

~~unclassified~~
~~CONFIDENTIAL~~

RM L6 L17
7080

0143906
TECH LIBRARY KAFB, NM



RESEARCH MEMORANDUM

PRELIMINARY TESTS AT SUPERSONIC SPEEDS
OF TRIANGULAR AND SWEEPED-BACK WINGS

By

Macon C. Ellis, Jr. and Lowell E. Hasel

Langley Memorial Aeronautical Laboratory
Langley Field, Va.

CLASSIFIED DOCUMENT

This document contains classified information affecting the National Defense of the United States within the meaning of the Espionage Act, USC 5021 and 32. Its transmission or the revelation of its contents in any manner to an unauthorized person is prohibited by law. Information so classified may be imparted only to persons in the military and naval services of the United States, appropriate civilian officers and employees of the Federal Government who have a legitimate interest therein, and to United States citizens of known loyalty and discretion who of necessity must be informed thereof.

AFMDC
TECHNICAL LIBRARY
AFL 2811

NATIONAL ADVISORY COMMITTEE FOR AERONAUTICS

WASHINGTON

February 21, 1947

57

~~unclassified~~
~~CONFIDENTIAL~~

Notice No. 2, NACA
filed 312.1 E4044

19.98113



0143906

NACA RM No. L6L17

~~CONFIDENTIAL~~

NATIONAL ADVISORY COMMITTEE FOR AERONAUTICS

RESEARCH MEMORANDUM

PRELIMINARY TESTS AT SUPERSONIC SPEEDS

OF TRIANGULAR AND SWEEP-BACK WINGS

By Macon C. Ellis, Jr. and Lowell E. Hasel

SUMMARY

A series of thin, triangular plan-form wings has been tested in the model supersonic tunnel at Langley. The series consisted of eight triangular wings of vertex angles such that a range of leading-edge positions both inside and outside the Mach cone at the two test Mach numbers of 1.43 and 1.71 was obtained. Three swept-back wings having angles of sweep of 45° , 55° , and 63° were also tested at a Mach number of 1.43. These swept-back wings had circular-arc sections with rounded leading edges and thicknesses of 13.3 percent of the chord measured normal to the leading edge. For each angle of sweep, wings having two values of aspect ratio were tested.

Lift results for the triangular wings indicated that Jones' theory for the lift of slender pointed wings is applicable for thin wings in the range of test Mach numbers up to values of $\frac{\tan \epsilon}{\tan m}$ equal to approximately 0.3, where ϵ is the wing vertex half-angle and m is the Mach angle. The center of pressure of the triangular wings was coincident with the center of area for all the wings tested at both Mach numbers. The lowest minimum drag coefficients were obtained for the wings with smallest vertex angles relative to the Mach angle. Also in this smallest vertex-angle region, the highest values of maximum L/D of about seven for both Mach numbers were obtained. It was thus indicated from the tests that wings having triangular plan forms should be operated well within the Mach cone for maximum efficiency.

Results of the swept-back-wing tests compared with triangular wing results for a Mach number of 1.43 show the same trends of lift and drag as the sweep angle is changed. For corresponding sweep

~~CONFIDENTIAL~~

angles, the swept-wing lift-curve slopes were lower than those for triangular wings, due probably to the increased thickness. It is indicated from the tests that for a Mach number of 1.4, the angle of sweep must be increased to about 60° to obtain low drag coefficients of the same magnitude as those due to skin friction.

INTRODUCTION

Recent theories of low-aspect-ratio triangular wings and swept wings by Jones (references 1 and 2) have indicated the advantages to be gained through the use of pointed plan-form wings for high-speed flight. Numerous tests both in this country and in Germany have shown that the drag rise with Mach number just below sonic velocity usually associated with wings having their leading edges normal to the flight direction may be delayed to higher speeds by the use of sweepback. Some of these tests have been conducted at high subsonic and up to moderate supersonic speeds; however, the largest amount of experimental work appears to be in the low subsonic speed region and is mostly concerned with development of means for making the stability and control characteristics of swept wings satisfactory. In reference 1, Jones has indicated by use of theories assuming small disturbances that the lift distribution at small angles of attack of a slender airfoil having a pointed or triangular plan form is relatively unaffected by the compressibility of the air below or above the speed of sound. The required condition for small changes in aerodynamic characteristics with Mach number at supersonic speeds is that the triangular wing have its vertex angle so small that the entire surface lies near the center of the Mach cone. With this condition satisfied, it would be expected that changes in lift-curve slope with Mach number would be small and that the position of the center of pressure at the center of area would not change. It was shown that the direction of the resultant force lies halfway between the normal to the surface and the normal to the air stream, suggesting that higher values of L/D might be expected from these wings than for wings having essentially two-dimensional characteristics, that is, wings with the resultant force normal to the surface. An isolated test of a slender triangular airfoil at a Mach number of 1.75 in reference 1 verified the theoretical values of lift and center of pressure; however, the value of maximum L/D was not obtained. Thus the present tests of a series of thin triangular wings at supersonic speeds were made to explore the possibilities of high values of maximum L/D , to find the limits of Jones' slender wing theory, and to provide preliminary design information for such wings beyond this limit.

A series of eight triangular wings of various vertex angles were tested at Langley in the so-called model supersonic tunnel which was the forerunner of the present Langley 9-inch supersonic tunnel. The tests were brief and preliminary in nature, because at the time they were started the date for starting modification of this tunnel to the present closed-return tunnel was imminent. The vertex angles of the wings were of such values that a range of leading-edge positions both inside and outside of the Mach cone were covered for the two test Mach numbers of 1.43 and 1.71. Following the triangular wing tests, time permitted only very brief tests of six sweptback wings at one Mach number of 1.43. Results of these sweptback tests are included herein mainly for their qualitative indications. All of the tests were made during July and August of 1945.

SYMBOLS

M	Mach number
V	stream velocity
ρ	stream density
q	dynamic pressure $\left(\frac{1}{2}\rho v^2\right)$
R	Reynolds number referred to c
α	angle of attack
ϵ	triangular wing vertex half-angle
m	Mach angle
A	sweepback angle
b	maximum span of wing
c	maximum chord
S	wing area
A	aspect ratio (b^2/S)
l	distance to center of area from vertex

- C_L lift coefficient $\left(\frac{\text{Lift}}{qS} \right)$
- C_D drag coefficient $\left(\frac{\text{Drag}}{qS} \right)$
- $C_{M.C.A.}$ pitching-moment coefficient for triangular wings
 $\left(\frac{\text{Moment about center of area}}{qSc} \right)$

Subscripts:

- C.A. center of area
- max maximum
- min minimum
- m mean or average

DESCRIPTION OF SUPERSONIC TUNNEL AND TEST MODELS

The so-called model supersonic tunnel in which the tests reported herein were made was the direct-action type, that is, atmospheric air was continuously inducted, compressed, and after passing through the nozzle and diffuser, exhausted back to the atmosphere. Thus this tunnel was subject to condensation in the supersonic nozzle during periods of high outside air humidity; some of the effects of condensation will be mentioned later. The supersonic nozzles and test sections for the tunnel were formed by interchangeable nozzle blocks inserted between fixed side walls $7\frac{1}{2}$ inches apart. The test sections were approximately square. A three-component balance and shielded-sting-support system provided means for measuring lift, moment, and drag forces on models.

In order to expedite the tests in the limited time available, the triangular wings were made simply from flat sheets of $\frac{1}{32}$ -inch thick steel. The leading edges were beveled slightly and rounded off, and the trailing edges were beveled to a sharp edge as shown in figure 1 which also gives dimensions of the wings. For the tests, the wings were mounted on a sting support which passed through a sharp-edged conical shield to the three-component balance. The size of the wings were limited by the forces the balance was capable of

measuring; the reflected shock from the wing vertex was always well back on the shield.

Details of the swept-back wing models are shown in figure 2. Circular-arc sections were selected mainly for ease of construction and duplication. The leading edges were rounded because it was considered that the wings would operate always behind the Mach angle.

TEST RESULTS AND DISCUSSION

Description of Tests

When air of sufficiently low temperature and high humidity flows through a supersonic nozzle the water vapor becomes super-cooled, finally condensing at a shock front somewhere along the nozzle. This condensation results in an increase in stagnation temperature and a decrease in total pressure of the air. For given initial stagnation conditions of the air before expansion through the nozzle, the effect of varying humidity is to vary the stream conditions in the test section. Most of the tests reported herein were made during periods of low humidity, however, stream conditions did vary to some extent. The two test Mach numbers of 1.43 and 1.71 are actually averages for the series of wings; the maximum variation in Mach number for the results presented was about plus or minus 0.02 and the maximum variation in stream pressure in the region of the model for any one test was about 4 percent. Variations within these values did not seriously affect the scatter of data, although they made it necessary to obtain, in some cases, a large number of test points in order to find differences in characteristics among the wings. It will be noted that fewer test points were obtained for the triangular wings at the lower Mach number. This was due to more consistent test conditions which gave less scatter for the same number of points.

Tares for the triangular and swept wings were obtained by measuring the lift and drag forces on the support cones alone. The drag tare was composed of the small cone drag and a relatively large pressure force acting on the spindle area. The pressure force was due to atmospheric pressure acting on one end of the spindle and stream pressure acting on the other end. The drag tares were of about the same magnitude as the drag forces and the variations in the pressure force thus leave the absolute values of drag more in doubt than the lift results. Tares for the swept wings were obtained similarly, but it should be noted that the lift tare of the relatively longer supports was larger than for the small cones for the triangular wings.

Test Results for Triangular Wings

Lift results for the eight triangular wings at $M = 1.43$ are shown in figure 3. It appears that the lift varies linearly with angle of attack up to about 5° , the limit of the tests, for all wings. Variations in angle of zero lift for the wings are due to varying stream inclination and to inadvertently different asymmetries in the wings. The same comments apply to the lift results for $M = 1.71$ shown in figures 4, except that for wings 5, 6, 7, and 3, the angle range is about 7° and the lift variation is still linear. It should be mentioned that these four wings all have their leading edges inside the Mach cone for $M = 1.71$. The lift curve slope values from figures 3 and 4 are collected and shown in figure 5 as the ratio of measured lift-curve slope to the theoretical two-dimensional lift-

curve slope against the parameter $\frac{\tan \epsilon}{\tan m}$. The theoretical two-dimensional lift-curve slope values are taken from Ackeret's theory

as
$$\frac{dC_L}{d\alpha} = \left(\frac{1}{57.3} \right) \frac{4}{\sqrt{M^2 - 1}}$$
. Theoretical considerations indicated

that $\frac{\tan \epsilon}{\tan m}$ is a fundamental parameter as pointed out to the authors by C. E. Brown of the Langley Laboratory. The inverse of same parameter has later appeared in a paper entitled "Supersonic Wave Drag of Thin Airfoils" given by Allen E. Puckett at the Fourteenth Annual Meeting of the Institute of Aeronautical Sciences in New York City, January 29, 1946. The quantity $\frac{\tan \epsilon}{\tan m}$ approximately equals ϵ/m for the range of test Mach numbers. When $\frac{\tan \epsilon}{\tan m}$ equals 1.0, it is identical to ϵ/m . Thus values of $\frac{\tan \epsilon}{\tan m}$ less than 1 correspond to cases where the leading edge is behind the Mach angle and values greater than 1 correspond to cases where the leading edge is ahead of the Mach angle. It is seen that as $\frac{\tan \epsilon}{\tan m}$ approaches zero, the test results for both Mach numbers show a single curve for the slope ratio that asymptotes Jones' theory. The limit of applicability of Jones' theory for slender triangular wings in the range of test Mach numbers thus appears as a value of $\frac{\tan \epsilon}{\tan m}$ approximately equal 0.3. In reference 3, Jones has developed a theory for calculating the pressure drag of thin oblique airfoils at supersonic speeds. It was pointed out by C. E. Brown of the Langley Laboratory, that the equations in Jones' report could be used to calculate the lift of a thin triangular wing for cases where the wing leading edge is outside the Mach cone. Calculations for wings outside the Mach cone at the

test Mach numbers showed the lift-curve slopes to be the same as the two-dimensional theoretical values for a straight wing. Thus it is expected that a suitable theory for the lift of triangular flat plates, bridging the gap between Jones' slender wing theory and the theory for wings outside the Mach cone, would result in a curve that would follow the lower part of the experimental slope ratio curve but continue smoothly to 1.0 or the two-dimensional value at $\frac{\tan \epsilon}{\tan m} = 1.0$. The variations in slope ratio, shown by the tests as the wing leading edge approaches and moves ahead of the Mach cone, are believed to be primarily due to the flow in the region of the rounded leading edge. Incidentally, wing 1 was tested reversed, that is, with its leading edge normal to the stream; and values of lift-curve slope very closely checking Ackeret's theory were measured.

The pitching-moment coefficients in figures 6 and 7 show immediately that the center of pressure is coincident with the center of area for all the triangular wings tested at both Mach numbers. At the low values of $\frac{\tan \epsilon}{\tan m}$, this result is as predicted by the theory and verified by a single test in reference 1. The fact that the center of pressure is coincident with the center of area may also be reasoned simply for all values of $\frac{\tan \epsilon}{\tan m}$ from considerations of the conical flow. Any supersonic flow in which the pressure and velocity are constant along lines radiating from a point is a conical flow field. Supersonic flow about a point-foremost triangular flat plate is such a flow. Conical supersonic flows are discussed in detail by Busemann in reference 4.

Minimum drag-coefficient values for the wings at zero lift are collected from figures 3 and 4 and shown in figure 3 plotted against the same parameter $\frac{\tan \epsilon}{\tan m}$ as were the lift-curve slopes. It is immediately apparent that the tests show increasing minimum drag coefficient as the wing leading edge moves away from the center of the Mach cone. As an indication of the theoretical trends of the minimum drag coefficient as the leading-edge angle and Mach number are varied, estimates were made using the calculations in Puckett's paper (reference previously mentioned). The calculations in Puckett's paper were for the pressure drag of a series of thin, sharp-edge, double wedge-section triangular wings of various thickness ratios and points of location of maximum thickness. It is realized that the assumption of geometrical similarity between the wings of Puckett's paper and those of the present tests is rather crude, nevertheless, calculations were made assuming the present wings to have an equivalent thickness ratio equal to the maximum value for the average chord.

It was further assumed that the maximum thickness was located at the midchord point and was constant from root to tip. Results of these calculations showed the same trend with $\frac{\tan \epsilon}{\tan m}$ as did the test results, that is, smoothly increasing values of the minimum drag coefficient as the Mach angle approached and passed over the leading edge.

The test points at the lowest value of $\frac{\tan \epsilon}{\tan m}$ on each drag curve in figure 8 are for the same wing at the two test Mach numbers. For this wing (wing 8), the calculations of drag give about the same value of $C_D = 0.002$ due to pressure forces for both values of the Mach number. From the low value of pressure drag indicated by the calculations for wing 8, it is expected that most of the drag shown by the tests for low values of $\frac{\tan \epsilon}{\tan m}$ is due to skin friction. Since there is no reason to expect an appreciable difference in skin-friction drag for the two Mach numbers, the displacement of the drag curves at the lowest values of $\frac{\tan \epsilon}{\tan m}$ is probably spurious. It is likely that there is a constant error in drag-tare measurements for the tests at either Mach number which is different for the two Mach numbers. Thus an approximation of the true drag curves appears possible by displacing the upper test curve downward and the lower test curve upward by equal amounts so that they both asymptote the same line at $\frac{\tan \epsilon}{\tan m}$ equal zero. This asymptotic value of minimum drag coefficient minus an allowance for pressure drag of $\Delta C_D = 0.002$ is of the right order of magnitude for skin friction. For corresponding wings at the two Mach numbers, the displaced curves show no difference in drag values within the scatter of the test points about a smooth curve. It therefore appears that the drag results show the correct trend with $\frac{\tan \epsilon}{\tan m}$ but are not of sufficient accuracy to show the trends for a given wing with Mach number. The important conclusion to be drawn is that the pressure drag may be reduced to a small value by operating triangular wings well within the Mach cone.

Although the absolute values of drag are in some doubt, it is believed that the indicated rise with angle of attack is reliable due to the systematic nature of the tests for each wing and because a smooth curve can be drawn through the points with small scatter. A check of the drag rise with angle of attack shows the resultant incremental force on all the wings for both Mach numbers to be normal to the surface. This result may be obtained by first assuming the resultant incremental force to be normal to the surface, then calculating ΔC_D above C_D for zero angle of attack as $\Delta C_D = C_L \tan \alpha$.

These calculated values will fall on each drag curve within the probable test accuracy.

The measured L/D values are shown in figures 3 and 4. The maximum L/D results shown in figure 3 show increasing maximum L/D as the wings become more slender for each Mach number. The trend of the curves at the maximum L/D of about seven obtained indicated the possibility of still higher values for more slender wings. For a comparison with two-dimensional values of maximum L/D, wing 1 was tested reversed, that is, with its sharp, straight trailing edge forward, normal to the stream. Approximate values of maximum L/D obtained were 4.0 for $M = 1.43$ and 3.8 for $M = 1.71$. The L/D curves are seen to be approaching these values as the wing leading edges approach the normal to the stream.

Test Results for Swept-back Wings

The lift results shown in figure 9 for the six swept-back wings indicate no significant change in slope with aspect ratio except for the 45° sweep angle where the slope for the lower aspect ratio appears higher. For the 45° sweep angle at the test Mach number of 1.43, the Mach cone lies approximately along the wing leading edge, and it might be expected that the different flow arising from the strong initial shock would lead to different characteristics than for the higher angles of sweep for which cases the initial disturbance must be smaller.

The most significant result of the drag coefficients shown for the wings in figure 9 is the high drag for the wing with 45° sweep. It is also important to note that for the Mach number of 1.43, drag coefficients as low as subsonic values are not obtained until the sweep angle is increased to approximately 60° . Practical use of this high degree of sweep appears difficult in relation to present knowledge and capability of handling the low-speed stability and control problems. The upward trend of the L/D curves shown in figure 9 for the highest sweep angle suggests a high value of maximum L/D, inviting solution to these stability and control problems.

The moment results of figure 9 show the center of pressure to be moving forward as the sweep angle decreases. At the highest sweep angle, the center of pressure appears about on the center of area. This result might be expected due to the fact that most of the wing is in an approximately conical field except in the regions near the tips and along the trailing edge.

A comparison between the lift and drag test results for the swept-back and triangular wings at a Mach number of 1.43 is given in

figure 10. The lift-curve slopes for the swept-back wings are appreciably lower than those for the triangular wings for corresponding sweep angles. A part of this difference may be due to thicker sections and some increases in lift might be affected by use of thinner sections. Further tests beyond the present very sketchy tests are necessary to explore this possibility. The drag comparison shows about the same minimum drag coefficient for the triangular and swept wings at the higher angles of sweep, however, for the lower sweep angles, the swept wing values are higher. The higher drags are probably due to the increased thickness ratio for the swept wings. It appears that the drag test results are not sufficiently accurate to show effects of aspect ratio. Variations in drag with aspect ratio and sweep angle can be calculated by the theory presented in reference 3.

The schlieren photographs of the lower aspect-ratio swept wings shown in figure 11 were made at a higher stream Mach number than that for the force tests, but serve to show some significant points in regard to the flow over the wings. The photographs were made at a stream Mach number of 1.55. For photograph (a), the leading edge of the 45° wing is in a position slightly ahead of the Mach angle. The disturbance ahead of the wing is seen to be strong as indicated by appreciable curvature of the shock. This strong shock leads to the idea that high pressures are acting along the wing leading edge resulting in high drag. This relatively high drag has been shown by the force tests. Comparison of photograph (d) with photographs (a) and (c) for higher angles of sweep indicates that the intensity of the initial disturbance from the point of the wing decreases. This is in line with the decreasing drags shown by the force tests. The side view of the 63° sweep wing in photograph (b) shows the initial disturbance still small, but shows a fairly strong shock originating at the vertex of the trailing edge. This indicates an accelerating region over the rear portion of wing near the trailing-edge vortex, resulting in relatively high velocities. As regards the tip sections, reasoning based on Jones' theory in reference 3 suggests that the tips should probably be made parallel to the stream for lower tip drag.

CONCLUSIONS

Supersonic wind-tunnel tests of a series of thin, triangular plan-form wings at Mach numbers of 1.43 and 1.71, and tests of three swept-back wings of 13.3-percent thickness ratio at a Mach number of 1.43 have indicated the following conclusions:

1. The lift of thin, triangular plan-form wings may be calculated by Jones' slender wing theory up to values of

$\frac{\tan \epsilon}{\tan m}$ equal approximately 0.3, where ϵ is the wing vertex half-angle. For values of $\frac{\tan \epsilon}{\tan m}$ above 1.0, the lift is essentially the same as that obtained theoretically for a two-dimensional wing.

2. The center of pressure of thin, triangular plan-form wings is coincident with the center of area.

3. For low drag coefficients approaching those due to skin friction alone and for the highest values of maximum L/D, both triangular and swept-back wings should be operated with their leading edges well behind the Mach cone.

Langley Memorial Aeronautical Laboratory
National Advisory Committee for Aeronautics
Langley Field, Va.

REFERENCES

1. Jones, Robert T.: Properties of Low-Aspect-Ratio Pointed Wings at Speeds below and above the Speed of Sound. NACA TN No. 1032, 1946.
2. Jones, Robert T.: Wing Plan Forms for High-Speed Flight. NACA TN No. 1033, 1946.
3. Jones, Robert T.: Thin Oblique Airfoils at Supersonic Speed. NACA TN No. 1107, 1946.
4. Busemann, A.: Drücke auf kegelförmige Spitzen bei Bewegung mit Überschallgeschwindigkeit. Z.f.a.M.M., Bd. 9, Heft 6, 1929, pp. 496-498.

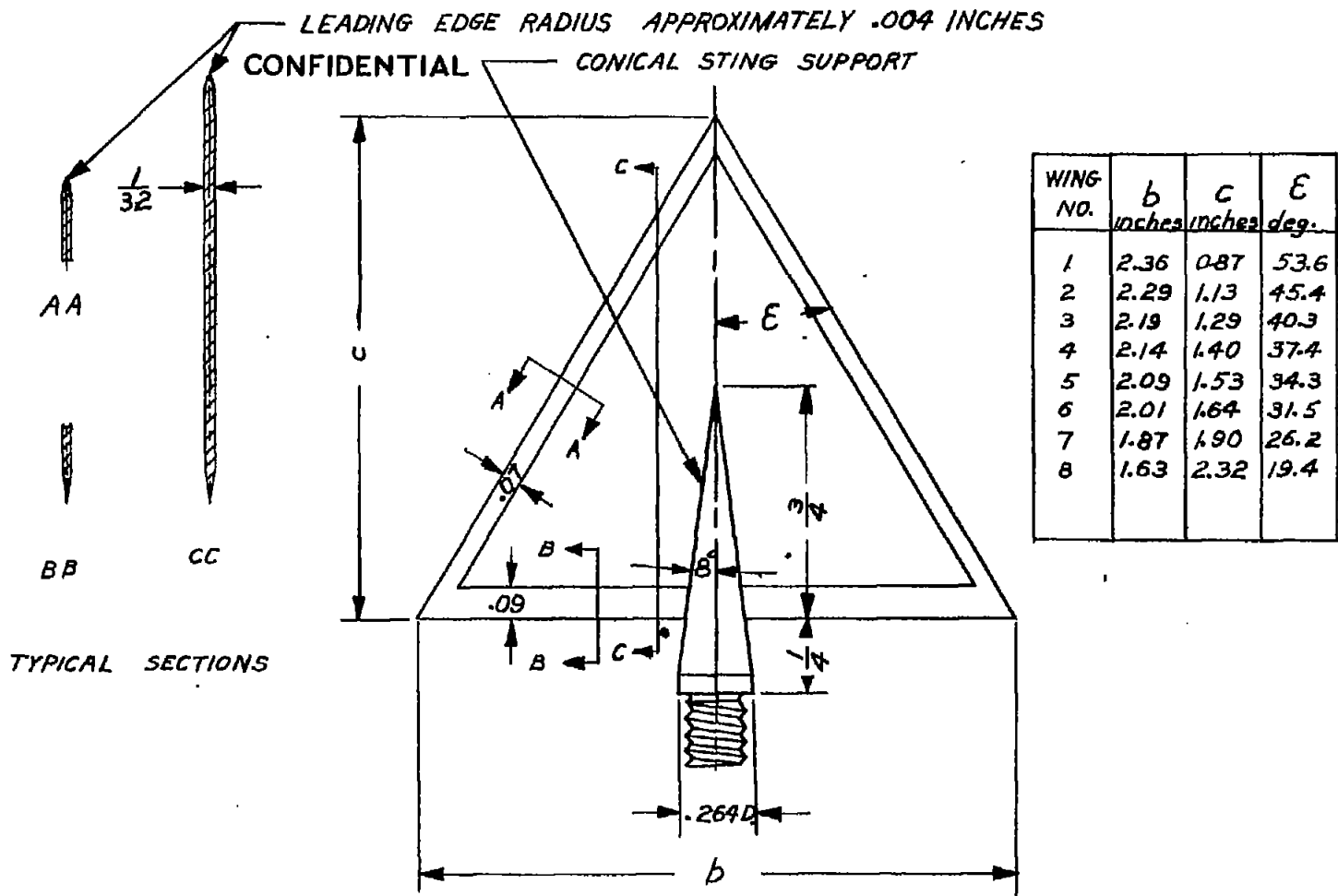

CONFIDENTIAL

NATIONAL ADVISORY
 COMMITTEE FOR AERONAUTICS

FIGURE 1.- TRIANGULAR WINGS AND SUPPORT DIMENSIONS

NACA RM No. L6L17

Fig. 1

CONFIDENTIAL

SWEEPBACK ANGLE, λ	A.	I	C
45°	5.13 3.32	1.97 1.41	1.33
55°	3.44 2.10	2.36 1.52	1.64
63°	2.27 1.36	2.74 1.73	2.07

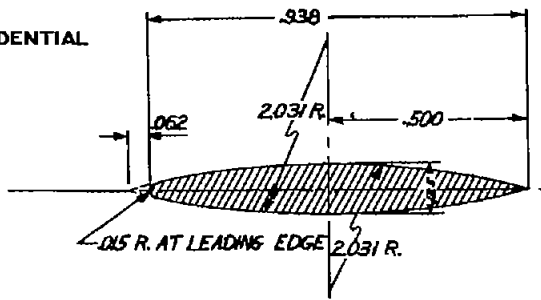

SECTION AA

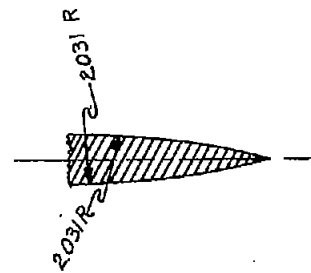

SECTION BB

TYPICAL SECTIONS

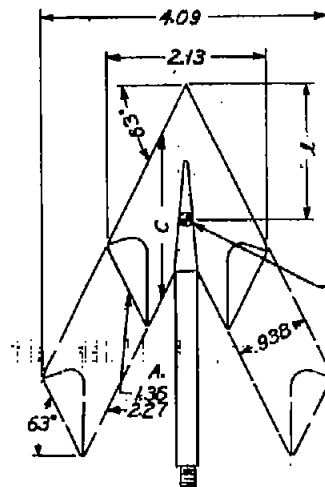
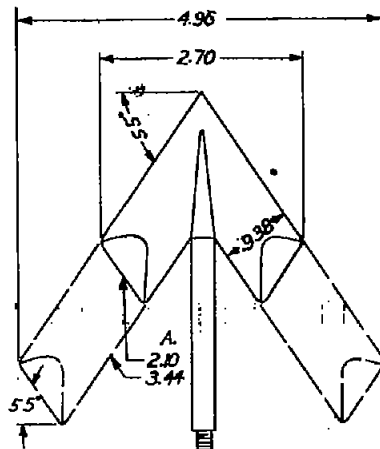
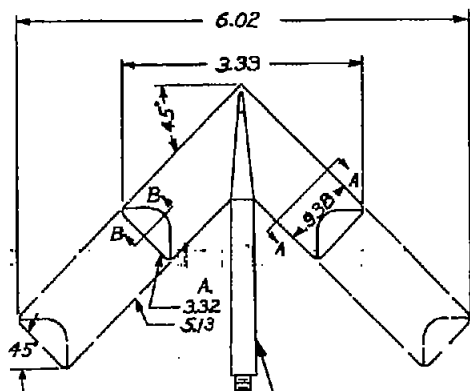

CENTER OF AREA

STING SUPPORT IS SIMILAR ON ALL MODELS. B₂ CONICAL TIP AND 0.264 DIA. SHAFT.

DIMENSIONS IN INCHES

NATIONAL ADVISORY
 COMMITTEE FOR AERONAUTICS

CONFIDENTIAL

FIGURE 2.- SWEEPBACK WINGS AND SUPPORT DIMENSIONS

FIG. 2

NACA RM No. L6L117

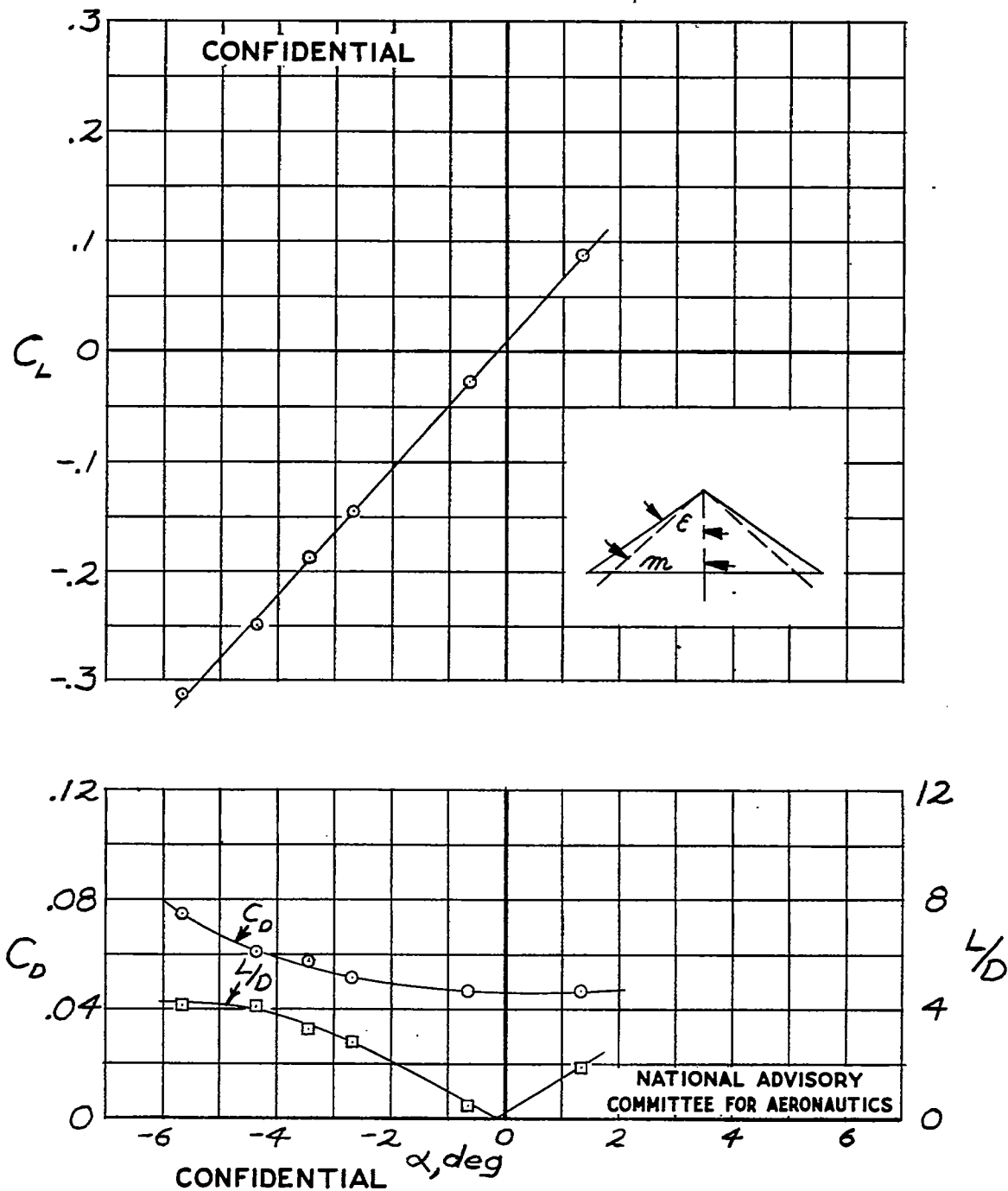

(a) Wing 1; $R=360,000$
 Figure 3.- Triangular wing lift and drag test results for $M=1.43$.

Fig. 3b

NACA RM No. L6L17

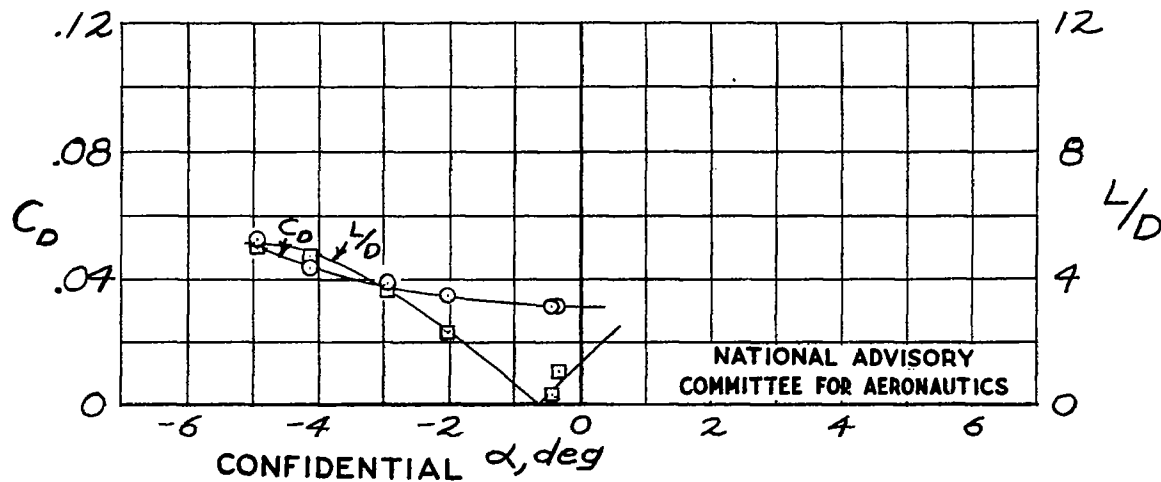
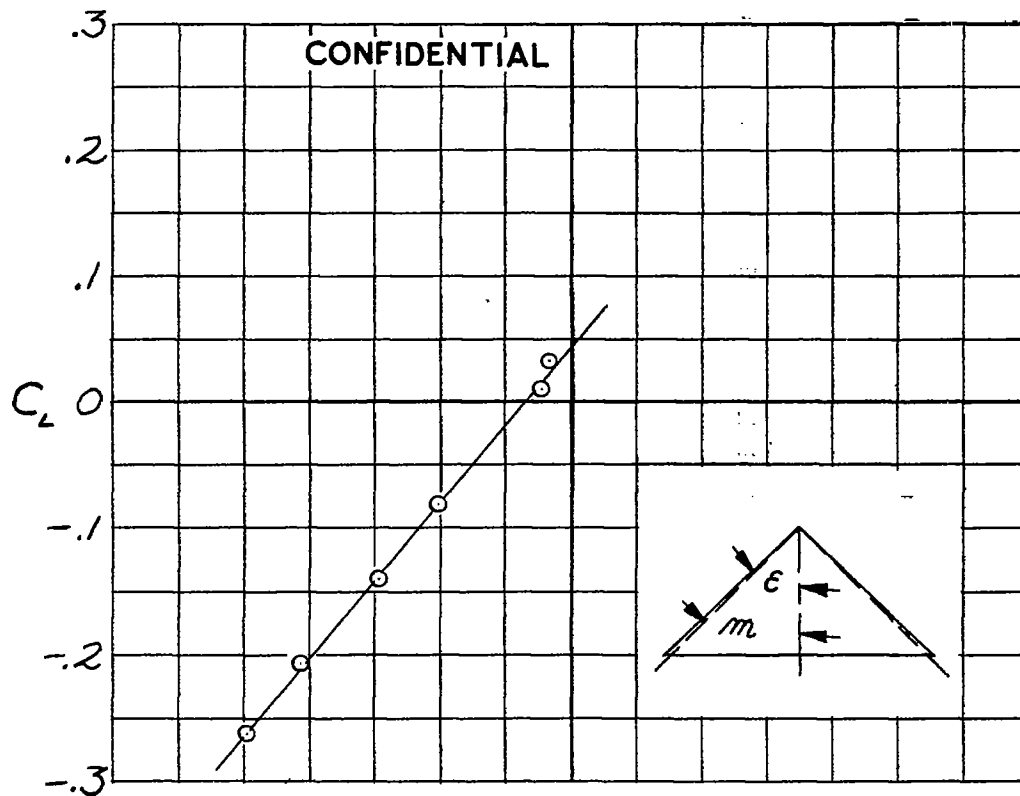

(b) Wing 2; $R = 480,000$
 Figure 3.- Continued.

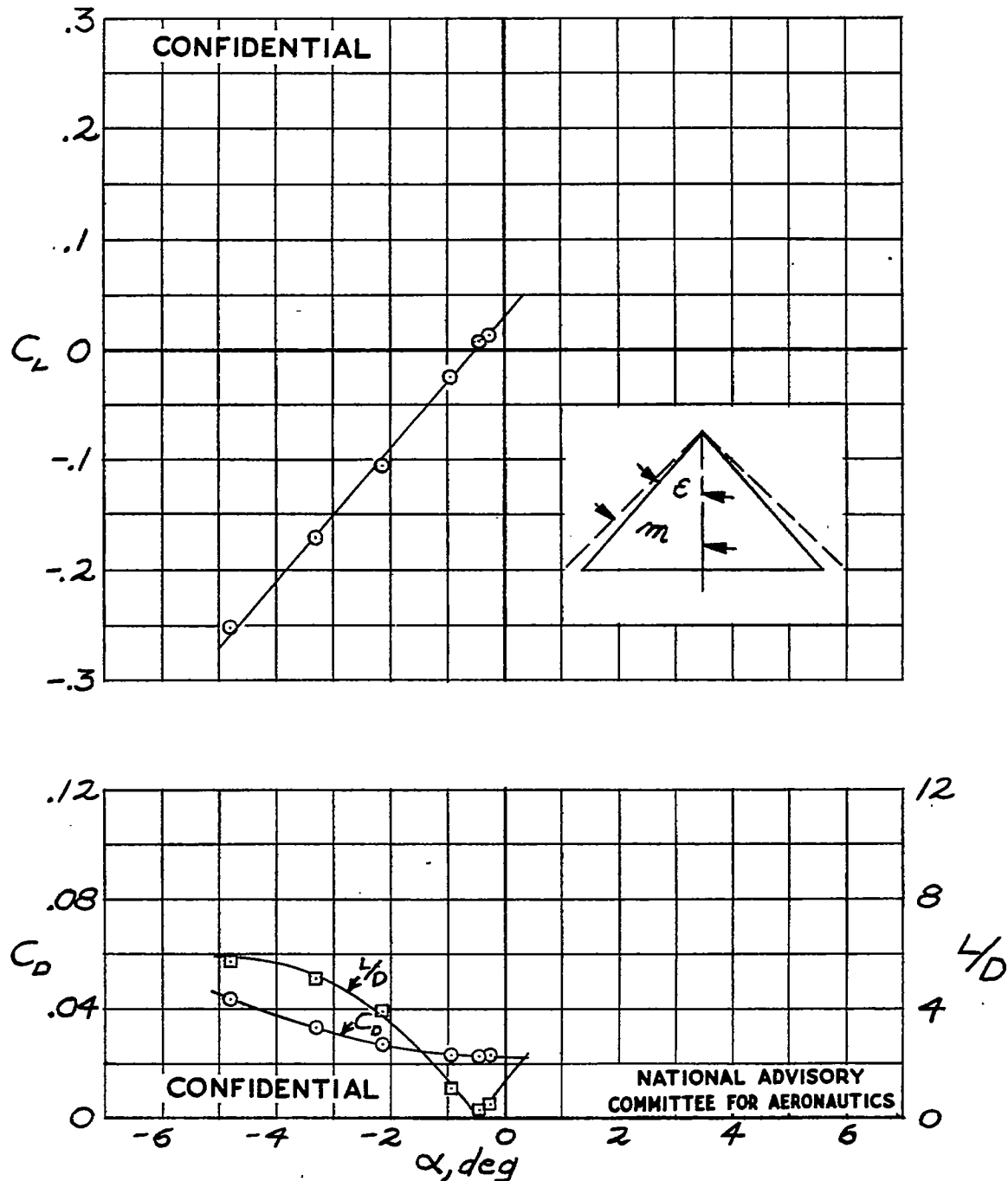

(c) Wing 3; $R=540,000$
 Figure 3.- Continued.

Fig. 3d

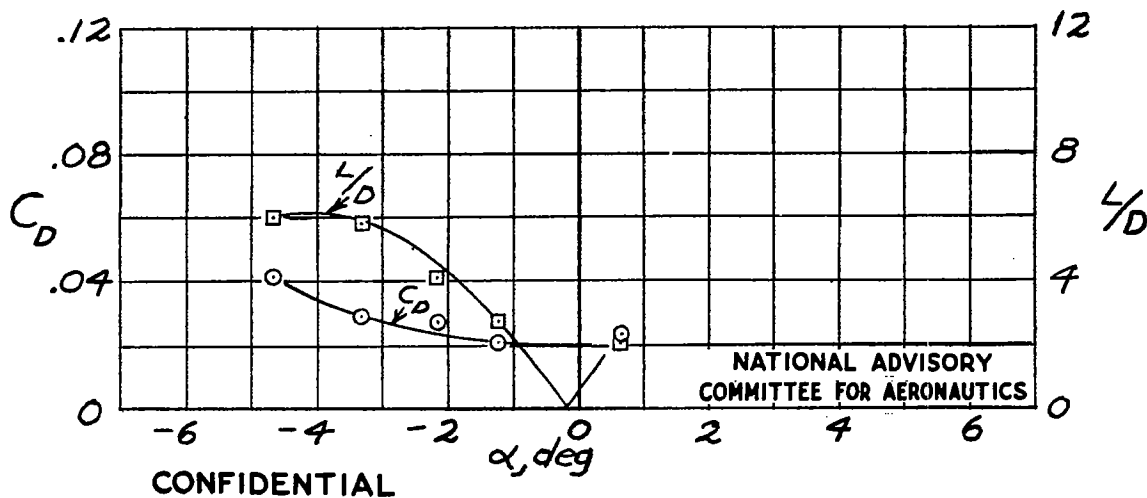
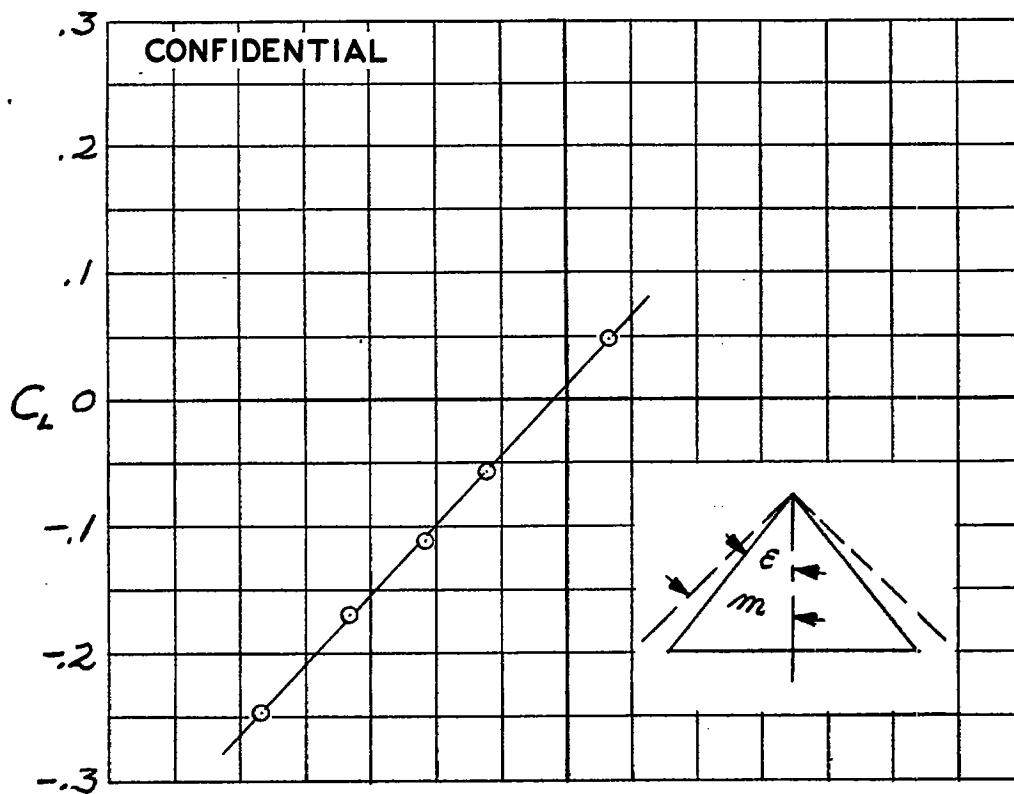

(d) Wing 4; $R = 600,000$
 Figure 3.-Continued.

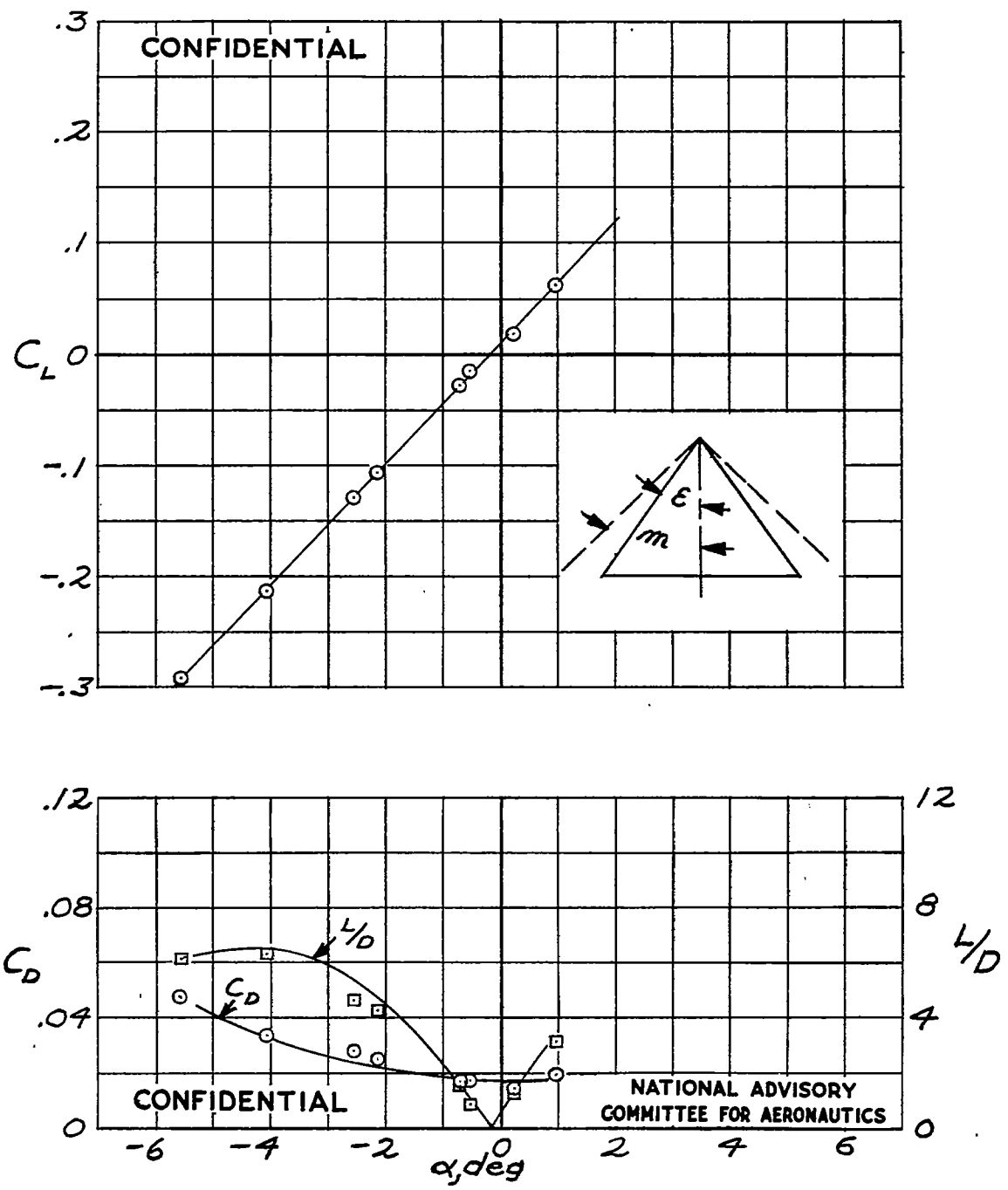

(e) Wing 5; $R = 640,000$
 Figure 3.- Continued.

Fig. 3f

NACA RM No. L6L17

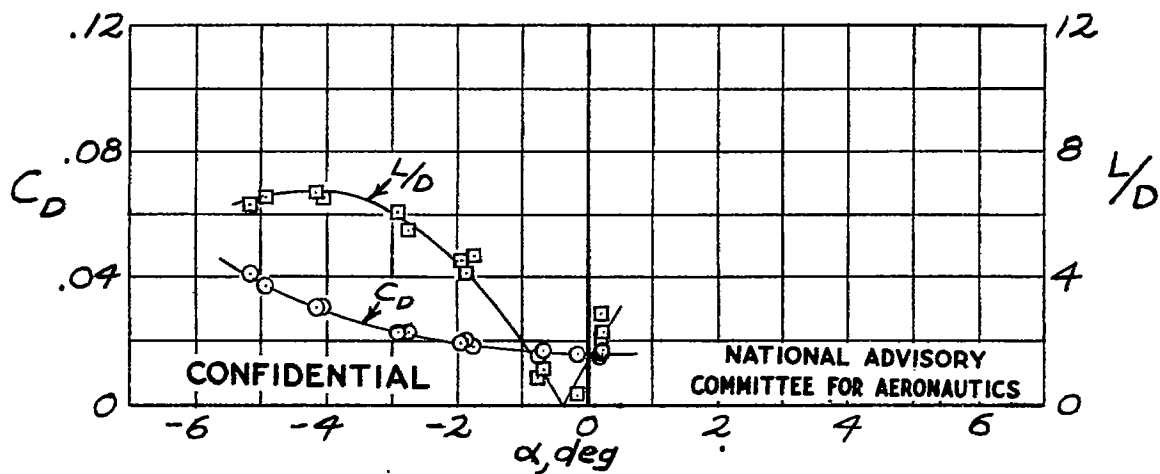
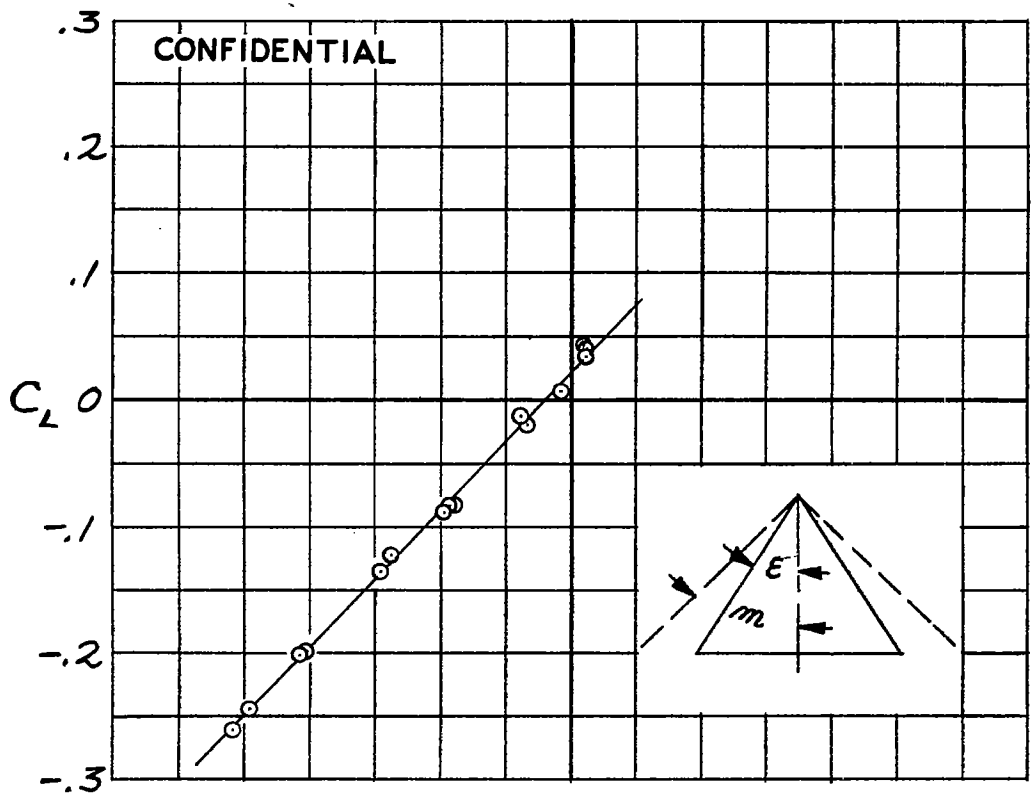

(f) Wing 6; $R = 700,000$
 Figure 3.- Continued.

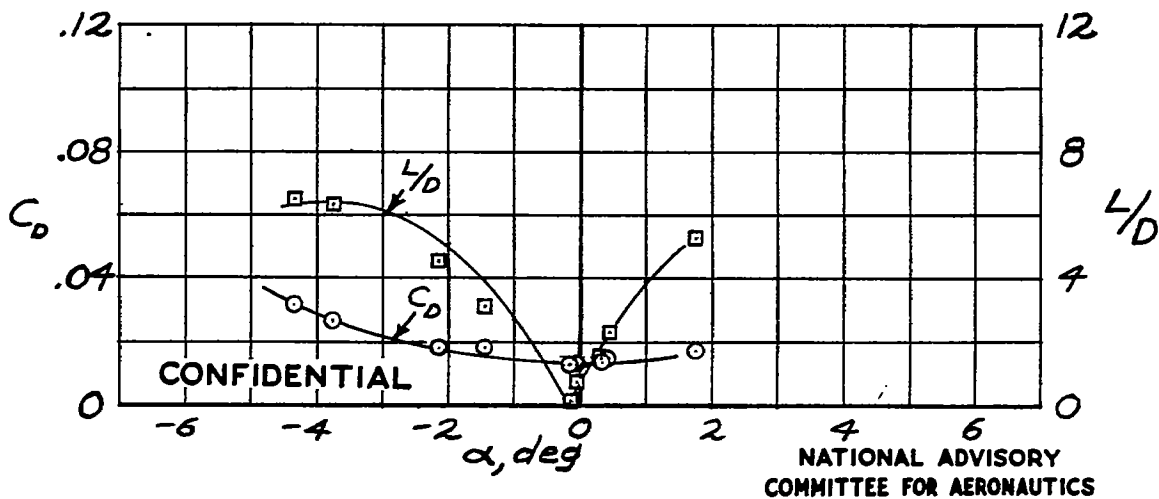
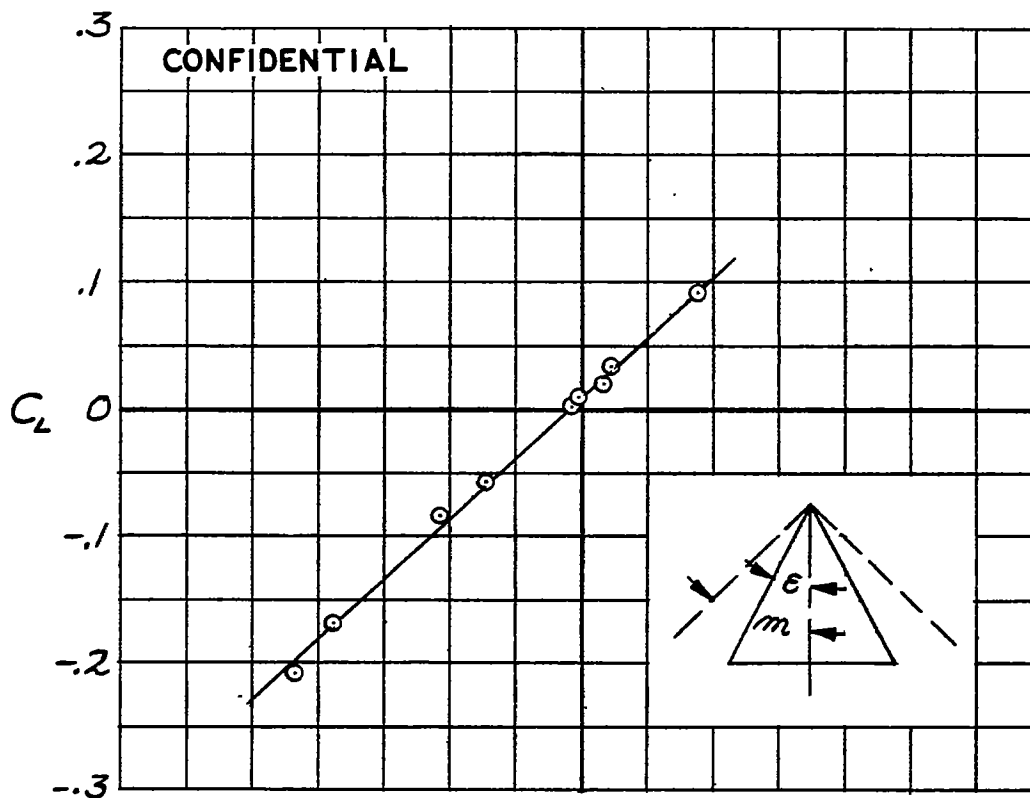

(g) Wing 7; $R = 800,000$
 Figure 3.- Continued.

Fig. 3h

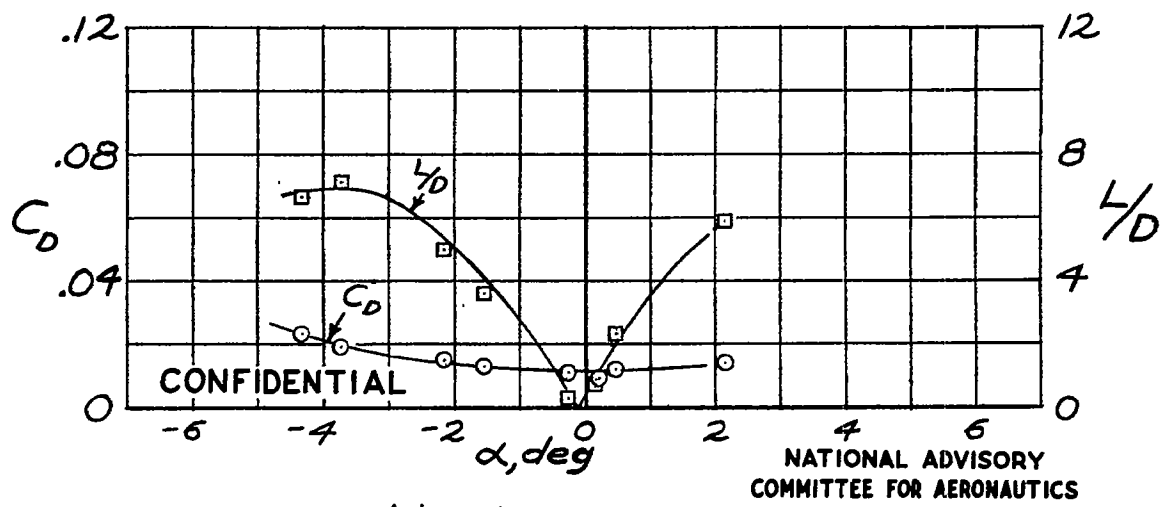
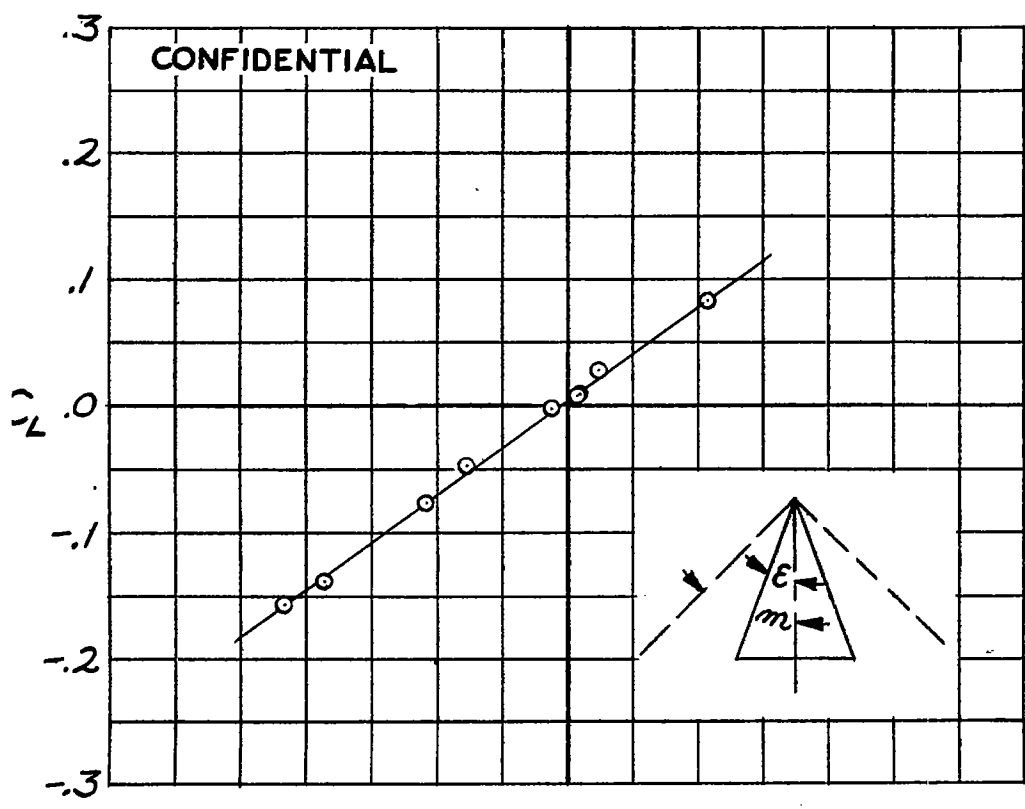

(h) Wing 8; $R = 980,000$
 Figure 3. - Concluded.

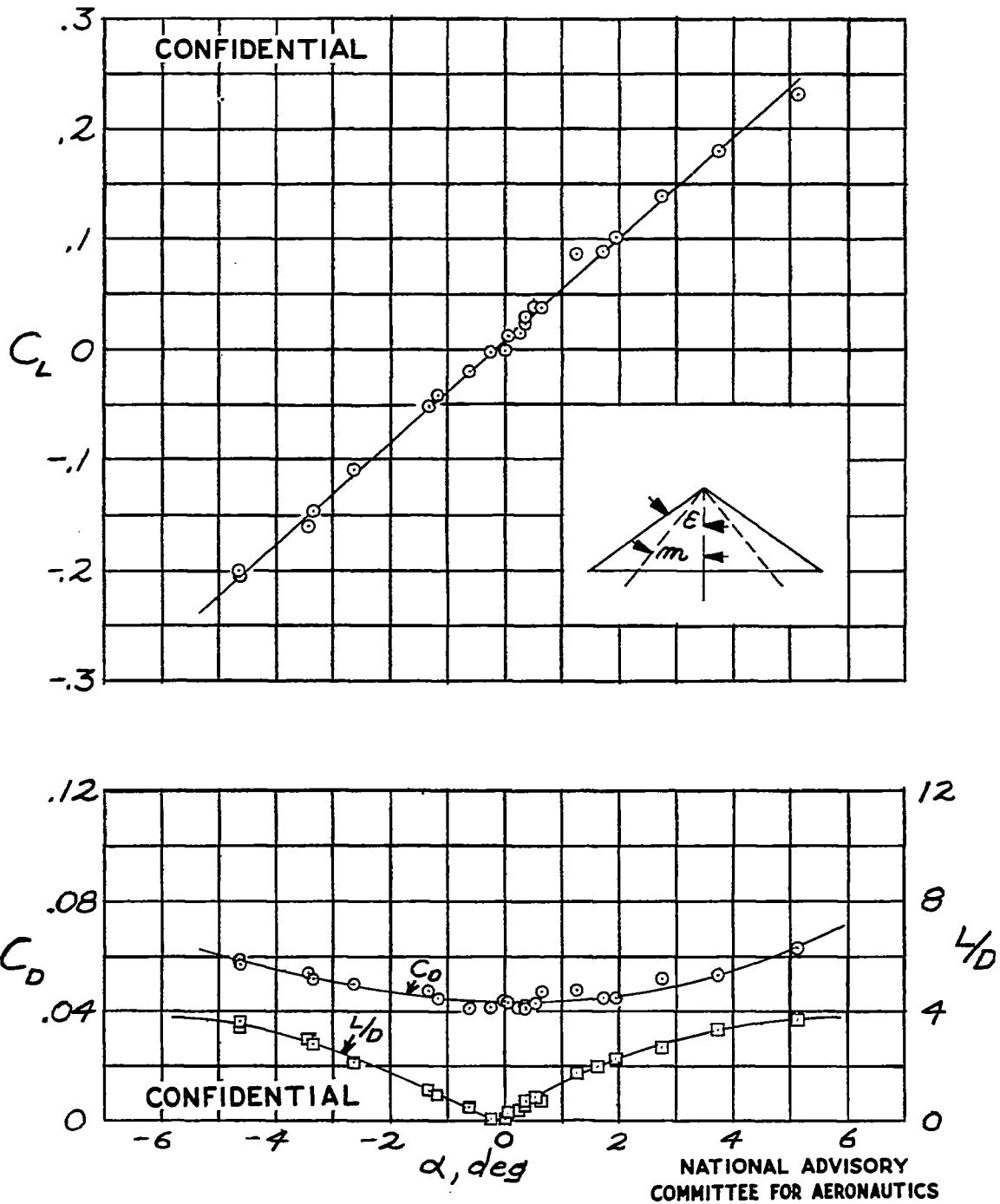

(a) Wing 1; $R=340,000$
 Figure 4.- Triangular wing lift and drag
 test results for $M=1.71$.

Fig. 4b

NACA RM No. L6L17

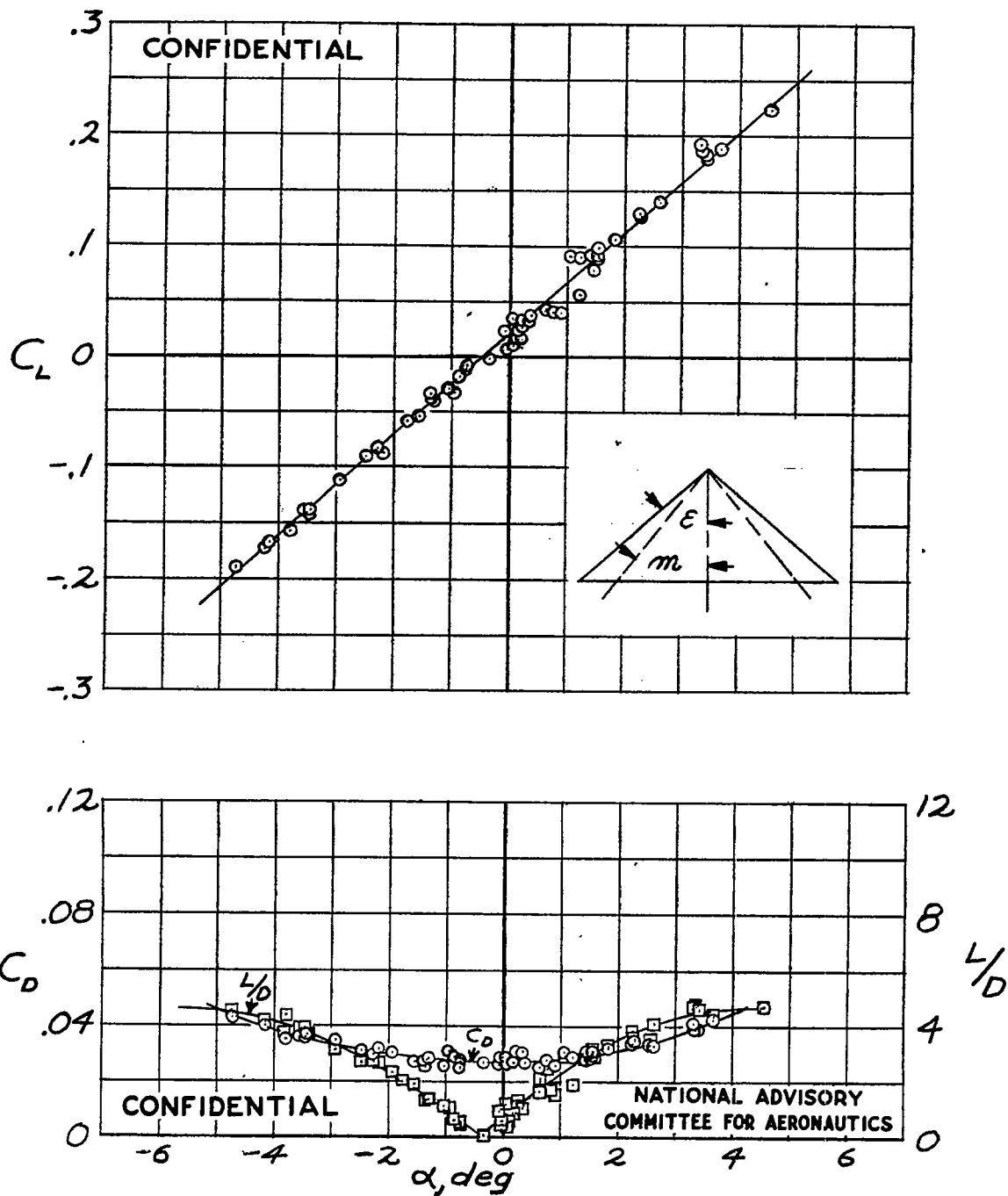

(b) Wing 2; $R = 440,000$
Figure 4.-Continued.

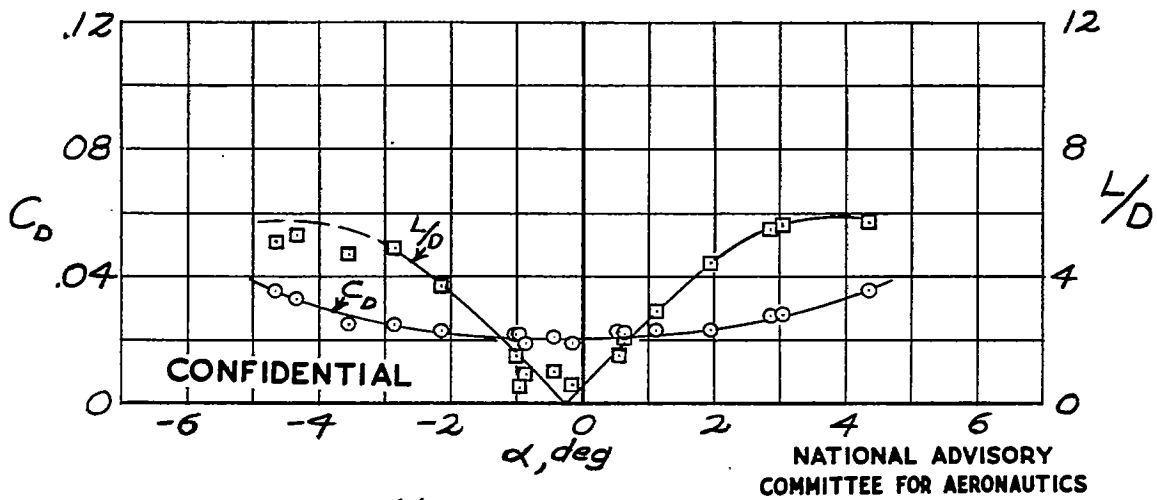
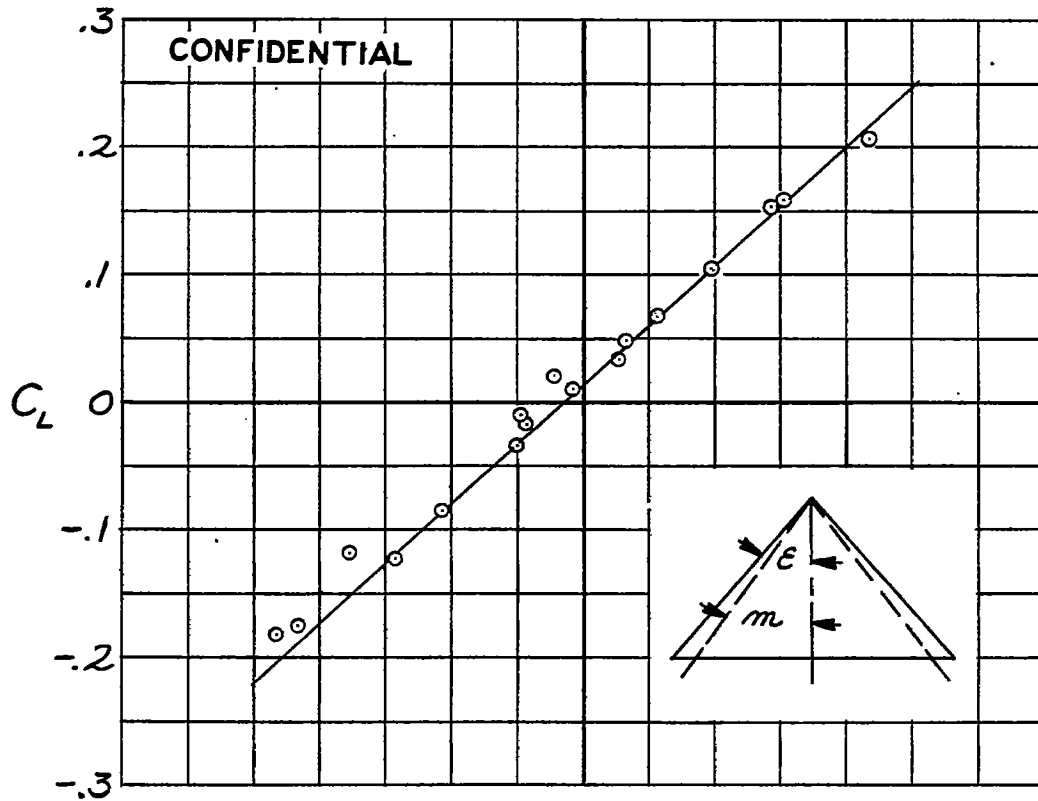

(c) Wing 3; $R=520,000$
 Figure 9.- Continued.

Fig. 4d

NACA RM No. L6L17

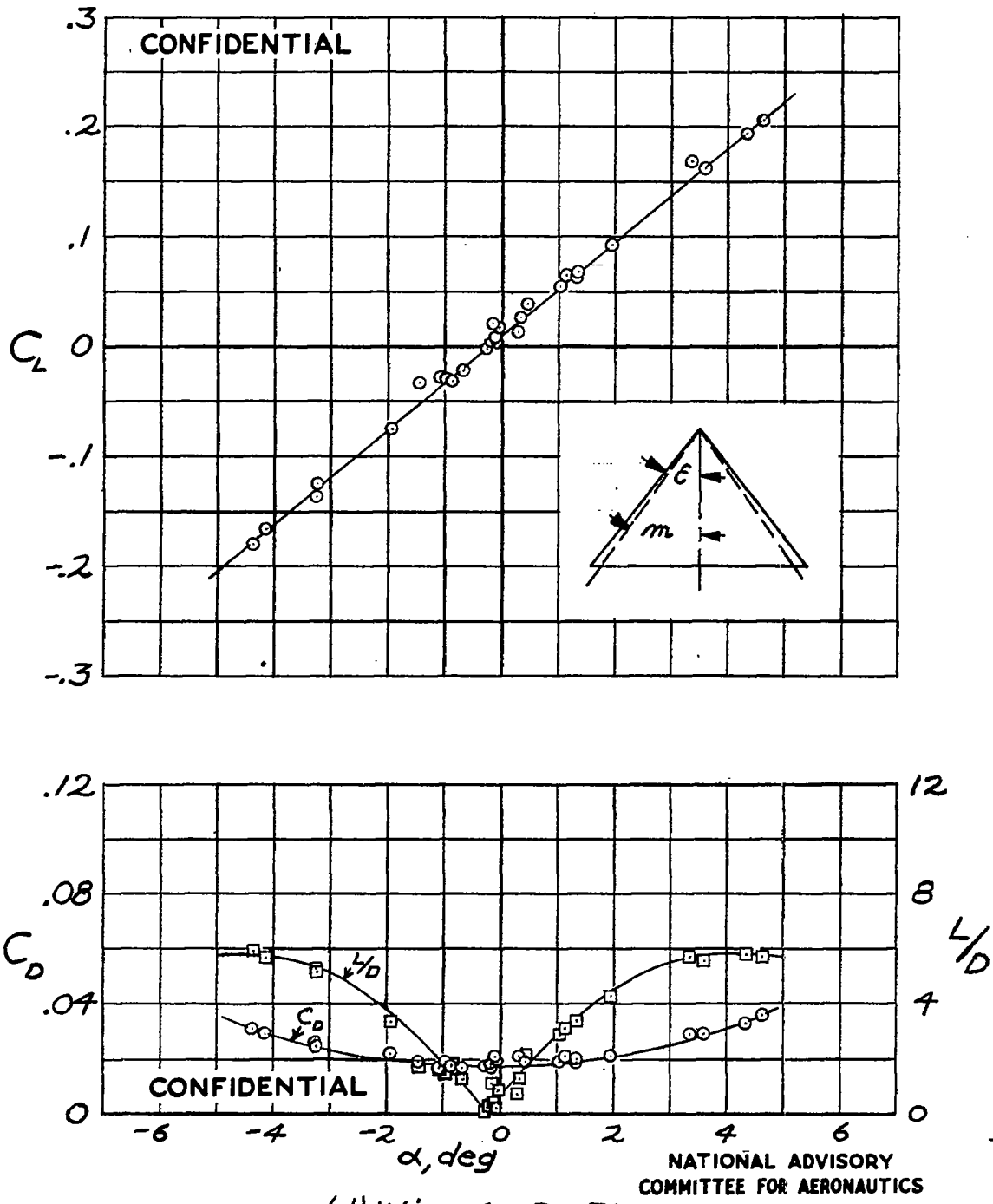

(d) Wing 4; $R=560,000$
 Figure 4. - Continued.

NATIONAL ADVISORY
 COMMITTEE FOR AERONAUTICS

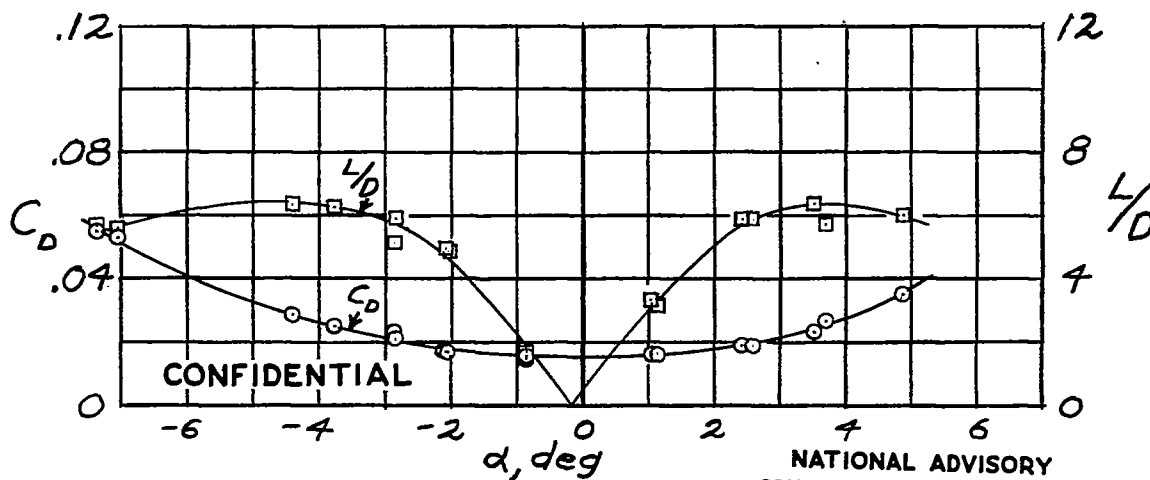
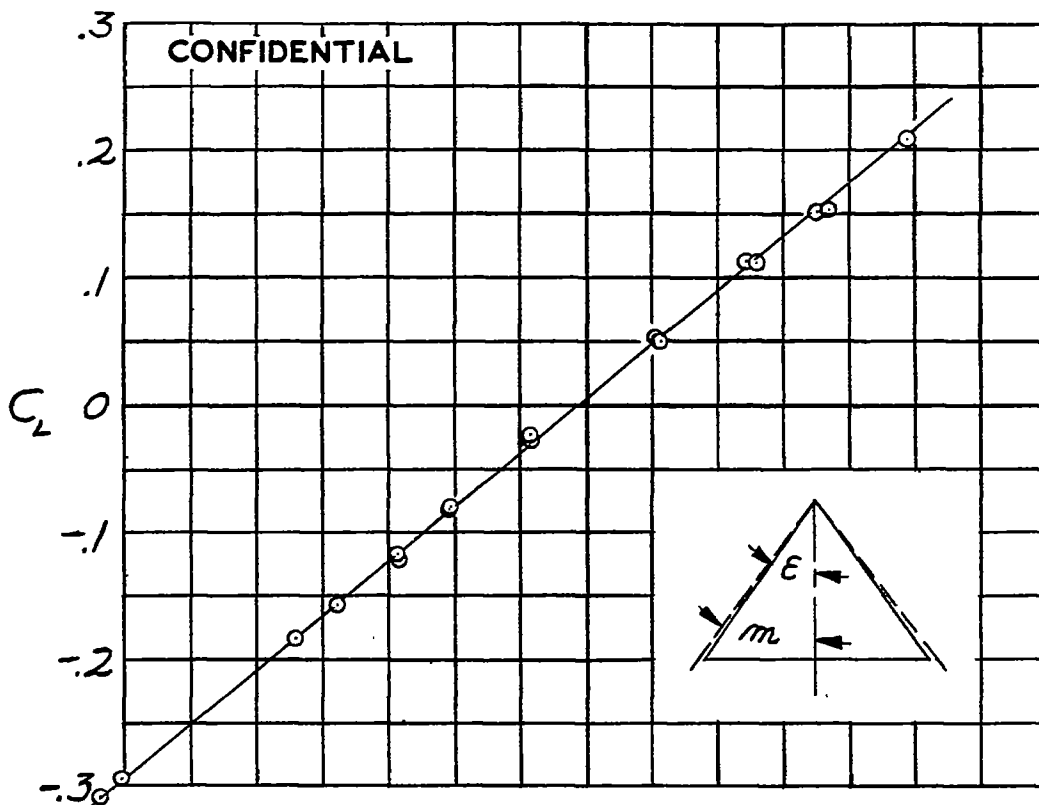

NATIONAL ADVISORY
 COMMITTEE FOR AERONAUTICS

(e) Wing 5; $R = 620,000$
 Figure 4. - Continued.

Fig. 4f

NACA RM No. L6L17

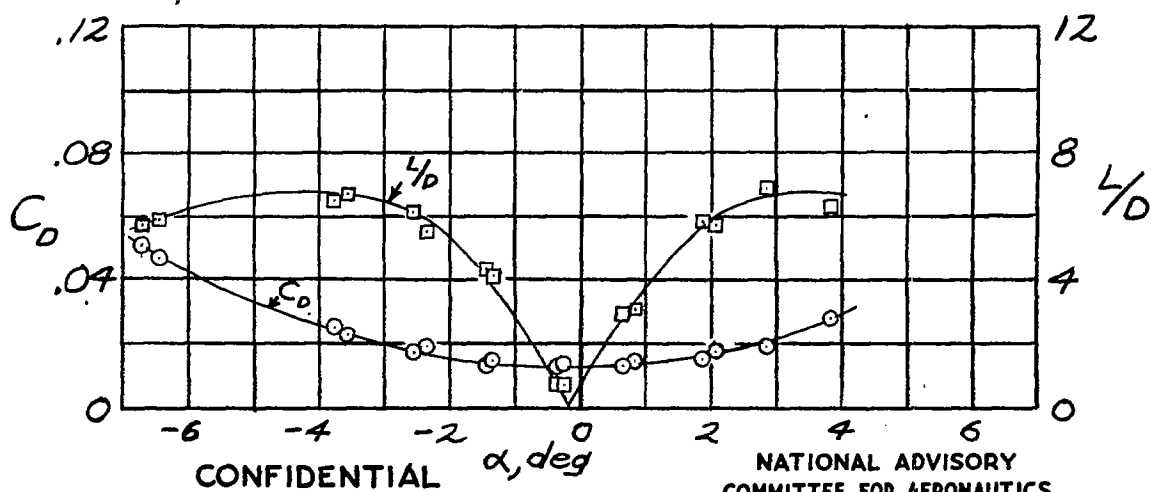
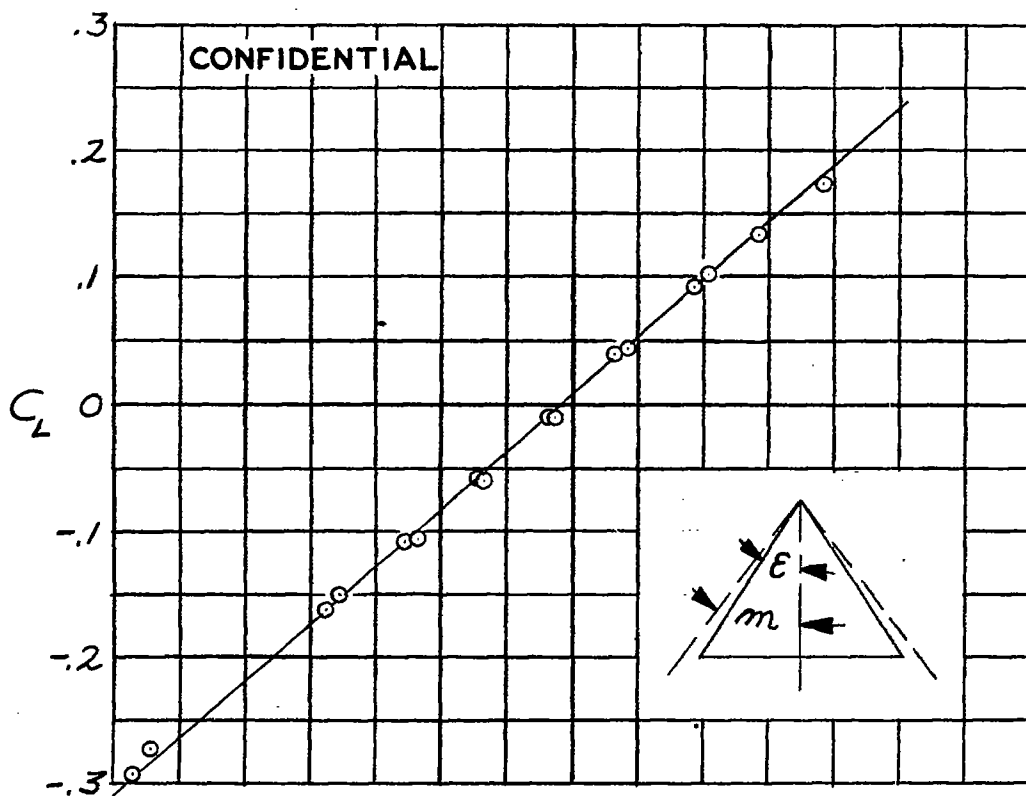

(f) Wing 6; $R = 660,000$
 Figure 4.- Continued.

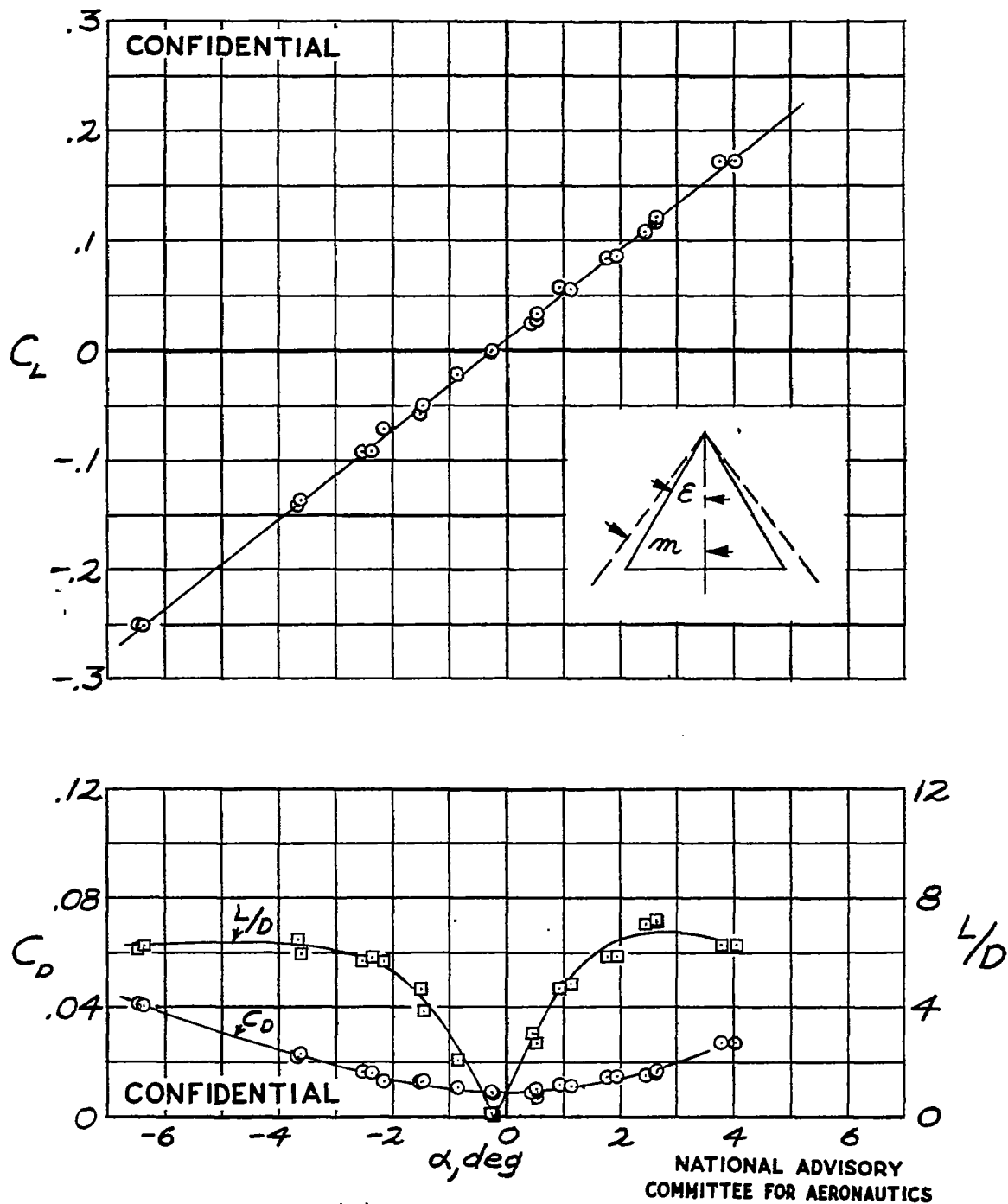

(g) Wing 7; $R = 760,000$
 Figure 4.- Continued.

Fig. 4h

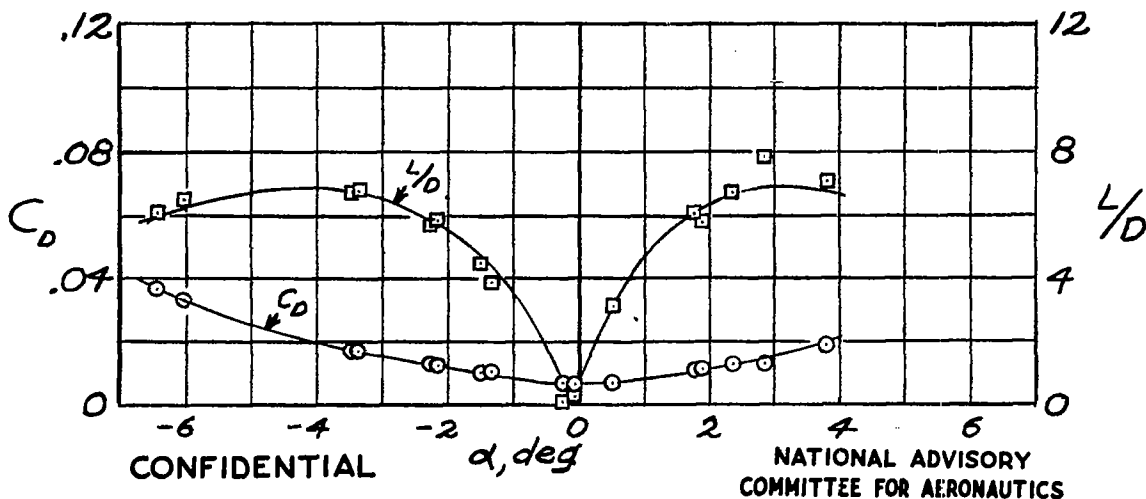
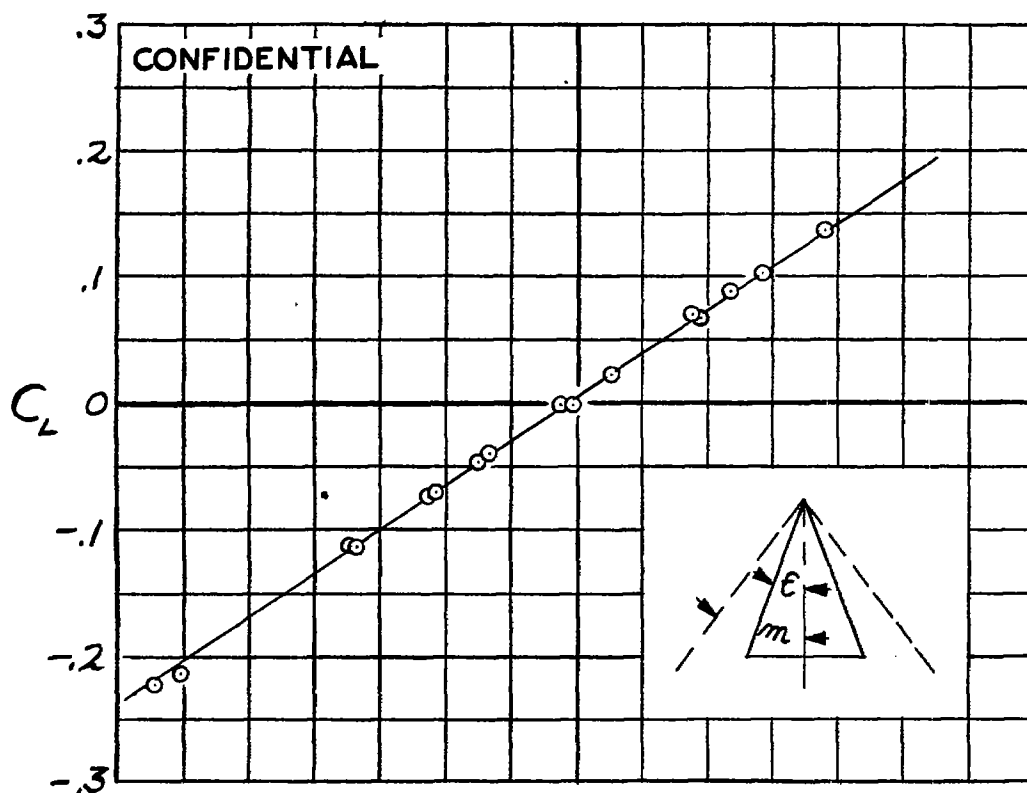

(h) Wing 8; $R=940,000$
 Figure 4.- Concluded.

*Measured lift curve slope
 Theor. 2-dimensional lift curve slope*

CONFIDENTIAL

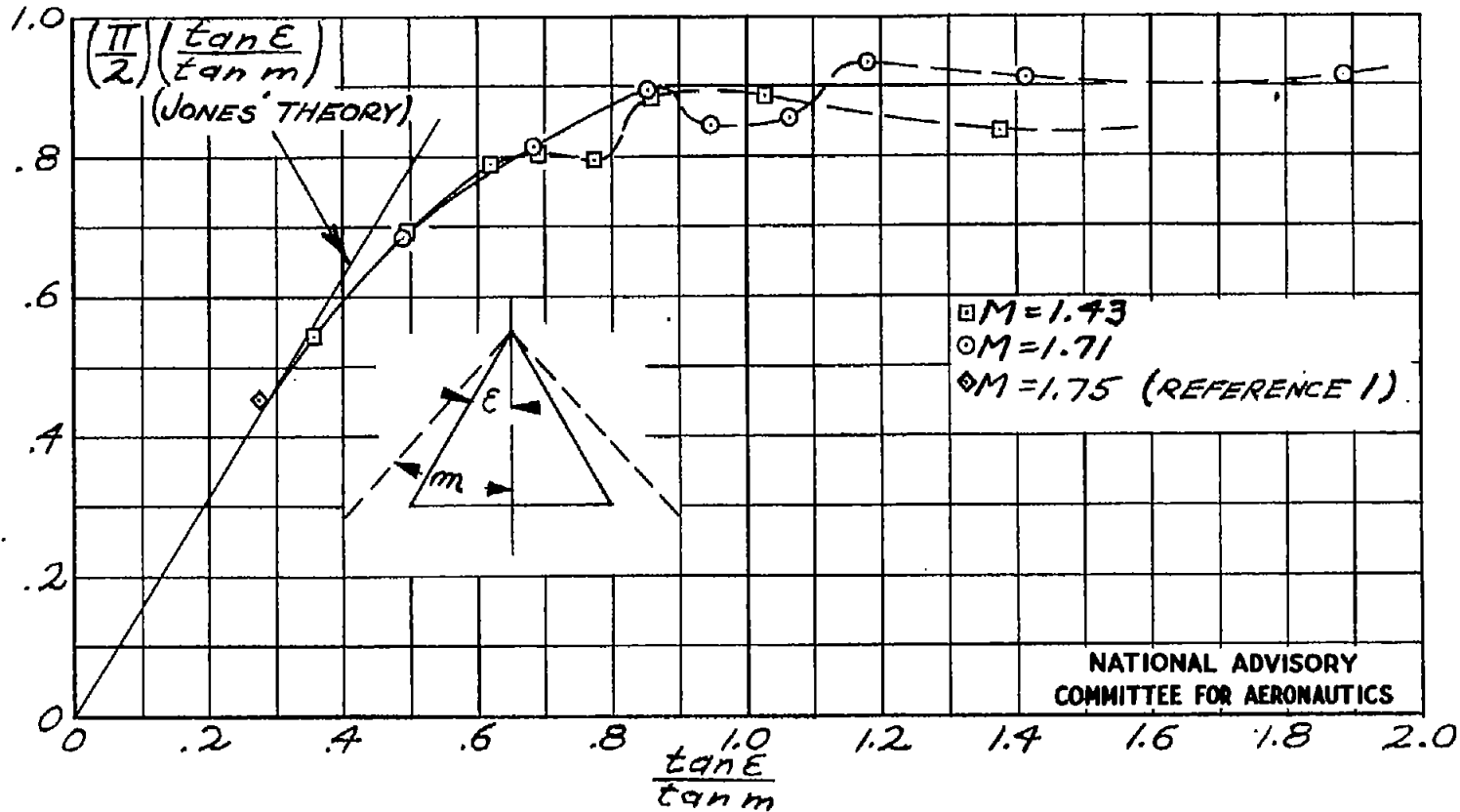

NATIONAL ADVISORY
 COMMITTEE FOR AERONAUTICS

Figure 5.- Triangular wing lift curve slope results from figures 3 and 4.

CONFIDENTIAL

Fig. 6

NACA RM No. L6L17

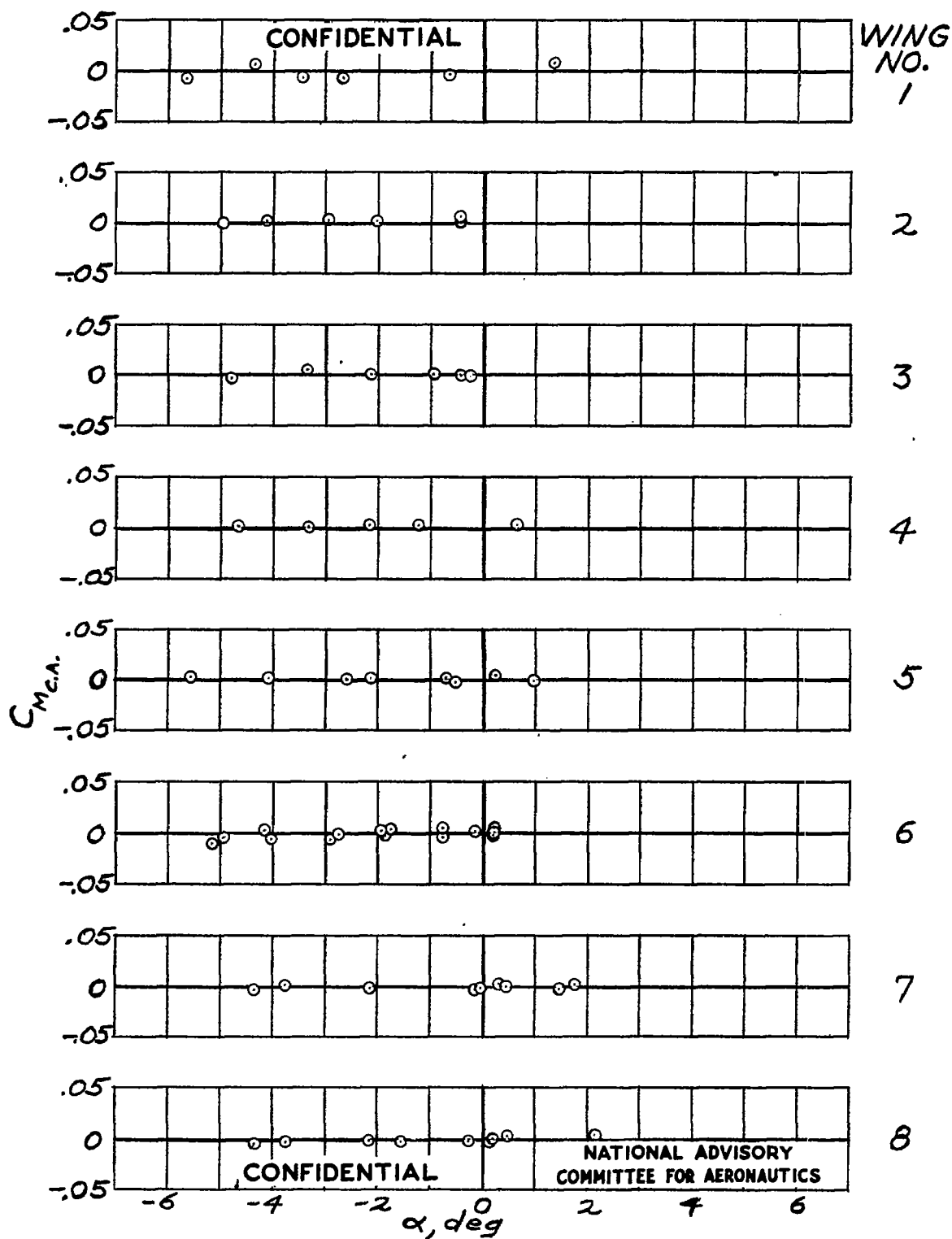

Figure 6.-Triangular wing-moment test results for $M=1.43$.

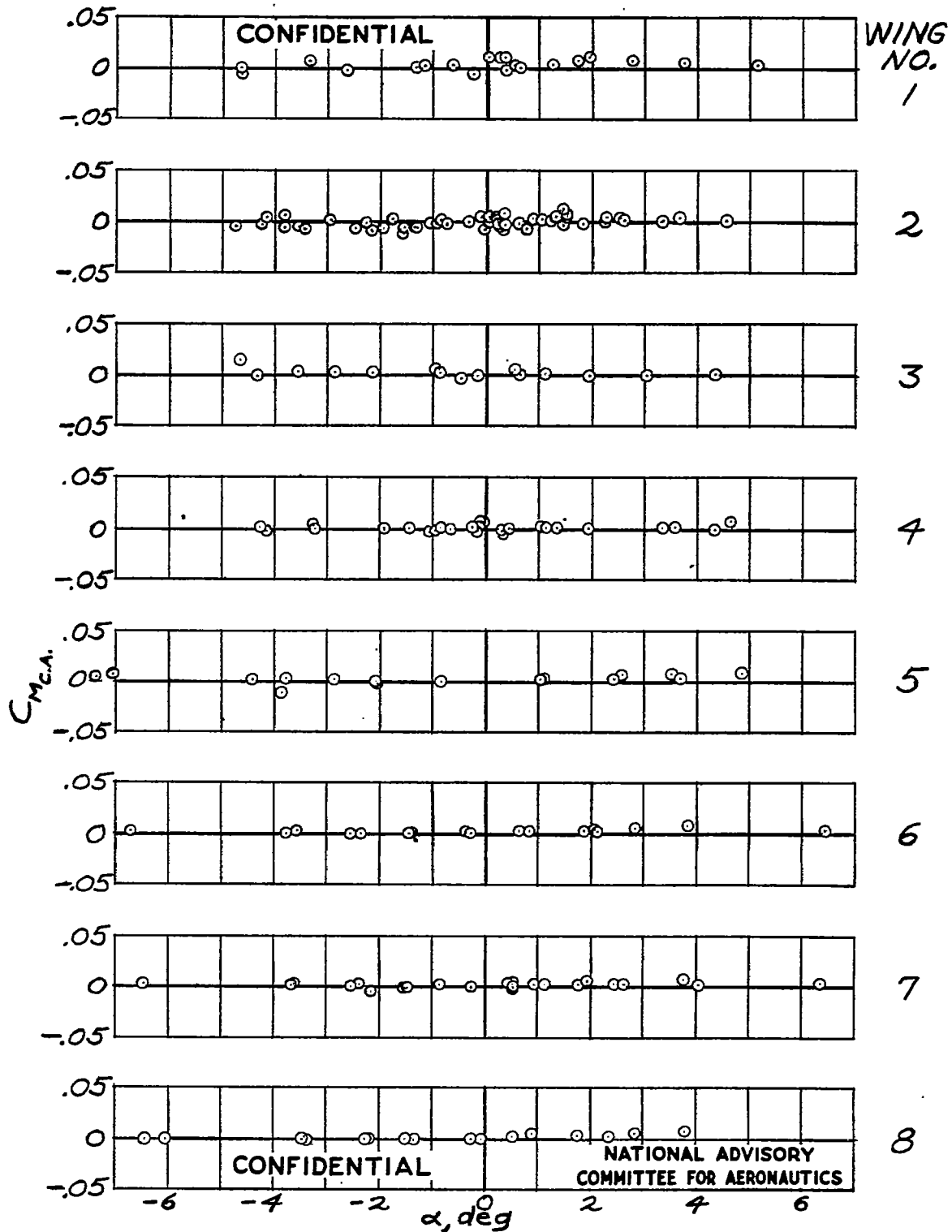

Figure 7.- Triangular wing moment test results for $M=1.71$.

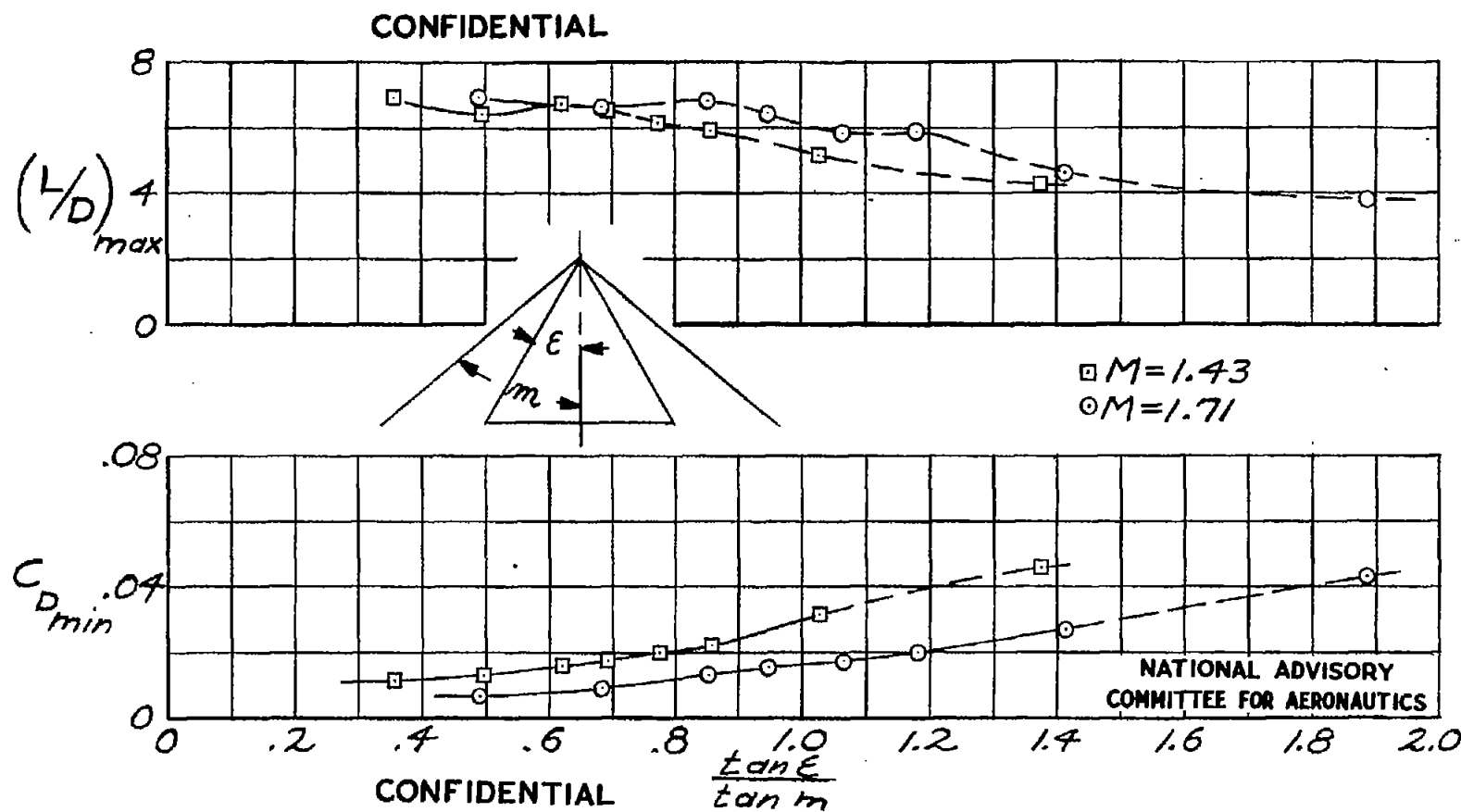

Figure 8.- Triangular wing minimum drag coefficient and maximum L/D test results from figures 3 and 4.

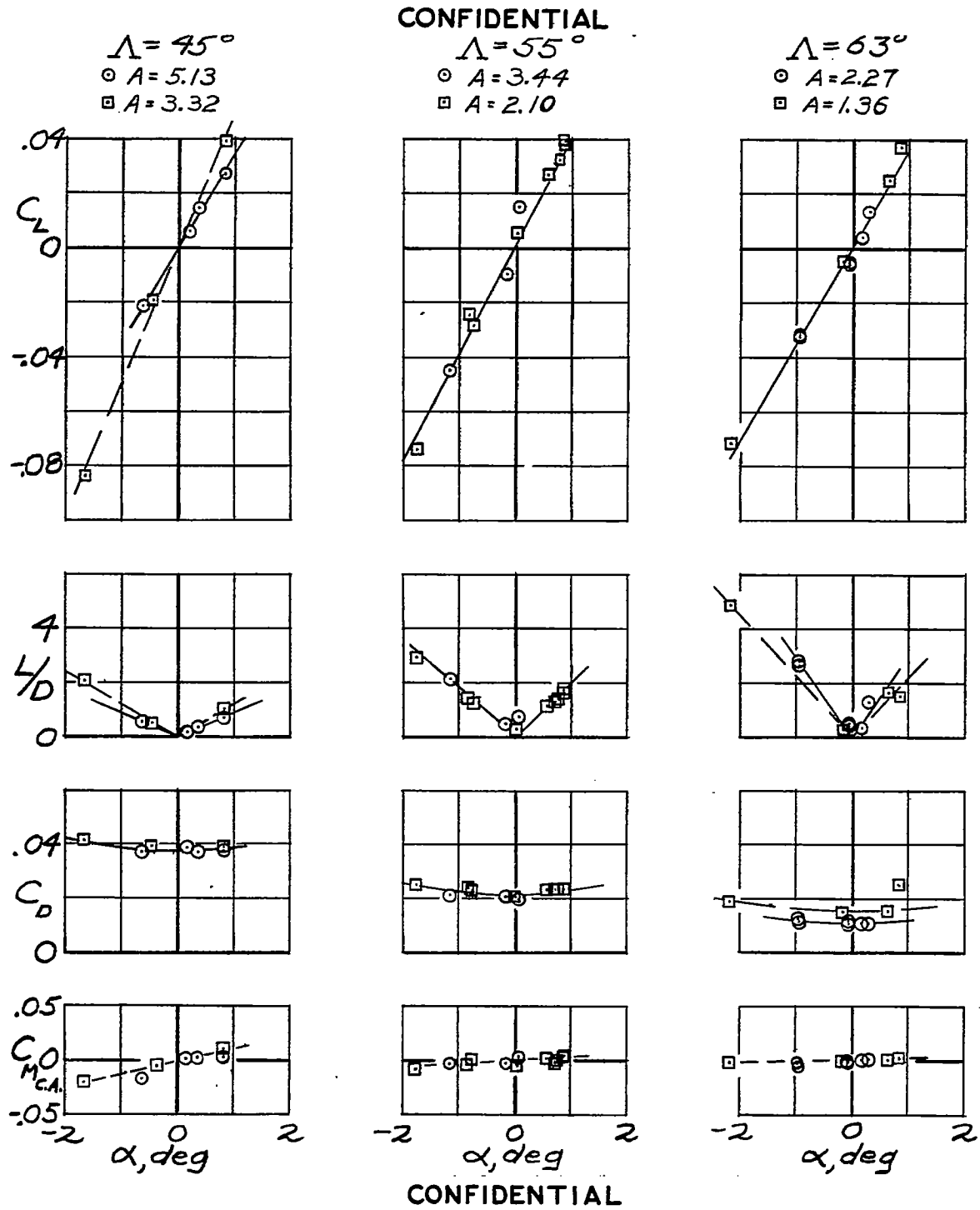

Figure 9.- Sweptback wing test results for
 $M = 1.43$.
 NATIONAL ADVISORY
 COMMITTEE FOR AERONAUTICS

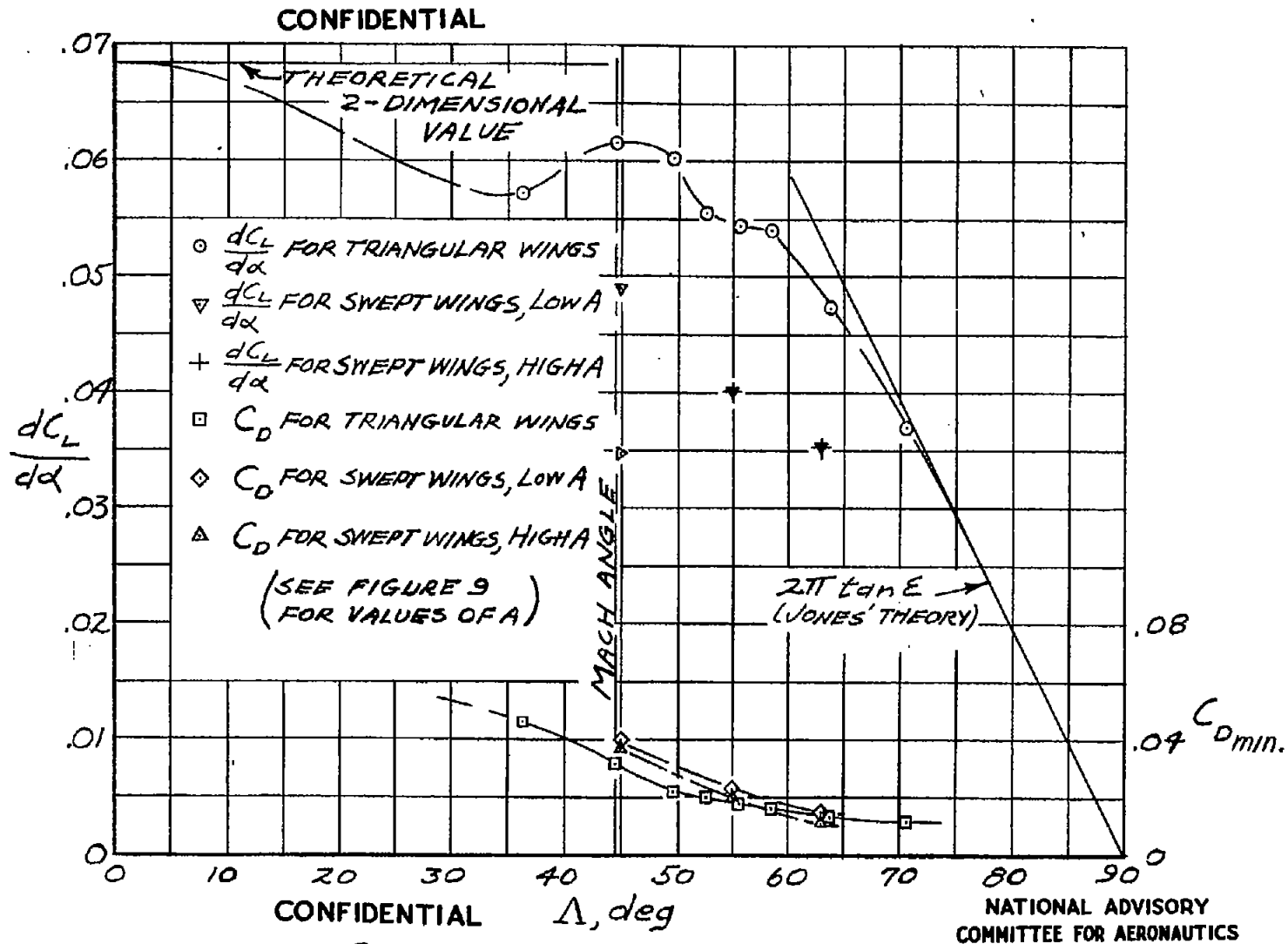

Figure 10.- Comparison of lift and drag results for triangular and sweptback wings at $M = 1.43$.

CONFIDENTIAL



(a) $\Lambda = 63^\circ$.



(b) $\Lambda = 63^\circ$; side view.

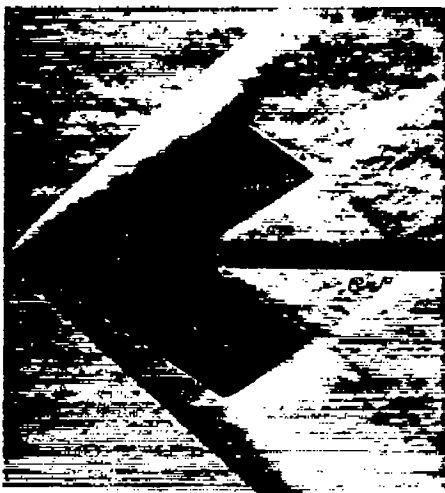

(c) $\Lambda = 55^\circ$.



(d) $\Lambda = 45^\circ$.

Figure 11.- Schlieren photographs of low aspect ratio swept-back wings at $M = 1.55$.

CONFIDENTIAL

NATIONAL ADVISORY COMMITTEE FOR AERONAUTICS
LANGLEY MEMORIAL AERONAUTICAL LABORATORY - LANGLEY FIELD, VA.