

3642
NACA TN 2222

TECH LIBRARY KAFB, NM
0065037

NATIONAL ADVISORY COMMITTEE FOR AERONAUTICS

TECHNICAL NOTE 2222

A METHOD FOR THE DETERMINATION OF THE SPANWISE LOAD
DISTRIBUTION OF A FLEXIBLE SWEPT WING AT
SUBSONIC SPEEDS

By Richard B. Skoog and Harvey H. Brown

Ames Aeronautical Laboratory
Moffett Field, Calif.



Washington
March 1951

AMES
TECHNICAL LIBRARY
MARCH 1951

319.98/100



	<u>Page</u>
SUMMARY	1
INTRODUCTION	1
SYMBOLS	2
THEORY	5
Loading on Flexible Wing	7
Aeroelastic Twist of Flexible Wing	8
Twist due to loading on flexible wing	8
Twist associated with individual loadings	11
Twist for additional loading only	11
Twist for basic loading only	12
Twist for camber loading only	12
Twist for inertia loading only	13
Evaluation of Aeroelastic Integrals	14
Swept-back wings	14
Swept-forward wings	16
Determination of Aerodynamic Span Loading for Flexible Wing	16
Stability Parameters for Flexible Wing	17
Lift-curve slope	17
Constant lift-coefficient analysis	17
Constant angle-of-attack analysis	18
Aerodynamic center	19
Divergence Speed for Flexible Wing	20
APPLICATION	20
Computing Forms	20
Numerical Example	21

Loading	22
Stability parameters	22
APPENDIX - DERIVATION OF WING TWIST POWER SERIES	24
REFERENCES	27
TABLES	28
FIGURES	37

NACA TN 2222

NATIONAL ADVISORY COMMITTEE FOR AERONAUTICS

TECHNICAL NOTE 2222

A METHOD FOR THE DETERMINATION OF THE SPANWISE LOAD DISTRIBUTION
OF A FLEXIBLE SWEEP WING AT SUBSONIC SPEEDS

By Richard B. Skoog and Harvey H. Brown

SUMMARY

A method is presented for the determination of the spanwise load distribution of a flexible swept wing at subsonic speeds. The method is based on a relaxation approach utilizing aerodynamic loadings obtained from previously published work (NACA Rep. 921, 1948) based on Weissinger's simplified lifting-surface theory together with simple beam theory. The solution is expressed in a convenient form such that the amount of detailed computing involved when extensive aeroelastic calculations for many flight conditions are desired is reduced to that for a single set of flight conditions. The method is simplified further by an abbreviated solution to the relaxation process. Sample computing forms and a numerical example are presented to illustrate the method.

INTRODUCTION

In the design of unswept wings, the spanwise distribution of aerodynamic load usually has been considered to be independent of structural deflections since torsional deflections normally are negligible at design operating speeds (usually well below the wing divergence speed) and bending deflections are not a factor for zero sweep. On a swept wing, however, the span load distribution no longer may be considered to be independent of structural deflections since the contribution of bending to the streamwise change in section angle of attack can become of considerable magnitude as the sweep angle is increased. In addition to this aeroelastic effect associated with wing sweep the trend toward higher operating dynamic pressures causes factors, which were previously negligible, to assume increased significance.

Several methods have been suggested for calculating the aerodynamic loading of the flexible swept wing, both explicitly (references 1 and 2) and by iteration (reference 3). The approach in each of these methods

has been to incorporate aerodynamic and structural theory in an equation of equilibrium expressing the balance existing between external and internal forces on the wing. To simplify the mathematics involved, matrix notations have been employed in two of these methods (references 1 and 2). Although two of the methods (references 2 and 3) indicate how aerodynamic theory other than strip theory could be employed, it is apparent that such application increases the mathematical difficulties a great deal so that the simplest aerodynamic theory has been used in all the methods. In addition, although solution of the problem by use of matrices has the advantage of simplicity in reducing the necessary computations to a routine form, the engineer unversed in this mathematical tool encounters a loss in physical appreciation.

The present method arose from the effort to fill the need for a mathematically simple approach which can yet include the aerodynamic refinements contained in lifting-line or lifting-surface theories. It was desired, also, to separate the aeroelastic effects associated with the various rigid-wing loadings so that it would not be necessary to perform detailed calculations for each new set of flight conditions.

The method of this report is based on relaxation concepts and employs aerodynamic span load distributions from previously published work (reference 4) based on Weissinger's simplified lifting surface theory together with structural deflections found from simple beam theory. Sample computing forms and calculated effects for an example wing also are presented.

SYMBOLS

- A wing aspect ratio $\left(\frac{b^2}{S}\right)$
- a distance from elastic axis to section quarter chord measured normal to elastic axis (positive measured forward), inches (See fig. 1.)
- A_z ratio of net aerodynamic force along the airplane Z axis (positive when directed upward) to the weight of the airplane
- b wing span measured normal to plane of symmetry, inches
- c section chord parallel to the plane of symmetry, inches
- c' section chord normal to the elastic axis, inches
- c_{av} average section chord parallel to the plane of symmetry, inches
- \bar{c} mean aerodynamic chord $\left(\frac{\int c^2 dy}{\int c dy}\right)$, inches

- c_{m_0} section pitching-moment coefficient due to camber as usually defined $\left(\frac{\text{section pitching moment}}{qc^2} \right)$
- $c_{m_0}^i$ section pitching-moment coefficient due to camber as used in this report (associated with camber, chord length, and dynamic pressure normal to the wing quarter-chord line)
- C_L wing lift coefficient $\left(\frac{\text{lift}}{qS} \right)$
- $C_{L\alpha}$ rate of change of lift coefficient with angle of attack of root section at plane of symmetry
- c_l section lift coefficient
- c_{l_e} section lift coefficient from additional-type loading
- c_{l_b} section lift coefficient from basic-type loading associated with built-in structural twist
- c_{l_e} total change in section lift coefficient due to structural deflection
- $c_{l_{e_a}}$ change in section lift coefficient due to structural deflection associated with additional loading
- $c_{l_{e_b}}$ change in section lift coefficient due to structural deflection associated with basic loading
- $c_{l_{e_{c_{m_0}}}}$ change in section lift coefficient due to structural deflection associated with torsional moment due to camber loading
- $c_{l_{e_{AZ}}}$ change in section lift coefficient due to structural deflection associated with inertia loading
- E Young's modulus of elasticity, pounds per square inch
- ϵ total change in section angle of attack due to structural deflection, radians
- ϵ_{C_L} change in section angle of attack due to structural deflection associated with additional loading, radians
- ϵ_{ϵ_b} change in section angle of attack due to structural deflection associated with basic loading, radians
- $\epsilon_{c_{m_0}^i}$ change in section angle of attack due to structural deflection associated with torsional moment due to camber loading, radians

- ϵ_{AZ} change in section angle of attack due to structural deflection associated with inertia loading, radians
- ϵ_{bt} built-in structural twist of tip section with respect to root section, radians
- ϵ_o change in section angle of attack due to structural deflection produced by rigid-wing loadings, radians
- $\Delta\epsilon$ change in section angle of attack due to structural deflection produced by the aerodynamic loading introduced by deflection, radians
- G modulus of elasticity in shearing, pounds per square inch.
- h distance from elastic axis to section center of gravity measured normal to elastic axis (positive measured forward), inches
- I moment of inertia in bending, inches to the fourth power
- J polar moment of inertia, inches to the fourth power
- l section lift loading, pounds per inch
- l_w section lift loading plus section inertia loading for chord sections defined by c' , pounds per inch
- M bending moment at any position along the swept span in a plane normal to assumed effective root (see fig. 1), inch-pound
- η dimensionless span coordinate $[Y/(b/2)]$, fraction of semispan
- q free-stream dynamic pressure, pounds per square inch
- S wing area (total), square inches
- s semispan measured along elastic axis, inches
- T torsional moment at any position along the swept span in a plane normal to the elastic axis, inch-pound
- Y span coordinate, inches
(See fig. 1.)
- t_w torsional moment representing combined contribution of section lift, inertia, and moment to the torsional loading about the elastic axis at any spanwise station, inch-pounds per inch

- v angular change in slope of the elastic axis due to bending, radians
- ϕ rotation of wing sections normal to the elastic axis due to torsion, radians
- $\Lambda_{c/4}$ angle of sweep of the quarter-chord line, degrees
(See fig. 1.)
- Λ_{ea} angle of sweep of elastic axis (positive for sweepback), degrees
(See fig. 1.)
- W total airplane weight, pounds
- w section structural weight based on chord sections defined by c' , pounds per inch
- λ wing taper ratio $\left(\frac{\text{tip chord}}{\text{root chord}} \right)$

THEORY

The method discussed in this report is developed to apply to the general case of a flexible wing with built-in structural twist, camber, and with structural inertia. The essential feature of the method is the application of relaxation¹ procedures to the physical problem of determining the aerodynamic span load distribution for the flexible wing. In formulating the theory in the subsections of the report which follow, the unknown aerodynamic span load distribution for the flexible wing expressed in general terms is applied to the wing together with the known load distribution due to inertia. From the bending and torsional deflections associated with this loading, the rotation (or aeroelastic twist) of wing sections parallel to the plane of symmetry then is derived. An implicit equation thus is obtained for the twist distribution of the flexible wing corresponding to the final equilibrium position of the wing under the combined aerodynamic, elastic, and inertia forces. To solve the equation, relaxation methods are applied, resulting in a series-type solution for the loading change contributed by structural deflection. As a final step, the lengthy series-type solution is converted to an abbreviated solution which approximates the series-type solution very closely.

¹In reference 5, relaxation methods are shown to provide a powerful tool in solving redundant problems of structural frameworks, electrical circuits, and vibratory systems. In the present report the relaxation approach employed is based on the principles of that reference rather than the exact procedures outlined therein.

In applying relaxation methods to the present problem, the wing is assumed to be fixed in position as the rigid-wing loading is applied to the wing and then the wing is allowed to deflect under the applied load. The wing then is fixed in the deflected position, while the loading corresponding to the afore-mentioned deflection as found from rigid-wing theory is applied to the wing. The wing then is allowed to deflect again. In this way successive deflections can be found which are dependent on the loading corresponding to the previous deflection. In the formulation of the theory, this procedure is used only to develop the series-type solution. Actually in practice the abbreviated solution previously mentioned is used. In order to apply the method most expeditiously, available methods for the quick determination of aerodynamic span load distributions for wings of arbitrary twist and arbitrary plan form (e.g., reference 4) should be used. With any load distribution so determined and a knowledge of where to apply the load, it is then a simple matter to calculate the amount of structural deflection (bending or torsion) due to that load using well-known methods of solution.

Before discussing the theory in detail, it is desirable to establish the conventions which are used throughout the report with regard to span load distribution. In accordance with the convention of reference 6 the spanwise distribution of lift on the rigid wing is considered to be separated into an additional lift distribution and a basic lift distribution, the additional lift being proportional to wing angle of attack and the basic lift being dependent only on built-in structural twist. In this report, the spanwise lift distribution on the flexible wing is considered to be separated into (1) the additional and basic loadings as defined above for the rigid wing, and (2) an aeroelastic loading defined as that due to the section angle-of-attack changes produced by structural deflection.

The axes referred to in the report are shown in figure 1. The Y axis is the reference axis for all aerodynamic span load distributions with the lift assumed to act at the quarter-chord line. The wing is assumed to have an effective root perpendicular to the elastic axis and located at the intersection of the elastic axis and the plane of symmetry.

In the following discussion, the basic theory is developed in the subsections, Loading on Flexible Wing, Aeroelastic Twist of Flexible Wing, and Evaluation of Aeroelastic Integrals. The details of this development are described in the following steps:

1. In the subsection, Loading on Flexible Wing, expressions are presented for the running load and running torque on the flexible wing in terms of the component loading involved.

2. In the subsection, Aeroelastic Twist of Flexible Wing, a general expression is developed for the twist due to structural deflection based on the unknown aerodynamic loading² for the flexible wing and the effect of inertia as presented in the first section. It is also shown how the general equation may be broken down to lessen the amount of computing involved when extensive aeroelastic calculations are desired.

3. In the subsection, Evaluation of Aeroelastic Integrals, it is shown how the equation resulting from application of the relaxation method can be abbreviated to provide a simple and direct means of evaluating the implicit twist equations presented in the previous subsection.

Based on the background developed in these three sections, an equation is presented in a fourth subsection, Determination of Span Loading for Flexible Wing, showing how the span loading for the flexible wing is determined from the various loadings involved. The application of the basic theory to determination of lift-curve slope, aerodynamic center, and divergence speed for the flexible wing also is discussed in subsequent subsections.

Loading on Flexible Wing

The loads which will produce bending of a flexible wing are the rigid-wing aerodynamic lift (additional and basic), the inertia load normal to the wing, and the increments in aerodynamic lift produced by aeroelastic twist. The lifting load per unit span based on streamwise wing sections can be expressed as

$$\begin{aligned} l &= (\text{rigid-wing loading}) + (\text{loading produced by wing deflection}) \\ &= (c_{l_a} c_q + c_{l_b} c_q) + (c_{l_e} c_q) \end{aligned} \quad \left. \vphantom{\begin{aligned} l &= (\text{rigid-wing loading}) + (\text{loading produced by wing deflection}) \\ &= (c_{l_a} c_q + c_{l_b} c_q) + (c_{l_e} c_q) \end{aligned}} \right\} (1)$$

If it is assumed that the effect of taper on sweep is small enough that $\Lambda_c/4$ may be taken equal to $\Lambda_{\theta a}$ and if the effects of inertia or dead weight also are included, the lifting load per unit span along the wing panel can be expressed as

²In setting up the expressions for aeroelastic twist, it is convenient to think of the entire flexible wing loading as being unknown. Actually all components are known except the component introduced by structural deflection.

$$l_w = (c_{l_a} c_q + c_{l_b} c_q) \cos \Lambda_{ea} + c_{l_e} c_q \cos \Lambda_{ea} - w A_z \quad (2)$$

The aerodynamic and inertia loadings normal to the plane of the wing will produce a torsional loading about the elastic axis if their lines of application do not coincide with the elastic axis. If a wing has camber there will be another torsional loading due to c_{m_0} . In this report, the contribution of camber has been taken such as to affect only torsional deflections of the wing since it was felt that values of pitching-moment coefficient for sections normal to the quarter-chord line would more likely be available from two-dimensional tests. In so doing, however, it is assumed that simple sweep concepts can be applied to finite-span wings without serious error. The torsional moment representing the combined contribution of section lift, inertia, and moment to the torsional loading about the elastic axis³ at any spanwise station thus may be expressed as

$$\begin{aligned}
 t_w = & \text{(rigid-wing torsional loading) +} \\
 & \text{(torsional loading produced by wing deflection)} \\
 = & \left[(c_{l_a} c_q + c_{l_b} c_q) a \cos \Lambda_{ea} - w A_z h + c_{m_0} c^2 q \cos^4 \Lambda_{ea} \right] + \\
 & (c_{l_e} c_q a \cos \Lambda_{ea}) \quad (3)
 \end{aligned}$$

Aeroelastic Twist of Flexible Wing

In this section of the report, expressions for the rotation (or aeroelastic twist) of streamwise sections of the flexible wing are derived in terms of simple integrals of shear and moment based on

³The torsional loading about the elastic axis at $\eta = \eta_1$ (where η_1 is an arbitrary value of η) will be a summation of loadings in a plane normal to the elastic axis. Since this plane will intersect the spanwise line of application of the aerodynamic or inertia loadings at some point $\eta = \eta_2$ (where $\eta_2 \neq \eta_1$) an error is introduced, which was ignored in the analysis.

elementary beam theory. The general case of the twist due to the loadings on the flexible wing given by equations (2) and (3) is discussed first, followed by discussion of a convenient way of breaking down the general expression for aeroelastic twist to facilitate computation when extensive aeroelastic calculations for a large number of flight conditions are desired.

Twist due to loading on flexible wing.— The bending moment at any point along the span due to the flexible-wing loading will be⁴

$$M = s^2 \int_{1.0}^{\eta} \int_{1.0}^{\eta} l_w d\eta d\eta \quad (4)$$

and the torsion will be⁴

$$T = s \int_{1.0}^{\eta} t_w d\eta \quad (5)$$

From elementary beam theory

$$v = s \int_0^{\eta} \frac{M}{EI} d\eta \quad (6)$$

and

$$\varphi = s \int_0^{\eta} \frac{T}{GJ} d\eta \quad (7)$$

For the case of the swept wing, both bending along the elastic axis and twisting about the elastic axis cause changes in the streamwise angle of attack. The change in section angle of attack⁵ due to structural deflection for arbitrary bending and twist may be expressed as

⁴Again a slight error is introduced (see footnote 3) because the various loadings lie along different axes. To be correct the loadings should be referenced with respect to the elastic axis rather than Y axis. The effect of drag on bending moment also was neglected in the analysis and normal force was assumed equal to lift force.

⁵This involves the assumption of a straight elastic axis for the undeflected wing and ignores the effect of taper in regard to the rotation of wing sections due to torsion.

$$\epsilon = -v \sin \Lambda_{ea} + \phi \cos \Lambda_{ea} \quad (8)$$

In the case of swept-back wings, the two terms of equation (8) will be of opposite sign. For swept-forward wings, the terms are of like sign. Substituting as required in equation (8), we have

$$\begin{aligned} \epsilon &= -s \sin \Lambda_{ea} \int_0^\eta \frac{M}{EI} d\eta + s \cos \Lambda_{ea} \int_0^\eta \frac{T}{GJ} d\eta \\ &= -s^3 \sin \Lambda_{ea} \int_0^\eta \frac{\int_{1.0}^\eta \int_{1.0}^\eta l_w d\eta d\eta}{EI} d\eta + \\ &\quad s^2 \cos \Lambda_{ea} \int_0^\eta \frac{\int_{1.0}^\eta t_w d\eta}{GJ} d\eta \end{aligned} \quad (9)$$

If substitution is made for l_w and t_w from equations (2) and (3) and if the terms are arranged in such a manner as to show clearly the various types of loading which contribute to the streamwise twist of a flexible wing, the expression for ϵ becomes:⁶

⁶Equation (10) consists of nine terms. The word description given opposite each term on page 11 merely gives a physical explanation for the existence of the term for the convenience of the reader.

$$\epsilon = -s^3 \sin \Lambda_{ea} \int_0^\eta \int_{1.0}^\eta \int_{1.0}^\eta \frac{c_{l_a} c_q \cos \Lambda_{ea} d\eta d\eta}{EI} d\eta$$

$$+ s^2 \cos \Lambda_{ea} \int_0^\eta \frac{\int_{1.0}^\eta c_{l_a} c_{qa} \cos \Lambda_{ea} d\eta}{GJ} d\eta$$

$$- s^3 \sin \Lambda_{ea} \int_0^\eta \int_{1.0}^\eta \int_{1.0}^\eta \frac{c_{l_b} c_q \cos \Lambda_{ea} d\eta d\eta}{EI} d\eta$$

$$+ s^2 \cos \Lambda_{ea} \int_0^\eta \frac{\int_{1.0}^\eta c_{l_b} c_{qa} \cos \Lambda_{ea} d\eta}{GJ} d\eta$$

$$+ s^2 \cos \Lambda_{ea} \int_0^\eta \frac{\int_{1.0}^\eta c_{m_0}^2 c_q^2 \cos^4 \Lambda_{ea} d\eta}{GJ} d\eta$$

$$+ s^3 \sin \Lambda_{ea} \int_0^\eta \frac{\int_{1.0}^\eta \int_{1.0}^\eta w A_Z d\eta d\eta}{EI} d\eta$$

$$- s^2 \cos \Lambda_{ea} \int_0^\eta \frac{\int_{1.0}^\eta w h A_Z d\eta}{GJ} d\eta$$

$$- s^3 \sin \Lambda_{ea} \int_0^\eta \int_{1.0}^\eta \int_{1.0}^\eta \frac{c_{l_e} c_q \cos \Lambda_{ea} d\eta d\eta}{EI} d\eta$$

$$+ s^2 \cos \Lambda_{ea} \int_0^\eta \frac{\int_{1.0}^\eta c_{l_e} c_{qa} \cos \Lambda_{ea} d\eta}{GJ} d\eta$$

(10)

- [1] twist due to bending caused by additional load of the rigid wing
- [2] twist due to tor-
sion caused by additional load of the rigid wing
- [3] twist due to bend-
ing caused by basic load of rigid wing
- [4] twist due to tor-
sion caused by basic load of rigid wing
- [5] twist due to tor-
sion caused by c_{m_0} of rigid wing
- [6] twist due to bend-
ing caused by inertia loads
- [7] twist due to tor-
sion caused by inertia loads
- [8] twist due to bend-
ing caused by aeroelastic loading
- [9] twist due to tor-
sion caused by aeroelastic loading

It is evident that the first seven terms of the preceding expression give the twist due to various types of loading of the rigid wing. The computation of this portion of ϵ is fairly straightforward; however,

the last two terms (terms [8] and [9]) include c_{l_e} (which is a function of ϵ) so that an explicit solution for these terms is not immediately apparent.

Twist associated with individual loadings.— As already stated, the purpose of the method presented in this report is to determine the aerodynamic spanwise load distribution for a flexible wing. If this load distribution is desired for only a single set of flight conditions (involving a specific combination of C_L , q , and A_Z), the over-all effect of flexibility is expressed by equation (10). However, normally it is desired to examine the aeroelastic effects of a wing over a wide range of C_L , q , and A_Z and for various combinations of these factors. Therefore, it is usually more convenient to separate c_{l_e} appearing in terms [8] and [9] into the components $c_{l_{ea}}$, $c_{l_{eb}}$, $c_{l_{ec_{m_0}}}$, and $c_{l_{eA_Z}}$

associated with c_{l_a} , c_{l_b} , c_{m_0} , and A_Z , respectively. The advantage of solving the problem in this way lies in the fact that only one detailed computation of the components of c_{l_e} need be made. This simplification arises from the fact that (1) $c_{l_{ea}}$ is proportional to C_L , (2) $c_{l_{eb}}$ and $c_{l_{ec_{m_0}}}$ do not depend on C_L , and (3) $c_{l_{eA_Z}}$

is proportional to A_Z (or to C_L for a given q and W/S). It is possible also to perform the calculations for unit built-in twist and unit camber effect. The terms of equation (10) therefore can be separated into several components as follows:

1. Twist for additional loading only.— The aeroelastic twist ϵ_{C_L} associated with the additional loading, consists of terms [1] and [2] of equation (10) plus the portions of terms [8] and [9] contributed by $c_{l_{ea}}$. Since the additional loading is proportional to C_L , ϵ_{C_L} can be put into the following form:

$$\epsilon_{C_L} = C_L \left[-c_{av} q s^3 \sin \Lambda_{ea} \int_0^\eta \int_{1.0}^\eta \int_{1.0}^\eta \frac{\left(\frac{c_{l_a}^c}{C_L c_{av}} \right) \cos \Lambda_{ea} d\eta d\eta}{EI} d\eta + \right. \\ \left. qc_{av}^2 s^2 \cos \Lambda_{ea} \int_0^\eta \int_{1.0}^\eta \left(\frac{c_{l_a}^c}{C_L c_{av}} \frac{a}{c_{av}} \right) \cos \Lambda_{ea} d\eta d\eta - \right. \\ \left. qc_{av} s^3 \sin \Lambda_{ea} \int_0^\eta \int_{1.0}^\eta \int_{1.0}^\eta \frac{\left(\frac{c_{l_{ea}}^c}{C_L c_{av}} \right) \cos \Lambda_{ea} d\eta d\eta}{EI} d\eta + \right. \\ \left. qc_{av}^2 s^2 \cos \Lambda_{ea} \int_0^\eta \int_{1.0}^\eta \left(\frac{c_{l_{ea}}^c}{C_L c_{av}} \right) \cos \Lambda_{ea} \frac{a}{c_{av}} d\eta d\eta \right] \quad (11)$$

In this equation the terms within the brackets are based on unit C_L . Once these terms have been evaluated, ϵ_{C_L} may be found for any value of C_L simply by multiplying by C_L .

2. Twist for basic loading only.— The aeroelastic twist ϵ_{ϵ_b} , associated with the basic loading, consists of terms [3] and [4] of equation (10) plus the portions of terms [8] and [9] contributed by $c_{l_{\epsilon_b}}$. Since the basic loading is proportional to built-in twist, ϵ_{ϵ_b} can be put in the following form:

$$\begin{aligned} \epsilon_{\epsilon_b} = \epsilon_{b_t} & \left[-qc_{av} s^3 \sin \Lambda_{ea} \int_0^\eta \int_{1.0}^\eta \int_{1.0}^\eta \left(\frac{c_{l_b}^c}{\epsilon_{b_t} c_{av}} \right) \cos \Lambda_{ea} d\eta d\eta + \right. \\ & qc_{av}^2 s^2 \cos \Lambda_{ea} \int_0^\eta \int_{1.0}^\eta \left(\frac{c_{l_b}^c}{\epsilon_{b_t} c_{av}} \right) \cos \Lambda_{ea} \frac{a}{c_{av}} d\eta - \\ & qc_{av} s^3 \sin \Lambda_{ea} \int_0^\eta \int_{1.0}^\eta \int_{1.0}^\eta \left(\frac{c_{l_{\epsilon_b}}^c}{\epsilon_{b_t} c_{av}} \right) \cos \Lambda_{ea} d\eta d\eta + \\ & \left. qc_{av}^2 s^2 \cos \Lambda_{ea} \int_0^\eta \int_{1.0}^\eta \left(\frac{c_{l_{\epsilon_b}}^c}{\epsilon_{b_t} c_{av}} \right) \frac{a}{c_{av}} \cos \Lambda_{ea} d\eta \right] \quad (12) \end{aligned}$$

In this equation the terms within the brackets are based on unit structural twist of the tip section for a given spanwise distribution of twist. Once these terms have been evaluated for this distribution, ϵ_{ϵ_b} can be found for any amount of twist having the same distribution simply by multiplying by ϵ_{b_t} .

3. Twist for camber loading only.— The aeroelastic twist $\epsilon_{c_{m_0}^i}$, associated with the torsional moment due to camber loading, consists of term [5] of equation (10) plus the portions of terms [8] and [9] contributed by $c_{l_{\epsilon_{c_{m_0}^i}}}$. Since the torsion due to camber depends upon the amount of camber (or the value of $c_{m_0}^i$), $\epsilon_{c_{m_0}^i}$ can be put in the following form, provided the camber is constant across the span:

$$\epsilon_{c_{m_0}} = \frac{c_{m_0}}{0.01} \left\{ qc_{av}^2 s^2 \cos \Lambda_{ea} \int_0^\eta \frac{\int_{1.0}^\eta \left[0.01 \left(\frac{c}{c_{av}} \right)^2 \cos^4 \Lambda_{ea} \right] d\eta}{GJ} d\eta - \right.$$

$$qc_{av} s^3 \sin \Lambda_{ea} \int_0^\eta \frac{\int_{1.0}^\eta \int_{1.0}^\eta \left(\frac{c_{l_e} c_{m_0}^c}{c_{av}} \right) \cos \Lambda_{ea} d\eta d\eta}{EI} d\eta +$$

$$\left. qc_{av}^2 s^2 \cos \Lambda_{ea} \int_0^\eta \frac{\int_{1.0}^\eta \left(\frac{c_{l_e} c_{m_0}^c}{c_{av}} \right) \frac{a}{c_{av}} \cos \Lambda_{ea} d\eta}{GJ} d\eta \right\} \quad (13)$$

In this equation the terms within the brackets are based on a unit camber equivalent to $c_{m_0} = 0.01$. Once these terms have been evaluated, $\epsilon_{c_{m_0}}$ may be found for any amount of this type camber by multiplying by $c_{m_0}/0.01$. In the case where a spanwise variation in camber is employed, the same procedure adopted for ϵ_{ϵ_D} can be used; that is, calculate the terms within the brackets for a given camber distribution and then use $c_{m_0}^c$ at some representative section as the scale factor.

4. Twist for inertia loading only.— The aeroelastic twist ϵ_{AZ} , associated with the inertia loading, consists of terms [6] and [7] of equation (10) plus the portions of terms [8] and [9] contributed by $c_{l_{eAZ}}$. Since the inertia or dead-weight loading is proportional to A_Z , ϵ_{AZ} can be put in the following form:

$$\epsilon_{AZ} = AZ \left[c_{av} s^3 \sin \Lambda_{ea} \int_0^\eta \frac{\int_{1.0}^\eta \int_{1.0}^\eta \frac{w}{c_{av}} d\eta d\eta}{EI} d\eta - \right.$$

$$c_{av}^2 s^2 \cos \Lambda_{ea} \int_0^\eta \frac{\int_{1.0}^\eta \frac{w}{c_{av}} \frac{h}{c_{av}} d\eta}{GJ} d\eta -$$

$$qc_{av} s^3 \sin \Lambda_{ea} \int_0^\eta \frac{\int_{1.0}^\eta \int_{1.0}^\eta \left(c_{l_{eAZ}} \frac{c}{c_{av}} \right) \cos \Lambda_{ea} d\eta d\eta}{EI} d\eta +$$

$$\left. qc_{av}^2 s^2 \cos \Lambda_{ea} \int_0^\eta \frac{\int_{1.0}^\eta \left(c_{l_{eAZ}} \frac{c}{c_{av}} \right) \frac{a}{c_{av}} \cos \Lambda_{ea} d\eta}{GJ} d\eta \right] \quad (14)$$

In this equation the terms within the brackets are based on a structural weight at lg . Once these terms have been evaluated, ϵ_{Az} may be found for any load factor simply by multiplying by A_z . It should be remembered that in combining the effect of A_z given by this equation and the effect of C_L given by equation (11), it is necessary to adhere to the following relation, in order to retain any physical significance:

$$A_z = \frac{C_L q}{W/S}$$

Evaluation of Aeroelastic Integrals

Swept-back wings.— As has already been discussed, terms [8] and [9] of equation (10) are not immediately solvable; however, as shown in the appendix, the solution of these terms can be expressed as a power series in q of the following type:

$$\Delta \epsilon(\eta) = f_1(\eta)q^2 + f_2(\eta)q^3 + f_3(\eta)q^4 + \dots + f_n(\eta)q^{n+1} \quad (15)$$

Equations (10) through (14) can be expressed, therefore, in series form as:

$$\epsilon(\eta) = +f_0(\eta)q + f_1(\eta)q^2 + f_2(\eta)q^3 + f_3(\eta)q^4 + \dots + f_n(\eta)q^n \quad (16)$$

where the coefficients are determined by the particular requirements of the equations (10) through (14) in mind. In this series (equation (16)) the values of successive terms are of opposite sign. If equation (16) is divided by $f_0(\eta)q$, we have

$$\frac{\epsilon(\eta)}{f_0(\eta)q} = 1 + \frac{f_1(\eta)}{f_0(\eta)} q + \frac{f_2(\eta)}{f_0(\eta)} q^2 + \dots \quad (17)$$

As has been shown by O. K. Smith in an unpublished Northrup report,⁷ succeeding terms of the series are very nearly related by a constant of proportionality so that equation (17) can be written as:

$$\frac{\epsilon(\eta)}{f_0(\eta)q} = 1 - kq + k^2q^2 \dots \quad (18)$$

⁷A similar approach also is contained in outline form in reference 7 under the section titled Effect of Wing Twist.

where⁸

$$k = -\frac{f_1(\eta)}{f_0(\eta)} = -\frac{f_2(\eta)}{f_1(\eta)}, \text{ etc.}$$

As also shown by Smith, the series of equation (18) represents an expansion of $1/1+kq$ so that $\epsilon(\eta)$ can be written as:

$$\epsilon(\eta) = \frac{q}{1+kq} f_0(\eta) \quad (19)$$

In these equations, $f_0(\eta)$ corresponds to terms [1] through [7] of equation (10) (or the first two terms of equation (11), (12), or (14), or the first term of equation (13)) with q set equal to unity. The function $f_1(\eta)$ corresponds to the twist produced by the aerodynamic loading obtained from $f_0(\eta)$ by the method of reference 4. With $f_0(\eta)$ and $f_1(\eta)$ determined, the twist distribution of the flexible wing $\epsilon(\eta)$ can be quickly determined for any value of q by equation (19). Then, having $\epsilon(\eta)$, it is a relatively simple matter to get $c_{l_e}(\eta)$ by the method of reference 4, which is based on the Weissinger simplified lifting-surface theory and is generalized to permit determination of load distribution for a wing of arbitrary plan form and arbitrary continuous twist distribution. The reference can be used to provide $c_{l_e}(\eta)$ for either a constant lift analysis or a constant angle-of-attack analysis.

It should be noted that the series represented by equation (16) will diverge at some value of dynamic pressure, depending on the structural rigidity. An outstanding advantage of equation (19) (in addition to being brief) is that no such mathematical difficulty will be encountered so that the aeroelastic effect at any dynamic pressure can be calculated.

⁸In practice, it is usually sufficiently accurate to determine k as:

$$k = -\frac{f_1(\eta)}{f_0(\eta)}$$

Since curves of the functions $f_0(\eta)$ and $f_1(\eta)$ will generally not be of exactly the same shape, the value of k will vary somewhat across the span. In the case of the example wing, the best approximation was obtained by using the value of k at $\eta=1.0$ since at that station the twists given by successive twist distributions (as evaluated using the series-type solution) were almost exactly proportional. It should be noted that the shape of a given ϵ curve as found from the series-type solution will differ slightly, in general, from the shape given by $f_0(\eta)$. It has been found, however, that the differences in curve shape encountered do not affect $c_{l_e}(\eta)$ significantly.

Swept-forward wings.— The method can be applied with approximately the same accuracy to a swept-forward wing by rewriting equation (19) so that a minus sign appears in the denominator of the function containing q .

The equation then becomes

$$\epsilon(\eta) = \frac{q}{1-kq} f_0(\eta) \quad (20)$$

the minus sign arising from the fact that the series for a swept-forward wing (equivalent to equation (18) for a swept-back wing) is $1+kq+k^2q^2+\dots$ which is merely an expansion of $1/1-kq$.

Determination of Aerodynamic Span Loading for Flexible Wing

The preceding sections of this report have laid the background for determining the aerodynamic span load distribution for a flexible wing. From equation (1)

$$\frac{l}{q} = c_{l_a} c + c_{l_b} c + c_{l_e} c \quad (21)$$

From equation (19) it is evident that the distribution of $c_{l_e} c$ across the span can be written as

$$c_{l_e} c(\eta) = \frac{q}{1+kq} f[f_0(\eta)] \quad (22)$$

For $q=1.0$, this load distribution can be written as

$$[c_{l_e} c(\eta)]_{q=1.0} = \frac{1}{1+k} f[f_0(\eta)] \quad (23)$$

If solution of $f[f_0(\eta)]$ from equation (23) is substituted in equation (22) and the resulting expression for $c_{l_e} c$ is then substituted in equation (21), equation (21) can then be written

$$\frac{l}{q} = c_{l_a} c + c_{l_b} c + \frac{q(1+k)}{1+kq} (c_{l_e} c)_{q=1.0} \quad (24)$$

If the following relation

$$c_{l_e} = c_{l_{e_a}} + c_{l_{e_b}} + c_{l_{e_c}}'_{m_0} + c_{l_{e_AZ}}$$

is substituted in equation (24) and if the various terms are written as loading coefficients, equation (24) becomes

$$\frac{l}{qc_{av}} = \left(\frac{c_{l_a}^c}{C_{Lc_{av}}} \right) C_L + \frac{c_{l_b}^c}{c_{av}} +$$

$$\frac{q(1+k)}{1+kq} \left[\left(\frac{c_{l_{\theta a}}^c}{C_{Lc_{av}}} \right) C_L + \frac{c_{l_{\theta b}}^c}{c_{av}} + \frac{c_{l_{\theta c m_0}}^c}{c_{av}} + \left(\frac{c_{l_{\theta AZ}}^c}{A_Z c_{av}} \right) A_Z \right]_{q=1.0} \quad (25)$$

With the various aeroelastic loadings evaluated for $q=1.0$, it is a simple matter to calculate $(l/qc_{av})(\eta)$ for the flexible wing for any combination of q , C_L , and A_Z .

Stability Parameters for Flexible Wing

Lift-curve slope.— The lift-curve slope for the flexible wing can be found by either of two methods, depending on whether the viewpoint adopted originally was that of constant lift coefficient or constant angle of attack. Both methods are presented here for convenience:

1. Constant lift-coefficient analysis.— The aeroelastic span load distribution resulting from a constant lift analysis is a basic-type loading, which yields zero lift when integrated. In solving for the aeroelastic loading by the method of reference 4, the angle of attack of the wing root α_r required to obtain zero over-all lift also is obtained. This angle of attack represents the angle through which the wing root must be turned in order to maintain a given wing lift coefficient for the flexible wing at all dynamic pressures. If the lift-curve slope for the rigid wing is known, the lift-curve slope for the flexible wing can be found graphically by simply laying off the value of α_r in the proper direction from the rigid-wing lift curve (increasing wing angle of attack for swept-back wings) at the C_L for which the value of α_r was obtained. This procedure is indicated in the following sketch for swept-back wings:

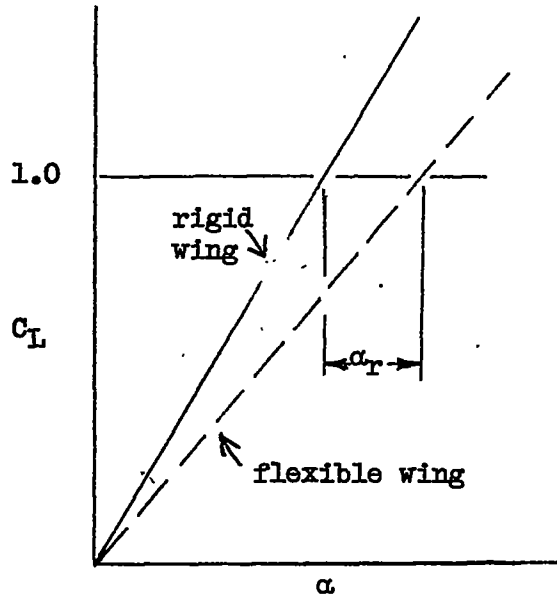

The value of α_r is made up of (1) the contribution associated with rigid-wing additional loading and (2) the contribution associated with inertia (or dead weight) loading, since only the contributions associated with these loadings are proportional to C_L . These contributions are given by the values of α_r associated with $c_{7e_a}(\eta)$ and $c_{7e_{AZ}}(\eta)$, respectively. These loadings are found from equations (11) and (14) previously presented. Lift-curve slope for rigid wings is given directly in reference 4 for a wide range of plan forms.

2. Constant angle-of-attack analysis.— The aeroelastic span load distribution resulting from a constant angle-of-attack analysis is similar to an additional-type loading and yields a lift when integrated. For a swept-back wing, the change in lift resulting from integration of the aeroelastic loading associated with the twist of equation (19) can be written as

$$\Delta C_L = \frac{q}{1+kq} \Delta C_{L_1} \quad (26)$$

where

ΔC_L lift coefficient resulting from integration of the aeroelastic loading corresponding to $\epsilon(\eta)$

ΔC_{L_1} lift coefficient resulting from integration of the aeroelastic loading corresponding to $f_0(\eta)$

The lift coefficient for the flexible wing (swept-back) therefore is

$$C_L = C_{L_0} - \frac{q}{1+kq} \Delta C_{L_1} \quad (27)$$

where

C_{L_0} lift coefficient of the rigid wing

If equation (27) is divided by the arbitrary angle of attack, the lift-curve slope for the flexible wing can be written as

$$(C_{L_\alpha})_F = (C_{L_\alpha})_R \left(1 - \frac{q}{1+kq} \frac{\Delta C_{L_1}}{C_{L_0}} \right) \quad (28)$$

where the subscripts F and R refer to the flexible and rigid wing, respectively. In the case of a swept-forward wing, equation (28) becomes

$$(C_{L_\alpha})_F = (C_{L_\alpha})_R \left(1 + \frac{q}{1-kq} \frac{\Delta C_{L_1}}{C_{L_0}} \right) \quad (29)$$

Aerodynamic center.— The accepted definition of aerodynamic center of a rigid wing is the centroid of all the additional loads. It is evident that on a flexible wing the lift increment due to angle of attack includes not only an additional-type load (in the rigid-wing sense) but also a varying amount of aeroelastic lift. The effective aerodynamic center of a flexible wing will thus differ from that of the rigid wing but will still be the centroid of all the additional loads. In stability analyses, it usually is customary to neglect the vertical location of the centroid since the effect of drag on stability normally is negligible.

The varying amount of aeroelastic lift is made up of (1) the component associated with the additional loading and (2) the component associated with the inertia (or dead weight) loading, since only the components associated with these loadings are proportional to C_L . These components, $c_{l_{e_a}}(\eta)$ and $c_{l_{e_{AZ}}}(\eta)$, respectively, are defined by the twist distributions given by equations (11) and (14) previously presented. With $c_{l_{e_a}}(\eta)$ and $c_{l_{e_{AZ}}}(\eta)$ determined, the aerodynamic center of the flexible wing can be found by any method for determining centroids, remembering that the chordwise load is assumed to lie along the quarter-chord line of the wing. The same method is applicable, in general, whether the analysis adopted is for constant lift or constant angle of attack.

Divergence Speed for Flexible Wing

The ease with which divergence speed can be obtained from equations (19) and (20) is worthy of brief mention also. If equation (19) is differentiated with respect to q , the derivative becomes

$$\frac{d}{dq} \epsilon(\eta) = \frac{1}{(1+kq)^2} f_0(\eta) \quad (30)$$

The condition for divergence is that the derivative $(d/dq) \epsilon(\eta)$ must equal infinity. To satisfy this condition,

$$1 + kq_D = 0 \quad (31)$$

where q_D is the divergence dynamic pressure, so that

$$q_D = -\frac{1}{k} \quad (32)$$

In the case of a swept-forward wing, differentiating equation (20) and proceeding as before yields

$$q_D = \frac{1}{k} \quad (33)$$

Equations (32) and (33) show the familiar fact that a swept-forward wing will diverge at some positive value of q while a swept-back wing will not diverge at any positive value of q .

APPLICATION

Computing Forms

Computing forms to aid in solving for the change in span load distribution due to wing flexibility are presented in table I. The basic data needed to perform the calculations are shown in table I(a). Tables I(b), I(c), I(d), and I(e) are for the purpose of computing the functions ($f_0(\eta)$ and $f_1(\eta)$) for each of the rigid-wing loadings, and require essentially the same operations. Any differences noted are merely for ease in handling the computations for a given loading. Table I(f) is essentially the same as table I(c) which is for basic-type loadings. The only distinction between the two forms is that table I(f) is for the aeroelastic loading introduced by wing deflection and table I(c) is for the basic loading due to built-in twist. With one exception these forms consist of separate calculations of bending deflection (columns 4 through 7) and of

torsional deflection (columns 9 through 11). The single exception is table I(e) for camber loading (c'_{m_0}) which does not require bending computations for obvious reasons. The last column (column 12) in each case is the sum of the bending and torsional deflections in terms of streamwise angle-of-attack change. This column yields $f_0(\eta)$ in the case of tables I(b), I(c), I(d), and I(e) and yields $f_1(\eta)$ in the case of table I(f). The column headings are either self-explanatory or are explained in the computing instructions following the tables. In the computing instructions operation A integrates the running load normal to the wing to obtain the shear at designated spanwise stations. Operation B integrates the shear curve so obtained to determine the bending moment at the same spanwise stations. Operation D integrates the running torsional load to obtain the torsional moment at the same spanwise stations. The summations are performed as indicated from $\eta = 1.0$ to $\eta = 0$. Operation C integrates the M/EI curve to obtain the slope of the elastic axis at the chosen spanwise stations. Operation E integrates the T/GJ curve to obtain the twist about the elastic axis at the same spanwise stations. The summations in these two operations are performed as indicated from $\eta = 0$ to $\eta = 1.0$. The integrating operations have been set up in accordance with the trapezoidal rule for approximate integration. The spanwise stations used in the computations, therefore, should be of sufficient number and of adequate spacing so that the integrations will not be subject to significant error.

Numerical Example

The solution procedure indicated in the preceding section of this report has been applied to a relatively flexible example wing of moderate sweep and high aspect ratio. Compressibility considerations were neglected in the present example, since the modifying influence of compressibility is small compared to the isolated, primary influence of dynamic pressure. The geometry of the example wing is shown in figure 2 together with curves of the structural-stiffness data used in the calculations. The wing has an aspect ratio of 9.43, a taper ratio of 0.42, and a sweep angle of the quarter-chord line of 35° . As indicated in the figure, the elastic axis is located at 38-percent chord.

The rigid-wing loading curves used in the calculations are shown in figure 3. The aerodynamic loadings (additional and basic) were obtained from reference 4, neglecting compressibility.⁹ The additional-type

⁹ For the reader interested in including compressibility, it should be noted that the method of reference 4 accounts for compressibility effects on the basis of linearized compressible flow theory so that the modifying influence of compressibility can easily be included using that reference by merely following the procedure outlined therein.

loading corresponds to an over-all wing lift coefficient of 1.0 and the basic loading corresponds to a linear twist distribution having 1.0° washout at the wing tip. The dead-weight shear distribution was obtained from weight estimates for the wing. The abrupt shear changes shown are due to the concentrated masses of the engines. The camber loading was obtained assuming constant camber across the span equivalent to $c_{m0}^i = -0.01$.

Loading.— Computations for the example wing assuming only the additional loading to exist and based on a constant lift analysis are presented in table II to illustrate use of the computing forms. Table II(a) presents the geometric and structural parameters for the example wing for specified stations along the semispan. Table II(b) presents the calculations for the angle-of-attack redistribution from which the function $f_0(\eta)$ is found. The function $f_1(\eta)$ is found from the angle-of-attack redistribution calculated in table II(c). In table II(b), the loading used is the additional loading. In table II(c), the loading used is the basic loading found from the twist distribution calculated in table II(b). The functions $f_0(\eta)$ and $f_1(\eta)$ and the ratio $f_1(\eta)/f_0(\eta)$ are plotted in figure 4 against spanwise station η . The ratio $f_1(\eta)/f_0(\eta)$ is plotted for the purpose of illustrating the differences in curve shape between the functions $f_0(\eta)$ and $f_1(\eta)$. As can be seen from the figure, the distributions of twist (as defined by the shape of the curves) for $f_0(\eta)$ and $f_1(\eta)$ are somewhat different due to the fact that $f_0(\eta)$ was determined from an additional loading and $f_1(\eta)$ was determined from a basic loading. In spite of the difference shown, however, the assumption of proportionality between successive terms of the series is sufficiently close to provide a good approximation since basic-type loading is affected very little by differences in curve shape such as shown in the figure. As can be seen from the figure, a large variation in $f_1(\eta)/f_0(\eta)$ across the semispan can exist so that it is important to choose the value of this ratio at the proper value of η . As stated earlier, the best approximation to the series-type solution was obtained for the example wing by choosing the value of $f_1(\eta)/f_0(\eta)$ at the tip station. These remarks also apply if a constant angle-of-attack analysis is adopted.

The aeroelastic loadings associated with each of the rigid-wing loadings are presented in figure 5 for several values of dynamic pressure as obtained from the constant-lift analysis. With the solution in the form shown in the figure, the computation of the spanwise load distribution for the flexible wing can be found relatively simple for any set of flight conditions and any set of camber and twist distribution similar to that assumed merely by combining the loading for the rigid wing with the proper combination of basic loadings due to deflection as indicated by equation (25). As has already been pointed out, such a computing shortcut is made possible by the linear aerodynamic and structural theory of the analysis which renders the deflection loadings (at a given dynamic pressure) proportional to either C_L , A_z ,

e_{bt} , or c_{m_0} , depending on the rigid-wing loading involved. The aeroelastic loadings for a constant angle-of-attack analysis are not presented since the proper combination of aeroelastic loadings is believed to be indicated sufficiently by figure 5.

Stability parameters.— Since no experimental data were available with which theoretical span load distributions of a flexible wing could be compared, the validity of the method was checked to some extent by comparing predictions of lift-curve-slope change and aerodynamic-center shift with those predicted by the method of reference 1.

The variation in lift-curve slope with dynamic pressure for the example wing, as calculated by the procedures outlined earlier in the report, is presented in figure 6, neglecting the modifying influence of compressibility. In the calculations, a rigid-wing lift-curve slope of 0.071 obtained from reference 4 was used. In the figure, a curve showing the slope variation according to the method of reference 1 also is presented for comparison. As can be seen, agreement between the two methods is very good.

The spanwise shift in the centroid of the additional loads with dynamic pressure for one panel of the example wing is presented in figure 7 together with the corresponding shift in aerodynamic center parallel to the plane of symmetry. At a dynamic pressure of 500 pounds per square foot, the spanwise shift is shown to be inboard by about 6 percent of the semispan. The corresponding chordwise shift is shown to be forward by about 20 percent of the mean aerodynamic chord. Good agreement with the prediction of reference 1 is shown again.

Ames Aeronautical Laboratory,
 National Advisory Committee for Aeronautics,
 Moffett Field, Calif., July 31, 1950.

APPENDIX

DERIVATION OF WING TWIST POWER SERIES

In the text of this report, the streamwise twist of a flexible, swept wing is given by equation (10) as a summation of terms due to the various rigid-wing loadings and the aeroelastic loading introduced by flexibility. Equation (10) can be summarized as follows:

$$\epsilon(\eta) = \epsilon_0(\eta) + \Delta\epsilon(\eta) \tag{A1}$$

where

$\epsilon_0(\eta)$ the twist of the flexible wing due to the total rigid-wing loading (as given by terms [1] through [7] of equation (10))

and

$\Delta\epsilon(\eta)$ the twist of the flexible wing due to the aeroelastic loading (as given by terms [8] and [9] of equation (10))

As stated in the text, the value of $\Delta\epsilon(\eta)$ in the above equation cannot be evaluated directly in any explicit manner so that a method of successive approximations must be employed.

One method for evaluating $\epsilon(\eta)$ is to adopt the obvious iterative approach and compute $\epsilon(\eta)$ by successive approximations to $\Delta\epsilon(\eta)$ until sufficient accuracy is obtained. A more convenient method, however, is to apply a relaxation procedure to the determination of $\Delta\epsilon(\eta)$. In this method, the wing is assumed to be fixed in position as the rigid-wing loading is applied, and then the wing is allowed to deflect under the applied load, resulting in the streamwise twist distribution $\epsilon_0(\eta)$ of equation (A1). The wing then is fixed in position again and the rigid-wing loading is removed. The aerodynamic loading corresponding to $\epsilon_0(\eta)$ then is applied to the wing and again the wing is allowed to deflect (in accordance with the applied load only), resulting in a new twist distribution. In this way successive twist distributions can be found which are dependent upon the aerodynamic loading corresponding to the previous twist distribution. The final twist distribution for the flexible wing can therefore be expressed as

$$\epsilon(\eta) = \epsilon_0(\eta) + \Delta\epsilon_1(\eta) + \Delta\epsilon_2(\eta) \dots + \Delta\epsilon_{n-1}(\eta) \tag{A2}$$

Comparison of equation (A2) with equation (A1) shows that

$$\Delta\epsilon(\eta) = \Delta\epsilon_1(\eta) + \Delta\epsilon_2(\eta) \dots + \Delta\epsilon_n(\eta) \tag{A3}$$

Now since⁹

$$\Delta \epsilon_1(\eta) = q F \left[c_{l_{e_1}}(\eta) \right] \dots$$

and

$$c_{l_{e_1}}(\eta) = f \left[\epsilon_0(\eta) \right]$$

where

$$\epsilon_0(\eta) = q F \left[c_l(\eta) \right]$$

or

$$\epsilon_0(\eta) = q f_0(\eta)$$

it is apparent that equation (A4) can be written as

$$\Delta \epsilon_1(\eta) = q^2 f_1(\eta) \tag{A5}$$

Similarly,

$$\Delta \epsilon_2(\eta) = q F \left[c_{l_{e_2}}(\eta) \right] \tag{A6}$$

where

$$c_{l_{e_2}}(\eta) = f \left[\Delta \epsilon_1(\eta) \right]$$

so that, with equation (A5), it is apparent that

$$\Delta \epsilon_2(\eta) = q^3 f_2(\eta) \tag{A7}$$

In like manner

$$\Delta \epsilon_n(\eta) = q^{n+1} f_n(\eta) \tag{A8}$$

⁹In these expressions, the notations $f \left[\quad \right]$ and $F \left[\quad \right]$ merely indicate the general dependence of loading and twist on the associated twist and loading, respectively. The notation $f_n \left[\quad \right]$ indicates a specific function.

It should be noted that for a swept-back wing each new twist distribution calculation by this procedure will be of opposite sign to the twist immediately preceding, since successive aerodynamic loadings will exert bending moments of opposite sense due to the bending-twist relationship for a swept-back wing. Summing the successive contributions to $\Delta\epsilon(\eta)$ of equation (A1) as given by equations (A5), (A7), and (A8), we have

$$\Delta\epsilon(\eta) = q^2 f_1(\eta) + q^3 f_2(\eta) + \dots + q^{n+1} f_n(\eta) \quad (A9)$$

Substituting in equation (A1) for $\epsilon_0(\eta)$ by the relation given under equation (A4) and for $\Delta\epsilon(\eta)$ as given by equation (A9), it can be seen that the twist distribution for the flexible wing can be expressed as a power series in q as follows:

$$\epsilon(\eta) = q f_0(\eta) + q^2 f_1(\eta) + q^3 f_2(\eta) + \dots + q^n f_{n-1}(\eta) \quad (A10)$$

REFERENCES

1. Diederich, Franklin W.: The Calculation of the Aerodynamic Loading of Flexible Wings of Arbitrary Plan Form and Stiffness. NACA TN 1876, 1949.
2. Pai, S. I., and Sears, W. R.: Some Aeroelastic Properties of Swept Wings. Jour. Aero. Sci., vol. 16, no. 2, Feb. 1949, pp. 105 - 116.
3. Miles, John W.: A Formulation of the Aeroelastic Problem for a Swept Wing. Jour. Aero. Sci., vol. 16, no. 8, Aug. 1949, pp. 477 - 490.
4. DeYoung, John, and Harper, Charles W.: Theoretical Symmetric Span Loading at Subsonic Speeds for Wings Having Arbitrary Plan Form. NACA Rep. 921, 1948.
5. Southwell, R. V.: Relaxation Methods in Engineering Science. University Press, Oxford, 1940.
6. Jacobs, Eastman N., and Rhode, R. V.: Airfoil Section Characteristics as Applied to the Prediction of Air Forces and Their Distribution on Wings. NACA Rep. 631, 1938.
7. Anon.: Flight Loading Conditions, ANC-1. Dept. of Commerce, Civil Aero. Adm., Dec. 7, 1942.

TABLE I.- SUGGESTED COMPUTING FORMS FOR CALCULATION OF THE FUNCTIONS $f_0(\eta)$ and $f_1(\eta)$ DUE TO WING FLEXIBILITY

(a) Wing parameters

1	2	3	4	5	6	7	8	9	10
η	EI (lb-in. ²)	$\frac{K_1}{EI}$ = $\frac{K_1}{\textcircled{2}}$	GJ (lb-in. ²)	$\frac{K_2}{GJ}$ = $\frac{k_2}{\textcircled{4}}$	c (in.)	$\frac{c \cos^2 \Lambda_{ea}}{c_{av}}$ $\textcircled{6} \times \frac{\cos^2 \Lambda_{ea}}{c_{av}}$	$\textcircled{7}^2$	$\frac{a}{c_{av}}$	ϵ_0



$\Lambda_{ea} = \underline{\hspace{2cm}}$ $\cos \Lambda_{ea} = \underline{\hspace{2cm}}$ $\sin \Lambda_{ea} = \underline{\hspace{2cm}}$
 $s = \underline{\hspace{2cm}}$ in. $K_1 = c_{av} s^3 \sin \Lambda_{ea} = \underline{\hspace{2cm}}$
 $c_{av} = \underline{\hspace{2cm}}$ in. $K_2 = c_{av}^2 s^2 \cos \Lambda_{ea} = \underline{\hspace{2cm}}$

TABLE I.- CONTINUED

(b) Additional loading

1	2	3	4	5	6	7	8	9	10	11	12
η	$\frac{\Delta\eta/2=}{2} \frac{\textcircled{1}_{n+1} - \textcircled{1}_n}{2}$	$c_{z_a} \frac{c \cos \Lambda_{ea}}{c_{av}}$	A	B	$\textcircled{5} \times \textcircled{\Delta}$	C ($v \sin \Lambda_{ea}$)	$\textcircled{3} \times \textcircled{\Delta}$	D	$\textcircled{9} \times \textcircled{\Delta}$	E ($\phi \cos \Lambda_{ea}$)	$\epsilon_0 = \textcircled{7} + \textcircled{11}$

$C_L = 1.0$ $q = 1.0$ psi

(c) Basic loading

1	2	3	4	5	6	7	8	9	10	11	12
η	$\frac{\textcircled{1}_{n+1} - \textcircled{1}_n}{2}$	$c_{z_b} \frac{c \cos \Lambda_{ea}}{c_{av}}$	A	B	$\textcircled{5} \times \textcircled{\Delta}$	C ($v \sin \Lambda_{ea}$)	$\textcircled{3} \times \textcircled{\Delta}$	D	$\textcircled{9} \times \textcircled{\Delta}$	E ($\phi \cos \Lambda_{ea}$)	$\epsilon_0 = \textcircled{7} + \textcircled{11}$

$C_L = 0$

$q = 1.0$ psi

$\epsilon_{bt} = \frac{0}{\quad} = \quad$ rad.

Note: Δ refers to indicated column in table I(a).



TABLE I.-- CONTINUED
 (d) Dead weight loading

1	2	3	4	5	6	7	8	9	10	11	12
η	$\frac{\Delta\eta/2}{2}$ $\frac{\textcircled{1}_{n+1} - \textcircled{1}_n}{2}$	Shear (lb)	$\frac{\textcircled{3}}{K_s}$	B	$\textcircled{5} \times \textcircled{\Delta 3}$	c ($v \sin \Lambda_{\theta a}$)	Torsion (in.-lb)	$\frac{\textcircled{8}}{K_4}$	$\textcircled{9} \times \textcircled{\Delta 5}$	E ($\varphi \cos \Lambda_{\theta a}$)	$\textcircled{7} + \textcircled{11}$ ϵ_o

$A_z = 1.0g$

$q = 1.0 \text{ psi}$

$K_s = c_{av} s = \underline{\hspace{2cm}}$

$K_4 = K_s c_{av} = \underline{\hspace{2cm}}$

(e) Camber loading

1	2	3	4	5	6	7	8	9	10	11
η	$\frac{\Delta\eta/2}{2}$ $\frac{\textcircled{1}_{n+1} - \textcircled{1}_n}{2}$	—	—	—	—	d_{m0}	$\textcircled{7} \times \textcircled{\Delta 8}$	D	$\textcircled{9} \times \textcircled{\Delta 5}$	E ($\varphi \cos \Lambda_{\theta a}$)

$q = 1.0 \text{ psi}$



TABLE I.- CONTINUED

(f) Aeroelastic loading

1	2	3	4	5	6	7	8	9	10	11	12
η	$\frac{\Delta\eta/2}{\frac{(1)_{n+1} - (1)_n}{2}}$	$c_{te_n} \frac{c \cos \Lambda_{ea}}{c_{av}}$	A	B	(5) x (3)	C (v sin Λ_{ea})	(3) x (9)	D	(9) x (5)	E ($\phi \cos \Lambda_{ea}$)	$\Delta\epsilon_n$ (7) + (11)

q = 1.0 psi



TABLE I.- CONCLUDED

(g) Computing Instructions.

A (col. 4)

$$\textcircled{4} = \sum_{\eta = 1.0}^{\eta} \left(\textcircled{3}_{n+1} \times \textcircled{2}_{n+1} + \textcircled{3}_n \times \textcircled{2}_n \right)$$

B (col. 5)

$$\textcircled{5} = \sum_{\eta = 1.0}^{\eta} \left(\textcircled{4}_{n+1} \times \textcircled{2}_{n+1} + \textcircled{4}_n \times \textcircled{2}_n \right)$$

C (col. 7)

$$\textcircled{7} = - \sum_{\eta = 0}^{\eta} \left(\textcircled{6}_{n-1} \times \textcircled{2}_{n-1} + \textcircled{6}_n \times \textcircled{2}_n \right)$$

D (col. 9)

$$\textcircled{9} = + \sum_{\eta = 1.0}^{\eta} \left(\textcircled{8}_{n+1} \times \textcircled{2}_{n+1} + \textcircled{8}_n \times \textcircled{2}_n \right)$$

E (col. 11)

$$\textcircled{11} = \sum_{\eta = 0}^{\eta} \left(\textcircled{10}_{n-1} \times \textcircled{2}_{n-1} + \textcircled{10}_n \times \textcircled{2}_n \right)$$



TABLE II.- SAMPLE COMPUTATION FOR EXAMPLE WING BASED ON ADDITIONAL-TYPE LOADING

(a) Geometric and structural parameters.

1	2	3	4	5	6	7	8	9	10
η	$\frac{EI}{(lb-in.^2)}$ $= \frac{5.043 \times 10^{10}}{(2)}$	$\frac{K_1}{EI}$ $= \frac{5.043 \times 10^{10}}{(2)}$	$\frac{GJ}{(lb-in.^2)}$ $= \frac{1.264 \times 10^{10}}{(4)}$	c	$\frac{c \cos^2 \Lambda_{ea}}{c_{av.}}$ $= \frac{(6) \times 0.00454}{(7)^2}$	$\frac{s}{c_{av.}}$	ϵ_b (rad)		
0	9.84×10^{10}	0.513	9.70×10^{10}	0.130	216.7	0.983	0.965	0.1561	0
.1	9.00	.560	7.17	.176	204.0	.925	.855	.1470	.00079
.2	7.50	.672	4.91	.257	191.6	.870	.755	.1380	.00168
.3	5.68	.888	3.35	.377	179.3	.813	.661	.1292	.00270
.4	3.93	1.283	2.20	.575	165.9	.737	.574	.1203	.00387
.5	2.77	1.821	1.58	.800	154.7	.701	.492	.1114	.00522
.6	1.77	2.849	1.20	1.053	142.2	.645	.416	.1024	.00682
.7	1.38	3.654	.90	1.404	129.6	.588	.346	.0933	.00873
.8	.97	5.199	.65	1.945	117.3	.532	.283	.0845	.01103
.9	.74	6.815	.47	2.689	105.1	.477	.227	.0757	.01385
1.0	0.66×10^{10}	7.641	0.28×10^{10}	4.514	92.7	.420	.176	.0667	.01745

$\Lambda_{ea} = 35.0^\circ$

$\cos \Lambda_{ea} = 0.819$

$\sin \Lambda_{ea} = 0.574$

$s = 841 \text{ in.}$

$K_1 = 5.043 \times 10^{10} \text{ in}^4$

$c_{av} = 147.7 \text{ in.}$

$K_2 = 1.264 \times 10^{10} \text{ in}^4$



TABLE II.- CONTINUED

(b) Calculation of the function $f_0(\eta)$.

1	2	3	4	5	6	7	8	9	10	11	12
η	$\frac{\Delta\eta}{2}$ $\frac{\textcircled{1}_{n+1} - \textcircled{1}_n}{2}$	c_{ea} $\frac{c \cos \Lambda_{\text{ea}}}{c_{\text{av}}}$	A	B	$\textcircled{5} \times \textcircled{3}$	C ($v \sin \Lambda_{\text{ea}}$)	$\textcircled{3} \times \textcircled{9}$	D	$\textcircled{9} \times \textcircled{5}$	E ($\varphi \cos \Lambda_{\text{ea}}$)	ϵ_0 $\textcircled{7} + \textcircled{11}$
0	0.05	0.897	0.808	0.363	0.1862	0	0.140	0.0942	0.0122	0	0
.1	.05	.906	.718	.287	.1607	-.0174	.133	.0805	.0142	.0013	-.0161
.2	.05	.922	.627	.220	.1478	-.0328	.127	.0675	.0173	.0029	-.0299
.3	.05	.934	.534	.162	.1439	-.0474	.121	.0551	.0208	.0048	-.0426
.4	.05	.932	.441	.113	.1450	-.0618	.112	.0434	.0250	.0071	-.0547
.5	.05	.914	.349	.0734	.1337	-.0757	.102	.0327	.0262	.0097	-.0660
.6	.05	.881	.259	.0430	.1225	-.0886	.090	.0231	.0243	.0122	-.0764
.7	.05	.823	.174	.0213	.0778	-.0986	.077	.0147	.0206	.0144	-.0842
.8	.05	.737	.096	.0078	.0406	-.1045	.062	.0077	.0150	.0162	-.0883
.9	.05	.591	.030	.0015	.0102	-.1070	.045	.0023	.0062	.0173	-.0897
1.0	.05	0	0	0	0	-.1075	0	0	0	.0176	-.0900

$C_L = 1.0$ $q = 1.0$ psi



TABLE II.- CONCLUDED

(c) Calculation of the function $f_1(\eta)$.

1	2	3	4	5	6	7	8	9	10	11	12
η	$\frac{\Delta\eta/2}{\frac{(1)_{n+1} - (1)_n}{2}}$	$c_{Le_1} \frac{c \cos \Lambda_{ea}}{c_{av}}$	A	B	(5) x (3)	C (v sin Λ_{ea})	(3) x (9)	D	(9) x (5)	E ($\varphi \cos \Lambda_{ea}$)	(7) + (11)
0	0.05	0.124	0.0025	-0.01696	-0.00870	0	0.0194	0.00192	0.00025	0	0
.1	.05	.116	-.0095	-.01661	-.00930	.00090	.0171	.0009	.00002	.00001	.00091
.2	.05	.092	-.0199	-.01017	.01017	.00187	.0127	-.00140	-.00036	-.00001	.00186
.3	.05	.052	-.0271	-.01279	-.01136	.00295	.0067	-.00237	-.00089	-.00007	.00288
.4	.05	.007	-.0300	-.00994	-.01275	.00416	.0008	-.00274	-.00158	-.00019	.00397
.5	.05	-.032	-.0288	-.0700	-.01275	.00544	.0036	-.00260	-.00208	-.00037	.00507
.6	.05	-.061	-.0242	-.0435	-.01239	.00670	-.0062	-.00211	-.00222	-.00059	.00611
.7	.05	-.071	-.0176	-.0226	-.00826	.00773	-.0066	-.00147	-.00206	-.00080	.00693
.8	.05	-.073	-.0104	-.00086	-.00447	.00837	-.0062	-.00083	-.00161	-.00098	.00739
.9	.05	-.067	-.0034	-.00017	-.00116	.00865	-.0051	-.00026	-.00070	-.00110	.00755
1.0	.05	0	0	0	0	.00871	0	0	0	-.00114	.00757

q = 1.0 psi



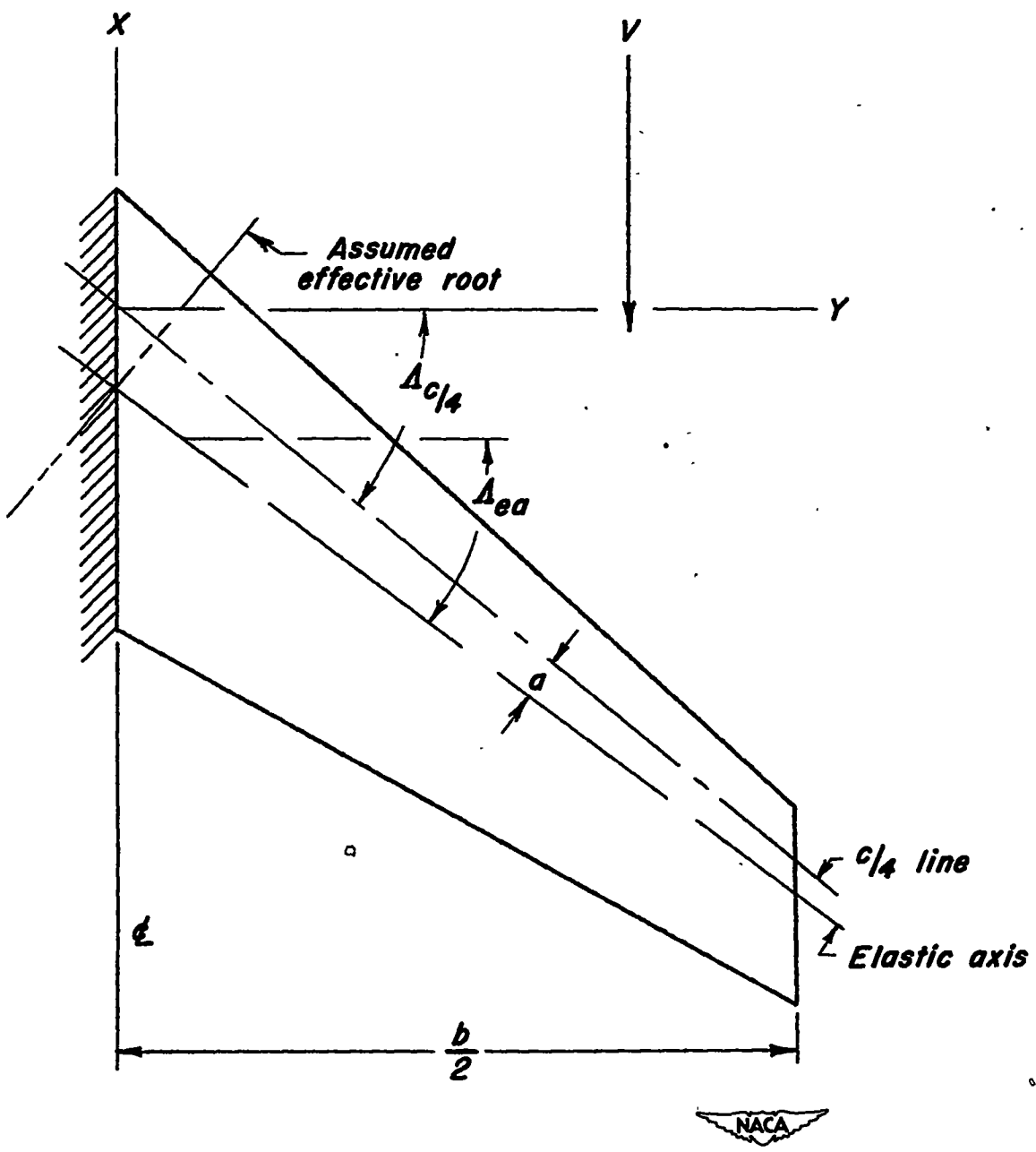

Figure 1.- Sketch of swept-back wing showing axes used in analysis.

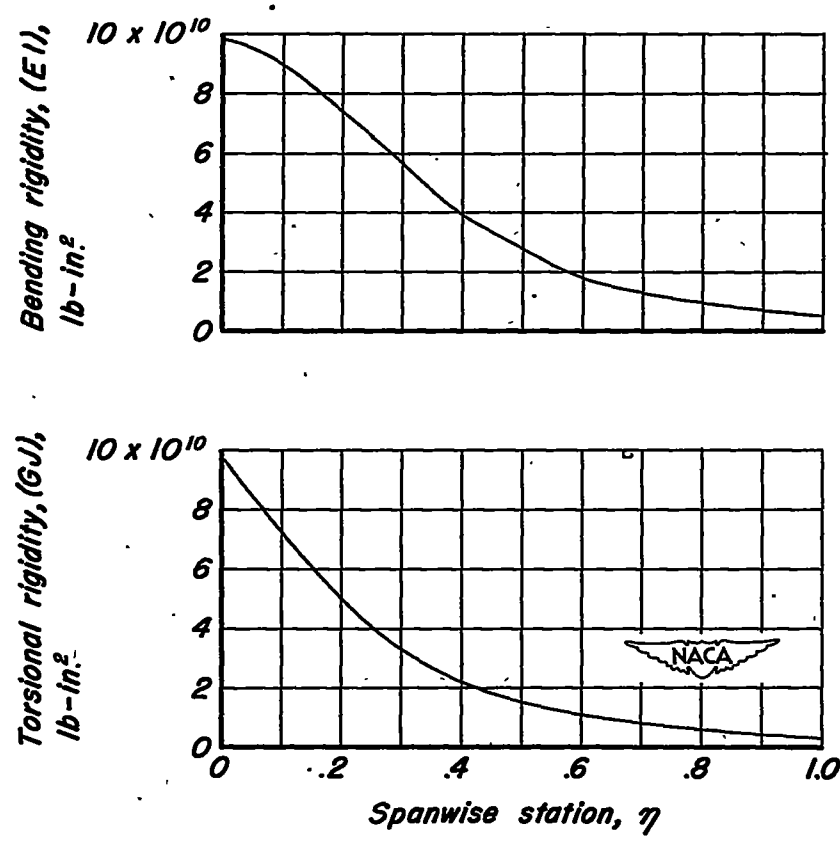
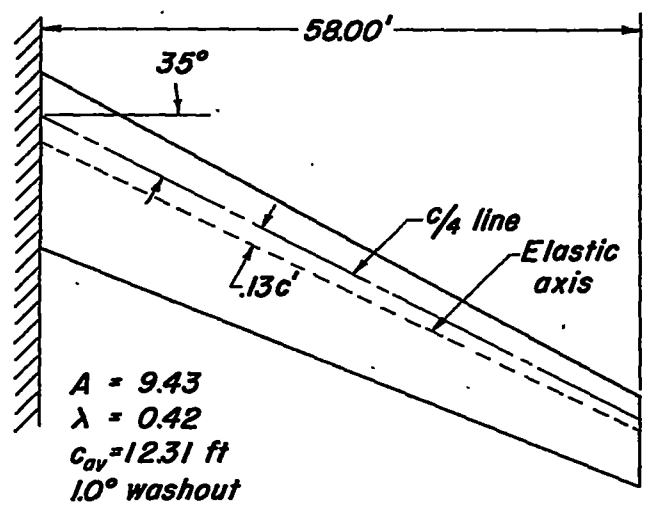

Figure 2.— Sketch of example wing with pertinent dimensions, plan-form parameters, and elastic properties.

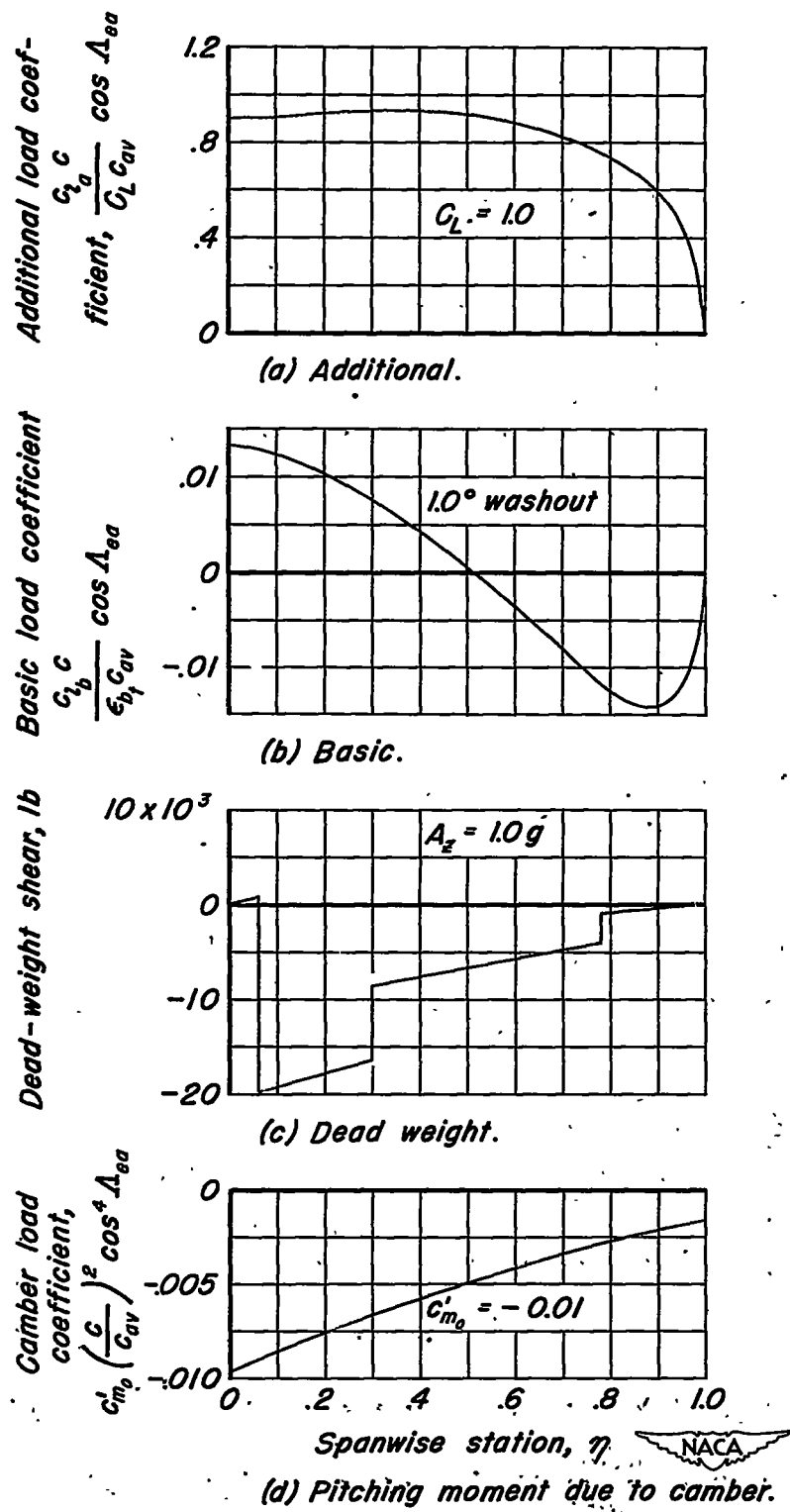

Figure 3.- Rigid-wing loadings for the example wing.

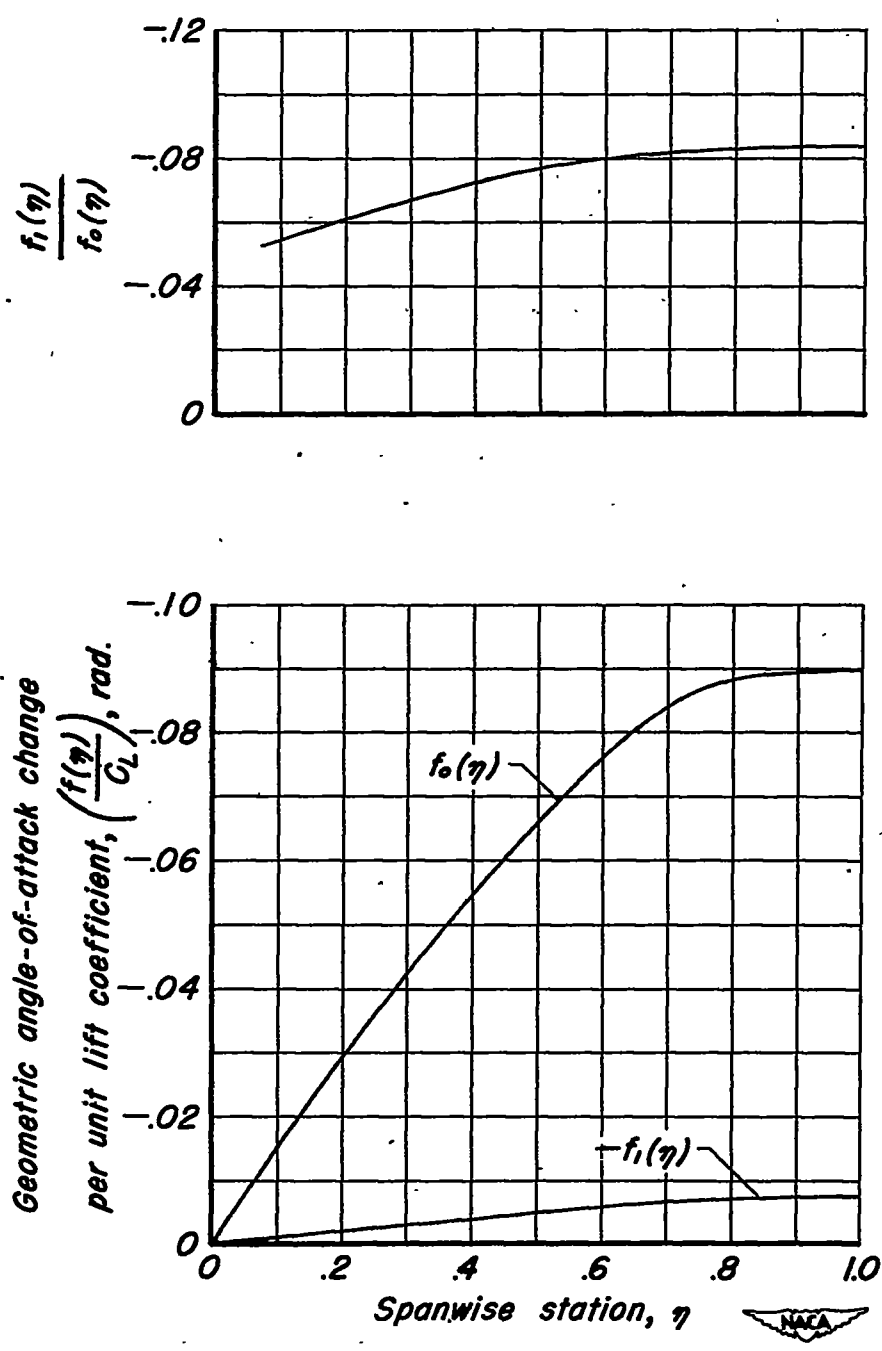
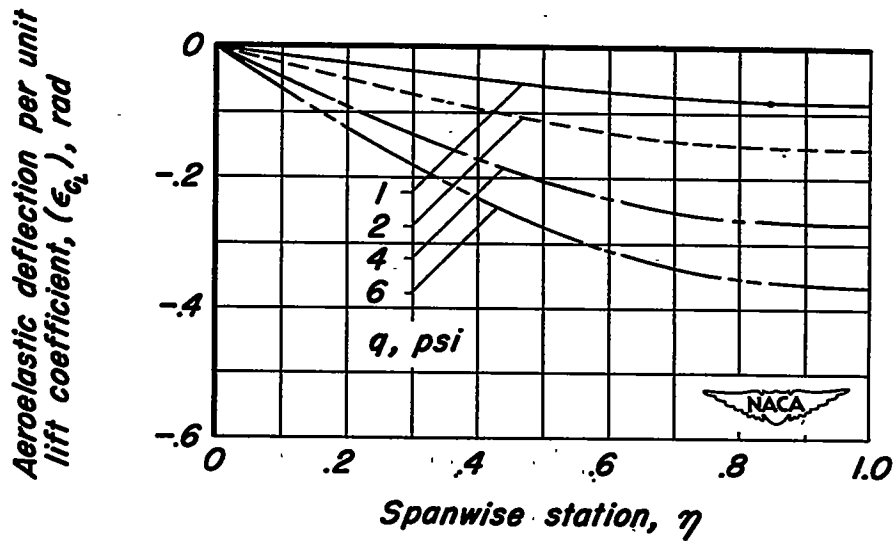
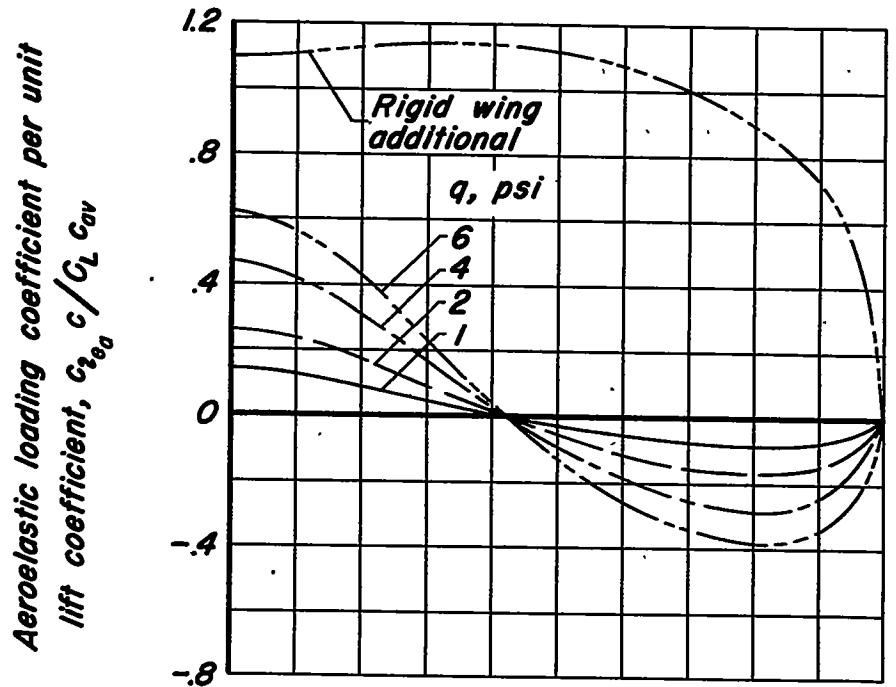
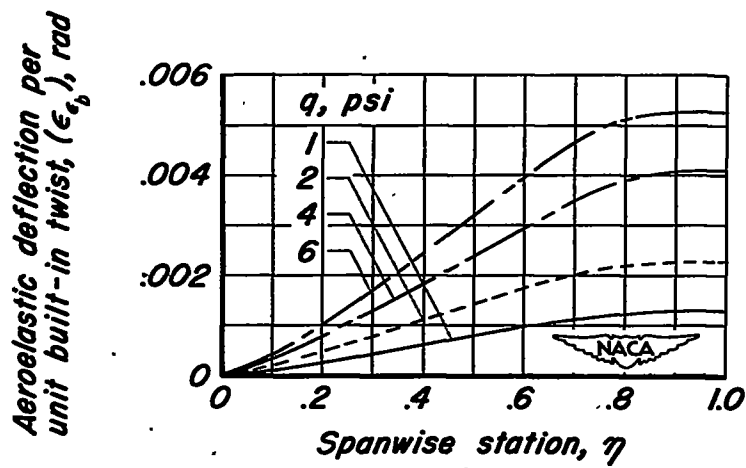
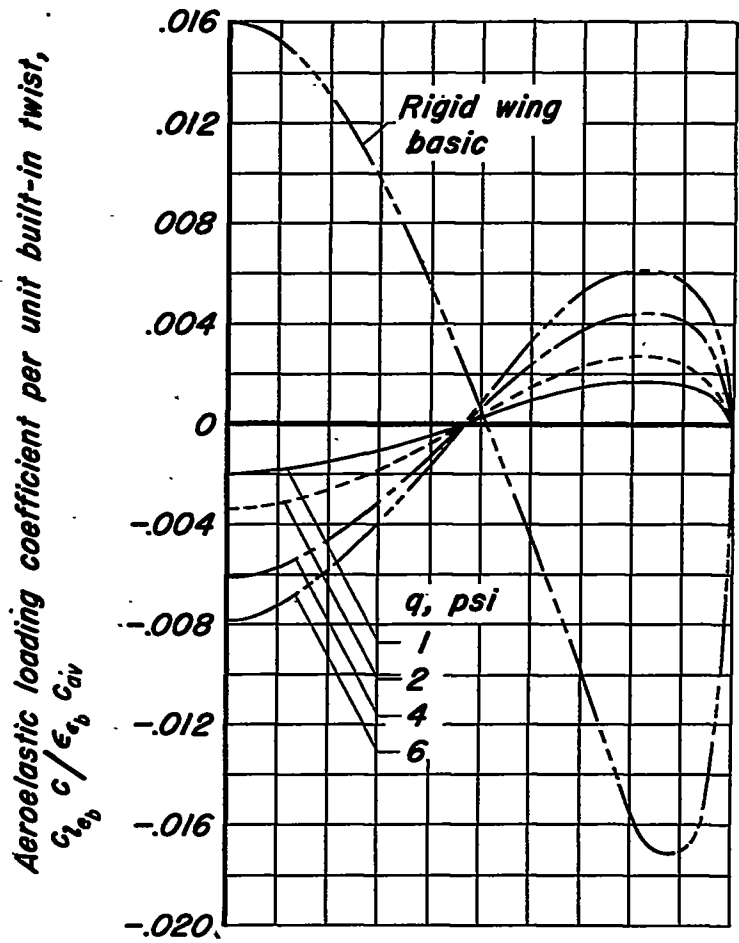

Figure 4.- The twist distributions $f_0(\eta)$ and $f_1(\eta)$ and the ratio $\frac{f_1(\eta)}{f_0(\eta)}$ for the example wing as calculated for the additional loading.



(a) Additional loading.

Figure 5.- Aeroelastic loadings and deflections associated with the various rigid-wing loadings for the example wing as calculated for several values of dynamic pressure using a constant-lift analysis.



(b) Basic loading.

Figure 5.- Continued.

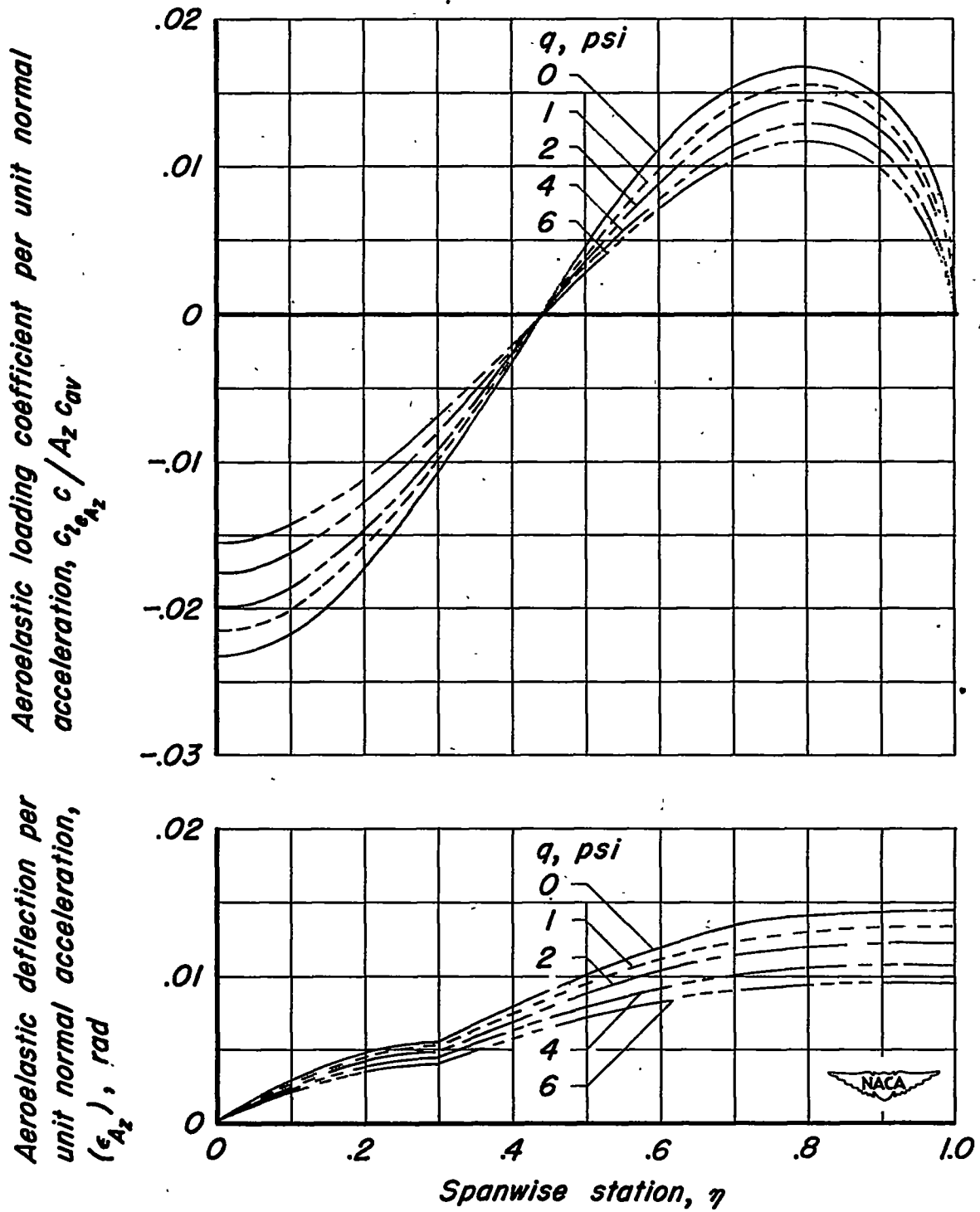

(c) Dead-weight shear.

Figure 5.—Continued.

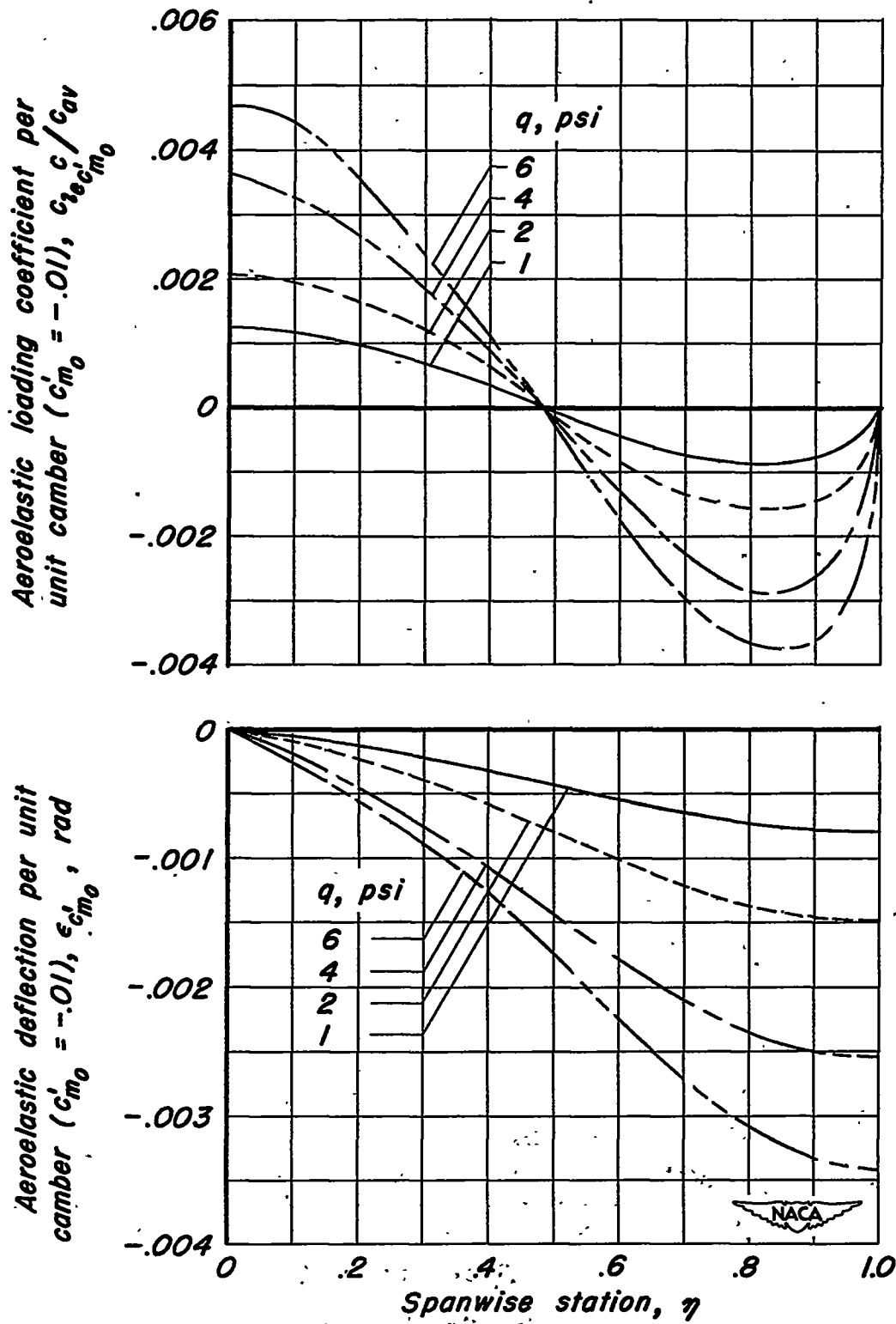

(d) Torsional loading due to camber.

Figure 5.- Concluded.

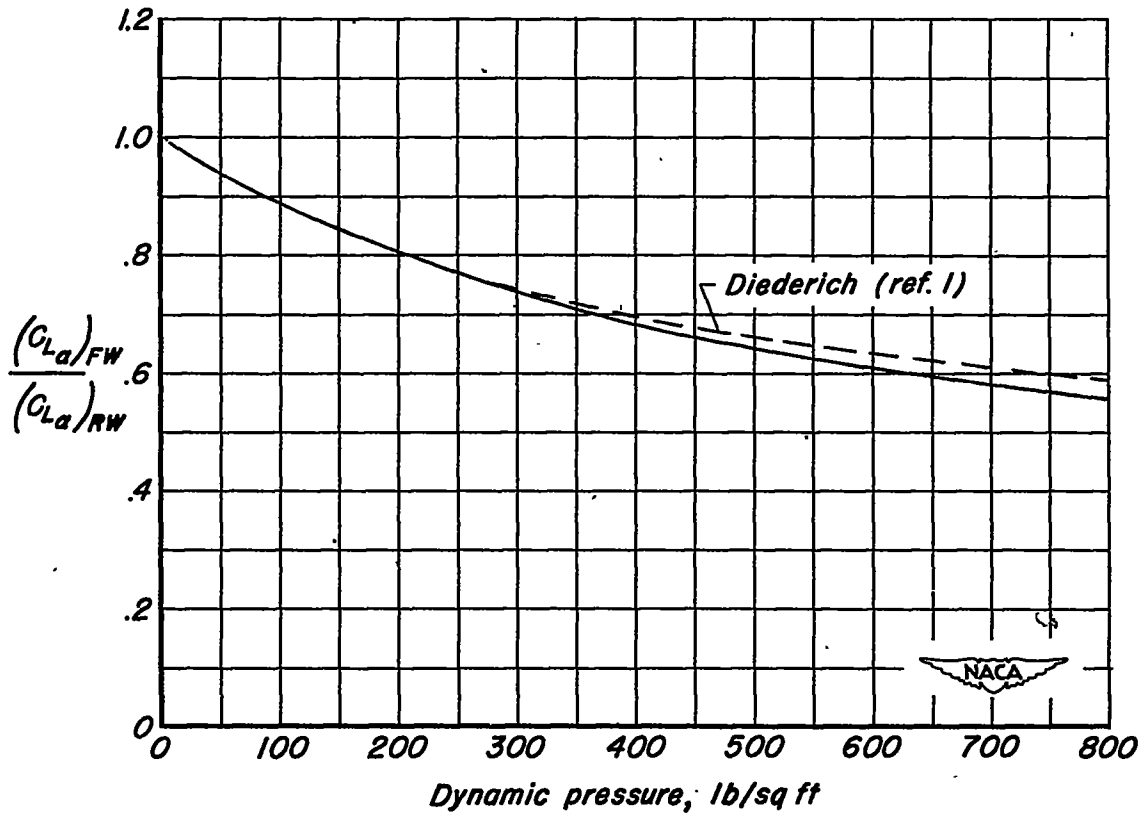
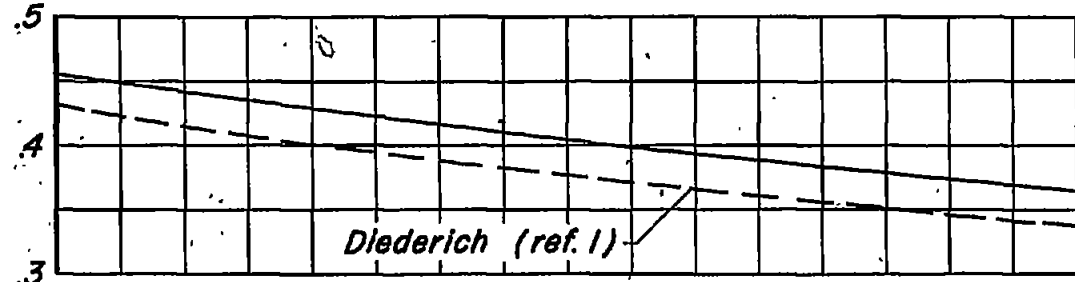

Figure 6.- Variation in lift-curve-slope ratio with dynamic pressure for example wing.

Centroid of span load
 distribution on one
 panel, \bar{y}_{cp}



Aerodynamic-center position, $\frac{x}{c}$

behind
 L.E.

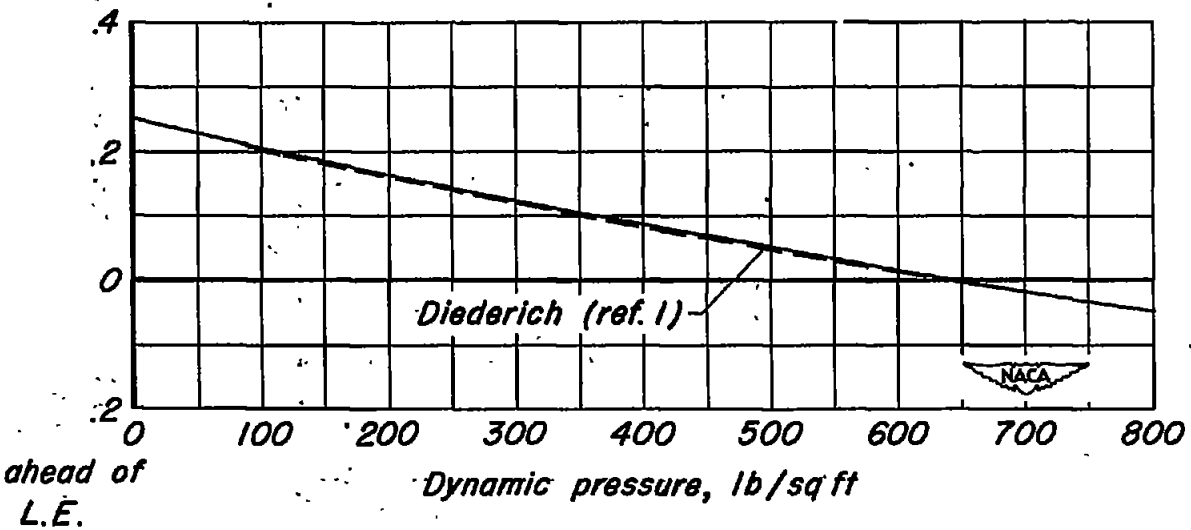

ahead of
 L.E.

Dynamic pressure, lb/sq ft

Figure 7.- Variation in spanwise and chordwise positions of aerodynamic center with dynamic pressure for example wing.