

NOT MEASUREMENT  
SENSITIVE

MIL-HDBK-781A  
1 APR 1996  
SUPERSEDING  
MIL-HDBK-781  
14 JULY 1987  
MIL-STD-781D  
17 OCT 1986

## DEPARTMENT OF DEFENSE

### HANDBOOK FOR RELIABILITY TEST METHODS, PLANS, AND ENVIRONMENTS FOR ENGINEERING, DEVELOPMENT QUALIFICATION, AND PRODUCTION



This handbook is for guidance only.  
Do not cite this document as a requirement.

AMSC N/A

DISTRIBUTION STATEMENT A Approved for public release. Distribution is unlimited

ARLX RELI

## FOREWORD

1. This handbook is approved for use by all Departments and Agencies of the Department of Defense.

2. This handbook is for guidance only. This handbook cannot be cited as a requirement. If it is, the contractor does not have to comply.

3. MIL-HDBK-781 contains test methods, test plans, and environmental profile data presented in a manner which facilitates their use with tailorable tasks when appropriate.

4. The testing of equipment procured for new military systems is an increasingly complex process. Test methods, test plans, and test environments must be selected which will ensure that contractually required reliability levels are attained in the field and early defect failures are removed prior to field deployment. MIL-HDBK-781 provides a menu of test plans, test methods, and environmental profiles. The most appropriate material may be selected for each program and incorporated into the tailored reliability test program.

5. The handbook sections on reliability test methods and test plans present methods for growth monitoring, environmental stress screening, mean-time-between-failure assurance testing, sequential tests, fixed-duration tests, and all-equipment tests, including a durability/economic Life Test. The sections on test environmental profiles provide typical test environments for fixed-ground equipment, mobile ground vehicle, shipboard, jet aircraft, turboprop and helicopter, and missiles and assembled external stores equipment. The references provided will expand the user's knowledge and aid in the design and implementation of reliability test programs through more detailed data.

6. Beneficial comments (recommendations, additions, deletions) and any pertinent data which may be of use in improving this document should be addressed to Commander, Space and Naval Warfare Systems Command, ATTN: SPAWAR 052-2, 2451 Crystal Drive, Arlington, VA 22245-5200, by using the self-addressed Standardization Document Improvement Proposal (DD Form 1426) appearing at the end of this document or by letter.

## CONTENTS

Paragraph		Page
1.	<b>SCOPE</b> .....	1
1.1	Purpose .....	1
1.2	Applicability .....	1
1.2.1	Application of handbook .....	1
1.3	Method of reference .....	1
1.4	Equipment categories .....	1
2.	<b>APPLICABLE DOCUMENTS</b> .....	3
2.1	General .....	3
2.2.1	Specifications, standards, and handbooks .....	3
2.3	Non-Government publications .....	3
2.4	Order of Precedence .....	5
3.	<b>DEFINITIONS</b> .....	6
3.1	Terms .....	6
3.1.1	Corrective maintenance (repair) .....	6
3.1.2	Decision risks .....	6
3.1.2.1	Consumer's risk .....	6
3.1.2.2	Producer's risk .....	6
3.1.2.3	Discrimination ratio .....	6
3.1.3	Multiple failures .....	6
3.1.3.1	Pattern failures .....	6
3.1.3.2	Primary failures .....	6
3.1.4	Measures of reliability .....	6
3.1.4.1	Mean-Time-Between-Failures .....	6
3.1.4.2	Demonstrated MTBF interval ( $\theta_d$ ) .....	6
3.1.4.3	Observed MTBF .....	7
3.1.4.4	Lower test MTBF .....	7
3.1.4.5	Upper test MTBF .....	7
3.1.4.6	Predicted MTBF .....	7
3.1.4.7	Observed cumulative failure rate .....	7
3.1.4.8	Intensity funtion .....	7
3.1.4.9	Instantaneous MTBF function .....	7
3.1.4.10	Observed reliability .....	7
3.1.4.11	Mean-Time-Between-Maintenance .....	7
3.1.5	Mission profile .....	7
3.1.6	Life-cycle profile .....	8
4.	<b>RELIABILITY TEST METHODS AND TEST PLANS</b> .....	9
4.1	Reliability test program .....	9
4.2	Integrated reliability test planning .....	9

## CONTENTS (Continued)

Paragraph		Page
4.3	Environmental test conditions .....	9
4.3.1	Combined environmental test conditions .....	9
4.3.1.1	Electrical stress .....	9
4.3.1.2	Vibration stress .....	9
4.3.1.3	Thermal stress .....	9
4.3.1.4	Moisture .....	10
4.3.1.5	Equipment cycling .....	10
4.4	Test instrumentation and facilities .....	10
4.4.1	Tolerance of test environments .....	10
4.4.2	Calibration of test apparatus .....	10
4.5	Performance baselines .....	10
4.5.1	Pretest performance .....	10
4.5.2	Performance during test .....	10
4.5.3	Post-test performance .....	11
4.6	Failure reporting, analysis and correction action system (FRACAS) .....	11
4.6.1	Problem and failure reporting .....	11
4.6.1.1	Identification and control of failed items .....	11
4.6.1.2	Problem and failure investigations .....	11
4.6.1.3	Failure verification .....	11
4.6.1.4	Corrective action .....	11
4.6.1.5	Problem and failure tracking and closeout .....	12
4.7	Failure categories .....	12
4.7.1	Failure classification .....	12
5.	<b>RECOMMENDED COMBINED ENVIRONMENTAL TEST CONDITIONS .....</b>	<b>13</b>
5.1	Purpose .....	13
5.2	Test planning .....	13
5.2.1	Integrated reliability testing .....	13
5.2.1.1	Reliability growth planning .....	13
5.2.1.2	Reliability test reviews .....	14
5.2.1.2.1	Test readiness reviews .....	14
5.2.1.2.2	Status reviews .....	14
5.2.1.2.3	Test completion review .....	14
5.2.2	Application Matrix .....	16
5.3	Test methods .....	16
5.3.1	Growth monitoring method .....	16
5.3.2	Durability/economic life test .....	16
5.3.2.1	ESS evaluation methods .....	16

## CONTENTS (Continued)

Paragraph		Page
5.3.3	Test plans .....	16
5.3.3.1	MTBF assurance test .....	16
5.3.3.2	Standard test plans .....	17
5.4	Test methods and test plan selection factors .....	17
5.4.1	Test method and test plan selection .....	17
5.4.2	Test method and test plan parameter selection .....	18
5.4.2.1	Equipment performance .....	18
5.4.2.2	Equipment quantity .....	18
5.4.2.3	Test duration .....	18
5.4.2.4	Decision risks .....	19
5.4.2.5	Discrimination ratio .....	19
5.5	Reliability development/growth evaluation methods .....	19
5.5.1	The Duane method .....	20
5.5.1.1	Symbols .....	20
5.5.1.2	Construction of a Duane plot .....	20
5.5.1.3	Example .....	21
5.5.1.4	Problems of plotting average failure rate .....	22
5.5.2	The AMSAA Method .....	23
5.5.2.1	Determination of trend from test data .....	23
5.5.2.2	Reliability growth analysis .....	24
5.5.2.3	illustrative example .....	26
5.6	Durability/economic life test .....	28
5.7	ESS monitoring methods .....	30
5.7.1	Computed ESS time interval method .....	30
5.7.2	Graphical method .....	31
5.7.3	Standard ESS .....	31
5.7.3.1	Thermal stress .....	31
5.7.3.2	Vibration stress .....	32
5.8	MTBF assurance test .....	32
5.8.1	Derivation of equation .....	34
5.8.2	Procedure .....	35
5.9	Sequential test plans .....	35
5.9.1	Symbols .....	37
5.9.2	Applications .....	37
5.9.3	Theoretical background .....	37
5.9.4	Test truncation .....	40
5.9.5	Sequential test example .....	40
5.9.6	Standard PRST accept-reject criteria and OC curves .....	42
5.9.7	Confidence limits for sequential tests .....	42
5.9.7.1	Confidence limits at acceptance .....	43

## CONTENTS (Continued)

Paragraph		Page
5.9.7.1.1	Example: black box X.....	43
5.9.7.2	Confidence limits at rejection.....	44
5.9.7.2.1	Example: black box X.....	45
5.9.8	Sequential tests: Program Manager's assessment.....	45
5.9.8.1	Procedure.....	46
5.10	Fixed-duration tests.....	46
5.10.1	Symbols.....	46
5.10.2	Example problem.....	48
5.10.3	Standard fixed-duration test plans and OC curves.....	48
5.10.4	Alternative fixed-duration test plans.....	48
5.10.4.1	Derivation of alternative plans.....	48
5.10.5	MTBF estimation from observed test data.....	49
5.10.6	Exclusion of hypothesis test values.....	49
5.10.7	Specified confidence interval.....	49
5.10.8	MTBF estimation from fixed-duration test plans.....	49
5.10.8.1	MTBF estimation at failure occurrence.....	49
5.10.8.1.1	Example at failure occurrence.....	50
5.10.8.2	MTBF estimation at acceptance.....	50
5.10.8.2.1	Example at acceptance.....	51
5.10.9	Projection of expected field MTBF.....	52
5.10.10	Fixed-duration tests: Program Manager's assessment.....	52
5.10.10.1	Accept times.....	52
5.10.10.2	Comparison with standard fixed-duration tests.....	51
5.10.10.3	OC curves.....	52
5.11	All-equipment production reliability acceptance test plan.....	52
5.11.1	Test duration.....	53
5.11.2	Evaluation.....	53
5.11.3	Accept-reject criteria for the all-equipment test.....	53
5.11.3.1	Acceptance.....	53
5.11.3.2	Rejection.....	53
5.11.3.3	Reaching the boundary line.....	53
5.11.4	Additional all-equipment production reliability acceptance test plans.....	54
5.12	Reliability estimates from unit-level results.....	54
5.12.1	Calculation method.....	54
5.12.2	Numerical examples.....	57
5.12.3	The case of only one failure in some subsystem(s).....	59
5.12.4	An estimator of the failure rate upper bound.....	62
5.12.5	Departures from AO method requirements.....	63
5.12.6	No observed failures.....	64

CONTENTS (Continued)

Paragraph		Page
5.12.7	Type I censoring .....	64
5.12.8	Computer program .....	65
6.	<b>TEST INSTRUMENTATION AND FACILITIES</b> .....	<b>67</b>
6.1	Purpose .....	67
6.1.1	Scope .....	67
6.2	Thermal and Vibration Survey.....	67
6.3	Mission and life-cycle environmental profiles and test conditions... 68	68
6.3.1	Mission and life cycle environmental profiles.....	68
6.3.2	Environmental test conditions .....	68
6.4	Combined environments for fixed-ground equipment.....	68
6.4.1	Electronic stress and duty cycle.....	68
6.4.2	Thermal stress.....	69
6.4.3	Humidity.....	69
6.5	Combined environments for mobile ground equipment .....	69
6.5.1	Electrical stress and duty cycle.....	69
6.5.2	Vibration stress.....	70
6.5.3	Thermal stress.....	70
6.5.4	Moisture.....	71
6.6	Combined environments for shipboard and underwater vehicle equipments .....	71
6.6.1	Naval surface craft.....	71
6.6.1.1.	Externally mounted equipment.....	71
6.6.1.1.1	Electrical stress and duty cycle.....	71
6.6.1.1.2	Vibration stress.....	71
6.6.1.1.3	Temperature and humidity stress.....	71
6.6.1.2	Internally mounted equipment .....	72
6.6.1.2.1	Electrical stress and duty cycle.....	72
6.6.1.2.2	Vibration stress.....	72
6.6.1.2.3	Temperature and humidity stress.....	72
6.6.1.3	Internally mounted equipment, temperature controlled space.....	73
6.6.1.3.1	Electrical stress and duty cycle.....	73
6.6.1.3.2	Vibration stress.....	73
6.6.1.3.3	Temperature and humidity stress profile.....	73
6.6.2	Naval submarine .....	74
6.6.2.1	Electrical and duty cycle stress.....	74
6.6.2.2	Vibration stress.....	74
6.6.2.3	Temperature and humidity stress profile .....	74
6.6.2.4.	Moisture .....	75
6.6.3	Marine craft (Army).....	75
6.6.3.1	Thermal stress .....	75

CONTENTS (Continued)

Paragraph		Page
6.6.3.2	Vibration stress.....	75
6.6.3.3	Electrical stress and duty cycle.....	75
6.6.4	Underwater vehicles.....	75
6.7	Combined environments for jet aircraft equipment.....	75
6.7.1	Mission profiles.....	75
6.7.2	Environmental test profiles.....	76
6.7.2.1	Mission phase (temperature mode).....	77
6.7.2.2	Duration.....	77
6.7.2.3	Altitude and Mach number.....	77
6.7.2.4	Compartment temperature.....	77
6.7.2.4.1	Ambient-cooled equipment.....	78
6.7.2.4.2	Supplementally cooled equipment.....	79
6.7.2.4.3	Temperature rate of change.....	79
6.7.2.5	Vibration.....	80
6.7.2.6	Humidity.....	81
6.7.2.7	Equipment operation.....	81
6.7.2.8	Electrical stress.....	81
6.7.3	Construction of an environmental profile.....	81
6.7.4	Test profile development.....	81
6.7.4.1	Vibration.....	82
6.7.4.2	Temperature.....	82
6.7.4.3	Example of test profile.....	82
6.7.4.4	Test profiles for various aircraft types.....	82
6.7.5	Composite environmental test profile for multimission applications.....	83
6.7.5.1	Required information.....	83
6.7.5.2	Temperature.....	83
6.7.5.3	Vibration.....	84
6.7.5.4	Construction of the composite test profile.....	85
6.7.5.4.1	Temperature.....	85
6.7.5.4.2	Vibration.....	86
6.7.5.4.3	Humidity.....	86
6.7.5.4.4	Equipment operation.....	86
6.7.5.4.5	Electrical stress.....	86
6.7.5.5	Example of composity test profile.....	86
6.8	Combined environments for V/STOL equipment.....	87
6.8.1	Mission description.....	87
6.8.1.1	Type A V/STOL missions.....	88
6.8.1.2	Type B V/STOL missions.....	88
6.8.2	Thermal stress.....	88

CONTENTS (Continued)

Paragraph		Page
6.8.3	Vibration stress .....	88
6.8.4	Electrical stress .....	89
6.8.5	Humidity .....	89
6.8.6	Equipment operation .....	89
6.8.7	Test profiles .....	89
6.9	Combined environments for turbopropeller aircraft and helicopter equipment .....	89
6.9.1	Turbopropeller aircraft environments .....	89
6.9.1.1	Electrical stress .....	89
6.9.1.2	Vibration .....	89
6.9.1.3	Thermal stress .....	89
6.9.1.4	Humidity stress .....	89
6.9.1.5	Supplementally cooled equipment .....	90
6.9.1.6	Chamber air humidity .....	90
6.9.2	Helicopter environments .....	90
6.9.2.1	Electrical stress .....	90
6.9.2.2	Vibration .....	90
6.9.2.3	Thermal stress .....	90
6.10	Combined environments for air-launched weapons and assembled external stores .....	90
6.10.1	Mission profiles .....	91
6.10.2	Environmental test profiles .....	91
6.10.2.1	Mission phase .....	93
6.10.2.2	Duration .....	93
6.10.2.3	Electrical stress .....	93
6.10.2.4	Vibration stress .....	94
6.10.2.4.1	Equipment performance test .....	94
6.10.2.4.2	Fully assembled captive-carry stores performance test .....	94
6.10.2.4.3	General notes .....	95
6.10.2.5	Thermal stress .....	95
6.10.2.5.1	Supplementally cooled equipments .....	95
6.10.2.5.2	Other equipments .....	96
6.10.2.6	Humidity stress .....	96
6.10.2.6.1	Supplementally cooled equipment .....	96
6.10.2.6.2	Chamber air humidity .....	96
6.10.3	Example of construction of environmental profile .....	96
6.11	Missile transportation, handling, and storage .....	98
6.11.1	Rail transport conditions .....	98
6.11.1.1	Vibration testing .....	98
6.11.1.2	Shock testing .....	99

## CONTENTS (Continued)

Paragraph		Page
6.11.1.3	Temperature testing .....	99
6.11.1.4	Test timeline .....	99
7.	<b>TEST INSTRUMENTATION AND FACILITIES</b> .....	<b>100</b>
7.1	Purpose .....	100
7.1.1	Scope .....	100
7.2	Test facilities and apparatus .....	100
7.2.1	Test chambers .....	100
7.2.2	Equipment cooling .....	101
7.2.2.1	External cooling .....	101
7.2.2.2	Internal coolant method .....	101
7.2.3	Test instrumentation .....	101
7.2.4	Calibration and accuracy .....	101
7.2.5	Testing the test facility .....	101
7.2.6	Installation of the test item in the test facility .....	101
8	<b>NOTES</b> .....	<b>103</b>
8.1	Intended use .....	103
8.2	Supersession .....	103
8.3	Subject term (keyword) listing .....	103
8.4	Changes from previous issue .....	103

## CONTENTS (Continued)

TABLE		Page
I	Application matrix.....	104
II	Summary of variables for the AMSAA model.....	105
III	Summary of equations, AMSAA model.....	106
IV	Equation selection guide, AMSAA model.....	107
V	Critical values of $C^2_M$ parametric form of the Cramer-Von Mises statistic.....	108
VI	Confidence intervals for MTBF, failure-terminated test.....	109
VII	Confidence intervals for MTBF, time-terminated test.....	110
VIII	AMSAA model example.....	111
IXA	(1 - $\gamma$ ) 100 percent standard confidence limits on MTBF after accept decision (lower - $\theta^1_L(\gamma, i)$ ).....	112-116
IXB	(1 - $\gamma$ ) 100 percent standard confidence limits on MTBF after accept decision (upper - $\theta^1_L(\gamma, i)$ ).....	117-120
XA	(1 - $\gamma$ ) 100 percent standard confidence limits on MTBF after reject decision (lower - $\theta^1_L(\gamma, t)$ ).....	121-125
XB	(1 - $\gamma$ ) 100 percent standard confidence limits on MTBF after reject decision (upper - $\theta^1_L(\gamma, t)$ ).....	126-130
XI	Summary of fixed-duration test plans.....	131
XII	Summary of high risk fixed-duration test plans.....	131
XIII	Demonstrated MTBF confidence limit multipliers, for failure calculation.....	132
XIV	Demonstrated MTBF confidence limit multipliers, for time calculation.....	133
XV	Accept times of fixed-duration test plans, Program Manager's Assessment.....	134-136
XVI	Comparison of risks, standard fixed~duration tests versus Program Manager's Assessment.....	137
XVII	Test times, standard fixed-duration test plans versus Program Manager's Assessment.....	138
XVIII	Failure times for the numerical example.....	139
XIX	Example of correct ordering in the AO bound calculation.....	140
XX	Example of incorrect ordering in the AO bound calculation.....	141
XXI	Example data for computer program.....	142
XXII	Example computer run for data in TABLE XXI.....	143
XXIII	Thermal stress environments for marine craft.....	144
XXIV	Environmental profile data (example).....	144
XXV	Test profile data (example).....	146
XXVI	Hot day temperatures ( $^{\circ}$ C) for Class I equipment in air- conditioned compartments.....	147

## CONTENTS (Continued)

TABLE		Page
XXVII	Hot day ambient temperature (°C) for Class II equipment in air-conditioned compartments .....	147
XXVIII	Hot day ambient temperatures (°C) for equipment in ram air-cooled compartments .....	148
XXIX	Cold day ambient temperatures (°C) for equipment in ram air-cooled compartments .....	149
XXX	Temperatures (°C) for Class I and Class II equipment in air-conditioned compartments .....	149
XXXI	Jet aircraft random vibration test .....	150
XXXII	Tabulation of temperature values .....	150
XXXIII	Summary of temperature values .....	151
XXXIV	Tabulation of vibration levels .....	152
XXXV	Summary of vibration levels .....	153
XXXVI	Composite test profile timeline .....	153
XXXVII	Temperature level tabulation - hot day (example) .....	154
XXXVIII	Temperature summary - hot day (example) .....	154
XXXIX	Temperature level tabulation - cold day (example) .....	155
XL	Temperature summary - cold day (example) .....	155
XLI	Vibration level tabulation (example) .....	156
XLII	Vibration level summary (example) .....	156
XLIII	Temperature rate of change (example) .....	157
XLIV	Composite test profile timeline (example) .....	158
XLV	Random vibration test for V/STOL aircraft .....	159
XLVI	Environmental profile sequence .....	160
XLVII	Stores host aircraft mission utilization rates for environmental testing .....	161
XLVIII	Random vibration, $g_{rms}$ (OVL), level adjustment factors for the maximum predicted environment (95th percentile with 50 percent confidence based on one-side tolerance limit) .....	162
XLIX	Method of calculating the acceleration power spectral density spectrum to produce $\sum_{i=1}^N A_i$ equal to a unit - $g_{rms}$ (OVL) .....	163-165
L	Preliminary operational design requirements (expected life of 5 years) .....	166-170
LI	Life cycle environments .....	171-188
LII	Assumed typical attack mission profiles .....	189
LIII	A method for calculating test profile times for a specific number of test cycles .....	190-191

**CONTENTS (Continued)**

<b>TABLE</b>	<b>Page</b>
LIV	Attack aircraft captive-carriage mission profile data (example)..... 192
LV	Assumed free-flight mission profile for example store (low-low), vibration ..... 193-194
LVI	Assumed free-flight mission profile for example store (low-low), standard day ..... 195
LVII	Composite test cycle profile example timeline - testing profiles for the reliability captive-flight test cycle..... 196-199
LVIII	Composite test cycle profile example timeline - mission profile for the high-medium-low test cycle profile..... 200-203
LVIX	Composite test cycle profile example timeline - mission profile for the high-low-high test cycle ..... 204-207
LX	Composite test cycle profile example timeline - mission profile for the free-flight low-low ..... 208-211

**CONTENTS (Continued)**

FIGURE		Page
1A	Reliability growth profile.....	15
1	Duane plot.....	212
2	Interval plot of example data.....	213
3	Graphical data plot for ESS.....	214
4	Typical thermal stress cycle.....	215
5	Vibration stress.....	216
6	MTBF assurance test (curve 1).....	216
7	MTBF assurance test (curve 2).....	217
8	Probability ratio sequential test (example).....	218
9	Test Plan I-D.....	219-220
10	Test Plan II-D.....	221-222
11	Test Plan III-D.....	223-224
12	Test Plan IV-D.....	225-226
13	Test Plan V-D.....	227-228
14	Test Plan VI-D.....	229-230
15	Test Plan VII-D.....	231-232
16	Test Plan VIII-D.....	233-234
17	Fixed-duration test plan (example).....	235
18	10 percent consumer's risk ( $\beta$ ) test plans.....	235
19	20 percent consumer's risk ( $\beta$ ) test plans.....	237
20	30 percent consumer's risk ( $\beta$ ) test plans.....	238
21	Demonstrated MTBF confidence limit multipliers, for failure calculation.....	239
22	Demonstrated MTBF confidence limit multipliers, for time calculation.....	240
23	Test Plan IX-D.....	241-242
24	Test Plan X-D.....	243-244
25	Test Plan XI-D.....	245-246
26	Test Plan XII-D.....	247-248
27	TestPlan XIII-D.....	249-250
28	TestPlan XIV-D.....	251-252
29	Test Plan XV-D.....	253-254
30	Test Plan XVI-D.....	255-256
31	Test Plan XVII-D.....	257-258
32	TestPlan XIX-D.....	259-260
33	Test Plan XX-D.....	261-262
34	Test Plan XXI-D.....	263-264
35	Test Plan XVIII-D.....	265-266
36	Boundary line criterion for reject-accept decision.....	267
37	All Equipment test plan derived from Test Plan I-D.....	268-269

CONTENTS (Continued)

FIGURE		Page
38	All Equipment test plan derived from Test Plan II-D.....	270-271
39	All Equipment test plan derived from Test Plan III-D .....	272-273
40	All Equipment test plan derived from Test Plan IV-D .....	274-275
41	All Equipment test plan derived from Test Plan V-D .....	276-277
42	All Equipment test plan derived from Test Plan VI-D.....	278-279
43	All Equipment test plan derived from Test Plan VII-D.....	280-281
44	All Equipment test plan derived from Test Plan VIII-D .....	282-283
45	Time truncation (Type I censoring) .....	284
46	Combined environmental test profile for fixed-ground equipment .....	285
47	Combined environmental test profile for mobile ground equipment .....	286
48	Naval surface craft, mission environmental profile for externally mounted equipment (cold cycle).....	287
49	Naval surface craft, mission environmental profile for externally mounted equipment (hot cycle).....	288
50	Naval surface craft, mission environmental profile for internally mounted equipment (cold cycle).....	289
51	Naval surface craft, mission environmental profile for internally mounted equipment (hot cycle) .....	290
52	Naval surface craft, mission environmental profile for internally mounted temperature controlled.....	291
53	Naval surface craft, mission environmental profile for internally mounted temperature controlled.....	292
54	Surface craft and submarine vibration spectrum.....	293
55	Submarine profile.....	294
56	Combined environmental test profile, for marine craft equipment .....	295
57	General mission profile and characteristics for six aircraft types and twelve missions.....	296
58	General mission profile and characteristics for six aircraft types and twelve missions.....	298-299
59	General mission profile and characteristics for four aircraft types and seven missions .....	300-301
60	General mission profile and characteristics for an attack aircraft on a high-low-low-high mission.....	302
61	General mission profile and characteristics for a fighter aircraft on an intercept mission.....	303
62	General mission profile and characteristics for a reconnaissance aircraft on a high-supersonic mission .....	303

CONTENTS (Continued)

FIGURE		Page
63	Mission profile for temperature rate of change calculation .....	303
64	Dynamic pressure (q) as function of Mach number and altitude .....	304
65	Random vibration test envelope for jet aircraft .....	305
66	Environmental profile (example) .....	306
67	Mission profile (example) .....	307
68	Test profile (example) .....	308
69	Attack aircraft test profile (low-low-low) .....	309
70	Attack aircraft test profile (close support) .....	310
71	Attack aircraft test profile (high-low-high) .....	311
72	Attack aircraft test profile (high-high-high) .....	312
73	Attack aircraft test profile (high-low-low-high) .....	313
74	Attack aircraft test profile (ferry) .....	314
75	ASW aircraft test profile (contact investigation - high) .....	315
76	ASW aircraft test profile (contact investigation intermediate) .....	316
77	ASW aircraft test profile (mine laying) .....	317
78	ASW aircraft test profile (high-high-high) .....	318
79	ASW aircraft test profile (search and attack) .....	319
80	ASW aircraft test profile (surface surveillance) .....	320
81	ASW aircraft test profile (ferry) .....	321
82	ECM aircraft test profile (penetration) .....	322
83	ECM aircraft test profile (stand-off) .....	323
84	ECM aircraft test profile (ferry) .....	324
85	Fighter aircraft test profile (high-high-high) .....	325
86	Fighter aircraft test profile (escort) .....	326
87	Fighter aircraft test profile (air defense and captive flight) .....	327
88	Fighter aircraft test profile (intercept) .....	328
89	Fighter aircraft test profile (high-low-low-high) .....	329
90	Fighter aircraft test profile (low-low-low) .....	330
91	Fighter aircraft test profile (low-low-high) .....	331
92	Fighter aircraft test profile (close support) .....	332
93	Fighter aircraft test profile (ferry) .....	333
94	Reconnaissance aircraft test profile (high-low-high) .....	334
95	Reconnaissance aircraft test profile (low-low-high) .....	335
96	Reconnaissance aircraft test profile (low-low-low) .....	336
97	Reconnaissance aircraft test profile (high-supersonic) .....	337
98	Reconnaissance aircraft test profile (high-subsonic) .....	338
99	Reconnaissance aircraft test profile (ferry) .....	339
100	Tanker aircraft test profile (high-low-high refuel) .....	340
101	Tanker aircraft (low-low-low refuel) .....	341

CONTENTS (Continued)

FIGURE		Page
102	Tanker aircraft test profile (strike refuel) .....	342
103	Composite test profile (example) .....	343
104	Composite test profile (example) .....	344
105	Type A V/STOL airborne early warning mission profile .....	345
106	Type A V/STOL anti-submarine warfare mission profile .....	346
107	Type A V/STOL contact investigation mission profile .....	346
108	Type A V/STOL marine assault mission profile .....	346
109	Type A V/STOL surface attack mission profile .....	347
110	Type A V/STOL tanker mission profile .....	347
111	Type A V/STOL vertical onboard delivery mission profile .....	348
112	Type B V/STOL combat air patrol mission profile .....	348
113	Type B V/STOL deck launched intercept mission profile .....	349
114	Type B V/STOL subsonic surface surveillance mission profiles .....	349
115	Type A V/STOL airborne early warning environmental profiles .....	350
116	Type A V/STOL anti-submarine warfare environmental profiles .....	350
117	Type A V/STOL contact investigation environmental profiles .....	351
118	Type A V/STOL marine assault environmental profile .....	351
119	Type A V/STOL surface attack environmental profile .....	352
120	Type A V/STOL tanker environmental profile .....	352
121	Type A V/STOL vertical onboard delivery environmental profiles .....	353
122	Type B V/STOL combat air patrol environment profile .....	353
123	Type B V/STOL deck launched intercept environmental profiles .....	354
124	Type B V/STOL subsonic surface surveillance environmental profiles .....	354
125	Turbopropeller vibration test spectra for equipment mounted within the fuselage (example) .....	355
126	Thermal profile for turbopropeller aircraft .....	356
127	Typical mission test cycle profile .....	357
128	Combined environmental test profile for rotary wing aircraft .....	358
129	Combined mission profile for rotary wing aircraft (hot and cold day operation) .....	359
130	Typical reliability captive flight test sequence (one cycle) .....	360
131	Typical reliability free flight test sequence (one cycle) .....	361

**CONTENTS (Continued)**

FIGURE		Page
132	Random vibration maximum predicted environment for combined air-launched weapons and assembled external stores .....	362
133	Random vibration maximum predicted environment for air-to-surface (AG M) air-launched weapons .....	363
134	Random vibration maximum predicted environment for air-to-air (AAM) air-launched weapons .....	364
135	Assembled external stores and air-launched weapons - vibrational response acceleration PSD versus frequency spectra .....	365
136	Equipment installed in assembled external stores and air-launched weapons - vibrational response acceleration PSD versus frequency spectra .....	366
137	Induced buffet maneuver random vibration response spectrum .....	367
138	Low- low free-flight mission profile (example) .....	368
139	Environmental engineering program schematic .....	369
140	Logistics functional schematic diagram .....	370
141	European scenario assumed maintenance schedule and possible operational utilization rate for environmental analyses (example) .....	371
142	Target movement timeline for environmental design criteria (European scenario) - large quantities (example) .....	372-373
143	Estimated percentage of time distribution for transportation, hold/delay, and handling, for nominal-probable factory-to-theater movement timeline .....	374
144	Assumed typical attack aircraft operating envelope (standard day) showing the assumed high-medium-low mission profile .....	375-376
145	Assumed typical attack aircraft operating envelope (standard day) showing the assumed high-low-high mission profile .....	377-378
146	Vibration factor ( $g_{rms} (OVL))^2$ flight mission profile high-medium-low use with FIGURES 130 and 143 except (*), versus minimum $g_{rms} (OVL)^2$ (example) .....	379
147	Vibration factor ( $g_{rms} (OVL))^2$ flight mission profile high-low-high use with FIGURES 130 and 144 except (*), versus inimum ( $g_{rms} (OVL))^2$ (example) .....	380
148	Store free-flight vibration factor ( $g_{rms} (OVL))^2$ flight mission profile low-low use with FIGURES 131 thru 134 and TABLE XLVIII (example) .....	381
149	Unit- $g_{rms} (OVL)^2$ acceleration PSD versus frequency spectra .....	382-383
150	Vibration profiles for rail transportation .....	384

CONTENTS (Continued)

FIGURE		Page
151	Rail transportation test profile .....	385
152	Program listing for FORTRAN program.....	386-387
153	Program listing for FORTRAN program.....	388-389
154	Program listing for FORTRAN program.....	390-391

## 1. SCOPE

1.1 Purpose. This handbook provides test methods, test plans, and test environmental profiles which can be used in reliability testing during the development, qualification, and production of systems and equipment.

1.2 Applicability. This handbook explains techniques for use in reliability tests performed during integrated test programs. Procedures, plans, and environments which can be used in Reliability Development/Growth Tests (RD/GT), Reliability Qualification Tests (RQT), Production Reliability Acceptance Tests (PRAT), Environmental Stress Screening (ESS) methods, and Durability/Economic Life Test are provided.

1.2.1 Application of handbook. Data provided in this handbook is typical of reliability test programs and may be specified in Department of Defense contracted procurements, requests for proposals, statements of work, and Government in-house developments which require reliability testing. This handbook is for guidance only. This handbook cannot be cited as a requirement. If it is, the contractor does not have to comply

1.3 Method of reference. When referencing the test methods, test plans, and environmental test conditions, the source is to be cited.

1.4 Equipment categories. The methods in this handbook are applicable to six broad categories of equipment, distinguished according to each equipment's field service application:

Category 1. Fixed-ground equipment

Category 2. Mobile ground equipment

- A. Wheeled vehicle
- B. Tracked vehicle
- C. Shelter configuration
- D. Manpack

Category 3. Shipboard equipment

- A. Naval surface craft
- B. Naval submarine
- C. Marine craft
- D. Underwater vehicle

Category 4. Equipment for jet aircraft

- A. Fixed-wing
- B. Vertical and Short Takeoff and Landing (V/STOL)

Category 5. Turboprop aircraft and helicopter equipment

- A. Turboprop
- B. Helicopter

**Category 6. Missiles and assembled external stores**

- A. Air-launched missiles**
- B. Assembled external stores**
- C. Ground-launched missiles**

## 2. APPLICABLE DOCUMENTS

### 2.1 General. None

### 2.2 Government Documents.

#### 2.2.1 Specifications, standards and handbooks.

MIL-HDBK-189, Reliability Growth Management.

### 2.3 Non-Government publications.

1. Duane, J.T. 1964, Learning Curve Approach to Reliability Monitoring, IEEE Transactions on Aerospace, 2: 536-566.
2. Crow, L.H. 1974, Reliability Analysis for Complex Repairable Systems, US Army Material Systems Analysis Activity, Technical Report 138, Aberdeen Proving Ground, MD.
3. Ascher, H.E., 1984, On the Estimation of Required Screening Time to Ensure Zero Remaining Defects Presented at the Institute for Environmental Sciences Annual Technical Meeting.
4. A. Harter, H.L., 1964, New Tables of the Incomplete Gamma Function Ratio and of Percentage Points of the Chi-square and Beta Distributions. U.S. Government Printing Office, Washington, DC.
5. NAVMAT P-9492, May 1979, Navy Manufacturing Screening Program.
6. Sexton, T. ,1972, MRI and RAT Evaluation Procedure, Grumman Inter-Office Memorandum, A 51-340-1-72-264.
7. Schmee, I. and Bryant, C.M., February 1979, "Confidence Limits on MTBF for Sequential Test Plans of MIL-STD-781 -, Technometrics. Vol. 21, No. 1.
8. Wald, A., 1947, Sequential Analysis, John Wiley & Sons, New York, NY.
9. Epstein, B. and Sobel, M. 1955, "Sequential Life Tests in the Exponential Case", Annals of Mathematical Statistics Volume 26, pp. 82-93.
10. Bazofsky, I., 1963. Reliability Theory and Practice. Prentice Hall.
11. Handbook of Mathematical Functions With Formulas, Graphs, and Mathematical Tables. U.S. Department of Commerce, National Bureau of Standards, Applied Mathematics Series, No. 55.

12. Butler, D.A., and Lieberman, G.J., June 1980. An Early-Accept Modification to the Test Plans of Military Standard 781C Technical Report No. 196, Department of Operations Research and Department of Statistics, Stanford University.
13. Mann, N.R., Grubbs, F.E., 1972, "Approximately Optimum Confidence Bounds on Series Systems Reliability for Exponential Time to Failure Data", Biometrika, Vol. 59, pp. 191-204.
14. Mann, N.R., 1974, "Simplified Expressions for Obtaining Approximately Optimum System Reliability Confidence Bounds from Exponential Subsystem Data", Journal of the American Statistical Association.
15. Mann, N.R., Schaffer, R.E., Singpurwalla, 1974, Methods for Statistical Analysis of Reliability and Life Data, Wiley.
16. CORADCOM, February 1979, Product Assurance and Test Directorate, Procedure for Use of Environmental Profiles in Reliability Requirements of MIL-STD-781.
17. Report Series, Annual Report Sep 3:78, Commanding Officer, Naval Ship Weapon Systems Engineering Station, Port Hueneme, CA 93043, Environmental Profiles for Reliability Testing of Navy Electronic Equipment, Annual Report, December 1978.
18. Naval Ocean Systems Center, San Diego, CA, Environmental Profiles for Environmental Testing of Electronic Equipment, March 1979 (submarines).
19. Weapons Quality Engineering Center, Naval Undersea Warfare Engineering Station, Keyport, WA, Underwater Vehicle Environments.
20. RMS-79-R-1, Development of Environmental Profiles for Testing Equipment Installed in Naval Aircraft (Fixed Wing), Grumman Aerospace Corporation, February 1979 (AD-A0997 13).
21. RMS-79-R-3, Development of Environmental Profiles for Testing Equipment Installed in Naval V/STOL Aircraft, Grumman Aerospace Corporation, May 1979 (AD-A099744).
22. 3-5631 0/4R-238. 28 September 1984. Recommended Reliability Environmental Stress Testing Conditions for Helicopter Mounted Equipment and Assembled External Stores. LTV Aerospace and Defense Company.

23. Piersol, A. G., December 1984, Vibration and Acoustic Test Criteria for Captive Flight of Externally Carried Aircraft Stores AFFDL-TR-7 1 - 158.
24. Spencer, M. G., March 1984, MIL-STD-781. Update Support Rail Transportation. Environmental Profile, BDM Corporation.

2.4 Order of Precedence. In the event of a conflict between the text of this document and the references cited herein, the text of this document takes precedence. Nothing in this document, however, supersedes applicable laws and regulations unless a specific exemption has been obtained.

### 3. DEFINITIONS

3.1 Terms. Terms used herein are in accordance with established guidance.

3.1.1 Corrective maintenance (repair). The actions performed, as a result of failure, to restore an item to a specified condition.

3.1.2 Decision risks. Decision risks should be as specified in 3.1.2.1 through 3.1.2.3.

3.1.2.1 Consumer's risk ( $\beta$ ). Consumer's risk ( $\beta$ ) is the probability of accepting equipment with a true mean-time-between-failures (MTBF) equal to the lower test MTBF ( $\theta_1$ ). The probability of accepting equipment with a true MTBF less than the lower test MTBF ( $\theta_1$ ) will be less than ( $\beta$ ).

3.1.2.2 Producer's risk ( $\alpha$ ). Producer's risk ( $\alpha$ ) is the probability of rejecting equipment which has a true MTBF equal to the upper test MTBF ( $\theta_0$ ). The probability of rejecting equipment with a true MTBF greater than the upper test MTBF will be less than ( $\alpha$ ).

3.1.2.3 Discrimination ratio (d). The discrimination ratio (d) is one of the standard test plan parameters; it is the ratio of the upper test MTBF ( $\theta_0$ ) to the lower test MTBF ( $\theta_1$ ) that is,  $d = \theta_0/\theta_1$ .

3.1.3 Multiple failures. The simultaneous occurrence of two or more independent failures. When two or more failed parts are found during troubleshooting and failures cannot be shown to be dependent, multiple failures are presumed to have occurred.

3.1.3.1 Pattern failures. The occurrence of two or more failures of the same part in identical or equivalent applications when the failures are caused by the same basic failure mechanism and the failures occur at a rate which is inconsistent with the parts predicted failure rate.

3.1.3.2 Primary failure. An independent malfunction of equipment under test; a root cause.

3.1.4 Measures of reliability. Reliability measurement should be as specified in 3.1.4.1 through 3.1.4.10.

3.1.4.1 Mean-Time-Between-Failure (MTBF). A basic measure of the system reliability parameter related to availability and readiness. The total number of system life units, divided by the total number of events in which the system becomes unavailable to initiate its mission(s), during a stated period of time.

3.1.4.2 Demonstrated MTBF interval ( $\theta d$ ). Demonstrated MTBF interval ( $\theta d$ ) is the probable range of true MTBF under test conditions; that is, an interval estimate of MTBF at a stated confidence level.

3.1.4.3 Observed MTBF ( $\hat{\theta}$ ). Observed MTBF ( $\hat{\theta}$ ) is equal to the total operating time of the equipment divided by the number of relevant failures.

3.1.4.4 Lower test MTBF ( $\theta_1$ ). Lower test MTBF ( $\theta_1$ ) is that value which is unacceptable. The standard test plans will reject, with high probability, equipment with a true MTBF that approaches ( $\theta_1$ ).

3.1.4.5 Upper test MTBF ( $\theta_0$ ). Upper test MTBF ( $\theta_0$ ) is an acceptable value of MTBF equal to the discrimination ratio times the lower test MTBF ( $\theta_1$ ). The standard test plans will accept, with high probability, equipment with a true MTBF that approaches ( $\theta_0$ ). This value ( $\theta_0$ ) should be realistically attainable, based on experience and information.

3.1.4.6 Predicted MTBF ( $\theta_p$ ). Predicted MTBF ( $\theta_p$ ) is that value of MTBF determined by reliability prediction methods; it is a function of the equipment design and the use environment. ( $\theta_p$ ) should be equal to or greater than ( $\theta_0$ ) in value, to ensure with high probability, that the equipment will be accepted during the reliability qualification test.

3.1.4.7 Observed cumulative failure rate ( $P(t)$ ). The observed cumulative failure rate ( $P(t)$ ) at time  $t$  is equal to the number of relevant system failures  $N(t)$  accumulated by  $t$ , divided by  $t$ .

3.1.4.8 Intensity function ( $P(t)$ ). The intensity function ( $P(t)$ ) is the change per unit time of the expected value of  $N(t)$ , the number of system failures multiplied by time  $t$ . This is written as:

$$P(t) = dE(N(t))/dt$$

where  $E$  represents the expected value.

3.1.4.9 Instantaneous MTBF function ( $M(t)$ ). The instantaneous MTBF function at  $t$  is equal to the reciprocal of the failure rate function.

3.1.4.10 Observed reliability ( $R(t)$ ). A point estimate of reliability equal to the probability of survival for a specified operating time,  $t$ , given that the equipment was operational at the beginning of the period.

3.1.4.11 Mean-Time-Between-Maintenance. A measure of the reliability taking into account maintenance policy. The total number of life units expended by a given time, divided by the total number of maintenance events (scheduled and unscheduled) due to that item.

3.1.5 Mission profile. A thorough description of all of the major planned events and conditions associated with one specific mission. A mission profile is one segment of a life-cycle profile (for example, a missile captive-carry phase or a missile free-flight phase). The profile

depicts the time span of the event, the expected environmental conditions, energized and nonenergized periods, and so forth.

3.1.6 Life-cycle profile. A thorough time-life description of the events and conditions associated with an item of equipment from the time of final factory acceptance until its ultimate disposition (for example, factory-to-target sequence). Each significant life-cycle event, such as transportation, dormant storage, test and checkout, standby and ready modes, operational deployment, and mission profiles, is addressed, including alternate possibilities. The profile depicts the time span of each event, the environmental conditions, and the operating modes.

## 4. GENERAL GUIDANCE

4.1 **Reliability test program.** The reliability test program should be integrated with other development and production tests in accordance with this handbook. The reliability tests should be selected and tailored according to the type of item and for each appropriate acquisition phase.

4.2 **Integrated reliability test planning.** In order to avoid duplication of test effort and to ensure that deficiencies are not overlooked, the integrated reliability test planning should define procedures which ensure that reliability data is derived from all other tests. Integrated test planning should consider a description of the test plans selected for use, the decision risks, and the environmental test conditions, and should be keyed to the program life-cycle phases.

4.3 **Environmental test conditions.** The environmental test conditions to be applied during the test and their variation with time should be representative of the field service and mission environment of the equipment under test. This does not apply to ESS.

4.3.1 **Combined environmental test conditions.** Unless otherwise specified by the procuring activity, the stress types defined in 4.3.1.1 through 4.3.1.5, should be combined in the same chamber at levels and rates of change appropriate to the specified stress data. The combined environmental test conditions profile should be developed in accordance with the guidance provided in Section 5.

4.3.1.1 **Electrical stress.** Electrical stress should include equipment ON-OFF cycling, operation in accordance with the specified operating modes and duty cycles, and input voltage variation above and below the nominal operational value.

4.3.1.2 **Vibration stress.** Vibration test levels and profiles should be tailored to the specified intended application of the equipment and should consider the mounting location and the classification category for field use. The factors that should be considered in the definition of realistic vibration stress include a) type of vibration (sine sweep, complex, or random); b) frequency range; c) amplitude; and d) manner and axis of application. The intent is to produce in the equipment on test a vibration response with a character, magnitude, frequency range, and duration similar to that produced by the field service environment and mission profile. The mechanical impedance effects (the interaction of equipment, fixtures, attachment structures, and shakers which would influence the laboratory simulation of the effects of vibration environments) should be accounted for in establishing vibration levels for all tests.

4.3.1.3 **Thermal stress.** The thermal stress profile should be a realistic simulation of the actual thermal environment that the equipment experiences in the service application. The factors to be considered in the definition of thermal stress include; a) starting temperature (heat soak, cold soak) and turn on (warmup) time; b) operating temperature (range, rate of change, and frequency of change; c) number of temperature cycles per mission profile; and d) cooling airflow (rate and fluctuation).

4.3.1.4 **Moisture.** Moisture levels during the temperature cycles should be sufficient to produce visible condensation and frosting or freezing, when such conditions can be expected in field service. The humidity should be controlled during the test cycle and may be increased to produce the desired result by injecting water vapor at appropriate times in the test cycle.

4.3.1.5 **Equipment cycling.** Equipment cycling imposed during reliability tests should be representative of field operation, see Section 5.

4.4 **Test instrumentation and facilities.** Test instrumentation and facilities used in conducting the tests are described in Section 6. These items should be fully calibrated and tested.

4.4.1 **Tolerance of test environments.** Unless otherwise stated in the equipment specification, tolerance of test environments should be as specified in a and b:

- a. Temperature:  $\pm 2^{\circ}$ Celsius (C) ( $3.6^{\circ}$ Fahrenheit (F)), after thermal stabilization.
- b. Vibration amplitude: Sinusoidal, 10 percent. Random, as in Section 5.

4.4.2 **Calibration of test apparatus.** The calibration of instruments, test equipment, and chambers used to control or monitor the test parameters should be verified periodically. All instruments and test equipment used in conducting the test should:

- a. Conform to laboratory standards whose calibration is traceable to the National Bureau of Standards of the U.S. Department of Commerce
- b. Have a precision of at least one-third the tolerance for the variable to be measured
- c. Be appropriate for measuring the conditions concerned

4.5 **Performance baselines.** Both performance and reliability should be assessed in a test program of statistically valid length under combined, cyclic, and time-varying environmental conditions which simulate conditions expected in service use. This should be accomplished by demonstrating an acceptable performance baseline, through detailed performance measurement, before the start of reliability testing. After completion of the detailed performance measurements, selected performance test criteria should be used during the reliability test to ensure acceptable equipment performance. All pretest and post-test measurements should be performed at standard ambient conditions. Actual test conditions should be recorded during the test period, whether controlled or not.

4.5.1 **Pretest performance.** Prior to starting tests, the performance level of the test item relative to the specified requirements should be established and recorded under standard ambient conditions. The pretest performance check should be made after installation of the item in the test facility.

4.5.2 **Performance during test.** Performance data should be recorded for the test item during each test cycle.

4.5.3 Post-test performance. Performance data should be recorded for the test item at the conclusion of the test.

4.6 Failure reporting, analysis, and corrective action system (FRACAS). A closed loop system should be used to collect data on, analyze, and record timely corrective action for all failures that occur during reliability tests. The system should cover all test items, interfaces between test items, test instrumentation, test facilities, test procedures, test personnel, and the handling and operating instructions.

4.6.1 Problem and failure reporting. A failure report should be initiated at the occurrence of each problem or failure. The report should contain the information required to permit determination of the origin and correction of failures. The existing failure report forms should include the information specified in a through c:

- a. Descriptions of failure symptoms, conditions surrounding the failure, failed hardware identification, and operating time (or cycles) at time of failure.
- b. Information on each independent and dependent failure and the extent of confirmation of the failure symptoms, the identification of failure modes, and a description of all repair action taken to return the item to operational readiness
- c. Information describing the results of the investigation, the analysis of all part failures, an analysis of the item design, and the corrective action taken to prevent failure recurrence. If no corrective action is taken, the rationale for this decision should be recorded.

4.6.1.1 Identification and control of failed items. A failure tag should be affixed to the failed item immediately upon the detection of any failure or suspected failure. The failure tag should provide space for the failure report serial number and for other pertinent entries from the item failure record. All failed parts should be marked conspicuously or tagged and controlled. Failed parts should not be handled in any manner which may obliterate facts which might be pertinent to the analysis. Failed parts should be stored pending disposition of the failure analysis.

4.6.1.2 Problem and failure investigations. An investigation and analysis of each reported failure should be performed. Investigation and analysis should be conducted to the level of hardware or software necessary to identify causes, mechanisms, and potential effects of the failure.

4.6.1.3 Failure verification. Reported failures should be verified as actual failures or an acceptable explanation provided for lack of failure verification. Failure verification is determined either by repeating the failure mode on the reported item or by physical or electrical evidence of failure. Inability to verify a failure is not sufficient rationale to disregard the occurrence of a failure.

4.6.1.4 Corrective action. When the cause of failure has been determined, a corrective action should be developed to eliminate or reduce the recurrence of the failure. Repairs should

be made in accordance with normal field operating procedures and manuals. The failure analysis and the resulting corrective actions should be documented. The effectiveness of the corrective action should be demonstrated.

4.6.1.5 Problem and failure tracking and closeout. The closed loop failure reporting system should include provisions for tracking problems, failures, analyses, and corrective actions. Status of corrective actions for all problems and failures should be readily available at all times. Problem and failure closeout should be reviewed to assure their adequacy.

4.7 Failure categories. A relevant failure is any primary malfunction, including software, which results in a failure of the item under test to meet specifications. Excepted only are failures which result from test personnel error, malfunction of test equipment, or anything associated with the test facility.

4.7.1 Failure classification. Failure definition and scoring criteria for classification of failures should be agreed upon prior to start of test.

## 5. RECOMMENDED RELIABILITY TEST METHODS AND TEST PLANS

**5.1 Purpose.** This section provides information and guidance for selecting methods and plans for reliability testing.

### 5.2 Test planning

**5.2.1 Integrated reliability testing.** Integrated reliability testing should identify all tests that provide data for evaluating the reliability of systems and equipment and should be part of the overall program planning. An essential element of integrated reliability testing is to ensure that mature equipment (both hardware and software) is available for final development and operational testing.

#### 5.2.1.1 Reliability growth planning.

**Purpose.** The purpose is to develop a reliability growth planning curve which specifies the plan for achieving specified reliability values and which provides a means for tracking reliability growth and monitoring progress as the test proceeds.

**Task description.** A graphically portrayed reliability growth planning curve should be prepared to indicate what the reliability value should be at incremental points throughout the program to manage reliability achievement.

**Reliability growth planning curve development.** The reliability growth planning curve development should be based on data from previous development programs for items of the same type being developed. These data should be analyzed to determine the length of the reliability growth test period and to provide project management with a means of monitoring progress during test. Detailed guidelines are provided in MIL-HDBK-189.

**Reliability growth curve preparation.** The reliability growth curves should be prepared as point estimates of each reliability parameter specified (that is, system MTBF, mission MTBF, probability of success, and so forth) for the entire systems and each major subsystem, as specified by the procuring activity. The vertical axis of the graph should portray cumulative values of the reliability parameter of the system or major subsystem and the horizontal axis should be in units of both calendar time and test time. Each test planned should be clearly indicated. A growth curve is shown in FIGURE 1A.

**Reliability growth curve starting point.** Planned growth curves should depict planned levels of reliability achievement at specific points in calendar time and test time and should be coordinated with the scheduled reliability program reviews. Values along the planned growth curve should represent the planned reliability improvement as measured by a point estimate. The MTBF value indicated by the planned growth curve at the end of any test program (for example, RD/GT in FIGURE 1A) should be achieved or exceeded at or before the end of that test program. The starting point for the planned growth curve should be determined: 1) from information of previous programs on similar systems; 2) by specifying a minimum level of

reliability which must be achieved to conform to the specified requirements; or 3) by conducting an engineering assessment of the design and any previous development test data. If historical data are unavailable, the starting point may be estimated by applying a constant factor (K) (that is, 10 percent, 15 percent, and so forth) to the reliability predicted for the mature system. Every effort should be made, however, to obtain information relevant to a realistic starting point prior to applying a K. A second curve, called the Adjusted Growth curve, which reflects the level at which the achieved reliability would be if the corrected failures were discounted, may also be provided.

**Predicted reliability growth rate.** Engineering rationale should be provided for the reliability growth rate that is predicted between the scheduled review points. When the predicted growth curves have been derived from historical data from similar programs, these programs and the similarities and differences with the present program should be specified.

**5.2.1.2 Reliability Test Reviews.** The status of reliability testing should be addressed at all program review milestones.

**5.2.1.2.1 Test Readiness Reviews.** To assure that the test item and all supporting elements are ready at the start of the test, a test readiness review should be planned and scheduled at least 7 days prior to the start of any test.

**5.2.1.2.2 Status reviews.** Formal reviews should be scheduled as preplanned milestones during the reliability test to permit the review of testing status and the results achieved to date. The status reviews should be scheduled in accordance with the contract and should consider, but not necessarily be limited to, the information specified in a through g:

- a. Current reliability assessments and projections based on test results
- b. Results of current problem and failure investigations and engineering analysis
- c. Preventive and corrective action recommendations
- d. Potential design problems based on the preventive and corrective action recommendations
- e. Status of subcontractor and supplier, or both, reliability development tests
- f. Status of previously assigned action items
- g. Assignment of action items resulting from the review including scheduled completion dates

**5.2.1.2.3 Test completion review.** A test completion review should be conducted at the completion of the test. This review should be conducted to evaluate the results of the test and should consider the information specified in a through g:

MIL-HDBK-781

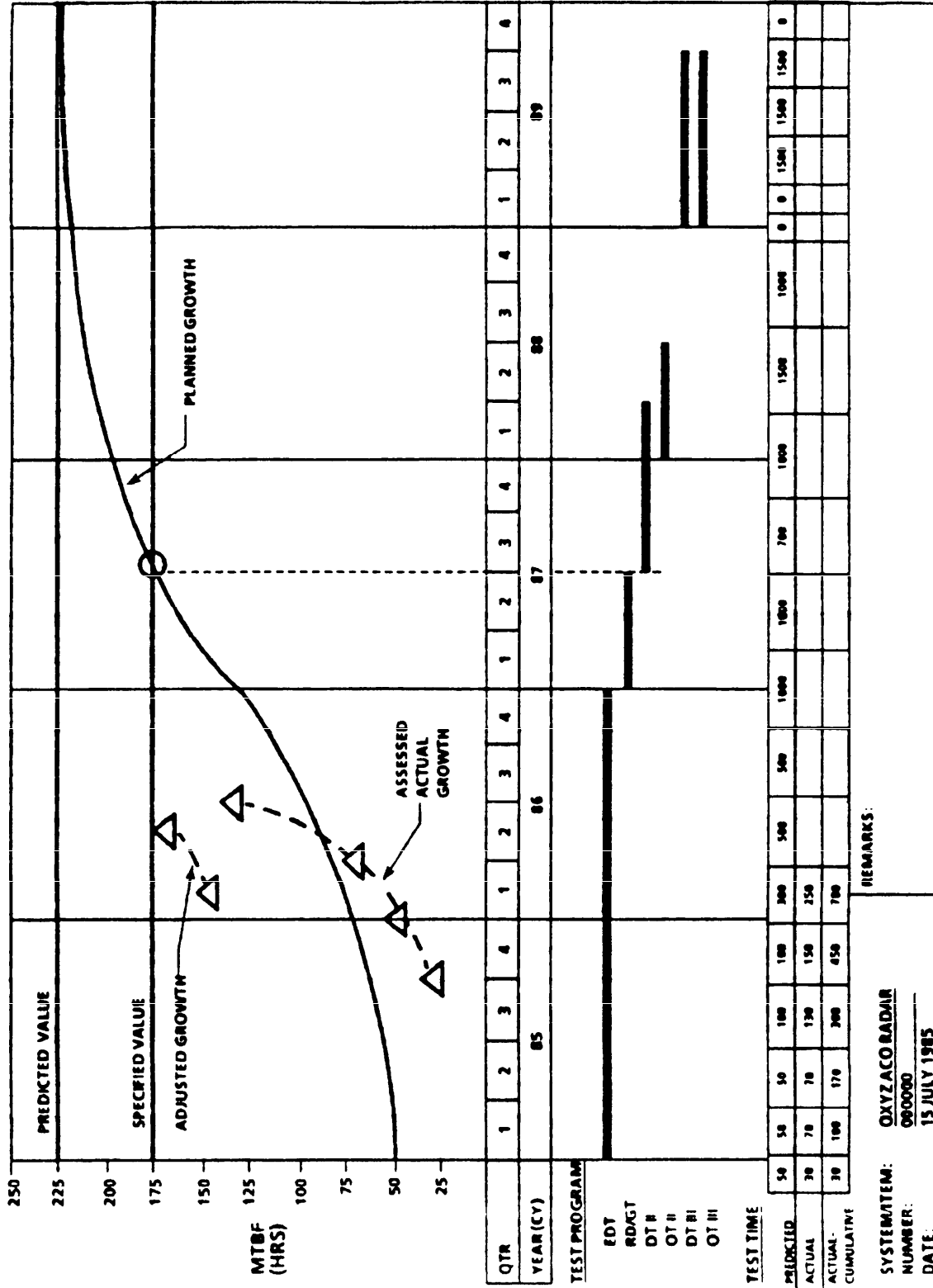

FIGURE 1A. Reliability growth profile (example)

- a. Current reliability growth assessments and achievements based on test results
- b. Status of open problems and failures
- c. Status of preventive and corrective actions
- d. Status of previously assigned action items
- e. Assignment of action items resulting from the review, including scheduled completion dates
- f. Conclusions of the review
- g. Test results documented in detail

5.2.2 Applications matrix. The interrelationships between the test methods and test plans described herein and the reliability tasks titled as follows.

5.3 Test methods. Methods for evaluating reliability growth during RD/GT and for evaluating ESS programs are provided in 5.3.1 and 5.3.2.1.

5.3.1 Growth monitoring method. Two growth monitoring (data evaluation) methods are described: the Duane Method and the Army Material Systems Analysis Agency (AMSAA) Method. The Duane Method is a graphical and nonstatistical technique which can be used to graphically plot changes in reliability. The AMSAA Method is based on the assumption that the times between successive failures can be modeled as the intensity function of a nonhomogeneous Poisson process. This intensity function is expressed as a multiple of the cumulative test time raised to some power. The Duane and AMSAA methods are described in MIL-HDBK-189.

5.3.2 Durability/Economic life test. A durability/economic life test is described to support determination of required maintenance events and required quantity of spares.

5.3.2.1 ESS evaluation methods. Two ESS evaluation methods are described which provide a means to determine when the ESS procedure should be terminated. One of the methods provides a technique for calculating a required ESS time interval (which must be satisfied to stop screening) prior to the start of the ESS. The second method makes use of arbitrary times based on historical data.

5.3.3 Test plans. MTBF assurance tests and the standard test plans provide a wide selection of tests suitable for tailoring to conform to the requirements of any reliability program.

5.3.3.1 MTBF assurance tests. The MTBF assurance tests use a failure-free interval concept to verify MTBF. The tests provide a desired assurance that a minimum specified MTBF level is achieved in addition to providing assurance that early defect failures have been eliminated. This test can be used on production equipments which have previously passed qualification testing. The MTBF assurance test provides the producer with a high probability of success (see paragraph 5.8).

5.3.3.2 Standard test plans. The standard test plans contain statistical criteria for determining compliance with specified reliability requirements and are based on the assumption that the underlying distribution of times-between-failures is exponential. The exponential assumption implies a constant failure rate; therefore, these test plans cannot be used for the purpose of eliminating design defects or infant mortality failures. The standard test plans are as categorized in a through d:

- a. Probability Ratio Sequential Test plans (PRST) (Test Plans I-D through VI-D)
- b. Short-run high-risk PRST plans (Test Plans VII-D and VIII-D)
- c. Fixed-duration test plans (Test Plans IX-D through XVII-D and XIX-D through XXI-D)
- d. All-equipment reliability test plan (Test Plan XVIII-D)

These statistical test plans are to be used to determine contractual compliance with pre-established accept-reject criteria and should not be used to project equipment MTBF.

5.4 Test method and test plan selection factors. The most important factors to be considered when selecting an appropriate test plan or method are provided in 5.4.1 through 5.4.2.5.

5.4.1 Test method and test plan selection. The test methods and test plans to be used in RD/GT, RQT, PRAT, and ESS should be selected from the material provided in a through f. The test methods or test plans should be specified in the contract and the equipment specification and described, in detail, in the reliability test plan document.

- a. The reliability growth monitoring method should be selected under conditions where parameters of the time-to-failure distribution are expected to be changing with time.
- b. The ESS methods are to be used to eliminate early defects (infant mortality). The Standard Environmental Stress Screen is a form of ESS used when it must be verified that equipment, which has passed previous reliability testing, has not been degraded by the production process.
- c. The MTBF assurance test can be used to provide assurance that a minimum specified MTBF has been achieved and that early defect failures have been eliminated.
- d. A fixed-duration test plan must be selected when it is necessary to obtain an estimate of the true MTBF demonstrated by the test, as well as an accept-reject decision, or when total test time must be known in advance.
- e. A sequential test plan may be selected when it is desired to accept or reject predetermined MTBF values ( $\theta_0, \theta_1$ ) with predetermined risks of error ( $\alpha, \beta$ ), and when uncertainty in total test time is relatively unimportant. This test will save test time, as compared to fixed-duration test plans having similar risks and discrimination ratios, when the true MTBF is much greater than ( $\theta_0$ ) or much less than ( $\theta_1$ ).

- f. The all-equipment test plan may be selected when all units of the production run must undergo a reliability lot acceptance test.

These statistical test plans are to be used to determine contractual compliance with pre-established accept-reject criteria and should not be used to project equipment MTBF.

**5.4.2 Test method and test plan parameter selection.** The most important parameters to be considered when selecting test methods and test plans are discussed in 5.4.2.1 through 5.4.2.5.

**5.4.2.1 Equipment performance.** The parameters to be measured during reliability tests and the applicable acceptance limits should be determined by the performance requirements of the equipment design control specification and should be included in the test procedures.

**5.4.2.2 Equipment quantity.** The number of equipment to be tested, not necessarily simultaneously, should be determined as described herein or as specified in the contract.

- a. **Sample size (reliability growth and qualification).** The sample size required for the growth and qualification phase test plans should be as specified in the contract or as agreed to by the contractor and the procuring activity.
- b. **Sample size (production reliability acceptance).** Unless otherwise specified by the procuring activity, the minimum of samples to be tested per lot is three pieces of equipment. The recommended sample size is 10 percent of the equipment per lot, up to a maximum of 20 pieces of equipment per lot.
- c. **All-equipment production reliability acceptance test.** Under this test plan, all production equipment is subjected to the reliability acceptance test. All-equipment acceptance testing (100 percent sample) should only be specified under exceptional circumstances, as determined by the requirements of safety or mission success.
- d. **Sample size (ESS).** Unless otherwise specified by the procuring activity, selected development equipment and all equipment in production lots should be subjected to ESS. In high volume production runs, the sample size from each lot should be selected by the procuring activity. Initial lots should be screened at the 100 percent level. Sample size on later lots may be reduced by the procuring activity based on the screening results.
- e. **Sample size (optional nonstatistical test).** The sample size for this test is all equipment in a lot whose verified reliability characteristics may be degraded by manufacturing and quality defects.

**5.4.2.3 Test duration.** The test duration for RD/GT should be specified in advance, by the Government, in the request for proposal, contract, and specification. During the test program, additional test time may be specified if needed to achieve reliability goals. ESS time is a variable, which depends on lot size, failure distribution of the early failures, types of environmental stress applied, and stress levels. Some maximum allowable test time should be used for test planning. For sequential test plans, test duration should be planned on the basis of maximum allowable test time (truncation), rather than the expected decision point, to avoid the

probability of unplanned test cost and schedule overruns. Testing should continue until the total unit hours together with the total count of relevant equipment failures permit either an accept or reject decision in accordance with the specified test plan. However, for the all-equipment reliability test, testing should continue until a reject decision is made or all contractually required equipment has been tested. Equipment ON time (that is, equipment operating time) should be used to determine test duration and compliance with accept-reject criteria. Testing should be monitored so that the times of failure may be recorded accurately. The monitoring instrumentation and techniques and the method of estimating MTBF should be included in the proposed reliability test procedures. Each equipment should operate at least one-half the average operating time of all equipment on test. The duration of fixed-time tests should be specified in the request for proposal, contract, and equipment specification. This test duration should be the maximum allowed by the schedule and fiscal constraints of the program.

5.4.2.4 Decision risks. The consumer's risk ( $\beta$ ) is the probability that equipment with MTBF equal to the lower test MTBF will be accepted by the test plan. The producer's risk ( $\alpha$ ) is the probability that equipments with MTBF equal to the upper test MTBF will be rejected by the test plan. In general, the use of low decision risks will result in longer test time. However, low decision risks provide protection against the rejection of satisfactory equipment or acceptance of unsatisfactory equipment. For each of the truncated sequential plans (PRST), the exact risks were calculated. Shifts in the accept-reject lines and truncation points were made to bring the true risks closer to the designated risks and to make the two risks more nearly equal for each plan. The decision risks of the all-equipment reliability test vary with the total test time and have little significance as a reason for choosing this plan.

5.4.2.5 Discrimination ratio (d). The discrimination ratio (d) is the ratio of the upper test MTBF ( $\theta_0$ ) to the lower test MTBF ( $\theta_1$ ) and is a measure of the power of the test to reach a decision quickly and, together with the decision risks, define a sequential test's accept-reject criteria. In general, the higher the discrimination ratio (d), the shorter the test. The discrimination ratio (d) (and corresponding test plan) must be chosen carefully to prevent the resulting ( $\theta_0$ ) from becoming unattainable due to design limitations.

## 5.5 Reliability development/growth evaluation methods.

a. The Duane Method was originally developed by J. T. Duane (see Reference 1). This method makes use of a graphical and nonstatistical technique which provides a pictorial presentation of the changes occurring in the measured reliability parameter. Numerical estimates of the reliability parameter also can be obtained.

b. The AMSAA Method for evaluating reliability growth presented herein was developed by AMSAA. This method is discussed in some detail in MIL-HDBK-189. Additional information is provided in Reference 2. The AMSAA model was selected for inclusion in this handbook because it is an analytical model which permits confidence interval estimates to be computed from the test data for current and future values of reliability (MTBF) or failure rate ( $\lambda$ ). In addition, the model can be applied to either continuous (time) or discrete (rounds, miles) reliability systems, single or multiple systems, and tests which are time or failure truncated.

5.5.1 The Duane method. The Duane method is a graphical technique which is useful in the analysis of reliability growth data. The technique is quick, simple, and easy to understand. The Duane plot or graph can depict facts that may be hidden by a purely statistical analysis. For example, a goodness-of-fit test may call for rejecting the AMSAA model, but will not indicate possible reasons for the rejection. A plot of the same data may indicate some reason for the problem. However, the reliability parameters cannot be estimated by the Duane Method as well as they can by a statistical model and, of course, no interval estimates can be computed. In addition, the Duane plot uses a straight line which is fitted by eye to the data points. The graphical and statistical methods should be viewed as complementary techniques.

5.5.1.1 Symbols. The symbols used in the equations of the Duane Method are:

$C(t)$  = expected number of failures in (t) units of development testing  
 divided by (t)

$F(t)$  = expected number of failures in (t) units of development testing

$m$  = slope of the Duane plot

$\lambda$  = reciprocal of the ordinate of the Duane plot at (t) = 1

$\theta(t)$  = current MTBF

$r(t)$  = current failure rate

$\bar{\lambda}_i$  = average failure rate of grouped data in interval (i)

5.5.1.2 Construction of a Duane plot. The Duane plot can be constructed as specified in a through g:

a. The Duane model can be expressed in the form:

$$C(t) = \lambda t^m$$

where:

$$C(t) = \frac{F(t)}{t}$$

Since (F(t)) is the expected number of failures experienced by the system during (t) units of development testing, it can be estimated by (N(t)), the observed number of failures during (t) units. Therefore,

$$N(t)/t = \lambda t^m$$

is the observed relationship. This may be expressed as a linear relationship, suitable for plotting, by taking logarithms.

$$\ln(N(t)/t) = \ln(\lambda) - m \ln(t)$$

However, since it is easier to visualize growth as an upward sloping line, a more commonly used relationship is:

$$\ln(t/N(t)) = m \ln(t) - \ln(\lambda)$$

- b. As the testing progresses, record is kept of (t), the total units of operation accumulated among all the systems. Thus, if three systems have been tested for 100 hours each, t = 300. Record also is kept of (N(t)), the cumulative number of failures experienced during the (t) units of operation.
- c. At selected values of (t), the quantity (t/N(t)) is computed.
- d. Using full-log graph paper, the values of (t) and (t/N(t)) are plotted on the abscissa and ordinate, respectively.
- e. If the plotted points form a reasonably straight line, it can be concluded that the Duane model is a reasonable method for describing the growth pattern observed.
- f. After fitting a straight line through these points, ( $\lambda$ ) may be estimated by the reciprocal of the ordinate at (t) = 1. The parameter (m) may be estimated by the arithmetic slope of the line. Each successive point contains all the information contained in earlier points. Therefore, the most recent points should be given heaviest weight in plotting the line.
- g. An estimate may be made of the current values of MTBF ( $\theta(t)$ ) and the failure rate (r(t)), by means of the relationships:

$$\theta(t) = t^m / (1 - m)\lambda$$

and

$$r(t) = (1 - m)\lambda t^{-m}$$

Any extrapolations beyond the test period are sensitive to the assumption of using the Duane model, and make the additional assumption that the program effort is to remain constant in the ensuing period. The analysis of data from several identical systems being tested simultaneously may be complicated by the fact that design modifications may not be introduced on all systems simultaneously. This will result in a mixture of configuration ages which will make data analysis more difficult.

5.5.1.3 Example. As an example, three systems were tested simultaneously until a total of 1000 hours of operation was accumulated among the three systems. As failures occurred, appropriate design modifications were introduced on all three systems. The cumulative number

of failures encountered after selected periods of testing and the corresponding values of  $(t/N(t))$  are given below:

$t$ (hundreds of hours)	$N(t)$	$t/N(t)$
1.00	3	0.333
2.00	6	0.333
5.00	13	0.385
8.00	18	0.444
10.00	22	0.454

The values of  $(t)$  and  $(t/N(t))$  are shown plotted in FIGURE 1. The points form a reasonably straight line, suggesting that the Duane model is appropriate for describing the growth pattern observed. A straight line is then fitted through these points.

The ordinate at  $(t) = 1$  is 0.31. Therefore,  $\lambda = 1/0.31 = 3.22$ . The arithmetic slope  $m = 15$  millimeters (mm) divided by 95 mm = 0.158. This may also be determined by:

$$m = \frac{\ln(0.445) - \ln(0.310)}{\ln(10) - \ln(1)} = 0.157$$

The MTBF currently achieved at 1000 hours may be estimated as:

$$\theta(1000) = \frac{10^{+0.157}}{(1 - 0.157)(3.22)} = 0.5288 \text{ hundred hours} = 52.88 \text{ hours}$$

and the current failure rate may be estimated as:

$$\begin{aligned} r(1000) &= (1 - 0.157)(3.22) 10^{-0.157} = 1.89 \text{ failures per hundred hours} \\ &= 0.0189 \text{ failures per hour} \end{aligned}$$

The MTBF expected at 2000 hours may be estimated as:

$$\theta(2000) = \frac{20^{+0.157}}{(1 - 0.157)(3.22)} = 0.5896 \text{ hundred hours} = 58.96 \text{ hours}$$

This estimate assumes that the Duane model is valid for the growth pattern being experienced and that the program effort is to remain constant.

**5.5.1.4 Problems of plotting average failure rate.** One disadvantage of plots, such as the Duane plot which uses cumulative measures, is the fact that the most recent data tends to get buried when it is combined with all the previous data. Plotting the average failure rate of

selected intervals eliminates this problem. The lack of cumulative smoothing, however, does make the average failure-rate plot much more sensitive to sampling variation. The average failure-rate ( $\lambda_i$ ) over any time interval is the number of failures in that interval (n) divided by the total operating time in the interval ( $T_i$ ).

$$\lambda_i = \frac{n_i}{T_i}$$

The choice of intervals is arbitrary, but they should *be* small enough to reflect trends, yet large enough to afford some smoothing. The average failure rate is plotted as a horizontal line for the appropriate interval. The test results used in the previous example are grouped into intervals and the average failure rate is computed for each interval, that is:

<u>Interval (Hours)</u>	<u>n<sub>i</sub> Number of failures</u>	<u>T<sub>i</sub> (Hours)</u>	<u><math>\bar{\lambda}_i</math> (Failures/hour)</u>
0-100	3	100	0.0300
100-200	3	100	0.0300
200-500	7	300	0.0233
500-800	5	300	0.0167
800-1000	4	200	0.0200

Average failure rate over each interval is shown in FIGURE 1; however, FIGURE 2 provides a clearer picture of the trend.

**5.5.2 The AMSAA Method.** A summary of the variables used in the AMSAA model is given in TABLE II.

**5.5.2.1 Determination of trend from test data.** Prior to the use of the AMSAA method, any significant trend in the test results must be identified. Multiple systems should be analyzed on a cumulative test duration basis (time, miles, and so forth) by combining the failure data on the multiple systems, as if they were a single system, and then analyzing the data as a single system. If the period of observation ends with a failure, use the test statistic ( $\mu$ ) generated by equation 1 in TABLE III. If the failure data is time-truncated, use the test statistic ( $\mu$ ) generated by equation 2 in TABLE III. At the 10 percent (two-sided) significance level,  $\mu = 1.645$ ; therefore, if:

- a.  $\mu \leq - 1.645$ : Significant reliability growth is indicated at the 10 percent significance level and the AMSAA model can be used for estimating parameters of interest.
- b.  $\mu \geq + 1.645$ : Significant reliability decay is indicated at the 10 percent significance level. Corrective action is necessary.

- c.  $-1.645 < \mu < +1.645$ : The trend is not significant at the 10 percent significance level and additional data should be accumulated.

For values near -1.645, some growth is indicated; for values near +1.645, some decay is indicated; for values near zero, no trend is indicated. Additional testing should be considered in these marginal cases.

Other critical values of the test statistic are:

<u>Value</u>	<u>Percent level of significance (two-sided)</u>
-3.09	0.2
-2.576	1.0
-2.326	2.0
-1.960	5.0
-1.645	10.0
-1.282	20.0

In practice, higher critical values will result in more test time but will yield a higher confidence of reliability growth.

5.5.2.2 Reliability growth analysis. If significant growth is indicated, compute the appropriate parameters using the reliability growth equations selected from TABLE III. Use TABLE IV as a guide for equation selection. Note that for small sample sizes, the recommended estimate of  $(\beta)$  is the unbiased estimate,  $(\bar{\beta})$ , which is:

For failure-truncated tests, use equation 4

$$\bar{\beta} = [(N-2)/N] \hat{\beta}$$

and for time-truncated tests, use equation 8

$$\bar{\beta} = [(N-1)/N] \hat{\beta}$$

The recommended estimate of  $(\lambda)$  is  $(\bar{\lambda})$ , which is:

For failure-truncated tests:

$$\bar{\lambda} = N/X_N^{\bar{\beta}}$$

and for time-truncated tests:

$$\bar{\lambda} = N/t_0^{\bar{\beta}}$$

The goodness-of-fit of the AMSAA model to the particular test data being generated must be tested by use of the Cramer-von Mises goodness-of-fit test. First, the level of significance ( $\alpha$ ) of the test must be chosen and the critical value of the test statistic ( $C^2_M$ ) determined from TABLE V. The ( $C^2_M$ ) calculated from the observations (equations 6 and 10 in TABLE III) must then be compared to this critical value. If the statistic is less than the tabulated critical value, the AMSAA model cannot be rejected and the calculation procedure in steps a through g below can be used. If the statistic is greater than the tabulated critical value, then the AMSAA model is rejected. If the model is rejected, follow the procedures given in step h below.

- a. If the AMSAA model is appropriate, the system intensity function may be estimated as a function of time by:

$$\hat{p}(t) = \hat{\lambda} \hat{\beta} t^{\hat{\beta}-1} \quad (\text{for large samples})$$

$$\bar{p}(t) = \bar{\lambda} \bar{\beta} t^{\bar{\beta}-1} \quad (\text{for small samples})$$

The intensity function is equal to the derivative, at time (t), of the expected number of failures in the interval (0,t).

- b. Then calculate ( $\hat{p}(t)$ ) or ( $\bar{p}(t)$ ) at the end of the test (or at the point in the test at which the calculation is being made).
- c. From TABLE VI for failure-terminated test and from TABLE VII for time-terminated test, obtain the two-sided lower confidence bounds ( $L_N, Y$ ) and two-sided upper confidence bounds ( $U_N, \gamma$ ) for N failures and ( $\gamma$ ) percent confidence coefficient.
- d. Compute the interval estimate of MTBF from:

$$\frac{L_N \cdot Y}{\hat{p}(t)} \leq MTBF \leq \frac{U_N \cdot Y}{\hat{p}(t)}$$

- e. If the number of failures is 20 or more, the same percentiles may be used to construct approximate confidence bounds on the future MTBF.
- f. The MTBF is:

$$\hat{M}(t) = 1 / \hat{p}(t) \quad (\text{for large samples})$$

$$\bar{M}(t) = 1 / \bar{p}(t) \quad (\text{for small samples})$$

- g. From the confidence limits on M(t) previously calculated, the corresponding limits for (t) may be found from:

$$P_{ub} = 1 / M_{lb}$$

$$P_{lb} = 1 / M_{ub}$$

- h. A poor Cramer-von Mises fit may be caused by jumps or discontinuities in the growth pattern. A plot of the data may suggest whether a different, continuous model should be considered; or whether program changes, which may cause breaks in the growth pattern, should be investigated. When there are jumps or discontinuities in the growth pattern, the AMSAA model may be applied in a piece-wise fashion. The procedures are as described in 4.3.2.2a through 4.3.2.2g, except that the data prior to and following the time of discontinuity (D) is treated separately. Thus, the earlier data is treated as a time-truncated test, with  $T = D$  and the later data is treated separately after subtracting (D) from each observed failure time. If a two-piece AMSAA model is appropriate, the system failure rate as a function of time (t) may be estimated by:

$$\hat{\beta}(t) = \hat{\lambda}_1 \hat{\beta}_1 t^{\hat{\beta}_1 - 1} \quad 0 \leq t \leq D$$

$$\hat{\beta}(t) = \hat{\lambda}_2 \hat{\beta}_2 (t - D)^{\hat{\beta}_2 - 1} \quad t > D$$

where the parameters subscripted 1 are determined from the data prior to (D), and the parameters subscripted 2 are determined from the data after (D).

**5.5.2.3 Illustrative example.** This example illustrates how the AMSAA model can be applied to a practical situation such as the test of a single system, the reliability of which is described by a continuous function, in a time-truncated test. The test data for this example are given in TABLE VIII. The test was terminated at 1000 hours. A total of 15 failures occurred at the times indicated. TABLE VIII also lists some of the intermediate computational results which may serve to clarify the procedure. The procedure is as provided in a through j:

- a. Compute the growth parameter estimate using equation 7 of TABLE III, that is:

$$\hat{\beta} = N / [N \ln t_0 - \sum_{i=1}^N \ln(X_i)] = 15 / [15(\ln 1000) - 70.312] = 0.4504$$

- b. Calculate the scale-parameter estimate using equation 9 of TABLE III, that is:

$$\hat{\lambda} = N / t_0^{\hat{\beta}} = 15 / 1000^{0.4504} = 0.6682$$

- c. Check the goodness of fit of the AMSAA model at the 10 percent level of significance. In this case, since  $M = N - 1$  is very close to the tabulated value for  $M = 15$ , the critical value found in TABLE V is 0.169. The Cramer-von Mises statistic is calculated from the observed data using equation 10 of TABLE III, that is:

$$C_M^2 = \frac{1}{12M} + \sum_{i=1}^M \left[ \left( \frac{X_i}{t_0} \right)^{\hat{\beta}} - \frac{2i-1}{2M} \right]^2$$

where:

$$\hat{\beta} = [(N - 1)/M]\beta = [(15 - 1)/15](0.4504) = 0.4204$$

therefore:

$$C_M^2 = 1/[12(15)] + 0.01857 = 0.0241$$

Since 0.0241 is less than 0.169, the tabulated critical value, the AMSAA model cannot be rejected. If the tabulated critical values and calculated values are very close, then more exact critical values can be obtained from TABLE V by interpolation.

- d. Since the AMSAA model is appropriate the system failure rate,  $p(t)$  can be estimated for large samples, from:

$$\hat{p}(t) = \hat{\lambda} \hat{\beta} t_0^{\hat{\beta}-1}$$

- e. The failure rate at 1000 hours is:

$$\hat{p}(1000) = (0.6682) (0.4504) (1000)^{0.4504-1} = 0.0067$$

Failure rates for other values of time can also be computed.

- f. Obtain the lower confidence bound ( $L_{N,\gamma}$ ) and upper confidence bound ( $U_{N,\gamma}$ ) for 15 failures and 0.8 confidence coefficient from TABLE VII, for a time-terminated test, that is, ( $L_{N,\gamma}$ ) = ( $L_{15,0.8}$ ) = 0.614 and ( $U_{N,\gamma}$ ) = ( $U_{15,0.8}$ ) = 1.8.

- g. The interval estimate of MTBF is computed from:

$$L_{N,\gamma}/\hat{p}(t_0) \leq MTBF \leq U_{N,\gamma}/\hat{p}(t_0)$$

$$0.614 / 0.0067 \leq MTBF \leq 1.8 / 0.0067$$

$$91.6 \leq MTBF \leq 268.7$$

- h. The MTBF is computed using the following equation:

$$\hat{M}(t) = 1 / \hat{p}(1000) = 1 / 0.0067 = 149.3 \text{ hours}$$

- i. Note that the sample of 15 failures is at the margin of useability of large sample equations. As an exercise the reader should recalculate the various parameters in a through h using the small sample equations.
- j. The interval estimate for failure rate can be determined from:

$$P_{ub} = 1 / M_{lb} = 1 / 91.6 = 0.01092$$

$$P_{lb} = 1 / M_{ub} = 1 / 268.7 = 0.00372$$

**5.6 Durability/Economic Life Test.** The Critical Failure Free Operating Period (CFFOP), the Cumulative Maintenance Burden (CMB) and the Durability 'Economic Life requirements should be demonstrated during the Durability Life Test (DLT). If the contractor has proposed any preventive or scheduled maintenance events (i.e. life limited items), these are to be accomplished and verified during the DLT. The DLT should be structured as follows:

1. Test unit(s) are to represent production configurations as closely as practical.
2. The DLT is to simulate the major environmental and operational cumulative stresses which the equipment will be exposed to during its durability/economic life and which influence its failure processes. The DLT test cycle is established by deriving environmental and operational stress profiles from the actual design usage and environments. The sequence of simulated missions in the cycle should be representative of the service usage. The environmental and operational stresses include both steady and cyclic or fatigue stresses. Examples of these stresses are thermal cycling, vibration, power cycling, voltage and humidity.
3. The minimum DLT duration should be equivalent to one durability/economic lifetime. As a minimum, one unit/test article is required to complete one lifetime of testing. However, continuation of the DLT beyond the first lifetime is recommended for one or more of the following reasons:
  - a. To verify and validate corrective actions
  - b. To verify specified design margins
  - c. To verify wearout, deterioration, degradation effects of non-life-limited equipments are equal or greater to or greater than the durability/economic life.
  - d. To identify additional failure mechanisms in the wearout phase
  - e. To characterize aging effects and assure the product is not adversely affected over the durability/economic lifetime. The DLT duration is defined as the amount of equipment power on/equipment operating time and is not to be confused with chamber and/or calendar time. The DLT should simulate the required operating time of the equipment over its lifetime.

4. Because of the limitations associated with cost, schedule and test facilities, it may not be practical and/or feasible to simulate all durability/economic life stresses on a real time basis. In such cases, the test profile should exclude usage periods of benign stress to shorten test times. Additionally, time compression techniques which are justified by published technical literature or derived by the contractor through in-house experiments and testing, may be used with prior approval from the PA. The time compression techniques, if used, must be combined with the cumulative fatigue damage at durability control points (DCPs) as an approximate measure of fatigue life consumed by the application of fatigue stresses. The DCPs should be identified during the analyses and/or lower level testing in the design phase. Care should be exercised while raising stress levels in the test to achieve time compression as doing so may result in failure mechanisms which are not representative of the intended field usage.
5. All failures occurring during DLT should be analyzed and corrective action developed and verified. When a failure occurs during the DLT, the contractor may elect to stop the test and wait until the failure investigation and analysis takes place and a corrective action is identified and implemented. Another option is to repair the unit under test (e.g. by removal and replacement of the failed SRU or part) and continue the test while the failed equipment is being analyzed for the failure cause and corrective action is devised. A corrective action may consist of a design change, a part vendor change, a manufacturing process change, or a change in the process controls. Verification of a proposed corrective action is usually achieved when this corrective action is implemented and the unit under test undergoes one durability/economic life worth of testing without any failure or maintenance. Verification of a proposed corrective action, in some cases, may also be achieved by analysis, by a separate lower level test, or by a combination of both, when technical justification and rationale exist. The contract should clearly define financial responsibility and liability for changes resulting from the DLT, to include hardware retrofit changes, documentation changes, etc. Liability for deficiencies must be clearly established in the contract.
6. Required portions of environmental qualification tests may be combined with this test.
7. Post-test inspections and data evaluation should be conducted, including a complete teardown and non-destructive inspection (NDI). Destructive inspections may be required if failures are detected/suspected.
8. Provisioning for the required quantity of spares should be made during the test planning in order to facilitate smooth continuation of the DLT when failures occur which require investigation and analysis to determine the root cause, establishment of corrective action, and implementation of the corrective action into the test article.

Contractual provisions must be established to ensure availability of required test hardware.

5.7 ESS monitoring methods. Three methods for monitoring ESS are provided in 5.7.1 through 5.7.3.2.

5.7.1 Computed ESS time interval method. This method provides a technique for estimating the required ESS time to ensure that, with a prespecified high probability, all defective parts have been removed from a repairable system (see Reference 3). The required screening time (T) for each additional system which ensures with probability (p) that no defects remain in the system is:

$$\hat{T} = \frac{-\ln\left(\frac{-\ln p}{N_d}\right)}{\lambda_d}$$

where:

- p = prespecified probability that no defects remain after the screening period
- N<sub>d</sub> = expected number of defective parts in each system
- λ<sub>d</sub> = failure rate of each defective part

Further, let:

N<sub>d</sub> = (Mp) where (M) is the total number of parts in a system and (p) is the probability that any one of these parts is defective

Point estimates of (p) and (λ<sub>d</sub>) will both be biased towards making the estimate of (T) too low. Therefore, it is recommended that an upper confidence limit on (p) and a lower confidence limit on (λ<sub>d</sub>) be used. An upper (1-α) confidence limit on (p), (p̂) can be obtained by finding the smallest (p) such that:

$$\frac{(MK)!}{r!(MK-r-1)!} \int_0^{\hat{p}} -\mu^r (1-\mu)^{(MK-r-1)} d\mu \geq 1 - \alpha$$

where:

- K = total number of systems on which data are available
- r = total number of defects observed on all K systems and the left-hand side of the equation is the cumulative Beta distribution, tabulated in Reference 4.

A lower (1 - δ) confidence limit on (λ<sub>d</sub>), (λ̂<sub>d</sub>), is obtained from:

$$\hat{\lambda}_d = \frac{\chi^2_{(1-\delta); 2r}}{2 \sum_{i=1}^r t_i}$$

where:

$\chi^2_{(1-\delta); 2r}$  = the (1 -  $\delta$ )th percentile of a chi-square distribution with 2r degrees of freedom

$t_i$  = the operating time to the  $i$ th failure of the system which suffers that failure

The recommended estimate for (T), ( $\hat{T}$ ), becomes:

$$\hat{T} = \frac{-\ln\left(\frac{-\ln p}{M\bar{p}}\right)}{\hat{\lambda}_d}$$

Before data becomes available to estimate (T) or ( $\hat{T}$ ), the screening time (T) should be based on screening periods for previous similar systems and/or engineering judgment. When and if ( $\hat{T}$ ) becomes smaller than this predetermined period, the screening time should be decreased accordingly. If ( $\hat{T}$ ) greater than the original period, thought should be given to increasing the screening period. A large ( $\hat{T}$ ) is particularly meaningful, of course, if it is based on a relatively large data base, that is, on a relatively large (r).

**5.7.2 Graphical method.** In the graphical method, a plot of observed failure rate and smoothed failure rate is made and continuously updated from the data. Typically these curves will bottom out if the defective parts are removed by ESS. The ESS duration is obtained by observing when the curve becomes flat. For example, in FIGURE 3 an ESS duration of approximately 70 hours would be reasonable. For a new system, the initial ESS duration should be chosen from data on similar systems and then modified as test experience is accumulated.

**5.7.3 Standard ESS.** Standard ESS verifies that production workmanship, manufacturing processes, quality control procedures, and the accumulation of design changes do not degrade the reliability which was originally found to be acceptable by the RQT. This ESS procedure should be applied to all production equipment of the system being evaluated. The equipment should be operating when placed under the specified environmental stress. Additional details are provided in Reference 5. All items should be subject to a sequential series of stress cycles consisting of thermal or vibration stress cycles or a combination of both. Typically, each equipment should be stressed until a minimum of one failure-free interval is attained. The procuring activity may suggest the number of cycles, cycle characteristics, and a failure-free period (time or cycles).

ESS can also be used as an effective screening method during development and during depot repair. After repairs have been completed, the screening should be restarted at the beginning of the next cycle.

5.7.3.1 **Thermal stress.** A typical thermal stress cycle is shown in FIGURE 4. The cycle should be selected from a range of temperatures between - 54°C to + 85°C. The number of thermal cycles used should range from 6 to 10, where 8 is considered as a reasonable value for many equipments. Historical data indicates that more complex equipments require more thermal cycles. Six cycles appear to be adequate for black boxes of about 2000 parts while 10 cycles may be required for equipment containing 4000 or more parts. A suggested range of thermal cycles to be applied is:

<u>Complexity</u>	<u>Thermal cycles</u>
Simple (100 electronic parts)	1
Moderately complex (500 electronic parts)	3
Complex (2000 electronic parts)	6
Very complex (4000 electronic parts)	10

Historical data indicates that thermal soaks do not contribute significantly to the screening effectiveness. Therefore, the dwell times at high and low temperatures need to be only long enough for internal temperatures to stabilize. It follows that each successive thermal ramp should be started soon after the internal part temperatures have stabilized within 2°C of the specified temperature and all required functional tests have been completed. The temperature rate of change of internal parts should fall within 5°C and 20°C per minute. The best screening results will be achieved by using the maximum safe range of chamber temperatures and the greatest practicable temperature rate of change of internal parts. The equipment undergoing ESS should be energized and operated during thermal cycling (within the specified operating temperature range), but it may be turned off during chamber cool-down to permit the temperature of internal parts to decline more rapidly. Equipment performance should be monitored continuously, but if cost or other constraints do not permit this, periodic checks and continuous monitoring of the final cycle should be required.

5.7.3.2 **Vibration stress.** The standard vibration stress spectrum is shown in FIGURE 5. The stress is a random vibration which should be applied for at least 10 minutes if the direction of vibration is to be along a single axis. When vibration along more than one axis is required, the random vibration stress should be applied for at least 5 minutes along each axis. The equipment should be hard-mounted to the shake table so that the direction of vibration is perpendicular to the plane of the printed circuit boards (PCBs). If the equipment has PCBs oriented in more than one plane, the equipment should be vibrated sequentially along each of three orthogonal axes. The tolerance for the random vibration spectrum should be + 3 decibels (dB). Notching at resonant frequencies is permitted.

5.8 **MTBF assurance test.** The MTBF assurance test (see Reference 6) can be used to provide assurance that any minimum MTBF level, such as the lower test MTBF, is achieved in addition to providing assurance that early defect failures have been eliminated. The test is

conducted in combination with an ESS which removes the early defects. The procedure commences with the ESS which is terminated after some number of hours determined by the methods previously described. After the ESS is terminated, the system enters the MTBF assurance test, which is to be conducted under mission profile environments. The procedure is designed to permit changes in the failure-free interval (test window) (W) if warranted by the test data. This test can be used on production equipment which has passed qualification tests and can provide the producer with a high probability of success. In the MTBF assurance test, the system must operate for a specified number of test hours without failure (failure-free requirement) within an interval (test window) (W) of specified length. Generally, the test window is chosen to give the seller a very high probability of passing the test (for example, 98 percent), if the equipment actually does satisfy the minimum MTBF level. The probability of a unit passing, (Ps), is:

$$P_s = \frac{(M - 1)^r (M + W - r)}{M^{r+1}}$$

where:

- M = Minimum MTBF level, hours
- W = test window, hours ( $r \leq W \leq 2r$ )
- r = failure-free interval, hours

Because of the large numbers involved, direct exponentiation and multiplication result in numbers which exceed the ranges of hand-held calculators, therefore, this calculation must be performed using logarithms, that is:

$$\log P_s = r \log(M - 1) + \log(M + W - r) - (r + 1) \log M$$

An analysis of these equations indicated that the best value of the test window (W) was twice the failure-free interval, (r).

If the ratio of (W) to (r) is less than two, there exists an interval within the test during which one equipment failure would immediately terminate the test in failure. This results in degraded statistical confidence in the result. Increasing the ratio of (W) to (r) beyond two, increases the test time without significantly improving the statistical confidence. Therefore, the optimal ratio of test window length to failure-free requirement is 2. FIGURES 6 and 7 present a graph of (Ps) versus (M) with  $W = 2r$  for a range of failure-free intervals of 10 hours to 150 hours. Using the above equation and letting  $W = 2r$ , the failure-free interval, and, consequently, the test window, can be computed for any desired (Ps).

For example, if  $P_s = 0.98$ , the equation yields:

$$0.98 = \frac{(M - 1)^r (M + r)}{M^{r+1}}$$

Solving numerically for (r) in terms of (M) yields the empirical relation:

$$r = 0.212M$$

As another example, for an arbitrary M = 150 hours and r = 10 hours, the probability of acceptance is Ps = 0.9976.

**5.8.1 Derivation of equation.** The MTBF assurance test equation is derived as provided in a through g:

- a. Break up the test into one-hour intervals; therefore, the probability of a success in any one hour interval is approximately:

$$\rho_s = e^{-1/M} = e^{-1/M} = 1 - 1/M$$

and the probability of failure is:

$$\rho_f = 1/M$$

- b. The condition for passing the test is (r) hours (r successes) of failure-free operation.  
 c. This can occur if (r) successes (r consecutive hours) are achieved without incidence of failure, that is:

$$(\rho_s)^r = (1 - 1/M)^r$$

- d. Furthermore, the test can be passed if following a failure, (r) successes are obtained. We are unconcerned with the previous failure history prior to the last failure, that is:

$$\rho_f(\rho_s)^r = (1/M) (1 - 1/M)^r$$

- e. This can occur (r) times within the test window (W), before the test is failed and sufficient failure-free time can no longer be accumulated.  
 f. Therefore  $(\rho_f)(\rho_s)^r$  can occur (r) times.  
 g. Therefore the total probability of acceptance is given by:

$$\begin{aligned}
 P_s &= p_s^r + (r)(p_f)(p_s)^r \\
 &= (1 - 1/M)^r + r(1/M)(1 - 1/M)^r \\
 &= (1 - 1/M)^r (1 + r/M) \\
 &= \left(\frac{M-1}{M}\right)^r \left(\frac{M+r}{M}\right) \\
 &= \frac{(M-1)^r (M+r)}{M^r M} \\
 &= \frac{(M-1)^r (M+r)}{M^{r+1}}
 \end{aligned}$$

5.8.2 **Procedure.** Using the relationships given in 5.8, the procedure provided in a through m can be used:

- a. Based on historical data with similar equipment, select an ESS duration using the methods in 5.5.
- b. For the desired ( $P_s$ ) and MTBF ( $\theta$ ), determine the failure-free interval from FIGURES 6 and 7
- c. The test window,  $W = 2r$ .
- d. Run the MTBF assurance test on each equipment with the parameters in a, b, and c, until the failure-free interval of ( $r$ ) hours is obtained in the test window, ( $W$ ).
- e. Accumulate the times of failure on each unit (serial number) of equipment tested and use the AMSAA model to compute current MTBF on the accumulated data and on the data for each individual system (or some group of latest units).
- f. Continue testing until a time of 10 MTBF is accumulated.
- g. If the test data indicates a computed MTBF in the vicinity of the desired MTBF, continue testing using the same failure-free interval and test window.
- h. If the most recent data indicates a significant decrease in MTBF (reliability deterioration), consider increasing the failure-free interval and test window.
- i. If the most recent data indicates a significant increase in MTBF (reliability improvement), consider decreasing the failure-free interval and test window.
- j. There is no simple method of determining, a priori, the number of latest units whose data should be combined when computing the MTBF which is to be compared against the original MTBF. The MTBF attained by each unit tested and the overall MTBF should be calculated and graphed and the results monitored continuously.

- k. If the use of a larger failure-free interval and test window results in an improvement in MTBF, these parameters (interval and test window) can eventually be reduced to the original values.
- l. If the use of a smaller failure-free interval and test window results in a deteriorated MTBF, these parameters (interval and test window) can be increased to the original values.
- m. This iterative procedure can be repeated as the test proceeds and is especially useful for equipment with large production runs.

5.9 Sequential test plans. The sequential test plans are based on the assumption that the underlying distribution of times-between-failures is exponential. A set of standard PRST have found wide applicability in the testing of electronic equipment. Six basic test plans (I-D through VI-D) are provided. The true decision risks and discrimination ratios (d) for these are:

<u>Test Plan</u>	<u>True risks</u>		<u>Discrimination ratio</u>
	$\alpha$	$\beta$	d
I-D	11.5	12.5	1.5
II-D	22.7	23.2	1.5
III-D	12.8	12.8	2.0
IV-D	22.3	22.5	2.0
V-D	11.1	10.9	3.0
VI-D	18.2	19.2	3.0

In addition, two short-run, high-risk test plans (VII-D and VII I-D) are provided. These test plans can be used on programs in which test time must be curtailed as a result of overriding schedule and cost factors. The true decision risks and discrimination ratios for these plans are:

<u>Test Plan</u>	<u>True risks</u>		<u>Discrimination ratio</u>
	$\alpha$	$\beta$	d
VII-D	31.2	32.8	1.5
VIII-D	29.3	29.9	2.0

The accept-reject criteria for the standard sequential test plans are shown graphically and in tabular form along with the corresponding operating characteristic (OC) curves and the expected test time curves which are based on assumed values of true MTBF. All of these data are grouped by test plan in FIGURES 9 through 16. A procedure for computing upper and lower confidence limits on MTBF for tests which are terminated by acceptance or rejection is also provided in Reference 7. Finally, the Program Manager's assessment described in 5.9.8 provides a means to assess the effective consumer's risk at any point in time during a sequential test.

5.9.1 **Symbols.** The symbols used in the equations of 4.6 are:

- $a$  = producer's risk
- $\beta$  = consumer's risk
- $\theta$  = MTBF
- $\theta_1$  = lower test MTBF
- $\theta_0$  = upper test MTBF
- $r$  = accumulated failures in time (t)
- $r_0$  = failures at truncation
- $T_0$  = truncation time
- $t_{A_i}$  = standardized acceptance time
- $t_{R_i}$  = standardized rejection time
- $O'_U(\gamma, I)$  = standardized upper confidence limits
- $O'_L(\gamma, i)$  = standardized lower confidence limits
- $O_U(\gamma, i)$  = upper confidence limit
- $O_L(\gamma, i)$  = lower confidence limit

5.9.2 **Application.** Standard PRST plans should be applied when a sequential test with normal (10 percent to 20 percent) producer's and consumer's risk is desired. Short-run, high-risk PRST plans may be used when a sequential test plan is desired, but test time is limited and both the producer and the consumer are willing to accept relatively high decision risks. PRST plans will accept material with a high MTBF or reject material with a very low MTBF more quickly than fixed-duration test plans having similar risks and discrimination ratios. Total test time may vary significantly; therefore, program cost and schedule must be planned to truncation. The Program Manager's assessment in 5.9.8 provides a means to assess the effective consumer's risk at any point in time during a sequential test.

5.9.3 **Theoretical background.** The concept of sequential tests was developed by I. Wald (see Reference 8) and B. Epstein (see Reference 9), and is also discussed by I. Bazovsky (see Reference 10). For an exponential equipment with an unknown MTBF of ( $\theta$ ), the probability of failing ( $r$ ) times in an accumulated operating time (t) is:

$$P(r) = \left(\frac{t}{\theta}\right)^r \left(\frac{e^{-t/\theta}}{r!}\right)$$

The sequential test must prove that  $(\theta)$  is at least equal to or greater than the lower test MTBF  $(\theta_1)$ . If the true MTBF is exactly equal to the lower test MTBF the probability of failing  $(r)$  times in the operating time  $(t)$  is:

$$P_1(r) = \left(\frac{t}{\theta_1}\right)^r \left(\frac{e^{-t/\theta_1}}{r!}\right)$$

In order to structure the sequential test an upper test MTBF,  $(\theta_0)$ , must also be selected. If the equipments MTBF were equal to  $(\theta_0)$  the probability of  $(r)$  failures in the interval  $(t)$  would be:

$$P_0(r) = \left(\frac{t}{\theta_0}\right)^r \left(\frac{e^{-t/\theta_0}}{r!}\right)$$

Now form the probability ratio:

$$P(r) = \frac{P_1(r)}{P_0(r)} = \left(\frac{\theta_1}{\theta_0}\right)^r e^{-t((1/\theta_1) - (1/\theta_0))}$$

This ratio is computed continuously during the test and compared to two predetermined constants (A) and (B), using the decision rules of a through c:

- a. If  $P(r)$  becomes  $< B$ , accept and stop testing.
- b. If  $P(r)$  becomes  $> A$ , reject and stop testing.
- c. If  $B < P(r) < A$ , continue testing.

The constants (A) and (B) are:

$$A = \frac{(1 - \beta)(d + 1)}{2\alpha d}$$

$$B = \frac{\beta}{(1 - \alpha)}$$

where:

a = producer's risk

$\beta$  = consumer's risk

$d$  = discrimination ratio

The graphical sequential test procedure is derived as follows:

The term for (A) contains the correction factor  $(1 + d)/2d$  which is found in Reference 9. This factor substantially reduces the differences between actual and achieved consumer's and producer's risks which arise because of test truncation. The original sequential test derivations do not account for the effect of truncation on the risks.

Starting with:

$$B < \left(\frac{\theta_0}{\theta_1}\right)^r e^{-[(1/\theta_1) - (1/\theta_0)]t} < A$$

Take the natural logarithms:

$$\ln B < r \ln(\theta_0/\theta_1) + (1/\theta_0 - 1/\theta_1)t < \ln A$$

Transform this inequality by dividing all terms by  $\ln(\theta_0/\theta_1)$  after adding  $(1/\theta_1 - 1/\theta_0)t$  to each term. This results in:

$$\frac{\ln B}{\ln(\theta_0/\theta_1)} + \frac{(1/\theta_1 - 1/\theta_0)t}{\ln(\theta_0/\theta_1)} < r < \frac{\ln A}{\ln(\theta_0/\theta_1)} + \frac{(1/\theta_1 - 1/\theta_0)t}{\ln(\theta_0/\theta_1)}$$

As long as the numerical value of (r) is between the values of the left and right side of the inequality, the test continues. If (r) becomes equal to or less than the left side, the test terminates in an accept decision. When (r) becomes equal to or greater than the right side, the test terminates in a reject decision. The expressions on both sides of the inequality are equations of two parallel straight lines; thus, the inequality can be written as:

$$a + bt < r < c + bt$$

When these two lines are plotted on graph paper with (t) (cumulative test time) as the abscissa and (r) (number of failures) as the ordinate, the constants (a and c) are the intercepts of these lines with the ordinate and (b) is the slope.

The numerical computation of a, c, and b is given by:

$$a = \frac{\ln B}{\ln(\theta_0/\theta_1)}$$

$$c = \frac{\ln A}{\ln(\theta_0/\theta_1)}$$

$$b = \frac{(1/\theta_1 - 1/\theta_0)}{\ln(\theta_0/\theta_1)}$$

From this, the two parallel lines can be plotted on graph paper in an (r - t) coordinate system. By drawing a horizontal line at (r = r<sub>0</sub>) and a vertical line at (t = T<sub>0</sub>), the test is truncated.

**5.9.4 Test truncation.** The sequential tests provided in this handbook are all truncated tests because of the practical requirements of real-world test programs. The method for truncating a sequential test was developed in the paper written by B. Epstein and M. Sobel (see Reference 9).

The appropriate value of (r) is the smallest integer that can be used so that:

$$\frac{X^2_{(1-\alpha); 2r}}{X^2_{\beta; 2r}} \geq \frac{\theta_1}{\theta_0}$$

where  $X^2_{(1-\alpha); 2r}$ , and  $X^2_{\beta; 2r}$  are the chi-square variables with (2r) degrees of freedom. Tables of the chi-square distribution can be found in Reference 11. These two values are found by simultaneously searching the (1 - α) and β probabilities of the chi-square tables until the ratio of the variables is equal to, or greater than, θ<sub>1</sub>/θ<sub>0</sub>. When this point is found, the degrees of freedom are set equal to (2r). The value of (r) is always rounded to the next highest integer.

This value is (r<sub>0</sub>). From this, the maximum time (T<sub>0</sub>) can be found.

$$T_0 = \frac{\theta_0 X^2_{(1-\alpha); 2r_0}}{2}$$

**5.9.5 Sequential test example.** A PRST plan may be generated analytically for any given (α), (β), (θ<sub>1</sub>), and (θ<sub>0</sub>). The procedure is straight forward and can be easily implemented with a hand-held calculator. For example, given the following input data:

$$\begin{aligned} \alpha &= 0.10 \\ \beta &= 0.10 \\ \theta_1 &= 100 \text{ hours} \\ \theta_0 &= 200 \text{ hours} \end{aligned}$$

Determine the discrimination ratio, accept-reject criteria, truncation points, and the slope and ordinate intercepts of the test plan curves. Plot the test plan. The solution proceeds as specified in a through e:

$$d = \frac{\theta_0}{\theta_1} = \frac{200}{100} = 2$$

a. Discrimination ratio =

$$b. \quad A = \frac{(d+1)(1-\beta)}{2ad} = \frac{(2+1)(1-0.10)}{2(2)(0.10)} = 6.75$$

$$c. \quad B = \frac{\beta}{1-\alpha} = \frac{0.10}{1-0.10} = 0.111$$

d. Compute the points of truncation as follows: Search the chi-square tables at the upper confidence  $(1 - \alpha)$  and  $(\beta)$  upper percentage points until a point is reached at which:

$$\frac{\chi^2_{(1-\alpha); 2r}}{\chi^2_{\beta; 2r}} \geq \frac{\theta_1}{\theta_0}$$

or

$$\frac{\chi^2_{0.9; 2r}}{\chi^2_{0.1; 2r}} \geq 0.5$$

This point occurs at 29 degrees of freedom where:

$$\frac{\chi^2_{0.9; 2r}}{\chi^2_{0.1; 2r}} = \frac{19.763}{39.087} = 0.506$$

therefore:

$$2r = 29$$

$$r = 14.5$$

$$r_0 = 15 \text{ failures}$$

and since:

$$\bar{T}_0 = \frac{\theta_0 X^2_{(1-a); 2r}}{2}$$

$$T_0 = \frac{200(20.6)}{2}$$

$$T_0 = 2060 \text{ hours}$$

The test, therefore, should not last longer than 15 failures, or 2060 hours.

e. Determine the slope and ordinate intercepts of the two parallel straight lines:

$$a = \frac{\ln B}{\ln(\theta_0/\theta_1)} = \frac{\ln 0.111}{\ln 2} = \frac{-2.198}{0.693} = -3.17$$

$$b = \frac{(1/\theta_1 - 1/\theta_0)}{\ln(\theta_0/\theta_1)} = \frac{(0.01 - 0.005)}{\ln 2} = 0.00721$$

$$c = \frac{\ln A}{\ln(\theta_0/\theta_1)} = \frac{\ln 6.75}{\ln 2} = \frac{1.910}{0.693} = 2.75$$

These values are plotted in FIGURE 8.

**5.9.6 Standard PRST accept-reject criteria and OC curves.** FIGURES 9 through 16 present the accept-reject criteria for the Standard PRST plans and the OC and Expected Test Time (ETT) curves for Test Plans I-D through VII I-D. The OC curves plot values of probability of acceptance versus the true MTBF expressed in multiples of  $(\theta_1)$  and  $(\theta_0)$ . The ETT curve plots values of expected test time versus time MTBF expressed in multiples of  $(\theta_1)$  and  $(\theta_0)$ .

**5.9.7 Confidence limits for sequential tests.** This method for estimating confidence limits can be used to estimate the confidence limits on MTBF at the completion of the sequential tests described in Test Plans I-D through VIII-D. Tables of confidence limits on the true MTBF are given in TABLES 9A and 9B and 10A and 10B. Acceptance can occur only at discrete times, while rejection can occur at any time after the required number of failures has occurred. Therefore, confidence limits after acceptance and rejection must be computed separately. TABLES 9A and 9B present confidence limits at acceptance and TABLES 10A and 10B present confidence limits at rejection. Define  $(t_{A_i})$  as the standardized acceptance time, so that an equipment is accepted if not more than  $(i)$  failures occur in  $(t_{A_i})$  hours. Define  $(t_{R_i})$  as the standardized rejection time, so that equipment is rejected if at least  $(i)$  failures occur at or before  $(t_{R_i})$  hours. Together,  $(t_{A_i})$  and  $(t_{R_i})$  are the standardized termination times. The actual termination times are obtained by multiplying the standardized termination times by  $\theta_1$ . The standardized lower test MTBF is assumed to equal 1.

5.9.7.1 Confidence limits at acceptance. TABLE IXA presents conservative  $(1 - \gamma)$  100 percent standardized lower confidence limits  $(\theta^1_{L(\gamma,i)})$  and  $(1 - \gamma)$  100 percent standardized upper confidence limits  $(\theta^1_{U(\gamma,i)})$  on the MTBF for all tests terminated by an accept decision using Test Plans I-D through VIII-D for  $\gamma = .5, .3, .2, .1, .05$ . A conservative two-sided  $(1 - 2\gamma)$  100 percent standardized confidence interval is  $(\theta^1_{L(\gamma,i)}, \theta^1_{U(\gamma,i)})$ . Actual limits and intervals are obtained by multiplying  $(\theta^1_{L(\gamma,i)})$  and  $(\theta^1_{U(\gamma,i)})$  by the lower test MTBF  $(\theta_1)$ . That is:

$$\theta'_L(\gamma,i) = \theta_1 \theta^1_{L(\gamma,i)}$$

$$\theta'_U(\gamma,i) = \theta_1 \theta^1_{U(\gamma,i)}$$

5.9.7.1.1 Example: black box X. The following example is based on a production reliability acceptance test of a black box X for an aircraft. The example can be stated as follows:

The Government agrees to accept a monthly production lot of 40 units with probability  $1 - \alpha = 0.8$ , if the true MTBF  $\theta_0 = 100$  hours and will reject the lot with probability  $1 - \beta = 0.8$ , if the true MTBF  $\theta_1 = 50$  hours. The designated risks are thus  $\alpha = \beta = 0.2$ , and the discrimination ratio (d) =  $100/50 = 2$ . Consequently, Test Plan IV-D must be used. The required minimum sample size is three units. From FIGURE 12, the lot is accepted with 0 failures after  $t_{A0} \theta_1 = 2.8 \times 50$  hours = 140 hours, or with 1 failure after  $t_{A1} \theta_1 = 4.18 \times 50$  hours = 209 hours, and soon, since  $t_{A0} = 2.8$ ,  $t_{A1} \theta_1 = 4.18$ , and so forth, are the standardized acceptance times. Assume in the actual test that relevant failures occurred at 50 hours, 90 hours, 120 hours, 250 hours, and 390 hours of accumulated test time. The accept and reject times at each of the failures determined from FIGURE 12 are as follows:

<u>Number of failures</u>	<u>Reject time</u>	<u>Accept time</u>	<u>Actual time</u>
0	-	$2.80 \times 50 = 140$	-
1	-	$4.18 \times 50 = 209$	50
2	$0.7 \times 50 = 35$	$5.58 \times 50 = 279$	90
3	$2.08 \times 50 = 104$	$6.96 \times 50 = 348$	120
4	$3.46 \times 50 = 173$	$8.34 \times 50 = 417$	250
5	$4.86 \times 50 = 243$	$9.74 \times 50 = 487$	390

This data indicates that the total accumulated times at 1, 2, 3, 4, and 5 failures do not lead to rejection, and the lot is accepted with 5 failures after  $9.74 \times 50$  hours = 487 hours total test time ( $t_A = 9.74$ , therefore  $T_A = 9.74 \times \theta$ ). Suppose that an 80 percent lower confidence limit on the MTBF is desired. First find the conservative 80 percent standardized lower confidence limit  $\theta^1_{L(\gamma, i)} = \theta^1_{L(0.2,5)} = 1.0459$  from the appropriate entry for Test Plan IV-D in TABLE IXA for  $\gamma = 0.2$  and 5 failures. A conservative 80 percent lower confidence limit on the MTBF is  $1.0459 \times \theta_1$  or  $1.0459 \times 50 = 52.3$  hours. Similarly, a conservative 80 percent upper confidence limit on the MTBF from TABLE IXB is  $\theta^1_{U(\gamma, i)} \times \theta_1 = 2.5225 \times 50 = 126.1$  hours, where  $\theta^1_{U(0.2,5)} = 2.5225$  comes from TABLE IXB for  $\gamma = 0.2, i = 5$ .

**5.9.7.2 Confidence limits at rejection.** TABLES XA and XB present exact  $(1-\gamma)$  100 percent standardized lower confidence limits  $(\theta^1_L(\gamma,t))$  and  $(1-\gamma)$  100 percent standardized upper confidence limits  $(\theta^1_U(\gamma,t))$  on the MTBF for Test Plans I-D through VIII-D terminated by a reject decision for selected values of the standardized time  $(t)$  and  $\gamma = .5, .3, .2, .1, .05$ . A test may be terminated by a reject decision at any time  $(t)$ , once a required number of failures has occurred. Therefore, it is impossible to tabulate confidence limits for all possible outcomes. Use linear interpolation for nontabulated values of standardized  $(t)$  where  $(t)$  equals the actual total test time  $(T)$  divided by the lower test MTBF  $(\theta_1)$  or in special cases, use the  $X^2$  distribution for exact limits. Consider the case where rejection of equipment occurs after  $(t\theta_1)$  hours of total test time. If  $(t)$  exceeds the smallest value in TABLE XA, the  $(1 - \gamma)$  100 percent lower confidence limit can be calculated as specified in a through c:

- a. From TABLE XA obtain  $(\theta^1_L(\gamma,t_1))$  and  $(\theta^1_L(\gamma,t_2))$  such that  $\{t_1\} < t < \{t_2\}$  and  $\{t_1\}$  is the largest table time less than  $t$  and  $\{t_2\}$  is the smallest table time greater than  $t$ .
- b. By simple interpolation find:

$$\theta^1_L(\gamma,t) = \theta^1_L(\gamma,t_1) + (\theta^1_L(\gamma,t_2) - \theta^1_L(\gamma,t_1)) (t - t_1) / t_2 - t_1$$

- c. The actual  $(1 - \gamma)$  100 percent lower confidence limit on the MTBF based on a rejection after  $(t\theta^1)$  hours then

$$\theta_L(\gamma,t) = \theta_1 \theta^1_L(\gamma,t)$$

If  $(t)$  is smaller than the smallest value in TABLE XA use the relationship between the  $X^2$  and the Poisson distributions to calculate the  $(1 - \gamma)$  100 percent standardized lower confidence limit on the MTBF as follows:

$$\theta^1_L(\gamma,t) = 2t / X^2_{1-\gamma, 2i}$$

where  $X_{(1-\gamma), 2i}$  is the  $(1 - \gamma)$  100th percentile of the  $X^2$  distribution with  $(2i)$  degrees of freedom, and  $(i)$  is the number of failures which lead to rejection at time  $(t\theta_1)$

Then:

$$\theta_L(\gamma,t) = \theta_1 \theta^1_L(\gamma,t)$$

Similarly calculate a  $(1 - \gamma)$  100 percent standardized upper confidence limit  $(\theta^1_U(\gamma,t))$  on MTBF by interpolation if  $(t)$  exceeds the smallest value in TABLE XB.

If  $t$  is smaller than the smallest value in TABLE XB, use:

$$\theta_U(\gamma, t) = 2t/\chi_{\gamma, 2i}^2$$

where  $\chi_{\gamma, 2i}^2$  is the  $\gamma$  100th percentile of the  $X^2$  distribution with  $(2i)$  degrees of freedom. A  $(1 - 2\gamma)$  100 percent confidence interval on the MTBF for a test terminated by rejection after  $(t\theta_1)$  hours is

$$\langle \theta_L, \theta_U \rangle = \theta_1 \theta_U(\gamma, t)$$

5.9.7.2.1 Example: black box X. Suppose that in the previous example failures occurred after 50 hours, 90 hours, 120 hours, and 150 hours total test time.

The accept and reject times at each of the failures are determined from FIGURE 12 as follows:

<u>Number of failures</u>	<u>Reject time</u>	<u>Accept time</u>	<u>Actual time</u>
0	-	$2.80 \times 50 = 140$	-
1	-	$4.18 \times 50 = 209$	50
2	$0.7 \times 50 = 35$	$5.58 \times 50 = 279$	90
3	$2.08 \times 50 = 104$	$6.96 \times 50 = 348$	120
4	$3.46 \times 50 = 173$	$8.34 \times 50 = 417$	150

From these tabulated values it can be seen that Test Plan IV-D does not require rejection after 1, 2, or 3 failures, nor acceptance before 150 hours. However, the lot is rejected after the fourth failure (that is, 150 hours) since it occurs before  $t_{R4} \times \theta_1 = 3.46 \times 50 = 173$  hours. The value  $t_{R4} = 3.46$  is taken from FIGURE 12. An 80 percent lower confidence limit on the MTBF is calculated as specified in a and b:

- a. First find  $\theta_L^1(\gamma, t) = \theta_L^1(0.2, 3)$  where  $t = T/\theta_1 = 150/50 = 3$ . In TABLE XA,  $t_1 = 2.80$  with  $\theta_L^1(0.2, 2.8) = 0.5646$  and  $t_2 = 3.46$  with  $\theta_L^1(0.2, 3.46) = 0.6644$ . Using the equation in 4.6.7.2b, calculate  $\theta_L^1(0.2, 3) = 0.595$  by interpolation. An 80 percent lower confidence limit on the MTBF given a rejection after  $3 \times \theta_1 = 150$  hours is  $\theta_L^1(0.2, 3) \times \theta_1 = 0.595 \times 50 = 29.7$  hours.
- b. Similarly, calculate an 80 percent upper confidence limit. From TABLE XB obtain  $\theta_U^1(0.2, 2.8) = 1.5517$  and  $\theta_U^1(0.2, 3.46) = 1.7379$ , giving  $\theta_U^1(0.2, 3) = 1.608$ . An upper confidence limit on the MTBF given a rejection after 150 hours is  $\theta_U^1(0.2, 3) \times \theta_1 = 1.608 \times 50 = 80.4$  hours.

5.9.8 Sequential tests: Program Manager's assessment. The Program Manager's assessment provides a means for the Government to assess the consumer's risk at any point in time during a sequential test. This is especially important in cases where program time and schedule pressures may force the Program Manager to consider an early termination of the test.

5.9.8.1 **Procedure.** The Program Manager's assessment can be implemented using the procedure specified in a through d:

- a. At the point where the test is halted, compute the probability ratio:

$$p(r) = (\theta_0/\theta_1)^r e^{-[(1/\theta_1) - (1/\theta_0)]t}$$

where:

$\theta_0$  = upper test MTBF

$\theta_1$  = lower test MTBF

$r$  = number of failures

$t$  = test halt time

- b. Set  $p(r) = (1 - \beta)/\alpha$

where:

$\beta$  = consumer's risk

$\alpha$  = producer's risk

- c. Compute the new value of  $\beta = \beta^1$ , from the equation in step b at the same (CE) level.  
 d.  $\beta^1$  is an effective consumer's risk at any time, (t).

This procedure should be used exclusively by the Program Manager. If the test appears to be heading towards an early reject, the Program Manager should not allow the test to be halted. If the test appears to be heading towards an early acceptance the Program Manager may permit an early acceptance if the value of consumer's risk is not seriously increased. The final decision can only be made after the costs of additional testing are weighed against the increased risks of early acceptance.

5.10 **Fixed-duration tests.** Fixed-duration tests offer a distinct advantage for program planning, namely, prior knowledge of test duration which permits program planners to perform trade-off studies between test duration, consumer's and producer's risk, ( $\theta_0$ ) and ( $\theta_1$ ). See the discussion in Reference 10.

5.10.1 **Symbols.** The following symbols are used in the equations defining fixed-duration test plans discussed in 5.10:

- T = test termination time
- k = number of failures
- a = accept number
- r = reject number
- c = confidence
- T<sub>j</sub> = accept time if (j) failures have occurred to that time

Four different categories of fixed-duration tests must be considered depending on whether the test is time terminated or failure terminated, and whether the test is conducted with or without replacement of failed units. In the case of fixed-duration, time-terminated tests conducted with replacement, the termination time, (T), and the accept (a) and reject (r) numbers, can be determined from two equations:

$$1 - \beta = \sum_{k=a+1}^{\infty} \frac{(T/\theta_1)^k e^{-T/\theta_1}}{k!}$$

$$\alpha = \sum_{k=r}^{\infty} \frac{(T/\theta_0)^k e^{-T/\theta_0}}{k!}$$

The right-hand expression of each equation is an upper tail cumulative Poisson which can be evaluated with appropriate tables (see Reference 10) or with some programmable pocket calculators. Some Poisson tables provide only the lower tail cumulative terms, in which case the equations may be rewritten as:

$$\beta = \sum_{k=0}^a \frac{(T/\theta_1)^k e^{-T/\theta_1}}{k!}$$

$$1 - \alpha = \sum_{k=0}^{r-1} \frac{(T/\theta_0)^k e^{-T/\theta_0}}{k!}$$

Note that the accept (a) number is related to the reject (r) number by a = r - 1 to ensure that the test reaches a decision in the allotted test time. This relationship between (a) and (r) means that the solution of the pair of defining equations used must be obtained by an iterative process. The minimum possible test time can be found in the accept equation by substituting a = 0 and the appropriate values for β and θ<sub>1</sub>. However, this value of (T) substituted in the reject equation, together with θ<sub>1</sub> and r = 1, will normally yield a value of (α) which is too large, indicating that (T) is too small. The value of (α) is increased by 1, again solving for (T). This value of (T) and the new r = a + 1 are then substituted in the equation for (α); this process is repeated until the value of (α) is less than, or equal to, the required (α). The values of (T, a, and r) in this final calculation constitute the decision rule for the desired plan.

5.10.2 Example problem. Assume that a plan with  $\alpha = \beta = 0.2$  and  $d = 2$  is required to test for  $\theta_1 = 500$  hours. Using the cumulative Poisson table in Reference 11 to solve the equation for  $1 - \beta$  with  $a = 0, (1 - \beta) = 0.80$ , and  $\theta_1 = 500$ , a value of 1.60 or 800 hours is obtained. Substituting  $T = 800, r = 1$ , and  $\theta_0 = 1000$  in the equation for  $(\alpha)$  yields  $\alpha = 0.55$ . Since this is too large,  $a$  is increased to 1 for which  $T$  is  $3.0 \theta_1$  or 1500 hours. Using  $T = 1500$  hours,  $r = 2$ , and  $\theta_0 = 1000$  in the equation for  $(\alpha)$  results in  $\alpha = 0.44$ , which is still too large. Continuing this process, it is finally determined that  $a = 5, r = 6$ , and  $T = 7.8 \theta_1$ , or 3900 hours. This will produce an  $\alpha = 0.2$  so that the test decision rule is  $T = 3900, a = 5, r = 6$ , or test for 3900 hours: accept if 5 or less failures are observed, and reject if 6 or more failures are observed (see FIGURE 17).

5.10.3 Standard fixed-duration test plans and OC curves. Twelve of the most frequently used or standard Test Plans IX-D to XVI I-D and XIX-D to XXI-D are summarized in TABLES XI and XII, respectively. These plans provide a considerable range of alternatives for test construction. The corresponding OC curves are shown in FIGURES 23 to 34. The Poisson formula for computing the OC curves is repeated below:

$$P(\theta) = \sum_{k=0}^{r-1} \frac{(T/\theta)^k}{k!} e^{-T/\theta}$$

where:

$P(\theta)$  = probability of accepting items with an MTBF of  $\theta$

$r$  = critical (reject) number of failures

$T$  = test termination time

The quantity  $(r)$  is determined so that:

$$P(\theta_0) \geq 1 - a \text{ and } P(\theta_1) \geq \beta$$

5.10.4 Alternative fixed-duration test plans. The alternative plans provide a comprehensive set of fixed-duration plans for 10 percent, 20 percent, and 30 percent consumer's risk ( $\beta$ ), covering a wide range of test times. These plans are presented in FIGURES 18 through 20.

5.10.4.1 Derivation of alternative plans. In order to derive a fixed-duration test plan from these figures, choose the consumers risk ( $\beta$ ) and turn to the appropriate figure (FIGURE 18 for 10 percent consumer's risk, for example). Based on the test time available, select the test criteria which best apply to the situation. For example, a test plan with a consumer's risk of 10 percent and a total test time not to exceed 9.3 multiples of the lower test MTBF is desired. In FIGURE 18, under column heading the TOTAL TEST TIME ( $T$ ) (multiples of  $\theta_1$ ), find the test time closest to 9.3 which does not exceed it. In this case, the test time would be 9.27 multiples

of  $(\theta_1)$  Reading across the row corresponding to 9.27, the test plan number is 10-6. This test plan will accept equipment if 5 or less failures occur during the  $9.27 \times \theta_1$  hours of testing. It will reject the equipment if 6 or more failures occur during that period. The row also defines the worst case (accept with 5 failures) acceptable observed MTBF  $(\theta)$ , which for Test Plan 10-6 is 1.55 multiples of  $(\theta_1)$ . The discrimination ratios corresponding to producer's risks of 10 percent, 20 percent, and 30 percent are provided in the last three columns. Again, in the case of Test Plan 10-6 for a producer's risk of 30 percent, the discrimination ratio is 2.05:1. Similarly, for a producer's risk of 10 percent, the discrimination ratio is 2.94:1. The procuring activity should select test plans from these tables if it is felt that such a test plan is more appropriate than the standard plans.

5.10.5 MTBF estimation from observed test data. When the procuring activity must have a statistical basis for determining contractual compliance; and a basis for estimating the field service MTBF values, a fixed-duration test plan must be used. Where required, all agencies conducting reliability tests under the provisions of this handbook should provide the procuring activity with current values of demonstrated MTBF  $(\theta)$  in each required test report.

5.10.6 Exclusion of hypothesis test values. Since they are assumptions rather than test results, neither the upper test MTBF  $(\theta_0)$  nor the lower test MTBF  $(\theta_1)$  of any test plan can be used to estimate demonstrated MTBF. The demonstrated MTBF  $(\theta)$  must be calculated from demonstrated test results. Producer's risk  $(\alpha)$  and consumer's risk  $(\beta)$  are excluded from these calculations since they refer to the probability of passing or failing the test rather than to the probable range of true MTBF demonstrated during the test. However, the test parameter values  $(\theta_0, \theta_1, \alpha, \beta)$  should be provided.

5.10.7 Specified confidence interval. In order to obtain an interval estimate of the demonstrated MTBF, the procuring activity must specify the confidence interval. The confidence interval is equal to  $(100 - 2\beta)$  percent. For example, given  $\beta$  equals 10 percent, the confidence interval equals  $100 - (2)(10)$ , which equals 80 percent.

5.10.8 MTBF estimation from fixed-duration test plans. When a fixed-duration test plan is specified, an interval estimate of the demonstrated MTBF of the test sample can be estimated within the specified confidence interval. When a test report is due, the activity conducting the test should estimate the MTBF and confidence interval using the procedures specified in 5.10.8.1 through 5.10.8.2.1.

5.10.8.1 MTBF estimation at failure occurrence. This estimation can be made when a test is in process or has terminated in a reject decision. The procedure is as specified in a through e.

- a. Calculate the observed MTBF  $(\hat{\theta})$  by dividing the total operating time of the equipment at the occurrence of the most recent chargeable failure by the number of chargeable failures.

- b. Enter TABLE XIII or FIGURE XXI with total failures and the specified confidence interval. Read the lower and upper confidence multiplier for that number of failures.
- c. Multiply observed MTBF ( $\hat{\theta}$ ) calculated by step a by both the upper and lower confidence limit multipliers to obtain the lower and upper demonstrated MTBF values.
- d. Record demonstrated MTBF as the specified percentage of confidence, followed by the lower and upper MTBF values in parenthesis:  $\hat{\theta} = XX$  percent (lower limit MTBF, upper limit MTBF). MTBF values should be rounded off to the nearest whole number.
- e. If the values are not available in TABLE XIII or FIGURE 21, then the correct values can be obtained by computation as follows:

MTBF multiplier

$$= \frac{2r}{\chi^2_{(1-c)/2; 2r}} \quad \text{lower limits}$$

$$= \frac{2r}{\chi^2_{(1+c)/2; 2r}} \quad \text{upper limits}$$

where:

$r$  = number of failures

$\chi^2$  = chi-square distribution

$c$  = confidence interval (percent per 100 )

5.10.8.1.1 Example at failure occurrence. The specified confidence interval is 80 percent; therefore  $(1 + c)/2 = 0.9$  and  $(1 - c)/2 = 0.1$ . The seventh failure occurs at 820 hours total test time. Therefore, observed MTBF ( $\hat{\theta}$ ) is 117.14 hours. Enter TABLE XIII (or FIGURE 21) with seven failures and the 90 percent upper and lower limits and find the lower limit multiplier of 0.665 and an upper limit multiplier of 1.797. The product of these multipliers with the observed MTBF yields a lower limit MTBF of 77.9 hours and an upper limit MTBF of 210.5 hours. There is an 80 percent probability that the true MTBF will be bounded by this interval. There is also a 90 percent probability that the true MTBF of the sample equipment is equal to or greater than 77.9 hours, and a 90 percent probability that it is equal to or less than 210.5 hours. Demonstrated MTBF at this point in the test will be reported as:  $\theta = 80$  percent (78/211) hours:

5.10.8.2 MTBF estimation at acceptance. The calculation of a through e should be made when the test is terminated in an accept decision.

- a. Calculate the observed MTBF ( $\hat{\theta}$ ) by dividing the total operating time of the equipment by the number of chargeable failures .
- b. Enter TABLE XIV or FIGURE 21 with total failures and the specified confidence interval. Read out the lower and upper confidence multipliers for that number of failures.
- c. Multiply observed MTBF ( $\hat{\theta}$ ) (calculated in a) by both the upper and lower confidence multipliers to obtain the lower and upper demonstrated MTBF values.
- d. Record demonstrated MTBF as the specified percentage of confidence followed by the lower and upper MTBF values in parenthesis:  $\theta = XX$  percent (lower limit MTBF, upper limit MTBF). MTBF values will be rounded off to the nearest whole number.
- e. If the values are not available in TABLE XIV or FIGURE 21, then the correct values can be obtained by computation as follows:

MTBF multiplier

$$= \frac{2r}{\chi^2_{(1-c)/2; 2r+2}} \quad \text{lower limits}$$

$$= \frac{2r}{\chi^2_{(1+c)/2; 2r}} \quad \text{upper limits}$$

where:

r = number of failures

$\chi^2$  = chi-square distribution

c = confidence interval (percent per 100)

5.10.8.2.1 **Example at acceptance.** The specified confidence interval is 80 percent. The test reached an accept decision after 920 hours of testing with seven failures occurring during that period. Therefore, the observed MTBF ( $\hat{\theta}$ ) is 131 hours. Enter TABLE XIV with seven failures and the 90 percent upper and lower limits and find the a lower limit multiplier of 0.595 and an upper limit multiplier of 1.797. The product of these multipliers with the observed MTBF ( $\hat{\theta}$ ) yields a lower limit MTBF of 78.2 hours and an upper limit MTBF of 236 hours. There is an 80 percent probability that the true MTBF is bounded by this interval. There also is a 90 percent probability that true MTBF of the sample equipment is equal to or greater than 78 hours, and a 90 percent probability that it is equal to or less than 236 hours. The demonstrated MTBF at the end of the test will be reported as  $\theta = 80$  percent (78/236) hours.

5.10.9 Projection of expected field MTBF. The contractor (or test agency, if other than the contractor) should be responsible for providing demonstrated MTBF under test conditions. The procuring activity should be responsible for projecting expected MTBF under field service conditions. This responsibility can be delegated to the contractor (or test activity, if other than the contractor) when so specified in the contract.

5.10.10 Fixed-duration tests: Program Manager's assessment. The standard fixed-duration test plans are characterized by their discrimination ratio ( $d$ ), total test time ( $T$ ), and maximum allowable number of failures to accept ( $k$ ). If a fixed-duration test plan is selected, the total test duration is set in advance. The only way these plans can terminate early is by rejection. For example, Test Plan XVII-D terminates with a reject decision at the third failure if this failure occurs before 4.3 units of total test time. An accept decision can only be made when 4.3 units of total test time have been completed. Even if the second failure occurs very early, an early reject decision cannot be made; nor can an early accept decision be made if no failures have occurred, for example, by 4.0 units of total test time. In both of these situations, an early decision would lack statistical validity by failing to guarantee the OC of the selected plan. Also, an early reject decision by the consumer would probably violate contractual agreements with the producer. However, an early accept decision by the consumer would not be subject to such an objection. Such a decision might appear to be very desirable to the consumer (Government) if test costs were high or if schedule deadlines were approaching. Modifications to the standard fixed-duration test plans which allow early accept decisions to be made without sacrificing statistical validity (see Reference 12) are provided in 5.10.10.1 through 5.10.10.3. The proposed plans differ from the probability ratio sequential tests in this handbook in that rejection is permitted only after a fixed number of failures have been observed.

5.10.10.1 Accept times. The accept times ( $T_j$ ) of the Program Manager's assessment are tabulated in TABLE XV in multiples of ( $\theta_1$ ). Acceptance occurs if not more than ( $j$ ) failures have occurred to that time.

5.10.10.2 Comparison with standard fixed-duration tests. TABLE XVI indicates how the consumer's and producer's risks are modified by the Program Manager's assessment fixed-duration tests. TABLE XVII compares the maximum test times and number of failures to reject.

5.10.10.3 OC curves. FIGURES 22 through 34 provide curves of expected test duration versus true MTBF for the Program Manager's assessment fixed-duration tests.

5.11 All-equipment production reliability acceptance test plan. The basic All-Equipment Production Reliability Acceptance Test Plan (Test Plan XVIII-D) should be used when all units of production equipment (or preproduction equipment, if required by the procuring activity) must undergo a reliability lot acceptance test. The plan depicted in FIGURE 35 includes a reject line and a boundary line. Both lines may extend as far as necessary to cover the total test time required for the production run. The reject and boundary line equations are the same respectively as those for the reject and accept lines of Sequential Test Plan III-D. The equation of the reject line is  $f_R = 0.72T + 2.50$  where ( $T$ ) is cumulative test time in multiples of ( $\theta_1$ ), and ( $f$ ) is the cumulative number of failures. The plotting ordinate is for failures and the abscissa is for

multiples of  $(\theta_1)$ , the lower test MTBF. The boundary line is 5.67 failures below and parallel to the reject line. The equation is  $f_B = 0.72T - 3.17$ . FIGURE 36 presents the OC curves.

5.11.1 **Test duration.** The test duration for each equipment should be specified in the test procedure and approved by the procuring activity. Unless otherwise specified by the procuring activity, the maximum duration should be 50 hours and the minimum duration should be 20 hours where time is counted to the next higher integral number of complete test cycles. If a failure occurs in the last test cycle, the unit should be repaired and another complete test cycle run to verify the repair.

5.11.2 **Evaluation.** When Test Plan XVIII-D is used, all production units should be subjected to the environmental test conditions in the approved test procedure. Cumulative equipment operating time and equipment failures should be recorded, plotted on the chart of the test plan, and evaluated in accordance with the criteria of FIGURE 35 and 5.11.3 through 5.11.3.3.

5.11.3 **Accept-reject criteria for the all-equipment test.** Accept-reject criteria for the all-equipment test is stated in 5.11.3.1 through 5.11.3.3.

5.11.3.1 **Acceptance.** If the specified test time is completed without reaching the reject line, all of the equipment which the lot under test comprises are considered to be acceptable, provided that each equipment conforms to the specified normal performance acceptance test criteria.

5.11.3.2 **Rejection.** If a plot of failures-versus-time reaches or crosses the reject line, the equipment lot under test is no longer acceptable. The test should then be terminated and corrective action undertaken.

5.11.3.3 **Reaching the boundary line.** If the plot of failures-versus-time crosses below the boundary line and the next failure point is at least one failure interval below the boundary line, the plot should be brought vertically up to the boundary line. If the failure point is less than one failure interval below the boundary line, the plot should be brought vertically up one failure interval, crossing the boundary line. This is equivalent to censoring test time as necessary at each failure in order to maintain a failure plot without crossing the boundary line. Therefore, the test time plot will not represent true accumulated test time. All test time should be recorded in the test log to maintain the capability to determine true accumulated test time. An accurate or true plot of accumulated test time and failures should be maintained on the same chart by continuing the plot into the region beyond the boundary line. In order to maintain the proper reject criteria, the first failure occurring after the boundary line is crossed should be shifted vertically to the boundary line to start a second plot (dotted line) within the accept and continue test region, if failures occur often enough. If another failure does not occur for an extended period of time, there would be no second plot and the original true plot should be continued. The next failure should be plotted on the boundary line directly above the true plotted point (failure 7 of FIGURE 36). When several failures occur in rapid succession, the second plot (dotted line

with failures vertically spaced at exact single failure intervals) would reach the reject line, and testing would be terminated and corrective action undertaken. After the approved corrective action is completed, the testing should be resumed and the true plot continued. The cumulative number of failures and time shown by the true plot would be read directly from the failure and time scales. The failures plotted on or above the boundary line after the time plot crossed the boundary line must be labeled since the number could not be read from the ordinate. After a reject occurs and corrective action is approved, the true plot should be returned to the boundary line. Continue the true plot in real time, and sequentially number the subsequent failures as shown on failure 16 of FIGURE 36.

**5.11.4 Additional all-equipment production reliability acceptance test plans.** A unique all-equipment test plan can be developed from any PRST plan. On any given program the all-equipment test selected should be based on the actual sequential test plan used during the qualification phase. If a sequential test was not used during qualification, the procuring activity can select the most suitable plan. FIGURES 37 through 44 provide all-equipment test plans which correspond to the PRST plans given in 4.6 (Test Plans I-D through VIII-D). The accept and reject Lines of the sequential tests do not follow the original Wald formulae (see Reference 8). They have been modified to account for the effects on the test risks of truncation. In computing the all-equipment test plans, this modification was not made, therefore the accept and boundary lines of the all-equipment test will not line up with the accept and reject lines of the corresponding sequential test. The difference is in the distance between the lines. It is felt the original Wald formulae (see Reference 8) which were computed without considering truncation, are more appropriate for the all-equipment plans.

**5.12 Reliability estimates from unit-level results.** A step-by-step summary of the procedure which can be used to combine test data from fixed-duration tests or a PRST is provided in 5.12.1 and 5.12.2. The technique is called the approximately optimum (AO) method and is described in greater detail in References 13, 14, and 15.

**5.12.1 Calculation method.** The calculation procedure used in the AO method is as specified in a through e:

- a. Step 1: Verify method requirements. The conformance to the requirements of 1 through 5 should be verified. Any violations will affect the optimality of the method.
  1. The procedure was derived for series subsystems; for practical purposes it is sufficient that all subsystems are essential to system operation.
  2. Subsystems should each exhibit exponential failure distributions.
  3. Subsystems should be statistically independent; that is, the failure of any one subsystem will not induce a failure of another subsystem. In addition, there should be no appreciable failure rates due to interfaces (hydraulics, cabling, fixtures, and so forth).
  4. Each subsystem must have been tested separately until at least one failure was observed. All tests must have been terminated at a failure. If the tests

were truncated after a given time, discard all the survival time after the last failure of each subsystem. If one or more subsystems have no failures, see 5.12.6.

5. The time to failure for each subsystem must be known.
- b. Step 2: Initial calculations. Calculate and verify the total number of subsystems tested, the total number of failures of each subsystem, and the total time on test for each subsystem.
- c. Step 3: Parameter calculation. Calculate (m) and (v) using the following formulae:

$$m = \sum_{j=1}^k [(r_j - 1)Z_j] + Z_{(1)}^{-1}$$

$$v = \sum_{j=1}^k [(r_j - 1)/Z_j^2] + Z_{(1)}^{-2}$$

where:

$r_j$  = observed number of failures for subsystem

$Z_j$  = total time on test for subsystem j

$Z_{(1)}$  = least total time on test among k

k = total number of subsystems

Define the required confidence, (1 -  $\alpha$ ), for the bound and the mission time ( $t_m$ ) to which the bound will apply.

- d. Step 4: AO calculation. Calculate the AO system reliability bound using the following formula:

$$R_s(t_m) = \exp \left[ -t_m \times m \left( 1 - \frac{v}{9m^2} + \frac{n_{(1-\alpha)} \sqrt{v}}{3m} \right)^3 \right]$$

where:

$R_s(t_m)$  = AO system reliability bound

$t_m$  = mission time

distribution

$m, v =$  parameters calculated in c (step 3)

$n(1-\alpha) = (1 - \alpha)$ th percentile point from the standardized normal

$(1-\alpha) =$  required confidence

Repeat d (step 4) for as many different confidence levels as are required, using the same  $(m, v)$ . This computation is readily performed by the FORTRAN program listing in 5.12.8. In this way sensitivity analyses may be performed.

- e. Step 5: Calculate failure rate bound. An upper bound for the total system failure rate, may be found directly from the AO reliability bound.

First, the system failure rate is estimated by:

$$\phi_s = \sum_{j=1}^k \phi_j = \sum_{j=1}^k \theta_j^{-1}$$

where:

$\phi_s =$  system failure rate estimate

$\phi_j =$  jth subsystem failure rate estimate

$\theta_j =$  jth subsystem MTBF estimate ( $= 1 / \phi_j$ )

MTBF = mean-time-between-failures

and where the  $(\phi_j)$  may be computed from:

$$\phi_j = r_j / Z_j$$

Then, the upper bound on this failure rate is given by:

$$\hat{\phi}_s = -\ln[R_s(t_m)] / t_m$$

where:

$\hat{\phi}_s =$  upper bound on the system failure rate

$\ln$  = natural logarithm function

5.12.2 Numerical examples. Numerical examples have been developed to illustrate the application of the AO approach and the verification of the model requirements. A complete development from the data collection and reduction phase to the calculation of the desired AO bound will be presented.

Assume that the system cannot be tested as a whole because of costs. Therefore, its  $n$  components or integrated subsystems (for example, 5) will be tested separately.

Assume that the conditions of the system (cost, size, and so forth) limit testing to a reduced number (for example, 10) of each subsystem (that is,  $n_j = 10, 1 \leq j \leq 5$ ). Also, assume that these units will be constantly monitored and that the failure times of each failed unit will be recorded accurately.

Assume that the system as a whole has been designed to attain a specified upper test MTBF,  $(\theta_0)$ , of 1000 hours and that all the times-to-failure of the item will be converted into units of this upper test MTBF by dividing the life of all failed items by  $(\theta_0)$ . This is a convenience, not a requirement, for the correct implementation of this methodology.

Assume that for the example system we have actually observed the failure times  $(t_i)$ , expressed in units of  $(\theta_0)$  listed in TABLE XVIII. For example, for Subsystem 1 there were  $(n_1) = 10$  units simultaneously put on test and the first four failures occurred, respectively, at standardized times  $(t_i)$  of 0.619, 0.7, 0.9, and 1.1 (for  $i = 1, 2, 3, 4$ ) in units of  $(\theta_0)$  (that is, at 619, 700, 900, and 1100 actual life hours). The test for Subsystem 1 was stopped at the time of the fourth failure. 1100 actual life hours, and the total time on test for Subsystem 1 is recorded as:

$$\begin{aligned} Z_1 &= \sum_{i=1}^4 t_i + (10 - 4)t_4 \\ &= 0.619 + 0.7 + 0.9 + 1.1 + (6 \times 1.1) \\ &= 9.919 \text{ in units of } (\theta_0) \end{aligned}$$

The total times on test  $(Z_j)$ , for subsystems  $j = 2, 3, 4$ , and 5, were calculated in the same manner and tabulated in TABLE XVIII.

Subsystem 1 yielded the smallest total time on test. In general, at this stage, an inspection should be made and the subsystem with the smallest total time on test (regardless of total number of units, on test or failed) should be recorded and renamed as Subsystem 1. Hence, its total time on test will now become  $(Z_{(1)})$ . This step is crucial since the ordering of the smallest total time on test as anything other than  $(Z_{(1)})$  will change the value of the lower bound. An example of an error of this type is provided in 5.12.5. Once data collection and reduction is performed, the AO

procedure can be used to obtain a lower bound, for the reliability of the entire system. In order to calculate the AO system reliability bound, use:

$$R_s(t_m) = \exp \left[ -t_m \times m \left( 1 - \frac{v}{9m^2} + \frac{n_{(1-\alpha)}\sqrt{v}}{3m} \right)^3 \right]$$

First calculate the parameters (m) and (v). For the data appearing in TABLE XVIII, the calculations for (m) and (v) are as follows:

$$\begin{aligned} m &= \sum_{j=1}^k [(r_j - 1) / Z_j] + Z_{(1)}^{-1} \\ &= \frac{3}{9.919} + \frac{1}{15.966} + \frac{1}{26.897} + \frac{2}{26.511} + \frac{2}{62.439} + \frac{1}{9.919} \\ &= 0.3024 + 0.0625 + 0.0372 + 0.0754 + 0.0320 + 0.1008 \\ &= 0.6103 \\ v &= \sum_{j=1}^k [(r_j - 1) / Z_j^2] + Z_{(1)}^{-2} \\ &= \frac{3}{98.387} + \frac{1}{255.872} + \frac{1}{723.449} + \frac{2}{702.833} + \frac{2}{3898.63} + \frac{1}{98.387} \\ &= 0.305 + 0.0039 + 0.0014 + 0.0028 + 0.0005 + 0.0102 \\ &= 0.0493 \end{aligned}$$

Therefore:

$$m = 0.6103$$

$$v = 0.0493$$

At this time it is necessary to decide upon the level of confidence (1 -  $\alpha$ ), level of significance ( $\alpha$ ), with which the lower bound will be obtained:

Assume first that a level of confidence of 75 percent (that is, our estimated lower system reliability bound) will in fact be below the real system reliability value at least 75 percent of the time given the total times on test ( $Z_j \leq j \leq n$ ) obtained herein. For this case, we look up the 75th percentile,  $n_{(1-\alpha)}$  in a statistical table for the standardized normal distribution and obtain:

$$n_{0.75} = 0.68$$

Assuming that the specified mission time for the whole system is  $\theta_0 = 1000$  hours (or  $t_m = 1.0$ ), we calculate the AO reliability bound as follows:

for  $n_{(1-\alpha)} = 0.68$ , that is,  $\alpha = 0.25$  and  $t_m = 1.0$  (mission time)

$$\begin{aligned} \underline{R}_s(t_m) &= \exp \left[ -t_m \times m \left( 1 - \frac{v}{9m^2} + \frac{n_{(0.75)} \sqrt{v}}{3m} \right)^3 \right] \\ &= \exp \left[ -1.0 \times 0.6103 \left( 1 - 0.0493/9 (0.6103)^2 + 0.68 \sqrt{0.0493}/3 (0.6103) \right)^3 \right] \\ &= \exp \left[ -0.6103 \left( 1 - 0.0147 + 0.68 (0.2220)/1.8309 \right)^3 \right] \\ &= \exp \left[ -0.6103 \times 1.0678^3 \right] \\ &= \exp \left[ -0.7430 \right] \\ &= 0.476 \end{aligned}$$

Another system reliability bound which will be below the real system reliability value only 50 percent of the time can be calculated as before, but now use, instead, the 50th percentile in a standardized normal distribution table. This value is, of course, zero. This bound will be larger than the previous one since it will bound the real system reliability value a smaller percentage of the times. It is obtained by repeating the procedure already described with the same parameters ( $m$ ) and ( $v$ ), since it is for the same system, and the same mission time ( $t_m$ ), since requirements for ( $\theta_0$ ) have not changed, and with the new percentile ( $n$ ):

for:

$$n_{(1-\alpha)} = 0.0, \text{ that is, } \alpha = 0.5, t_m = 1.0$$

$$\begin{aligned} \underline{R}_s(t_m) &= \exp \left[ -0.6103 \left( 1 - 0.0493/9 (0.6103)^2 + 0.0 \sqrt{0.0493}/3 (0.6103) \right)^3 \right] \\ &= \exp \left[ -0.6103 (1 - 0.0147 + 0)^3 \right] \\ &= \exp \left[ -0.6103 \times 0.9853^3 \right] \\ &= \exp \left[ -0.5838 \right] \\ &= 0.558 \end{aligned}$$

5.12.3 The case of only one failure in some subsystem(s). Considering the formulae for the parameters ( $m$ ) and ( $v$ ), we can easily conclude that for every subsystem ( $j$ ) with only one observed failure (that is,  $r_j - 1 = 0$ ) the information provided by this subsystem to the reliability bound is zero (that is,  $(r_j - 1)/Z_j = 0$ ). That is, no matter what time a failure occurred in subsystem ( $j$ ), the term  $(r_j - 1)/Z_j$  vanishes in the equations for ( $m$ ) and ( $v$ ) and has no impact on the calculation of the AO reliability bound ( $R_S(t_m)$ ). This was particularly critical in the original

version of (m) and (v), (see Reference 13, Table 2, Formula 1), and created a need for the adaptive procedure. Formula 1 refers to the special case where only one failure is observed during the testing of all subsystems integrating the system. The main problem with Formula 1 is that, when  $r_j = 1$  for  $1 < j < n$ , the term:

$$\frac{\sum (r_j - 1) v Z_j^4}{\sum (r_j - 1) v Z_j^2} = \frac{0}{0}$$

which is indeterminate (that is, when each subsystem has experienced only one failure). With the general version for (m) and (v) proposed in References 14 and 15 and suggested in those references as the most appropriate one, this situation does not arise. In fact, if  $r_j = 1, 1 < j < n$ , then  $m = Z_1$  and  $v = Z_1$  are still well defined. We can appreciate also the importance of renaming the subsystem with the smallest total time on test among all subsystems under consideration, as  $Z_1$ . For this special case, take the same numerical example presented in 4.9.2 and modified as follows:

<u>Subsystem 1</u>	<u>Subsystem 2</u>	<u>Subsystem 3</u>
$t_1 = 0.619$	$t_1 = 1.146$	$t_1 = 2.6897$
$t_2 = 0.7$	$t_2 = 1.65$	
$t_3 = 0.9$		
$t_4 = 1.1$		
$Z_1 = 9.919$	$Z_2 = 15.996$	$Z_3 = 26.897$
$n_1 = 10$	$n_2 = 10$	$n_3 = 10$
$r_1 = 4$	$r_2 = 2$	$r_3 = 1$

The system is now composed only of Subsystems 1, 2 and 3, with the same number of failures and failure times for Subsystems 1 and 2 as before. However, Subsystem 3 now has only one failure at the truncation time, 2.6897, in units of  $(\theta_0)$  (that is, the test was stopped at the time of the first failure).

Calculations of (m) and (v) are:

$$\begin{aligned}
 m &= \sum_{j=1}^k (r_j - 1) v Z_{(1)}^{-1} \\
 &= \frac{(4-1)}{9.919} + \frac{(2-1)}{15.996} + \frac{(1-1)}{26.897} + \frac{1}{9.919} \\
 &= 0.3024 + 0.0625 + 0.0 + 0.1008 \\
 &= .4657
 \end{aligned}$$

$$\begin{aligned}
 v &= \sum_{j=1}^k (r_j - 1) Z_j^2 + Z_{(1)}^{-2} \\
 &= \frac{(4-1)}{98.387} + \frac{(2-1)}{255.872} + \frac{(1-1)}{723.449} + \frac{1}{98.387} \\
 &= 0.0305 + 0.0039 + 0.0102 \\
 &= 0.0446
 \end{aligned}$$

With these values of (m) and (v) we can calculate a 50 percent AO lower system reliability bound for the specified mission time  $\theta_0 = 1000$  hours ( $t_m = 1.0$  in units of  $\theta_0$ ). Thus:

$$\underline{R}_s(t_m) = \exp \left[ -t_m \times m \left( 1 - \frac{v}{9m^2} + \frac{n_{(1-\alpha)} \sqrt{v}}{3m} \right)^3 \right]$$

for  $t_m = 1.0$  and  $n_{(1-\alpha)} = 0$ , that is,  $\alpha = 0.5$

$$\begin{aligned}
 \underline{R}_s(t_m) &= \exp[-0.4657(1-0.0446/9(0.4657)^2+0.0)^3] \\
 &= \exp[0.4657(1-0.0228)^3] \\
 &= \exp[-0.4657 \times 0.9772^3] \\
 &= \exp[-0.4345] \\
 &= 0.6476
 \end{aligned}$$

To calculate the lower confidence bound for a level of significance of 75 percent, apply the procedure used to calculate a 50 percent lower system reliability bound. That is, for the 75th percentile,  $n_{(1-\alpha)} = n_{0.75} = 0.68$ , we have:

for  $t_m = 1.0$  and  $n_{(1-\alpha)} = 0.68$ , that is,  $\alpha = 0.25$

$$\begin{aligned}
 \underline{R}_s(t_m) &= \exp[-0.4657(1 - 0.0446/9(0.4657)^2 + 0.68\sqrt{0.0446}/3(0.4657))^3] \\
 &= \exp[-0.4657(1-0.0228 + 0.1436/1.3971)^3] \\
 &= \exp[-0.4657 \times 1.0800^3] \\
 &= \exp[-0.5866]
 \end{aligned}$$

$$=0.5562$$

5.12.4 An estimator of the failure rate upper bound. Often, reliability engineers are interested in the estimated system failure rate ( $\phi$ ) as well as in the estimated reliability ( $R_s(t_m)$ ) of the system, given a mission time ( $t_m$ ).

Assuming that all the conditions are met and following the notation of Reference 13:

$$\phi_s = \sum_{j=1}^n \phi_j = \sum_{j=1}^n \theta_j^{-1}$$

where:

$\phi_j$  = jth subsystem failure rate

$\theta_j$  = jth subsystem MTBF

Therefore, an estimator ( $\hat{\phi}_s$ ) of the upper bound for the total system failure rate ( $\phi$ ) will be:

$$\hat{\phi}_s = -\ln[R_s(t_m)]/t_m$$

where ( $R_s(t_m)$ ) is the AO estimator of the system reliability lower bound calculated in 5.12.1 and 5.12.2; ( $t_m$ ) is the specified mission time and ( $\ln$ ) is the natural logarithm. This ( $\hat{\phi}_s$ ) failure rate upper bound is subject to the same constraints used in obtaining ( $R_s(t_m)$ ), that is, same level of confidence, dependence on same total times on test ( $Z_j$ ), and all other constraints discussed. As an illustration of this procedure, assume we want to obtain an estimate ( $\hat{\phi}_s$ ) of the upper bound of system failure rate ( $\phi_s$ ) for the two examples developed in 5.12.1 and 5.12.2. Examples are as specified in a and b:

a. For the calculation method, where the level of confidence was 75 percent:

$$\hat{\phi}_s = -\ln \frac{0.4757}{1.0} = 0.74296 \text{ failures per 1000 hours}$$

is a 75 percent upper confidence bound for total system failure rate (that is, this bound will be larger than the actual system failure rate at least 75 percent of the time).

b. For the second example, where the level of confidence was 50 percent, we have:

$$\hat{\phi}_s = -\ln \frac{0.5578}{1.0} = 0.58375 \text{ failures per 1000 hours}$$

that is, the actual system failure rate ( $\phi_s$ ) will be exceeded by the above estimate ( $\phi_c$ ) at least 50 percent of the time.

**5.12.5 Departures from AO method requirements.** Cautions regarding the use of the AO methodology and suggestions for dealing with deviations from the requirements are as provided in a through f:

- a. The exponentiality of the statistical distribution of the times-to-failure and the independence of the subsystems should be carefully checked. Both requirements represent ideal conditions. However, they can be justified in practice. For example, the exponential distribution requirement can be justified by using burn-in and quality control procedures for the subsystem's critical components. The subsystem's independence requirement can be justified by the technical knowledge that actual subsystem interfaces negligibly affect reliability. When either of these two conditions is gravely suspect, the present AO procedure should not be applied: If it is absolutely necessary to use the present AO procedure, then extreme caution is required and the results should be interpreted with great care.
- b. This caution relates to the termination times of the different subsystem tests. All tests should be failure truncated, that is, terminated at the occurrence of a failure (Type II censoring). Mixtures of Types I and II censoring schemes are not recommended. If, in a given subsystem test, the test truncation time is other than a failure time, it is recommended that the last failure time before truncation be taken as the actual truncation time (see 5.12.1).
- c. The ordering of the data is very important for the correct application of the AO procedure. The subsystem with the least total time on test must always be recorded as Subsystem 1, and its total time on test, ( $Z_{(1)}$ ), included in the last terms of the calculation of ( $m$ ) and ( $v$ ) parameters. An example of the consequences for noncompliance with this requirement is presented in TABLES 19 and 20. Observe how the results vary considerably due to ( $Z_{(1)}$ ) not being the least total time on test among the subsystems.
- d. The AO approach requires the observation of at least one failure in each subsystem. This is a very strict requirement and a must for the correct application of this AO procedure. When dealing with high-cost, ultra reliable systems, the necessary time to obtain a failure in some of the component subsystems may be too long. Also, the number of items on test for a given subsystem to obtain a high probability of getting a failure before truncation time may be too small. In practice, for some particular subsystem, testing may have to be terminated before observing the first failure, but an engineering assessment is still required.
- e. Under the real life constraints of d, the use of an adaptive procedure will be required in order to provide a gross approximation for the system reliability bound. Assume that a first failure has occurred at the time of test truncation (for the subsystem without any prior observed failures) and calculate the lower

- AO system reliability bound. This will provide a gross lower bound for the AO system reliability bound. Care should be taken not to use this procedure where the total time on test for the subsystem is the smallest (that is,  $Z_{(1)}$ ).
- f. Given the formulae for (m) and (v), in the case of one real or imaginary failure in any jth subsystem, then  $r_j - 1 = 0$  and  $(r_j - 1) / = 0$ . Therefore, the information contribution of this subsystem to the reliability bound is null, unless it is the one with the smallest total time on test.

5.12.6 No observed failures. An example of the adaptive procedure for dealing with the case of no observed failures for some subsystem is provided below (see Reference 13). Assume that for the second subsystem, the test was terminated before the first failure occurred, that is:

$Z_1 = 17.607$	$Z_2 = 20.045$	$Z_3 = 33.644$	$Z_4 = 51.495$
$n_1 = 2$	$n_2 = 1$	$n_3 = 2$	$n_4 = 3$
$Z_5 = 82.214$			
$n_5 = 3$			

Exact (90 percent confidence) bound = 0.726. AO bound = 0.735 (at 90 percent confidence level)

Assume that for Subsystem 2, the test was truncated before the first failure had occurred and the corresponding total time on test for Subsystem 2 at the truncation time was  $Z_2 = 19.5$

Assume that one failure had occurred at this truncation time. The gross lower bound is obtained as AO bound = 0.719 (at 90 percent confidence level)

5.12.7 Type I censoring. To consider a test truncated at other than a failure time, assume that the Subsystem 3 test was truncated some time after the first failure but before the second failure, as depicted in FIGURE 45. Had we waited to observe the second failure, the values obtained according to Reference 13 would be:

$Z_1 = 14.61$	$Z_2 = 35.971$	$Z_3 = 62.542$
$n_1 = 2$	$n_2 = 2$	$n_3 = 3$

Exact (90 percent) bound = 0.731. AO bound = 0.738 (at 90 percent confidence level)

If we assume that the truncation time was ( $T^*$ ), the values obtained up to the first failure (that is, neglecting test time from the first failure up to time ( $T^*$ )) would be:

$$Z_1 = 14.61$$

$$n_1 = 2$$

$$Z_2 = 35.971$$

$$n_2 = 2$$

$$Z_3 = 30.0$$

$$n_3 = 1$$

The result is AO bound = 0.781 (at 90 percent confidence level)

An alternative adaptive procedure is to assume that time ( $T^*$ ) is the time of the second (last) observed failure. This is not recommended because of the conditions specified in a through c:

- a. There are existing failures in the test other than at ( $T^*$ ).
- b. Since the second following failure time will never be known, we may be introducing unnecessary bias in the analysis by assuming ( $T^*$ ) to be a failure time.
- c. Statistical properties of the bound are unnecessarily lost when truncation is taken at any other time than at a failure.

5.12.8 Computer program. A computer program was written to implement the AO methodology. FORTRAN listings are included in FIGURES 152 through 154. The program is self-contained and may be adapted for any computer with a FORTRAN compiler. The use of the program requires the data specified in a through c:

a. Inputs:

$k$  = number of subsystems

$Z_1$  = total time on test for the subsystem with least total time on test

$n_{r(1)}$  = number of failures of the same (previous) subsystem

$Z_i$  =  $2 < i < k$  total time on test for system

$n_{r(i)}$  = total number of failures for  $i$ th system

$t_m$  = mission time desired in the reliability bound

$p$  = percentile of the confidence level desired in the reliability bound

b. Outputs:

$M1$  = parameters

$V1$  = parameters

$M2$  = parameters

$V2$  = parameters

M3 = parameters

V3 = parameters

- c. Reliability bounds: Of these results, only the recommended values M2, V2, and the corresponding bound are presently printed. The other results are inserted as comments in the program. The user may activate them easily by removing the comment command. An example run for the data provided in TABLE XXI is given in TABLE XXII.

## 6. COMBINED ENVIRONMENTAL TEST CONDITIONS

6.1 Purpose. Section 6 provides guidance to individuals responsible for establishing the combined environmental test. The data is presented in a manner which encourages tailoring to specific systems, platforms, and operational environments.

6.1.1 Scope. Section 6 discusses the combined environmental test conditions to be applied during reliability tests. The analyses needed to establish the appropriate test conditions are provided also.

### 6.2 Thermal and Vibration Survey.

Purpose. The purpose is to establish and implement survey testing procedures so that thermal stabilization and resonant conditions of the equipment can be determined.

Description. Thermal and vibration survey testing should be conducted on a sample of the equipment to determine the level of equipment thermal stabilization and to search for resonant conditions and design weaknesses. Thermal and vibration surveys should be performed prior to the start of reliability testing.

Thermal survey. A thermal survey should be performed on one sample of the equipment to be tested, under the temperature and duty cycle specified in the reliability test procedures. The thermal survey should be used to identify hot spots and the component of greatest thermal inertia, and to establish the time temperature relationship between the equipment and the chamber air. These relationships should be used to determine the level of equipment thermal stabilization. The lower test level temperature stabilization occurs when the temperature of the point of the maximum thermal inertia is within 2°C of the lower test level temperature or the rate of change is less than 2°C per hour. Upper test level temperature stabilization occurs when the temperature of the maximum thermal inertia point is within 2°C of the upper temperature level or the rate of change is less than 2°C per hour. Temperatures of equipment cooling air and chamber air should be recorded continuously during both the survey and the tests. Should the results of the thermal survey indicate local temperatures significantly higher than those predicted by the final thermal design analysis or greater than those used for derating in the reliability prediction, corrective action should be accomplished, verified, and approved prior to the start of reliability testing.

Vibration survey. A vibration survey should be performed on one sample of the equipment to be tested to search for resonant conditions and design weaknesses. Unless otherwise specified by the procuring activity, the vibration conditions should be those specified in the reliability test procedures. Any failures which occur during vibration survey testing should be reported, investigated, and analyzed for cause; and corrective action should be accomplished, verified, and approved prior to the start of reliability testing. Equipment mounting for the vibration survey should simulate mounting in actual use.

6.3 Mission and life-cycle environmental profiles and test conditions. Mission and life-cycle environmental profiles and test conditions are as provided in 6.3.1 and 6.3.2.

6.3.1 Mission and life-cycle environmental profiles. The mission profiles should be used to determine the environmental specifications and should be derived from the operational life profile defined by the equipment or system operational requirements. If this information is not provided in the original contractual documentation, provision should be made for the procuring activity and the contractor to cooperatively derive the mission profiles and the equipment environmental specifications. This derivation should make use of historical data on similar equipment applications and mounting platforms and the effect of equipment location in the platform should be accounted for. Each significant life-cycle event must be considered, including transportation, handling, installation and checkout, and tactical missions including platform category and operational situation.

6.3.2 Environmental test conditions. The reliability growth, qualification, and acceptance tests should be performed under the combined influence of electrical power input, temperature, vibration, humidity and other appropriate test conditions. The test levels for these test conditions should be derived from the equipment's mission and environmental profiles. When the equipment is designed for one application, with a single mission, or one type of repetitive mission, there is a one-to-one relationship between the test profile and mission and life-cycle environmental profile. The test conditions should simulate the actual stress levels during the mission. If the equipment is designed for several missions and environmental conditions, the test profile should represent a composite of those missions, with the test levels and durations being prorated according to the percentage of each mission type expected during the equipment's life cycle. In order to derive realistic test conditions and levels, the actual environments (especially temperature and vibration) should be measured at the location where the equipment is to be mounted during an actual mission operation. Where such data are not available, the conditions and levels presented in 6.4 through 6.11.1.4 may be used as guidelines.

6.4 Combined environments for fixed-ground equipment. Equipments designed for fixed-ground installations are generally located in a controlled environment within a building and, therefore, do not require cyclic environmental testing (see Reference 16). However, since this equipment must be transported to the final installation site, a nominal vibration test should be applied, with power OFF, before each reliability test. Contractually specific operating criteria based on the guidelines in 6.4.1 through 6.4.4 may be used in the test plan and procedures. A typical combined environmental test profile for fixed-ground equipment is shown in FIGURE 46. The duration of the profile is normally 24 hours or an evenly divisible fraction thereof.

6.4.1 Electronic stress and duty cycle. The equipment should be operated at nominal design input voltage for 50 percent of the time and 25 percent of the time each at minimum and maximum input voltages. The input voltage range, if not specified, should be  $\pm 7$  percent of the nominal input voltage. The duration of the operating cycle should depend on the operational use of the equipment; typically, four hours, eight hours, or 16 hours per day, or around-the-clock continuous operation with periodic shutdowns for routine maintenance should be considered.

The equipment duty cycle should be ON about 90 percent of the test cycle. The OFF periods should be randomly selected.

**Vibration stress.** Normally, vibration stress testing is not required during the operational phase of the environmental profile. If the equipment is not packaged specifically for transportation to the installation site, a nominal vibration stress, consisting of a single-frequency sine-wave vibration at 2.2 gravitational acceleration units peak (g's pk) at a nonresonant frequency between 20 hertz (Hz) and 60 Hz, should be applied for 20 minutes before starting the reliability test. If the equipment has specified shipping configuration, it should be qualified for adequate shipping protection by packing it in that configuration and testing it prior to the reliability test in accordance with the shipping vibration and shock expected.

**6.4.2 Thermal stress.** The equipment should be operated at its specified ambient temperature. If not specified, use these thermal conditions provided in a through e:

- a. Cold soak temperature:  $-54^{\circ}\text{C}$
- b. Hot soak temperature:  $+85^{\circ}\text{C}$
- c. If the equipment is installed in an occupied building with automatically controlled air -conditioning and heating, use  $25^{\circ}\text{C}$  as the operating ambient temperature. Computer equipment should be controlled at  $20^{\circ}\text{C}$ .
- d. If the equipment is installed in a nonair-conditioned building where summer heat may reach a high temperature, use  $40^{\circ}\text{C}$  as the operating ambient temperature.
- e. If the equipment is in an unoccupied, nonair-conditioned enclosure and in semitropical or tropical locations, perform one-half of the testing at  $60^{\circ}\text{C}$ , one-quarter at  $40^{\circ}\text{C}$ , and one-quarter at  $20^{\circ}\text{C}$ .

**6.4.3 Humidity.** Humidity testing is not required unless specified in the contract. See AR70-38 for additional guidance for humidity testing.

**6.5 Combined environments for mobile ground equipment.** This category of equipment includes wheeled vehicles, tracked vehicles, shelter configurations, and manpacks (see Reference 16). The specific equipment application should be considered when specifying the combined environments for reliability testing. Equipment operating on moving platforms, including wheeled and tracked vehicles, and while stationary, should be considered in developing a cyclic test similar to the test shown in FIGURE 47. The test profile duration should be 24 hours or an evenly divisible fraction thereof. Climatic extreme and vibration data should be considered to represent maximum conditions. The actual test environmental conditions should include a distribution of values which reflects expected conditions. Only a small fraction of test levels should reach the maximum conditions.

**6.5.1 Electrical stress and duty cycle.** The equipment should be operated at nominal design input voltage for 50 percent of the ON time, at minimum voltage for 25 percent of the ON time, and at maximum voltage for 25 percent of the ON time. The input voltage range, if not specified elsewhere, should be as specified in a through d:

- a. Wheeled vehicle equipment:  $\pm 10$  percent of nominal or as specified by the procuring activity.
- b. Tracked vehicle equipment:  $\pm 10$  percent of nominal or as specified by the procuring activity.
- c. Shelter configuration equipment:  $\pm 10$  percent of nominal or as specified by the procuring activity.
- d. Manpack equipment: For 24 volts direct current (VDC), volts (V) maximum = 32 V; minimum = 20V

The duration of the operational test cycle should be based on mission requirements and equipment design control specification. The duty cycle should be ON 90 percent of the time and OFF 10 percent of the time. The OFF periods should be randomly spaced. If designed for continuous operation for an eight-hour shift, the operating cycle should be eight hours with complete shutdown before the next operation. This time period is long enough for the equipment to stabilize at the ambient temperature.

6.5.2 Vibration stress. Unless otherwise specified by the procuring activity, the vibration stress should follow general guidance is as specified in a through d:

- a. Wheeled vehicle equipment: 5 Hz to 200 Hz to 5 Hz for a maximum time of 5.5 hours, using a cycle of 12 minutes on each of three axes. Maximum g-level is 3.5 g. Maximum displacement is 1-inch double amplitude (DA).
- b. Tracked vehicle equipment: 5 Hz to 500 Hz to 5 Hz for a maximum time of 3 hours, using a cycle of 15 minutes on each of three axes. Maximum g-level is 4.2 g. Maximum displacement is 1- inch DA.
- c. Shelter configuration equipment: 5 Hz to 200 Hz to 5 Hz for a maximum time of 5.5 hours, using a cycle of 12 minutes on each of three axes. Maximum g-level is 3.5 g. Maximum displacement is 1-inch DA.
- d. Manpack equipment: 5 Hz to 500 Hz to 5 Hz for a maximum of 3 hours, using a cycle of 15 minutes on each of three axes. Maximum g-level is 4.2 g. Maximum displacement is 1-inch DA.

If the equipment is operated on a carrier which is stationary for a major portion of the time, the vibration should only be applied for a portion of the operating cycle.

6.5.3 Thermal stress. The equipment should be operated at the specified ambient temperature conditions from minimum to maximum, as shown in FIGURE 47. If no ambient temperatures are specified, the temperatures specified in a through c should be used:

- a. Cold soak temperature:  $- 54^{\circ}\text{C}$  (start of normal cycle)
- b. Hot soak temperature:  $+ 85^{\circ}\text{C}$  (every fifth cycle)
- c. Operating temperature range:  $- 40^{\circ}\text{C}$  to  $+ 55^{\circ}\text{C}$

6.5.4 Moisture. Moisture levels sufficient to cause visible condensation and frosting should be used when such conditions are expected in the field service environment of the equipment under test. Humidity need not be held constant during the test cycle, and high levels may be achieved by moisture injection at appropriate times in the test cycle.

6.6 Combined environments for shipboard and underwater vehicle equipments. The combined environments experienced by shipboard equipment depend on the location of the equipment onboard ship and the ship type. Equipment mounted in unsheltered deck or superstructure and mast areas will experience more severe environmental stresses. This equipment includes Naval surface craft, Naval submarine, marine craft (Army, landing), and underwater vehicles specified in 6.6.1 through 6.6.4.

6.6.1 Naval surface craft. The combined environments experienced by Naval surface craft equipment depend on the location of the equipment onboard ship (see Reference 17). Equipment mounted in unsheltered deck or superstructure and mast areas will experience more severe environmental stresses. Categories of Naval surface craft equipment environments are as specified in 6.6.1.1 through 6.6.1.1.3 (see FIGURES 48 through 53).

6.6.1.1 Externally mounted equipment. The suggested test profile for externally mounted equipment is provided in 6.6.1.1.1 through 6.6.1.1.3.

6.6.1.1.1 Electrical stress and duty cycle. During the operating cycle, input voltage should be varied between several levels as shown in FIGURES 48 and 49. Unless otherwise specified by the procuring activity, the input voltage range should be  $\pm 7$  percent of nominal design voltage. After reference measurements are taken at nominal voltage and room temperature, minimum and maximum voltage should be applied during the operating cycle as shown in FIGURES 48 and 49. The duty cycle is given also in FIGURES 47 and 48. The equipment should be OFF about 10 percent of the time. Power should be ON during the cold and hot soak periods.

6.6.1.1.2 Vibration stress. The vibration stress should be applied according to the schedule in FIGURES 48 and 49 on a 25 percent randomly selected duty cycle. The vibration spectra should have the shape defined in FIGURE 54. The test should be run on a single axis specified by the procuring activity.

6.6.1.1.3 Temperature and humidity stress. The suggested temperature and humidity profile for externally mounted equipment is provided in a through o below. All relative humidity (RH) values are  $\pm 5$  percent (RH):

- a. Starting from 22°C and 25 percent to 75 percent RH, lower the temperature to -50°C as rapidly as possible, hold at -50°C (cold soak) for 1.75 hours (ON). Raise the temperature to -32°C. Apply the cold soak only during the first three cycles.
- b. Slowly lower the temperature to -34.5°C over a period of 3.5 hours.
- c. Slowly raise the temperature to -28°C over a period of 13 hours.

- d. Raise the temperature to 22°C over a period of 5 hours.
- e. Hold the temperature at 22°C, but bring the RH to 25 percent to 75 percent over a period of 1 hour.
- f. Raise the temperature to 25°C and the RH to 95 percent over a period of 2 hours.
- g. Over the next 10 hours, slowly raise the temperature to 29°C with the RH kept continuously at 95 percent and hold for 5 hours.
- h. Slowly lower the temperature to 25°C over a period of the next 5 hours with the RH kept continuously at 95 percent.
- i. After 2 hours, lower the temperature to 22°C and the RH from 25 percent to 75 percent.
- j. After 2 hours, raise the temperature to 25°C with an RH of 65 percent.
- k. Over the next 12 hours, raise the temperature slowly to 48°C with an RH of 25 percent and hold for 2 hours.
- l. Raise the temperature to 65°C (ON) and raise the RH to 95 percent and hold for 2 hours. Drop the temperature to 48°C. Apply the hot soak only during the first three cycles.
- m. Over the next 9 hours, slowly lower the temperature to 22°C and bring the RH to 25 percent to 75 percent.
- n. Repeat steps f through i six times.
- o. Return to step a and repeat the cycle until the desired test duration is obtained.

Hot and cold soaks are added to cover worse-case storage and transportation environments.

6.6.1.2 Internally mounted equipment. The full profile for internally mounted equipment is as shown on FIGURES 50 and 51.

6.6.1.2.1 Electrical stress and duty cycle. The electrical stress and duty cycle should conform to 6.6.1.1.1.

6.6.1.2.2 Vibration stress. The vibration stress should conform to 6.6.1.1.2.

6.6.1.2.3 Temperature and humidity stress. The temperature and humidity stress profile for internally mounted equipment is as specified in a through m:

- a. Starting from 22°C and 25 percent to 75 percent RH, lower the temperature to -50°C as rapidly as possible and hold at -50°C (cold soak) for 1.75 hours (OFF). Raise the temperature to 0°C as rapidly as possible. Apply the cold soak only for first three cycles.
- b. Hold 0°C for 19.5 hours, then raise the temperature to 19°C over a period of 2 hours.
- c. Over a period of 1 hour, establish conditions of 22°C and 25 percent to 75 percent RH.
- d. Over a period of 2 hours, establish conditions of 37°C and 50 percent RH.

- e. Slowly during the next 10 hours, establish conditions of 41°C and 48 percent RH; hold for 5 hours.
- f. Slowly during a period of 5 hours, establish conditions of 37°C and 50 percent RH.
- g. Hold 37°C for the next 2 hours, but lower the RH to 43 percent.
- h. After 2 hours establish conditions of 41°C and 33 percent RH.
- i. Slowly during the next 9 hours, establish conditions of 50°C and 21 percent RH; hold for 6 hours.
- j. Rapidly raise the temperature to 65°C and the RH to 95 percent; hold for 2 hours (OFF). Lower temperature as rapidly as possible to 50°C. Apply the hot soak only during the first three cycles.
- k. Over the next 5 hours, slowly establish conditions of 22°C and 25 percent to 75 percent RH.
- l. Repeat steps d through i six times.
- m. Return to step a and repeat cycle until the desired test duration is obtained.

6.6.1.3 Internally mounted equipment, temperature controlled space. See FIGURES 52 and 53 for the full profile of the internally mounted equipment for temperature controlled space.

6.6.1.3.1 Electrical stress and duty cycle. The electrical stress and duty cycle for internally mounted equipment in a temperature controlled space should conform to 6.6.1.1.1.

6.6.1.3.2 Vibration stress. The vibration stress should conform to 6.6.1.1.2.

6.6.1.3.3 Temperature and humidity stress profile. The temperature and humidity stress profile for internally mounted equipment in temperature controlled spaces is provided in a through i:

- a. Starting from 22°C and 25 percent to 75 percent RH, lower the temperature as rapidly as possible to -50°C (cold soak) and 25 percent RH; hold for 1.75 hours (OFF). Raise the temperature to 22°C as rapidly as possible. Return the RH to 75 percent. Apply the cold soak only during the first three cycles.
- b. Slowly over a period of 15 hours, establish conditions of 25°C and 30 percent RH.
- c. Slowly over a period of 7 hours, establish conditions of 25°C and 30 percent RH.
- d. Repeat steps a through c six times.
- e. Lower the temperature to 0°C in 1 hour; hold for 5 hours.
- f. After 2 hours, establish conditions of 20°C and 46 percent RH; hold for 6 hours.
- g. After 2 hours, establish conditions of 50°C and 21 percent RH; hold for 4 hours. Raise the temperature as rapidly as possible to 65°C; hold for 2 hours (OFF). Decrease the temperature rapidly to 50°C. Apply the hot soak on only the first three cycles.

- h. After 2 hours, establish conditions of 22°C and 25 percent to 75 percent RH.
- i. Return to step a and repeat the cycle until the desired test duration is obtained.

6.6.2 Naval submarine. The submarine profiles should be based on a 24-hour test cycle which should be repeated for the duration of the test (see Reference 18).

6.6.2.1 Electrical and duty cycle stress. During the operating cycle, the input voltage should be varied between several levels as shown in FIGURE 55. Unless otherwise specified, the input voltage range should be + 7 percent of nominal. Reference measurements should be made at nominal voltage and room temperature. Minimum voltage should be applied for the initial period of the operating cycle and maximum voltage should be applied during the period of highest ambient temperature. Nominal voltage should be applied for the balance of the cycle and the duty cycle should be as shown in FIGURE 55.

6.6.2.2 Vibration stress. Submarine vibration stress levels are normally extremely low. However, since vibration levels after battle damage and during transportation may be considerably higher, the vibration stress of FIGURE 54 should be used with the profile shown in FIGURE 55. The actual vibration time should be 3 hours in a 24-hour test cycle. This test should be run on a single axis selected by the procuring activity. The battle damage spectrum should be applied for 10 minutes during each 24-hour test cycle at the start of the vibration cycling. The transportation spectrum should be applied for the remainder of the 3 hours, in 20-minute intervals, with 10-minute breaks.

6.6.2.3 Temperature and humidity stress profile. The temperature and humidity stress profile for Naval submarine equipments is provided in a through k:

- a. Starting from 22°C and 25 percent to 75 percent RH, lower the temperature as rapidly as possible to -50°C and hold for 1.75 hours (OFF). Apply the cold soak only on the first three cycles.
- b. Raise the temperature to -35°C; hold for 2 hours.
- c. Raise the temperature to 0°C; hold for 2 hours.
- d. Raise the temperature to 22°C; hold for 6 hours.
- e. Raise the temperature to 50°C and the RH to 95 percent; hold for 1 hour.
- f. Raise the temperature to 65°C; hold for 2 hours (OFF). Hold the RH at 95 percent. Apply the hot soak only during the first three cycles.
- g. Lower the temperature to 50°C and the RH to 65 percent; hold for 2 hours.
- h. Lower the temperature to 22°C and raise the RH to 95 percent; hold for 4 hours.
- i. Lower the temperature to 0°C and lower the RH to the 25 percent to 75 percent range.
- j. Lower the temperature to -35°C over a period of 2 hours; hold the RH in the 25 percent to 75 percent range for 1 hour.
- k. Repeat the test profile as directed by the Program Manager.

6.6.2.4 Moisture. Moisture levels are not a significant stress factor for equipment installed in protected areas on submarines.

6.6.3 Marine craft (Army). Marine craft includes a variety of smaller craft such as landing craft and smaller vessels used on interior waterways. The environmental stress cycle for marine craft is given in FIGURE 56 (see Reference 16). The test cycle duration should be 24 hours or an evenly divisible fraction thereof. The environments for testing small marine craft are given in 6.6.3.1 through 6.6.3.4.

6.6.3.1 Thermal stress. Unless otherwise specified by the procuring activity, the marine craft thermal stress environment should be constructed from a combination of the environments in TABLE XXIII.

6.6.3.2 Vibration stress. If the vibration is unknown or not specified, the requirements provided in a through c should be used:

- a. Amplitude: .020 inch (DA)  $\pm$ .004 inch (DA)
- b. Frequency range: 4 Hz to 33 Hz to 4 Hz
- c. Sweeptime: 10 minutes  $\pm$  2 minutes (up and down)

6.6.3.3 Electrical stress and duty cycle. A voltage variation of  $\pm$ 10 percent is normal for marine craft. A typical profile would be: 25 percent of the time at nominal +10 percent; 25 percent of the time at nominal -10 percent; and 50 percent of the time at nominal. Unless otherwise specified by the procuring activity, the duty cycle of input power should be 10 percent OFF and 90 percent ON, in a preselected irregular pattern.

6.6.4 Underwater vehicles. Environmental test data which is appropriate for the reliability testing of underwater vehicles is presented in Reference 19. Government Program Managers and equipment developers are referred to Reference 19 for appropriate test data. It should be noted that the data in this report applies only to the MK-50 torpedo; other systems may require extrapolation of data.

6.7 Combined environments for jet aircraft equipment. A combined-environments test cycle should be used whenever possible for testing jet aircraft equipment. During this cycle the thermal stress, vibration, humidity, and input voltage imposed on the test item should be varied simultaneously. The specific test conditions will be determined by the type of aircraft into which the equipment is to be installed, its location within the aircraft, the aircraft mission profiles, the equipment class designation, type of cooling for the compartment in which the equipment is located (air-conditioned or ram air-cooled), and the type of equipment cooling (ambient or supplemental air) which is being used (see Reference 20).

6.7.1 Mission profiles. Each aircraft type is designed to operate within a specific flight envelope and to fly specific mission profiles. The environmental profiles used to test prototype and production aircraft should be based on these flight envelopes and profiles. When design flight envelopes and flight mission profiles are not available, the generalized flight envelopes in

FIGURES 57 through 62, and the tables incorporated into those figures, should be used for developing mission profiles (altitude and speed versus time) for specific aircraft types. From these mission profiles, reasonable and practical environmental test profiles may be developed. The mission profiles are classified by special aspects such as phase altitude, phase Mach number, phase duration, and transition rates between steady-state conditions. If mission profile information is not available, the data in 6.7.2 through 6.7.2.8 should be used to establish the environmental test conditions.

**6.7.2 Environmental test profiles.** The test profile should be developed from the aircraft mission profile. The conditions which must be defined are temperature, vibration, humidity, and input voltage. Each test cycle should consist of two missions. One mission should start in a cold environment and proceed to a hot environment; the second mission should start in a hot environment and return to a cold environment. The mission profile should be analyzed to determine the environmental stress levels for each of the mission flight phases (takeoff, climb, combat, landing, and so forth) as well as for ground conditions. In addition to the information derived from the mission profile, the data specified in a through d should be compiled.

- a. Equipment class
- b. Equipment location within the aircraft
- c. Type of cooling for the compartment in which the equipment is located (air-conditioned or ram air-cooled)
- d. Type of equipment cooling (ambient or supplemental air)

A table of environmental profile data should be prepared for the specific aircraft and equipment under consideration. This tabulation should include the data specified in e through p:

- e. Mission phase
- f. Duration (minutes)
- g. Altitude (thousands of feet)
- h. Mach number
- i. Compartment temperature ( $^{\circ}\text{C}$ )
- j. Temperature rate of change ( $^{\circ}\text{C}$  per minute)
- k. Dynamic pressure  $q$  (pounds per square foot ( $\text{lbs}/\text{ft}^2$ ))
- l. Power spectral density (PSD),  $W_{\alpha}(\text{g}^2/\text{Hz}) = K(q)^2$ , where  $q$  = dynamic pressure
- m. PSD,  $W_1(\text{g}^2/\text{Hz}) = W_0 - 3\text{dB}$
- n. Humidity
- o. Equipment operation
- p. Input voltage

A typical environmental profile data set for equipment attached to structures adjacent to the external surface of a jet-propelled Navy attack aircraft is given in TABLE XXIV. Sources from which environmental data can be obtained and the methodology to be used in entering this data in the table are as provided in 6.7.2.1 through 6.7.2.8. The methodology describes how each stress level should be obtained and presumes that no measured data, either specific or for similar

applications, is available. If measured stress-level data (specific or similar) is available, it should be entered directly into TABLE XXIV. TABLE XXV should then be developed by applying the special vibration and thermal ground rules as provided in 6.7.2.1 through 6.7.5.5.

6.7.2.1 **Mission phase (temperature mode)**. The specific mission phases should be derived from the mission profile. The number, type, and duration of the phase are functions of aircraft type. The ground conditions used for all aircraft and equipment types should include a nonoperating period followed by a period of operation. Since the equipment often will be at either a low or a high temperature when in a nonoperating mode and turn-on will occur while it is still at that thermal condition, both hot and cold starts should be included in the test profile.

6.7.2.2 **Duration**. The duration of each mission flight phase should be obtained from the mission profile. The test time for ground conditions should apply to all aircraft types and missions. The test time for nonoperating and operating temperatures is 30 minutes.

6.7.2.3 **Altitude and Mach number**. Altitude and Mach number should be obtained from the mission profile analysis.

6.7.2.4 **Compartment temperature**. The information specified in a through i should be obtained prior to establishing the compartment temperature levels:

<u>Data</u>	<u>Need</u>	<u>Obtained from</u>
a. Altitude and Mach number	Mandatory	Mission profile analysis (see 6.7.2.3)
b. Equipment class	Mandatory	Equipment design control specification
c. Equipment cooling method (ambient or supplemental)	Mandatory	Equipment design control specification
d. Compartment cooling method (air-conditioned or ram air-cooled)	Mandatory	Equipment design control specification
e. Power dissipation	Desirable	Equipment design control specification
f. Equipment density in compartment (crowded or uncrowded)	Desirable	Air-conditioned design specification
g. Air flow into compartment	Desirable	Thermal design specification
h. Temperature of air flowing into compartment	Desirable	Thermal design specification
i. Compartment area exposed	Desirable	Aircraft design specification

6.7.2.4.1 Ambient-cooled equipment. The data for ambient-cooled equipment are provided in a through b (3):

- a. Hot-day temperature: Using the altitude, Mach number, the Class, and compartment cooling information, enter TABLE XXVI, XXVII, or XXVIII as appropriate to determine hot-day compartment temperatures for each of the mission flight phases. For the ground conditions (nonoperating and operating), a temperature of + 55°C should be used for Class I equipment and + 71°C for Class II equipment.
- b. Cold-day temperature: Cold-day compartment temperatures for equipment in ram air-cooled compartments should be selected from TABLE XXIX. For equipment located in air-conditioned compartments, cold-day temperatures should be selected from the methods provided in 1 through 3. The method selected depends on the amount of information available. For the ground conditions (nonoperating and operating), a temperature of -54°C should be used for both Class I and Class II equipment.
  1. Method I: If a limited amount of information is available, such as only the altitude and Mach number, the compartment temperature for each of the mission flight phases should be selected from the cool-compartment temperatures in TABLE XXX.
  2. Method II: If the equipment power dissipation and compartment equipment density are known in addition to altitude and Mach number, the cool- or warm-compartment temperatures should be selected for each of the mission flight phases from TABLE XXX as follows:
    - A. Warm-compartment selection: If the equipment power dissipates a high wattage and the compartment contains many other equipments tending to impede cooling air flow, temperatures should be selected from the warm-compartment values.
    - B. Cool-compartment selection: If the equipment power dissipation is minimal and the compartment is relatively uncrowded with free, unrestricted airflow, the compartment temperature should be selected from the cool-compartment values.
  3. Method III: When additional thermal and design engineering data are available, the compartment cold-day temperature can be calculated for the mission flight phases using the following expression:

$$T(Comp) = \frac{3.41 \times Q(Elec) + 14.4(1.8)W \times T(in) + U \times 1.8 \times A \times T(rec)}{1.8(U \times A + 14.4W)}$$

where:

Q(Elec) = Electrical load (watts)

W = Air-conditioned flow rate into compartment (pounds per minute)

- T(in) = Temperature of air flowing into compartment (°C)
- U = Overall heat transfer coefficient, British thermal units per minute per square foot per degree Celsius (BTU/min/ft<sup>2</sup>/°C)
- A = Compartment area exposed to ambient (square feet (ft<sup>2</sup>))
- T(rec) =  $(1 + 0.18M^2)(T_A + 273) - 273$  (°C)
- M = Mach number
- T<sub>A</sub> = Ambient temperature (°C) at altitude

<u>Altitude (1000 ft)</u>	<u>Temperature (°C)</u>
0	- 51
10	- 26
20	- 43
30	- 62
40	- 65
50	- 73

**6.7.2.4.2 Supplementally cooled equipment.** Supplementally cooled equipment for hot day compartment temperature and cold-day compartment temperature should be established in accordance with 6.7.2.4.1. The flow rate, temperature, and dewpoint temperature of the supplemental air should be selected in accordance with the equipment specification during all phases of the mission profile which require equipment operation. During the ground nonoperating phases, the supplemental air flow should be zero. During chamber air heatup, the mass flow of supplemental air should be the minimum specified in the equipment specification and this should be maintained until chamber air cool down. During chamber air cool down, the mass flow of supplemental air should be the maximum specified in the equipment specification and this should be maintained until chamber air heatup.

**6.7.2.4.3 Temperature rate of change.** A temperature rate of change should be calculated for each mission phase which involves a change in altitude or Mach number. This should be accomplished by calculating the compartment temperatures of the steady-state conditions bounding the phase in which altitude or Mach number varied, calculating the temperature difference of the bounding phases, and then dividing this value by the duration of the varying altitude or Mach number phase. In the example presented in TABLE XXV, takeoff and climb to altitude have been considered as a single phase from a thermal point of view. In certain cases, two consecutive mission phases may involve such changes as a dive followed by a climb or a loiter condition followed by a dash. In such situations, a temperature rate of change should be calculated for each of the two phases. The example provided below illustrates the procedure:

Example of temperature rate of change calculation

An aircraft in a cruising mode suddenly climbs, then dives, and finally resumes cruising. FIGURE 63 shows this action. The following tabulation lists the phases and accompanying data:

<u>Phase</u>	<u>Duration (minutes)</u>	<u>Mach Number</u>	<u>Altitude (per 1000 ft)</u>	<u>Compartment T(°C)</u>	<u>°C per minute</u>
Cruise	11.3	0.85	1	1.5	
Climb	1.0	0.75	1 to 8	3.0	1.5 (use 5)
Dive	5.0	0.80	8 to 1	13.0	2.3 (use 5)
Cruise	10.7	0.85	1	1.5	

Thermal rates of change are calculated as follows:

CLIMB (cold day cool compartment)

Temperature = + 3°C at 8000 ft and Mach Number = 0.75

Temperature = + 1.5°C at 1000 ft and Mach Number = 0.85

$$Rate = \frac{3^{\circ}C - 1.5^{\circ}C}{1.0 \text{ minute}} = 1.5^{\circ}C \text{ per minute}$$

DIVE (cold day, cool compartment)

Temperature = + 13°C at 8000 ft and Mach Number = 0.80

Temperature = + 1.5°C at 1000 ft and Mach Number = 0.85

$$Rate = \frac{13^{\circ}C - 1.5^{\circ}C}{5.0 \text{ minutes}} = 2.3^{\circ}C \text{ per minute}$$

**6.7.2.5 Vibration.** The random vibration level should be determined for each of the mission phases using the information in TABLE XXIV and FIGURES 64 and 65. Special-case vibration data is contained in TABLE XXXI. Select a value of dynamic pressure (q) from FIGURE 64 for each steady-state condition as a function of Mach number and altitude. For transient conditions such as dive, the (q) value should be determined using the Mach number for that phase, if known, and the average altitude for that phase. If the Mach number is not known, the (q) value should be computed as the arithmetical average of the (q) at the start of a dive plus that at the termination of the dive:

$$\frac{(q_{start} + q_{termination})}{2} = q_{average}$$

If the altitude and Mach number combination is such that the value of (q) is less than 76, use  $q = 76$ . The PSD ( $W_0$ ) should then be computed in accordance with the requirements of TABLE XXXI. FIGURE 64 should then be employed to determine the spectrum shape (test envelope) and a ( $W_1$ ) calculated if required.

6.7.2.6 **Humidity.** Humidity should be injected into the test chamber and a dewpoint temperature of + 31°C or greater should be maintained during the initial portion of the ground, nonoperating phase for a hot day. This level of dewpoint should be maintained and controlled until the end of the ground, operating phase for a hot day. No further injection of moisture is required for any of the other profile phases and the humidity during these phases should be uncontrolled. The dewpoint temperature should be maintained and controlled at 31°C or greater for each subsequent cycle during the hot-day ground, nonoperating and operating conditions. Chamber air should not be dried at any time during a test cycle. RH should be controlled to  $\pm 5$  percent RH.

6.7.2.7 **Equipment operation.** The equipment should be in an operating mode during all phases of a test profile except for the ground, nonoperating phases.

6.7.2.8 **Electrical stress.** Input voltage should be maintained at 110 percent of nominal for the first test cycle, at the nominal value for the second test cycle, and at 90 percent of the nominal for the third test cycle. This sequence should be repeated continuously during subsequent cycles throughout the test. The equipment should be turned ON and OFF at least twice before power is applied continuously to determine startup ability at the extremes of the thermal cycle.

6.7.3 **Construction of an environmental profile.** See FIGURE 66, which presents the environmental profile resulting from the data entered in the example (see TABLE XXIV), was derived from the mission profile presented in FIGURE 67. It should be noted that in the example (see TABLE XXV, combat cruise phase) a change in temperature is obtained even though no change in altitude occurs. This is due to an acceleration followed by a deceleration. In this case, no temperature rate of change has been defined since the acceleration and deceleration are extremely rapid.

6.7.4 **Test profile development.** The environmental profile developed in 6.7.3 should now be converted into a test profile which reproduces those phases of the environmental profile which reflect the equipment exposure and which can be simulated in a test facility. When converting from the environmental to the test profile, the ground rules and procedures in 6.7.4.1 through 6.7.4.4 should be used.

6.7.4.1 Vibration. A maximum of four vibration levels ( $W_0$  values) should be used in any particular test profile for each of the two missions (cold day and hot day). These levels should be established using the steps specified in a through d (steps 1 through 4):

- a. Step 1. Review the ( $W_0$ ) values listed for each phase and delete any levels which are less than 0.001.
- b. Step 2. Identify the ( $W_0$ ) and duration associated with takeoff and apply these values to the test profile as shown in TABLE XXV.
- c. Step 3. Identify the ( $W_0$ ) and durations associated with the highest and lowest (q) levels and apply these values to the test profile during the phases in which they occurred.
- d. Step 4. The fourth level of ( $W_0$ ) is established by calculating a time-weighted average of the ( $W_0$ ) values remaining after identification of the takeoff, minimum, and maximum levels. This is accomplished by multiplying each ( $W_0$ ) by its duration, adding these products, and then dividing this sum by the sum of the durations. The resulting fourth level should be applied to those test phases associated with the environmental profile phases which were used to calculate the fourth test level. In each case the duration should be as stipulated in TABLE XXIV for that particular phase. For certain aircraft flying relatively benign missions, all or most ( $W_0$ ) values may be less than  $0.001\text{g}^2/\text{Hz}$ .

A value of  $W_0 = 0.001\text{g}^2/\text{Hz}$  should be stipulated for mission flight phases not accounted for by any of the four ( $W_0$ ) defined in a through d (steps 1 through 4) above.

6.7.4.2 Temperature. If the temperature rate of change calculated for any transient condition is less than  $5^\circ\text{C}$  per minute, a value of  $5^\circ\text{C}$  per minute should be used. Any thermal condition which is less than  $10^\circ\text{C}$  or less than 20 minutes in duration should be deleted from the test profile.

6.7.4.3 Example of test profile. FIGURE 68 is the test profile developed from the sample mission and environmental profiles. TABLE XXIV lists in tabular form the actual data used to construct the test profile. Note that the transient thermal condition ( $-19^\circ\text{C}$  to  $-10^\circ\text{C}$  for a period of 5 minutes) was deleted from the test profile. All values of temperature rate of change which were less than  $5^\circ\text{C}$  per minute were changed also. The durations of those phases were reduced and all other phase durations were maintained as originally specified. Three levels of vibration remained after application of the ground rules: takeoff, minimum, and maximum. The ( $W_0$ ) associated with takeoff is selected from TABLE XXIV; a maximum of  $W_0 = 0.007$  and a minimum of  $W_0 = 0.0019$  were obtained from this table after all values of  $W_0 < 0.001$  were excluded. Since these values and their associated durations did not account for the total mission time, a level of  $W_0 = 0.001\text{g}^2/\text{Hz}$  was specified for unaccounted time periods (see TABLE XXV)

6.7.4.4 Test profiles for various aircraft types. Unless otherwise specified by the procuring activity, the test profiles shown in FIGURES 69 through 102 should be used during

reliability testing. These profiles were derived from the mission profiles in FIGURES 57 through 62 using the methods in 6.7.4.1 through 6.7.4.3.

6.7.5 Composite environmental test profile for multimission applications. A composite test profile should be developed for those situations where it is anticipated that the equipment will be used during more than one type of mission. In this case, a test profile must be developed for each identified mission for which temperature, vibration, humidity, and input voltage levels and durations have been determined. The composite test profile framework should be structured to retain the concept of two missions in each test cycle. One mission starts from a cold environment and proceeds to a hot environment; the second starts from a hot environment and returns to a cold environment. Provisions have been included in the structure for exposing the equipment to three temperature levels during each mission and four vibration levels during each test cycle. This procedure requires that an environmental test profile for each applicable mission and an estimate of the relative frequency of occurrence of each mission be available to the user.

6.7.5.1 Required information. A test profile for each mission must be developed. Each profile should indicate temperature levels and rates of change and their duration for both the hot-day and cold-day missions. In addition, all vibration levels and corresponding durations should be identified. The estimated relative frequency of occurrence of each mission should be determined from an analysis of the equipment's application and the host platform. A relative frequency of occurrence is defined as the proportion of the total missions contributed by an individual mission type. The sum of the mission weighting factors over all applicable missions should equal 1.0.

6.7.5.2 Temperature. The procedures provided in a through d are identical for the hot-day and cold-day missions. Separate analyses should be performed for each mission.

- a. A table similar to TABLE XXXII should be prepared. Each steady-state temperature level and its corresponding duration should be listed for each applicable mission. The mission-weighting factor for each mission should be identified. The weighted durations should be determined by multiplying each duration by the corresponding mission-weighting factor.
- b. The information presented in TABLE XXXII should be summarized, and a table similar to TABLE 33 should be prepared. Every unique temperature appearing in TABLE XXXII should be listed in ascending order in TABLE XXXIII. Only one entry per temperature value should be made in TABLE XXXIII no matter how many times that value appears in the same or in different missions. The total weighted duration for each temperature level should be determined by summing the weighted durations for each entry of that temperature appearing in TABLE XXXII:
- c. Three levels of temperature and their durations should be selected from those appearing in TABLE XXXII (MAX, INT, MIN). The MAX should be the highest temperature value indicated and the MIN the lowest. The test duration for each should be the corresponding total-weighted duration. The INT level should be determined as the time-weighted average of all the temperature

values appearing in TABLE XXXIII that have not been included in the determination of the MAX and MIN levels. The test duration for the INT level should be computed as the sum of the total weighted durations of those temperature values used in the determination of INT value.

For example, if the following are given:

Temperature level °C	<u>Total-weighted duration</u> (minutes)
20	15
5	10
3	20

$$INT = \frac{(20 \times 15) + (5 \times 10) + (3 \times 20)}{15 + 10 + 20} = \frac{410}{45} = 9.1^{\circ}C$$

Duration = (corresponding times)

$$= 15 + 10 + 20$$

$$= 45 \text{ minutes}$$

- d. When determining MAX (or MIN) level, combine all temperature values in TABLE XXXIII within 5°C of the highest (or lowest) value by the method of time-weighted average. Duration for MAX (or MIN) should be the sum of the corresponding total-weighted durations. If either the MAX or MIN levels do not have a duration of at least 20 minutes, determine a new value of MAX or MIN by time weighting with the next most severe level(s) until a 20-minute duration is achieved by summing the corresponding weighted durations. If the INT level does not have a duration of at least 20 minutes, specify it to be 20 minutes and subtract one-half the difference between 20 minutes and the INT duration from both the MAX and MIN duration. If all the temperature levels of TABLE XXXIII have been exhausted while computing the MAX and MIN levels and the INT level cannot be determined, identify the level with the longest time. Assume that that level is to be the INT level also. Use half the duration for the MAX or MIN level (as appropriate) and the other half as the duration for INT.

6.7.5.3 Vibration. A table similar to TABLE XXXIV should be prepared. Each vibration level ( $W_0$ ) and its corresponding duration should be listed for each applicable mission. The takeoff (TO) vibration level for 1 minute should be listed separately from a ( $W_0$ ) of the same numerical value which is derived by calculation. Similarly, the ( $W_0$ ) of  $0.001g^2/Hz$  and its

corresponding duration which has been added to require continuous vibration (see 6.7.2.5) should be listed separately from a ( $W_0$ ) of  $0.001g^2/Hz$  that was derived by calculation. These two entries should precede any other mission vibration entries. Each mission's weighting factor should be identified. Weighted durations should be determined by multiplying each duration by its corresponding mission weighting factor. The information presented in TABLE XXXIV should be summarized and a table similar to TABLE XXXV should be prepared. The TO and  $0.001g^2/Hz$  levels identified in 6.7.2.5 and the total weighted duration should be listed separately and apart from the same values determined by calculation. All other unique vibration levels ( $W_0$ ) appearing in TABLE XXXIV should be listed in TABLE XXXV in ascending order. Only one entry per ( $W_0$ ) should be made in TABLE XXXV irrespective of how many times that value appears in the same or in different missions. The total weighted duration for each ( $W_0$ ) value should be determined by summing the weighted durations for each entry of that ( $W_0$ ) in TABLE XXXIV. A ( $W_0$ ) of TO for 1 minute (takeoff condition) should be selected. The minimum ( $W_0$ ) of  $0.001g^2/Hz$  corresponding to continuous vibration during the flight phases should be applied for a period equal to its total-weighted duration. In addition, three levels (MAX, INT, MIN) should be determined for the remaining values provided in TABLE XXXV. The MAX level should be the highest ( $W_0$ ) listed and the MIN level should be the lowest ( $W_0$ ) listed. The test duration for each should be the corresponding total-weighted duration. The INT level should be determined as the time weighted average of the remaining ( $W_0$ ). The test duration for the INT level should be the sum of the total weighted durations of the ( $W_0$ ) used in determining NT.

6.7.5.4 Construction of the composite test profile. Construction of the composite test profile is provided in 6.7.5.4 through 6.7.5.4.5.

6.7.5.4.1 Temperature. One test cycle should consist of the sequence of levels specified in a through k:

- a.  $-54^{\circ}C$  (nonoperating)
- b.  $-54^{\circ}C$  (operating)
- c.  $INT_C$  (cold day)
- d.  $MAX_C$  (cold day)
- e.  $MIN_C$  (cold day)
- f.  $+71^{\circ}C$  (nonoperating)
- g.  $+71^{\circ}C$  (operating)
- h.  $INT_H$  (hot day)
- i.  $MAX_H$  (hot day)
- j.  $MIN_H$  (hot day)
- k. Return to  $-54^{\circ}C$  (nonoperating)

The duration at the two  $-54^{\circ}C$  conditions and the two  $+71^{\circ}C$  conditions should be 30 minutes each. The duration at each of the other levels should be determined using the procedure in 6.7.5.2. The temperature rate of change between any two levels should be determined by reviewing comparable phases of each individual test profile and selecting the most typical value. The duration of exposure to a temperature rate of change should be determined from:

$$\text{Duration} = \frac{\text{end temperature} - \text{start temperature}}{\text{rate of change}}$$

The entire cycle with dwells at all levels and transitions between levels should be listed in a table similar to TABLE XXXVI or depicted graphically as FIGURE 103.

6.7.5.4.2 **Vibration.** The vibration requirements should be integrated with the temperature timeline. The MAX vibration level should start at the same time as the MAX temperature levels and continue for the time period determined in 6.7.5.3. The MIN vibration level should start at the conclusion of the exposure to the MAX vibrations levels and continue for the time determined in 6.7.5.3. The exposure to the INT vibration level for the time determined in 6.7.5.3 should start at a time calculated to assure that its completion coincides with the start of the MAX vibration level. The takeoff level should be applied for 1 minute at the start of each of the transitions from  $-54^{\circ}\text{C}$  to INT and from  $+71^{\circ}\text{C}$  to INT. A level of  $0.001\text{g}^2/\text{Hz}$  should be applied during all other periods, except for the  $-54^{\circ}\text{C}$  and  $+71^{\circ}\text{C}$  soaks. The vibration requirements for one complete cycle should be listed in a table similar to TABLE XXXVI or depicted graphically as in FIGURE 103.

6.7.5.4.3 **Humidity.** Humidity should be injected into the test chamber and a dewpoint temperature of  $+31^{\circ}\text{C}$  or greater attained during the initial portion of the ground, nonoperating phase for a hot day. The dewpoint temperature should be maintained and controlled until the end of the ground, operating phase for a hot day. No further injection of moisture is required for any of the other profile phases, and the humidity during these phases should be uncontrolled. The dewpoint temperature should be maintained and controlled at  $+31^{\circ}\text{C}$  or greater for each subsequent cycle during the hot day ground, nonoperating and operating conditions. Chamber air should not be dried at any time during a test cycle.

6.7.5.4.4 **Equipment operation.** The equipment should be in an operating mode during all phases of a test profile, except for the ground, nonoperating phases.

6.7.5.4.5 **Electrical stress.** The input voltage should be maintained at 110 percent of nominal for the first test cycle, at the nominal value for the second test cycle, and at 90 percent of the nominal for the third test cycle. This sequence should be repeated continuously during subsequent cycles during the test. The equipment should be turned ON and OFF at least twice before power is applied continuously to determine startup ability at the extremes of the thermal cycle.

6.7.5.5 **Example of composite test profile.** This example provides the procedure for developing a composite environmental test profile for a Class II equipment that is attached to structures adjacent to the external surface of a jet fighter aircraft. The following data indicates the missions in which the equipment is used and the relative frequency of occurrences of each mission:

<u>Mission type</u>	<u>Relative frequency of occurrence</u>
Low-low-low	0.10
High-low-low-high	0.40
Low-low-high	0.25
Close support	0.20
Ferry	<u>0.05</u>
Total	1.00

Since these conditions correspond to those of the sample test profiles shown in FIGURES 69 through 102, they may be used directly. FIGURES 89 through 93 are corresponding test profiles for the missions enumerated above. Temperature and vibration levels and durations may be read directly from these figures. The application of the procedure is illustrated in the tables listed in a through c:

- a. TABLES 37 and 38: hot day temperature
- b. TABLES 39 and 40: cold day temperature
- c. TABLES 41 and 42: vibration

Rates of change of temperature between levels are determined by reviewing the corresponding phases of the individual test profiles and selecting the most appropriate one. The selected rates and calculated durations are listed in TABLE XLIII. The completed composite profile is provided in a timeline in TABLE XLIV and shown in FIGURE 104.

6.8 Combined environments for V/STOL equipment. The combined environments for Types A and B V/STOL aircraft (see Reference 21) are specified in a and b:

- a. Type A is a twin-engine, subsonic aircraft designed for sea control and utility missions, including antisubmarine warfare, aircraft early warning, tanker service, ordnance delivery, and assault. This aircraft can take off and land vertically or horizontally. Vertical operations are accomplished by a rotation of the engines.
- b. Type B is a twin-engine, supersonic aircraft which is approximately 10,000 pounds lighter than the Type A aircraft. The Type B aircraft is designed for a fighter-attack role and can perform intercept and surveillance missions. This aircraft also can take off and land in a vertical or conventional mode. The vertical mode is accomplished by use of engine exhaust deflectors.

6.8.1 Mission description. The generalized missions for the V/STOL aircraft provided in 6.8.1.1 and 6.8.1.2 represent the current view of the future role envisioned for V/STOL aircraft. Each mission is described by spatial aspects required for the development of the environmental test. Aircraft speed and altitude enroute to the combat area, during combat, and return to the ship are identified. The missions and the characteristics for each type of V/STOL aircraft are provided. Although each type of aircraft can take off and land in a conventional mode, it is assumed that all takeoffs and landings will be performed vertically. The V/STOL mission profiles are presented graphically in FIGURES 105 through 114.

6.8.1.1 Type A V/STOL missions. Type A V/STOL missions are defined in a through g:

- a. Airborne early warning: Take off vertically, climb to altitude, cruise Out, loiter, and cruise back at high altitude, descend, land vertically
- b. Antisubmarine warfare: Take off vertically, climb to altitude, cruise Out, loiter, deliver ordnance, cruise back at high altitude, descend, land vertically
- c. Contact investigation: Take off vertically, climb to altitude, dash at low altitude, loiter and deliver ordnance at low altitude and low speed climb to high altitude, cruise back at high altitude, descend, land vertically
- d. Marine assault: Take off vertically, cruise Out at sea level, hover at 3000 ft, cruise back at sea level, land vertically
- e. Surface attack: Take off vertically, climb to altitude, cruise out at high altitude, loiter and deliver ordnance at 20,000 ft at low speed, cruise back at high altitude, descend, land vertically
- f. Tanker: Take off vertically, climb to altitude, cruise out at high altitude, loiter at low speed and low altitude to transfer fuel, cruise back at high altitude, descend, land vertically
- g. Vertical onboard delivery: Take off vertically, climb to altitude, cruise at high altitude, descend, land vertically

6.8.1.2 Type B V/STOL missions. Type B V/STOL missions are defined in a through c:

- a. Combat air patrol: Take off vertically, climb to altitude, cruise out and loiter at high altitude, engage in combat at high speed and lower altitude, cruise back at high altitude, descend, land vertically
- b. Deck launched interception: Take off vertically, climb at high speed to altitude, dash out and engage in combat at high altitude and high speed, cruise back at high altitude, descend, land vertically
- c. Subsonic surface surveillance: Take off vertically, climb to altitude, cruise Out and loiter at high altitude, engage in combat at intermediate altitude, cruise back at high altitude, descend, land vertically

6.8.2 Thermal stress. The procedures of 6.7.2 should be applied. Whenever V/STOL designs include cooling systems and techniques designed to maintain cool ambient conditions for electronic hardware, a Class I thermal environment may be used.

6.8.3 Vibration stress. Vibration effects on equipment for V/STOL aircraft operating in a horizontal flight mode are identical to those experienced by conventional fixed-wing aircraft. For vertical flight modes (takeoff and landing), the vibration levels are significantly different because of ground effects. TABLE XLV, an abridged version of TABLE XXXI, should be used for V/STOL; it includes vibration test levels ( $W_0$ ) for V/STOL peculiar takeoff and landing conditions. The OK takeoff and landing W values were calculated using V/STOL engine parameter information for both Types A and B V/STOL aircraft.

6.8.4 **Electrical stress.** The electrical stress for V/STOL aircraft should be applied in the manner described in 6.7.2.8.

6.8.5 **Humidity.** Humidity should be maintained in conformance with 6.7.2.6.

6.8.6 **Equipment operation.** The equipment should be in an operating mode during all phases of a test profile, except for the ground, nonoperating phases.

6.8.7 **Test profiles.** Test profiles for Types A and B V/STOL aircraft are provided in FIGURES 115 through 124.

6.9 **Combined environments for turbopropeller aircraft and helicopter equipment.** Combined environments for turbopropeller aircraft and helicopter equipment are as specified in 6.9.1 through 6.9.2.4.

6.9.1 **Turbopropeller aircraft environments.** The environmental test levels provided herein are applicable to equipments mounted within the fuselage of turbopropeller aircraft. The indicated stress values presented should be used only if actual stress levels are not specified in contractual documents, and mission profiles are not provided. Gunfire induced vibration should be considered when the equipment is mounted in an attack helicopter.

6.9.1.1 **Electrical stress.** Input voltage should be maintained at 110 percent of nominal for the first thermal cycle, at the nominal value for the second thermal cycle, and at 90 percent of nominal for the third thermal cycle. This cycling procedure should be repeated continuously throughout the reliability development test. The sequence may be interrupted for repetition of input voltage conditions related to a suspected failure. The equipment should be turned ON and OFF at least twice before power is applied continuously to determine startup ability at the extremes of the thermal cycle.

6.9.1.2 **Vibration.** The random vibration envelope in FIGURE 125 should be used. The vibration should be applied during the thermal cycle of FIGURE 126 at the indicated levels for 12.5 minutes at start of phases B and G and for 12.5 minutes at the start of the mission objective maneuvers during phases C and H. If the mission profile has no maneuvers, the full vibration level should be applied for 12.5 minutes midway during phases C and H. For the remaining portion of the test period, the vibration level should be reduced to 50 percent of the levels of FIGURE 125.

6.9.1.3 **Thermal stress.** The general thermal test profile to be used is shown in FIGURE 126. This profile simulates both cold day and hot day missions, which together form one cycle. The thermal cycle is continuously repeated until the end of the test. Prior to the start of the first thermal cycle, or after storage at room ambient, the equipment should be allowed to cold soak for 1.5 hours at the low temperature of the start of the next thermal cycle.

6.9.1.4 **Humidity stress.** Humidity should be specified to simulate the warm, moist atmospheric conditions especially prevalent in tropical climates. Moisture can be induced

directly into equipment during flight in a humid atmosphere. Installed equipment is also subject to condensation, freezing, and frosting as a result of climatic temperature humidity conditions.

6.9.1.5 Supplementally cooled equipment. The chamber air humidity should be in accordance with 6.7.2.6. The supplemental cooling air may be dried so that the dewpoint temperature is from 3°C to 13°C below the temperature of the supplemental air or the chamber air, whichever is lower.

6.9.1.6 Chamber air humidity. Humidity should be introduced into the test chamber in phase D and increased as the chamber air temperature increases, keeping the dewpoint less than the chamber air temperature. The dewpoint temperature should be raised to 31°C or greater and maintained and controlled through phases E and F of FIGURE 127. At the end of phase F, no further injection of moisture is required for the other profile phases, and humidity should be uncontrolled. This humidity procedure should be repeated for each test cycle and phases D, E, and F. Drying of chamber air should not be accomplished at any time during a test cycle.

6.9.2 Helicopter environments. Unless otherwise specified by the procuring activity, helicopter environments should be derived from the data provided in 6.9.2.1 through 6.9.2.4. The combined environments profile is shown in FIGURE 128, and the combined mission profile in FIGURE 129.

6.9.2.1 Electrical stress. Use the input voltage variation specified in the individual equipment specification. If the equipment specification does not provide this information, use the following:

<u>Normal</u>	<u>High</u>	<u>Low</u>
28 VDC	29	22
115 VAC, 400 Hz alternating current (AC)	122	104

6.9.2.2 Vibration. Unless otherwise specified by the procuring activity, vibration test requirements should be established for equipment installed in rotary wing aircraft. Vibration cycling from 5 Hz to 2000 Hz to 5 Hz for a maximum time of three hours, using a cycle of 36 minutes on each of three axes is required. The equipment should be exposed to a maximum of 5 g. For equipment installed in Army helicopters, the following vibration should be applied: 0.05 inch (1.27 mm) DA from 5 Hz to 24.5 Hz and 1.5 g's pk from 24.5 Hz to 500 Hz. The vibration should be applied continuously from 5 Hz to 500 Hz to 5 Hz. The sweep rate should be logarithmic and take 15 minutes to go from 5 Hz to 500 Hz to 5 Hz. This sweep should be applied once during every hour of equipment operation.

6.9.2.3 Thermal stress. Unless otherwise specified by the procuring activity, the thermal profile for helicopters should be as specified in FIGURE 128. The equipment also should be subjected to a cold soak at 62°C and a hot soak at + 85°C as shown in FIGURE 128.

6.10 Combined environments for air-launched weapons and assembled external stores. A method for modeling air-launched weapons and assembled external store combined

environmental stresses where no flight measured data is available (see Reference 22) is provided in 6.10.1 through 6.10.3. The test profiles are to be tailored from actual mission-defined captive and free-flight environments. The criteria for establishing the mission related environmental test profiles include time dependent thermal, vibration, and electrical stresses with optional humidity and pressure conditions. A general definition of the methodology required and a description of how to establish realistic environmental test profile parameters are provided in 6.10.2. Also, many tables and figures are provided to assist in the construction of representative captive and free-flight environmental test cycles. A combined environments test cycle should be used when testing air-launched weapons and assembled external stores carried by aircraft and helicopters. The equipment mounted inside these stores should be tested as specified in 6.10.1 through 6.10.3. During the environmental test cycle, the thermal stress, vibration (acoustics) humidity, and input voltage imposed on the test item should be varied simultaneously. Specific test conditions should be determined by the type of aircraft upon which the store is carried, and its mission profile, stores logistics and life-cycle profile, the equipment class designation, and free-flight envelope (where applicable). Several other factors, provided in detail in 6.10.1 through 6.10.3, will assist in the development of a test profile. The overall objective is to evaluate store or missile reliability in the test laboratory by simulating the service use environments.

**6.10.1 Mission profiles.** Each aircraft type which carries external stores is designed to operate within a specific flight envelope and fly specific captive-carry mission profiles which may include external store installations on either the fuselage or wing pylons, wing tips, or both. For stores testing, the flight envelopes and mission profiles of the host aircraft(s) should be determined and used in developing the store captive carry environmental test profiles (see TABLES 46 through 53 and FIGURES 130 through 137). When a store is to be used on more than one aircraft, a percentage distribution by aircraft and mission should be used to establish the test profiles. When no specific use information is available, the mission-type distribution in TABLE XLVII may be used. When design flight envelopes and flight mission profiles are not available, the generalized flight envelopes in FIGURES 57 through 62 may be used as a basis for development of the external store captive-carry test profiles. Each store, designated to be launched from a host aircraft, is designed to fly its own specific free-flight mission profile(s). The type(s) mission profile(s) for a store in free-flight is essentially unique to its mission duration, performance, and objectives. Hence, no generalized profiles can be provided. The composite mission profile should be consistent with the expected extremes of free-flight duration, altitude, speed, and, temperatures. An example of the type of information needed is shown in TABLES L and LI and in FIGURE 147.

**6.10.2 Environmental test profiles.** As specified in 6.7.2, the test profile should be developed from the aircraft mission profile. The conditions which must be defined are the selected climatic category temperature, the required operational vibration, humidity, and the input voltage limits. Each test cycle should consist of two segments. One segment should start in the cold environment category and proceed to the hot environment. The second segment should start in the hot environment and return to the cold environment. Test cycles exhibiting these characteristics are shown in FIGURES 130 and 131 and displayed in TABLE XLVI. The mission profile should be analyzed to determine the environmental stress levels encountered for the mission flight phases (takeoff, climb, combat, landing, and so forth) and the ground

conditions. In addition to the information derived from the mission profile, the data should be compiled as specified in a through d:

- a. Equipment class
- b. Equipment location within the store and the store station
- c. Type of cooling for the compartment in which the equipment is located (air-conditioned or ram air-cooled)
- d. Type of equipment cooling (ambient or supplemental air)

A table of environmental profile data should be prepared for the specific aircraft, the stores, and the stores' equipment. This tabulation should include the information for e through p (in addition to the data in the example of 6.10.3):

- e. Mission phase
- f. Duration (minutes)
- g. Altitude (thousands of ft)
- h. Mach number
- i. Compartment temperature ( $^{\circ}\text{C}$ )
- j. Temperature rate of change ( $^{\circ}\text{C}$  per minute)
- k. Dynamic pressure ( $q$ )( $\text{lbs}/\text{ft}^2$ )
- i. PSD,  $W_0$  ( $\text{g}^2/\text{Hz}$ ), spectrum maximum level
- m. PSD,  $W_1$  ( $\text{g}^2/\text{Hz}$ ), spectrum minimum level
- n. Humidity
- o. Equipment operation
- p. Input voltage

Sources from which environmental data can be obtained and the methodology to be used in entering this data in the table are discussed in 6.10.2.1 through 6.10.2.6.2. The methodology describes how each stress level should be obtained and presumes that no measured data is available, either specific or for similar applications. If measured stress level data (specific or similar) is available, it should be used. Test conditions should be then developed by applying the vibration, thermal, and humidity ground rules discussed in 6.10.2.1 through 6.10.2.6.2. The test environments for the free-flight phase simulation are the same as those required for the captive-flight phase specified above. However, the simulation of free-flight environments in the test cycle is limited to post-launch mission profile testing only (including the initial captive-flight launch conditions). Included in this sequence is the thermal transition period from one climatic condition to its subsequent climatic condition (see FIGURE 131 and TABLE XLVI). The phasing of the free-flight test cycle within the overall reliability test sequence depends on the missiles (or stores) projected employment. If a store is projected (by system specification requirements) to be launched after a specific number of captive-flight hours, then the free-flight reliability test cycle should be sequenced to simulate the mission duration and an equivalent percentage of free-flight launches throughout the overall test program. There should be not less than one complete series of free-flight launch test cycles per test item.

6.10.2.1 **Mission phase.** The specific mission phases should be derived from the mission profile. The number, type, and duration of the phase are a function of aircraft type. The ground conditions used for all externally carried stores and equipment types should include a nonoperating period followed by a period of operation. Since the equipment will often be at either a low temperature or a high temperature when in a nonoperating mode and the equipment turn ON will occur while the equipment is still at that thermal condition, both hot and cold starts should be included in the test profile. Each portion of the test cycle will be composed of appropriate combinations of ground and flight environmental extremes.

The first half segment of the total test cycle (see FIGURE 130) starts after the ambient transition to the ground extremes of the specified cold climatic region environment and proceeds through to the completion of the selected hot-climatic mission profile (phases A through H). The second half segment begins at the ground extremes of the specified hot climatic region environment and returns through the remaining climatic phases of the test cycle to the completion of the specified ground cold climatic region environment (phases I through Q). A post-test return to ambient occurs after the completion of the last segment of the scheduled test cycles. The time of each phase (A through Q) is determined by the results of the operational field use study and mission profile(s) requirement.

6.10.2.2 **Duration.** The duration of each mission flight phase should be obtained from the mission profile. When more specific information is lacking, the external store test times specified in a through d can be used:

- a. For a typical air superiority fighter with an air-to-air captive-carry weapon mission only, a typical mission time should be a minimum of 1 hour, 40 minutes.
- b. For a typical tactical or attack aircraft (interdiction aircraft) with an external captive-carry weapon system for an air-to-surface mission or for an aircraft with a supporting electronic warfare mission (assembled external store), a typical mission time should be a minimum of 2 hours.
- c. For a typical air-to-air or air-to-surface strategic aircraft mission (endurance), the minimum mission time should be 24 hours.
- d. For external captive-carried assembled stores on transport cargo-type aircraft (special mission), the assumed minimum mission time should be 6.5 hours.

6.10.2.3 **Electrical stress.** When no values are specified by the individual equipment detail specification, input voltage should be maintained at 110 percent of nominal for the first test cycle, at the nominal value for the second test cycle, and at 90 percent of nominal for the third test cycle. This cycling procedure should be repeated continuously throughout the test. However, this sequence may be interrupted for the repetition of input voltage conditions related to a specific failure. Aircraft and store electrical interface compatibility should be maintained throughout the test cycles. The equipment should be turned ON and OFF at least twice in each thermal phase before continuous power is applied to determine start up ability at the extremes of the thermal cycle. During the nominal input voltage sequences, short-term interrupts (10

microseconds ( $\mu\text{s}$ ) to  $300\mu\text{s}$ ) and long-term interrupts (20 ms to 150 ms) in the power supply should be imposed during the odd-numbered test cycles. When the individual equipment specification requires a standby operating mode during specified operational missions, the input voltage stress variations specified herein for the normal equipment operations should be followed.

**6.10.2.4 Vibration stress.** Random vibration should be applied to the internal equipment item designated for store in aircraft installation in accordance with 6.10.2.4.1, and for the air-launched missile and assembled external stores, in accordance with 6.10.2.4.2. The random vibration test level for each phase of the test cycle should produce the random vibration responses on the test item, required by the maximum predicted environment of FIGURES 132 through 134 and TABLE XLVIII (for ( $g_{\text{rms}}$ ) overall (OVL)) level adjustments and FIGURES 135 through 137 and the equations of TABLE XLIX. The maximum predicted environment is derived from the 95th percentile with 50 percent confidence (for a one-sided tolerance limit) using standard statistical analysis procedures, for the period of maximum overall random vibration level. The baseline data was derived from a detailed study of 1839 separate flight data measurements. When air-launched missiles or assembled external stores are to be installed in more than one location on more than one aircraft, the highest effective random vibration response level of exposure to be encountered by the test item during captive-flight should be computed for each test phase and should be used throughout the captive-flight test. The free-flight response from externally applied vibration should be as defined by the mission profile performance (see 6.10.2).

**6.10.2.4.1 Equipment performance test.** The individual equipment test item(s) should be subjected to random vibration excitation on the most sensitive axis. Equipment hard-mounted in service use should be hard-mounted to the test fixture and soft-mounted equipment should use service isolators when mounted on the test fixture. If service isolators cannot be made available during the test, isolators with comparable dynamic characteristics should be provided. The acceleration PSD of applied vibration ( $g^2/\text{Hz}$ ), as specified on the test fixture at the test item mounting points, should produce the random vibration responses calculated in accordance with 6.10.2.4. The duration of each phase of the tests should be determined from the individual mission analyses.

**6.10.2.4.2 Fully assembled captive-carry stores performance test.** The test item should be mounted using a test setup simulating the actual mounting impedance. The individually installed and operationally capable equipment (inside the fully assembled store) should be mounted in an actual installation configuration. The random vibration input levels, tolerances, and durations for the fully assembled store should be measured responses as specified in 6.10.2.4.3, except that the vibration input level adjustment factors should be reduced 3 dB from the ( $g_{\text{rms}}$ )(OVL) values shown in FIGURES 132 through 134 and TABLE XLVIII. This reduction is applicable only to the fully assembled air-launched missiles and assembled external stores.

6.10.2.4.3 General notes. General notes which provide guidance for the development of test profiles are provided in a through h:

- a. Determination of mission profile vibration levels: The vibration response level for each phase of the profile will be determined from FIGURES 132 through 137 and TABLES XLVIII and XLIX. Where no specific mission profile is available, the procedure of 5.6.2.5 should be used, with the FIGURES 132 through 137 and TABLES XLVIII and XLIX specified above to determine the vibration response levels.
- b. Cargo aircraft: Unless unusual mission profiles are determined, takeoff and cruise profiles (vibration response levels) can be the only required vibration levels.
- c. Minimum ( $W_0$ ) test level: The minimum ( $W_0$ ) vibration response test level should be  $0.001 \text{ g}^2/\text{Hz}$ . If the calculated response test level is less than  $0.001 \text{ g}^2/\text{Hz}$ , the vibration response test minimum  $1.3_{\text{grms}}$  (OVL) spectrum of FIGURES 132 through 137 and TABLES XLVIII and XLIX should be used during this portion of mission profile. This spectrum should produce a minimum vibration response of  $0.001 \text{ g}^2/\text{Hz}$ . If it does not, a ( $W_0$ ) level of  $0.001 \text{ g}^2/\text{Hz}$  should be used.
- d. Option: The maximum ( $W_0$ ) vibration level determined may be used for the vibration response level throughout the test. However, this is not recommended since it is an overttest condition.
- e. Gunfire environment: The gunfire environment is not considered in this test, but should be considered in the environmental qualification test.
- f. Composite vibration profile: When equipments are to be installed in turbopropellers and helicopters (see 6.9), and jet aircraft (see 6.7), a composite random spectrum should be generated. See h below and 6.10.3 for an example of composite spectrum.
- g. Wing and fin tip and fuselage external stores: When a store is to be installed in multiple locations on an aircraft, a composite vibration response profile should be used.
- h. For turbopropellers and helicopters, the special transmission drive and low frequency blade passage excitation forcing functions should be superimposed on the acceleration PSD response spectra obtained from the use of FIGURES 132 through 137 and TABLES XLVIII and XLIX.

6.10.2.5 Thermal stresses. The thermal stresses for supplementary cooled equipments should be determined for each test phase in accordance with 6.10.2.5.1. All other equipments should use 6.10.2.5.2. The duration of the ground test cycles of FIGURE 130 (phase A, D, G, I, L, O, and Q) should be long enough to reach initial stabilization of temperature.

6.10.2.5.1 Supplementally cooled equipments. The flow rate, temperature, and dewpoint temperature of the supplemental air should be in accordance with the individual equipment specification values during all phases, except the nonoperating portions of phases A, D, G, I, L, O, and Q. During these portions of the test phases, the supplemental air flow should be zero.

The thermal environment external to the test item should be in accordance with 6.10.2.5.2. During surrounding external air heat up, the mass flow of supplemental air should be the minimum specified, and this should be maintained until the surrounding external air cools down. During surrounding external air cool down, the mass flow of supplemental air should be the maximum specified, and this should be maintained until the surrounding external air heats up.

6.10.2.5.2 Other equipments. The thermal stresses in each test phase should be in accordance with FIGURES 130 and 131 and TABLE XLVI and the environmental stresses of the applicable mission profile. Use the methods of 6.10.2.1 through 6.10.2.4.3, if a mission profile is not available. An example of the construction of an environmental stress profile is presented in 6.10.3.

6.10.2.6 Humidity stress. Humidity should be specified to simulate the warm, moist atmospheric conditions especially prevalent in tropical climates. Moisture can be induced directly into equipment during flight in a humid atmosphere. Installed equipment is subject to condensation freezing and frosting as a result of climatic conditions. Where applicable, humidity can be varied (from 100 at sea level) directly with the air density ratio, within + 5 percent RH.

6.10.2.6.1 Supplementally cooled equipment. The chamber air humidity should be in accordance with 6.10.2.6.2. The supplemental cooling air may be dried so that its dewpoint temperature is from 3°C to 13°C below the temperature of the supplemental air or the surrounding air, whichever is lower.

6.10.2.6.2 Chamber air humidity. A dewpoint temperature of 31°C or greater should be attained during the initial portion of phases D, G, I, and M of FIGURE 130 and maintained until the end of these phases. No further injection of moisture is required for the other profile phases for the fully assembled stores or for hermetically sealed equipment tests, and the humidity should be uncontrolled. For nonhermetically sealed equipment, the RH should vary from 100 percent at sea level directly with the air density ratio (from 95 percent RH  $\pm$  5 percent RH). The dewpoint temperature should be maintained and controlled at 31°C or greater for each subsequent test cycle in Phases D, G, I, and L. Chamber air should not be dried at any time during a test cycle.

6.10.3 Example of construction of environmental profile. This example illustrates the construction of a composite mission test cycle profile for an aircraft with a captive-flight assembled external store and its internally installed equipment. The example information is as provided in a through e:

- a. Equipment Class 2
- b. Equipment installed in air-conditioned missile or store avionics compartment
- c. Equipment is ambient cooled (no supplemental cooling)
- d. Equipment is attached to the structure forward of external-flow body discontinuities. The body contour forward is smooth and free from discontinuities, that is, no forward control surfaces, antenna blades, or blunt noses

- e. The final environmental requirements for this example are derived from the data specified in 1 through 20:
1. FIGURE 139, Environmental engineering program schematic.
  2. TABLE L, Preliminary operational design requirements (expected life of 5 years).
  3. FIGURE 140, Logistics functional schematic diagram.
  4. FIGURE 141, European scenario assumed maintenance schedule and possible operational utilization rate for environmental analyses (example).
  5. FIGURE 142, Target movement timeline for environmental design criteria (European scenario) - large quantities (example).
  6. FIGURE 143, Estimated percentage of time distribution for transportation, hold/delay, and handling, for nominal-probable factory-to-theater movement timeline.
  7. TABLE LI, Life cycle environments. (A) Distribution of environmental exposures and durations.
  8. FIGURE 144, Assumed typical attack aircraft operating envelope (standard day) showing the assumed high-medium-low mission profile.
  9. FIGURE 145, Assumed typical attack aircraft operating envelope (standard day) showing the assumed high-low-high mission profile.
  10. TABLE LII, Assumed typical attack mission profiles.
  11. TABLE LIII, A method for calculating test profile times for a specific number of test cycles.
  12. FIGURE 146, Vibration factor  $[g_{rms}(OVL)]^2$  flight mission profile (high-medium-low) use with FIGURES 130 and 143 except (\*), versus minimum  $g_{rms}(OVL)^2$  (example).
  13. FIGURE 147, Vibration factor  $[g_{rms}(OVL)]^2$  flight mission profile high-low-high use with FIGURES 130 and 144 except (\*), versus minimum  $g_{rms}(OVL)^2$  (example).
  14. TABLE LIV, Attack aircraft captive-carriage mission profile data example.
  15. FIGURE 138, Low-low free-flight mission profile (example).
  16. FIGURE 148, Store free flight vibration factor  $(g_{rms}(OVL))^2$  flight mission profile low-low use with FIGURES 131 through 134 and TABLE 48 (example).
  17. TABLE LV, Assumed free-flight mission profile for example store (low-low), vibration.
  18. TABLE LVI, Assumed free-flight mission profile for example store (low-low) standard day.
  19. FIGURE 149, Unit  $g_{rms}(OVL)$  acceleration PSD versus frequency spectra (frequencies should be determined by Method 514.3 of MIL-STD-810, as applicable).
  20. TABLES LVII through XL, Composite test cycle profile example timelines.

The event times for determining the temperature for each phase (prior to the adjustment by the test cycle time factor) are given in TABLE XLII. The resulting profiles are given in FIGURES 142 and 143. The temperature rate-of-change for each captive-flight temperature step is greater than or equal to 25°C per minute. The rate of altitude change is approximately set at 10,000 ft per minute, average for captive-flight (time to climb, dive, idle descent). The altitude and temperature rates-of-change for each phase of the example mission are shown in FIGURES 144 and 145 for captive flight, and FIGURE 147 for free-flight. The vibration response conditions (prior to the adjustment by the cycle time factor) are calculated for each flight phase and listed in TABLES XLIV and 55. FIGURE 149 shows the final vibration response test (baseline conditions) PSD to be applied for use with the mission profile vibration response factors of FIGURES 146, 147, and 148. The dewpoint temperature should be raised to 31°C or greater at the beginning of phase D. The 31°C or greater dewpoint temperature should be maintained until the completion of phase L, Ground Operation, Ambient Day. For the remaining phases of the test profile, the humidity should be controlled with the RH starting at 95 percent ( $\pm$  5 percent RH) at sea level and following as closely as possible the density ratio variation expected with altitude. For repeated profile cycles, the dewpoint should be checked as specified herein for phases A through Q. Electrical stress should be in accordance with 6.10.2.3. The final test cycle times should be adjusted by the test cycle time factor from TABLE XLIII. The final composite test cycle profile timeline for the example is given in TABLE XLVII. For this example, the cycle is repeated 10 times (6 high-medium-low missions, 4 high-low-high missions, with one simulated launch on each test item, also consisting of 10 test cycles).

**6.11 Missile transportation, handling, and storage.** The environmental conditions of transportation, handling, and storage also affect equipment performance and reliability. In order to address all of these conditions, TABLE LX has been prepared. This table provides a single point of reference for all environmental conditions which might be encountered as a result of various methods of transportation, handling activities, and storage conditions.

**6.11.1 Rail transport conditions.** The test conditions which are to be used to simulate the effects of vibration, shock, and temperature which result from transporting equipment by rail are provided in 6.11.1.1 through 6.11.1.4 (see Reference 24). These conditions will always assume that the equipment is not operating and therefore no equipment operating parameters or requirements are given.

**6.11.1.1 Vibration testing.** FIGURE 150 encompasses the real world vibration conditions reported by the railroad industry. The three curves shown on FIGURE 150 (best, worst, and nominal) define the complete vibration spectra associated with rail transportation. The worst case (Curve I) represents uncushioned rail transportation and was developed by defining a curve which envelopes all conditions. This curve was generated by visually drawing a straight line which encompassed all applicable data points and was tangential to the maximum values obtained. This curve represents data taken from the power density versus frequency plots of appropriately selected sources. The best case (Curve III) represents data depicting cushioned rail transportation. This curve is taken directly from "An Assessment of the Common Carrier Shipping Environment", by Ostrem and Godshould which is discussed in Reference 24. It is shown as a best case because it represents the vibration environment of a truck trailer mounted

on a rail flatcar. Items transported in this manner are cushioned by both the trailer suspension system and the rail car suspension system. This cushioning effect provides the best protection of equipment with respect to shock and vibration expected during rail transport. The nominal case (Curve II) represents the most probable profile as defined by general rail transport conditions. This curve was defined with the use of the computer generated regression analysis. Using the same data points mentioned for Curve I, a piece-wise, least square linear regression was performed for each of the three segments of the curve. The results of these analyses were combined to produce the single vibration envelope shown as Curve II. These three curves may be selectively specified for rail conveyance simulation tests depending on the damage avoidance requirements established for the equipment.

6.11.1.2 Shock testing. The profile given for shock testing represents the worst-case composite of the shock force data reported for U.S. Rail Transportation conditions. The profile encompasses real-world conditions and provides nominal shock test parameters.

<u>Force</u>	<u>Duration</u>	<u>Axis</u>	<u>Repetition</u>
70g's	10ms	Longitudinal	Every 3 minutes

These conditions are the recommended shock test parameters.

6.11.1.3 Temperature testing. The nominal temperature range to be used in rail transportation testing is specified as follows. As indicated, temperature levels assume a start and end point at room temperature (see FIGURE 151).

<u>Starting point</u>	<u>Low point</u>	<u>High point</u>	<u>End point</u>
24°C	- 32°C	54°C	24°C

6.11.1.4 Test timeline. To integrate reliability testing of all of the critical characteristics, a test timeline is necessary. FIGURE 151 provides that timeline requirement, indicating the schedule relationship between shock, vibration, and temperature testing for both cold day and hot day. Temperature levels must be maintained but are critical only from 15 minutes prior to and during shock testing. Equipment is to be nonoperating and packaged for shipment during testing.

## 7. TEST INSTRUMENTATION AND FACILITIES

**7.1 Purpose.** The purpose of this section is to assure that reliability tests are adequately planned and that properly certified and calibrated equipment and facilities are provided and accepted by the procuring activity, prior to the start of reliability testing.

**7.1.1 Scope.** This section establishes basic requirements for test equipment and facilities used in the performance of reliability tests.

**7.2 Test facilities and apparatus.** Test facilities and apparatus used in the performance of reliability tests should be capable of providing the test conditions discussed in this handbook.

**7.2.1 Test chambers.** Test chambers should be capable of maintaining the environmental conditions of the specified test level. That is, a chamber should be capable of:

- a. Maintaining the ambient and forced air temperatures at the specified temperature level, + 2°C, during the test. The rate of temperature change of the thermal medium, in both heating and cooling cycles, should average not less than 5°C per minute. Chamber and equipment cooling air temperatures should be monitored continuously, or periodically, at a monitoring frequency sufficient to ensure proper chamber operation. Means should be provided to interrupt the programming used in the automatic control of temperature cycling until the maximum and minimum air temperature requirements are satisfied. Protective devices should be installed to shut off the equipment being tested and the heating source, in the case of temperature overruns. However, equipment cooling should be maintained to prevent overheating of the equipment under test.
- b. Maintaining specified vibration within + 10 percent for sinusoidal sweep or single frequency. For random vibration, the rules specified in 1 through 3 apply:
  1. The PSD of the test control signal should not deviate from specified requirements by more than:
    - A. + 100, -30 percent (+ 3 dB, -1.5dB) below 500 Hz
    - B. + 100, -50 percent ( $\pm$  3 dB) between 500 Hz to 2000 Hz
  2. Deviations as large as + 300 percent (+ 6dB) and -75 percent (- 6 dB) should be allowed over a cumulative bandwidth of 100 Hz maximum, between 500 Hz and 2000 Hz.
  3. It is recommended that the vibration equipment be checked for proper operation after each 24 hours of operation and that vibration be monitored with automatic devices to prevent overtest conditions.

**7.2.2 Equipment cooling.** The equipment should be cooled by means of its designed-in cooling system. When it is not practical to test the equipment and its cooling system as a unit, simulated coolant conditions and attributes used should be included in the test procedures. Regardless of the method of cooling, all equipment should be tested under contractually specified

mission and environmental profiles. The coolant attributes should be as specified in 7.2.2.1 and 7.2.2.2.

7.2.2.1 External cooling. When there is little or no mixing between the chamber medium and the coolant such as, in the ducted liquid, ducted gas, or direct blast gas methods, the coolant should be:

- a. The type to be used operationally
- b. At the maximum temperature and the minimum rate of flow (in accordance with input requirements in the individual equipment specification), when the chamber temperature is at the highest
- c. At the minimum temperature and the maximum rate of flow when the chamber temperature is at its lowest. (When the chamber temperature is below the specified lower limit temperature for cooling air, and the equipment is turned OFF, the cooling air supply should correspond to conditions anticipated in the equipment installation.)

7.2.2.2 Internal coolant method. When the gas within the chamber is used as the coolant, it should be:

- a. At a temperature which permits the required test level in the approved test procedure to be attained
- b. At the minimum rate of flow (per coolant input requirements in tested equipment specification) when the chamber temperature is at the highest
- c. At the maximum rate of flow when the chamber temperature is at the lowest

7.2.3 Test instrumentation. Test instrumentation, beyond that required for the environmental chambers, must be provided to measure and monitor the performance parameters of the equipment under test, as listed in the test procedures.

7.2.4 Calibration and accuracy. The environmental and monitoring test facilities should be in proper operating condition. All instruments and test instrumentation used in conducting the tests should have an accuracy of at least one-third of the tolerance for the variable to be measured.

7.2.5 Testing the test facility. The test facility should be tested to ensure that it is operating properly under the required test conditions. Unless otherwise approved by the procuring activity, equipment other than the test samples should be used to verify proper operation of the test facility.

7.2.6 Installation of the test item in the test facility. Unless otherwise specified by the procuring activity, the test item should be installed in the test facility in a manner which simulates service usage. Connections and attached instrumentation should be used only as absolutely necessary for the test. Plugs, covers, and inspection plates not used in operation, but used in servicing, should remain in place. When mechanical or electrical connections are not used, the connections normally protected in service should be adequately covered. For tests in

which temperature values are controlled, the test chamber should be at standard ambient conditions when the test item is installed. The test item should then be operated to determine that no malfunction or damage was caused due to faulty installation or handling.

## 8. NOTES

### 8.1 Intended use.

General application.

### 8.2 Supersession.

This document supercedes all previous issues of MIL-HDBK-781 and MIL-STD-781.

### 8.3 Subject term (keyword) listing.

Combined environmental test conditions  
Environmental Stress Screening (ESS)  
Environmental test profiles  
Life-cycle environmental profiles  
Mission profiles  
Production Reliability Acceptance Tests (PRAT)  
Reliability Development/Growth Tests (RD/GT)  
Reliability Qualification Tests (RQT)  
Reliability test methods  
Reliability test plans

8.4 Changes from previous issue. Marginal notations are not used in this revision to identify changes with respect to the previous issue due to the extent of the changes.

Custodians:  
Army - CR  
Navy - EC  
Air Force - 11

Preparing Activity  
Navy - EC  
  
(Project RELI-0076)

Review activities:  
Army - ME, MI, AR, AV, AT  
Navy - AS, SH, OS  
Air Force - 01, 10, 13, 16, 17, 19.

**MIL-HDBK-781**

**TABLE I. Application matrix.**

MIL-STD-781 Tasks		MIL-HDBK-781	
Task Number	Title	Test Method or Test Plan	Paragraph
202	Reliability Development/Growth (RD/GT)	Duane Method	4.3.2
301	Reliability Qualification Test (RQT)	AMSAA Method	4.3.3
302	Production Reliability Acceptance Test (PRAT)	MTBF Assurance Test Standard, PRST Standard, Fixed-Duration Standard, All-Equipment	4.5 4.6 4.7 4.8
401	Environmental Stress Screening (ESS)	Computed ESS Time Interval Method Graphical Method Standard ESS	4.4.2 4.4.3 4.4.4

TABLE II. Summary of variables for the AMSAA model.

1.	X	Cumulative test time to the <i>i</i> th failure
2.	N	Total number of failures observed
3.	M	N-1
4.	t	Total period of observation
5.	$\mu$	Statistic used to test for trend in the data. The distribution of $\mu$ is in standardized normal form.
6.	$\beta$	A growth parameter estimate used to describe the variation of the failure rate with time. If the failure rate is increasing, the parameter is greater than one. For a constant failure rate, it is equal to one. If the failure rate is decreasing (growth), then it is less than one.
7.	$\bar{\beta}$	An unbiased estimate of the true value of the growth parameter
8.	$\hat{\lambda}$	After the growth parameter estimate has been obtained, it is possible to estimate the scale parameter, $\lambda$ by $\hat{\lambda}$ .
9.	$C_{M}^2$	Cramer-von Mises goodness-of-fit test statistic, as calculated from the observations
10.	$p(X)$	Interval estimate of the failure rate at the time of the last failure
11.	$p(t)$	Interval estimate of the failure rate at a future time

TABLE III. Summary of equations. AMSAA model.

1) $\mu = \frac{\left( \sum_{i=1}^M X_i \right) - \frac{1}{2} X_N}{X_N \sqrt{\frac{1}{12M}}}$	8) $\bar{\beta} = \frac{N-1}{N} \hat{\beta}$
2) $\mu = \frac{\left( \sum_{i=1}^N X_i \right) - \frac{1}{2} t_0}{t_0 \sqrt{\frac{1}{12N}}}$	9) $\lambda = \frac{N}{t_0 \hat{\beta}}$
3) $\hat{\beta} = \frac{N}{N \ln X_N - \sum_{i=1}^M \ln X_i}$	10) $C_M^2 = \frac{1}{12M} + \sum_{i=1}^M \left[ \left( \frac{X_i}{t_0} \right)^{\bar{\beta}} - \frac{2i-1}{2M} \right]^2$
4) $\bar{\beta} = \frac{N-2}{N} \hat{\beta}$	
5) $\hat{\lambda} = \frac{N}{X_N \hat{\beta}}$	
6) $C_M^2 = \frac{1}{12M} + \sum_{i=1}^M \left[ \left( \frac{X_i}{X_N} \right)^{\bar{\beta}} - \frac{2i-1}{2M} \right]^2$	
7) $\hat{\beta} = \frac{N}{N \ln t_0 - \sum_{i=1}^N \ln (X_i)}$	

TABLE IV. Equation selection guide, AMSAA model.

Parameter	Parameter characteristic	Test termination	Equation From TABLE III			
			Large sample $N \geq 20$	Small sample $N < 20$	Scale parameter	Goodness-of-fit statistic
			$\beta$	$\bar{\beta}$	$\lambda$	$C_M^2$
MTBF, $\theta$	Continuous	Failure terminated	3	4	5	6
MTBF, $\theta$	Continuous	Time terminated	7	8	9	10
Probability of success	Discrete	Failure on final trial	3	4	5	6
Probability of success	Discrete	Success on final trial	7	8	9	10

TABLE V. Critical values of  $C_M^2$  parametric form of the Cramer-von Mises statistic.

$M^{1/}$	Level of significance $\alpha$				
	0.20	0.15	0.10	0.05	0.01
2	0.138	0.149	0.162	0.175	0.186
3	0.121	0.135	0.154	0.184	0.231
4	0.121	0.136	0.155	0.191	0.279
5	0.121	0.137	0.160	0.199	0.295
6	0.123	0.139	0.162	0.204	0.307
7	0.124	0.140	0.165	0.208	0.316
8	0.124	0.141	0.165	0.210	0.319
9	0.125	0.142	0.167	0.212	0.323
10	0.125	0.142	0.167	0.212	0.324
15	0.126	0.144	0.169	0.215	0.327
20	0.128	0.146	0.172	0.217	0.333
30	0.128	0.146	0.172	0.218	0.333
60	0.128	0.147	0.173	0.221	0.333
100	0.129	0.147	0.173	0.221	0.336

<sup>1/</sup> For  $M > 100$ , use values for  $M = 100$ .

TABLE VI. Confidence intervals for MTBE, failure-terminated test.

N \ $\gamma$	.80		.90		.95		.98	
	L	U	L	U	L	U	L	U
2	0.8065	33.76	0.5552	72.67	0.4099	151.5	0.2944	389.9
3	.6840	8.927	.5137	14.24	.4054	21.96	.3119	37.60
4	.6601	5.328	.5174	7.651	.4225	10.65	.3368	15.96
5	.6568	4.000	.5290	5.424	.4415	7.147	.3603	9.995
6	.6600	3.321	.5421	4.339	.4595	5.521	.3815	7.388
7	.6656	2.910	.5548	3.702	.4760	4.595	.4003	5.963
8	.6720	2.634	.5668	3.284	.4910	4.002	.4173	5.074
9	.6787	2.436	.5780	2.989	.5046	3.589	.4327	4.469
10	.6852	2.287	.5883	2.770	.5171	3.286	.4467	4.032
11	.6915	2.170	.5979	2.600	.5285	3.054	.4595	3.702
12	.6975	2.076	.6067	2.464	.5391	2.870	.4712	3.443
13	.7033	1.998	.6150	2.353	.5488	2.721	.4821	3.235
14	.7087	1.933	.6227	2.260	.5579	2.597	.4923	3.064
15	.7139	1.877	.6299	2.182	.5664	2.493	.5017	2.921
16	.7188	1.829	.6367	2.144	.5743	2.404	.5106	2.800
17	.7234	1.788	.6431	2.056	.5818	2.327	.5189	2.695
18	.7278	1.751	.6491	2.004	.5888	2.259	.5267	2.604
19	.7320	1.718	.6547	1.959	.5954	2.200	.5341	2.524
20	.7360	1.688	.6601	1.918	.6016	2.147	.5411	2.453
21	.7398	1.662	.6652	1.881	.6076	2.099	.5478	2.390
22	.7434	1.638	.6701	1.848	.6132	2.056	.5541	2.333
23	.7469	1.616	.6747	1.818	.6186	2.017	.5601	2.281
24	.7502	1.596	.6791	1.790	.6237	1.982	.5659	2.235
25	.7534	1.578	.6833	1.765	.6286	1.949	.5714	2.192
26	.7565	1.561	.6873	1.742	.6333	1.919	.5766	2.153
27	.7594	1.545	.6912	1.720	.6378	1.892	.5817	2.116
28	.7622	1.530	.6949	1.700	.6421	1.866	.5865	2.083
29	.7649	1.516	.6985	1.682	.6462	1.842	.5912	2.052
30	.7676	1.504	.7019	1.664	.6502	1.820	.5957	2.023
35	.7794	1.450	.7173	1.592	.6681	1.729	.6158	1.905
40	.7894	1.410	.7303	1.538	.6832	1.660	.6328	1.816
45	.7981	1.378	.7415	1.495	.6962	1.606	.6476	1.747
50	.8057	1.352	.7513	1.460	.7076	1.562	.6605	1.692
60	.8184	1.312	.7678	1.407	.7267	1.496	.6823	1.607
70	.8288	1.282	.7811	1.367	.7423	1.447	.7000	1.546
80	.8375	1.259	.7922	1.337	.7553	1.409	.7148	1.499
100	.8514	1.225	.8100	1.293	.7759	1.355	.7384	1.431

TABLE VII. Confidence intervals for MTBF, time-terminated test.

N \ $\gamma$	.80		.90		.95		.98	
	L	U	L	U	L	U	L	U
2	0.261	18.66	0.200	38.66	0.159	78.66	0.124	198.7
3	.333	6.326	.263	9.736	.217	14.55	.174	24.10
4	.385	4.243	.312	5.947	.262	8.093	.215	11.81
5	.426	3.386	.352	4.517	.300	5.862	.250	8.043
6	.459	2.915	.385	3.764	.331	4.738	.280	6.254
7	.487	2.616	.412	3.298	.358	4.061	.305	5.216
8	.511	2.407	.436	2.981	.382	3.609	.328	4.539
9	.531	2.254	.457	2.750	.403	3.285	.349	4.064
10	.549	2.136	.476	2.575	.421	3.042	.367	3.712
11	.565	2.041	.492	2.436	.438	2.852	.384	3.441
12	.579	1.965	.507	2.324	.453	2.699	.399	3.226
13	.592	1.901	.521	2.232	.467	2.574	.413	3.050
14	.604	1.846	.533	2.153	.480	2.469	.426	2.904
15	.614	1.800	.545	2.087	.492	2.379	.438	2.781
16	.624	1.759	.556	2.029	.503	2.302	.449	2.675
17	.633	1.723	.565	1.978	.513	2.235	.460	2.584
18	.642	1.692	.575	1.933	.523	2.176	.470	2.503
19	.650	1.663	.583	1.893	.532	2.123	.479	2.432
20	.657	1.638	.591	1.858	.540	2.076	.488	2.369
21	.664	1.615	.599	1.825	.548	2.034	.496	2.313
22	.670	1.594	.606	1.796	.556	1.996	.504	2.261
23	.676	1.574	.613	1.769	.563	1.961	.511	2.215
24	.682	1.557	.619	1.745	.570	1.929	.518	2.173
25	.687	1.540	.625	1.722	.576	1.900	.525	2.134
26	.692	1.525	.631	1.701	.582	1.873	.531	2.098
27	.697	1.511	.636	1.682	.588	1.848	.537	2.068
28	.702	1.498	.641	1.664	.594	1.825	.543	2.035
29	.706	1.486	.646	1.647	.599	1.803	.549	2.006
30	.711	1.475	.651	1.631	.604	1.783	.544	1.980
35	.729	1.427	.672	1.565	.627	1.699	.579	1.870
40	.745	1.390	.690	1.515	.646	1.635	.599	1.788
45	.758	1.361	.705	1.476	.662	1.585	.617	1.723
50	.769	1.337	.718	1.443	.676	1.544	.632	1.671
60	.787	1.300	.739	1.393	.700	1.481	.657	1.591
70	.801	1.272	.756	1.356	.718	1.435	.678	1.533
80	.813	1.251	.769	1.328	.734	1.399	.695	1.488
100	.831	1.219	.791	1.286	.758	1.347	.722	1.423

TABLE VIII. AMSAA model example.

1	2	3	4	5	6	7
Failure number	Failure time	$\ln X_i$	$\ln X_i$	$\left[\frac{X_i}{1000}\right]^{4504}$	$\left[\frac{X_i}{1000}\right]^{4504} \frac{-2_i - 1}{30}$	$\sum \left[\frac{X_i}{1000}\right]^{4504} \frac{-2_i - 1}{30}$
1	1.5	.405	.405	.053	$40 \times 10^{-5}$	$40 \times 10^{-5}$
2	3.2	1.163	1.569	.075	$61 \times 10^{-5}$	$101 \times 10^{-5}$
3	11.8	2.468	4.037	.135	$97 \times 10^{-5}$	$199 \times 10^{-5}$
4	29.6	3.388	7.424	.205	$81 \times 10^{-5}$	$280 \times 10^{-5}$
5	53.6	3.982	11.406	.268	$104 \times 10^{-5}$	$385 \times 10^{-5}$
6	65.2	4.177	15.583	.292	$551 \times 10^{-5}$	$937 \times 10^{-5}$
7	119.4	4.782	20.366	.384	$243 \times 10^{-5}$	$1181 \times 10^{-5}$
8	265.3	5.581	25.947	.550	$251 \times 10^{-5}$	$1432 \times 10^{-5}$
9	294.0	5.684	31.630	.576	$9 \times 10^{-5}$	$1441 \times 10^{-5}$
10	441.1	6.089	37.720	.692	$340 \times 10^{-5}$	$1781 \times 10^{-5}$
11	465.1	6.142	43.862	.708	$7 \times 10^{-5}$	$1788 \times 10^{-5}$
12	567.0	6.340	50.202	.774	$6 \times 10^{-5}$	$1794 \times 10^{-5}$
13	685.8	6.530	56.733	.844	$10 \times 10^{-5}$	$1805 \times 10^{-5}$
14	831.4	6.723	63.456	.920	$40 \times 10^{-5}$	$1846 \times 10^{-5}$
15	949.7	6.856	70.312	.977	$10 \times 10^{-5}$	$1857 \times 10^{-5}$

<sup>1/</sup> Terminated at 1000.0

**TABLE IXA.  $(1 - \gamma)100$  percent standard confidence limits on MTBF after accept decision  
 (lower  $\theta$  ( $\gamma$  i)).**

**LOWER CONFIDENCE LIMITS FOR MTBF  $\theta$  ON THE ACCEPTANCE BOUNDARY  
 TEST PLAN I-D  $d = 1.5,$   $\alpha = \beta 0.10$**

NUMBER OF FAILURES (i)	TOTAL TEST TIME	$\gamma = .50$	$\gamma = .30$	$\gamma = .20$	$\gamma = .10$	$\gamma = .05$
0	6.60	9.5218	5.4818	4.1008	2.8864	2.2031
2	9.03	3.3006	2.4386	2.0589	1.6531	1.3957
3	10.25	2.7074	2.0843	1.7977	1.4811	1.2737
4	11.46	2.3664	1.8726	1.6387	1.3743	1.1971
5	12.68	2.1462	1.7326	1.5324	1.3022	1.1453
6	13.91	1.9328	1.6337	1.4569	1.2508	1.1083
7	15.12	1.8785	1.5591	1.3996	1.2117	1.0802
8	16.34	1.7908	1.5014	1.3553	1.1814	1.0585
9	17.55	1.7210	1.4552	1.3197	1.1571	1.0412
10	18.77	1.6645	1.4177	1.2908	1.1374	1.0273
11	19.98	1.6175	1.3864	1.2667	1.1210	1.0158
12	21.20	1.5781	1.3602	1.2465	1.1074	1.0063
13	22.41	1.5443	1.3376	1.2292	1.0957	.9982
14	23.63	1.5153	1.3183	1.2143	1.0858	.9913
15	24.84	1.4839	1.3014	1.2013	1.0772	.9854
16	26.06	1.4677	1.2866	1.1900	1.0697	.9804
17	27.29	1.4482	1.2736	1.1802	1.0632	.9760
18	28.50	1.4307	1.2620	1.1713	1.0574	.9722
19	29.72	1.4150	1.2516	1.1635	1.0523	.9688
20	30.93	1.4009	1.2423	1.1564	1.0477	.9658
21	32.15	1.3881	1.2338	1.1500	1.0437	.9532
22	33.36	1.3764	1.2262	1.1442	1.0400	.9608
23	34.58	1.3658	1.2192	1.1390	1.0367	.9588
24	35.79	1.3551	1.2128	1.1342	1.0337	.9569
25	37.01	1.3472	1.2070	1.1299	1.0310	.9552
26	38.22	1.3390	1.2016	1.1259	1.0285	.9537
27	39.44	1.3314	1.1987	1.1223	1.0263	.9523
28	40.67	1.3245	1.1922	1.1190	1.0243	.9511
29	41.88	1.3180	1.1881	1.1159	1.0224	.9500
30	43.10	1.3120	1.1842	1.1131	1.0207	.9490
31	44.31	1.3064	1.1806	1.1104	1.0192	.9481
32	45.53	1.3012	1.1773	1.1080	1.0177	.9472
33	46.74	1.2964	1.1741	1.1057	1.0164	.9465
34	47.96	1.2918	1.1713	1.1036	1.0152	.9458
35	49.17	1.2876	1.1685	1.1017	1.0141	.9452
36	49.50	1.2797	1.1632	1.0977	1.0116	.9437
37	49.50	1.2662	1.1533	1.0899	1.0064	.9404
38	49.50	1.2493	1.1403	1.0791	.9987	.9351
39	49.50	1.2308	1.1254	1.0664	.9890	.9279
40	49.50	1.2120	1.1097	1.0526	.9780	.9194

TABLE IXA.  $(1-\gamma)$  100 percent standard confidence limits on MTBF after accept decision  
 (lower -  $\theta_{L}^{1}(\gamma, i)$ ). (Continued)

LOWER CONFIDENCE LIMITS FOR MTBF  $\theta$  ON THE ACCEPTANCE BOUNDARY

TEST PLAN II-D

$d = 1.5,$

$\alpha = \beta = 0.20$

NUMBER OF FAILURES (i)	TOTAL TEST TIME	$\gamma = .50$	$\gamma = .30$	$\gamma = .20$	$\gamma = .10$	$\gamma = .05$
0	4.19	6.0449	3.4801	2.6034	1.8197	1.3987
1	5.40	3.1261	2.1477	1.7475	1.3425	1.0984
2	6.62	2.3601	1.7401	1.4669	1.1746	.9889
3	7.83	2.0077	1.5412	1.3264	1.0887	.9326
4	9.05	1.8069	1.4246	1.2432	1.0376	.8993
5	10.26	1.6768	1.3478	1.1882	1.0039	.8776
6	11.49	1.5873	1.2946	1.1501	.9808	.8631
7	12.71	1.5218	1.2555	1.1222	.9641	.8527
8	13.92	1.4718	1.2256	1.1009	.9515	.8451
9	15.14	1.4330	1.2024	1.0844	.9419	.8394
10	16.35	1.4019	1.1839	1.0714	.9344	.8351
11	17.57	1.3769	1.1691	1.0610	.9286	.8317
12	18.78	1.3563	1.1568	1.0525	.9239	.8292
13	19.99	1.3392	1.1467	1.0455	.9201	.8271
14	21.21	1.3249	1.1384	1.0398	.9170	.8255
15	21.90	1.3072	1.1273	1.0320	.9127	.8232
16	21.90	1.2764	1.1059	1.0155	.9023	.8169
17	21.90	1.2420	1.0799	.9943	.8874	.8068
18	21.90	1.2109	1.0546	.9727	.8709	.7946

**TABLE IXA.  $(1-\gamma)$  100 percent standard confidence limits on MTBF after accept decision  
 (lower -  $\theta^L(\gamma, i)$ ). (Continued)**

**LOWER CONFIDENCE LIMITS FOR MTBF  $\theta$  ON THE ACCEPTANCE BOUNDARY**

**TEST PLAN III-D  $d = 2.0, \alpha = \beta = 0.10$**

NUMBER OF FAILURES (i)	TOTAL TEST TIME	$\gamma = .50$	$\gamma = .30$	$\gamma = .20$	$\gamma = .10$	$\gamma = .05$
0	4.40	6.3479	3.6546	2.7339	1.9109	1.4688
1	5.79	3.3364	2.2913	1.8638	1.4311	1.1704
2	7.18	2.5435	1.8741	1.5790	1.2633	1.0627
3	8.56	2.1789	1.6712	1.4372	1.1783	1.0080
4	9.94	1.9708	1.5521	1.3532	1.1278	.9760
5	11.34	1.8385	1.4754	1.2992	1.0956	.9559
6	12.72	1.7466	1.4218	1.2614	1.0734	.9424
7	14.10	1.6799	1.3827	1.2339	1.0575	.9329
8	15.49	1.6300	1.3535	1.2135	1.0459	.9262
9	16.88	1.5916	1.3311	1.1980	1.0372	.9213
10	18.26	1.5613	1.3135	1.1858	1.0305	.9177
11	19.65	1.5371	1.2995	1.1763	1.0254	.9150
12	20.60	1.5112	1.2839	1.1654	1.0194	.9117
13	20.60	1.4661	1.2530	1.1418	1.0045	.9026
14	20.60	1.4173	1.2163	1.1120	.9835	.8882
15	20.60	1.3755	1.1825	1.0830	.9613	.8715

**LOWER CONFIDENCE LIMITS FOR MTBF  $\theta$  ON THE ACCEPTANCE BOUNDARY**

**TEST PLAN IV-D  $d = 2.0, \alpha = \beta = 0.20$**

NUMBER OF FAILURES (i)	TOTAL TEST TIME	$\gamma = .50$	$\gamma = .30$	$\gamma = .20$	$\gamma = .10$	$\gamma = .05$
0	2.80	4.0395	2.3256	1.7397	1.2160	.9347
1	4.18	2.3277	1.5933	1.2927	.9880	.8042
2	5.58	1.8907	1.3822	1.1581	.9181	.7650
3	6.96	1.6995	1.2865	1.0968	.8869	.7485
4	8.34	1.977	1.2351	1.0643	.8710	.7407
5	9.74	1.5385	1.2054	1.0459	.8626	.7368
6	9.74	1.4486	1.1502	1.0066	.8403	.7245
7	9.74	1.3763	1.0986	.9662	.8133	.7069

TABLE IXA.  $(1 - \gamma)$  100 percent standard confidence limits on MTBF after accept decision  
 (lower -  $\theta^L(\gamma, i)$ ). (Continued)

LOWER CONFIDENCE LIMITS FOR MTBF  $\theta$  ON THE ACCEPTANCE BOUNDARY

TEST PLAN V-D  $d = 3.0$ ,  $\alpha = \beta = 0.10$

NUMBER OF FAILURES (i)	TOTAL TEST TIME	$\gamma = .50$	$\gamma = .30$	$\gamma = .20$	$\gamma = .10$	$\gamma = .05$
0	3.75	5.4101	3.1147	2.3300	1.6286	1.2518
1	5.40	3.0397	2.0831	1.6915	1.2950	1.0557
2	7.05	2.4208	1.7755	1.4909	1.1861	.9918
3	8.70	2.1462	1.6333	1.3972	1.1357	.9633
4	10.35	1.9966	1.5547	1.3457	1.1087	.9487
5	10.35	1.1947	1.4266	1.2504	1.0481	.9093
6	10.35	1.6326	1.3112	1.1575	.9811	.8600

LOWER CONFIDENCE LIMITS FOR MTBF  $\theta$  ON THE ACCEPTANCE BOUNDARY

TEST PLAN VI-D  $d = 3.0$ ,  $\alpha = \beta = 0.20$

NUMBER OF FAILURES (i)	TOTAL TEST TIME	$\gamma = .50$	$\gamma = .30$	$\gamma = .20$	$\gamma = .10$	$\gamma = .05$
0	2.67	3.8520	2.2177	1.6590	1.1596	.8913
1	4.32	2.3418	1.5980	1.2932	.9842	.7974
2	4.50	1.6344	1.2039	1.0142	.8111	.6818

LOWER CONFIDENCE LIMITS FOR MTBF  $\theta$  ON THE ACCEPTANCE BOUNDARY

TEST PLAN VII-D  $d = 1.5$ ,  $\alpha = \beta = 0.30$

NUMBER OF FAILURES (i)	TOTAL TEST TIME	$\gamma = .50$	$\gamma = .30$	$\gamma = .20$	$\gamma = .10$	$\gamma = .05$
0	3.15	4.5445	2.6163	1.9572	1.3680	1.0515
1	4.37	2.4854	1.7049	1.3856	1.0622	.8673
2	5.58	1.9410	1.4273	1.2007	.9580	.8035
3	6.80	1.6951	1.2959	1.1118	.9077	.7733
4	6.80	1.4214	1.1207	.9784	.8175	.7092
5	6.80	1.2142	.9756	.8611	.7302	.6412

TABLE IXA.  $(1-\gamma)$  100 percent standard confidence limits on MTBF after accept decision  
 (lower -  $\theta_L^1(\gamma, i)$ ). (Continued)

LOWER CONFIDENCE LIMITS FOR MTBF  $\theta$  ON THE ACCEPTANCE BOUNDARY

TEST PLAN VIII-D  $d = 2.0, \alpha = \beta = 0.30$

NUMBER OF FAILURES (i)	TOTAL TEST TIME	$\gamma = .50$	$\gamma = .30$	$\gamma = .20$	$\gamma = .10$	$\gamma = .05$
0	1.72	2.4814	1.4286	1.0687	.7470	.5742
1	3.10	1.6120	1.0939	.8814	.6656	.5352
2	4.50	1.3867	1.0011	.8298	.6451	.5268



**TABLE IXB.  $(1-\gamma)$  100 percent standard confidence limits on MTBF after accept decision  
 (upper- $\theta^1_{11}(\gamma, i)$ ). (Continued)**  
**UPPER CONFIDENCE LIMITS FOR MTBF S ON THE ACCEPTANCE BOUNDARY**  
**TEST PLAN II-D  $d = 1.5, \alpha = \beta = 0.20$**

NUMBER OF FAILURES	TOTAL TEST TIME (i)	$\gamma = .50$	$\gamma = .30$	$\gamma = .20$	$\gamma = .10$	$\gamma = .05$
1	5.40	6.0449	11.7474	18.7771	39.7682	81.6886
2	6.62	3.1261	4.7865	6.3746	9.8867	14.8006
3	7.83	2.3601	3.3054	4.1254	5.7531	7.7597
4	9.05	2.0077	2.6766	3.2260	4.2544	5.4393
5	10.26	1.8069	2.3329	2.7497	3.5009	4.3300
6	11.49	1.6768	2.1162	2.4553	3.0507	3.6884
7	12.71	1.5873	1.9693	2.2585	2.7563	3.2780
8	13.92	1.5218	1.8630	2.1175	2.5491	2.9943
9	15.14	1.4718	1.7827	2.0117	2.3961	2.7881
10	16.35	1.4330	1.7207	1.9307	2.2801	2.6339
11	17.57	1.4019	1.6713	1.8666	2.1895	2.5150
12	18.78	1.3769	1.6317	1.8153	2.1179	2.4221
13	19.99	1.3563	1.5992	1.7735	2.0599	2.3480
14	21.21	1.3392	1.5722	1.7389	2.0127	2.2884
15	21.90	1.3249	1.5498	1.7103	1.9739	2.2403
16	21.90	1.3072	1.5233	1.6776	1.9316	2.1901
17	21.90	1.2764	1.4819	1.6293	1.8743	2.1273
18	21.90	1.2420	1.4391	1.5818	1.8219	2.0744

**UPPER CONFIDENCE LIMITS FOR MTBF  $\theta$  ON THE ACCEPTANCE BOUNDARY**  
**TEST PLAN III-D  $d = 2.0, \alpha = \beta = 0.10$**

NUMBER OF FAILURES	TOTAL TEST TIME (i)	$\gamma = .50$	$\gamma = .30$	$\gamma = .20$	$\gamma = .10$	$\gamma = .05$
0	4.40	$\infty$	$\infty$	$\infty$	$\infty$	$\infty$
1	5.79	6.3479	12.3362	19.7182	41.7613	85.7828
2	7.18	3.3364	5.1098	6.8060	10.5571	15.8052
3	8.56	2.5435	3.5638	4.4489	6.2057	8.3716
4	9.94	2.1789	2.9069	3.5047	4.6238	5.9135
5	11.34	1.9708	2.5470	3.0036	3.8270	4.7365
6	12.72	1.8385	2.3236	2.6983	3.3570	4.0641
7	14.10	1.7466	2.1710	2.4928	3.0484	3.6333
8	15.49	1.6799	2.0615	2.3469	2.8333	3.3390
9	16.88	1.6300	1.9802	2.2395	2.6775	3.1295
10	18.26	1.5916	1.9181	2.1579	2.5608	2.9752
11	19.65	1.5613	1.8692	2.0941	2.4709	2.8585
12	20.60	1.5371	1.8303	2.0438	2.4009	2.7693
13	20.60	1.5112	1.7905	1.9936	2.3339	2.6873
14	20.60	1.4661	1.7287	1.9206	2.2453	2.5880
15	20.60	1.4173	1.6671	1.8515	2.1682	2.5092

<sup>1</sup> The upper limit on  $\theta$  is infinite, with zero observed failures

**TABLE IXB.  $(1 - \gamma)$  100 percent standard confidence limits on MTBF after accept decision  
 (upper-  $\theta^1_{\gamma, i}$ ). (Continued)**

**UPPER CONFIDENCE LIMITS FOR MTBF  $\theta$  ON THE ACCEPTANCE BOUNDARY  
 TEST PLAN IV-D  $d = 2.0, \alpha = \beta = 0.20$**

NUMBER OF FAILURES (i)	TOTAL TEST TIME	$\gamma = .50$	$\gamma = .30$	$\gamma = .20$	$\gamma = .10$	$\gamma = .05$
0	2.80	$\infty$	$\infty$	$\infty$	$\infty$	$\infty$
1	4.18	4.0395	7.8503	12.5480	26.5754	54.5891
2	5.58	2.3277	3.5732	4.7640	7.3975	11.0817
3	6.96	1.8907	2.6681	3.3453	4.6985	6.3838
4	8.34	1.6995	2.2978	2.7963	3.7496	4.8858
5	9.74	1.5977	2.1073	2.5225	3.3033	4.2253
6	9.74	1.5385	1.9983	2.3693	3.0652	3.8936
7	9.74	1.4486	1.8613	2.1971	2.8387	3.6262

**UPPER CONFIDENCE LIMITS FOR MTBF  $\theta$  ON THE ACCEPTANCE BOUNDARY**

**TEST PLAN V-D  $d = 3.0, \alpha = \beta = 0.10$**

NUMBER OF FAILURES (i)	TOTAL TEST TIME	$\gamma = .50$	$\gamma = .30$	$\gamma = .20$	$\gamma = .10$	$\gamma = .05$
0	3.75	$\infty$	$\infty$	$\infty$	$\infty$	$\infty$
1	5.40	5.4101	10.5138	16.8053	35.5920	73.1104
2	7.05	3.0397	4.6625	6.2143	9.6459	14.4469
3	8.70	2.4208	3.4052	4.2604	5.9625	8.0694
4	10.35	2.1462	2.8849	3.4956	4.6508	6.0038
5	10.35	1.9966	2.6113	3.1057	4.0178	5.0622
6	10.35	1.7947	2.3001	2.7039	3.4489	4.3109

**UPPER CONFIDENCE LIMITS FOR MTBF  $\theta$  ON THE ACCEPTANCE BOUNDARY**

**TEST PLAN VI-D  $d = 3.0, \alpha = \beta = 0.20$**

NUMBER OF FAILURES (i)	TOTAL TEST TIME	$\gamma = .50$	$\gamma = .30$	$\gamma = .20$	$\gamma = .10$	$\gamma = .05$
0	2.67	$\infty$	$\infty$	$\infty$	$\infty$	$\infty$
1	4.32	3.8520	7.4858	11.9654	25.3415	52.0546
2	4.50	2.3418	3.6027	4.8080	7.4730	11.2010

<sup>1</sup> The upper limit on  $\theta$  is infinite, with zero observed failures

TABLE IXB.  $(1 - \gamma)$  100 percent standard confidence limits on MTBF after accept decision  
 (upper- $\theta^1_{U}(\gamma, i)$ ). (Continued)

UPPER CONFIDENCE LIMITS FOR MTBF  $\theta$  ON THE ACCEPTANCE BOUNDARY

TEST PLAN VII-D  $d = 1.5, \quad \alpha = \beta = 0.30$

NUMBER OF FAILURES (i)	TOTAL TEST TIME	$\gamma = .50$	$\gamma = .30$	$\gamma = .20$	$\gamma = .10$	$\gamma = .05$
0	3.15	$\infty$	$\infty$	$\infty$	$\infty$	$\infty$
1	4.37	4.5445	8.8316	14.1165	29.8973	61.4127
2	5.58	2.4854	3.8096	5.0760	7.8765	11.7945
3	6.80	1.9410	2.7236	3.4022	4.7491	6.4095
4	6.80	1.6951	2.2673	2.7375	3.6186	4.6358
5	6.80	1.4214	1.8373	2.1686	2.7706	3.4423

UPPER CONFIDENCE LIMITS FOR MTBF  $\theta$  ON THE ACCEPTANCE BOUNDARY

TEST PLAN VIII-D  $d = 2.0, \quad \alpha = \beta = 0.30$

NUMBER OF FAILURES (i)	TOTAL TEST TIME	$\gamma = .50$	$\gamma = .30$	$\gamma = .20$	$\gamma = .10$	$\gamma = .05$
0	1.72	$\infty$	$\infty$	$\infty$	$\infty$	$\infty$
1	3.10	2.4814	4.8223	7.7080	16.3249	33.5333
2	4.50	1.6120	2.4894	3.3277	5.1811	7.7733

$\infty$  The upper limit on  $\theta$  is infinite, with zero observed failures

TABLE XA.  $(1 - \gamma)$  100 percent standard confidence limits on MTBF after reject decision  
 (lower- $\theta_L^1(\gamma, t)$ ).

LOWER CONFIDENCE LIMITS FOR MTBF S ON THE REJECTION BOUNDARY

TEST PLAN I-D       $d = 1.5,$        $\alpha = \beta = 0.10$

NUMBER OF FAILURES	TOTAL TEST TIME (t)	$\gamma = .50$	$\gamma = .30$	$\gamma = .20$	$\gamma = .10$	$\gamma = .05$
6	.68	.1199	.0971	.0860	.0733	.0647
7	1.89	.2835	.2331	.2083	.1795	.1596
8	3.11	.4072	.3389	.3049	.2849	.2371
9	4.32	.5031	.4228	.3824	.3346	.3010
10	5.54	.5815	.4926	.4476	.3939	.3559
11	6.75	.6454	.5505	.5021	.4441	.4028
12	7.97	.6997	.6004	.5495	.4881	.4443
13	9.18	.7453	.6430	.5902	.5264	.4806
14	10.40	.7852	.6806	.6265	.5606	.5132
15	11.61	.8194	.7134	.6582	.5909	.5422
16	12.83	.8499	.7428	.6868	.6184	.5687
17	14.06	.8773	.7695	.7129	.6436	.5932
18	15.27	.9012	.7929	.7360	.6860	.6150
19	16.49	.9228	.8143	.7572	.6867	.6352
20	17.70	.9420	.8336	.7763	.7055	.6537
21	18.92	.9596	.8513	.7940	.7230	.6709
22	20.13	.9754	.8674	.8101	.7390	.6867
23	21.35	.9901	.8824	.8251	.7540	.7016
24	22.56	1.0033	.8960	.8389	.7678	.7153
25	23.78	1.0157	.9088	.8518	.7808	.7282
26	24.99	1.0269	.9205	.8637	.7928	.7402
27	26.21	1.0374	.9315	.8749	.8041	.7516
28	27.44	1.0473	.9420	.8855	.8149	.7624
29	28.65	1.0562	.9515	.8952	.8248	.7723
30	29.85	1.0644	.9602	.9042	.8339	.7815
31	31.08	1.0723	.9686	.9129	.8428	.7905
32	32.30	1.0797	.9765	.9210	.8511	.7988
33	33.51	1.0864	.9838	.9285	.8588	.8066
34	34.73	1.0928	.9908	.9357	.8662	.8141
35	35.94	1.0987	.9972	.9423	.8731	.8210
36	37.16	1.1044	1.0034	.9487	.8796	.8276
37	38.37	1.1096	1.0091	.9546	.8858	.8338
38	39.59	1.1145	1.0145	.9603	.8916	.8397
39	40.82	1.1193	1.0198	.9658	.8973	.8454
40	42.03	1.1236	1.0246	.9708	.9025	.8506
41	43.10	1.1269	1.0283	.9746	.9064	.8546
41	44.31	1.1369	1.0388	.9853	.9170	.8649
41	45.53	1.1517	1.0536	.9998	.9308	.8779
41	46.74	1.1691	1.0703	1.0159	.9457	.8914
41	47.96	1.1880	1.0880	1.0325	.9607	.9047
41	49.17	1.2069	1.1051	1.0484	.9745	.9165
41	49.50	1.2120	1.1097	1.0526	.9780	.9194

TABLE XA.  $(1-\gamma)$  100 percent standard confidence limits on MTBF after reject decision  
 (lower- $\theta_L^1(\gamma, t)$ ). (Continued)

LOWER CONFIDENCE LIMITS FOR MTBF  $\theta$  ON THE REJECTION BOUNDARY

TEST PLAN II-D       $d=1.5$ ,       $\alpha = \beta = 0.10$

NUMBER OF FAILURES	TOTAL TEST TIME (t)	$\gamma = .50$	$\gamma = .30$	$\gamma = .20$	$\gamma = .10$	$\gamma = .05$
3	.24	.0898	.0664	.0561	.0451	.0381
4	1.46	.3981	.3069	.2649	.2187	.1884
5	2.67	.5831	.4605	.4028	.3380	.2947
6	3.90	.7133	.5733	.5063	.4299	.3782
7	5.12	.8075	.6577	.5851	.5015	.4444
8	6.33	.8783	.7231	.6472	.5590	.4983
9	7.55	.9347	.7765	.6985	.6073	.5440
10	8.76	.9794	.8198	.7406	.6474	.5824
11	9.98	1.0165	.8564	.7765	.6821	.6158
12	11.19	1.0468	.8869	.8067	.7114	.6442
13	12.41	1.0725	.9131	.8328	.7370	.6691
14	13.62	1.0938	.9352	.8549	.7588	.6903
15	14.84	1.1122	.9544	.8743	.7780	.7090
16	16.05	1.1277	.9708	.8909	.7944	.7249
17	17.28	1.1413	.9854	.9056	.8090	.7390
18	18.50	1.1530	.9980	.9184	.8216	.7511
19	18.78	1.1536	.9986	.9191	.8223	.7519
19	19.99	1.1675	1.0135	.9340	.8368	.7654
19	21.21	1.1937	1.0389	.9582	.8586	.7844
19	21.90	1.2109	1.0546	.9727	.8709	.7946

TABLE XA.  $(1 - \gamma)$  100 percent standard confidence limits on MTBF after reject decision  
 (lower -  $\theta^1_{L}(\gamma, t)$ ). (Continued)

LOWER CONFIDENCE LIMITS FOR MTBF  $\theta$  ON THE REJECTION BOUNDARY

TEST PLAN III-D

d = 2.0,

$\alpha = \beta = 0.10$

NUMBER OF FAILURES	TOTAL TEST TIME (t)	$\gamma = .50$	$\gamma = .30$	$\gamma = .20$	$\gamma = .10$	$\gamma = .05$
3	.70	.2618	.1936	.1636	.1315	.1112
4	2.08	.5724	.4403	.3798	.3131	.2696
5	3.48	.7696	.6062	.5296	.4437	.3865
6	4.40	.8403	.6700	.5894	.4983	.4371
6	4.86	.9027	.7232	.6377	.5405	.4751
7	5.79	.9535	.7708	.6832	.5830	.5151
7	6.24	.9998	.8117	.7210	.6169	.5460
8	7.18	1.0383	.8488	.7570	.6512	.5788
8	7.63	1.0746	.8818	.7880	.6795	.6050
9	8.56	1.1037	.9107	.8164	.7069	.6315
9	9.02	1.1332	.9382	.8425	.7312	.6541
10	9.94	1.1556	.9610	.8652	.7534	.6758
10	10.40	1.1793	.9836	.8870	.7738	.6951
11	11.34	1.1980	1.0029	.9063	.7930	.7138
11	11.79	1.2170	1.0214	.9244	.8100	.7300
12	12.72	1.2319	1.0371	.9402	.8258	.7454
12	13.18	1.2479	1.0530	.9557	.8406	.7595
13	14.10	1.2599	1.0657	.9687	.8536	.7722
13	14.56	1.2731	1.0790	.9818	.8661	.7841
14	15.49	1.2831	1.0899	.9929	.8772	.7950
14	15.94	1.2939	1.1009	1.0038	.8877	.8049
15	16.88	1.3025	1.1102	1.0133	.8973	.8142
15	17.34	1.3118	1.1199	1.0229	.9064	.8227
16	18.26	1.3187	1.1275	1.0307	.9142	.8303
16	19.65	1.3484	1.1572	1.0595	.9409	.8543
16	20.60	1.3755	1.1825	1.0830	.9613	.8715

**TABLE XA.  $(1 - \gamma)$  100 percent standard confidence limits on MTBF after reject decision  
 (lower -  $\theta^1_1(\gamma, t)$ ). (Continued)**

**LOWER CONFIDENCE LIMITS FOR MTBF  $\theta$  ON THE REJECTION BOUNDARY**

**TEST PLAN IV-D       $d = 2.0,$        $\alpha = \beta = 0.20$**

NUMBER OF FAILURES	TOTAL TEST TIME (t)	$\gamma = .50$	$\gamma = .30$	$\gamma = .20$	$\gamma = .10$	$\gamma = .05$
2	.70	.4171	.2870	.2338	.1800	.1476
3	2.08	.8127	.5944	.4997	.3996	.3367
4	2.80	.8914	.6843	.5646	.4578	.3898
4	3.46	1.0284	.7767	.6644	.5428	.4646
5	4.18	1.0734	.8193	.7052	.5809	.5004
5	4.86	1.1634	.8977	.7768	.6438	.5567
6	5.58	1.1910	.9251	.8036	.6693	.5809
6	6.24	1.2478	.9767	.8515	.7120	.6192
7	6.96	1.2654	.9948	.8694	.7291	.6353
7	7.62	1.3031	1.0301	.9026	.7586	.6612
8	8.34	1.3147	1.0423	.9146	.7700	.6717
8	9.74	1.3763	1.0986	.9662	.8133	.7069

**LOWER CONFIDENCE LIMITS FOR MTBF  $\theta$  ON THE REJECTION BOUNDARY**

**TEST PLAN V-D       $d = 3.0,$        $\alpha = \beta = 0.10$**

NUMBER OF FAILURES	TOTAL TEST TIME (t)	$\gamma = .50$	$\gamma = .30$	$\gamma = .20$	$\gamma = .10$	$\gamma = .05$
2	.57	.3396	.2337	.1904	.1465	.1202
3	2.22	.8514	.6256	.5271	.4225	.3564
4	3.75	1.0993	.8334	.7141	.5845	.5008
4	3.87	1.1275	.8559	.7338	.6010	.5152
5	5.40	1.2816	.9932	.8613	.7156	.6200
5	5.52	1.3007	1.0094	.8758	.7282	.6313
6	7.05	1.4030	1.1049	.9664	.8118	.7089
8	7.17	1.4164	1.1166	.9772	.8213	.7175
7	8.70	1.4866	1.1845	1.0427	.8825	.7746
7	10.35	1.6326	1.3112	1.1575	.9811	.8600

**LOWER CONFIDENCE LIMITS FOR MTBF  $\theta$  ON THE REJECTION BOUNDARY**

**TEST PLAN VI-D       $d = 3.0,$        $\alpha = \beta = 0.20$**

NUMBER OF FAILURES	TOTAL TEST TIME (t)	$\gamma = .50$	$\gamma = .30$	$\gamma = .20$	$\gamma = .10$	$\gamma = .05$
2	.36	.2145	.1476	.1202	.0926	.0759
3	2.67	1.0053	.7422	.6266	.5034	.4253
3	4.32	1.5801	1.1648	.9819	.7862	.6618
3	4.50	1.6344	1.2039	1.0142	.8111	.6818

TABLE XA.  $(1-\gamma)100$  percent standard confidence limits on MTBF after reject decision  
 (lower-  $\theta^L(\gamma, t)$ ). (Continued)

LOWER CONFIDENCE LIMITS FOR MTBF  $\theta$  ON THE REJECTION BOUNDARY

TEST PLAN VII-D       $d = 1.5,$        $\alpha = \beta = 0.30$

NUMBER OF FAILURES	TOTAL TEST TIME (t)	$\gamma = .50$	$\gamma = .30$	$\gamma = .20$	$\gamma = .10$	$\gamma = .05$
3	1.22	.4562	.3374	.2851	.2292	.1938
4	2.43	.6856	.5245	.4513	.3710	.3188
5	3.15	.7501	.5824	.5052	.4199	.3638
5	3.65	.8322	.6511	.5671	.4735	.4115
6	4.37	.8743	.6908	.6050	.5089	.4448
6	5.58	1.0323	.8263	.7283	.6172	.5422
6	6.80	1.2142	.9756	.8611	.7302	.6412

LOWER CONFIDENCE LIMITS FOR MTBF  $\theta$  ON THE REJECTION BOUNDARY

TEST PLAN VIII-D       $d = 2.0,$        $\alpha = \beta = 0.30$

NUMBER OF FAILURES	TOTAL TEST TIME (t)	$\gamma = .50$	$\gamma = .30$	$\gamma = .20$	$\gamma = .10$	$\gamma = .05$
3	1.72	.6432	.4757	.4020	.3232	.2732
3	3.10	1.1121	.8183	.6885	.5494	.4605
3	4.50	1.3867	1.0011	.8298	.6451	.5268

**TABLE XB.  $(1-\gamma)$  100 percent standard confidence limits on MTBF after reject decision  
 (upper -  $\theta^1_U(\gamma, t)$ ).**

UPPER CONFIDENCE LIMITS FOR MTBF  $\theta$  ON THE REJECTION BOUNDARY

TEST PLAN I-D                       $d = 1.5,$                        $\alpha = \beta = 0.10$

NUMBER OF FAILURES	TOTAL TEST TIME (t)	$\gamma = .50$	$\gamma = .30$	$\gamma = .20$	$\gamma = .10$	$\gamma = .05$
6	.68	.1199	.1505	.1742	.2157	.2602
7	1.89	.2835	.3494	.3995	.4855	.5757
8	3.11	.4072	.4951	.5609	.6724	.7873
9	4.32	.5031	.6052	.6807	.8074	.9365
10	5.54	.5815	.6933	.7751	.9114	1.0488
11	6.75	.6454	.7636	.8496	.9917	1.1339
12	7.97	.6997	.8224	.9111	1.0567	1.2015
13	9.18	.7453	.8711	.9614	1.1090	1.2550
14	10.40	.7852	.9129	1.0042	1.1528	1.2991
15	11.61	.8194	.9484	1.0402	1.1890	1.3350
16	12.83	.8499	.9796	1.0716	1.2201	1.3654
17	14.06	.8773	1.0073	1.0992	1.2472	1.3915
18	15.27	.9012	1.0311	1.1228	1.2700	1.4132
19	16.49	.9228	1.0525	1.1438	1.2900	1.4320
20	17.70	.9420	1.0713	1.1621	1.3073	1.4480
21	18.92	.9596	1.0884	1.1786	1.3227	1.4621
22	20.13	.9754	1.1036	1.1932	1.3361	1.4742
23	21.35	.9901	1.1176	1.2065	1.3482	1.4850
24	22.56	1.0033	1.1301	1.2184	1.3589	1.4944
25	23.78	1.0157	1.1416	1.2293	1.3686	1.5029
26	24.99	1.0269	1.1521	1.2391	1.3772	1.5103
27	26.21	1.0374	1.1617	1.2481	1.3851	1.5170
28	27.44	1.0473	1.1708	1.2565	1.3923	1.5231
29	28.65	1.0562	1.1790	1.2640	1.3988	1.5285
30	29.85	1.0644	1.1863	1.2708	1.4045	1.5332
31	31.08	1.0723	1.1934	1.2772	1.4099	1.5376
32	32.30	1.0797	1.2000	1.2832	1.4148	1.5416
33	33.51	1.0864	1.2060	1.2886	1.4193	1.5451
34	34.73	1.0928	1.2116	1.2936	1.4234	1.5484
35	35.94	1.0987	1.2168	1.2982	1.4271	1.5513
36	37.16	1.1044	1.2217	1.3026	1.4306	1.5540
37	38.37	1.1096	1.2262	1.3066	1.4338	1.5564
38	39.59	1.1145	1.2305	1.3103	1.4367	1.5586
39	40.82	1.1193	1.2345	1.3139	1.4395	1.5607
40	42.03	1.1236	1.2382	1.3172	1.4420	1.5625
41	43.10	1.1269	1.2410	1.3195	1.4438	1.5638
41	44.31	1.1369	1.2500	1.3277	1.4505	1.5690
41	45.53	1.1517	1.2642	1.3410	1.4621	1.5786
41	46.74	1.1691	1.2816	1.3580	1.4777	1.5922
41	47.96	1.1880	1.3011	1.3776	1.4965	1.6095
41	49.17	1.2069	1.3213	1.3982	1.5170	1.6291
41	49.50	1.2120	1.3268	1.4038	1.5228	1.6347

TABLE XB.  $(1-\gamma)$  100 percent standard confidence limits on MTBF after reject decision  
 (upper -  $\theta_{U}^1(\gamma, t)$ ). (Continued)

UPPER CONFIDENCE LIMITS FOR MTBF  $\theta$  ON THE REJECTION BOUNDARY

TEST PLAN II-D  $d=1.5,$   $\alpha = \beta = 0.20$

NUMBER OF FAILURES	TOTAL TEST TIME (t)	$\gamma = .50$	$\gamma = .30$	$\gamma = .20$	$\gamma = .10$	$\gamma = .05$
3	.24	.0898	.1254	.1563	.2178	.2935
4	1.46	.3981	.5291	.6369	.8389	1.0720
5	2.67	.5831	.7537	.8902	1.1394	1.4185
6	3.90	.7133	.9040	1.0538	1.3224	1.6179
7	5.12	.8075	1.0081	1.1638	1.4395	1.7392
8	6.33	.8783	1.0837	1.2415	1.5186	1.8173
9	7.55	.9347	1.1420	1.3000	1.5758	1.8715
10	8.76	.9794	1.1869	1.3442	1.6174	1.9093
11	9.98	1.0165	1.2232	1.3792	1.6492	1.9370
12	11.19	1.0468	1.2522	1.4066	1.6732	1.9572
13	12.41	1.0725	1.2762	1.4289	1.6922	1.9726
14	13.62	1.0938	1.2958	1.4468	1.7070	1.9840
15	14.84	1.1122	1.3123	1.4617	1.7188	1.9929
16	16.05	1.1277	1.3260	1.4738	1.7282	1.9996
17	17.28	1.1413	1.3379	1.4842	1.7360	2.0050
18	18.50	1.1530	1.3479	1.4928	1.7422	2.0092
19	18.78	1.1536	1.3483	1.4932	1.7425	2.0093
19	19.99	1.1675	1.3604	1.5035	1.7499	2.0142
19	21.21	1.1937	1.3854	1.5266	1.7686	2.0277
19	21.90	1.2109	1.4029	1.5436	1.7833	2.0392

TABLE XB.  $(1 - \gamma)$  100 percent standard confidence limits on MTBF after reject decision  
 (upper -  $\theta_{1-\gamma}^A(\gamma, t)$ ). (Continued)

UPPER CONFIDENCE LIMITS FOR MTBF  $\theta$  ON THE REJECTION BOUNDARY

TEST PLAN III-D

d=2.0,

$\alpha = \beta = 0.10$

NUMBER OF FAILURES	TOTAL TEST TIME (t)	$\gamma = .50$	$\gamma = .30$	$\gamma = .20$	$\gamma = .10$	$\gamma = .05$
3	.70	.2618	.3658	.4560	.6352	.8561
4	2.08	.5724	.7631	.9208	1.2184	1.5650
5	3.48	.7696	.9986	1.1831	1.5226	1.9075
6	4.40	.8403	1.0760	1.2643	1.6079	1.9949
6	4.86	.9027	1.1491	1.3444	1.6982	2.0930
7	5.79	.9535	1.2023	1.3984	1.7519	2.1450
7	6.24	.9998	1.2542	1.4535	1.8106	2.2052
8	7.18	1.0383	1.2931	1.4918	1.8469	2.2385
8	7.63	1.0746	1.3322	1.5321	1.8878	2.2783
9	8.56	1.1037	1.3606	1.5594	1.9125	2.2999
9	9.02	1.1332	1.3913	1.5902	1.9423	2.3275
10	9.94	1.1556	1.4125	1.6102	1.9597	2.3419
10	10.40	1.1793	1.4364	1.6336	1.9814	2.3610
11	11.34	1.1980	1.4536	1.6495	1.9946	2.3715
11	11.79	1.2170	1.4724	1.6674	2.0106	2.3849
12	12.72	1.2319	1.4857	1.6795	2.0203	2.3923
12	13.18	1.2479	1.5011	1.6939	2.0326	2.4021
13	14.10	1.2599	1.5116	1.7032	2.0398	2.4073
13	14.56	1.2731	1.5239	1.7146	2.0491	2.4144
14	15.49	1.2831	1.5326	1.7221	2.0547	2.4183
14	15.94	1.2939	1.5425	1.7310	2.0617	2.4234
15	16.88	1.3025	1.5497	1.7371	2.0661	2.4263
15	17.34	1.3118	1.5581	1.7445	2.0718	2.4302
16	18.26	1.3187	1.5638	1.7493	2.0751	2.4323
16	19.65	1.3484	1.5911	1.7739	2.0940	2.4453
16	20.60	1.3755	1.6184	1.7999	2.1161	2.4620

**TABLE XB.  $(1 - \gamma)$  100 percent standard confidence limits on MTBF after reject decision  
 (upper -  $\theta_U^1(\gamma, t)$ ). (Continued)**

**UPPER CONFIDENCE LIMITS FOR MTBF  $\theta$  ON THE REJECTION BOUNDARY**

TEST PLAN IV-D

$d = 2.0$

$\alpha = \beta = 0.20$

NUMBER OF FAILURES	TOTAL TEST TIME (t)	$\gamma = .50$	$\gamma = .30$	$\gamma = .20$	$\gamma = .10$	$\gamma = .05$
2	.70	.4171	.6379	.8491	1.3163	1.9698
3	2.08	.8127	1.1549	1.4606	2.0916	2.9133
4	2.80	.8914	1.2418	1.5517	2.1863	3.0078
4	3.46	1.0284	1.4084	1.7379	2.3998	3.2402
5	4.18	1.0734	1.4541	1.7830	2.4418	3.2774
5	4.86	1.1634	1.5551	1.8891	2.5506	3.3819
6	5.58	1.1910	1.5816	1.9139	2.5716	3.3986
6	6.24	1.2478	1.6413	1.9733	2.6267	3.4455
7	6.96	1.2654	1.2654	1.9876	2.6377	3.4533
7	7.62	1.3031	1.6948	2.0232	2.6677	3.4759
8	8.34	1.3147	1.7049	2.0318	2.6737	3.4797
8	9.74	1.3763	1.7664	2.0895	2.7203	3.5124

**UPPER CONFIDENCE LIMITS FOR MTBF  $\theta$  ON THE REJECTION BOUNDARY**

TEST PLAN V-D

$d = 3.0,$

$\alpha = \beta = 0.10$

NUMBER OF FAILURES	TOTAL TEST TIME (t)	$\gamma = .50$	$\gamma = .30$	$\gamma = .20$	$\gamma = .10$	$\gamma = .05$
2	.57	.3396	.5194	.6914	1.0718	1.6040
3	2.22	.8514	1.2013	1.5104	2.1387	2.9405
4	3.75	1.0993	1.4966	1.8373	2.5110	3.3478
4	3.87	1.1275	1.5322	1.8783	2.5609	3.4057
5	5.40	1.2816	1.7020	2.0557	2.7434	3.5848
5	5.52	1.3007	1.7245	2.0802	2.7703	3.6129
6	7.05	1.4030	1.8304	2.1855	2.8695	3.7010
6	7.17	1.4164	1.8451	2.2009	2.8850	3.7155
7	8.70	1.4866	1.9142	2.2666	2.9421	3.7614
7	10.35	1.6326	2.0766	2.4352	3.1097	3.9145

**TABLE XB.  $(1-\gamma)$  100 percent standard confidence limits on MTBF after reject decision  
 (upper -  $\theta^1_{U}(\gamma, t)$ ). (Continued)**

UPPER CONFIDENCE LIMITS FOR MTBF  $\theta$  ON THE REJECTION BOUNDARY

TEST PLAN VI-D                       $d = 3.0,$                        $\alpha = \beta = 0.20$

NUMBER OF FAILURES	TOTAL TEST TIME (t)	$\gamma = .50$	$\gamma = .30$	$\gamma = .20$	$\gamma = .10$	$\gamma = .05$
2	.36	.2145	.3281	.4367	.6769	1.0130
3	2.67	1.0053	1.4085	1.7602	2.4631	3.3386
3	4.32	1.5801	2.2143	2.7655	3.8626	5.2207
3	4.50	1.6344	2.2915	2.8625	3.9987	5.4047

UPPER CONFIDENCE LIMITS FOR MTBF  $\theta$  ON THE REJECTION BOUNDARY

TEST PLAN VII-D                       $d = 1.5,$                        $\alpha = \beta = 0.30$

NUMBER OF FAILURES	TOTAL TEST TIME (t)	$\gamma = .50$	$\gamma = .30$	$\gamma = .20$	$\gamma = .10$	$\gamma = .05$
3	1.22	.4562	.6375	.7948	1.1070	1.4920
4	2.43	.6856	.9211	1.1183	1.4961 r	1.9450
5	3.15	.7501	.9921	1.1927	1.5743	2.0247
5	3.65	.8322	1.0898	1.3009	1.6974	2.1594
6	4.37	.8743	1.1335	1.3448	1.7402	2.1998
6	5.58	1.0323	1.3164	1.5430	1.9578	2.4286
6	6.80	1.2142	1.5387	1.7939	2.2533	2.7633

UPPER CONFIDENCE LIMITS FOR MTBF  $\theta$  ON THE REJECTION BOUNDARY

TEST PLAN VIII-D                       $d = 2.0,$                        $\alpha = \beta = 0.30$

NUMBER OF FAILURES	TOTAL TEST TIME (t)	$\gamma = .50$	$\gamma = .30$	$\gamma = .20$	$\gamma = .10$	$\gamma = .05$
3	1.72	.6432	.8987	1.1205	1.5607	2.1035
3	3.10	1.1121	1.5594	1.9473	2.7171	3.6659
3	4.50	1.3867	1.9710	2.4763	3.4779	4.7114

TABLE XI. Summary of fixed-duration test plans.

Test Plan	True decision risks (percentage)		Discrimination ratio (d) $\theta_0/\theta_1$	Test duration (multiples of $\theta_1$ )	Number of failures	
	$\alpha$	$\beta$			Reject (equal or more)	Accept (equal or less)
IX-D	12.0	9.9	1.5	45.0	37	36
X-D	10.9	21.4	1.5	29.9	26	25
XLD	19.7	19.6	1.5	21.5	18	17
XII-D	9.6	10.6	2.0	18.8	14	13
XIII-D	9.8	20.9	2.0	12.4	10	9
XIV-D	19.9	21.0	2.0	7.8	6	5
XV-D	9.4	9.9	3.0	9.3	6	5
XVI-D	10.9	21.3	3.0	5.4	4	3
XVII-D	17.5	19.7	3.0	4.3	3	2

TABLE XII. Summary of high risk fixed-duration test plans.

Test Plan	True decision risks (percentage)		Discrimination ratio (d) $\theta_0/\theta_1$	Test duration (multiples of $\theta_1$ )	Number of failures	
	$\alpha$	$\beta$			Reject (equal or more)	Accept (equal or less)
XIX-D	29.8	30.1	1.5	8.1	7	6
XX-D	28.3	28.5	2.0	3.7	3	2
XXI-D	30.7	33.3	3.0	1.1	1	0

TABLE XIII. Demonstrated MTBF confidence limit multipliers for failure calculation.

TOTAL NUMBER OF FAILURES	CONFIDENCE INTERVALS					
	40 PERCENT		60 PERCENT		80 PERCENT	
	70 PERCENT LOWER LIMIT	70 PERCENT UPPER LIMIT	80 PERCENT LOWER LIMIT	80 PERCENT UPPER LIMIT	90 PERCENT LOWER LIMIT	90 PERCENT UPPER LIMIT
1	0.801	2.804	0.621	4.481	0.434	9.491
2	0.820	1.823	0.668	2.426	0.514	3.761
3	0.830	1.568	0.701	1.954	0.564	2.722
4	0.840	1.447	0.725	1.742	0.599	2.293
5	0.849	1.376	0.744	1.618	0.626	2.055
6	0.856	1.328	0.759	1.537	0.647	1.904
7	0.863	1.294	0.771	1.479	0.665	1.797
8	0.869	1.267	0.782	1.435	0.680	1.718
9	0.874	1.247	0.796	1.400	0.693	1.657
10	0.878	1.230	0.799	1.372	0.704	1.607
11	0.882	1.215	0.806	1.349	0.714	1.567
12	0.886	1.203	0.812	1.329	0.723	1.533
13	0.889	1.193	0.818	1.312	0.731	1.504
14	0.892	1.184	0.823	1.297	0.738	1.478
15	0.895	1.176	0.828	1.284	0.745	1.456
16	0.897	1.169	0.832	1.272	0.751	1.437
17	0.900	1.163	0.836	1.262	0.757	1.419
18	0.902	1.157	0.840	1.253	0.763	1.404
19	0.904	1.152	0.843	1.244	0.767	1.390
20	0.906	1.147	0.846	1.237	0.772	1.377
30	0.920	1.115	0.870	1.185	0.806	1.291

**TABLE XIV. Demonstrated MTBF confidence limit multipliers for time calculation.**

TOTAL NUMBER OF FAILURES	CONFIDENCE INTERVALS					
	40 PERCENT		60 PERCENT		80 PERCENT	
	70 PERCENT LOWER LIMIT	70 PERCENT UPPER LIMIT	80 PERCENT LOWER LIMIT	80 PERCENT UPPER LIMIT	90 PERCENT LOWER LIMIT	90 PERCENT UPPER LIMIT
1	0.410	2.804	0.334	4.481	0.257	9.491
2	0.533	1.823	0.467	2.426	0.376	3.761
3	0.630	1.568	0.544	1.954	0.449	2.722
4	0.679	1.447	0.595	1.742	0.500	2.293
5	0.714	1.376	0.632	1.618	0.539	2.055
6	0.740	1.328	0.661	1.537	0.570	1.904
7	0.760	1.294	0.684	1.479	0.595	1.797
8	0.777	1.267	0.703	1.435	0.616	1.718
9	0.790	1.247	0.719	1.400	0.634	1.657
10	0.802	1.230	0.733	1.372	0.649	1.607
11	0.813	1.215	0.744	1.349	0.663	1.567
12	0.821	1.203	0.755	1.329	0.675	1.533
13	0.828	1.193	0.764	1.312	0.686	1.504
14	0.835	1.184	0.772	1.297	0.696	1.478
15	0.841	1.176	0.780	1.284	0.705	1.456
16	0.847	1.169	0.787	1.272	0.713	1.437
17	0.852	1.163	0.793	1.262	0.720	1.419
18	0.856	1.157	0.799	1.253	0.727	1.404
19	0.861	1.152	0.804	1.244	0.734	1.390
20	0.864	1.147	0.809	1.237	0.740	1.377
30	0.891	1.115	0.844	1.185	0.783	1.291

**TABLE XV. Accept times of fixed-duration test plans. Program Manager's assessment.**

Test Plan	Accept times <sup>1/</sup>				
IX-D	$T_0 = 4.2$	$T_1 = 6.1$	$T_2 = 7.9$	$T_3 = 9.4$	$T_4 = 11.0$
	$T_5 = 12.4$	$T_6 = 13.9$	$T_7 = 15.3$	$T_8 = 16.6$	$T_9 = 18.0$
	$T_{10} = 19.3$	$T_{11} = 20.7$	$T_{12} = 22.0$	$T_{13} = 23.3$	$T_{14} = 24.5$
	$T_{15} = 25.8$	$T_{16} = 27.1$	$T_{17} = 28.3$	$T_{18} = 29.6$	$T_{19} = 30.8$
	$T_{20} = 32.1$	$T_{21} = 33.3$	$T_{22} = 34.5$	$T_{23} = 35.8$	$T_{24} = 37.0$
	$T_{25} = 38.2$	$T_{26} = 39.4$	$T_{27} = 40.6$	$T_{28} = 41.8$	$T_{29} = 43.0$
	$T_{30} = 44.2$	$T_{31} = 45.4$	$T_{32} = 46.6$	$T_{33} = 47.8$	$T_{34} = 49.0$
	$T_{35} = 50.1$	$T_{36} = 51.3$	$T_{37} = 52.5$	$T_{38} = 53.7$	$T_{39} = 54.8$
	$T_{40} = 56.0$	$T_{41} = 57.2$	$T_{42} = 58.3$	$T_{43} = 59.5$	$T_{44} = 60.7$
	$T_{45} = 61.8$	$T_{46} = 63.0$	$T_{47} = 64.1$	$T_{48} = 65.3$	$T_{49} = 66.5$
$T_{50} = 67.6$	$T_{51} = 68.8$	$T_{52} = 69.9$	$T_{53} = 71.1$	$T_{54} = 72.2$	
X-D	$T_0 = 3.2$	$T_1 = 5.0$	$T_2 = 6.6$	$T_3 = 8.1$	$T_4 = 9.5$
	$T_5 = 10.9$	$T_6 = 12.2$	$T_7 = 13.6$	$T_8 = 14.9$	$T_9 = 16.1$
	$T_{10} = 17.4$	$T_{11} = 18.7$	$T_{12} = 19.9$	$T_{13} = 21.2$	$T_{14} = 22.4$
	$T_{15} = 23.6$	$T_{16} = 24.8$	$T_{17} = 26.1$	$T_{18} = 27.3$	$T_{19} = 28.4$

<sup>1/</sup> Accept at time (T<sub>j</sub>) if (j) failures have occurred up to that time.

**TABLE XV. Accept times of fixed-duration test plans. Program Manager's assessment.**  
**(Continued)**

Test Plan	Accept times <sup>1/</sup>				
IX-D (Cont')	T <sub>20</sub> = 29.6	T <sub>21</sub> = 30.8	T <sub>22</sub> = 32.0	T <sub>23</sub> = 33.2	T <sub>24</sub> = 34.4
	T <sub>25</sub> = 35.6	T <sub>26</sub> = 36.7	T <sub>27</sub> = 37.9	T <sub>28</sub> = 39.1	T <sub>29</sub> = 40.2
	T <sub>30</sub> = 41.4	T <sub>31</sub> = 42.5	T <sub>32</sub> = 43.9	T <sub>33</sub> = 44.8	T <sub>34</sub> = 46.0
	T <sub>35</sub> = 47.1	T <sub>36</sub> = 48.3	T <sub>37</sub> = 49.4	T <sub>38</sub> = 50.6	T <sub>39</sub> = 51.7
XI-D	T <sub>0</sub> = 3.0	T <sub>1</sub> = 4.8	T <sub>2</sub> = 6.3	T <sub>3</sub> = 7.8	T <sub>4</sub> = 9.2
	T <sub>5</sub> = 10.5	T <sub>6</sub> = 11.9	T <sub>7</sub> = 13.2	T <sub>8</sub> = 14.4	T <sub>9</sub> = 15.7
	T <sub>10</sub> = 17.0	T <sub>11</sub> = 18.2	T <sub>12</sub> = 19.5	T <sub>13</sub> = 20.7	T <sub>14</sub> = 21.9
	T <sub>15</sub> = 23.1	T <sub>16</sub> = 24.3	T <sub>17</sub> = 25.5	T <sub>18</sub> = 26.7	T <sub>19</sub> = 27.9
	T <sub>20</sub> = 29.1	T <sub>21</sub> = 30.3	T <sub>22</sub> = 31.4	T <sub>23</sub> = 32.6	
XII-D	T <sub>0</sub> = 3.7	T <sub>1</sub> = 5.6	T <sub>2</sub> = 7.2	T <sub>3</sub> = 8.8	T <sub>4</sub> = 10.3
	T <sub>5</sub> = 11.7	T <sub>6</sub> = 13.1	T <sub>7</sub> = 14.4	T <sub>8</sub> = 15.8	T <sub>9</sub> = 17.1
	T <sub>10</sub> = 18.4	T <sub>11</sub> = 19.7	T <sub>12</sub> = 21.0	T <sub>13</sub> = 22.3	T <sub>14</sub> = 23.5
	T <sub>15</sub> = 24.8	T <sub>16</sub> = 26.0			
XIII-D	T <sub>0</sub> = 2.8	T <sub>1</sub> = 4.6	T <sub>2</sub> = 6.1	T <sub>3</sub> = 7.5	T <sub>4</sub> = 8.9
	T <sub>5</sub> = 10.3	T <sub>6</sub> = 11.6	T <sub>7</sub> = 12.9	T <sub>8</sub> = 14.1	T <sub>9</sub> = 15.4
	T <sub>10</sub> = 16.6	T <sub>11</sub> = 17.9	T <sub>12</sub> = 19.1		

<sup>1/</sup> Accept at time (T<sub>j</sub>) if (j) failures have occurred up to that time.

**TABLE XV. Accept times of fixed-duration test plans. Program Manager's assessment.**  
 (Continued)

Test Plan	Accept times <sup>1/</sup>				
IX-D (Cont'd)	$T_0 = 2.7$	$T_1 = 4.4$	$T_2 = 5.9$	$T_3 = 7.3$	$T_4 = 8.7$
	$T_5 = 10.0$	$T_6 = 11.3$	$T_7 = 12.6$		
XV-D	$T_0 = 3.5$	$T_1 = 5.4$	$T_2 = 7.0$	$T_3 = 8.6$	$T_4 = 10.0$
	$T_5 = 11.4$	$T_6 = 12.8$			
XVI-D	$T_0 = 2.5$	$T_1 = 4.1$	$T_2 = 5.6$	$T_3 = 7.0$	$T_4 = 8.3$
XVII-D	$T_0 = 2.2$	$T_1 = 3.8$	$T_2 = 5.2$		
XIX-D	$T_0 = 2.1$	$T_1 = 3.7$	$T_2 = 5.1$	$T_3 = 6.4$	$T_4 = 7.7$
	$T_5 = 8.9$	$T_6 = 10.2$	$T_7 = 11.4$	$T_8 = 12.6$	
XX-D	$T_0 = 1.8$	$T_1 = 3.2$	$T_2 = 4.5$		
XXI-D	$T_0 = 1.1$				

<sup>1/</sup> Accept at time ( $T_j$ ) if (j) failures have occurred up to that time.

**TABLE XVI. Comparison of risks, standard fixed-duration tests versus Program Manager's assessment.**

Test Plan	Discrimination ratio	Standard test plans		Program Manager's assessment	
		Producer's risk $\alpha$ (%)	Consumer's risk $\beta$ (%)	Producer's risk $\alpha$ (%)	Consumer's risk $\beta$ (%)
IX-D	1.5	12.0	9.9	10.2	10.0
X-D	1.5	10.9	21.4	10.1	29.8
XI-D	1.5	17.8	22.1	20.1	20.4
XII-D	2.0	9.6	10.6	10.4	10.3
XIII-D	2.0	9.8	20.9	9.9	19.2
XIV-D	2.0	19.9	21.0	20.0	18.3
XV-D	3.0	9.4	9.9	10.0	8.4
xvi-D	3.0	10.9	21.3	10.2	18.7
XVII-D	3.0	17.5	19.7	19.7	19.2
(High risk plans)					
XIX-D	1.5	28.8	31.3	29.6	30.8
XX-D	2.0	28.8	28.5	29.9	29.1
XXI-D	3.0	30.7	33.3	30.7	33.3

**TABLE XVII. Test times, standard fixed-duration test plans versus Program Manager's assessment.**

Test Plan	Discrimination ratio	Standard test plans		Program Manager's assessment	
		Test Time <sup>1/</sup>	Number of failures to reject	Test Time <sup>1/</sup>	Number of failures to reject
IX-D	1.5	45.0	≥ 37	72.2	≥ 55
X-D	1.5	29.9	≥ 26	51.7	≥ 40
XI-D	1.5	21.1	≥ 18	32.6	≥ 24
XII-D	2.0	18.8	≥ 14	26.0	≥ 17
XIII-D	2.0	12.4	≥ 10	19.1	≥ 13
XIV-D	2.0	7.8	> 6	12.6	≥ 8
XV-D	3.0	9.3	≥ 6	12.8	≥ 7
XVI-D	3.0	5.4	≥ 4	8.3	≥ 5
XVII-D	3.0	4.3	≥ 3	5.2	≥ 3
(High risk plans)					
XIX-D	1.5	8.0	≥ 7	12.6	≥ 9
XX-D	2.0	3.7	> 3	4.5	≥ 3
XXI-D	3.0	1.1	≥ 1	1.1	≥ 1

<sup>1/</sup> Multiples of  $\theta_0$

TABLE XVIII. Failure times for the numerical example.

	Subsystem 1	Subsystem 2	Subsystem 3	Subsystem 4	Subsystem 5 <sup>2/</sup>
1	$t_1 = 0.619$ $t_2 = 0.7$ $t_3 = 0.9$ $t_4 = 1.1$	$t_1 = 1.146$ $t_2 = 1.65$	$t_1 = 1.697$ $t_2 = 2.8$	$t_1 = 1.311$ $t_2 = 2.0$ $t_3 = 2.9$	$t_1 = 2.0$ $t_2 = 4.439$ $t_3 = 7.0$
2 <sup>1</sup>	$Z_1 = 9.919$	$Z_2 = 15.996$	$Z_3 = 26.897$	$Z_4 = 26.511$	$Z_5 = 62.439$
3	$n_1 = 10$	$n_2 = 10$	$n_3 = 10$	$n_4 = 10$	$n_5 = 10$
4	$r_1 = 4$	$r_2 = 2$	$r_3 = 2$	$r_4 = 3$	$r_5 = 3$

- 1<sup>1</sup>  $t_i$  = failure times
- 2  $Z_i$  = total time on test for subsystem
- 3  $n_i$  = number of items on test for subsystem
- 4  $r_i$  = number of failures observed on subsystem
- 5  $n$  = total number of subsystems = 5

**TABLE XIX. Example of correct ordering in the AO bound calculation.**

```

* fort o relibd2
* run
  Give number of subsystems.
= 3
  Enter data starting by subsystem with smallest total time on test.
  Enter data for subsystem 1
  Enter this subsystem's total time on test
= 14.61
  Enter this subsystem's number of failures.
= 2
  Enter data for subsystem 2
  Enter this subsystem's total time on test
= 35.971
  Enter this subsystem's number of failures.
= 2
  Enter data for subsystem 3
  Enter this subsystem's total time on test
= 62.542
  Enter this subsystem's number of failures.
= 2
  Enter confidence level percentile.
= 1.282
  Enter mission time.
= 1.0

  Mission Time: 1.00000
    Percentile: 1.28200

  M2 = 0.1806820 V2 = 0.0103983
  Reliability Bound is: 0.728509

  If another confidence level or mission time, give 1.
= 1

  Enter confidence level percentile.
= 0.0
  Enter mission time.
= 1.0

  Mission Time: 1.00000
    Percentile: 0.

  M2 = 0.1806820 V2 = 0.0103983
  Reliability Bound is: 0.850297

  If another confidence level or mission time, give 1.
= 0
*
  
```

TABLE XX. Example of incorrect ordering in the AO bound calculation.

```

run
Give number of subsystems.
= 3
Enter data starting by subsystem with smallest total time on test.
Enter data for subsystem 1
Enter this subsystem's total time on test
= 35.971
Enter this subsystem's number of failures.
= 2
Enter data for subsystem 2
Enter this subsystem's total time on test
= 14.61
Enter this subsystem's number of failures.
= 2
Enter data for subsystem 3
Enter this subsystem's total time on test
= 62.542
Enter this subsystem's number of failures
= 2

Enter confidence level percentile.
= 1.282
Enter mission time.
= 1.0

Mission Time: 1.00000
Percentile: 1.28200

M2 = 0.1400359 V2 = 0.0064862
Reliability Bound is: 0.780768

If another confidence level or mission time, give 1.
= 1

Enter confidence level percentile.
= 0.0

Enter mission time.
= 1.0

MissionTime: 1.00000
Percentile: 0.

M2 = 0.1400359 V2 = 0.0064862
Reliability Bound is: 0.882358

If another confidence level or mission time, give 1.
= 0
*
```

TABLE XXI. Example data for computer program.

Example run:	Reference 13, page 200, line 1	
ith Subsystem	Total time on test	Number Failures
1	9.919	4
2	15.996	2
3	26.897	2
4	26.511	3
5	62.439	3

TABLE XXII. Example computer run for data in TABLE XXI.

```
run
Give number of subsystems.
= 5
Enter data starting by subsystem with smallest total time on test.
Enter data for subsystem 1
Enter this subsystem's total time on test
= 9.914
Enter this subsystem's number of failures.
= 4
Enter data for subsystem 2
Enter this subsystem's total time on test
= 15.296
Enter this subsystem's number of failures.
= 2

Enter data for subsystem 3
Enter this subsystem's total time on test
= 26.897
Enter this subsystem's number of failures.
= 2
Enter data for subsystem 4
Enter this subsystem's total time on test
= 29.511
Enter this subsystem's number of failures.
= 3

Enter data for subsystem 5
Enter this subsystem's total time on test
= 62.430
Enter this subsystem's number of failures.
= 3

Enter confidence level percentile.
= 1.282
Enter mission time.
= 1.0

Mission Time: 1.00000
Percentile: 1.28200

M1 = 0.5946219 V1 = 0.0475423
Reliability Bound is: 0.412697

M2 = 0.5058325 V2 = 0.0491630
Reliability Bound is: 0.406101

M3 = 0.5899235 V3 = 0.0465764
Reliability Bound is: 0.415876

If another confidence level or mission time, give 1
= 0
```

TABLE XXIII. Thermal stress environments for marine craft.

Environmental condition	Operating °C	Nonoperating °C
Exposed-unsheltered	-54 to + 65	-62 to + 71
Exposed-unsheltered (ship)	-28 to + 65	-62 to + 71
Sheltered noncontrolled environment (shore)	-40 to + 50	-62 to + 71
Sheltered noncontrolled	0 to + 50	-62 to + 71

MIL-HDBK-781

TABLE XXIV. Environmental profile data (example).

MISSION PHASE	DURATION MINUTES	ALTITUDE (1000 FT)	MACH	COMPART-MENT TEMPERATURE (°C)	TEMPERATURE RATE OF CHANGE (°C PER MIN)	DYNAMIC PRESSURE (q)	W <sub>0</sub> (q <sup>2</sup> /Hz)	W <sub>1</sub> (q <sup>2</sup> /Hz)	DEWPOINT TEMPERATURE (°C)
GROUND NONOPERATING, COLD DAY	30	0	-	-54	-	-	-	-	N/A
GROUND OPERATING, COLD DAY	30	0	-	-54	-	-	-	-	N/A
TAKEOFF	1	0	0.60		1.83	280	0.002	0.001	N/A
CLIMB TO ALTITUDE	11	1-34	0.60			110	0.0005	0.00025	N/A
CRUISE	18	34	0.55	-32	3.05	541	0.00008	0.00004	N/A
DIVE	4.25	34-0	0.85			541	0.0019	0.0009	N/A
CRUISE	45	0	0.60	-19		541	0.0019	0.0009	N/A
CRUISE (COMBAT)	5	0	0.83	-10		1024	0.007	0.0035	N/A
CRUISE	45	0	0.60		1.85	541	0.0019	0.0009	N/A
CLIMB	7	0-35	0.70		7.35	375	0.0009	0.00045	N/A
DESCEND TO HOT DAY	14	35-0	0.40			124	0.0001	0.00005	N/A
GROUND NONOPERATING, HOT DAY	30	0	-	+71	-	-	-	-	31
GROUND OPERATING, HOT DAY	30	0	-	+71	-	-	-	-	31
TAKEOFF	1	0	0.60		5.00	280	0.002	0.001	N/A
CLIMB TO ALTITUDE	11	1-34	0.60			110	0.0005	0.00025	N/A
CRUISE	18	34	0.55	+11	14.1	541	0.00008	0.00004	N/A
DIVE	4.25	34-0	0.85			541	0.0019	0.0009	N/A
CRUISE	45	0	0.60	+71		541	0.0019	0.0009	N/A
CRUISE (COMBAT)	5	0	0.83	+71		1024	0.007	0.0035	N/A
CRUISE	45	0	0.60	+71	8.71	541	0.0019	0.0009	N/A
CLIMB	7	0-35	0.70	+10	4.57	375	0.0009	0.00045	N/A
CRUISE	18	35	0.45			76	0.00004	0.00002	N/A
DESCEND TO COLD DAY	14	35-0	0.40			124	0.0001	0.00005	N/A

TABLE XXV. Test profile data (example).

	DURATION (MINUTES)	COMPART MENT TEMPER- ATURE (°C)	TEMPER- ATURE RATE OF CHANGE (°C PER MIN)	W <sub>0</sub> (g <sup>2</sup> /Hz)	DEW POINT TEMPER- ATURE (°C)	EQUIP- MENT OPERA- TION
GROUND NONOPERATING, COLD DAY	30	- 54	-	-	N/A	OFF
GROUND OPERATING, COLD DAY	30	- 54	-	-	N/A	ON
TAKEOFF	1	-	5.0	0.002	N/A	ON
CLIMB TO ALTITUDE	3.4	-	-	0.001	N/A	ON
CRUISE	18	- 32	-	0.001	N/A	ON
DIVE	2.6	-	5.0	0.0019	N/A	ON
CRUISE	45	- 19	-	0.0019	N/A	ON
CRUISE (COMBAT)	5	- 10	-	0.007	N/A	ON
CRUISE	45	- 19	-	0.0019	N/A	ON
CLIMB	2.6	-	5.0	0.001	N/A	ON
CRUISE	18	- 32	-	0.001	N/A	ON
DESCEND TO HOT DAY	14	-	7.35	0.001	N/A	ON
GROUND NONOPERATING, HOT DAY	30	+ 71	-	-	31	OFF
GROUND OPERATING, HOT DAY	30	+ 71	-	-	31	ON
TAKEOFF	1	-	5.0	0.002	N/A	ON
CLIMB TO ALTITUDE	11	-	-	0.001	N/A	ON
CRUISE	18	+ 11	-	0.001	N/A	ON
DIVE	4.25	-	14.1	0.0019	N/A	ON
CRUISE	45	+ 71	-	0.0019	N/A	ON
CRUISE (COMBAT)	5	+ 71	-	0.007	N/A	ON
CRUISE	45	+ 71	-	0.0019	N/A	ON
CLIMB	7	-	8.71	0.001	N/A	ON
CRUISE	18	+ 10	-	0.001	N/A	ON
DESCEND TO COLD DAY	13	-	5.0	0.001	N/A	ON

TABLE XXVI. Hot day temperatures (°C) for Class I equipment in air-conditioned compartments.

ALTITUDE (1000 FT)	TEMPERATURE (°C)
0	55
10	53
20	40
30	40
40	30
50	20

TABLE XXVII. Hot day ambient temperature (°C) for Class II equipment in air-conditioned compartments.

ALTITUDE (1000 FT)	MACH NUMBER	HIGH PERFORMANCE $\geq (1.0)^{1'}$			
		$\leq 0.6$	0.8	1.0	
0		71	71	71	95
10		56	68	68	93
20		40	55	63	88
30		15	36	56	80
40		5	10	46	70
50		5	10	35	60
60		5	10	24	49
70		5	10	11	35

<sup>1</sup> Ambient cooled equipment must be turned off for 15 minutes after 30 minutes of operation at these temperatures to comply with the Intermittent operation of MIL-E-5400.

TABLE XXVIII. Hot day ambient temperatures ( $^{\circ}\text{C}$ ) for eadioment in ram air-cooled compartments.

ALTITUDE (1000 FT)	MACH NUMBER			
	$\leq 0.4$	0.6	0.8	$\geq (1.0)$
0	48	60	75	95 <sup>1/</sup>
10	27	38	52	71
20	6	16	29	46
30	- 15	- 6	7	23
40	- 36	- 30	- 16	- 1
50	- 30	- 19	- 7	8
60	- 31	- 23	- 11	4
70	- 30	- 22	- 10	5

<sup>1/</sup> Ambient cooled Class II equipment must be turned off for 15 minutes after 30 minutes of operation at this temperature to comply with the intermittent operation requirement of MIL-E-5400.

TABLE XXIX. Cold day ambient temperatures ( $^{\circ}\text{C}$ ) for equipment in ram air-cooled compartments.

ALTITUDE (1000 FT)	MACH NUMBER			
	$\leq 0.4$	0.6	0.8	$\geq (1.0)$
0	- 44	- 37	- 15	- 11
10	- 18	- 10	2	19
20	- 36	- 28	- 16	- 2
30	- 58	- 50	- 40	- 27
40	- 59	- 51	- 41	- 18
50	- 82	- 76	- 67	- 55
60	- 82	- 75	- 66	- 54
70	- 65	- 58	- 48	- 35

TABLE XXX. Temperatures ( $^{\circ}$ C) for Class I and Class II equipment in air-conditioned compartments.

WARM COMPARTMENT

ALTITUDE (1000 FEET)	MACH NUMBER	MACH NUMBER			HIGH PERFORMANCE $\geq 1.0$
		0 to .59	.6 to .79	.8 to .99	
0		8	12	19	27
2 to 10		24	29	36	44
20		16	20	27	35
30		7	11	17	24
40		8	12	17	24
50		6	9	14	21

COOL COMPARTMENT

ALTITUDE (1000 FEET)	MACH NUMBER	MACH NUMBER			HIGH PERFORMANCE $\geq 1.0$
		0 to .59	.6 to .79	.8 to .99	
0		- 26	- 19	- 10	2
2 to 10		- 4	3	13	27
20		- 17	- 10	- 1	11
30		- 32	- 26	- 17	- 6
40		- 33	- 27	- 18	- 8
50		- 38	- 32	- 24	- 14

**TABLE XXXI. Jet aircraft random vibration test.**

Aerodynamic induced vibration

$W_0 = K(q)^2$ , where  $q$  = Dynamic pressure (when  $q > 1200$  lbs/ft<sup>2</sup>, use 1200)

$W_1 = W_0 - 3$  dB

(SEE FIGURE 65 for spectrum shape)

K Location Factor	Equipment location	$W_0$
$0.67 \times 10^{-8}$	Equipment attached to structure adjacent to external surfaces that are smooth, free from discontinuities.	
$0.34 \times 10^{-8}$	Cockpit equipment and equipment in compartments and on shelves adjacent to external surfaces that are smooth, free from discontinuities.	
$03.5 \times 10^{-9}$	Equipment attached to structure adjacent to or immediately aft of surfaces having discontinuities (that is, cavities, chins, blade antennas, and so forth)	
$01.75 \times 10^{-8}$	Equipment in compartments adjacent to or immediately aft of surfaces having discontinuities (that is, cavities, chins, speed brakes, and so forth)	

**SPECIAL CASE CONDITIONS**

**Fighter bomber**

Condition	Equipment location	$W_0$
Takeoff	Attached to or in compartments adjacent to structure directly exposed to engine exhaust aft of engine exhaust plane (1 minute)	0.7
Cruise	(Same as above)	0.175
Takeoff	In engine compartment or adjacent to engine forward of engine exhaust plane (1 minute)	0.1
Cruise	(Same as above)	0.025
Takeoff, landing, maneuvers	Wing and fin tips <sup>1/</sup> deceleration (speed brake) (1 minute)	0.1
High q (>1000 lbs/ft <sup>2</sup> )	Wing and fin tips <sup>1/</sup>	0.02
Cruise	Wing and fin tips <sup>1/</sup>	0.01
Takeoff	All other locations (1 minute)	0.002

**Cargo/transport**

Condition	Equipment location	$W_0$
Takeoff	Fuselage mounted	0.01
Takeoff	Internal	0.005
Takeoff	Wing - aft of engine exhaust <sup>2/</sup>	0.05
All	Wing tip and fin tip <sup>3/</sup>	0.01

<sup>1/</sup> Use wing and fin tip spectrum (see FIGURE 65)

<sup>2/</sup> Excludes upper surface blown (USB) and externally blown flap (EFB)

<sup>3/</sup> Takeoff, landing, plus 10 percent of cruise time

MIL-HDBK-781

TABLE XXXII. Tabulation of temperature values.

COLD DAY  
 HOT DAY

MISSION A WEIGHTING FACTOR =			MISSION B WEIGHTING FACTOR =			MISSION X WEIGHTING FACTOR =		
TEMPERATURE LEVEL	DURATION	WEIGHTED DURATION	TEMPERATURE LEVEL	DURATION	WEIGHTED DURATION	TEMPERATURE LEVEL	DURATION	WEIGHTED DURATION

TABLE 33. Summary of temperature values.

COLD DAY  
 HOT DAY

TEMPERATURE VALUE	TOTAL WEIGHTED DURATION

MIL-HDBK-781

Table XXXIV. Tabulation of vibration levels.

COLD DAY  
 HOT DAY

MISSION A WEIGHTING FACTOR =			MISSION B WEIGHTING FACTOR =			MISSION X WEIGHTING FACTOR =		
VIBRATION LEVEL (g <sup>2</sup> /Hz)	DURATION (MIN)	WEIGHTED DURATION	VIBRATION LEVEL (g <sup>2</sup> /Hz)	DURATION	WEIGHTED DURATION	VIBRATION LEVEL (g <sup>2</sup> /Hz)	DURATION	WEIGHTED DURATION
002 001	1		002 01	1		002 001	1	
-----								
-----								
-----								
-----								
-----								
-----								
-----								
-----								
-----								

COLD DAY  
 HOT DAY

TABLE 35. Summary of vibration levels.

VIBRATION LEVEL	TOTAL WEIGHTED DURATION
002 001	1
-----	
-----	
-----	
-----	
-----	
-----	
-----	
-----	
-----	

MIL-HDBK-781

TABLE XXXVI. Composite test profile timeline.

TEMPERATURE PHASE	TEMPERATURE VALUE (°C)	DURATION (MINUTES)	TEMPERATURE RATE OF CHANGE (°C/MINUTE)	DURATION (MINUTES)	START TIME	VIBRATION PHASE	VIBRATION VALUE(g <sup>2</sup> /Hz)	DURATION (MINUTES)	START TIME
NON-OP SOAK						NO VIB			
OPSOAK						TO 1/2			
TRANSITION INT						INT			
TRANSITION MAX						MAX			
TRANSITION MIN						MIN 1/2			
TRANSITION						2/2			
NON-OP SOAK						NO VIB			
OP SOAK						TO 1/2			
TRANSITION INT						INT			
TRANSITION MAX						MAX			
TRANSITION MIN						MIN 1/2			
TRANSITION						2/2			
NON-OP SOAK						NO VIB			

1 TAKEOFF  
 2 0.00g<sup>2</sup>/Hz AS REQUIRED TO ASSURE CONTINUOUS VIBRATION DURING FLIGHT PHASES

**TABLE XXXVII. Temperature level tabulation - hot day (example).**

	Temperature Level (°C) <sup>1/</sup>	Duration (Minutes)	Weighted duration
Low-low-low Weighting factor = 0.10	71	145	14.5
High-low-low-high Weighting factor = 0.40	36	60	24.0
	71	27	10.8
	10	70	28.0
Low-low-high Weighting factor = 0.25	71	75	18.75
	23	60	15.0
Close support Weighting factor = 0.20	36	70	14.0
	64	60	12.0
	10	75	15.0
Ferry Weighting factor = 0.05	23	240	12.0

Selected levels and durations are:

MIN = 10°C for 43 minutes  
 MAX = 71°C for 44 minutes  
 INT = 35.8°C for 77 minutes

$$\text{INT} = \frac{23(27) + 36(38) + 64(12)}{27 + 38 + 12} = \frac{2757}{77} = 35.8$$

**TABLE 38. Temperature summary - hot day (example).**

Temperature Level (°C)	Total Weighted Duration (Minutes)
10	43.0
23	27.0
36	38.0
64	12.0
71	44.05

TABLE XXXIX. Temperature level tabulation - cold day (example).

	Temperature Level (°C) <sup>1/</sup>	Duration (Minutes)	Weighted duration
Low-low-low Weighting factor = 0.10	- 26	145	14.5
High-low-low-high Weighting factor = 0.40	- 26	130	52.0
	- 10	27	10.8
Low-low-high Weighting factor = 0.25	- 26	140	35.0
Close support Weighting factor = 0.20	- 26	70	14.0
	- 4	60	12.0
	- 27	75	15.0
Ferry Weighting factor = 0.05	- 26	240	12.0

<sup>1/</sup> Selected levels and durations (see 5.6.2.2)

$$\text{MAX} = \frac{(-10)(10.8) + (-4)(12)}{10.8 + 12} = -6.8^{\circ}\text{C for 22.8 minutes}$$

$$\text{MIN} = \frac{(-27)(15) + (-26)(127.5)}{15 + 127.5} = -26.1^{\circ}\text{C for 142.5 minutes}$$

since no levels remain to select INT value

$$\text{MIN} = -26.1^{\circ}\text{C for 71.25 minutes and}$$

$$\text{INT} = -26.1^{\circ}\text{C for 71.25 minutes}$$

TABLE XL. Temperature summary - cold day (example).

Temperature Level (°C)	Total Weighted Duration (Minutes)
-27	15.0
-26	127.5
-10	10.8
-4	12.0

TABLE XLI. Vibration Level Tabulation (example).

Low-Low-Low Weighting Factor = .10		High-Low-Low-High Weighting Factor = .40		Low-Low-High Weighting Factor = .25		Close support Weighting Factor = .20		Ferry Weighting Factor = .05			
Vib. Level (g <sup>2</sup> /Hz)	Duration (min)	Wtd. Dur.	Vib. Level (g <sup>2</sup> /Hz)	Duration (min)	Wtd. Dur.	Vib. Level (g <sup>2</sup> /Hz)	Duration (min)	Wtd. Dur.	Vib. Level (g <sup>2</sup> /Hz)	Duration (min)	Wtd. Dur.
.002	1	0.1	.002	1	0.4	.002	1	0.25	.002	1	0.2
(takeoff)			(takeoff)			(takeoff)			(takeoff)		
.001	140.3	14.03	.001	143	57.2	.001	142	35.5	.001	218	43.6
.0032	5.2	0.52	.0041	20.7	8.28	.0032	5.2	1.3	.0012	6.0	1.2
			.0077	15.0	6.0	.0026	5.0	1.25	.002	2.5	0.5
			.0012	6	2.4				.0015	5.0	1.0

TABLE XLII. Vibration Level Summary (example).

Vibration Level (g <sup>2</sup> /Hz)	Total Weighted Duration (min)
.002	1.0
.001	163.28
.0012	3.6
.0015	1.0
.002	0.5
.0026	1.25
.0032	1.82
.0041	8.28
.0077	6.0

NOTES: Selected Levels and Durations:

T/O = .002g<sup>2</sup>/Hz for 1 minute

MAX = .0077g<sup>2</sup>/Hz for 6 minutes

MIN = .0012g<sup>2</sup>/Hz for 3.6 minutes

INT = .0035g<sup>2</sup>/Hz for 12.85 minutes (1)

.001g<sup>2</sup>/Hz for 163.28 minutes to assure continuous vibration

$$(1) INT = \frac{(.0015)(1.0) + (.002)(0.5) + (.0026)(1.25) + (.0032)(1.82) + (.0041)(8.28)}{1.0 + 0.5 + 1.25 + 1.82 + 8.28}$$

$$= \frac{.045522}{12.85} = .0035$$

TABLE XLIII. Temperature rate of change (example).

FROM LEVEL	TO LEVEL	TEMPERATURE RATE OF CHANGE (°C)	DURATION (MINUTES)
-54°C	INT <sub>C</sub>	5	$\{(-26.1) - (-54)\} / 5 = 5.6$
INT <sub>C</sub>	MAX <sub>C</sub>	7	$\{(-6.8) - (-26.1)\} / 7 = 2.8$
MAX <sub>C</sub>	MIN <sub>C</sub>	5	$\{(-26.1) - (-6.8)\} / 5 = 3.9$
MIN <sub>C</sub>	+71°C	8	$\{(71) - (-26.1)\} / 8 = 12.1$
+71°C	INT <sub>H</sub>	6	$\{(35.8) - (71)\} / 6 = 5.9$
INT <sub>H</sub>	MAX <sub>H</sub>	11.5	$\{(71) - (35.8)\} / 11.5 = 3.1$
MAX <sub>H</sub>	MIN <sub>H</sub>	10.5	$\{(10) - (71)\} / 10.5 = 5.8$
MIN <sub>H</sub>	-54°C	6	$\{(-54) - (10)\} / 6 = 10.7$

**MIL-HDBK-781**

**TABLE XLIV. Composite test profile timeline (example).**

Temperature phase	Temperature level (oC)	Duration (Minutes)	Temperature rate of change (oC per Minute)	Duration (Minutes)	Start time	Vibration phase	Vibration level (g <sup>2</sup> /Hz)	Duration (Minutes)	Start time
Nonoperating Soak	54	30							
Operating soak Transition INT <sub>C</sub>	-54	30	5	30	60	No Vibration TO	.002	1.0	0
Transition INT <sub>C</sub>	-26.1	71.25		5.6	65.6	.001			61
Transition MAX <sub>C</sub>	-6.8	22.8	7	2.8	136.85	INT	.0035	12.85	126.8
Transition MIN <sub>C</sub>	-26.1	71.25			139.65	MAX	.0077	6.0	139.65
Transition Nonoperating Soak	+71	30	5	3.9	162.45	MIN	.0012	3.6	145.65
Operating Soak Transition INT <sub>H</sub>	+71	77	8	12.1	166.35	.001			149.25
Transition MAX <sub>H</sub>	+71	44			237.6	No Vibration			249.7
Transition Nonoperating Soak	+10	43	6	5.9	279.7	TO	.002	1.0	309.7
Transition MIN <sub>H</sub>	-54	71.25			309.7	.001			310.7
Transition Nonoperating Soak	-54	30	11.5	3.1	315.6	INT	.0035	12.85	382.85
Transition Nonoperating Soak	-54	30	10.5	5.8	392.6	MAX	.0077	6.0	395.7
Transition Nonoperating Soak	-54	30	6	10.7	439.7	MIN	.0012	3.6	401.7
Transition Nonoperating Soak	-54	30	6		445.5	.001			405.3
Transition Nonoperating Soak	-54	30			488.5	No Vibration			499.2

1 level of .001 g<sup>2</sup>/Hz inserted as required to assure continuous vibration during flight phases.

**TABLE XLV. Random vibration test for V/STOL aircraft.**

**Aerospace induced vibration**

$W_0 = K(q)^2$ , where  $q$  = dynamic pressure (when  $q > 1200$  lbs/ft<sup>2</sup> use 1200)

$W_1 = W_0 - 3\text{dB}$

(K) Location factor	Equipment location
0.67 X 10-8	Equipment attached to structure adjacent to external surfaces that are smooth, free from discontinuities
0.34 X 10-8	Cockpit equipment and equipment in compartments and on shelves adjacent to external surfaces that are smooth, free from discontinuities
3.5 X 10-8	Equipment attached to structure adjacent to or immediately aft of surfaces having discontinuities (that is, cavities, chins, blade antennas, and so forth)
1.75 X 10-8	Equipment in compartments adjacent to or immediately aft of surfaces having discontinuities (that is, cavities, chins, speed brakes, and so forth)

**SPECIAL CASE CONDITIONS**

Condition	Equipment location	$W_0$ (HOR) <sup>2/</sup>	$W_0$ (VERT) <sup>4/</sup>	
			V/STOL	
			TYPES	
			A	B
Takeoff <sup>1/</sup>	Attached to or in compartments adjacent to structure directly exposed to engine exhaust aft of engine exhaust plane (1 minute) <sup>2/</sup>	0.7	0.05	0.60
Takeoff <sup>1/</sup>	In engine compartment or adjacent to engine forward 0.1 of engine exhaust plane (1 minute) <sup>2/</sup>	0.1	0.17	0.04
Takeoff <sup>1/</sup>	All other locations (1 minute) <sup>2/</sup>	0.002	0.02	0.02

<sup>1/</sup> Takeoff or landing

<sup>2/</sup> 0.5 minutes for vertical takeoff/landing mode

<sup>3/</sup> Horizontal

<sup>4/</sup> Vertical

MIL-HDBK-781

TABLE XL.VI. Environmental profile sequence.

TEST PHASE	TYPICAL RELIABILITY MISSION PROFILE TEST SEQUENCE (ONE CYCLE) TEST PHASE AND DEFINITION <sup>1/2</sup>	TEST PHASE APPLICABILITY	GENERAL NOTES FOR CHART
•	TEMPERATURE TRANSITION - AMBIENT/COLD	SET INITIAL CONDITIONS	1) FOR ALL TEST TOLERANCES. SEE PARAGRAPH 4.4 OF MIL-STD-810
A	GROUND OPERATION - COLD	CF <sup>2/</sup> ONLY	2) FOR THE GENERAL TEST PERFORMANCE GUIDANCE, SEE MILSTD-810, PARAGRAPHS 4.5.1 THROUGH 4.5.9
B	MISSION PROFILE - COLD	BOTH CF AND FF <sup>4/</sup>	3) SEE PARAGRAPH 5.9.2 FOR DEFINITION OF THE HOST AIRCRAFT/MISSION TESTING PROFILES, OR MIL-STD-810, METHOD 520, TABLE 520.0-1. (UTILIZATION RATES OF MISSION PROFILES)
C	TEST TRANSITION - COLD/AMBIENT	CF ONLY	
D	GROUND OPERATION - AMBIENT	BOTH CF AND FF	
E	MISSION PROFILE - AMBIENT	BOTH CF AND FF	
F	TEST TRANSITION - AMBIENT/HOT	BOTH CF AND FF	
G	GROUNDOPERATION-HOT	CF ONLY	
H	MISSION PROFILE - HOT	BOTH CF AND FF	
I	GROUND OPERATION - HOT	CF ONLY	
J	MISSION PROFILE - HOT	BOTH CF AND FF	
K	TEST TRANSITION - HOT/AMBIENT	BOTH CF AND FF	
L	GROUND OPERATION - AMBIENT	BOTH CF AND FF	
M	MISSION PROFILE - AMBIENT	CF ONLY	
N	TEST TRANSITION - AMBIENT/COLD	BOTH CF AND FF	
O	GROUNDOPERATION-COLD	BOTH CF AND FF	
P	MISSION PROFILE - COLD	CF ONLY	
Q	GROUNDOPERATION-COLD	BOTH CF AND FF	
•	TEMPERATURE TRANSITION - COLD/AMBIENT	CF ONLY END OF TEST AFTER COMPLETION OF SPECIFIED CYCLES OR FAILURE/NON FUNCTIONAL CONDITION	

<sup>1/</sup> See FIGURES 130 and 131

<sup>2/</sup> See TABLE LVII for Composite Test Cycle Profile Example Timeline

<sup>3/</sup> CF is captive flight

<sup>4/</sup> FF is free flight

**TABLE XLVII. Stores host aircraft mission utilization rates for environmental testing.**

**Example utilization rates of mission profiles**

Mission <sup>1/</sup>	Percent Utilization Rate
Ground Attack, Training	40
Ground Attack, Combat	20
Defensive Maneuvers	20
Search and Rescue	10
Functional Check	5
Training Cycle	5
	<u>100</u>

<sup>1/</sup> Since the first three missions, as a group, total 80 percent of the utilization rate, these three mission profiles would be selected for combined environmental testing. If any of the other missions are determined to include extreme or sustained environmental conditions not encountered in the first three missions, then those missions also should be selected, thereby adding the most diversity to the test cycle. If the first mission selected is utilized twice as much as the other two missions, then Mission 1 should be run twice as much per cycle. (See MIL-STD-810, Table 520.0-1)

TABLE XLVIII. Random vibration,  $g_{rms}$  (OVL), level adjustment factors for the maximum predicted environment

(95th percentile with 50 percent confidence based on one-side tolerance limit).

EQUATION i (NUMBER)	AIR-LAUNCHED MISSILES AND ASSEMBLED EXTERNAL STORES CONDITION OF CONFIGURATION <sup>1/ 2/</sup>	$g_{rms}$ (OVL) FACTOR FOR BASELINE MAXIMUM PREDICTED ENVIRONMENT <sup>1/ 2/</sup>	MINIMUM DYNAMIC PRESSURE (q) BELOW WHICH $g_{rms}$ (OVL) = 1.3 (CONSTANT)	FIGURE NUMBER APPLICABLE
1.	<u>COMBINED</u> MULTIPLE-USE ALL STORE (BASELINE)	1.00	250	132
2.		0.88	284	
3.		1.28	195	
4.	<u>AIR-TO-SURFACE (AGM)</u> MULTIPLE-USE ALL STORES	0.96	260133	
5.		0.83	302	
6.		1.25	201	
7.	<u>AIR-TO-AIR (AAM)</u> MULTIPLE-USE ALL STORES	1.07	235	134
8.		0.97	259	
9.		1.38	182	

<sup>1/</sup> THE MAXIMUM PREDICTED ENVIRONMENT (AS DETERMINED FROM RANDOM VIBRATION STATISTICAL ANALYSES) IS DEFINED BY + 6 dB LOG-LOG  $g_{rms}$  (OVL) VERSUS q LEVEL EQUAL TO OR GREATER THAN THE 95TH PERCENTILE VALUE AT LEAST 50 PERCENT OF THE TIME. SEE FIGURE 132 FOR THE BASELINE  $g_{rms}$  VERSUS q FOR ALL STORES.

<sup>2/</sup> CLUSTER MOUNT VALUES ARE ONLY VALID FOR CAPTIVE- FLIGHT CONDITIONS.

<sup>3/</sup> EQUATION OF LINE,  $g_{rms}$  VERSUS q (6 dB/OCTAVE ON LOG-LOG):  
 (FROM i = 1 TO 9)

$$[g_{rms} (OVL)]_i = (10^{[EXP]})_i (BASELINE)$$

$$[exp] = [1 \log_{10}(q) - (2.28533)]$$

$$[g_{rms} (OVL)]_i = (FACTOR)_i [g_{rms} (OVL)]_i (BASELINE)$$

MIL-HDBK-781

TABLE XLIX. Method of calculating the acceleration power spectral density spectrum to produce

$$\sum_{i=1}^N A_i \text{ equal to a unit } = g_{rms} \text{ (OVL)}$$

REFERENCE FIGURE NUMBER	EQUATION (ALL PSD SLOPES, M, ARE EITHER ± 3 dB/OCTAVE )	REMARKS
135(a)	$W_0 = [(f_2 - f_1) + (f_2) \ln_2(f_2/f_1)]^{-1}$ $W_0 = (\text{LEVEL ADJUSTMENT FACTOR})^2 W_0$ $W_0 = (g_{rms})^2 W_0$ <p>THIS SPECTRUM IS FOR USE ONLY WITH WING-MOUNTED AND FIN-TIP STORES IN THE RANGE OF <math>q \leq 250</math> lbs/sq-ft AND MACH NUMBER <math>\leq 0.45</math>.</p>	<p>(1) <math>W_0</math> FOR ONBOARD EQUIPMENT AND FULLY-STORES</p> <p>(2) <math>W_0</math> TO PRODUCE THE ACCELERATION PSD LEVEL WITH LEVEL ADJUSTMENT FACTOR (EQUIVALENT TO <math>W_0</math>, FIGURE 135(a))</p> <p>(3) SEE FIGURES 132 THROUGH 134</p>
135(b)	$W_0 = (f_2 / f_1) (f_2 - f_1) + (0.5) (f_2 - f_1^2 / f_1) + (f_0 - f_1)^{-1}$ $W_1 = (f_2 / f_1) W_0$ $W_0 = (\text{LEVEL ADJUSTMENT FACTOR})^2 W_0 = (g_{rms})^2 W_0$ $W_1 = (\text{LEVEL ADJUSTMENT FACTOR})^2 W_1 = (g_{rms})^2 W_1$ <p>THE SPECTRUM IS FOR USE WITH ALL FULLY-ASSEMBLED EXTERNAL STORES, FOR ALL DYNAMIC PRESSURES (q), EXCEPT FOR WING PYLON AND FIN-TIP SPECTRUM SPECIFIED FOR THE RANGE OF <math>q \leq 250</math> lbs/ft<sup>2</sup> AND MACH NUMBER <math>\leq 0.45</math>.</p>	<p>(1) <math>W_0</math> FOR ASSEMBLED EXTERNAL STORES, MAXIMUM PSD LEVEL</p> <p>(2) <math>W_1</math>, SAME, FOR PRODUCE THE ACCELERATION PSD LEVEL WITH LEVEL ADJUSTMENT FACTOR (EQUIVALENT TO <math>W_0</math> AND <math>W_1</math> IN FIGURE 135(a))</p> <p>(4) SEE FIGURES 132 THROUGH 134</p>

TABLE XLIX. Method of calculating the acceleration power spectral density spectrum to produce

$$\sum_{i=1}^N A_i \text{ equal to a unit } g_{rms} \text{ (OVL) (Continued)}$$

REFERENCE FIGURE NUMBER	EQUATION (ALL PSD SLOPES, M (SLOPE) = ± 3 dB/OCTAVE )	REMARKS
136	$W_0 = \left[ \frac{(f_2 / f_1) (f_2 - f_1) + (0.5 (f_3 - f_2)^2 / f_3)}{(f_4 - f_3) + (f_4 \ln_2 [f_2 / f_1])} \right]^{-1}$ $W_1 = W_0 (f_2 / f_1)$ $W_0 = (\text{LEVEL ADJUSTMENT FACTOR}) (W_0) = (g_{rms})^2 (W_0)$ $W_1 = (\text{LEVEL ADJUSTMENT FACTOR}) (W_1) = (g_{rms})^2 (W_1)$ <p>THIS SPECTRUM IS FOR USE WITH EQUIPMENT INSTALLED IN EXTERNAL STORES IN THE RANGE OF <math>q \geq 250 \text{ lbs/ft}^2</math> AND MACH <math>\geq 0.45</math>. SEE FIGURE 135(a) LOW SPEED</p>	<p>(1) <math>W_0</math> MAXIMUM LEVEL PSD FOR ONBOARD EQUIPMENT INSTALLED IN EXTERNAL STORES. USE IN CONJUNCTION WITH LIMITS OF FIGURE 135(a)</p> <p>(2) <math>W_1</math>, SAME FOR MINIMUM PSD SPECTRUM LEVEL</p> <p>(3) <math>W_0</math> AND <math>W_1</math> TO PRODUCE THE ACCELERATION PSD LEVEL WITH LEVEL ADJUSTMENT FACTOR. (EQUIVALENT TO <math>W_0</math> AND <math>W_1</math> IN FIGURE 136)</p> <p>(4) SEE FIGURES 132 THROUGH 134</p>

TABLE XLIX. Method of calculating the acceleration power spectral density spectrum to produce

$$\sum_{i=1}^N A_i \text{ equal to a unit } = g_{rms}(OVL) \text{ (Continued)}$$

REFERENCE FIGURE NUMBER	EQUATION (ALL PSD SLOPES, M (SLOPE) = ± 3 dB/OCTAVE )	REMARKS
137	<p><b>THESE EQUATIONS ARE FOR INFORMATION ONLY</b></p> $M_1 = (6.9019) [\log_{10}(f_r/f_1)]^{-1}$ $M_2 = (-6.9019) [\log_{10}(f_r/f_n)]^{-1}$ $g_{rms}(OVL) = \left( \sum_{i=1}^2 A_i \right)^{1/2}$ <p>WHERE (M<sub>i</sub> ≥ ± 9.844 dB/OCTAVE):</p> $A_1 = \left( \frac{6}{3 + M_1} \right) \left[ f_r - \left( \frac{5}{f_n} \right)^{\frac{M_1}{3}} (5) \right]$ $A_2 = \left( \frac{0.03}{3 + M_2} \right) \left[ 20 - \left( \frac{f_n}{20} \right)^{\frac{M_2}{3}} (f_n) \right]$	<p>FIXED (NON-VARIABLE) INPUT                      BUFFER SPECTRUM</p> <p>(1) RISING SLOPE,                      (+M<sub>1</sub> IN dB/OCTAVE)</p> <p>(2) FALLING SLOPE,                      (-M<sub>2</sub> IN dB/OCTAVE)</p> <p>(3) f<sub>r</sub> IS THE FIRST BODY                      BENDING FREQUENCY OF                      THE EXTERNAL STORE</p> <p>(4) g<sub>rms</sub> (OVL) VALUE IN                      BUFFER FOR 6 SECONDS                      DURATION</p> <p>(5) A<sub>1</sub> IS THE AREA UNDER THE                      PSD VERSUS FREQUENCY                      CURVE FROM f<sub>1</sub> = 5 Hz TO                      f<sub>n</sub> (Hz). A<sub>2</sub> IS THE AREA                      FROM f<sub>n</sub> (Hz) TO 20 Hz.</p>

MIL-HDBK-781

TABLE L. Preliminary operational design requirements (expected life of 5 years)

ENVIRONMENT	TRANSPORTATION EVENT			HANDLING EVENT			STORAGE EVENT			FLIGHT EVENT	
	TRUCK	RAIL	SHIP	AIR/FREIGHT	MOVEMENT/ MAINTENANCE	INSTALL	RELOAD	COVERED	OPEN DUMP	CAPTIVE FLIGHT	FREE FLIGHT
COMBINED ENVIRONMENT	PROBABLE COMBINATION OF OPERATIONAL ENVIRONMENTS WILL BE SPECIFIED IN THE TESTING DOCUMENTS. (DESIGN TO COMBINED ENVIRONMENTS BASED ON THE REQUIREMENTS OF MIL-STD-170 AND MIL-STD-191.)										
FREE AIR TEMPERATURE - HIGH SOAK	32°C	32°C	32°C	60°C	11°C (CONTAINER) 19°C (OUT OF CONTAINER)	49°C	32°C	32°C	71°C	43°C	43°C
FREE AIR TEMPERATURE - LOW SOAK	-20°C FOR 6 HRS	-20°C FOR 6 HRS	-20°C FOR 6 HRS	-10°C FOR 2 HRS	-10°C FOR 72 HRS (LAND) 0°C (SEA) FOR 24 HRS	-10°C FOR 72 HRS	-10°C FOR 72 HRS	-23°C FOR 72 HRS	-40°C FOR 72 HRS	-23°C FOR 20 MINUTES FOR 6 MINUTES	-23°C FOR 6 MINUTES
REDUCED THERMAL (EXTERNAL SEED)	N/A	N/A	N/A	N/A	N/A	N/A	N/A	N/A	N/A	SEE FREE AIR TEMPERATURES	N/A
REDUCED THERMAL (INTERNAL EQUIPMENT)	N/A	N/A	N/A	N/A	N/A	N/A	N/A	N/A	N/A	N/A	N/A
RELATIVE HUMIDITY	90% AT 24°C AND 13% AND 25% AT 50°C	90% AT 24°C AND 13% AT 50°C	90% AT 24°C AND 13% AT 50°C	90% AT 10°C AND 34% AT 30°C AND 11% AT 40°C	90% AT 10°C AND 100% AT 30°C AND 10% AT 40°C	90% AT 10°C AND 100% AT 30°C AND 10% AT 40°C	90% AT 10°C AND 100% AT 30°C AND 10% AT 40°C	90% AT 10°C AND 100% AT 30°C AND 10% AT 40°C	90% AT 10°C AND 100% AT 30°C AND 10% AT 40°C	TEMPERATURE - HUMIDITY CAP TYPE TO 40°C 90% TO 30°C 90% AT 40°C AND 34% 90% AT 40°C	TEMPERATURE - HUMIDITY CAP TYPE TO 40°C 90% TO 30°C 90% AT 40°C AND 34% 90% AT 40°C
SOLAR RADIATION	IN GENERAL WILL BE TREATED AS COVERED STORAGE FOR UNPROTECTED ORIENTATION. SEE ORIENTATION.										

\*NOTE 1/ FOR THERMAL SHOCK - THE MAXIMUM RATE OF TEMPERATURE CHANGE FOR THE RADOME EXTERIOR IS 26°C/S/C. FOR INTERIOR COMPARTMENT THE MAXIMUM RATE OF TEMPERATURE CHANGE IS 8°C/SEC.  
 2/ THE CRITICAL DESIGN REQUIREMENTS ARE OUTLINED IN BOLD-FACE BLOCKS

MIL-HDBK-781

TABLE L. Preliminary operational design requirements (expected life of 5 years) (Continued)

ENVIRONMENT	TRANSPORTATION EVENT			MANOVLING EVENT		STORAGE EVENT		FLIGHT EVENT			
	THRUST	PALE	SHIP	AIR FREIGHT	MOVEMENT/ MAINTENANCE	RETRIEVAL	NEED	COVERED	OPEN DUMP	CAP/TRE FLIGHT	FREE FLIGHT
COMBINED ENVIRONMENT SHOCK (DESIGN 7 OR 8 SHOCKS - PLUS 3 HOURS PER AIMS - TOTAL 10)	PROBABLE COMBINATIONS OF OPERATIONAL ENVIRONMENTS WILL BE SPECIFIED IN THE TESTING DOCUMENTS. (DESIGN TO COMBINED ENVIRONMENTS BASED ON THE REQUIREMENTS OF MIL-STD-154 AND MIL-STD-154A.)										
	3 g AT 25 ms (1/2 SINE)	3 g AT 11 ms (1/2 SINE)	3 g AT 7 ms (1/2 SINE)	REGLDABLE	SHOCK (OUT OF CONTAINER)	SHOCK OR WATER IMPACT AT SPK SPEED OF 20 ft/sec. 1/2 SINE. 1/2 g. 1/2 SINE. 1/2 g. 1/2 SINE.	N/A	N/A	N/A	EJECTION SHOCKS (VERT. 15 ms AND 15 g. 15 ms (RADIAL) - BOOSTER IGNITION 10 ms (LONG) FOR FREE FLIGHT BOOST (SEE 2/ FOR PPHO SHOCK)	10 g FOR 10 ms (ABAL). 12 g FOR 10 ms (RADIAL) - BOOSTER IGNITION 10 ms (LONG) FOR FREE FLIGHT BOOST (SEE 2/ FOR PPHO SHOCK)
WHEEL LAKEOUS PACKAGING DESIGN REQUIREMENTS	DESIGNABLE TO MIL-P-44348 - CONTAINER DESIGN TO MEET REQUIREMENTS FOR TEST METHOD NO. 1988. METHODS (MIL 9907, 9908, 9909) (PARAGRAPH 12.03, 9912, 9914, AND 9918, PARAGRAPH 12.01, MIL-STD-648)										
LAUNCH VIBRATION (ALL D AXES)	N/A	N/A	N/A	N/A	TILT/DRIFT OF CONTAINER IN SHIPPER (MIL 9907, 9908, 9909) SAFE HANDLE (GROUP) (MIL 9907)	N/A	N/A	N/A	N/A	N/A	N/A
	1.5 g FROM 5.5 Hz TO 200 Hz	1.5 g FROM 1.5 Hz TO 200 Hz	1.5 g FROM 1.5 Hz TO 200 Hz	REGLDABLE	REGLDABLE	REGLDABLE	N/A	N/A	N/A	LAUNCH AT MACH 0.95, 10 g. 15 g.	LAUNCH AT MACH 0.95, 10 g. 15 g.
											3

\*NOTE 2/ FOR PYROTECHNIC SHOCK - 500 Hz TO 10,000 Hz +6 dB/ACTAVE  
 10,000 Hz TO 12,000 Hz 7500g (PEAK - SHOCK SPECTRUM, q = 10)  
 -6 dB/ACTAVE

TABLE L. Preliminary operational design requirements (expected life of 5 years)

ENVIRONMENT	TRANSPORTATION EVENT			HANDLING EVENT		STORAGE EVENT		FLIGHT EVENT					
	TRUCK	RAIL	SNIP	AMP/REBENT	MOVEMENT/	MAINTENANCE	INTERNAL	MEL DO	COMPACT	OPEN DUMP	CAP THE FLIGHT	FREE FLIGHT	
	N/A	N/A	N/A	REB. MOBILE	N/A	N/A	EXTERNAL	N/A	N/A	N/A	EXTERNAL W/ AB	EXTERNAL W/3	
ACOUSTIC							INTERNAL 300-1000 Hz FOR 30 MINUTES				INTERNAL W/ AB ON 13 TO 8,000 Hz. W/ AB 0.0002 DYNES/cm <sup>2</sup> OR 34 MINUTES	INTERNAL W/3 AB OVERALL TO 8,000 Hz (NET 0.0002 DYNES/cm <sup>2</sup> ) FOR 2 MINUTES	
ACCELERATION (MANUEVER-HAS PITCH AND ROLL)											Mx-21.0 g My-21.0 g Mz-21.0 g PITCH AND ROLL RATES 4.0-10.0 TO 10 4.0-10.0	Mx-21.0 g My-21.0 g Mz-21.0 g PITCH AND ROLL RATES 4.0-10.0 TO 10 4.0-10.0	
ALTITUDE (FEET)	SL TO 10,000 FT	SL TO 10,000 FT	SL	8000 TO 80,000 (TEMP. LOUPE DECORPENS. SHOWN IN 0.3 DEG)	SL TO 8000 FT	SL TO 8000 FT	SL TO 8000 FT	SL TO 8000 FT	SL TO 8000 FT	SL TO 8000 FT	SL TO 35,000 FT	SL TO 50,000 FT	
ELECTRO- MAGNETIC	DESIGN TO THE REQUIREMENTS OF MIL-STD-883C, PART 2, MIL-E-1699, MIL-HDBK-237, AND MIL-HDBK-253, AND MIL-STD-1818 OR DE SEN GUIDANCE (EXCEPT AS MODIFIED BY PAR. 4.4.1). FOR HIR, DESIGN IN ACCORDANCE WITH MIL-STD-1818, USE LEMMA 2004-3 V, 10 PWS OR PEAK FOR 0.5% DUTY CYCLE												
EMC	DESIGN NOT APPLY TO SYSTEM REQUIREMENTS												
IMMERSION							SEA STATE CODE 4, SALT WATER - Less than 24 HOURS (SEE 5.7)				WITH STAMP SLIP IMMERSION UNDER 2 FOOT HEAD OF FRESH WATER FOR 4 HOURS		
CORROSION (SALT FOG)							MIL-STD-883C METHOD 599.1 (DLESH) ELECTROLYSIS COMPART. WATER- TIGHT				10% SALT SOLUTION, SALT FOG AT 70% 95% ILL, 5% SODIUM CHLORIDE PLUS 2% PERCHLORATE, 1% OZONE		

\*NOTE: 4/ SL - SEA LEVEL  
 5/ FOR RAJOME AND ANTENNA - A 70 FOOT HEAD OF WATER PRESSURE IS REQUIRED. FOR ENGINE ... 3 TWO-HOUR IMMERSIONS IN SALT WATER.  
 6. +31 Kg APPLIES TO BOOST ONLY.

MIL-HDBK-781

TABLE L. Preliminary operational design requirements (expected life of 5 years)

ENVIRONMENT	TRANSPORTATION EVENT			HANDLING EVENT			STORAGE EVENT			FLIGHT EVENT		
	TRUCK 2 IRL PER HOUR FOR 1 HOUR	TRAILER 2 IRL PER HOUR FOR 1 HOUR	AIR FREIGHT SHIP 2 IRL PER HOUR FOR 1 HOUR	MOVEMENT/ MAINTENANCE 2 IRL PER HOUR FOR 1 HOUR	RETINAL 2 IRL PER HOUR FOR 1 HOUR	PILEO N/A	CORROD N/A	OF ENDUP 2 IRL PER HOUR FOR 1 HOUR	CAP THE FLIGHT 2 IRL PER HOUR FOR 1 HOUR UP TO 24 HOURS	FREE FLIGHT 4 IRL PER HOUR FOR 2 HOURS	N/A	N/A
RAIN	N/A	N/A	N/A	N/A	N/A	N/A	N/A	N/A	N/A	N/A	N/A	N/A
SNOW	N/A	N/A	N/A	N/A	0.5 IRL PER HOUR AS NOTES FROM 50° TO -10° FOR 1 HOUR	N/A	N/A	LOAD OF 10 LB/SQ FT - 20 TO -10°C	N/A	N/A	N/A	N/A
ICE	1 IRL PER HOUR 2 IN BUILDUP	1 IRL PER HOUR 2 IN BUILDUP	1 IRL PER HOUR 2 IN BUILDUP	1 IRL PER HOUR 2 IN BUILDUP	N/A	N/A	N/A	1 IRL PER HOUR 2 IN BUILDUP	N/A	N/A	N/A	N/A
SAND AND DUST	45 KNOTS, 0.1 TO 0.2 mm DAMPETER 0.3 G/M <sup>3</sup>	45 KNOTS, 0.1 TO 0.2 mm DAMPETER 0.3 G/M <sup>3</sup>	N/A	45 KNOT WIND, WITH DENSITY 0.2 G/M <sup>3</sup> , 110 0.3 mm DAMPETER 0.3 G/M <sup>3</sup>	45 KNOTS, 0.1 TO 0.2 mm DAMPETER 0.3 G/M <sup>3</sup>	N/A	N/A	45 KNOT WIND, WITH DENSITY 0.2 G/M <sup>3</sup> , 110 0.3 mm DAMPETER 0.3 G/M <sup>3</sup>	45 KNOTS, 0.1 TO 0.2 mm DAMPETER, 0.3 G/M <sup>3</sup>	N/A	N/A	N/A
EXPLOSIVE ATMOSPHERE	N/A	N/A	N/A	MEETS REQUIRE- MENTS OF METHOD 311 PHL-STD-490C (OUT OF CONTAINER)	N/A	N/A	N/A	N/A	MEETS REQUIRE- MENTS OF METHOD 311, PHL- STD-490C	N/A	N/A	N/A
FUNGUS	N/A	N/A	N/A	N/A	DESIGN TO MEET THE REQUIREMENTS FOR TESTING PROVIDED BY METHOD 349.2, PHL- STD-490C	N/A	N/A	N/A	N/A	N/A	N/A	N/A
OZONE	N/A	N/A	N/A	N/A	DESIGN TO MAXIMUM CONCENTRATION OF 22 MICROGRAMS PER CUBIC FOOT	N/A	N/A	N/A	N/A	N/A	N/A	OUT OF CONTAINER

TABLE L. Preliminary operational design requirements (expected life of 5 years). (Continued)

FLIGHT EVENT			
	COMPARTMENT	EXTERNAL	INTERIOR
	LOCATION	SURFACE	AIR
		(°C)	(°C)
INDUCED THERMAL	RADOME	421	71
	PAYLOAD (FWD)	357	132
	PAYLOAD (AFT)	329	132
	RECOVERY	366	143
	FUEL TANK	360	164
	FMS	393	192
	FAIRINGS	382	N/A
	FINS	382	N/A
	ACTUATOR	N/A	246
	COMBUSTOR	449	N/A

FLIGHT EVENT	
VIBRATION (ALL 3 AXES)	<u>CAPTIVE FLIGHT VIBRATION (INPUT)</u>
	20-150Hz 0.01 g <sup>2</sup> /Hz
	150-500Hz + 3dB/OCTAVE
	500-1500Hz 0.04g <sup>2</sup> /Hz
	1500-2000Hz - 3dB/OCTAVE
	OVERALL: 8.24g <sub>rms</sub>
	DURATION: 1 HOUR PER AXIS
	<u>FREE FLIGHT VIBRATION (INPUT)</u> (FORWARD OF INLETS)
	20-500 + 3dB/OCTAVE
	500-2000 0.08g <sup>2</sup> /Hz
OVERALL: 11.8 g <sub>rms</sub>	
DURATION: 2 MINS. 15 SECONDS	
(AFT OF INLETS)	
20-2000Hz 0.43 g <sup>2</sup> /Hz	
OVERALL: 29.2 g <sub>rms</sub>	
DURATION: 2 MINUTES	

**TABLE LI. Life cycle environments.**

U.S. NAVY  
 AN EXAMPLE  
 SUMMARY CHARTS FOR THE  
 LOGISTIC LIFE CYCLE  
 ENVIRONMENTS  
 FORA  
 LIFE OF 5-YEARS  
 (43800 HOURS)

**SUMMARY OF  
 STORES LIFE DISTRIBUTION (5-YEARS) IN MAJOR LIFE CYCLE PHASES**

**1. FACTORY/DEPOT REWORK**

STORE (5 YEARS 43800 HRS)	IN-ROUTE TRANSPORT HOURS (PERCENT)	MOVEMENT/ HANDLING HOURS (PERCENT)	HANDLE HOURS (PERCENT)	STORAGE/MAINT HOURS (PERCENT)	HOLD/DELAY AND DUMP STORAGE HOURS (PERCENT)	CAPTIVE AND FREE FLIGHT HOURS (PERCENT)
AN EXAMPLE	1667 (3.81)	809 (1.85)	40 (.09)	6120 (13.97)	35141 (80.23)	22.68 (.05)

**2. SHOCK**

ITEM NUMBER	SPECIFIED EQUIVALENT AMPLITUDE (3-AXES with exception)	NOMINAL DURATION	MAXIMUM PROBABLE NUMBER	STORE STATUS CONDITION
1.	35G	11 ms	6	1
2.	30G	11 ms	1	2
3.	25G	11 ms	3	5
4.	35G (LONG)	18 ms	2	1
5.	50G (VERT)	6ms	4	6
6.	15G	2 ms	4	6
7.	25G	11 ms	1	6
8.	30G	10 ms	4	6
9.	1 FOOT DROP ON CONCRETE		3	1
10.	18 INCH DROP ON CONCRETE (EDGEWISE DROPS)		1	2

**3. TRANSPORTATION VIBRATION (SINE) -- LOG SWEEP RATE (ASSUMED)**

ITEM NUMBER	ACCELERATION LEVEL (g)	ASSUMED FREQUENCY RANGE (Hz)	ESTIMATED VIBRATION DURATION TOTAL (HOURS)	ESTIMATED DURATION IN-RESOURCE (MINUTES)	STORE STATUS CONDITION
1.	1	2-5	3.0	30.	1
2.	1	5-10	2.3	28.	1
3.	2	10-20	2.3	28.	1
4.	3	20 - 60	3.6	33.	1
5.	5	60 - 500	7.0	48.	1

**TABLE LI. Life cycle environments (Continued)**

U.S. NAVY  
 AN EXAMPLE  
 SUMMARY CHARTS FOR THE  
 LOGISTIC LIFE CYCLE  
 ENVIRONMENTS  
 FORA  
 LIFE OF 5-YEARS  
 (43800 HOURS)  
 (CONTINUED)

**4. CAPTIVE FLIGHT VIBRATION (RANDOM) -- POWER SPECTRAL DENSITY**

ITEM NUMBER	FLIGHT CONDITION FOR STORE	NOMINAL PERCENT MISSIONS EMPLOYED	SAFETY FACTOR ON g-LEVEL	AVERAGE EFFECTIVE MAXIMUM PSD (g <sup>2</sup> /Hz)	LIFETIME DURATION EXPECTED AT MAX. PSD	STORE STATUS CONDITION
1.	MEAN	85.0	1.5	0.040	1.4 Hrs	5
2.	MAX g	1.5	1.5	0.090	1.5 Mins	5
3.	CLIMB/DESC.	9.0	1.5	0.025	9.1 Mins	5
4.	DIVE/PULLOUT	2.5	1.5	0.021	2.5 Mins	5
5.	HIGH BUFFET	1.0	1.5	0.291	1.0 Mins	5
6.	T.O./LANDING	1.0	1.5	0.023	1.0 Mins	5
7.	FREE-FLIGHT	100.0	1.0	0.200	488.0 Secs	6

**5. TEMPERATURE - HUMIDITY**

TEMPERATURE PROFILE		NOMINAL RELATIVE HUMIDITY PERCENT	PROBABLE OCCURRENCE TIME DURATION HOURS
DEG F	(DEG C)		
160	(70.1)	20	20.
140	(60.0)	31	293.
120	(48.9)	40	1720.
100	(37.8)	47	5367.
70	(21.1)	49	8163.
32	(0.0)	43	843.
0	(- 17.8)	34	229.
- 25	(- 31.7)	25	38.
- 45	(- 42.8)	16	4.
- 65	(- 53.9)	3	1.

**6. ACCELERATION (SUSTAINED FREE FLIGHT)**

ITEM NUMBER	MAXIMUM LEVEL (g)	DIRECTION	STORE STATUS CONDITION
1.	+ 31.0	LONGITUDINAL	6
2.	- 4.0	LONGITUDINAL	6
3.	+ 12.0	RADIAL	6
4.	- 12.0	RADIAL	6

TABLE LI. Life cycle environments (Continued)

U.S. NAVY  
 AN EXAMPLE  
 SUMMARY CHARTS FOR THE  
 LOGISTIC LIFE CYCLE  
 ENVIRONMENTS  
 FORA  
 LIFE OF 5-YEARS  
 (43800 HOURS)  
 (CONTINUED)

7. ALTITUDE

<u>ITEM NUMBER</u>	<u>MAXIMUM ALTITUDE (FEET)</u>	<u>MAXIMUM PROBABLE DURATION (TIME)</u>	<u>STORE STATUS CONDITION</u>	<u>FLIGHT EVENT</u>
1.	35000.	17. Hrs	1,2	AIR FREIGHT
2.	>40000.	1. Hrs	5	CAPTIVE FLIGHT
3.	>30000.	5. Hrs	5	CAPTIVE FLIGHT
4.	>20000.	9. Hrs	5	CAPTIVE FLIGHT
5.	5000.	33. Sec	6	FREE FLIGHT

8. SALT SPRAY

<u>ITEM NUMBER</u>	<u>MAXIMUM ALLOWABLE EFFECT</u>	<u>DIRECT EXPOSURE DURATION EXPECTED (DAYS)</u>	<u>STORE STATUS CONDITION</u>
1.	ALLOWABLE CORROSION LEVEL EQUIVALENT TO 0.007 INCHES OF HOT ROLLED STEEL DISSIPATED PER 5 YEARS LIFE CYCLE.	50.	1,3,4
2.	SAME, EXCEPT 0.001 IN.	5.	2,5,6

9. ACOUSTIC

<u>ITEM NUMBER</u>	<u>ASSUMED MAXIMUM LEVEL (dB OVERALL)</u>	<u>FREQUENCY RANGE (Hz)</u>	<u>MAXIMUM PROBABLE DURATION (TIME)</u>	<u>STORE STATUS CONDITION</u>
1.	110	20 - 20000	33. Hrs	1
2.	120	20 - 20000	9. Hrs	2
3.	160	20 - 20000	1. Hrs	5
4.	163	20 - 20000	488. Sec	6

TABLE LI. Life cycle environments (Continued)  
 U.S. NAVY  
 AN EXAMPLE  
 SUMMARY CHARTS FOR THE  
 LOGISTIC LIFE CYCLE  
 ENVIRONMENTS  
 FORA  
 LIFE OF 5-YEARS  
 (43800 HOURS)  
 (CONTINUED)

10. RAIN

<u>ITEM NUMBER</u>	<u>EXPECTED MAXIMUM LEVEL (IN/HR)</u>	<u>MAXIMUM PROBABLE DURATION</u>	<u>STORE STATUS CONDITION</u>
1.	2	80. Hrs	1
2.	2	1. Hrs	2
3.	2	3. Min	5
4.	2	160. Sec	6

11. SNOW

<u>ITEM NUMBER</u>	<u>EXPECTED MAXIMUM LEVEL (IN/HR)</u>	<u>MAXIMUM PROBABLE DURATION</u>	<u>STORE STATUS CONDITION</u>
1.	10	64. Hrs	1
2.	10	1. Hrs	2
3.	10	2. Mm	5
4.	10	128. Sec	6

12. SAND AND DUST

<u>ITEM NUMBER</u>	<u>MAXIMUM PROBABLE LEVEL</u>	<u>MAXIMUM PROBABLE DURATION</u>	<u>STORE STATUS CONDITION</u>
1.	45 MPH WIND. 0.001 TO 0.125 INCH DIAMETER PARTICLE SIZE	38. Hrs	1
2.	SAME	1. Hrs	2,5,6

TABLE LI. Life cycle environments (Continued)

EUROPEAN SCENARIO (NOMINAL)  
 US NAVY STORES LOGISTIC LIFE CYCLE  
 (NOMINAL PARAMETERS)  
 5-YEAR LIFE CYCLE

DURATION AND LEVELS OF EXPOSURE TO ENVIRONMENTS  
 APPLICABLE TO AN EXAMPLE

**ASSUMPTIONS**

A) FACTORY IS ASSUMED  
 TO BE IN CENTRAL CONUS

B) 1 RT CONUS-AB/AC-CONUS  
 2 RT AB/AC-EUROPE DEPOT-AB/AC

C) SEE EXPLANATORY NOTES  
 AT END OF TABLE

ENVIRONMENT EVENT	DURATION	SHOCK (NUMBERS) a-LEVEL PER MSECS	VIBRA- TION		TEMP °C (PROBABLE HOURS)	ALTITUDE 1000 FEET	HUMIDITY (AT TEMP.) PROBABLE PERCENT	ACCELERATION	SALT SPRAY ML OF HOT ROLLED STEEL DISSIPATED/ YEAR	FUNGUS	ACOUSTICS		RAIN* IN/HR (PER YEAR)	SNOW* IN/HR (PER YEAR)	SAND WIND MPH	DUST IN DMA	STATUS (SEE NOTE 0)
			a	M2							dB	MZ					
1. FACTORY PRODUCTION HANDLING	4 HOURS	(2) 15 a 11- 10* MS	-	-	25 (4)	SEA LEVEL	84	-	-	-	-	-	-	-	-	-	1
2. FACTORY RE- WORK HANDLING	4 HOURS	(2) 15 a 11- 10* MS	-	-	25 (4)	SEA LEVEL	84	-	-	-	-	-	-	-	-	-	1
3. TRANSPORT TO DEPOT	264 HOURS	(66) SEE NOTES A AND J	SEE NOTE B	-	30 (10) - 20 (1)	40	69 48	-	-	-	110 dB 20 TO 15,000*	2 (12 MM/HR ANY 24 HRS NOM- INAL)	2 (12 MM/HR ANY 24 HRS NOM- INAL)	45 MPH 0.001 TO 0.125 INCHES	-	-	1
4. TRANSPORT HANDLING	80 HOURS	(20) 15 a 11- 10* MS	-	-	30 (14) 15 (12)	SEA LEVEL	84 79	-	-	-	-	-	-	-	-	-	1
5. CONUS HOLD/ DELAY	52 DAYS	-	-	-	30 (49) - 35 (2)	SEA LEVEL	69 88	-	-	-	-	-	-	-	-	-	1
6. DEPOT DEAD STORAGE	60 DAYS	-	-	-	30 (54) - 35 (3)	SEA LEVEL	69 85	-	-	-	-	-	-	-	-	-	1

TABLE LI. Life cycle environments (Continued)

EUROPEAN SCENARIO (NOMINAL)  
 US NAVY STORES LOGISTIC LIFE CYCLE  
 (NOMINAL PARAMETERS)  
 5-YEAR LIFE CYCLE

DURATION AND LEVELS OF EXPOSURE TO ENVIRONMENTS  
 APPLICABLE TO AN EXAMPLE

**ASSUMPTIONS**

A) FACTORY IS ASSUMED  
 TO BE IN CENTRAL CONUS

B) 1 RT CONUS-AB/AC-CONUS  
 2 RT AB/AC-EUROPE DEPOT-AB/AC

C) SEE EXPLANATORY NOTES  
 AT END OF TABLE

ENVIRONMENT EVENT	DURATION	SHOCK (NUMBERS) g-LEVEL PER MSECS	VIBRA- TION		TEMP °C (PROBABLE HOURS)	ALTITUDE 1000 FEET	HUMIDITY (AT TEMP.) PROBABLE PERCENT	ACCELERATION	SALT SPRAY ML OF HOT ROLLED STEEL DISSIPATED/ YEAR	FUNGUS	ACOUSTICS		RAM*	SNOW*	SAND DUST		STATUS (SEE NOTE 6)
			g	HZ							dB	HZ			IN/HR (PER YEAR)	IN/HR (PER YEAR)	
7. DEPOT HANDLING	3 HOURS	(2) 15 g 11-10* MS	-	-	25 (3)	SEA LEVEL	84	-	-	-	-	-	-	-	-	-	3
8. DEPOT TEST HANDLING	8 HOURS	(5) 15 g 11-10* MS	-	-	25 (8)	SEA LEVEL	84	-	-	NO VISUAL EVIDENCE OF FUNGUS GROWTH	-	-	-	-	-	-	6
9. TRANSPORT HANDLING	10 HOURS	(2) 15 g 11-10* MS	-	-	30 (1) 15 (1)	SEA LEVEL	84 79	-	-	-	-	-	-	-	-	-	1
10. SHIPPING AND TRANSPORT (CONUS)	304 HOURS	(16) SEE NOTES A AND J	SEE NOTE B	-	50 (15)-20 (1)	SEA LEVEL	69 48	-	0.125	-	-	-	2 (12 PMW ANY 24 HRS NOM- INAL)	10 (12 PMW ANY 24 HRS NOM- INAL)	-	-	1
11. TRANSPORT (TO EUROPE)	300 HOURS	(16) 30 g 5-11* MS (M24 HRS)	0.4 g 5- 55 HZ	-	50 (15)-20 (1)	00	69 48	-	0.125	-	110 dB 20 TO 15,000*	2 (12 PMW ANY 24 HRS NOM- INAL)	10 (12 PMW ANY 24 HRS NOM- INAL)	-	-	-	

TABLE LI. Life cycle environments (Continued)

EUROPEAN SCENARIO (NOMINAL)  
 US NAVY STORES LOGISTIC LIFE CYCLE  
 (NOMINAL PARAMETERS)  
 5-YEAR LIFE CYCLE

DURATION AND LEVELS OF EXPOSURE TO ENVIRONMENTS  
 APPLICABLE TO AN EXAMPLE

**ASSUMPTIONS**

A) FACTORY IS ASSUMED

B) 1 RT CONUS-AB/AC-CONUS

C) SEE EXPLANATORY NOTES

TO BE IN CENTRAL CONUS

2 RT AB/AC-EUROPE DEPOT-AB/AC

AT END OF TABLE

ENVIRONMENT EVENT	DURATION	SHOCK (NUMBERS) G-LEVEL PER MSECS	VIBRA- TION		TEMP °C (PROBABLE HOURS)	ALTITUDE 1000 FEET	HUMIDITY (AT TEMP.) PROBABLE PERCENT	ACCELERATION	SALT SPRAY IN. OF NOT ROLLED STEEL DISSIPATED/ YEAR	FUNGUS		ACOUSTICS		RARE H/HR (PER YEAR)	SNOW H/HR (PER YEAR)	SAND MPH WIND	DUST M DIA.	STATUS (SEE NOTE 6)
			g	HZ						AB	HZ	H/HR (PER YEAR)	H/HR (PER YEAR)					
12. HANDLING (TO EUROPE)	14 HOURS	(4) SEE NOTE C	-	-	30 (2) 15 (2)	SEA LEVEL	84 79	-	-	-	-	-	-	-	-	-	-	1
13. HOLD/ DELAY AT SEAPORT	24 DAYS	-	-	-	50 (24) - 20 (2)	SEA LEVEL	69 60	-	0.125	-	-	-	2 (12 MIN/ ANY 24 HRS NOMI- NAL)	10 (12 MIN/ ANY 24 HRS NOMI- NAL)	-	-	1	
14. TRANS- PORT AND ARRIVAL AT DEPOT	122 HOURS	(30) SEE NOTES A AND J	SEE NOTE B	-	50 (4) - 20 (1)	SEA LEVEL	69 60	-	-	-	-	-	2 (12 MIN/ ANY 24 HRS NOMI- NAL)	10 (12 MIN/ ANY 24 HRS NOMI- NAL)	-	-	1	
15. TEST AND HANDLING AT DEPOT	24 HOURS	(14) 15 g 11- 16" MS	-	-	25 (4)	SEA LEVEL	84	-	-	NO VISUAL EVIDENC E OF FUNGUS GROWTH	-	-	-	-	-	-	1	
16. DEPOT TRANSPORT TO AIRBASE OR CARRIER	144 HOURS	(34) SEE NOTES A AND J	SEE NOTE B	-	50 (5) - 20 (1)	SEA LEVEL	69 60	-	-	-	-	-	-	-	-	-	1	

TABLE LI. Life cycle environments (Continued)

EUROPEAN SCENARIO (NOMINAL)  
 US NAVY STORES LOGISTIC LIFE CYCLE  
 (NOMINAL PARAMETERS)  
 5-YEAR LIFE CYCLE

DURATION AND LEVELS OF EXPOSURE TO ENVIRONMENTS  
 APPLICABLE TO AN EXAMPLE

**ASSUMPTIONS**

A) FACTORY IS ASSUMED  
 TO BE IN CENTRAL CONUS

B) 1 RT CONUS-AB/AC-CONUS  
 2 RT AB/AC-EUROPE DEPOT-AB/AC

C) SEE EXPLANATORY NOTES  
 AT END OF TABLE

ENVIRONMENT EVENT	DURATION	SHOCK (NUMBERS)		VIBRA- TION		TEMP °C (PROBABLE HOURS)	ALTITUDE 1000 FEET	HUMIDITY (AT TEMP.) PROBABLE PERCENT	ACCELERATION	SALT SPRAY ML OF MIST ROLLED STEEL DISPATED YEAR	FUNGUS		ACOUSTICS		RAIN* IN/HR (PER YEAR)	SNOW* IN/HR (PER YEAR)	SAND WIND MPH	DUST IN DIA.	STATUS (SEE NOTE 9)
		g-LEVEL PER MSEC	g	HZ	HZ						DB	HZ	IN/HR (PER YEAR)	IN/HR (PER YEAR)					
17. HOLD/ DELAY TRANSPORT DEPOT TO AIRBASE OR CARRIER	30 DAYS	-	-	-	-	50 (20)-20 (2)	SEA LEVEL	65 48	-	-	-	-	-	-	2 (12 MIN/ ANY 24 HRS NOMI- NAL)	10 (12 MIN/ ANY 24 HRS NOMI- NAL)	45 MPH 0.001 TO 0.125 INCHES	-	1
18. DEPOT STORAGE (EUROPE)	100 DAYS	-	-	-	-	50 (14)-20 (10)	SEA LEVEL	65 48	-	-	-	-	-	-	2 (12 MIN/ ANY 24 HRS NOMI- NAL)	10 (12 MIN/ ANY 24 HRS NOMI- NAL)	45 MPH 0.001 TO 0.125 INCHES	-	1
19. AIR BASE/ CARRIER HANDLING	12 HOURS	(8) 10 g 11- 10" MS 1-1 FOOT DROP ON CONCRETE	-	-	-	30 (2) 15 (1)	SEA LEVEL	84 79	-	-	-	-	-	-	-	-	-	-	1
20. WEAPONS STORE AREA PROG, INSP, DISTRIBUTION	10 HOURS	(12) 15 g 11- 10" MS	-	-	-	30 (3) 15 (2)	SEA LEVEL	84 79	-	-	-	-	-	-	-	-	-	-	1

TABLE LI. Life cycle environments (Continued)

EUROPEAN SCENARIO (NOMINAL)  
 US NAVY STORES LOGISTIC LIFE CYCLE  
 (NOMINAL PARAMETERS)  
 5-YEAR LIFE CYCLE

DURATION AND LEVELS OF EXPOSURE TO ENVIRONMENTS  
 APPLICABLE TO AN EXAMPLE

**ASSUMPTIONS**

A) FACTORY IS ASSUMED  
 TO BE IN CENTRAL CONUS

B) 1 RT CONUS-AB/AC-CONUS  
 2 RT AB/AC-EUROPE DEPOT-AB/AC

C) SEE EXPLANATORY NOTES  
 AT END OF TABLE

ENVIRONMENT	DURATION	SHOCK (NUMBERS)	VIBRATION	TEMP	ALTITUDE	HUMIDITY (AT	ACCELERATION	SALT SPRAY	FUNGUS	ACOUSTICS	RAIN	SNOW	SAND	DUST	STATUS	
		a-LEVEL PER SECS	e HZ	c (PROBABLE HOURS)	1000 FEET	TEMP.) PROBABLE PERCENT		IN. OF HOT ROLLED		dB	HZ	IN/HR (PER YEAR)	IN/HR (PER YEAR)	MPH WIND	IN DIA.	(SEE NOTE 8)
21. TRANSPORT ABANDON-TO-CONUS AND RETURN FACTORY REWORK	1 R.T. (SEE EVENTS 1 THROUGH 20 AND NOTES L AND M)							(SEE EVENTS 1 THROUGH 20 AND NOTES L AND M)								
22. TRANSPORT HANDLINE ABANDON-TO-EUROPEAN DEPOT AND RETURN	2 R.T. (SEE EVENTS 15 THROUGH 20 AND NOTES L AND M)							(SEE EVENTS 15 THROUGH 20 AND NOTES L AND M)								
23. WEAPONS STORE AREA HANDLINE	12 HOURS	(8) 15 g 11-18" MS (SEE NOTE J)	-	30 (2) 10 (7)	SEA LEVEL	64 79	-	-	-	-	-	-	-	-	-	1
24. AB/AC DEAD STORAGE	1343 DAYS	-	-	30 (1205) - 20 (129)	SEA LEVEL	69 48	-	0.125	NO EVIDENCE OF FUNGUS GROWTH (VISUAL INSPECT)	-	2 (12) 100% 100% (NOMINAL)	30 (12) 100% 100% (NOMINAL)	45 MPH @ 0.001 TO 0.125 INCHES	-	-	1

TABLE LI. Life cycle environments (Continued)

EUROPEAN SCENARIO (NOMINAL)  
 US NAVY STORES LOGISTIC LIFE CYCLE  
 (NOMINAL PARAMETERS)  
 5-YEAR LIFE CYCLE

DURATION AND LEVELS OF EXPOSURE TO ENVIRONMENTS  
 APPLICABLE TO AN EXAMPLE

**ASSUMPTIONS**

A) FACTORY IS ASSUMED  
 TO BE IN CENTRAL CONUS

B) 1 RT CONUS-AB/AC-CONUS  
 2 RT AB/AC-EUROPE DEPOT-AB/AC

C) SEE EXPLANATORY NOTES  
 AT END OF TABLE

ENVIRONMENT	DURATION	SHOCK (NUMBERS) G-LEVEL PER MSECS	VIBRA- TION		TEMP °C (PROBABLE HOURS)	ALTITUDE 1000 FEET	HUMIDITY (%T PROBABLE PERCENT)	ACCELERATION	SALT SPRAY IN. OF NOT ROLLED STEEL DISSIPATED/ YEAR	FUNGUS		ACOUSTICS		RAIN* IN/HR (PER YEAR)	SNOW* IN/HR (PER YEAR)	SAND MPH WIND	DUST IN DIA.	STATUS (SEE NOTE G)
			g	MZ						dB	MZ							
25. PERIODIC INSPECTION, TEST	4 HOURS	(4) SEE NOTES C AND J	-	30 (1) 15 (1)	SEA LEVEL	84 79	-	-	-	-	-	-	-	-	-	-	-	3
26. TRANSFER TO ORGANIZA- TIONAL MAINTENANCE HANDLING**	42 HOURS	(10) 15 g 11- 10" MS (SEE NOTE J)	-	30 (7) 15 (6)	SEA LEVEL	77 73	-	-	-	NO EVIDENCE OF FUNGUS GROWTH	-	-	-	-	-	-	-	1
27. ASSEMBLY/ DISASSEMBLY PREPARATION FOR USE	144 HOURS (SEE NOTE J)	(94) 15 g 11- 10" MS SEE NOTES J AND H	-	45 (10) 5 (5)	SEA LEVEL	77 73	-	-	-	-	-	-	-	-	-	-	-	2
28. ORGANI- ZATIONAL MAINTENANCE HANDLING/ MOVEMENT	14 HOURS	(3) 15 g 11-10" MS (SEE NOTE J)	-	30 (2) 15 (2)	SEA LEVEL	84 79	-	-	-	-	-	-	-	-	-	-	-	2
29. MAINTENANCE- BASE OR CARRIER	300 HOURS	(100) 15 g 11- 10" MS	-	30 (10) 5 (10)	SEA LEVEL	84 73	-	-	-	-	-	-	-	-	-	-	-	5

TABLE LI. Life cycle environments (Continued)

EUROPEAN SCENARIO (NOMINAL)  
US NAVY STORES LOGISTIC LIFE CYCLE  
(NOMINAL PARAMETERS)  
5-YEAR LIFE CYCLE

DURATION AND LEVELS OF EXPOSURE TO ENVIRONMENTS  
APPLICABLE TO AN EXAMPLE

**ASSUMPTIONS**

A) FACTORY IS ASSUMED  
TO BE IN CENTRAL CONUS

B) 1 RT CONUS-AB/AC-CONUS  
2 RT AB/AC-EUROPE DEPOT-AB/AC

C) SEE EXPLANATORY NOTES  
AT END OF TABLE

ENVIRONMENT EVENT	DURATION	SHOCK (NUMBER) G-LEVEL PER MSECS	VIBRA- TION		TEMP °C (PROBABLE HOURS)	ALTITUDE 1000 FEET	HUMIDITY (AT TEMP.) PROBABLE PERCENT	ACCELERATION g	SALT SPRAY ML OF HOT ROLLED STEEL DISSIPATED/ YEAR	FUNGUS	ACOUSTICS		RAIN* IN/HR (PER YEAR)	SNOW* IN/HR (PER YEAR)	SAND MPH WIND	DUST IN DIA	STATUS (SEE NOTE 6)
			g	HZ							dB	HZ					
30. LIFE STORAGE (SEE NOTE K)	10 DAYS	-	-	-	50 (9) - 20 (1)	SEA LEVEL	69 68	-	0.129	-	-	2 (12 MM (10 YR TOTAL)	10 - (24 MM (10 YR TOTAL)	45 MPH 0.001 TO 0.125 INCHES	-	-	2
31. PERIODIC INSPECTION, TEST FOR FLIGHT READINESS	23 HOURS	-	-	-	40 (2) 0 (1)	SEA LEVEL	81 69	-	-	NO VISUAL EVIDENC E OF FUNGUS GROWTH	-	-	-	-	-	-	3, 4
32. APC LOAD HANDLING MOVEMENT	30 HOURS	(4) 15 g 11-10* MS (SEE NOTE J)	-	-	30 (1) 15 (1)	SEA LEVEL	84 79	-	-	-	-	-	-	-	-	-	2
33. PRELOAD TEST	20 HOURS	(13) 15 g 11- 10* MS (SEE NOTE J)	-	-	30 (3) 15 (3)	SEA LEVEL	84 79	-	-	-	-	-	-	-	-	-	4
34. FLIGHT LINE HANDLING MOVEMENT	30 HOURS	(4) 15 g 11-10* MS (SEE NOTE J)	-	-	30 (1) 15 (1)	SEA LEVEL	84 79	-	-	-	-	-	-	-	-	-	2

TABLE LI. Life cycle environments (Continued)

EUROPEAN SCENARIO (NOMINAL)  
 US NAVY STORES LOGISTIC LIFE CYCLE  
 (NOMINAL PARAMETERS)  
 5-YEAR LIFE CYCLE

DURATION AND LEVELS OF EXPOSURE TO ENVIRONMENTS  
 APPLICABLE TO AN EXAMPLE

**ASSUMPTIONS**

A) FACTORY IS ASSUMED  
 TO BE IN CENTRAL CONUS

B) 1 RT CONUS-AB/AC-CONUS  
 2 RT AB/AC-EUROPE DEPOT-AB/AC

C) SEE EXPLANATORY NOTES  
 AT END OF TABLE

ENVIRONMENT	DURATION	SHOCK (NUMBERS)	VIBRA- TION	TEMP	ALTITUDE	HUMIDITY (AT TEMP.)	ACCELERATION	PL. OF HOT ROLLED	SALT SPRAY	FUNGUS	ACOUSTICS	RAIN*	SNOW*	SAND	DUST	STATUS
		g-LEVEL PER MSECS	g HZ	°C (PROBABLE HOURS)	1000 FEET	PERCENT		STEEL DISSIPATED/ YEAR			dB HZ	IN/HR (PER YEAR)	IN/HR (PER YEAR)	MPH WIND	IN DIA.	(SEE NOTE 4)
35. FLIGHT LINE STORAGE (SEE NOTE K)	7 DAYS (SEE NOTE K)	-	-	50 (7) - 20 (1)	SEA LEVEL	69 48	-	0.125	-	-	120 dB 20 TO 15,000*	2 (12 MIN/ ANY 24 HRS NOMI- NAL)	10 (12 MIN/ ANY 24 HRS NOMI- NAL)	49 MPH 0.001 TO 0.125 INCHES	-	2
36. AIRCRAFT UPLOAD (SEE NOTE D)	15 HOURS (SEE NOTE D)	(8) 15 g 11-18* MS	-	40 (1) 0 (1)	SEA LEVEL	81 69	-	-	-	-	-	-	-	-	-	2
37. AIRCRAFT POST LOAD TEST	15 HOURS	-	-	40 (1) 0 (1)	SEA LEVEL	81 69	-	-	-	-	-	-	-	-	-	3
38. AIRCRAFT READY ALERT (SEE NOTE K)	120 HOURS (SEE NOTE K)	-	-	40 (14) 0 (2)	SEA LEVEL	81 69	-	-	-	-	-	2 (12 MIN/ ANY 24 HRS NOMI- NAL)	10 (12 MIN/ ANY 24 HRS NOMI- NAL)	49 MPH 0.001 TO 0.125 INCHES	-	2
39. AIRCRAFT TAKEOFF	15 TIMES	(18)*** 0.4 18- 25* MS	-	50 (1) - 35 (1)	SEA LEVEL	69 31	-	-	-	-	140 dB 20 TO 15,000*	-	-	-	-	2

**TABLE LI. Life cycle environments (Continued)**

EUROPEAN SCENARIO (NOMINAL)  
 US NAVY STORES LOGISTIC LIFE CYCLE  
 (NOMINAL PARAMETERS)  
 5-YEAR LIFE CYCLE

DURATION AND LEVELS OF EXPOSURE TO ENVIRONMENTS  
 APPLICABLE TO AN EXAMPLE

**ASSUMPTIONS**

A) FACTORY IS ASSUMED  
 TO BE IN CENTRAL CONUS

B) 1 RT CONUS-AB/AC-CONUS  
 2 RT AB/AC-EUROPE DEPOT-AB/AC

C) SEE EXPLANATORY NOTES  
 AT END OF TABLE

ENVIRONMENT	DURATION	SHOCK (NUMBERS) G-LEVEL PER HRS	VIBRATION G HZ	TEMP °C (PROBABLE HOURS)	ALTITUDE 1000 FEET	HUMIDITY (AT TEMP.) PROBABLE PERCENT	ACCELERATION	SALT SPRAY IN. OF HOT ROLLED STEEL DISSIPATED/ YEAR	FUNGUS	ACOUSTICS dB HZ	RAIN IN/HR (PER YEAR)	SNOW IN/HR (PER YEAR)	SAND MPH WIND	DUST IN DIA.	STATUS (SEE NOTE 6)
40. CAPTIVE FLIGHT	22.30 HOURS	SEE NOTE E	SEE NOTE F	SEE NOTE G	SEE NOTE H	-	-	-	-	14.5 dB 20 TO 15,000*	2 (12 HRW ANT 24 HRS NOMINAL)	10 (12 HRW ANT 24 HRS NOMINAL)	-	-	5
41. AIRCRAFT LANDINGS AFTER AN EXAMPLE	11 TIMES	(1) 9 g 10-25 MS	-	90 (1) 25 (1)	SEA LEVEL	60 31	-	-	-	-	-	-	-	-	2
42. AIRCRAFT DOWNGO	1 HOUR SEE (NOTE D)	(2) SEE NOTE H	-	60 (1) 0 (1)	SEA LEVEL	81 69	-	-	-	-	2 (12 HRW ANT 24 HRS NOMINAL)	10 (12 HRW ANT 24 HRS NOMINAL)	-	-	2
43. LAUNCH (AVERAGE FREIGHT TIME PER LAUNCH)	4 TIMES (165 SECONDS)	(4) 90 g 6 MS	SEE NOTE I	EXTERIOR SURFACE - 55 TO 400°C (APPROX)	1,000	48 (55 DEG AT ALTITUDE)	31.0, -2.0 (LONGITUDINAL)* +12.0, -12.0 (RADIAL)	-	-	14.5 dB (+/-) 40 TO 15,000*	-	-	-	-	6

**TABLE LI. Life cycle environments (Continued)**

EUROPEAN SCENARIO (NOMINAL)  
 US NAVY STORES LOGISTIC LIFE CYCLE  
 (NOMINAL PARAMETERS)  
 5-YEAR LIFE CYCLE

DURATION AND LEVELS OF EXPOSURE TO ENVIRONMENT'S  
 APPLICABLE TO AN EXAMPLE

**ASSUMPTIONS**

A) FACTORY IS ASSUMED  
 TO BE IN CENTRAL CONUS

B) 1 RT CONUS-AB/AC-CONUS  
 2 RT AB/AC-EUROPE DEPOT-AB/AC

C) SEE EXPLANATORY NOTES  
 AT END OF TABLE

ENVIRONMENT	DURATION	SHOCK (G-LEVEL PER PERIOD)	VIBRA- TION	TEMP °C (PROBABLE HOURS)	ALTITUDE 1000 FEET	HUMIDITY (AT TEMP.) PROBABLE PERCENT	ACCELERATION G	PL OF NOT RULLED STEEL DISAPATED YEAR	FUNGUS		RASH (PER YEAR)	SNOV (PER YEAR)	SAND DUST (PER YEAR)	STATUS (SEE NOTE 9)
									M1	M2				
44. FREE FLIGHT BOOST TOTAL (SAFE AND ARM) TOTAL (OPT TOTAL FLIGHT TIME)	666.00 SECONDS (24.48 HOURS) (77.94)	(4) 30g 10MS	SEE NOTE 8	AIR TEMP (FRESH) -50 TO 100°C (APPROX)	000	00 (17°C AT ALTITUDE)	*10 0 - 1.0 (LUMINITY- NORMAL)* 4.5 - 7.0 (RADIAL)		50 00 (10-3) 00) TO 10 10,000"	2 (100 PER YEAR)	10- (14 SECS)		1	
45. FREE FLIGHT TOTAL SUBMANCE AND CONTROL (PCT TOTAL FLIGHT TIME)	644.00 SECONDS (18.17 HOURS)		SEE NOTE 8	AIR TEMP (FRESH) -50 TO 100°C (APPROX)	.030	00 (17°C AT ALTITUDE)	*10 0 - 1.0 (LUMINITY- NORMAL)* 4.5 - 7.0 (RADIAL)		50 00 (10-3) 00) TO 10 10,000"				1	
46. FREE FLIGHT ONLY TOTAL (OPT TOTAL FLIGHT TIME)	672.00 SECONDS (18.67 HOURS)		SEE NOTE 8	AIR TEMP (FRESH) -50 TO 100°C (APPROX)	.043	00 (17°C AT ALTITUDE)	*10 0 - 1.0 (LUMINITY- NORMAL)* 4.5 - 7.0 (RADIAL)		50 00 (10-3) 00) TO 10 10,000"				1	
47. FREE-VL1 TOTAL TIME FROM IMPACT, AND (PCT TOTAL FLIGHT TIME)	639.20 SECONDS (17.75 HOURS)		SEE NOTE 8	AIR TEMP (FRESH) -50 TO 100°C (APPROX)	0.000	03 (17°C AT ALTITUDE)	*10 0 - 1.0 (LUMINITY- NORMAL)* 4.5 - 7.0 (RADIAL)		50 00 (10-3) 00) TO 10 10,000"				1	

**TABLE LI. Life cycle environments (Continued)**  
**AN EXAMPLE**  
**NOTES TO ACCOMPANY**  
**U.S. NAVY STORES LOGISTIC CYCLE**  
**DURATION AND LEVELS OF EXPOSURE**  
**TO ENVIRONMENTS**  
**FOR A LIFE OF 5-YEARS (43800 HOURS)**

**GENERAL -- NEGLIGIBLE RESPONSE CONDITIONS ARE INDICATED BY A DASH. STORE STATUS DEFINITION SHOWN IN ACCOMPANYING CHART TO NOTES (STORES LOGISTICS STATUS CONDITION. NOTE 0)**

- AB/AC ISAIRBASE OR AIRCRAFT CARRIER

- \* - ASSUMED ENVIRONMENTAL LEVEL
- \*\* - RE-ENTRY POINT IN LOGISTIC CYCLE FOR REUSABLE STORE (EVENT 26)
- \*\*\* - ASSUME EACH TAKEOFF ISA CATAPULT, EACH LANDING AN ARRESTMENT

**A - 25g FOR 11 TO 18 MILLISECONDS (LONGITUDINAL)**  
**1 FOOT DROP TO CONCRETE (CORNER DROPS)**  
**(ASSUME MAXIMUM OF 1 OCCURRENCE PER 6 EVENTS/ 5 YEARS)**  
**3.5g FOR 25 TO 50 MILLISECONDS (VERTICAL AND LATERAL)**  
**(ASSUMED 4 OCCURRENCES PER EVENT/S YEARS)**

**B - 1g FROM 1Hz TO 10Hz**  
**2g FROM 10Hz TO 20Hz**  
**3g FROM 20Hz TO 60Hz**  
**5g FROM 60Hz TO 500Hz**

**C - 25g FOR 11 TO 18 MILLISECONDS (EACH AXIS)**  
**1 FOOT DROP TO CONCRETE (CORNER DROPS)**  
**(ASSUME MAXIMUM OF 1 OCCURRENCE PER 6 EVENTS / 5 YEARS)**

**D - ASSUMED NOMINAL LIFE LOADING/UNLOADING EACH TWO FLIGHTS**  
**(2 HOURS LOADING AND 1.5 HOURS UNLOADING) AND NUMBER OF FLIGHTS**  
**(AVERAGE 1.50 HOURS/FLIGHT)**

<u>MISSILE NAME</u>	<u>APPROXIMATE NO. LOADS/UNLOADS</u>	<u>FLT. HOURS</u>	<u>NOMINAL TOTAL LD/UNLD HOURS</u>
AN EXAMPLE	7	22.50	23

**E - THE APPLICABLE MISSILE BUFFET/SHOCK LEVELS (COMBAT MISSIONS) ARE 2 g<sub>rms</sub>**  
**(LONGITUDINAL). 4.5 g<sub>rms</sub> (VERTICAL AND LATERAL) 10Hz TO 60 Hz (ASSUMED)**

**TABLE LI. Life cycle environments (Continued)  
 AN EXAMPLE  
 NOTES TO ACCOMPANY  
 U.S. NAVY STORES LOGISTIC CYCLE  
 DURATION AND LEVELS OF EXPOSURE  
 TO ENVIRONMENTS  
 FOR A LIFE OF 5-YEARS (43800 HOURS)  
 (CONTINUED).**

F - SEE APPLICABLE MISSION PROFILE(S) FOR CAPTIVE CARRIAGE FOR  
 A-6            P-3  
 F/QF-4        DC-130  
 F/A-18

**NOMINAL CAPTIVE FLIGHT VIBRATION LEVELS (ASSUMED)**

(FOR SPECIFIC STORE FLIGHT HOURS, SEE INDIVIDUAL STORE DURATION AND LEVELS OF EXPOSURE TO ENVIRONMENTS.)

0.024 g<sup>2</sup>/Hz, 20 TO 250 Hz  
 0.004 g<sup>2</sup>/Hz, 250 TO 1500 Hz  
 0.012 g<sup>2</sup>/Hz, 1500 TO 2000 Hz (MEAN CAPTIVE FLIGHT)

0.096 g<sup>2</sup>/Hz, 20 TO 250 Hz  
 0.016 g<sup>2</sup>/Hz, 250 TO 1500 Hz  
 0.048 g<sup>2</sup>/Hz, 1500 TO 2000 Hz (INTERMITTENT MAXIMUM)

**BUFFET LEVELS (ASSUMED AT 1 PERCENT OF FLIGHT TIME)**

10 Hz - 30Hz  
 0.1 g<sup>2</sup>/Hz  
 30 HZ - 200 Hz  
 - 6 dB/OCTAVE

G - SEE APPLICABLE MACH NUMBER VS. ALTITUDE FOR RECOVERY TEMPERATURE AND MISSION PROFILES OF APPLICABLE CARRIER AIRCRAFT

A-6            P-3  
 F/QF-4        DC-130  
 F/A-18

H - 15g, 11 TO 18 MILLISECOND (ASSUMED - 4 OCCURRENCES / 10 UNLOADINGS)  
 18 IN. DROP TO CONCRETE (EDGEWISE DROP)  
 (ASSUME 1 OCCURRENCE PER 10 UNLOADINGS)

I - ASSUME 12 HOURS EACH FOR STORE ASSEMBLY/DISASSEMBLY AND MAINTENANCE.

<u>MISSILE NAME</u>	<u>NOMINAL ANNUAL FREQUENCY ASSUMED</u>	<u>MAINTENANCE, INSPECT, TEST, AND ASSEMBLY/DISASSEMBLY (HOURS)</u>
AN EXAMPLE	6	584

J - ASSUME 1 SHOCK EACH 1 HOUR AND 30 MINUTES IN DEPOT AND ASSEMBLY/DISASSEMBLY AND EACH 4 HOURS HANDLING TRANSPORT AND TEST

**TABLE LI. Life cycle environments (Continued)**

AN EXAMPLE

NOTES TO ACCOMPANY

U.S. NAVY STORES LOGISTIC CYCLE  
 DURATION AND LEVELS OF EXPOSURE  
 TO ENVIRONMENTS  
 FOR A LIFE OF 5-YEARS (43800 HOURS)  
 (CONTINUED).

K - ASSUME 1 DAY FLIGHT LINE STORAGE PER 4 FLIGHTS, READY/ALERT 4 HOURS PER FLIGHT, AND LIVE STORAGE AT ONE DAY PER LOAD/UNLOAD. AS FOLLOWS

MISSILE NAME	LIVE STORAGE (DAYS)	FLIGHT LINE STORAGE (DAYS)	READY ALERT (HOURS)
AN EXAMPLE	10	7	120

L - ASSUMING DELIVERY, EMPLOYMENT, AND REPAIR/REWORK LIFE FREQUENCY. THEN THE REMAINING PORTION OF LIFE SPENT IN DEAD STORAGE.

MISSILE NAME	RECYCLE CONUS FACTORY/DEPOT IN DAYS (PERCENT)	RECYCLE TO EUR. DEPOT IN DAYS (PERCENT)	TOTAL DURATION IN ACTIVE STATUS IN DAYS (PERCENT)	TOTAL LIFE DEAD STORAGE IN DAYS (PERCENT)
AN EXAMPLE	265 (14.52)	145 (7.95)	52 (2.85)	1363 (74.68)

M - SEE INDIVIDUAL STORE LISTING FOR QUANTITIES.

N - VIBRATION (RANDOM) ACCELERATION SPECTRAL DENSITY LEVELS FOR ALL STORES IN FREE FLIGHT (ASSUMED)

LAUNCH	NOMINAL RANDOM VIBRATION (g <sup>2</sup> /Hz)		FREQUENCY Hz
	BOOST	FREE FLIGHT	
0.024	0.01	0.006	20-250
0.135	0.08	0.025	250-1500
0.012	0.02	0.003	1500-2000

APPROXIMATE MAXIMUM FREE-FLIGHT EVENT TIMES (IN SECONDS)

MISSILE NAME	SAFE AND ARM	FREE-FLIGHT	FUSING
AN EXAMPLE	9.10	165.00	FREE-FLIGHT FUSING ASSUMED AT 5.20 SEC FROM IMPACT

TABLE LI. Life cycle environments. (Continued)

AN EXAMPLE  
 NOTES TO ACCOMPANY  
 U.S. NAVY STORES LOGISTIC CYCLE  
 DURATION AND LEVELS OF EXPOSURE  
 TO ENVIRONMENTS  
 FOR A LIFE OF 5-YEARS (43800 HOURS)  
 (CONTINUED)

0- STORES LOGISTICS STATUS CONDITION

EVENT NUMBER	STATUS CONDITION*
1	1
2	1
3	1
4	1
5	1
6	1
7	3
8	6
9	1
10	1
11	1
12	1
13	1
14	1
15	1
16	1
17	1
18	1
19	1
20	1
21	1, 3, 6
22	1
23	1
24	1

EVENT NUMBER	STATUS CONDITION*
25	3
26	
27	2
28	2
29	5
30	2
31	3, 4
32	2
33	4
34	2
35	2
36	2
37	5
38	2
39	2
40	5
41	2
42	2
43	6
44	6
45	6
46	6
47	6
48	-

\* STATUS CONDITION

1. INOPERATIVE IN CONTAINER
2. INOPERATIVE OUT OF CONTAINER
3. VISUAL, DESICANT, HUMIDITY (INOPERATIVE IN CONTAINER)
4. INOPERATIVE - CONTINUITY/BIT (IN/OUT CONTAINER)
5. PARTIALLY OPERATIVE
6. FULLY OPERATIVE

**TABLE LII. Assumed typical attack mission profiles.**

**HIGH-LOW-HIGH MISSION (2 HOURS, 10 MINUTES)**

EVENT NUMBER	EVENT TIME (MINUTES)	ALTITUDE (FEET)	MACH NUMBER	q (STANDARD DAY)	TR(°C) (STD DAY)	TR(°C) (HOT DAY) 10% DAY	TR(°C) (COLD DAY) 10% DAY	REMARKS
0	-15	0.0	0.0	0	15	45	-54	GROUND RUNUP/TAXI
1	15	1,000	0.673	646	36	68	-35	TAKEOFF/CLIMB/RUN-OUT
2	25	30,000	0.582	149	-31	1	-53	CLIMB/CRUISE
3	15	8,000	0.672	496	21	48	-13	DESCEND/ON-STATION
4	2	3,000	0.832	918	44	77	-23	DIVE/ATTACK
5	4	8,000	0.752	622	27	55	-8	CLIMB/LOITER
6	2	3,000	0.832	918	44	77	-23	DIVE/ATTACK
7	2	8,000	0.752	622	27	55	-8	CLIMB/RECONNOITER
8	2	3,000	0.832	918	44	77	-23	DIVE/ATTACK
9	7	5,000	0.668	549	27	57	-23	CLIMB/DEPART STATION
10	23	47,000	0.619	76	-42	-14	-55	CLIMB/CRUISE (BACK)
11	23	4,000	0.584	436	24	55	-33	DESCEND/CRUISE/LANDING
12	10	0.0	0.0	0	15	45	-54	TAXI/PARK

**HIGH-MEDIUM-LOW MISSION (2 HOURS, 10 MINUTES)**

EVENT NUMBER	EVENT TIME (MINUTES)	ALTITUDE (FEET)	MACH NUMBER	q (STANDARD DAY)	TR(°C) (STD DAY)	TR(°C) (HOT DAY) 10% DAY	TR(°C) (COLD DAY) 10% DAY	REMARKS
0	-15	0.0	0.0	0	15	45	-54	GROUND RUNUP/TAXI
1	7	5,000	0.45	249	16	43	-33	TAKEOFF/CLIMB/LOW CRUISE
2	18	30,000	0.65	186	30	58	-8	CLIMB/ON-STATION
3	4	10,000	0.85	736	4	21	-28	DESCEND/HIGH ATTACK
4	6	20,000	0.80	436	36	64	-3	CLIMB/LOITER
5	2	10,000	0.92	862	-3	13	-34	DESCEND/HIGH ATTACK
6	8	20,000	0.70	334	-16	42	-21	CLIMB/LOITER
7	16	10,000	0.65	430	38	71	-33	DESCEND/HIGH ATTACK
8	13	1,000	0.70	700	26	56	-30	DESCEND/ON-STATION
9	3	5,000	0.65	520	58	93	-19	CLIMB/INITIAL RUN-IN
10	2	500	0.93	1,263	43	76	-26	DIVE/ATTACK
11	4	2,000	0.80	881	51	85	-25	CLIMB/RECONNOITER
12	2	500	0.85	1,055	26	58	-40	DIVE/ATTACK
13	6	2,000	0.55	417	47	81	-26	CLIMB/RECONNOITER
14	3	1,000	0.82	960	16	42	-21	DIVE/ATTACK
15	19	10,000	0.65	430	24	55	-39	CLIMB/CRUISE (BACK)
16	7	3,000	0.55	401	15	45	-54	DESCEND/CRUISE/LANDING
17	10	0.0	0.0	0				TAXI/PARK

<sup>1</sup> OR MAXIMUM AS AVAILABLE (NOT LESS THAN 71°C)

T<sub>R</sub> - RECOVERY TEMPERATURE

$$T_R (^{\circ}R) = T_{\infty} (^{\circ}R) [1 + 0.178 (\text{MACH No.})^2]$$

MIL-HDBK-781

TABLE LIII. A method for calculating test profile times for a specific number of test cycles.

	① TOTAL SCHEDULED LIFE-CYCLE OCCURRENCES ALLOCATED FOR TEST CYCLE EVENTS (PERCENTAGE DISTRIBUTED)	② ALLOCATED TIME IN EACH TEST CYCLE PER OCCURRENCE (DISTRIBUTED)	③ TOTAL NUMBER OF EVENT OCCURRENCES DURING TEST CYCLE	④ TOTAL TIME SPENT IN EACH EVENT PER TEST CYCLE (HOURS)	⑤ (A) (B) ADJUSTED TIME IN EACH EVENT FOR TEST ITEM FOR 10 CYCLE TEST AND OF 2.03 (C) (2) X 2.03	⑥ TOTAL TEST ITEM HOURS SPENT IN EACH EVENT TOTAL TEST (3) X (5) X 10
LIFE-CYCLE EVENT FIGURES 130 AND 131)						
1A. RELIABILITY-DEFINED TEST EVENTS FOR AIR-FIRED MISSILES AND ASSEMBLED EXTERNAL STORES FROM OPERATIONAL LIFE-CYCLE ENVIRONMENTAL REQUIREMENTS (SEE TABLE LI)	40 (50) (50)	25 MIN (12.5 MIN) (12.5 MIN)	7	2.917	50 MIN 46 SEC (25 MIN 23 SEC) (25 MIN 23 SEC)	59.21  (OCCURRENCE 70 TIMES)
1B. GROUND PRE/POST FLIGHT  NONOPERATING  OPERATING (SEE FIGURE 130)	40 (60) (40)	2 hours  (24 MISSIONS) (16 MISSIONS)	6	12	4 HRS 4 MIN (36 MISSIONS) (24 MISSIONS)	244.0  (OCCURRENCE 60 TIMES)
1C. CAPTIVE-FLIGHT MISSIONS  HIGH-MEDIUM-LOW  HIGH-LOW-HIGH (SEE FIGURE 130)	4 (D) (100)	3 MIN (4 MISSIONS)	6	0.3	6 MIN 6 SEC (6 MISSIONS)	6.1  (OCCURRENCE 60 TIMES)
1D. FREE-FLIGHT MISSION  LOW-LOW (SEE FIGURE 131)	4 <sup>1/</sup> 4 <sup>2/</sup>	6 MINS (CF) 6 MINS (FF)	4 <sup>1/</sup> 4 <sup>2/</sup>	0.4 0.4	12 MIN 11 SEC 12 MIN 11 SEC	16.24  (OCCURRENCE 80 TIMES)
TOTALS FOR EACH TEST ITEM	(A) (B)			16.017	32.555	>325.55 (A) (B)

<sup>1</sup> Captive flight  
<sup>2</sup> Free flight

TABLE LIII. A method for calculating test profile times for a specific number of test cycles.  
(Continued)

- A** A MINIMUM OF FOUR TEST ITEMS AT 325 HOURS OF TESTING PER TEST ITEM (THAT IS, NOT LESS THAN 1300 HOURS OF TOTAL TESTING IS RECOMMENDED).
- B** THE TEST CYCLE/TIME FACTOR IS DETERMINED BY DIVIDING THE TOTAL TIME ALLOCATED PER TEST ITEM BY THE TOTAL TIME PER TEST CYCLE ( $\geq 325/16.017 = 20.291$ , OR 2.03 TIME ADJUSTMENT FACTOR FOR EACH TEST EVENT FOR 10 CYCLES).
- C** USE TO EXPAND THE PROFILE TIME SCALE OF FIGURES 143 THROUGH 148 AND THE CORRESPONDING TABLES (THAT IS, 2.03 TIMES EACH MANEUVER DURATION FOR TESTING IN EXAMPLE PROFILES).
- D** ONE SIMULATED LAUNCH PER TEST ITEM (ASSUMED 325 HOURS CAPTIVE FLIGHT / LAUNCH)
- E** SEE 5.9.3.1 FOR SCHEDULING SHORT-TERM AND LONG-TERM ELECTRICAL INTERRUPTS.

**MIL-HDBK-781**

**TABLE LIV. Attack aircraft captive-carriage mission profile data (example).**

HIGH-LOW-HIGH-MISSION						HIGH-MEDIUM-LOW-MISSION						
i	TIME I/ (MIN- UTES)	$\sum T$	q (lbs/ft <sup>2</sup> )	$g_{rms}$ (OVL) (95th PERCENTILE, 50 PERCENT CONFIDENCE)	BUFFET	SPECTRUM FACTOR ( $g_{rms(1)}$ ) <sup>2</sup>	TIME I/ (MIN- UTES)	$\sum T$	q (lbs/ft <sup>2</sup> )	$g_{rms}$ (OVL) (95th PERCENTILE, 50 PERCENT CONFIDENCE)	BUFFET	SPECTRUM FACTOR ( $g_{rms(2)}$ ) <sup>2</sup>
1	0-15	15	646	3.349		11.215	0-7	7	249	1.291		(1.690)3/
2	25	40	149	0.772		(1.690)3/	18	25	186	0.964		(1.690)3/
3	15	55	496	2.571		6.612	4	29	736	3.815	2/	14.558
4	2	57	918	4.759	2/	22.648	6	35	436	2.260		5.109
5	4	61	622	3.224		10.397	2	37	862	4.469	2/	19.969
6	2	63	918	4.759	2/	22.648	8	45	334	1.731		2.998
7	2	65	622	3.224		10.397	16	61	430	2.229	2/	4.969
8	2	67	918	4.759	2/	22.648	13	74	700	3.629		13.168
9	7	74	549	2.846		8.100	3	77	520	2.696		7.267
10	23	97	76	0.394		(1.690)3/	2	79	1263	6.547	2/	42.869
11	23	97	436	2.260		5.109	4	83	881	4.567		20.859
12	10	107	0	0			2	85	1055	5.469	2/	29.912
	130						6	91	417	2.162		4.673
							3	94	960	4.977	2/	24.767
							19	113	430	2.229		4.969
							7	120	401	2.079		4.321
								0	0			
								130				

95th percentile, 50 percent confidence,  $g_{rms}$  (OVL) = 3.639316  
 (K = 1.645)

$$\log_{10}(g_{rms}(OVL))_i = (\log_{10}(g_{rms}) - \log_{10}(q) + \log_{10}(q))_i$$

$$\log_{10}(g_{rms}(OVL))_i = [\log_{10}(q) - 2.28533]$$

$$g_{rms}(OVL)_i = 10^{\log_{10}(q) - 2.28533}$$

1 See TABLE 5LIII for time adjustment factor and TABLE 5LVII for test timeline.

2 Buffet (duration 6 seconds each, PSD spectrum of FIGURE 149).

3 Minimum  $g_{rms}(OVL) = 1.3$  for  $q \leq 250$  lbs/ft<sup>2</sup> and Mach  $\leq 0.45$

TABLE LV. Assumed free-flight mission profile for example store (low-low), vibration.

EVENT NUMBER	EVENT TIME (SEC)	$\sum$ TIME (SEC)	$V$ q (lbs/ft <sup>2</sup> )	$g_{rms}$ (OVL) FREE-FLIGHT TURBULENCE ADJUSTMENT FACTOR	$g_{rms}$ (OVL) <sup>2/</sup> VERSUS q FROM CAPTIVE-FLIGHT MEASUREMENTS	$V$ ADJUSTED FREE-FLIGHT FINAL $g_{rms}$ ((OVL) LEVEL)	$W$ <sup>3/</sup> ( $g_{rms}$ ) FACTOR ON PSD SPECTRA
0	0	0	500	0.4375	2.59	1.13	1.28
1	30	30	9250	0.4375	47.95	20.98 <sup>2/</sup>	440.16
2	90	120	9250	0.4375	47.95	20.98 <sup>2/</sup>	440.16
3	18	138	308	0.4375	1.6	0.7	0.49
4	12	150	211	0.4375	1.33 <sup>2/</sup>	0.57	0.32
5	18	168	48	0.4375	1.33 <sup>2/</sup>	0.57	0.32
6	12	180	0	0.4375	1.33 <sup>2/</sup>	0.57	0.32

SEE GENERAL FREE-FLIGHT NOTE (NEXT PAGE)

<sup>1/</sup> ACTUAL VALUE OF DYNAMIC PRESSURE, OF EVENTS 1 AND 2 ARE, (q) = 9250 lbs/ft<sup>2</sup> FINAL VALUE OF ADJUSTED  $g_{rms}$  (OVL) IS EMPIRICALLY-LIMITED TO A  $g_{rms}$  (OVL) MAXIMUM VALUE CALCULATED FOR A q = 5930 lbs/ft<sup>2</sup> AND MACH = 2.0 AT SEA LEVEL FOR A SINGLE STORE (THAT IS, FIGURE 132,  $g_{rms}$  (OVL) LIMIT FOR SINGLE STORE = 30.74).

<sup>2/</sup> MAXIMUM PREDICTED CAPTIVE-FLIGHT ENVIRONMENT, 95TH PERCENTILE, 50 PERCENT CONFIDENCE LEVEL (BASED ON A ONE-SIDE TOLERANCE LIMIT), (SEE FIGURE 132, SINGLE STORE)

<sup>3/</sup> MINIMUM  $g_{rms}$  (OVL) FOR q ≤ 250 lbs/ft<sup>2</sup> MACH ≤ 0.45 (SEE TABLE XLVIII).

<sup>4/</sup> MINIMUM TESTING  $W_0$  (PSD) LEVEL SHALL BE 0.001 g<sup>2</sup>/Hz.

<sup>5/</sup> FOR THIS EXAMPLE, ONE SIMULATED LAUNCH WILL BE IMPOSED ON EACH TEST ITEM, CONSISTING OF 10 TEST CYCLES.

**TABLE LV. Assumed free-flight mission profile for example store (low-low), vibration  
 (Continued)**

**GENERAL FREE-FLIGHT NOTE**

Based on the approximate relationship of a constant boundary layer pressure ratio with flight dynamic pressures and aerodynamically-induced random vibration (Reference 23, pages 21 and 58) and the relationship of  $W_0 = K(q)^2$  (the spectrum relationship between equipment locations and surface discontinuities), the free-flight (g<sub>rms</sub>)<sup>2</sup> acceleration, (hence, the level relationship for the PSD versus frequency) is assumed to vary in direct proportion to the jet aircraft smooth surfaces flow and discontinuity surfaces flow coefficients.

<u>K (smooth)</u>	<u>K (free-flight)</u>
K (discontinuity)	K (captive flight)

or,  $[W_0]$   
 free flight =  $\frac{K(\text{smooth})(W_0)_{\text{Captive}}}{K(\text{discontinuity})} = (0.1914) [W_0]$  high speed captive PSD

where:

$$q(M = 0.45) \leq q \leq q(M = 2.0)$$

and,

$$W_1 = W_0 - 3\text{dB}$$

These limits are based on Reference 23, pages 21 through 25 and the initial assumptions of the  $M \leq 0.45$  and  $q \leq 250 \text{ lbs/ft}^2$  the minimum level of  $W_0$  for testing. then,

$$[g_{\text{rms}}(q, W_0)]_{\text{free flight}} = (0.1914)^2 [g_{\text{rms}}(q, W_0)]_{\text{high speed captive data}}$$

or,

$$[g_{\text{rms}}(q, W_0)]_{\text{free flight}} = (0.4375) [g_{\text{rms}}(q, W_0)]_{\text{high speed captive data}}$$

where,

the  $g_{\text{rms}}$  relationship is shown in FIGURES 132 through 134  
 $q(\text{MIN}) \leq q \leq 5930 \text{ lbs/ft}^2$

$q(\text{MIN})$  is listed in TABLE XLVIII for FIGURES 132 thru 134

MACH (MAX) = 2.0

$V_\infty = 1116.89 \text{ ft/second}$ ; (for Mach = 1.0 at sea level)

$q(\text{MAX} = 5930 \text{ lbs/ft}^2)$  (for Mach = 2.0 at sea level)

MIL-HDBK-781

TABLE LVI. Assumed free-flight mission profile for example store (low-low) standard day.

EVENT NUMBER	EVENT TIME (SECONDS)	ALTITUDE (FT)	MACH NUMBER	$q$ <sup>1/</sup> LBS/FT <sup>2</sup> (Standard Day)	°C CHANGE IN RECOVERY TEMPERATURE (COMPARTMENT NUMBER)	REMARKS
0	0	10,000	0.65	500	-18 (1,2) <sup>2/</sup>	T <sub>R</sub> AT LAUNCH = 15°C LAUNCH FROM AIR CRAFT MINIMUM ALTITUDE. MAXIMUM SPEED BURN-OUT  PULL-UP TO RECOVERY ALTITUDE MAXIMUM COMPARTMENTS TEMPERATURE ELECTRICAL SIGNAL CHECK SPLASH DOWN T <sub>R</sub> = 15°C
1	30	50	2.5	9250 1/	-9 (1)	
2	120	50	2.5	9250 1/	-12 (2)	
3	138	5000	0.5	308	60 (1)	
4	150	3200	0.4	211	16 (2)	
5	168	200	0.18	48	93 (1)	
6	180	0	0	0	38 (2)	
					132 (1)	
					71 (2)	
					10 (1)	
					5 (2)	
					-18 (1,2)	
					(AMBIENT)	

<sup>1</sup> LIMIT VALUE OF ADJUSTED FREE-FLIGHT  $g_{max}(OVL)$  TO  $\leq 5930 \text{ lbs/ft}^2 = q(\text{MAX}) \leq \text{MACH NUMBER } 2.0$ , SEE FIGURE 147 AND TABLE LV

<sup>2</sup> COMPARTMENT NUMBER (1) IS FORWARD RANDOM SECTION, COMPARTMENT NUMBER (2) IS GUIDANCE AND CONTROL AVIONICS SECTION

MIL-HDBK-781

TABLE LVII. Composite test cycle profile example timeline - testing profiles for the reliability captive-flight test cycle 1/2

ITEM NO	TEST CYCLE EVENT AND CONDITION DESCRIPTION	TOTAL TEST CYCLE		HORIZONTAL TEST CYCLE		VERTICAL TEST CYCLE		ENVIRONMENTAL STRESS PHASING		VIBRATION PROFILE		START TIME OF EVENT (MMS-TIME (S))	DURATION OF EVENT (MMS-TIME (S))
		TEST CYCLE	ACCUMULATED CLOCK TIME	TEST CYCLE	ACCUMULATED CLOCK TIME	TEST CYCLE	ACCUMULATED CLOCK TIME	TEST CYCLE	ACCUMULATED CLOCK TIME	SPECTRUM NO.	VIBRATION FACTOR (PKS/INU)		
1-A	APPLICABLE TO CYCLE MOD. ITREU	0-25-23	0-25-23	0-25-23	0-25-23	0-25-23	0-25-23						
2-B	COLD DAY, GROUND OPERATION	0-25-23	0-25-23	0-25-23	0-25-23	0-25-23	0-25-23						
3-C	MISSESHIP PROFILE - COLD DAY	0-25-23	0-25-23	0-25-23	0-25-23	0-25-23	0-25-23						
4-D	TRANSITION	0-25-23	0-25-23	0-25-23	0-25-23	0-25-23	0-25-23						
5-E	AP-BERTH DAY, GROUND OPERATION	0-25-23	0-25-23	0-25-23	0-25-23	0-25-23	0-25-23						
6-F	MISSESHIP PROFILE - AP-BERTH DAY	0-25-23	0-25-23	0-25-23	0-25-23	0-25-23	0-25-23						
7-G	TRANSITION	0-25-23	0-25-23	0-25-23	0-25-23	0-25-23	0-25-23						
8-H	HOT DAY, GROUND OPERATION	0-25-23	0-25-23	0-25-23	0-25-23	0-25-23	0-25-23						
9-I	MISSESHIP PROFILE - HOT DAY	0-25-23	0-25-23	0-25-23	0-25-23	0-25-23	0-25-23						
10-J	TRANSITION	0-25-23	0-25-23	0-25-23	0-25-23	0-25-23	0-25-23						
11-K	AP-BERTH DAY, GROUND OPERATION	0-25-23	0-25-23	0-25-23	0-25-23	0-25-23	0-25-23						
12-L	MISSESHIP PROFILE - AP-BERTH DAY	0-25-23	0-25-23	0-25-23	0-25-23	0-25-23	0-25-23						

1/ Use with TABLE LVIII. High-medium-low mission; TABLE LIX. High-low-high mission, and TABLE 6LX Free-flight low-

low

2/ This table is applicable to all test cycles

3/ Sea level

MIL-HDBK-781

TABLE LVII. Composite test cycle profile example timeline - testing profiles for the reliability captive-flight test cycle <sup>1/2/</sup> (Cont)

<sup>1/</sup> Use with TABLE LVIII. High-medium-low mission: TABLE LIX, High-low-high mission; and TABLE LX. Free-flight low-  
low  
<sup>2/</sup> This table is applicable to all test cycles  
<sup>3/</sup> Sea level

MIL-HDBK-781

TABLE LVII. Composite test cycle profile example timeline - testing profiles for the reliability captive-flight test cycle 1/2 (Cont)

ITEM NO.	CYCLE PHASE NO	TEST SEGMENT, SEQUENCE DESCRIPTION				THERMAL PROFILE						ELECTRICAL PROFILE											
		TEST CYCLE EVENT AND CONDITION DESCRIP TIONS	TOTAL TEST CYCLE ACCUMULATED CLOCK TIME (HRS-MIN-SEC) (00-00-00)	INDIVIDUAL TEST CYCLE BEGIN-EN-D TIME (HRS-MIN-SEC)	TEST FREE AIR TEMP (°C)	ELECTRONIC EQUIPMENT COMPARTMENT TEMPERATURE (°C)	EXPECTED SURVIVAL RATE MAXIMUM RATE OF CHANGE (%/CYCLE)	TH-C DURATION OF EVENT (HRS-MIN-SEC)	VOLTAGE CONDITION, ON/OFF, PERCENT NORMAL VOLTAGE	SPECIAL FUNCTION INTERRUPT	TIME DURATION OF EVENT (HRS-MIN-SEC)	STANDBY		OPERATE		OCCURRENCE							
												START	H	T	END			L	INSIDE	ON/OFF	%	ON/OFF	%
												YAS	REC'D	AMP	-54			AS	BECD	AS	BECD	OFF	OFF
1-A	1-A	PRE-TEST CONDITIONING GROUND OPERATION	0-0-0	0-25-23	0-25-23	0-25-23	0-25-23	0-25-23	0-25-23	0-25-23	0-25-23	0-25-23	0-25-23	0-25-23	0-25-23	0-25-23	0-25-23	0-25-23					
2-B	2-B	COLD DAY, HIGH-MED-LOW	0-25-23	0-25-23	0-25-23	0-25-23	0-25-23	0-25-23	0-25-23	0-25-23	0-25-23	0-25-23	0-25-23	0-25-23	0-25-23	0-25-23	0-25-23	0-25-23					
3-C	3-C	COLD DAY TRANSITION AMBIENT DAY, OPERATION	0-25-23	0-25-23	0-25-23	0-25-23	0-25-23	0-25-23	0-25-23	0-25-23	0-25-23	0-25-23	0-25-23	0-25-23	0-25-23	0-25-23	0-25-23	0-25-23					
4-D	4-D	AMBIENT DAY, OPERATION	0-25-23	0-25-23	0-25-23	0-25-23	0-25-23	0-25-23	0-25-23	0-25-23	0-25-23	0-25-23	0-25-23	0-25-23	0-25-23	0-25-23	0-25-23	0-25-23					
5-E	5-E	OPERATION PROFILE: AMBIENT DAY, HIGH-MED-LOW	0-25-23	0-25-23	0-25-23	0-25-23	0-25-23	0-25-23	0-25-23	0-25-23	0-25-23	0-25-23	0-25-23	0-25-23	0-25-23	0-25-23	0-25-23	0-25-23					
6-F	6-F	AMBIENT DAY TRANSITION TO HOT DAY	0-25-23	0-25-23	0-25-23	0-25-23	0-25-23	0-25-23	0-25-23	0-25-23	0-25-23	0-25-23	0-25-23	0-25-23	0-25-23	0-25-23	0-25-23	0-25-23					
7-G	7-G	HOT DAY, GROUND OPERATION PROFILE: HOT DAY, HIGH-MED-LOW	0-25-23	0-25-23	0-25-23	0-25-23	0-25-23	0-25-23	0-25-23	0-25-23	0-25-23	0-25-23	0-25-23	0-25-23	0-25-23	0-25-23	0-25-23	0-25-23					
8-H	8-H	MISSION PROFILE: HOT DAY, HIGH-MED-LOW	0-25-23	0-25-23	0-25-23	0-25-23	0-25-23	0-25-23	0-25-23	0-25-23	0-25-23	0-25-23	0-25-23	0-25-23	0-25-23	0-25-23	0-25-23	0-25-23					
9-I	9-I	AMBIENT DAY TRANSITION TO HOT DAY	0-25-23	0-25-23	0-25-23	0-25-23	0-25-23	0-25-23	0-25-23	0-25-23	0-25-23	0-25-23	0-25-23	0-25-23	0-25-23	0-25-23	0-25-23	0-25-23					
10-J	10-J	MISSION PROFILE: HOT DAY, HIGH-MED-LOW	0-25-23	0-25-23	0-25-23	0-25-23	0-25-23	0-25-23	0-25-23	0-25-23	0-25-23	0-25-23	0-25-23	0-25-23	0-25-23	0-25-23	0-25-23	0-25-23					
11-K	11-K	AMBIENT DAY TRANSITION TO GROUND OPERATION	0-25-23	0-25-23	0-25-23	0-25-23	0-25-23	0-25-23	0-25-23	0-25-23	0-25-23	0-25-23	0-25-23	0-25-23	0-25-23	0-25-23	0-25-23	0-25-23					
12-L	12-L	GROUND OPERATION	0-25-23	0-25-23	0-25-23	0-25-23	0-25-23	0-25-23	0-25-23	0-25-23	0-25-23	0-25-23	0-25-23	0-25-23	0-25-23	0-25-23	0-25-23	0-25-23					

1 Use with TABLE LVIII. High-medium-low mission: TABLE LIX, High-low-high mission; and TABLE LX, Free-flight low-low.

2 This table is applicable to all test cycles.



MIL-HDBK-781

TABLE LVIII. Composite test cycle profile example timeline - mission profile for the high-medium-low test cycle profile <sup>1/</sup>

TEST CYCLE NO	TEST CYCLE PHASE (REF TABLE)	TEST CYCLE DESCRIPTION	TEST SEQUENCE DESCRIPTION			ENVIRONMENTAL STRESS PHASING				ELECTRICAL PROFILE										
			TOTAL TEST CYCLE DURATION (HRS-MIN-SEC)	START END	START END	START END	START END	START END	START END	START END	START END	START END	START END	START END	START END					
																INDIVIDUAL TEST CYCLE DURATION (HRS-MIN-SEC)	TEST START END	TEST START END	TEST START END	TEST START END
1	PHASE A	FROM PHASE A TO GROUND OPERATION	0-00-00	0-00-12	0-00-00	0-00-12	0-00-00	0-00-12	0-00-00	0-00-12	0-00-00	0-00-12	0-00-00	0-00-12	0-00-00	0-00-12	0-00-00	0-00-12	0-00-00	0-00-12
2	PHASE B	TO CLIMB LOW CRUISE	0-00-12	0-00-25	0-00-12	0-00-25	0-00-12	0-00-25	0-00-12	0-00-25	0-00-12	0-00-25	0-00-12	0-00-25	0-00-12	0-00-25	0-00-12	0-00-25	0-00-12	0-00-25
3	PHASE C	CLIMB HIGH STATION	0-00-25	0-01-00	0-00-25	0-01-00	0-00-25	0-01-00	0-00-25	0-01-00	0-00-25	0-01-00	0-00-25	0-01-00	0-00-25	0-01-00	0-00-25	0-01-00	0-00-25	0-01-00
4	PHASE D	DESCEND HIGH ATTACK	0-01-00	0-01-07	0-01-00	0-01-07	0-01-00	0-01-07	0-01-00	0-01-07	0-01-00	0-01-07	0-01-00	0-01-07	0-01-00	0-01-07	0-01-00	0-01-07	0-01-00	0-01-07
5	PHASE E	CLIMB ALTIMETER	0-01-07	0-01-11	0-01-07	0-01-11	0-01-07	0-01-11	0-01-07	0-01-11	0-01-07	0-01-11	0-01-07	0-01-11	0-01-07	0-01-11	0-01-07	0-01-11	0-01-07	0-01-11
6	PHASE F	DESCEND HIGH ATTACK (CLIMB ALTIMETER)	0-01-11	0-01-14	0-01-11	0-01-14	0-01-11	0-01-14	0-01-11	0-01-14	0-01-11	0-01-14	0-01-11	0-01-14	0-01-11	0-01-14	0-01-11	0-01-14	0-01-11	0-01-14
7	PHASE G	DESCEND HIGH ATTACK	0-01-14	0-01-23	0-01-14	0-01-23	0-01-14	0-01-23	0-01-14	0-01-23	0-01-14	0-01-23	0-01-14	0-01-23	0-01-14	0-01-23	0-01-14	0-01-23	0-01-14	0-01-23
8	PHASE H	DESCEND HIGH STATION	0-01-23	0-01-25	0-01-23	0-01-25	0-01-23	0-01-25	0-01-23	0-01-25	0-01-23	0-01-25	0-01-23	0-01-25	0-01-23	0-01-25	0-01-23	0-01-25	0-01-23	0-01-25
9	PHASE I	CLIMB INITIAL	0-01-25	0-01-25	0-01-25	0-01-25	0-01-25	0-01-25	0-01-25	0-01-25	0-01-25	0-01-25	0-01-25	0-01-25	0-01-25	0-01-25	0-01-25	0-01-25	0-01-25	0-01-25
10	PHASE J	DESCEND HIGH ATTACK	0-01-25	0-01-34	0-01-25	0-01-34	0-01-25	0-01-34	0-01-25	0-01-34	0-01-25	0-01-34	0-01-25	0-01-34	0-01-25	0-01-34	0-01-25	0-01-34	0-01-25	0-01-34
11	PHASE K	CLIMB HIGH CRUISE	0-01-34	0-01-41	0-01-34	0-01-41	0-01-34	0-01-41	0-01-34	0-01-41	0-01-34	0-01-41	0-01-34	0-01-41	0-01-34	0-01-41	0-01-34	0-01-41	0-01-34	0-01-41
12	PHASE L	DESCEND HIGH ATTACK	0-01-41	0-01-47	0-01-41	0-01-47	0-01-41	0-01-47	0-01-41	0-01-47	0-01-41	0-01-47	0-01-41	0-01-47	0-01-41	0-01-47	0-01-41	0-01-47	0-01-41	0-01-47
13	PHASE M	CLIMB HIGH CRUISE	0-01-47	0-01-51	0-01-47	0-01-51	0-01-47	0-01-51	0-01-47	0-01-51	0-01-47	0-01-51	0-01-47	0-01-51	0-01-47	0-01-51	0-01-47	0-01-51	0-01-47	0-01-51
14	PHASE N	DESCEND HIGH ATTACK	0-01-51	0-01-54	0-01-51	0-01-54	0-01-51	0-01-54	0-01-51	0-01-54	0-01-51	0-01-54	0-01-51	0-01-54	0-01-51	0-01-54	0-01-51	0-01-54	0-01-51	0-01-54
15	PHASE O	CLIMB HIGH CRUISE (BACK)	0-01-54	0-01-54	0-01-54	0-01-54	0-01-54	0-01-54	0-01-54	0-01-54	0-01-54	0-01-54	0-01-54	0-01-54	0-01-54	0-01-54	0-01-54	0-01-54	0-01-54	0-01-54
16	PHASE P	DESCEND HIGH CRUISE	0-01-54	0-01-54	0-01-54	0-01-54	0-01-54	0-01-54	0-01-54	0-01-54	0-01-54	0-01-54	0-01-54	0-01-54	0-01-54	0-01-54	0-01-54	0-01-54	0-01-54	0-01-54
17	PHASE Q	RETURN TO TRANSITION PHASE B OR O	0-01-54	0-01-54	0-01-54	0-01-54	0-01-54	0-01-54	0-01-54	0-01-54	0-01-54	0-01-54	0-01-54	0-01-54	0-01-54	0-01-54	0-01-54	0-01-54	0-01-54	0-01-54

<sup>1/</sup> Use with TABLE LVII

<sup>2/</sup> Voltage: 110% - Cycles 1, 4, 7, 10; 100% - Cycles 2, 5, 8; 90% - Cycles 3, 6, 9

<sup>3/</sup> Special Interrupt functions (10  $\mu$ s - 300  $\mu$ s and 20 ms - 150 ms) occur during cycles 1, 3, 5, 7, 9

<sup>4/</sup> (A) Cold Day

MIL-HDBK-781

TABLE LVIII. Composite test cycle profile example timeline - mission profile for the high-medium-low test cycle profile 1/ (Cont)

ITEM NO	TEST CYCLE AND PHASE NO. (REF. FIGURE)	TEST SEGMENT, SEQUENCE DESCRIPTION		THERMAL PROFILE 2/				ELECTRICAL PROFILE				
		TEST CYCLE AND PHASE NO. (REF. FIGURE)	TOTAL TEST CYCLE ACCUMULATED CLOCK TIME (HRS-MIN-SEC) (00-00-00)	INDIVIDUAL TEST CYCLE DURATION (HRS-MIN-SEC)	TEST FINISH TIME (HRS-MIN-SEC)	ELECTRONIC EQUIPMENT COMPARTMENT TEMPERATURE (°C)	START	END	EXPECTED TEMPERATURE DIFFERENTIAL OF CHANGE (°C/HRS)	TIME DURATION OF EVENT (HRS-MIN-SEC)	SPECIAL FUNCTION INTERRUPT	TIME DURATION OF EVENT (HRS-MIN-SEC)
1	PHASE 1	0-00-00	0-00-00	0-00-00	0-00-00	0-00-00	0-00-00	0-00-00	0-00-00	0-00-00	0-00-00	0-00-00
2	PHASE 2	0-00-00	0-00-00	0-00-00	0-00-00	0-00-00	0-00-00	0-00-00	0-00-00	0-00-00	0-00-00	0-00-00
3	PHASE 3	0-00-00	0-00-00	0-00-00	0-00-00	0-00-00	0-00-00	0-00-00	0-00-00	0-00-00	0-00-00	0-00-00
4	PHASE 4	0-00-00	0-00-00	0-00-00	0-00-00	0-00-00	0-00-00	0-00-00	0-00-00	0-00-00	0-00-00	0-00-00
5	PHASE 5	0-00-00	0-00-00	0-00-00	0-00-00	0-00-00	0-00-00	0-00-00	0-00-00	0-00-00	0-00-00	0-00-00
6	PHASE 6	0-00-00	0-00-00	0-00-00	0-00-00	0-00-00	0-00-00	0-00-00	0-00-00	0-00-00	0-00-00	0-00-00
7	PHASE 7	0-00-00	0-00-00	0-00-00	0-00-00	0-00-00	0-00-00	0-00-00	0-00-00	0-00-00	0-00-00	0-00-00
8	PHASE 8	0-00-00	0-00-00	0-00-00	0-00-00	0-00-00	0-00-00	0-00-00	0-00-00	0-00-00	0-00-00	0-00-00
9	PHASE 9	0-00-00	0-00-00	0-00-00	0-00-00	0-00-00	0-00-00	0-00-00	0-00-00	0-00-00	0-00-00	0-00-00
10	PHASE 10	0-00-00	0-00-00	0-00-00	0-00-00	0-00-00	0-00-00	0-00-00	0-00-00	0-00-00	0-00-00	0-00-00
11	PHASE 11	0-00-00	0-00-00	0-00-00	0-00-00	0-00-00	0-00-00	0-00-00	0-00-00	0-00-00	0-00-00	0-00-00
12	PHASE 12	0-00-00	0-00-00	0-00-00	0-00-00	0-00-00	0-00-00	0-00-00	0-00-00	0-00-00	0-00-00	0-00-00
13	PHASE 13	0-00-00	0-00-00	0-00-00	0-00-00	0-00-00	0-00-00	0-00-00	0-00-00	0-00-00	0-00-00	0-00-00
14	PHASE 14	0-00-00	0-00-00	0-00-00	0-00-00	0-00-00	0-00-00	0-00-00	0-00-00	0-00-00	0-00-00	0-00-00
15	PHASE 15	0-00-00	0-00-00	0-00-00	0-00-00	0-00-00	0-00-00	0-00-00	0-00-00	0-00-00	0-00-00	0-00-00
16	PHASE 16	0-00-00	0-00-00	0-00-00	0-00-00	0-00-00	0-00-00	0-00-00	0-00-00	0-00-00	0-00-00	0-00-00
17	PHASE 17	0-00-00	0-00-00	0-00-00	0-00-00	0-00-00	0-00-00	0-00-00	0-00-00	0-00-00	0-00-00	0-00-00

1/ Use with TABLE LVII

2/ Voltage: 110% - Cycles 1, 4, 7, 10; 100% - Cycles 2, 5, 8; 90% - Cycles 3, 6, 9

3/ Special interrupt functions (10 µs - 300 µs and 20 ms - 150 ms) occur during cycles 1, 3, 5, 7, 9

4/ [B] Ambient Day



MIL-HDBK-781

TABLE LVIII. Composite test cycle profile example timeline - mission profile for the high-medium-low test cycle profile  $V$  (Cont)

ITEM NO.	APPLY TO ALL CYCLE AND PHASE NOS. (PRELIM. PHASE ON)	TEST SEGMENT, SEQUENCE DESCRIPTION			HUMIDITY AND ALTITUDE PROFILE			ENVIRONMENTAL STRESS PHASING				VIBRATION PROFILE		
		TEST CYCLE EVENT AND CONTRIBUTION TO TOTAL TEST CYCLE TIME (HRS-MIN-SEC)	START	END	PLN (US)	START (1000 FEET)	END (1000 FEET)	SCHED RATE OF CHANGE (1000 FPM)	THE DURATION OF THE EVENT (HRS-MIN-SEC)	SPECTRUM FAILURE (100)	VIBRATION FACTOR (PHASING 100)	%	START BUFFER (HRS-MIN-SEC)	THE DURATION OF THE EVENT (HRS-MIN-SEC)
1	PHASE 1	PHASE 1	0-0-0	0-0-0	100	10000	Level 1	10.0	0-00-0				0-00-0	
2	PHASE 2	PHASE 2	0-0-0	0-0-0	84	10000	0.017	0-0-0	0-00-0	A	1.0	NONE	0-00-0	0-00-0
3	PHASE 3	PHASE 3	0-0-0	0-0-0	37	0.017	0.374	0-0-0	0-00-0	A	1.0	NONE	0-00-0	0-00-0
4	PHASE 4	PHASE 4	0-0-0	0-0-0	74	0.374	0.748	0-0-0	0-00-0	C	14.04	0.0004	0-00-0	0-00-0
5	PHASE 5	PHASE 5	0-0-0	0-0-0	93	0.748	0.932	0-0-0	0-00-0	C	5.0	0.0004	0-00-0	0-00-0
6	PHASE 6	PHASE 6	0-0-0	0-0-0	140	0.932	0.140	0-0-0	0-00-0	C	14.04	0.0004	0-00-0	0-00-0
7	PHASE 7	PHASE 7	0-0-0	0-0-0	93	0.140	0.932	0-0-0	0-00-0	C	5.0	0.0004	0-00-0	0-00-0
8	PHASE 8	PHASE 8	0-0-0	0-0-0	140	0.932	0.140	0-0-0	0-00-0	C	14.04	0.0004	0-00-0	0-00-0
9	PHASE 9	PHASE 9	0-0-0	0-0-0	93	0.140	0.932	0-0-0	0-00-0	C	5.0	0.0004	0-00-0	0-00-0
10	PHASE 10	PHASE 10	0-0-0	0-0-0	140	0.932	0.140	0-0-0	0-00-0	C	14.04	0.0004	0-00-0	0-00-0
11	PHASE 11	PHASE 11	0-0-0	0-0-0	93	0.140	0.932	0-0-0	0-00-0	C	5.0	0.0004	0-00-0	0-00-0
12	PHASE 12	PHASE 12	0-0-0	0-0-0	140	0.932	0.140	0-0-0	0-00-0	C	14.04	0.0004	0-00-0	0-00-0
13	PHASE 13	PHASE 13	0-0-0	0-0-0	93	0.140	0.932	0-0-0	0-00-0	C	5.0	0.0004	0-00-0	0-00-0
14	PHASE 14	PHASE 14	0-0-0	0-0-0	140	0.932	0.140	0-0-0	0-00-0	C	14.04	0.0004	0-00-0	0-00-0
15	PHASE 15	PHASE 15	0-0-0	0-0-0	93	0.140	0.932	0-0-0	0-00-0	C	5.0	0.0004	0-00-0	0-00-0
16	PHASE 16	PHASE 16	0-0-0	0-0-0	140	0.932	0.140	0-0-0	0-00-0	C	14.04	0.0004	0-00-0	0-00-0
17	PHASE 17	PHASE 17	0-0-0	0-0-0	93	0.140	0.932	0-0-0	0-00-0	C	5.0	0.0004	0-00-0	0-00-0

1/ Use with TABLE LVII  
 2/ Voltage: 110% - Cycles 1, 4, 7, 10; 100% - Cycles 2, 5, 8, 90% - Cycles 3, 6, 9  
 3/ Special Interrupt functions (10  $\mu$ s - 300  $\mu$ s and 20 ms - 150 ms) occur during cycles 1, 3, 5, 7, 9  
 4/ [A, B, C] (Cold, Ambient, Hot) Days  
 5/ Sea level

MIL-HDBK-781

TABLE LIX. Composite test cycle profile example timeline - mission profile for the high-low-high test cycle 1/

ITEM NO.	CYCLE AND PHASE NO. (REF. FIGURE 11)	TEST SEGMENT, SEQUENCE DESCRIPTION				THERMAL PROFILE 2/				ENVIRONMENTAL STRESS PHASING				ELECTRICAL PROFILE			
		TEST CYCLE EVENT AND OPERATION BEG. TIME (HRS-MIN-SEC) (00-00-00)	TOTAL TEST CYCLE ACCUMULATED GLOBE TIME (HRS-MIN-SEC)	INDIVIDUAL TEST CYCLE INTERMITTENT TYPE (HRS-MIN-SEC)	TEST FREE AIR TEMP (°C)	START	END	ELECTRONIC EQUIPMENT (OPERATING) TEMPERATURE (°C)	EMBEDDED TEMPERATURE MEASUREMENT CHANGE (°C/HR)	TIME DURATION OF EVENT (HRS-MIN-SEC)	STANDBY		OPERATE		SPECIAL FUNCTION INTERRUPT	TIME DURATION OF EVENT (HRS-MIN-SEC)	
											START	END	CHOFF	CHON			VOLTAGE CONDITION, CHOFF, PERCENT NOMINAL VOLTAGE
1	1	FROM PHASE A ON O. CIRCUIT OPERATION	0-00-00	0-00-00	-54	-54	-54	-54	INSIDE	0-00-00	CHOFF	CHON	0-00-00	0-00-00	0-00-00	0-00-00	
2	2	TO CLIMB/RUN-OUT	0-00-02	0-00-27	-54	-39	-39	-39	INSIDE	0-00-27	CHOFF	CHON	0-00-27	0-00-27	0-00-27	0-00-27	
3	3	CLIMB/COURSE	0-00-29	0-00-45	-39	-35	-35	-35	INSIDE	0-00-45	CHOFF	CHON	0-00-45	0-00-45	0-00-45	0-00-45	
4	4	DESCEND-ON-STATION	0-00-27	0-00-27	-35	-10	-10	-10	INSIDE	0-00-27	CHOFF	CHON	0-00-27	0-00-27	0-00-27	0-00-27	
5	5	DIVE/ATTACK	0-00-00	0-00-04	-10	-23	-23	-23	INSIDE	0-00-04	CHOFF	CHON	0-00-04	0-00-04	0-00-04	0-00-04	
6	6	CLIMB/COURSE	0-00-07	0-00-07	-23	-6	-6	-6	INSIDE	0-00-07	CHOFF	CHON	0-00-07	0-00-07	0-00-07	0-00-07	
7	7	DIVE/ATTACK	0-00-04	0-00-04	-6	-23	-23	-23	INSIDE	0-00-04	CHOFF	CHON	0-00-04	0-00-04	0-00-04	0-00-04	
8	8	CLIMB/COURSE	0-00-04	0-00-04	-23	-6	-6	-6	INSIDE	0-00-04	CHOFF	CHON	0-00-04	0-00-04	0-00-04	0-00-04	
9	9	DIVE/ATTACK	0-00-04	0-00-04	-6	-23	-23	-23	INSIDE	0-00-04	CHOFF	CHON	0-00-04	0-00-04	0-00-04	0-00-04	
10	10	CLIMB/COURSE	0-00-04	0-00-04	-23	-6	-6	-6	INSIDE	0-00-04	CHOFF	CHON	0-00-04	0-00-04	0-00-04	0-00-04	
11	11	DESCEND/COURSE/LOW	0-00-04	0-00-04	-6	-23	-23	-23	INSIDE	0-00-04	CHOFF	CHON	0-00-04	0-00-04	0-00-04	0-00-04	
12	12	THE TURN TO TRANSITION PHASE ON B	0-00-04	0-00-11	-23	-10	-10	-10	INSIDE	0-00-11	CHOFF	CHON	0-00-11	0-00-11	0-00-11	0-00-11	

1/ Use with TABLE LVII  
 2/ Voltage 110% - Cycles 1, 4, 7, 10; 100% - Cycles 2, 5, 8; 90% - Cycles 3, 6, 9  
 3/ Special interrupt functions (10 μs - 300 μs and 20 ms - 150 ms) occur during cycles 1, 3, 5, 7, 9  
 4/ [A] Cold Day

TABLE LIX. Composite test cycle profile example timeline - mission profile for the high-low-high test cycle <sup>1</sup> (Continued)

ITEM NO	CYCLE AND PHASE NO (REF FIGURE 139)	TEST SEGMENT, SEQUENCE DESCRIPTION				THERMAL PROFILE <sup>2</sup>				ENVIRONMENTAL STRESS PHASINGS				ELECTRICAL PROFILE					
		TEST CYCLE EVENT AND CONDITION DESCRIPTIONS (REFER TO TABLE ST)	TOTAL TEST CYCLE ACCUMULATED CLOCK TIME (HRS-MIN-SEC) (00-00-00)	INDIVIDUAL TEST CYCLE INTERVAL TIME (HRS-MIN-SEC)	DURATION	START	END	TEST FREE AIR TEMP (°C)	START	END	BLIGHTING EQUIPMENT OPERATING TEMPERATURE (°C)	EXPECTED TEMPERATURE MAXIMUM RATE OF CHANGE (°C/MIN)	TIME DURATION OF EVENT (HRS-MIN-SEC)	VOLTAGE CONDITION, ON/OFF, PERCENT NORMAL VOLTAGE	OPERATE	STANDBY	VOLTAGE CONDITION, ON/OFF, PERCENT NORMAL VOLTAGE	SPECIAL FUNCTION INTERRUPT	TIME DURATION OF EVENT (HRS-MIN-SEC)
1		FRONT PHASE D ORL GROUND OPERATION	0-00-00	0-00-00	0-00-12	15	15	15	15			0-00-12	ON/OFF 2/ OFF 2/	ON/OFF 2/ OFF 2/	ON/OFF 2/ OFF 2/				0-00-12
2		TO CLIMB/PLUNGE-OUT	0-00-39	0-00-32	0-30-27	15	34	15	34			0-30-27	ON/OFF 6/ 10-14	ON/OFF 6/ 10-14	ON/OFF 6/ 10-14				0-03-19
3		CLIMB/PLUNGE	0-30-24	0-30-29	0-50-05	34	31	34	31			0-50-05	ON/OFF 24/ 32-30	ON/OFF 24/ 32-30	ON/OFF 24/ 32-30				0-00-00
4		DESCEND/ON-STATION	0-51-51	1-21-24	0-30-27	-31	21	-31	21			0-30-27	ON/OFF 00/ 01	ON/OFF 00/ 01	ON/OFF 00/ 01				0-10-09
5		DIVE/ATTACK	1-55-55	1-51-51	0-4-4	21	44	21	44			0-04-04	ON/OFF 07/ 01	ON/OFF 07/ 01	ON/OFF 07/ 01				0-10-09
6		CLIMB/CLIMB-OUTER	2-00-02	1-55-55	0-1-7	44	27	44	27			0-01-07	ON/OFF 07/ 01	ON/OFF 07/ 01	ON/OFF 07/ 01				0-14-0
7		DIVE/ATTACK	2-00-04	2-00-02	0-4-4	27	44	27	44			0-04-04	ON/OFF 07/ 01	ON/OFF 07/ 01	ON/OFF 07/ 01				0-14-0
8		CLIMB/CLIMB-INNER	2-12-10	2-00-04	0-4-4	44	27	44	27			0-04-04	ON/OFF 07/ 01	ON/OFF 07/ 01	ON/OFF 07/ 01				0-14-0
9		DIVE/ATTACK	2-18-14	2-12-10	0-4-4	27	44	27	44			0-04-04	ON/OFF 07/ 01	ON/OFF 07/ 01	ON/OFF 07/ 01				0-14-0
10		CLIMB/CLIMB-OUTER	2-30-27	2-18-14	0-14-0	44	27	44	27			0-14-0	ON/OFF 07/ 01	ON/OFF 07/ 01	ON/OFF 07/ 01				0-14-0
11		CLIMB/PLUNGE (BACK)	3-17-00	2-30-27	0-04-01	27	-02	27	-02			0-04-01	ON/OFF 07/ 01	ON/OFF 07/ 01	ON/OFF 07/ 01				1-21-02
12		DESCEND/PLUNGE/ LDG RETURN TO TRANSITION PHASE 1 OR M	4-03-00	3-17-00	0-04-01	-02	24	-02	24			0-04-01	ON/OFF 07/ 01	ON/OFF 07/ 01	ON/OFF 07/ 01				0-10-09
13			4-04-11	4-03-00	0-0-11	24	15	24	15			0-00-11	ON/OFF 07/ 01	ON/OFF 07/ 01	ON/OFF 07/ 01				0-10-09

<sup>1</sup> Use with TABLE LVII  
<sup>2</sup> Voltage: 110% - Cycles 1, 4, 7, 10; 100% - Cycles 2, 5, 8; 90% - Cycles 3, 6, 9  
<sup>3</sup> Special Interrupt functions (10 μs - 300 μs and 20 ms - 150 ms) occur during cycles 1, 3, 5, 7, 9  
<sup>4</sup> [B] Ambient Day

MIL-HDBK-781

TABLE LIX. Composite test cycle profile example timeline - mission profile for the high-low-high test cycle 1/ (Continued)

ITEM NO.	CYCLE AND PHASE NO. (REF. FIGURE 13)	TEST SEGMENT, SEQUENCE DESCRIPTION				THERMAL PROFILE 4/				ENVIRONMENTAL STRESS PHASINGS				ELECTRICAL PROFILE			
		TEST CYCLE EVENT AND CONDITION DESCRIPTIONS REFERENCE TABLE 7	EACH CYCLE TOTAL TEST DURATION (HRS-MIN-SEC)	INDIVIDUAL TEST CYCLE DURATION (HRS-MIN-SEC)	TEST FUSE AIR TEMP (°C)	START	END	ELECTRONIC EQUIPMENT COMPARTMENT TEMPERATURE (°C)	EMBEDDED TEMPERATURE PHASING RATE OF CHANGE (°C/HRS)	TYPE DURATION OF EVENT (HRS-MIN-SEC)	VOLTAGE CONDITION ON/OFF PERCENT NOMINAL VOLTAGE	SPECIAL FUNCTION INTERRUPT	TYPE DURATION OF EVENT (HRS-MIN-SEC)	STABILITY	OPERATE	OCCURRENCE	TYPE DURATION OF EVENT (HRS-MIN-SEC)
1	FOR ALL HOT DAY BOMBING PHASES H AND I AND FOR ALL HOT DAY BOMBING PHASES J THROUGH N	FROM PHASES ON GROUND OPERATION FOR CLIMB/CRUISE/OUT	0-00-12	0-00-00	0-00-12	0-00-00	0-00-12	0-00-00	0-00-12	0-00-00	0-00-12	0-00-00	0-00-12	0-00-00	0-00-12	0-00-00	0-00-12
2		CLIMB/CRUISE	0-10-30	0-00-12	0-10-30	0-00-12	0-10-30	0-00-12	0-10-30	0-00-12	0-10-30	0-00-12	0-00-12	0-00-12	0-00-12	0-00-12	0-00-12
3		DESCEND/OUT STATION	0-11-01	0-10-30	0-11-01	0-10-30	0-11-01	0-10-30	0-11-01	0-10-30	0-11-01	0-10-30	0-11-01	0-10-30	0-11-01	0-10-30	0-11-01
4		DEPART/TAKE OFF/BOILER	0-00-00	0-00-00	0-00-00	0-00-00	0-00-00	0-00-00	0-00-00	0-00-00	0-00-00	0-00-00	0-00-00	0-00-00	0-00-00	0-00-00	0-00-00
5		DEPART/TAKE OFF/BOILER	0-00-00	0-00-00	0-00-00	0-00-00	0-00-00	0-00-00	0-00-00	0-00-00	0-00-00	0-00-00	0-00-00	0-00-00	0-00-00	0-00-00	0-00-00
6		CLIMB/CRUISE	0-10-30	0-00-00	0-10-30	0-00-00	0-10-30	0-00-00	0-10-30	0-00-00	0-10-30	0-00-00	0-10-30	0-00-00	0-10-30	0-00-00	0-10-30
7		DEPART/TAKE OFF/BOILER	0-00-00	0-00-00	0-00-00	0-00-00	0-00-00	0-00-00	0-00-00	0-00-00	0-00-00	0-00-00	0-00-00	0-00-00	0-00-00	0-00-00	0-00-00
8		DEPART/TAKE OFF/BOILER	0-00-00	0-00-00	0-00-00	0-00-00	0-00-00	0-00-00	0-00-00	0-00-00	0-00-00	0-00-00	0-00-00	0-00-00	0-00-00	0-00-00	0-00-00
9		CLIMB/CRUISE (BACK)	0-17-00	0-16-41	0-17-00	0-16-41	0-17-00	0-16-41	0-17-00	0-16-41	0-17-00	0-16-41	0-17-00	0-16-41	0-17-00	0-16-41	0-17-00
10		DESCEND/CRUISE	0-03-00	0-02-41	0-03-00	0-02-41	0-03-00	0-02-41	0-03-00	0-02-41	0-03-00	0-02-41	0-03-00	0-02-41	0-03-00	0-02-41	0-03-00
11		RETURN TO TRANSITION PHASE/ON GROUND OPERATION, PHASES I AND J	0-00-00	0-00-00	0-00-00	0-00-00	0-00-00	0-00-00	0-00-00	0-00-00	0-00-00	0-00-00	0-00-00	0-00-00	0-00-00	0-00-00	0-00-00

1/ Use with TABLE LVII  
 2/ Voltage: 110% - Cycles 1, 4, 7, 10; 100% - Cycles 2, 5, 8; 90% - Cycles 3, 6, 9  
 3/ Special Interrupt functions (10 μs - 300 μs and 20 ms - 150 ms) occur during cycles 1, 3, 5, 7, 9  
 4/ [C] Hot Day

MIL-HDBK-781

TABLE LIX. Composite test cycle profile example timeline - mission profile for the high-low-high test cycle <sup>1/</sup> (Continued)

ITEM NO.	CYCLE PHASE NO. (MIL-HDBK-781)	TEST CYCLE EVENT AND CONDITION DESCRIPTION REFERENCE TABLES	ENVIRONMENTAL TEST		SEQUENCE DESCRIPTION		INDIVIDUAL TEST CYCLE INFORMATION		HUMIDITY AND ALTITUDE PROFILE		ENVIRONMENTAL STRESS PHASING				VELOCITY PROFILE				
			START	DURATION	START	DURATION	START	END	START	END	SOUND RATE OF CHANGE (MIL-HDBK-781)	TYPE OF EVENT (MIL-HDBK-781)	SPECTRUM NO. (MIL-HDBK-781)	VELOCITY FACTOR (MIL-HDBK-781)	%	START TIME (MIL-HDBK-781)	TYPE OF EVENT (MIL-HDBK-781)	TYPE DURATION OF EVENT (MIL-HDBK-781)	
1	1-01-01	FRONT PHASE GROUND OPERATION	0-00-00	0-00-12	100	1.0000	1.0000	0-00-00	0-00-12	0-00-00	0-00-12								
2	1-01-02	TARGET BURST-OUT	0-00-12	0-00-27	95	1.0000	0.9719	0-00-12	0-00-27	0-00-12	0-00-27	C	11.22	0.0046					
3	1-01-03	CLIP-ONRUSE	0-00-27	0-01-05	97	0.9719	0.9741	0-00-27	0-01-05	0-00-27	0-01-05	A	1.04	0.0040	NONE				
4	1-01-04	DESCENDANT STATION	0-01-05	0-01-24	70	0.9741	0.7064	0-01-05	0-01-24	0-01-05	0-01-24	C	6.6	0.0039	0.0012				
5	1-01-05	DESCENDANT	0-01-24	0-01-41	92	0.7064	0.9191	0-01-24	0-01-41	0-01-24	0-01-41	C	22.61	0.0132	0.0004	0-01-24 (1-01-41)			
6	1-01-06	CLIP-FLUTTER	0-01-41	0-01-58	70	0.9191	0.7064	0-01-41	0-01-58	0-01-41	0-01-58	C	10.4	0.0040	0.0001				
7	1-01-07	DESCENDANT	0-01-58	0-02-04	92	0.7064	0.9191	0-01-58	0-02-04	0-01-58	0-02-04	C	22.61	0.0132	0.0004	0-01-58 (2-02-04)			
8	1-01-08	CLIP-FLUTTER	0-02-04	0-02-10	70	0.9191	0.7064	0-02-04	0-02-10	0-02-04	0-02-10	C	10.4	0.0040	0.0001				
9	1-01-09	CLIP-RECONNECT	0-02-10	0-02-16	92	0.7064	0.9191	0-02-10	0-02-16	0-02-10	0-02-16	C	22.61	0.0132	0.0004	0-02-10 (2-02-16)			
10	1-01-10	DESCENDANT	0-02-16	0-02-27	94	0.9191	0.9417	0-02-16	0-02-27	0-02-16	0-02-27	C	6.6	0.0039	0.0001				
11	1-01-11	CLIP-ONRUSE (BACK)	0-02-27	0-03-03	100	0.9417	0.9750	0-02-27	0-03-03	0-02-27	0-03-03	A	1.61	0.0042	NONE				
12	1-01-12	DESCENDANT/LOG	0-03-03	0-03-09	92	0.9750	0.9211	0-03-03	0-03-09	0-03-03	0-03-09	C	5.11	0.0032	0.0004				
13	1-01-13	RETURN TO TRANSITION PHASE	0-03-09	0-03-11	100	0.9211	1.0000	0-03-09	0-03-11	0-03-09	0-03-11								

<sup>1/</sup> Use with TABLE LXII  
<sup>2/</sup> Voltage: 110% - Cycles 1, 4, 7, 10; 100% - Cycles 2, 5, 8, 90% - Cycles 3, 6, 9  
<sup>3/</sup> Special Interrupt functions (10 μs - 300 μs and 20 ms - 150 ms) occur during cycles 1, 3, 5, 7, 9  
<sup>4/</sup> [A, B, C] (Cold, Ambient, Hot) Days  
<sup>5/</sup> Sea level

MIL-HDBK-781

TABLE LX. Composite test cycle profile example timeline - mission profile for the free-flight low-low 1/

ITEM NO.	CYCLE AND PHASE NO. (REF. FIGURE 13)	TEST CYCLE EVENT AND DESCRIPTIONS REFERENCE TABLE 17	EACH CYCLE TOTAL TEST CYCLE DURATION (HRS-MIN-SEC)	INDIVIDUAL TEST CYCLE DURATION (HRS-MIN-SEC)	THERMAL PROFILE 4/				ELECTRICAL PROFILE								
					START	DURATION	START	END	OUTSIDE	INSIDE	ELECTRONIC EQUIPMENT COMPARTMENT TEMPERATURE (°C)	EXPLOITED TEMPERATURE HIGHLIGHT OF CHANGES (°C/HR)	THE DURATION OF EVENT (HRS-MIN-SEC)	VOLTAGE OPERATION, ON/OFF, PERCENT NORMAL VOLTAGE	SPECIAL FUNCTION INTERRUPT	THE DURATION OF EVENT (HRS-MIN-SEC)	
																	START
0		FROM PHASE 1, P. OR H PREE FLIGHT LAUNCH/ MIN. AL SPEED/ MAX. SPEED	0-00-00	0-0-0	START	END	START	END	OUTSIDE	INSIDE							
1.0		MAX. ALTITUDE/ MAX. SPEED	0-00-01	0-0-1	-23	-21	-23	-21	-23	-21	0-00-01	0-00-01	0-00-01	0-00-01	0-00-01	0-00-01	0-00-01
2.0		ENGINE BURST/ OUT	0-00-04	0-0-3	-24	-21	-24	-21	-24	-21	0-00-03	0-00-03	0-00-03	0-00-03	0-00-03	0-00-03	0-00-03
3.0		RECOVERY/ REUSER	0-00-01	0-0-1	-23	-21	-23	-21	-23	-21	0-00-01	0-00-01	0-00-01	0-00-01	0-00-01	0-00-01	0-00-01
4.0		WAKE-UP/ COMPARTMENT TEMPERATURE	0-00-05	0-0-4	-24	-21	-24	-21	-24	-21	0-00-04	0-00-04	0-00-04	0-00-04	0-00-04	0-00-04	0-00-04
5.0		ELECTRICAL SIGNAL ON/OFF	0-00-02	0-0-2	-23	-21	-23	-21	-23	-21	0-00-02	0-00-02	0-00-02	0-00-02	0-00-02	0-00-02	0-00-02
6		SPLASH-DOWN/ RETURN TO NET/ PHASE IN FACE/ FLIGHT CYCLE (TABLE 17)	0-00-04	0-0-4	-23	-21	-23	-21	-23	-21	0-00-04	0-00-04	0-00-04	0-00-04	0-00-04	0-00-04	0-00-04

- 1/ Use with TABLE LVII
- 2/ Forward radome compartment
- 3/ Guidance and control and avionics compartment
- 4/ [A] Cold Day

MIL-HDBK-781

TABLE LX. Composite test cycle profile example timeline - mission profile for the free-flight low-low 1/

ITEM NO	TEST SEGMENT, SEQUENCE DESCRIPTION				THERMAL PROFILE 4/				ELECTRICAL PROFILE					
	CYCLE AND PHASE NO. (REF. FIGURE 17)	TEST CYCLE EVENT AND CONDITION DESCRIPTORS REFERENCE TABLE 17	LAGG CYCLE TOTAL TEST CYCLE (HRS-MIN-SEC)	INDIVIDUAL TEST CYCLE INCREMENTAL TIME (HRS-MIN-SEC)	FREE AIR TEMP (°C)	START	END	ENVIRONMENT (INSIDE/OUTSIDE)	EXPECTED TEMPERATURE MAXIMUM RATE OF CHANGE (°C/HR)	THE DURATION OF EVENT (HRS-MIN-SEC)	VOLTAGE CONDITION, ONOFF, PERCENT NOMINAL VOLTAGE		SPECIAL FUNCTION INTERRUPT	THE DURATION OF EVENT (HRS-MIN-SEC)
											START	DURATION		
1 (a)	FROM PHASE 04 TO FREE FLIGHT LAUNCH	0-00-00	0-0-0	0-0-0	0	0	0	INSIDE		0-00-00			0-00-00	
1 (b)	FROM PHASE 04 TO FREE FLIGHT LAUNCH	0-01-00	0-0-0	0-0-0	0	0	0	INSIDE		0-01-01			0-01-01	
2 (a)	ENGINE SHUT-DOWN	0-04-04	0-0-0	0-0-0	0	0	0	INSIDE		0-03-03			0-03-03	
2 (b)	ENGINE SHUT-DOWN	0-04-04	0-0-0	0-0-0	0	0	0	INSIDE		0-03-03			0-03-03	
3 (a)	RECOVERY PHASE 04	0-04-04	0-0-0	0-0-0	0	0	0	INSIDE		0-00-37			0-00-37	
3 (b)	RECOVERY PHASE 04	0-04-04	0-0-0	0-0-0	0	0	0	INSIDE		0-00-37			0-00-37	
4 (a)	MANEUVER COMPARTMENT TEMPERATURE	0-05-05	0-0-0	0-0-0	0	0	0	INSIDE		0-00-24			0-00-24	
4 (b)	MANEUVER COMPARTMENT TEMPERATURE	0-05-05	0-0-0	0-0-0	0	0	0	INSIDE		0-00-24			0-00-24	
5 (a)	ELECTRONIC SIGNAL CHECK	0-05-05	0-0-0	0-0-0	0	0	0	INSIDE		0-00-37			0-00-37	
5 (b)	ELECTRONIC SIGNAL CHECK	0-05-05	0-0-0	0-0-0	0	0	0	INSIDE		0-00-37			0-00-37	
6	FLASH-DOWN RETURN TO NEXT PHASE REFERENCE TABLE 17	0-04-04	0-0-0	0-0-0	0	0	0	INSIDE		0-00-24			0-00-24	

1/ Use with TABLE LVII  
 2/ Forward radome compartment  
 3/ Guidance and control and avionics compartment  
 4/ (B) Ambient Day



MIL-HDBK-781

TABLE LX. Composite test cycle profile example timeline - mission profile for the high-low-high test cycle <sup>1/</sup> (Continued)

ITEM NO	CYCLE AND PHASE NO (REF. PARAGR. 139)	TEST CYCLE EVENT AND CONDITION DESCRIPTIONS REFERENCE TABLE	TEST SEQUENCE, SEQUENCE DESCRIPTION		HUMIDITY AND ALTITUDE PROFILE		ENVIRONMENTAL STRESS PHASING					VIBRATION PROFILE					
			EACH CYCLE TOTAL TEST ACUMULATED CYCLE CLOCK TIME (HRS-MIN-SEC)	INDIVIDUAL TEST CYCLE ENVIRONMENTAL TIME (HRS-MIN-SEC)	START	DURATION	HUMIDITY		ALTITUDE		SCORE RATE OF CHANGE (PER CENT)	SPECTRUM NO. FAILURE (HRS)	VIBRATION FACTOR (G-RMS 1000)	W <sub>0</sub>	W <sub>1</sub>	TIME DURATION OF START BUFFER (HRS-MIN-SEC)	TIME DURATION OF EVENT (HRS-MIN-SEC)
							% RH (LS)	START (FEET)	END (FEET)	START (PERCENT)							
0		PHASE LAUNCH	0-00-00	0-0-0													
1 (1)		PHASE ALTITUDE/ PHASE SPEED	0-01-01	0-1-1													
2 (1)		ENGINE BURN-OUT	0-04-04	0-3-3													
3 (1)		RECOVERY MANEUVER	0-04-41	0-0-37													
4 (1)		PARACHUTE COMPARTMENT TEMPERATURE	0-05-05	0-0-24													
5 (1)		ELECTRICAL SIGNAL CHECK	0-05-45	0-0-37													
6		SPLASH-DOWN RETURN TO EARTH PHASE IN FREE FLIGHT CYCLE (TABLE 87)	0-04-04	0-0-24													

UNCONTROLLED

<sup>1/</sup> Use with TABLE I.VII

<sup>2/</sup> Forward radome compartment

<sup>3/</sup> Guidance and control and avionics compartment

<sup>4/</sup> [A, B, C] (Cold Ambient, Hot) Days

<sup>5/</sup> Sea level

MAXIMUM VALUE MUST PRODUCE A W<sub>0</sub> (MINIMUM) EQUAL TO 0.01 AND W<sub>1</sub> (MINIMUM) EQUAL TO 0.040 OR THESE W<sub>0</sub> AND W<sub>1</sub> VALUES WILL BE USED INDEPENDENTLY.

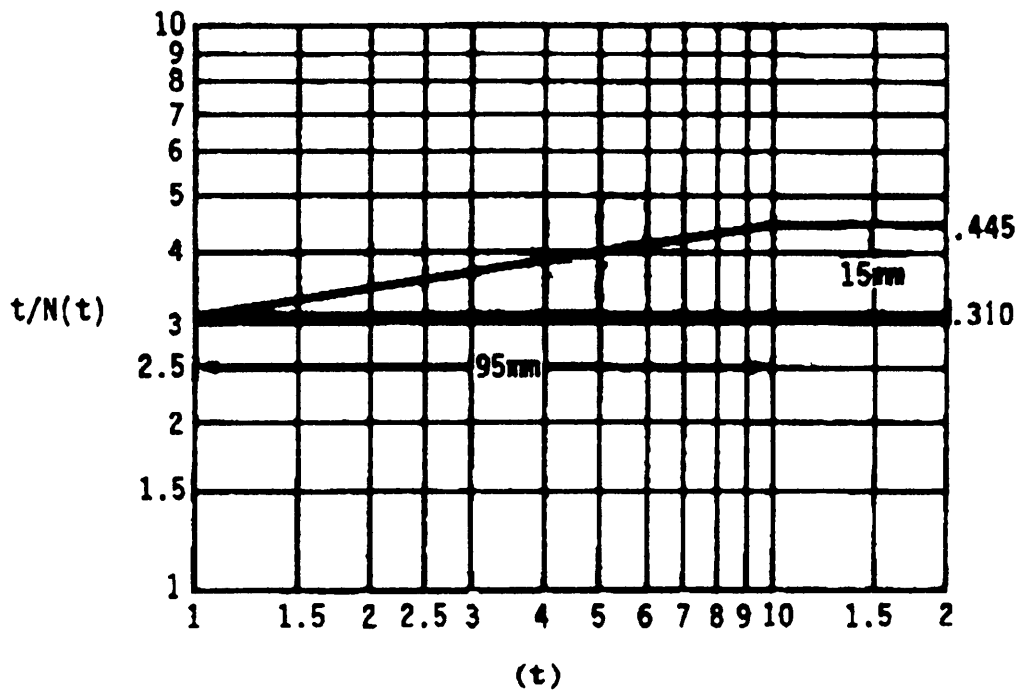

FIGURE 1. Duane Plot

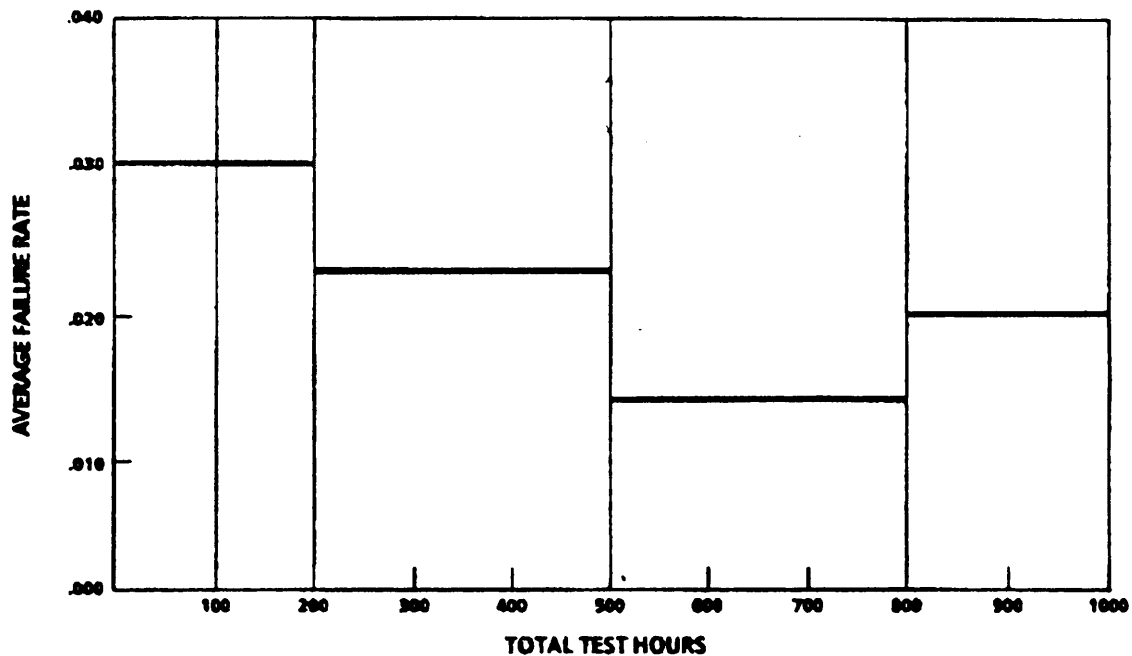

FIGURE 2. Interval plot of example data.

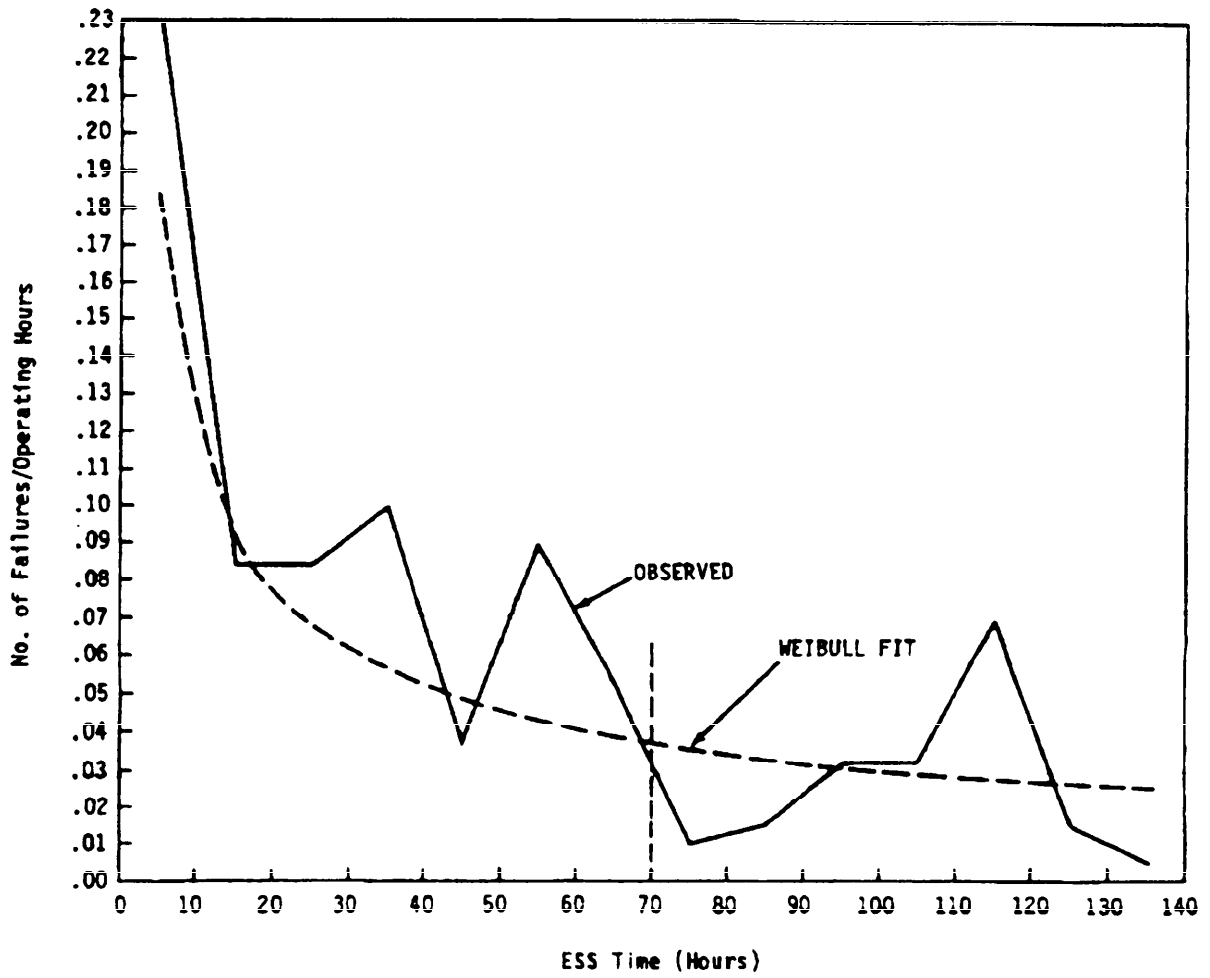

FIGURE 3. Graphical data plot of ESS

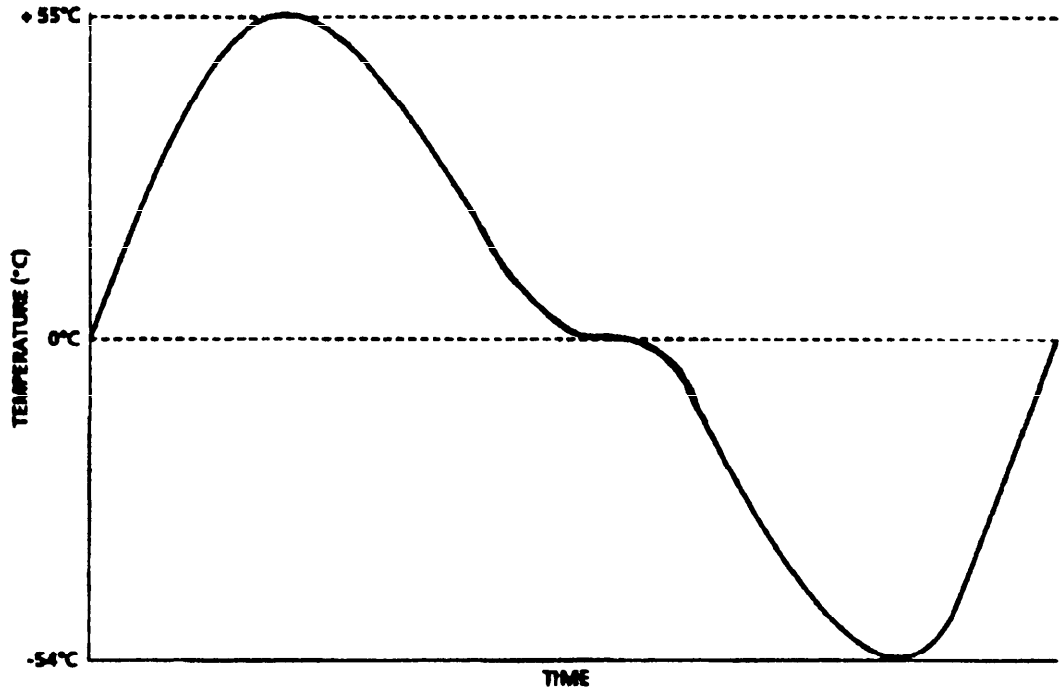

FIGURE 4. Typical thermal stress cycle

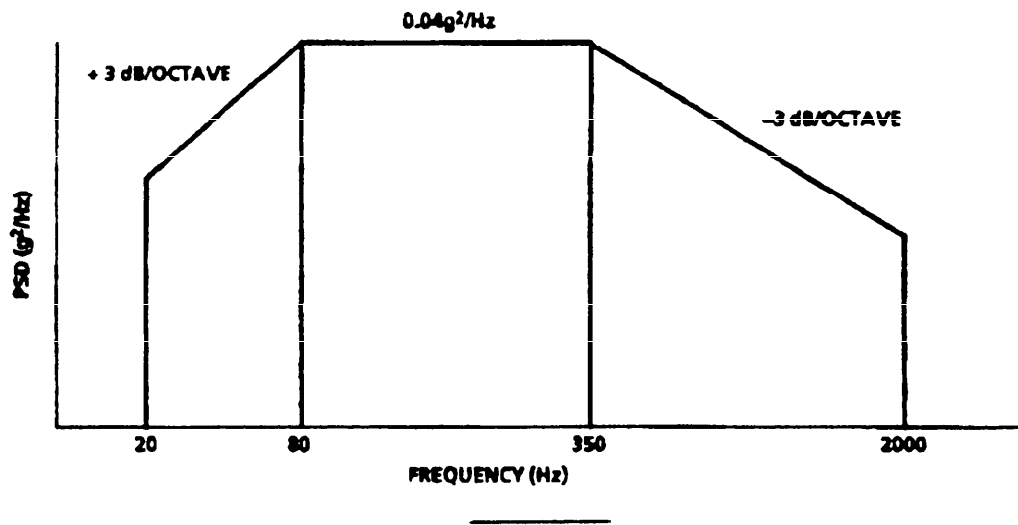

FIGURE 5. Vibration stress.

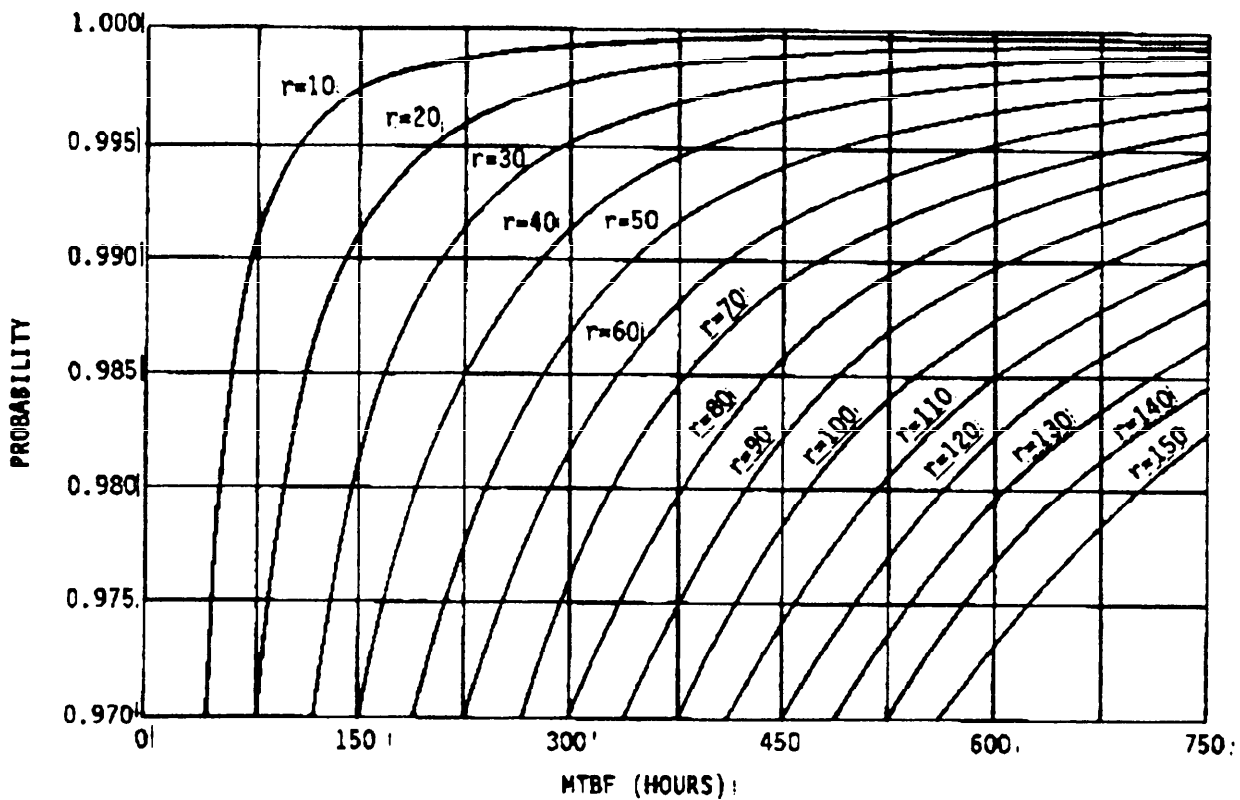

FIGURE 6. MTBF assurance test (curve 1).

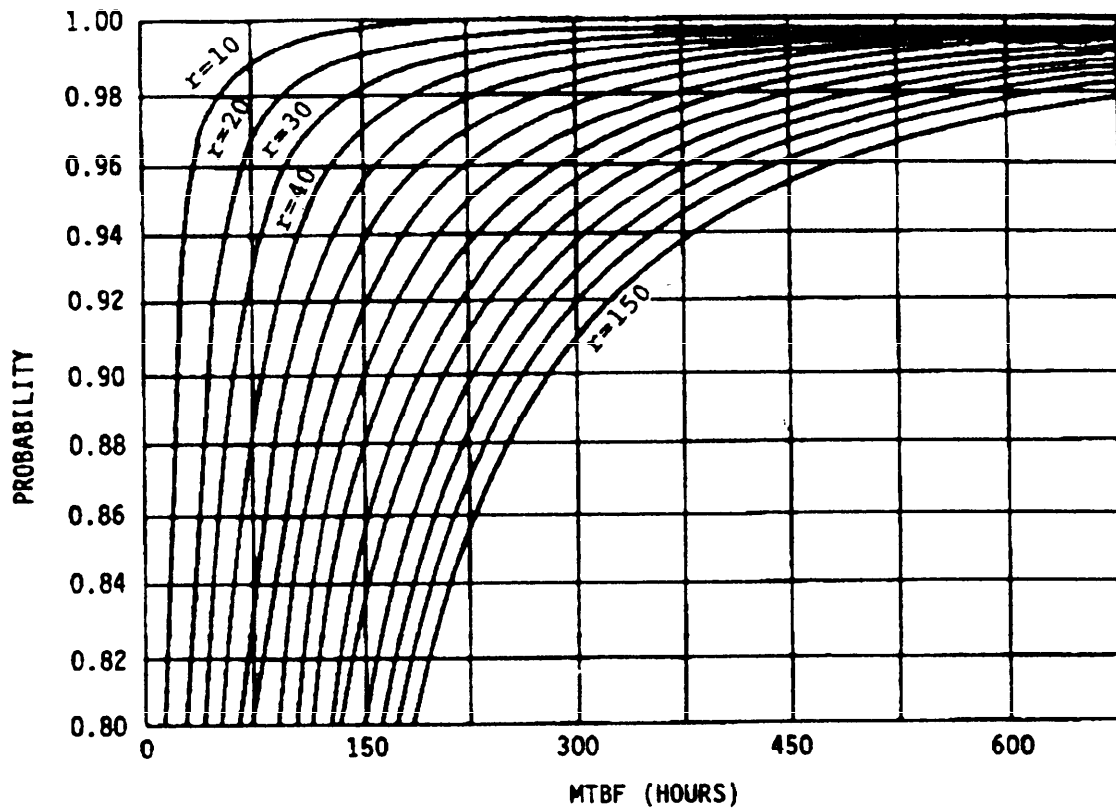

FIGURE 7. MTBF assurance test (curve 2)

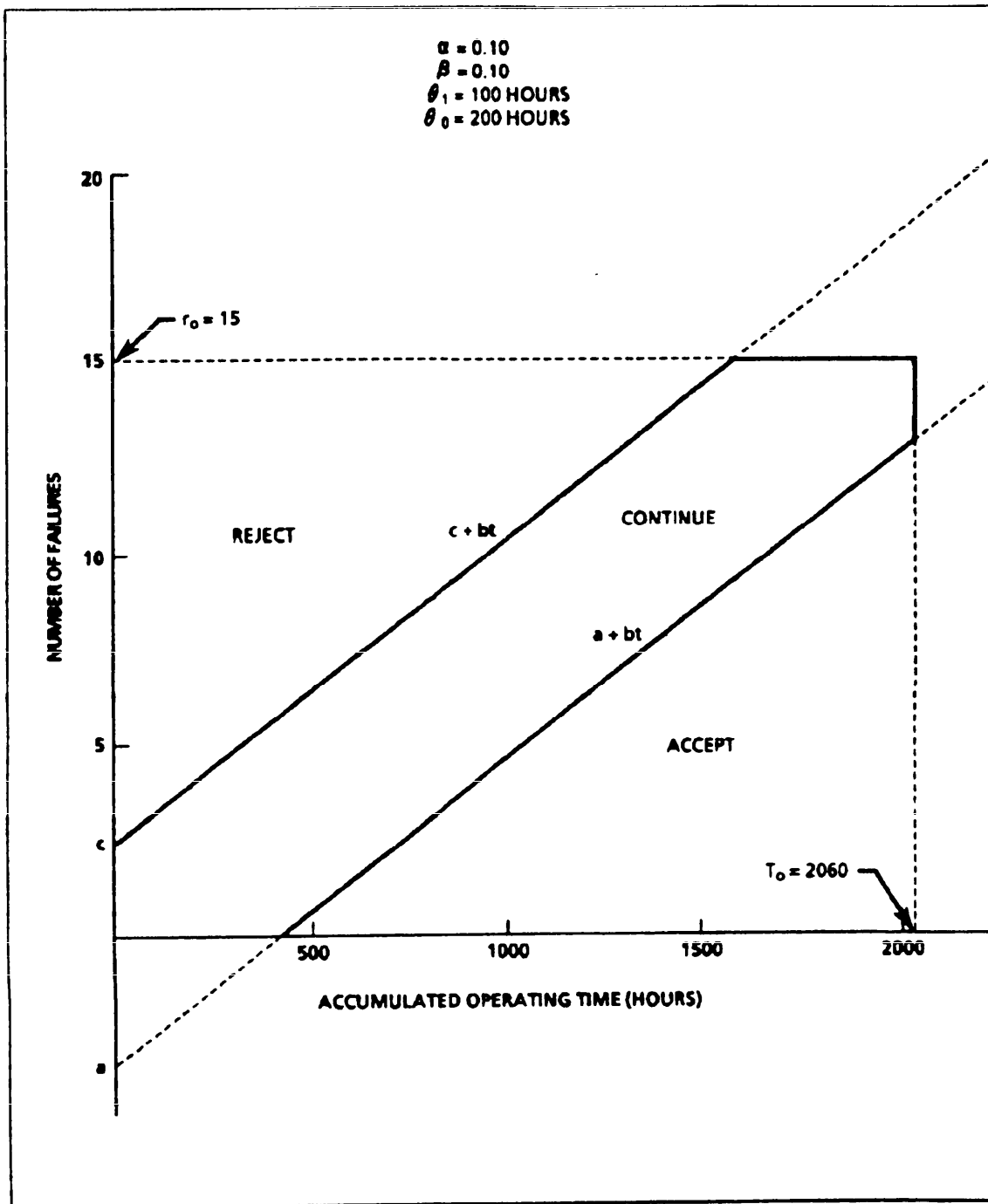
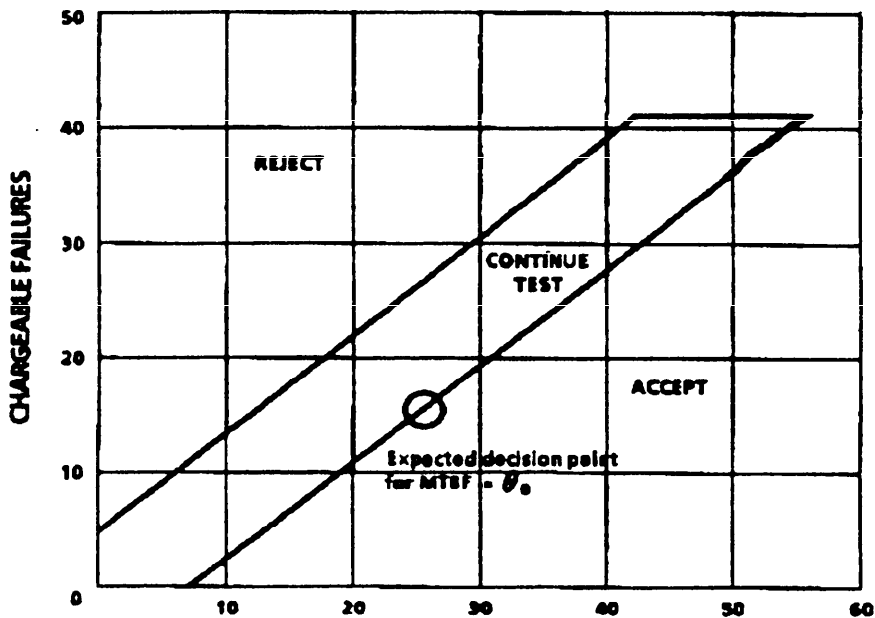

FIGURE 8. Probability ratio sequential test (example).

Decision Risks (Nominal) 10 Percent  
 Discrimination Ratio (d) 1.5 : 1



TOTAL TEST TIME (IN MULTIPLES OF LOWER TEST MTBF,  $\theta_1$ )<sup>1</sup>

Chargeable failures	Standardized termination time, $t^2$		Chargeable failures	Standardized termination time, $t^2$	
	Reject at $t_R \leq$	Accept at $t_A \geq$		Reject at $t_R \leq$	Accept at $t_A \geq$
0	N/A	6.95	21	18.50	32.49
1	N/A	8.17	22	19.80	33.70
2	N/A	9.38	23	21.02	34.92
3	N/A	10.60	24	22.23	36.13
4	N/A	11.80	25	23.45	37.35
5	N/A	13.03	26	24.66	38.57
6	0.34	14.25	27	25.88	39.78
7	1.56	15.46	28	27.07	41.00
8	2.78	16.69	29	28.31	42.22
9	3.9g	17.90	30	29.53	43.43
10	5.20	19.11	31	30.74	44.65
11	6.42	20.33	32	31.96	45.86
12	7.64	21.54	33	33.18	47.08
13	8.86	22.76	34	34.39	48.30
14	10.07	23.98	35	35.61	49.50
15	11.29	25.19	36	36.82	49.50
16	12.50	26.41	37	38.04	49.50
17	13.72	27.62	38	39.26	49.50
18	14.94	28.64	39	40.47	49.50
19	16.15	30.06	40	41.6g	49.50
20	17.37	31.27	41	49.50	N/A

Accept-reject criteria

<sup>1</sup> Total test time is the summation of operating time of all units included in test sample.

<sup>2</sup> To determine the actual termination time, multiply the standardized termination time (t) by the lower test MTBF( $\theta_1$ )

FIGURE 9. Test Plan I-D.

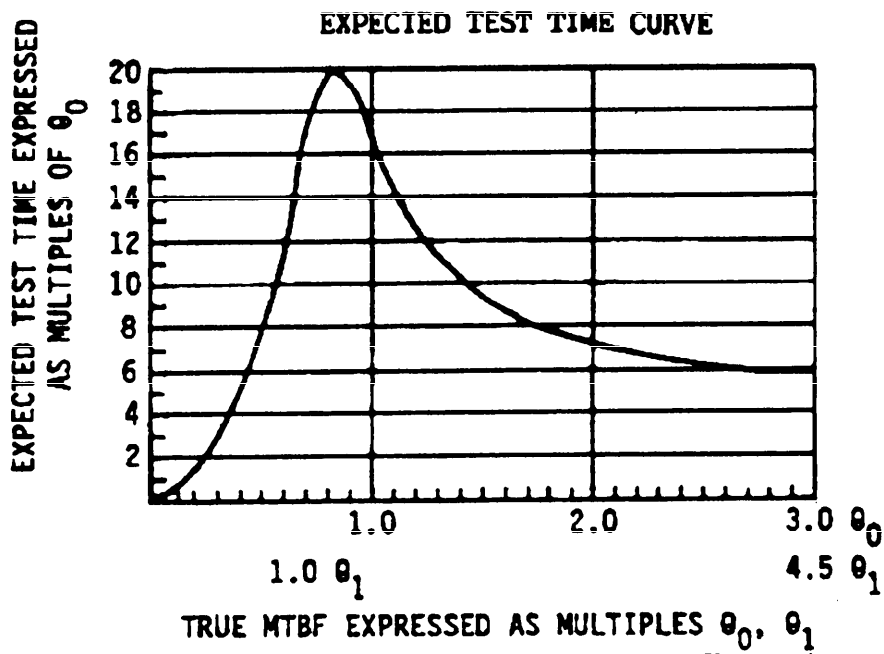
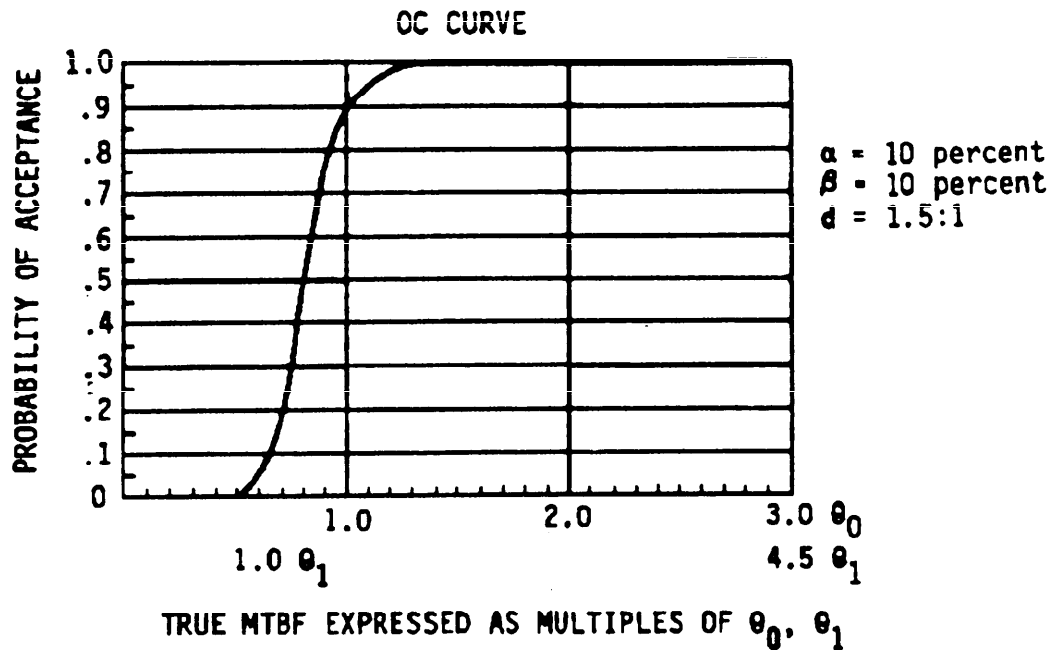
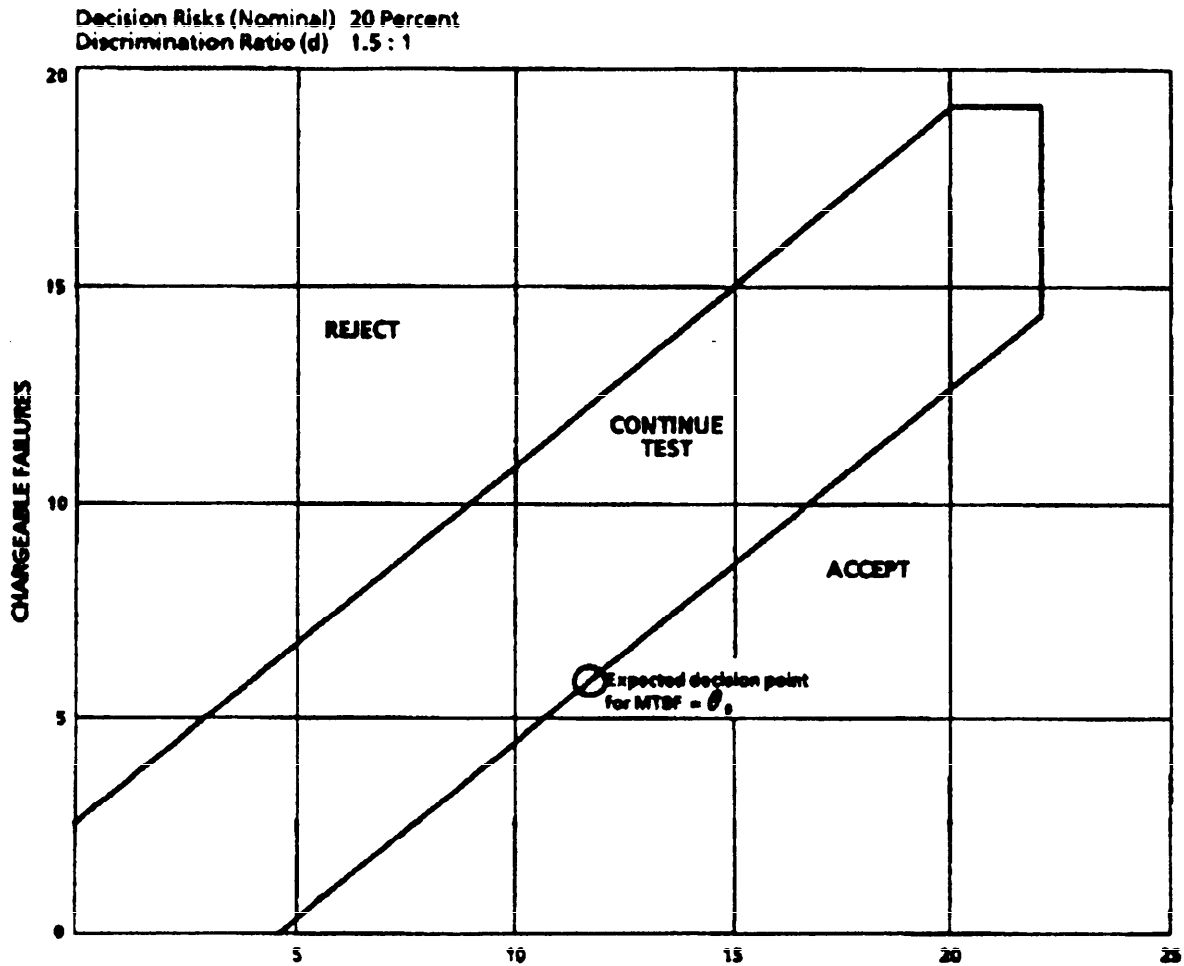

FIGURE 9. Test Plan I-D (Continued)



TOTAL TEST TIME (IN MULTIPLES OF LOWER TEST MTBF,  $\theta_1$ )<sup>1/2</sup>

Chargeable failures	Standardized termination time, $t^2$		Chargeable failures	Standardized termination time, $t^2$	
	Reject at $t_R \leq$	Accept at $t_A \geq$		Reject at $t_R \leq$	Accept at $t_A \geq$
0	N/A	4.19	10	8.76	16.35
1	N/A	5.40	11	9.98	17.57
2	N/A	6.62	12	11.19	18.73
3	.24	7.83	13	12.41	19.99
4	1.46	9.05	14	13.62	21.21
5	2.67	10.26	15	14.84	21.90
6	3.90	11.49	16	16.05	21.90
7	5.12	12.71	17	17.28	21.90
8	6.33	13.92	18	18.50	21.90
9	7.55	15.14	19	21.90	N/A

Accept-reject criteria

<sup>1</sup> Total test time is the summation of operating time of all units included in test sample.

<sup>2</sup> To determine the actual termination time~ multiply the standardized termination time (t) by the lower test MTBF ( $\theta_1$ )

FIGURE 10. Test Plan II-D.

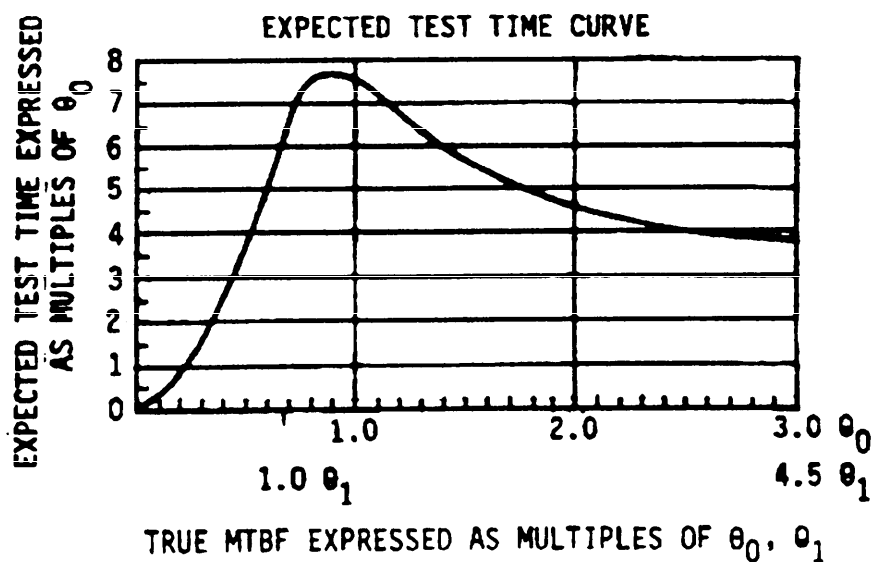
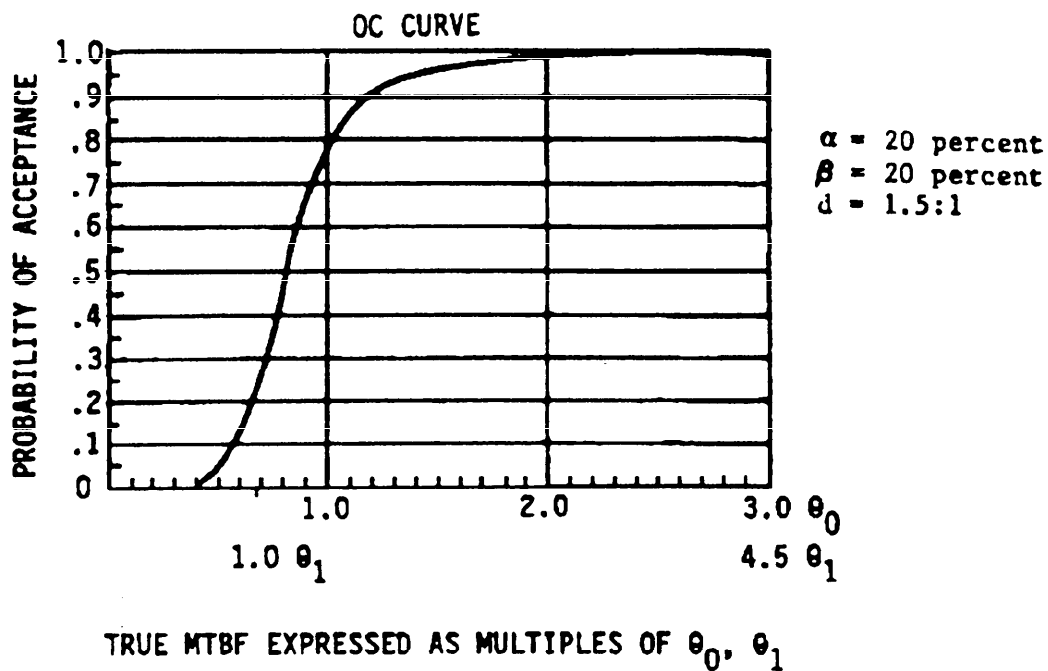
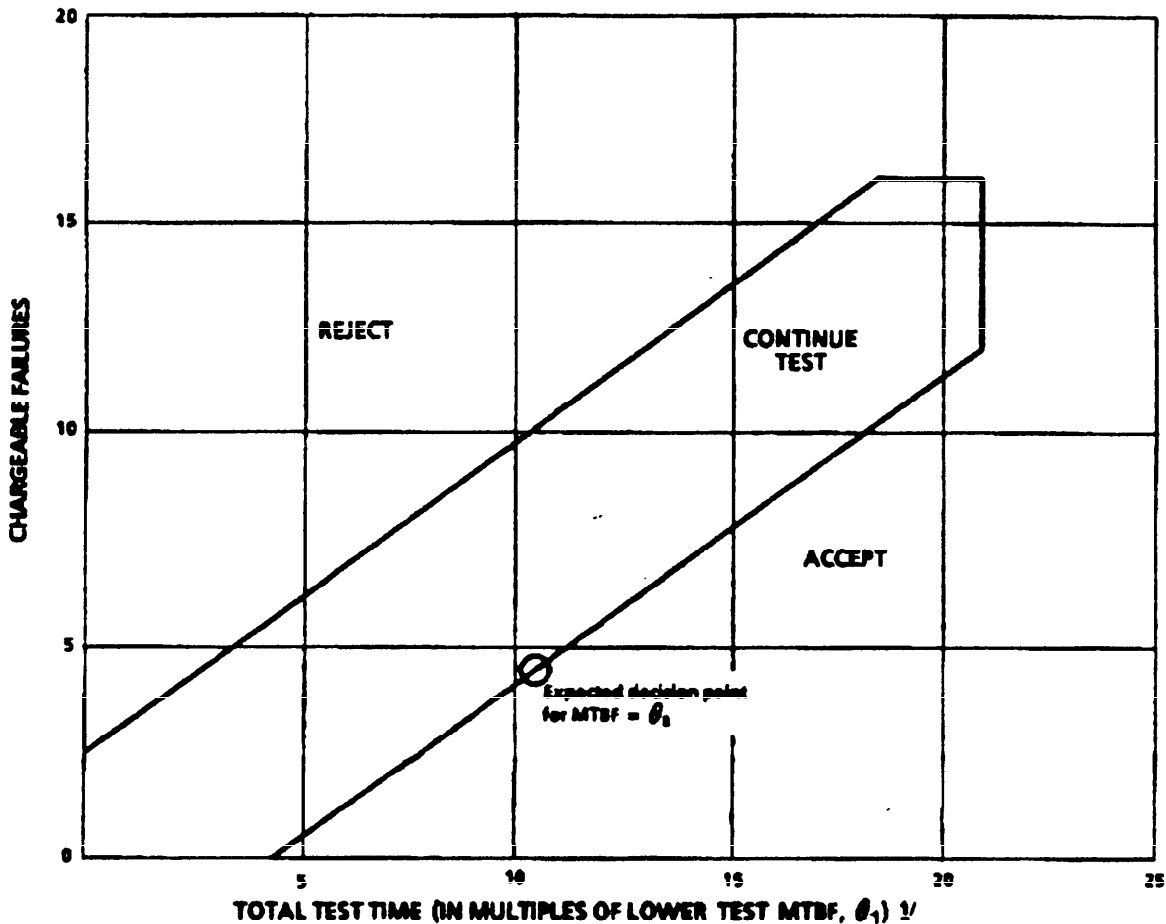

FIGURE 10. Test Plan II-D (Continued)

Decision Risks (Nominal) 10 Percent  
 Discrimination Ratio (d) 2.0 : 1



TOTAL TEST TIME (IN MULTIPLES OF LOWER TEST MTBF,  $\theta_1$ )<sup>1/</sup>

Chargeable failures	Standardized termination time, $t^2$		Chargeable failures	Standardized termination time, $t^2$	
	Reject at $t_R \leq$	Accept at $t_A \geq$		Reject at $t_R \leq$	Accept at $t_A \geq$
0	N/A	4.40	9	9.02	16.88
1	N/A	5.79	10	10.40	18.26
2	N/A	7.18	11	11.79	19.65
3	.70	8.56	12	13.18	20.60
4	2.08	9.94	13	14.56	20.60
5	3.48	11.34	14	15.94	20.60
6	4.86	12.72	15	17.34	20.60
7	6.24	14.10	16	20.60	N/A
8	7.63	15.49			

Accept-Reject criteria

<sup>1/</sup> Total test time is the summation of operating time of all units included in test sample.

<sup>2/</sup> To determine the actual termination time, multiply the standardized termination time (t) by the lower test MTBF ( $\theta_1$ )

FIGURE 11. Test Plan III-D.

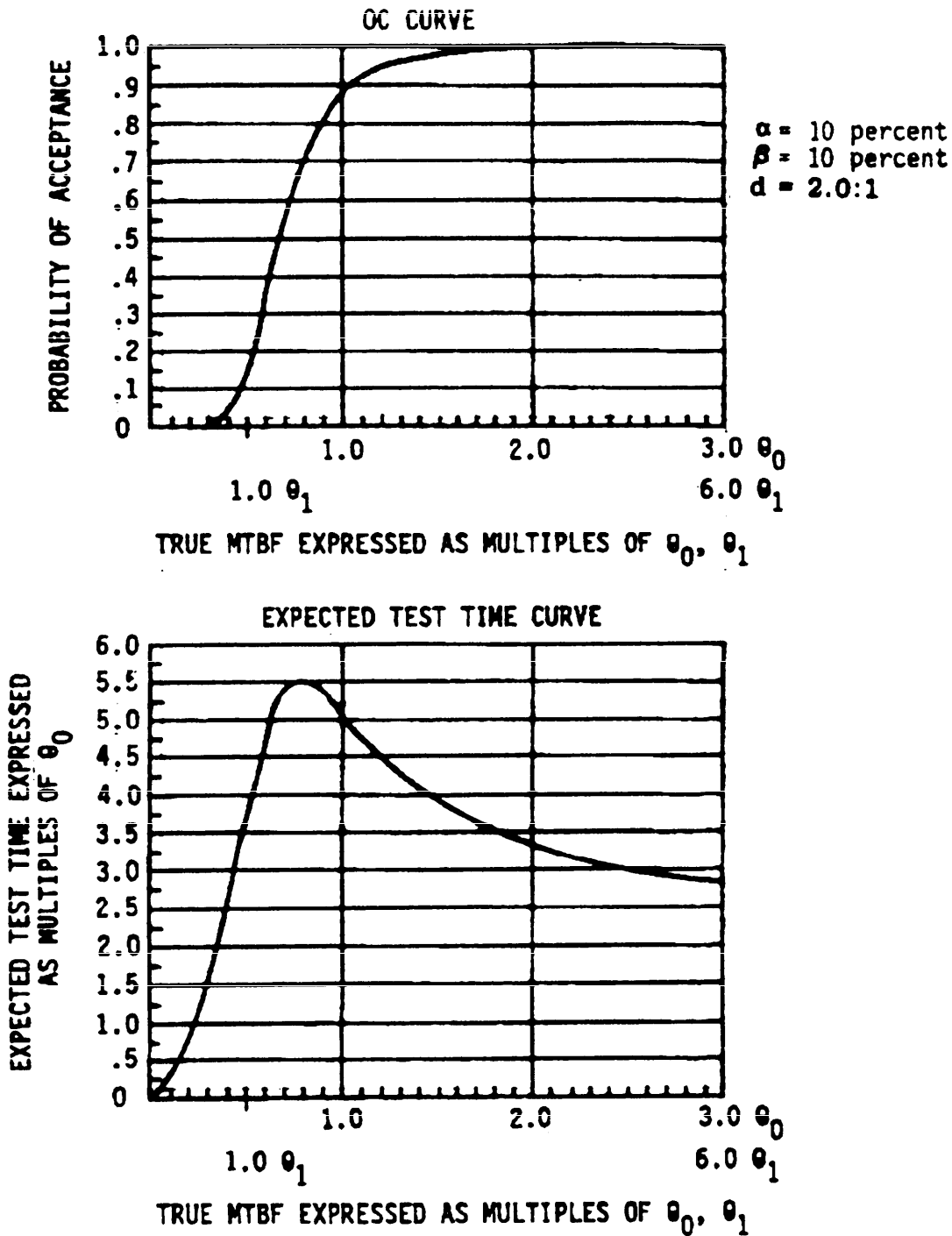
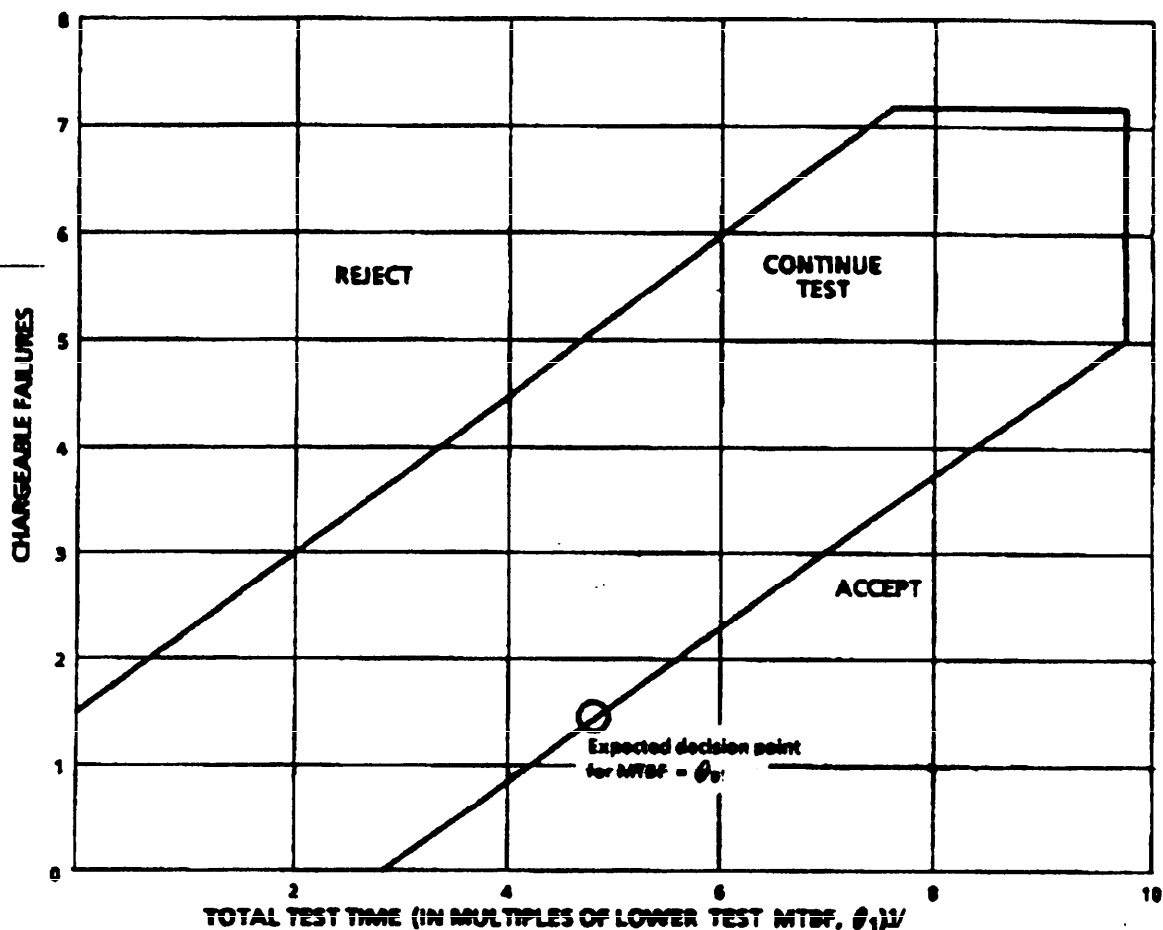

FIGURE 11. Test Plan III-D (Continued)

Decision Risks (Nominal) 20 Percent  
 Discrimination Ratio (d) 2.0 : 1



TOTAL TEST TIME (IN MULTIPLES OF LOWER TEST MTBF,  $\theta_1$ )<sup>1</sup>

Chargeable failures	Standardized termination time, $t^2$	
	Reject at $t_R \leq$	Accept at $t_A \geq$
0	N/A	2.80
1	N/A	4.18
2	.70	5.58
3	2.08	6.96
4	3.46	8.34
5	4.86	9.74
6	6.24	9.74
7	7.62	9.74
8	9.74	N/A

Accept-reject criteria

<sup>1</sup> Total test time is the summation of operating time of all units included in test sample

<sup>2</sup> To determine the actual termination time, multiply the standardized termination time (t) by the lower test MTBF ( $\theta_1$ )

FIGURE 12. Test Plan IV-D.

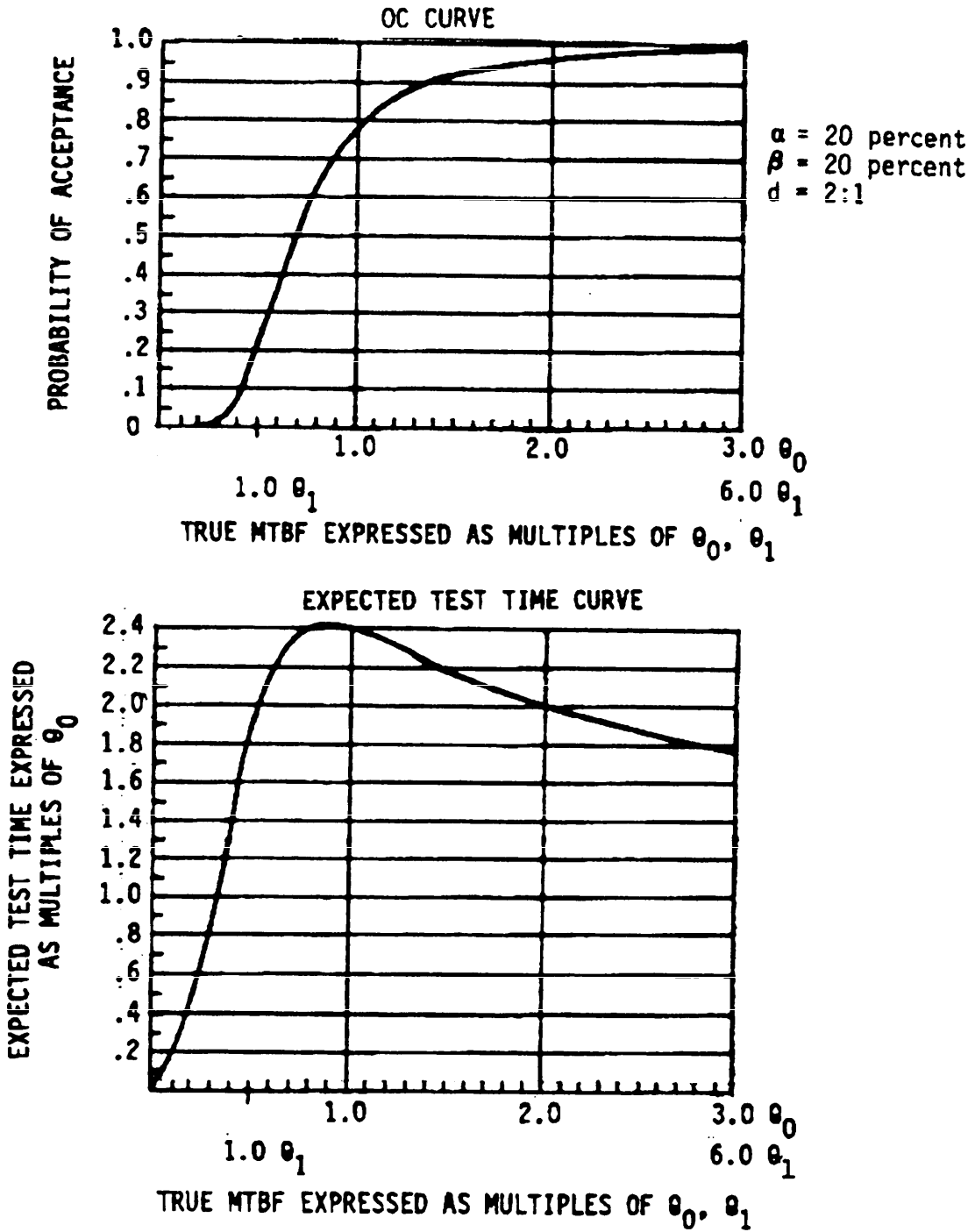
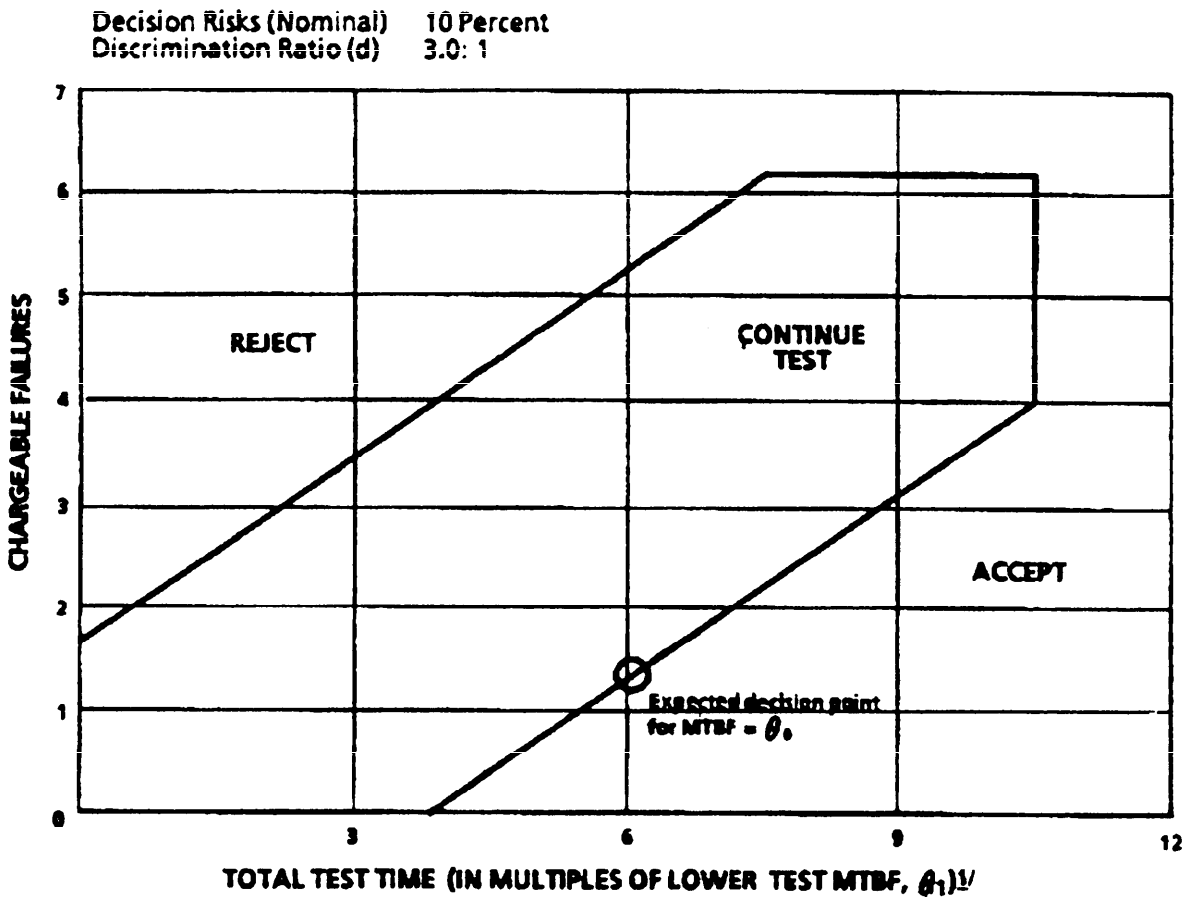

FIGURE 12. Test Plan IV-D (Continued)



TOTAL TEST TIME (IN MULTIPLES OF LOWER TEST MTBF  $\theta_1$ )<sup>2/</sup>

Chargeable failures	Standardized termination time, $t^2$	
	Reject at $t_R \leq$	Accept at $t_A \geq$
0	N/A	3.75
1	N/A	5.40
2	.57	7.05
3	2.22	8.70
4	3.87	10.35
5	5.52	10.35
6	7.17	10.35
7	10.35	N/A

Accept-reject criteria

<sup>1/</sup> Total test time is the summation of operating time of all units included in test sample.

<sup>2/</sup> To determine the actual termination time, multiply the standardized termination time (t) by the lower test MTBF ( $\theta_1$ )

FIGURE 13. Test Plan V-D

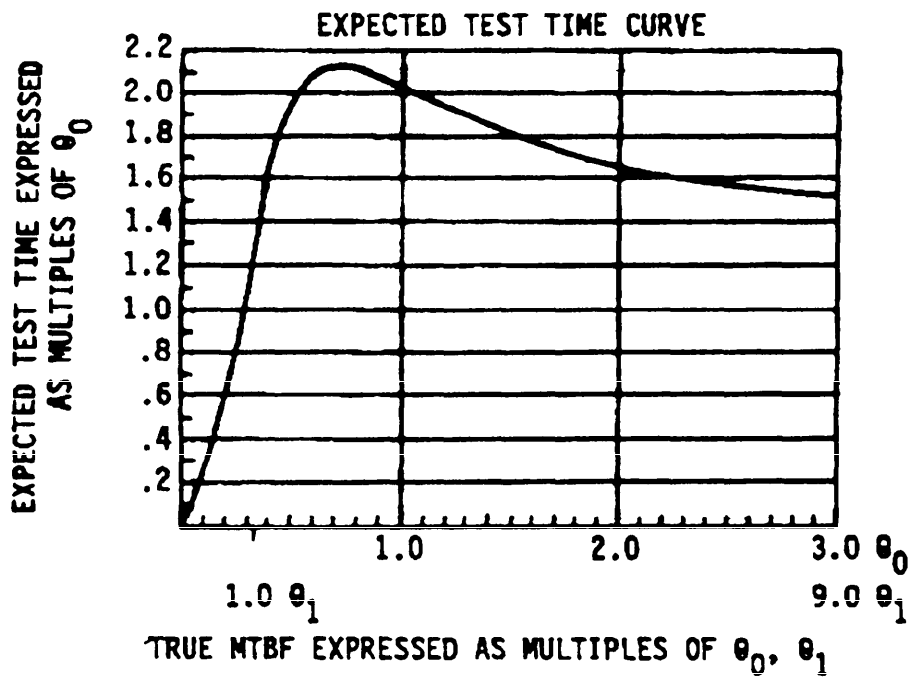
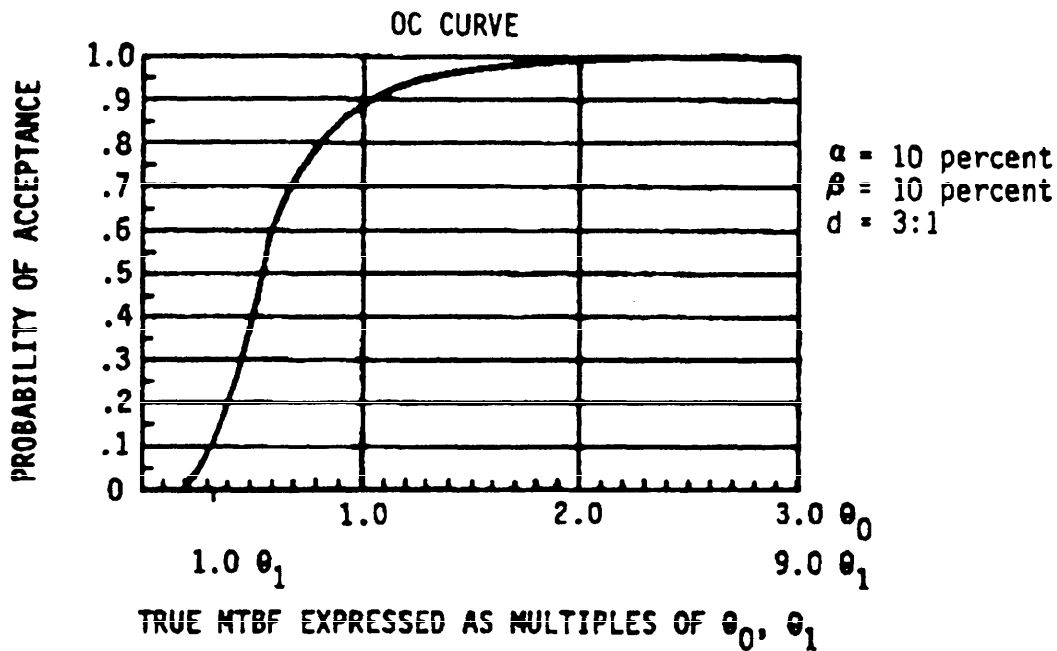
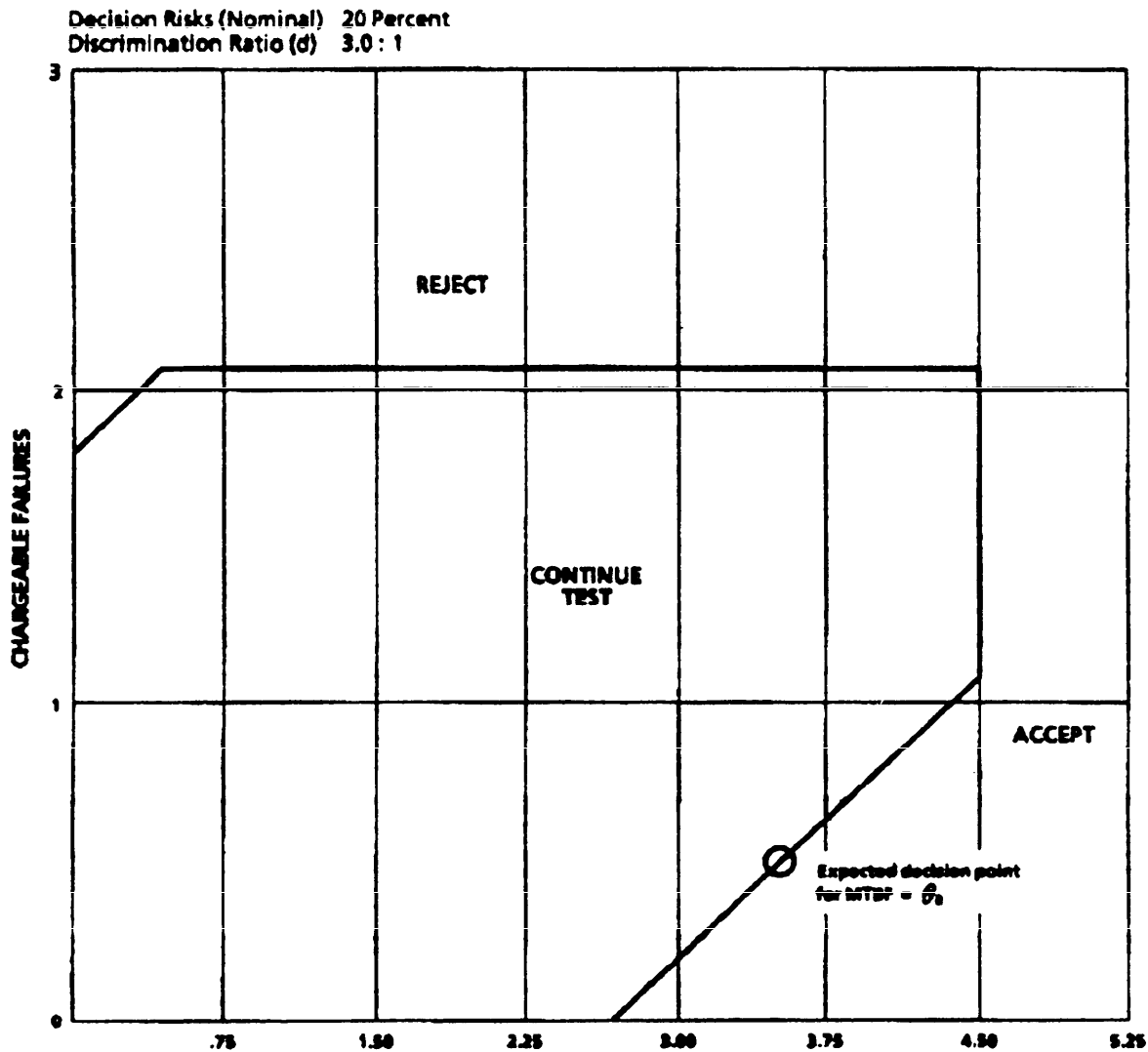

FIGURE 13. Test Plan V-D (Continued)



TOTAL TEST TIME (IN MULTIPLES OF LOWER TEST MTBF,  $\theta_1$ )<sup>2</sup>

Chargeable failures	Standardized termination time, $t^2$	
	Reject at $t_R \leq$	Accept at $t_A \geq$
0	N/A	2.67
1	N/A	4.32
2	.36	4.50
3	4.50	N/A

Accept-reject criteria

<sup>1</sup> Total test time is the summation of operating time of all units included in test sample.

<sup>2</sup> To determine the actual termination time, multiply the standardized termination time (t) by the lower test MTBF ( $\theta_1$ )

FIGURE 14. Test Plan VI-D.

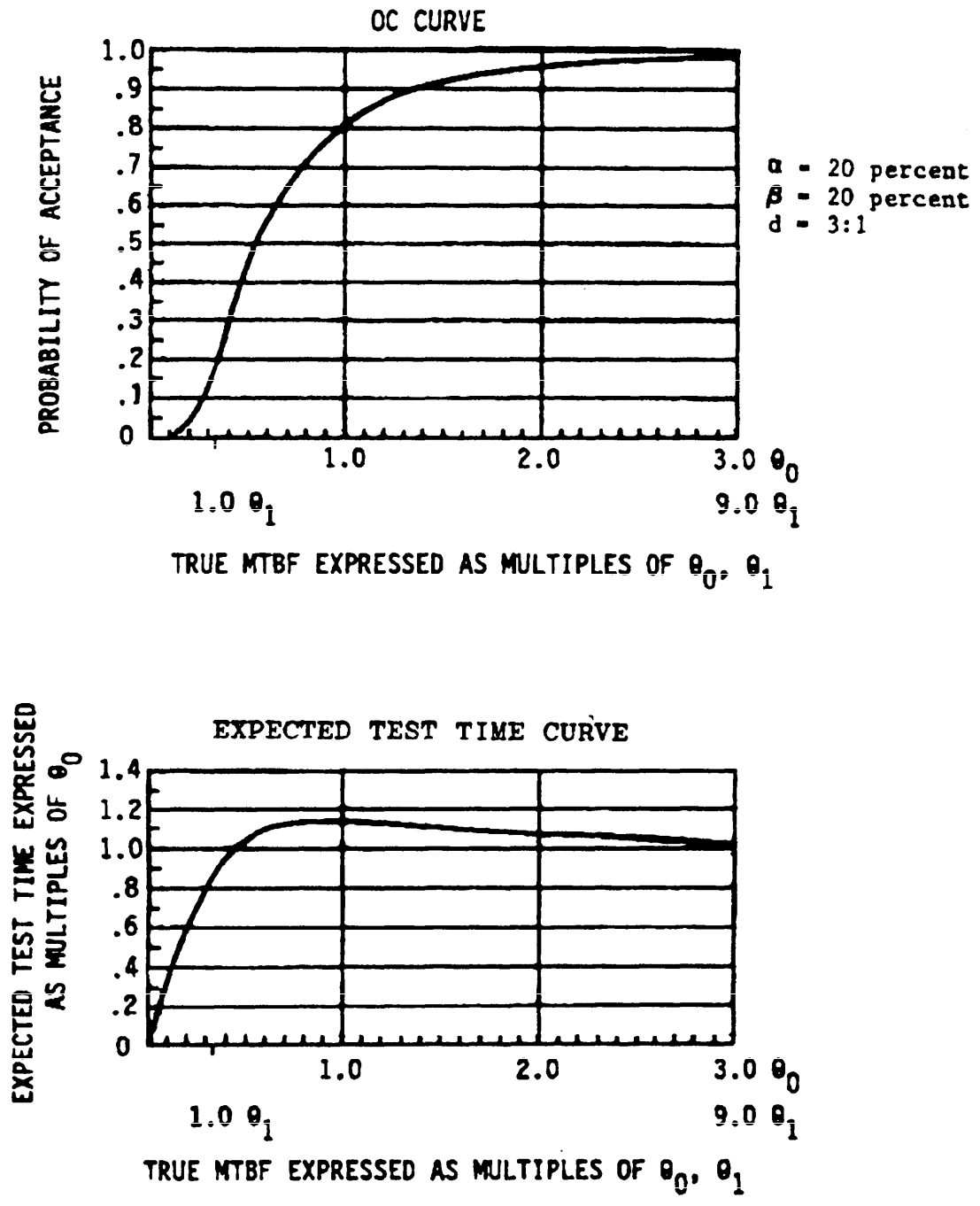
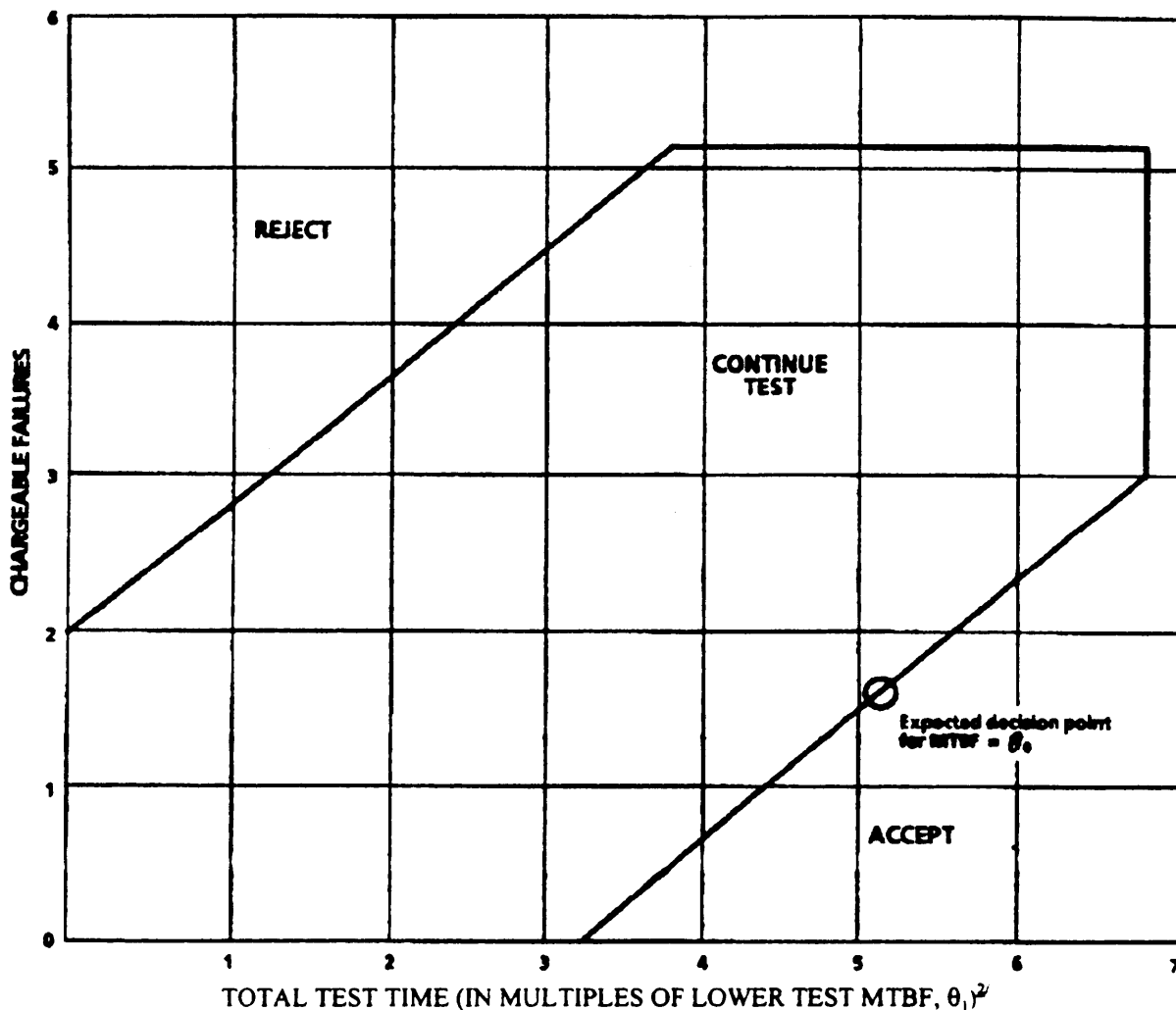

FIGURE 14. Test Plan VI-D (Continued)

Decision Risks (Nominal) 30 Percent  
 Discrimination Ratio (d) 1.5 : 1



Chargeable failures	Standardized termination time, $t^d$	
	Reject at $t_R \leq$	Accept at $t_A \geq$
0	N/A	3.15
1	N/A	4.37
2	N/A	5.58
3	1.22	6.80
4	2.43	6.80
5	3.65	6.80
6	6.80	N/A

Accept-reject criteria

<sup>1</sup> Total test time is the summation of operating time of all units included in test sample.

<sup>2</sup> To determine the actual termination time, multiply the standardized termination time (t) by the lower test MTBF ( $\theta_1$ ).

FIGURE 15. Test Plan VII-D.

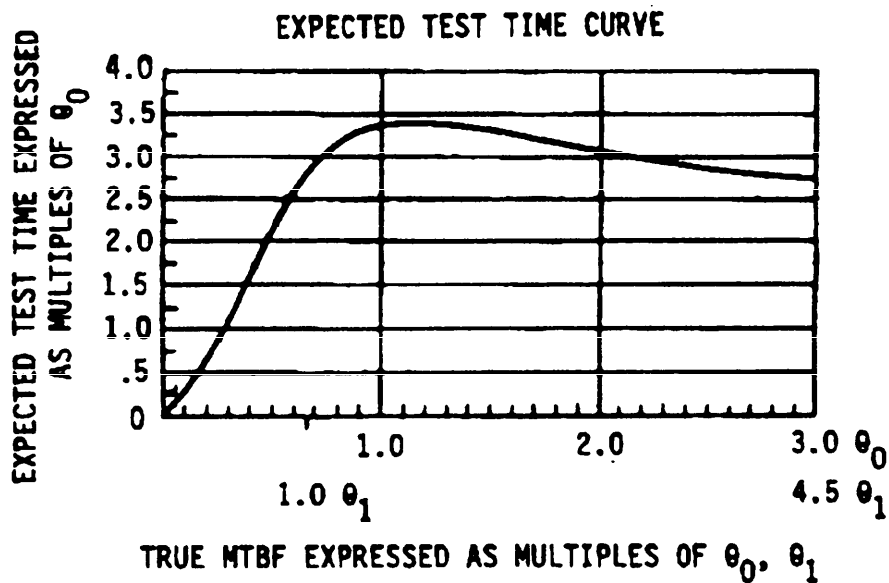
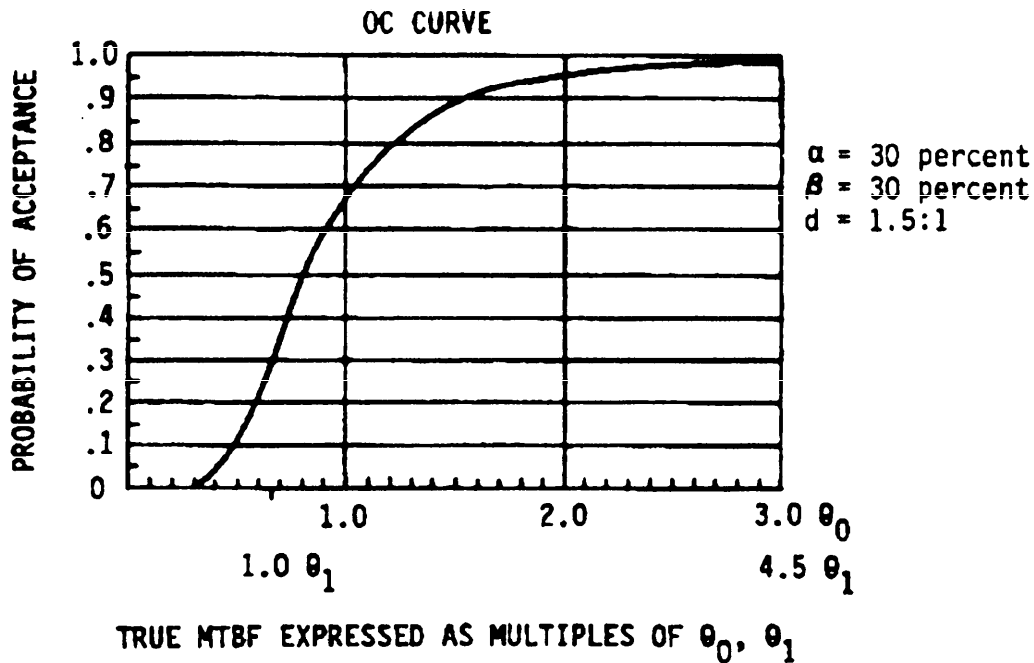
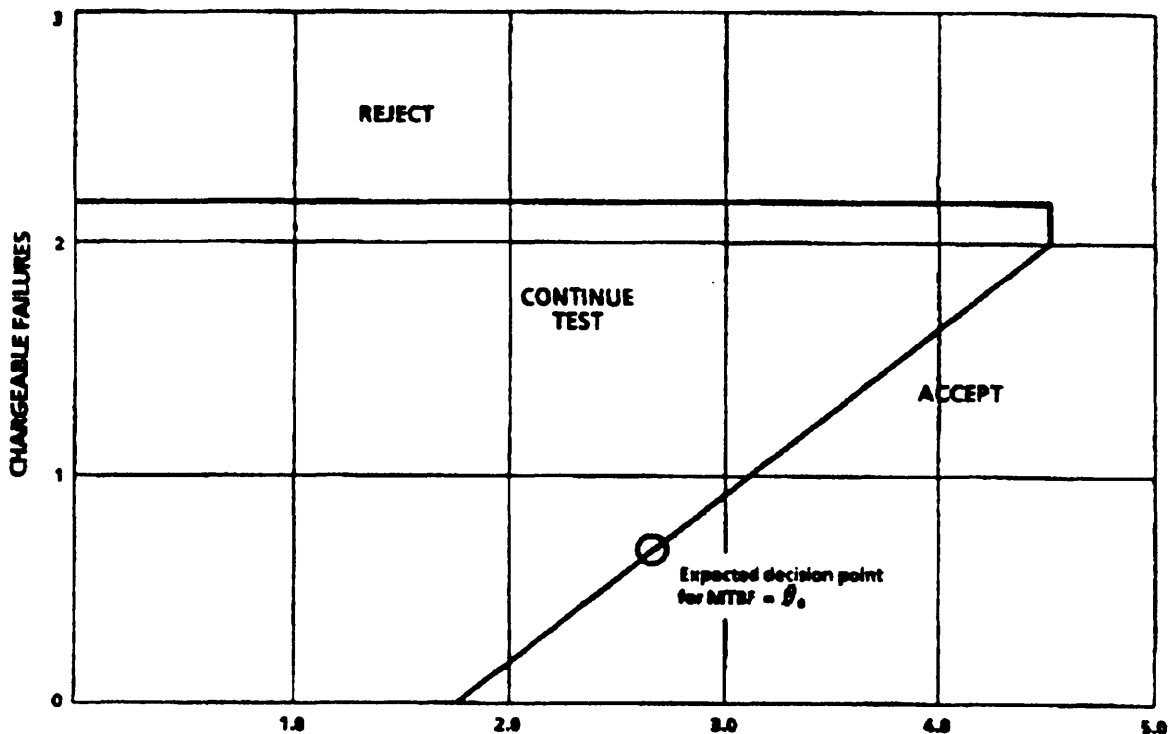

FIGURE 15. Test Plan VII-D (Continued)

Decision Risks (Nominal) 30 Percent  
 Discrimination Ratio (d) 2.0: 1



TOTAL TEST TIME (IN MULTIPLES OF LOWER TEST MTBF,  $\theta_1$ )<sup>2</sup>

Chargeable failures	Standardized termination time, $t^2$	
	Reject at $t_R \leq$	Accept at $t_A \geq$
0	N/A	1.72
1	N/A	3.10
2	N/A	4.50
3	4.50	N/A

Accept-reject criteria

<sup>1/</sup> Total test time is the summation of operating time of all units included in test sample.

<sup>2/</sup> To determine the actual termination time, multiply the standardized termination time (t) by the lower test MTBF ( $\theta_1$ ).

FIGURE 16. Test Plan VIII-D.

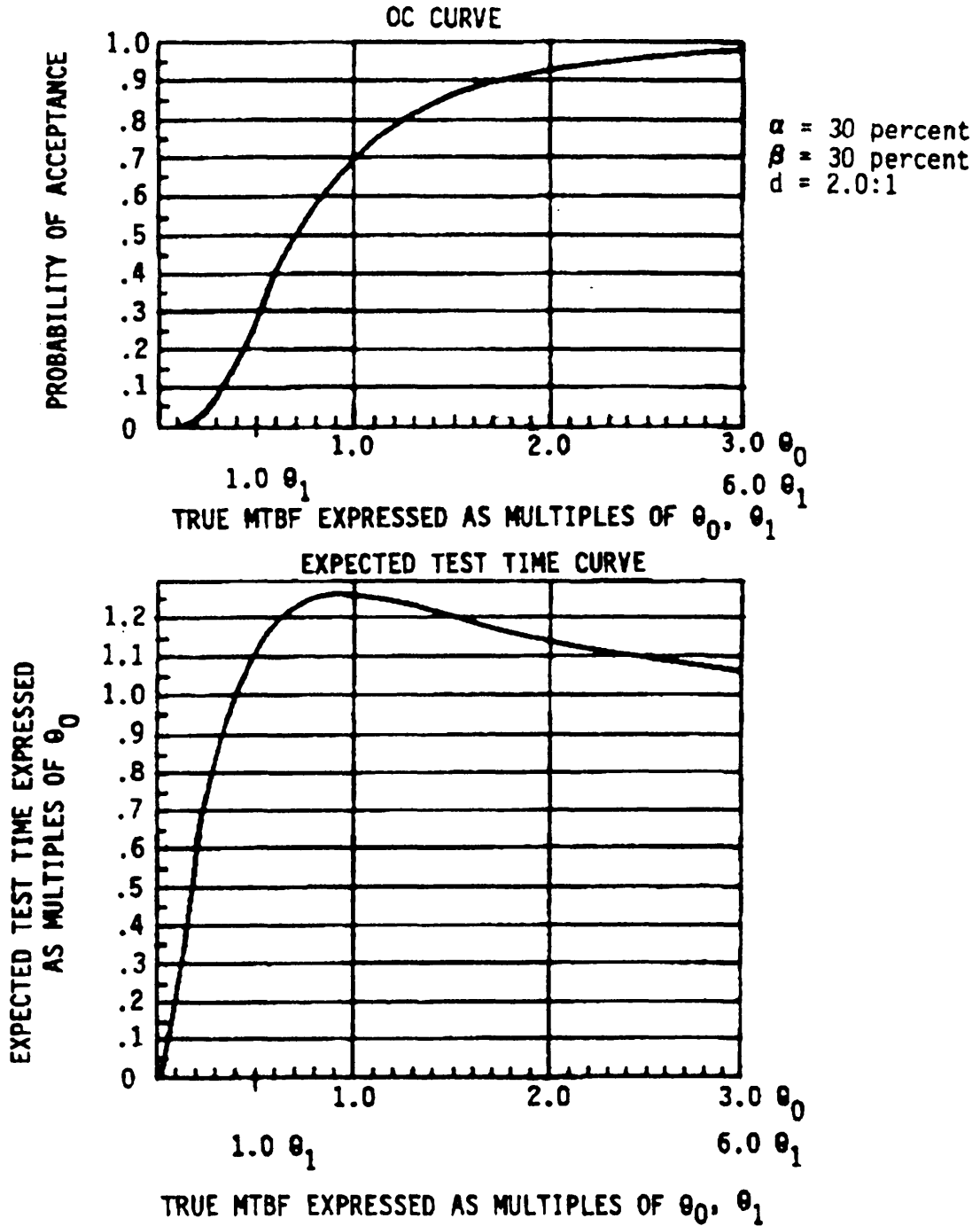

FIGURE 16. Test Plan VIII-D (Continued)

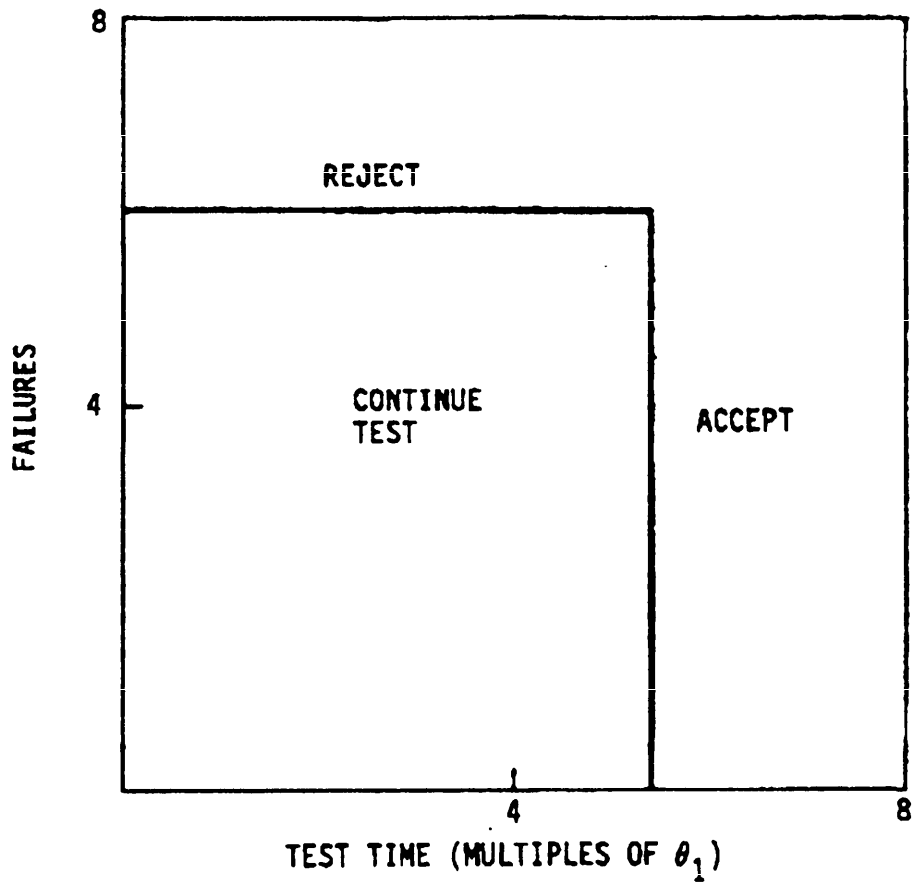
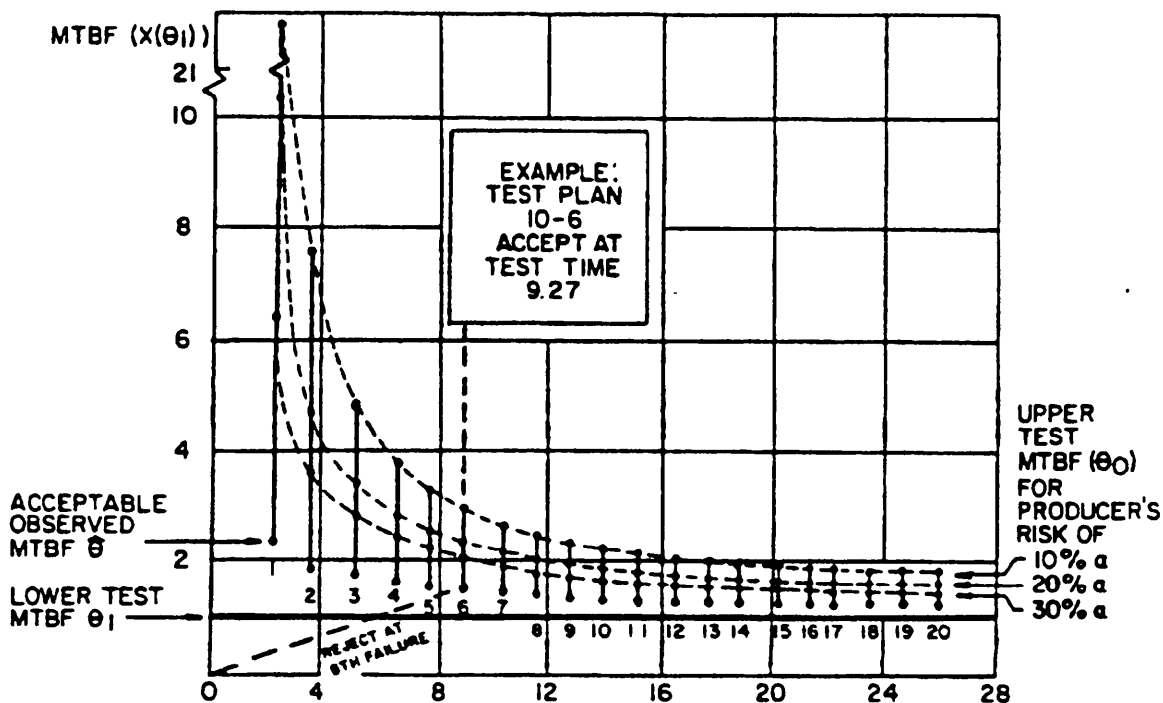

FIGURE 17. Fixed-duration test plan (example)

10% CONSUMER'S RISK ( $\beta$ ) TEST PLANS



TOTAL TEST TIME (IN MULTIPLES OF LOWER TEST MTBF,  $\theta_1$ )

TEST PLAN NUMBERS	NUMBER OF FAILURES		TOTAL TEST TIME (T) (MULTIPLES OF $\theta_1$ )	ACCEPTABLE (MULTIPLES OF $\theta_1$ )	DISCRIMINATION RATIO, ( $\theta_0/\theta_1$ ) FOR PRODUCER'S RISK		
	ACCEPTED	REJECTED			$\alpha=30\%$	$\alpha=20\%$	$\alpha=10\%$
10-1	0	T	2.30	2.30 +	6.46	10.32	21.85
10-2	1	2	3.89	1.94+	3.54	4.72	7.32
10-3	2	3	5.32	1.77 +	2.78	3.47	4.83
10-4	3	4	6.68	1.67+	2.42	2.91	3.83
10-5	4	5	7.99	1.59+	2.20	2.59	3.29
10-6	5	6	9.27	1.55 +	1.95	2.22	2.70
10-7	6	7	10.53	1.50+	1.95	2.22	2.70
10-8	7	8	11.77	1.47 +	1.86	2.11	2.53
10-9	8	9	12.99	1.43 +	1.80	2.02	2.39
10-10	9	10	14.21	1.42+	1.75	1.95	2.28
10-11	10	11	15.41	1.40+	1.70	1.89	2.19
10-12	11	12	16.60	1.38+	1.66	1.84	2.12
10-13	12	13	17.78	1.37+	1.63	1.79	2.00
10-14	13	14	18.96	1.35+	1.60	1.75	2.00
10-15	14	15	20.13	1.34 +	1.56	1.72	1.95
10-16	15	16	21.29	1.33 +	1.56	1.69	1.91
10-17	16	17	22.45	1.32+	1.54	1.67	1.87
10-18	17	18	23.61	1.31 +	1.52	1.62	1.84
10-19	18	19	24.75	1.30+	1.50	1.62	1.78
10-20	19	20	25.90	1.29+	1.48	1.60	1.78

FIGURE 18. 10 Percent Consumer's Risk ( $\beta$ ) Test Plans.

20% CONSUMER'S RISK ( $\beta$ ) TEST PLANS

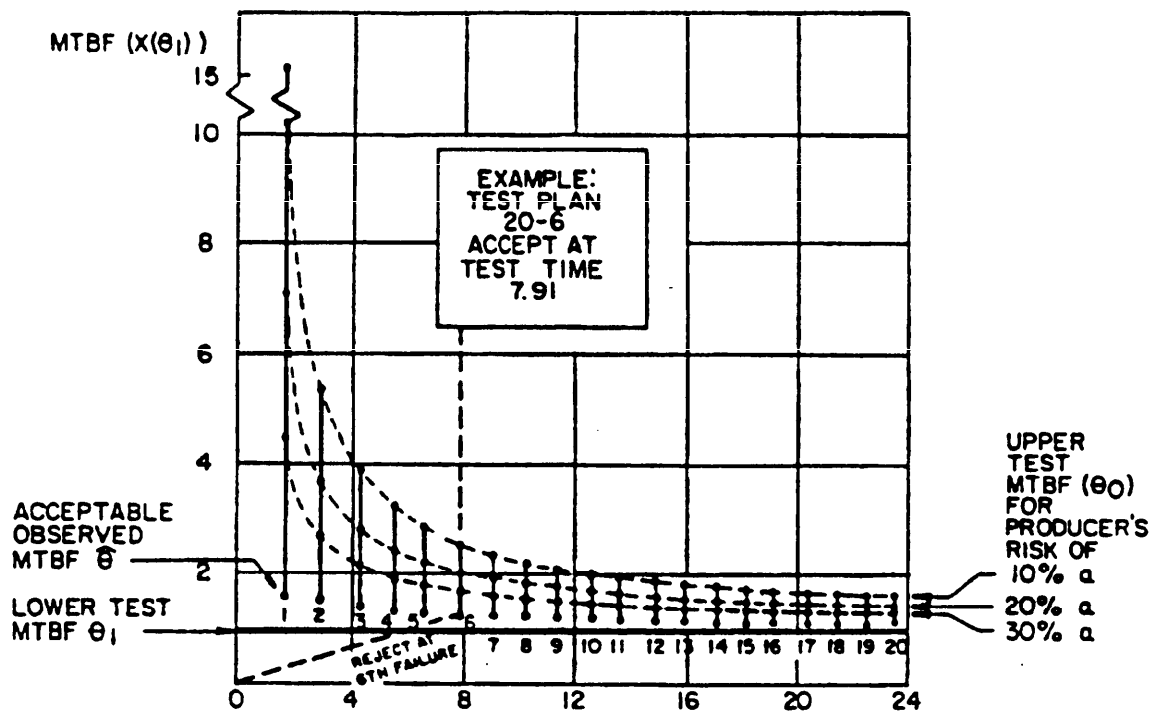

TOTAL TEST TIME (IN MULTIPLES OF LOWER TEST MTBF,  $\theta_1$ )

TEST PLAN NUMBERS	NUMBER OF FAILURES		TOTAL TEST TIME (T) (MULTIPLES OF $\theta_1$ )	ACCEPTABLE (MULTIPLES OF $\theta_1$ )	DISCRIMINATION RATIO, ( $\theta_0/\theta_1$ ) FOR PRODUCER'S RISK		
	ACCEPTED	REJECTED			$\alpha=30\%$	$\alpha=20\%$	$\alpha=10\%$
20-1	0	1	1.61	1.61+	4.51	7.22	15.26
20-2	1	2	2.99	1.50+	2.73	3.63	5.63
20-3	2	3	4.28	1.43+	2.24	2.79	3.88
20-4	3	4	5.51	1.38+	1.99	2.40	3.16
20-5	4	5	6.72	1.34+	1.85	2.17	2.76
20-6	5	6	7.91	1.32+	1.75	2.03	2.51
20-7	6	7	9.08	1.30+	1.68	1.92	2.33
20-8	7	8	10.23	1.28+	1.62	1.83	2.20
20-9	8	9	11.38	1.26+	1.57	1.77	2.09
20-10	9	10	12.52	1.25+	1.54	1.72	2.01
20-11	10	11	13.65	1.24+	1.51	1.67	1.94
20-12	11	12	14.78	1.23+	1.48	1.64	1.89
20-13	12	13	15.90	1.22+	1.46	1.60	1.84
20-14	13	14	17.01	1.21+	1.44	1.58	1.80
20-15	14	15	18.12	1.21+	1.42	1.55	1.76
20-16	15	16	19.23	1.20+	1.40	1.53	1.73
20-17	16	17	20.34	1.19+	1.39	1.51	1.70
20-18	17	18	21.44	1.19+	1.38	1.49	1.67
20-19	18	19	22.54	1.18+	1.37	1.48	1.65
20-20	19	20	23.63	1.18+	1.35	1.46	1.63

FIGURE 19. 20 Percent Consumer's Risk ( $\beta$ ) Test Plans.

30% CONSUMER'S RISK ( $\beta$ ) TEST PLANS

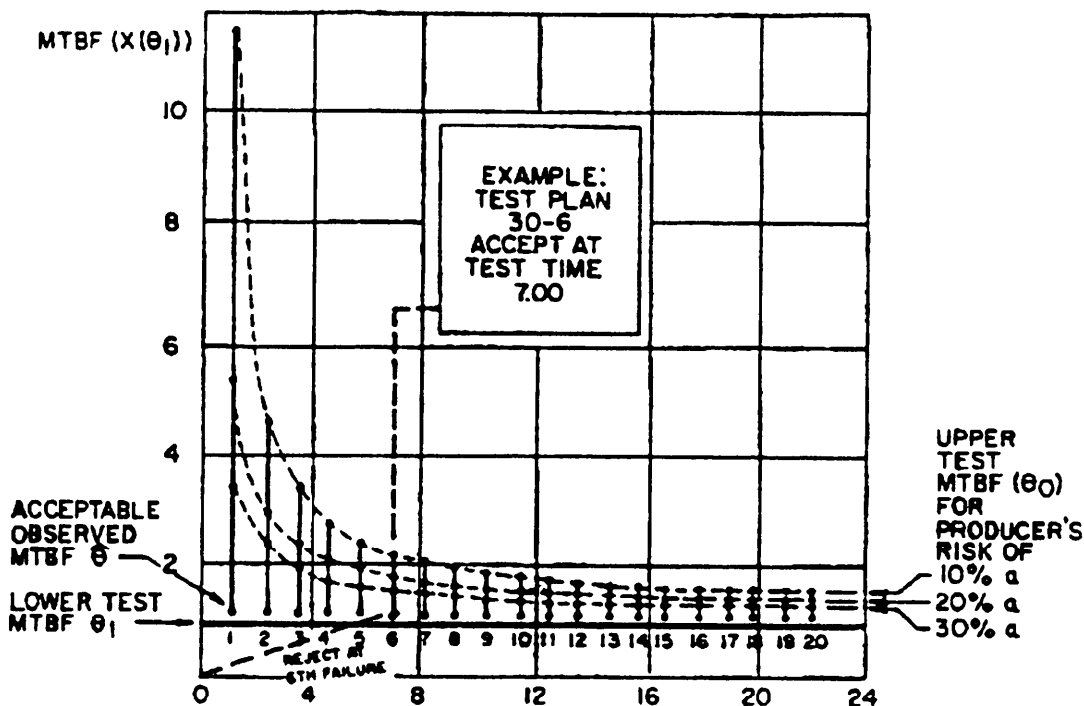

TOTAL TEST TIME (IN MULTIPLES OF LOWER TEST MTBF,  $\theta_1$ )

TEST PLAN NUMBERS	NUMBER OF FAILURES		TOTAL TEST TIME (T) (MULTIPLES OF $\theta_1$ )	ACCEPTABLE (MULTIPLES OF $\theta_1$ )	DISCRIMINATION RATIO, ( $\theta_0/\theta_1$ ) FOR PRODUCER'S RISK		
	ACCEPTED	REJECTED			$\alpha=30\%$	$\alpha=20\%$	$\alpha=10\%$
30-1	0	1	1.20	1.20+	3.37	5.39	11.43
30-2	1	2	2.44	1.22+	2.22	2.96	4.59
30-3	2	3	3.62	1.20+	1.89	2.35	3.28
30-4	3	4	4.76	1.19+	1.72	2.07	2.73
30-5	4	5	5.89	1.18+	1.62	1.91	2.43
30-6	5	6	7.00	1.17+	1.55	1.79	2.22
30-7	6	7	8.11	1.16+	1.50	1.71	2.08
30-8	7	8	9.21	1.15+	1.46	1.65	1.98
30-9	8	9	10.30	1.14+	1.43	1.60	1.90
30-10	9	10	11.39	1.14+	1.40	1.56	1.83
30-11	10	11	12.47	1.13+	1.38	1.53	1.78
30-12	11	12	13.55	1.13+	1.36	1.50	1.73
30-13	12	13	14.62	1.12+	1.34	1.48	1.69
30-14	13	14	15.69	1.12+	1.33	1.45	1.66
30-15	14	15	16.76	1.12+	1.31	1.43	1.63
30-16	15	16	17.83	1.11+	1.30	1.42	1.60
30-17	16	17	18.90	1.11+	1.29	1.40	1.58
30-18	17	18	19.96	1.11+	1.28	1.39	1.56
30-19	18	19	21.02	1.11+	1.27	1.38	1.54
30-20	19	20	22.08	1.10+	1.27	1.36	1.52

FIGURE 20. 30 Percent Consumer's Risk ( $\beta$ ) Test Plans.

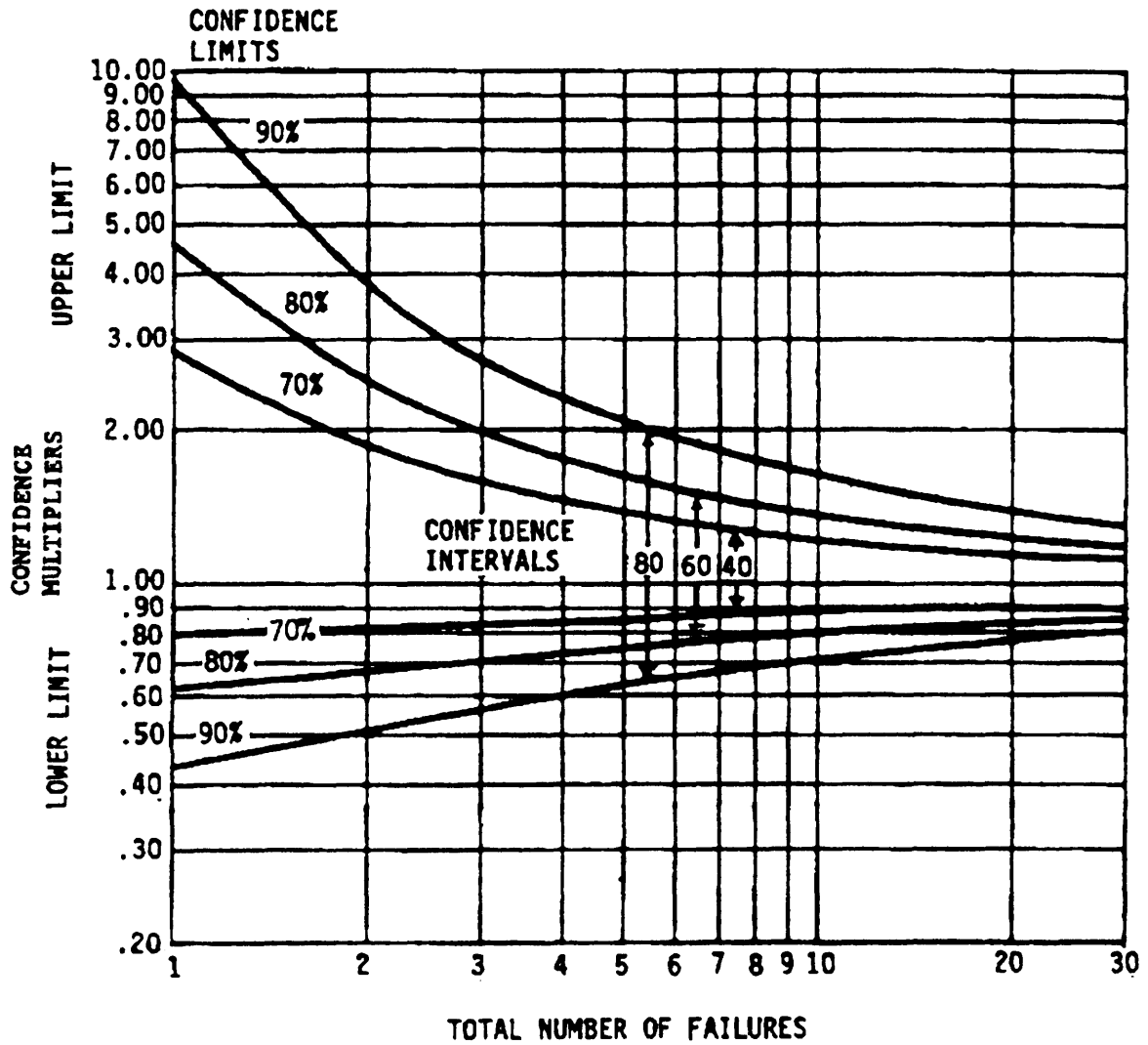

FIGURE 21. Demonstrated MTBF confidence limit multipliers for failure calculation.

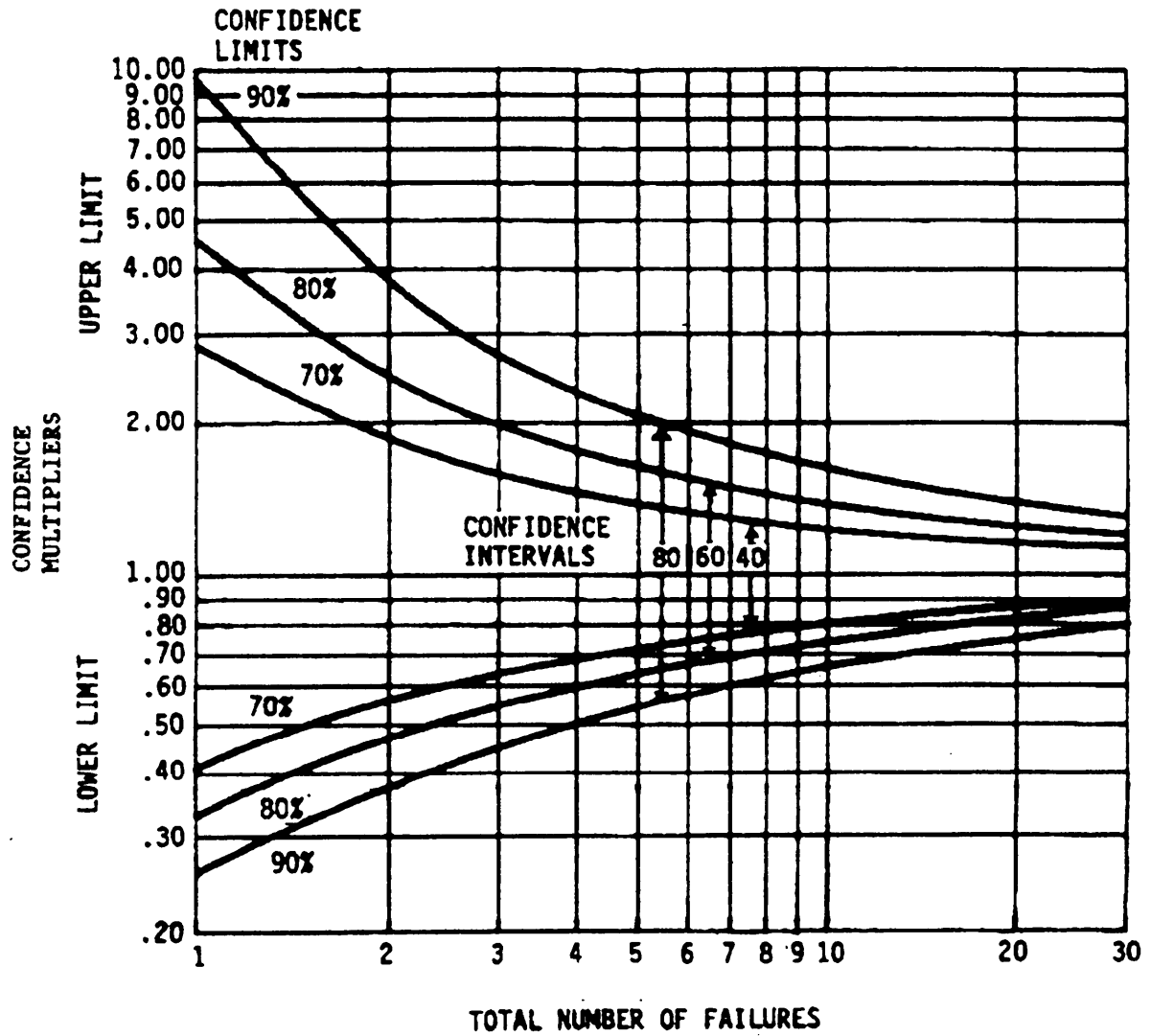

FIGURE 22. Demonstrated MTBF limit multipliers, for time calculation.

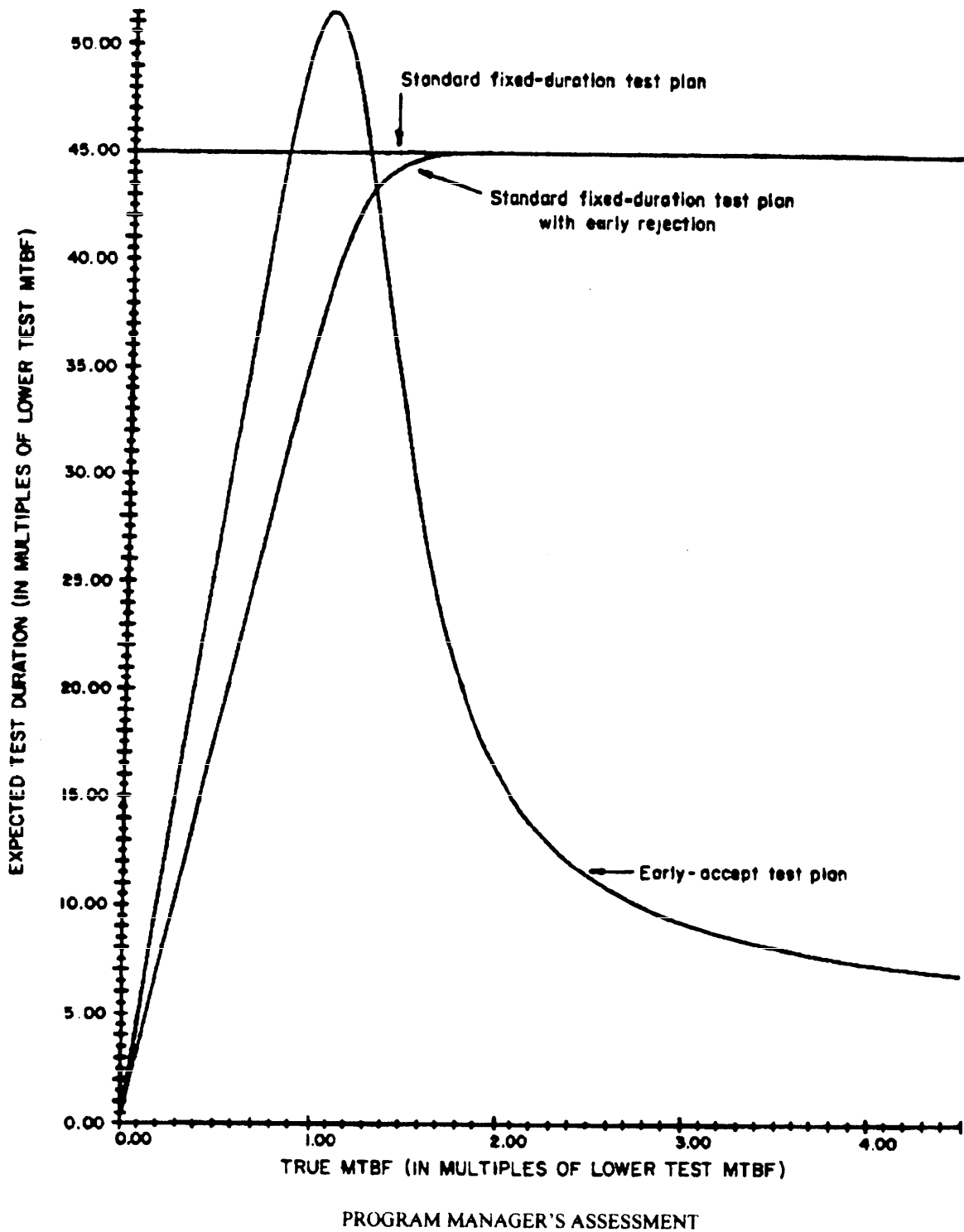

FIGURE 23. Test Plan IX-D.

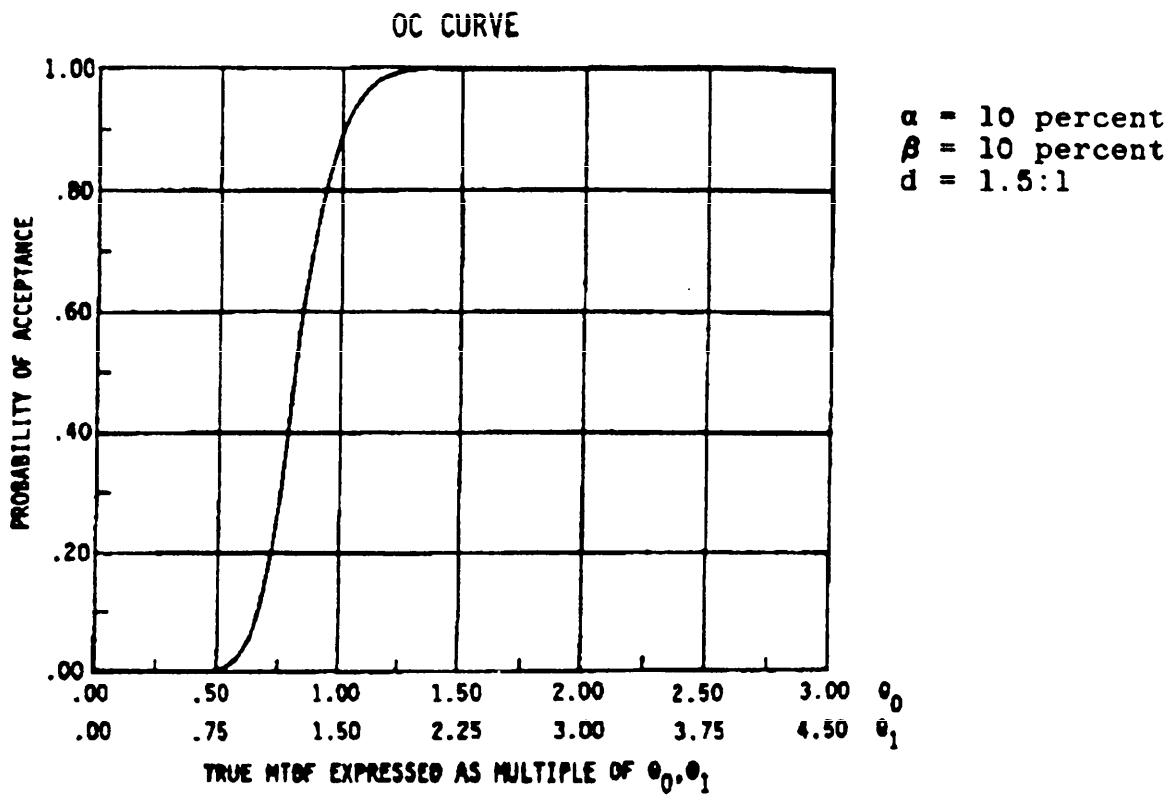

FIGURE 23. Test Plan IX-D. (Continued)

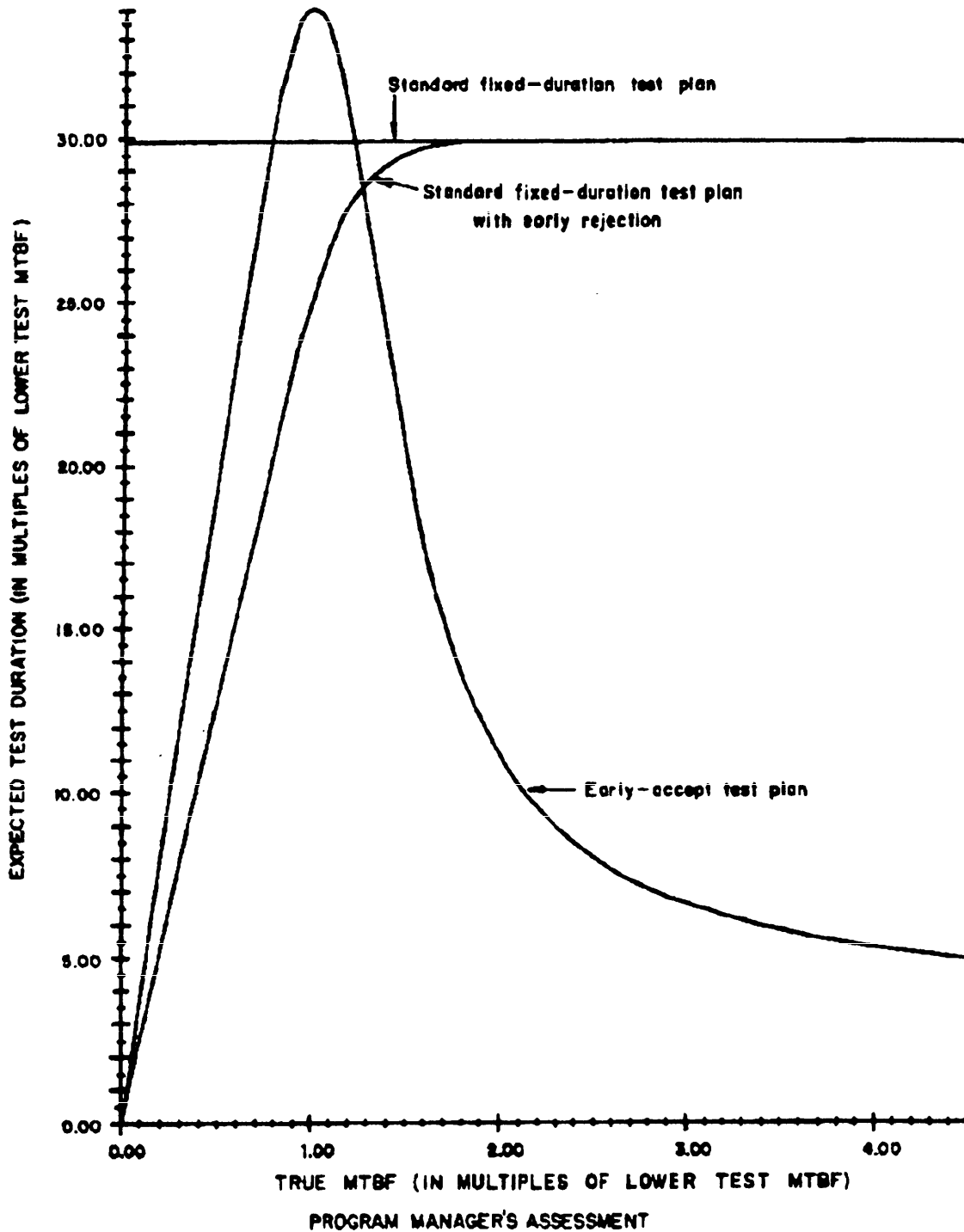

FIGURE 24. Test Plan X-D.

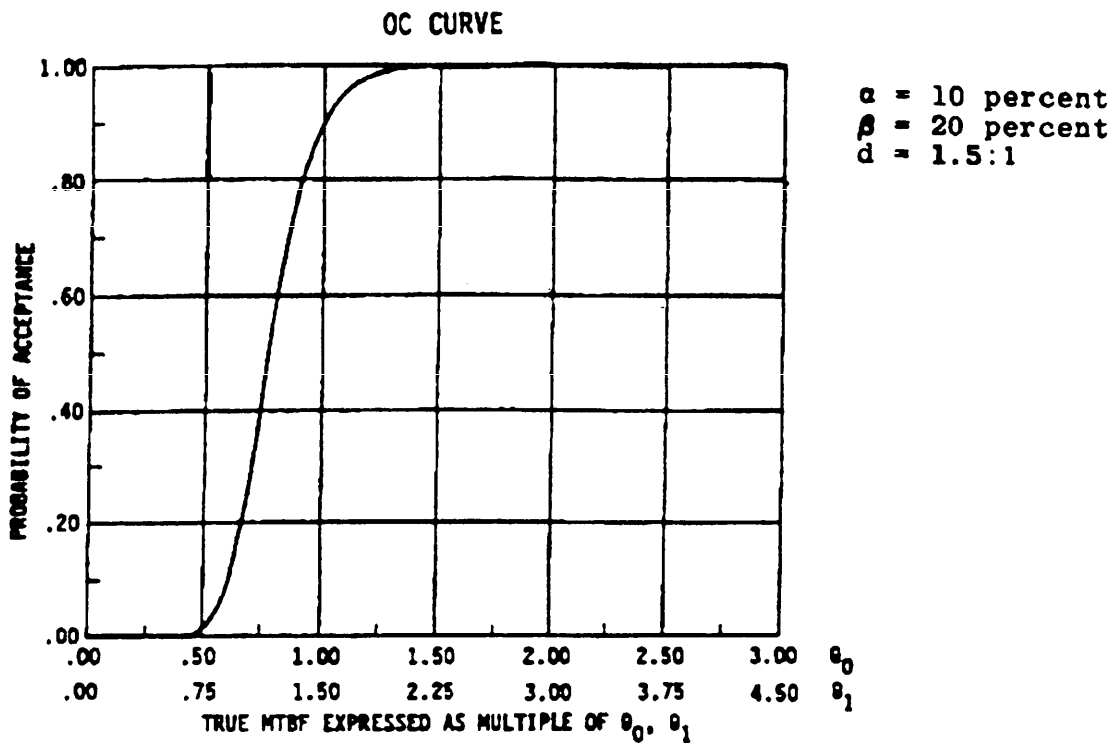

FIGURE 24. Test Plan X-D. (Continued)

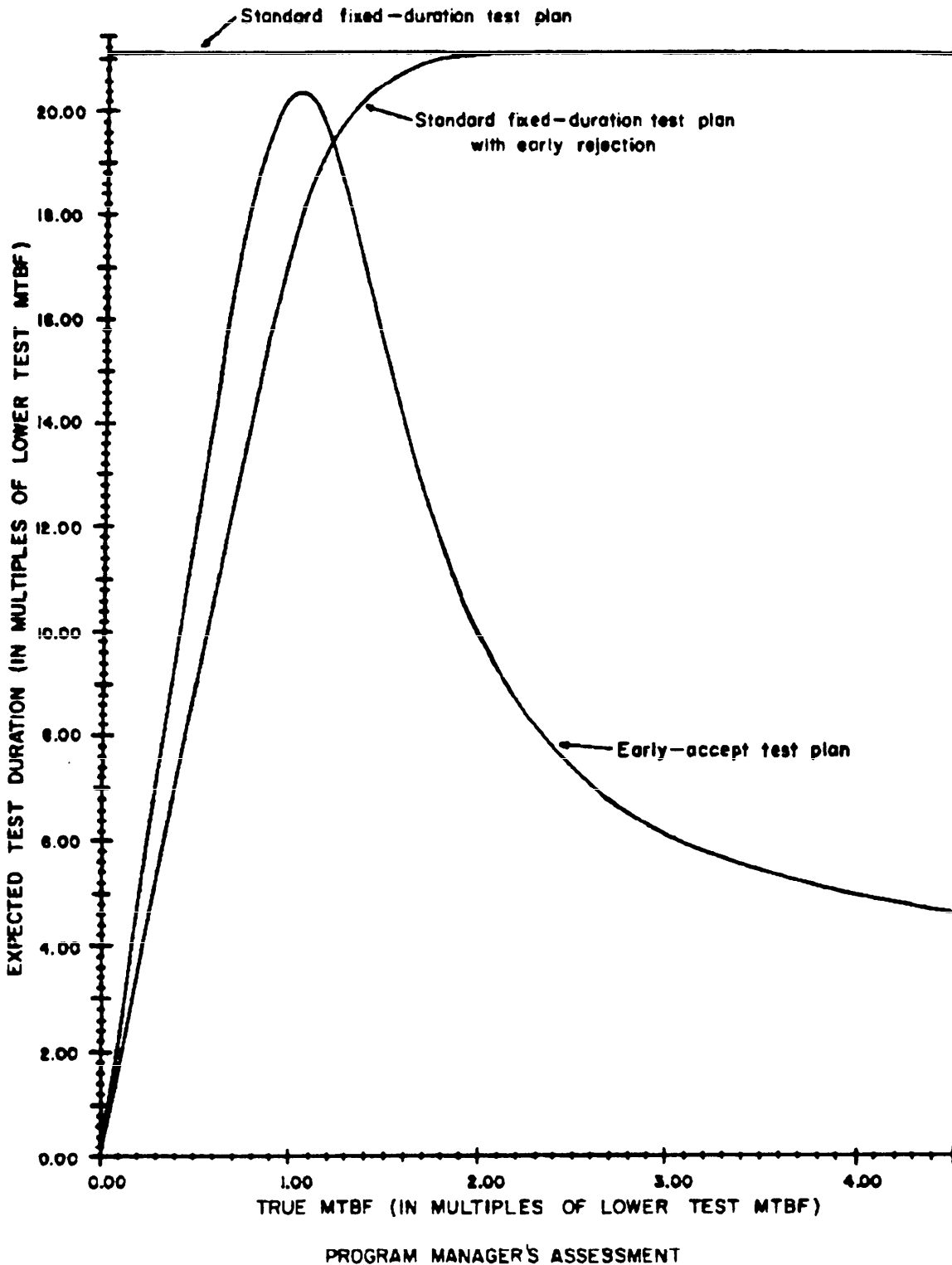

FIGURE 25. Test Plan XI-D

### OC CURVE

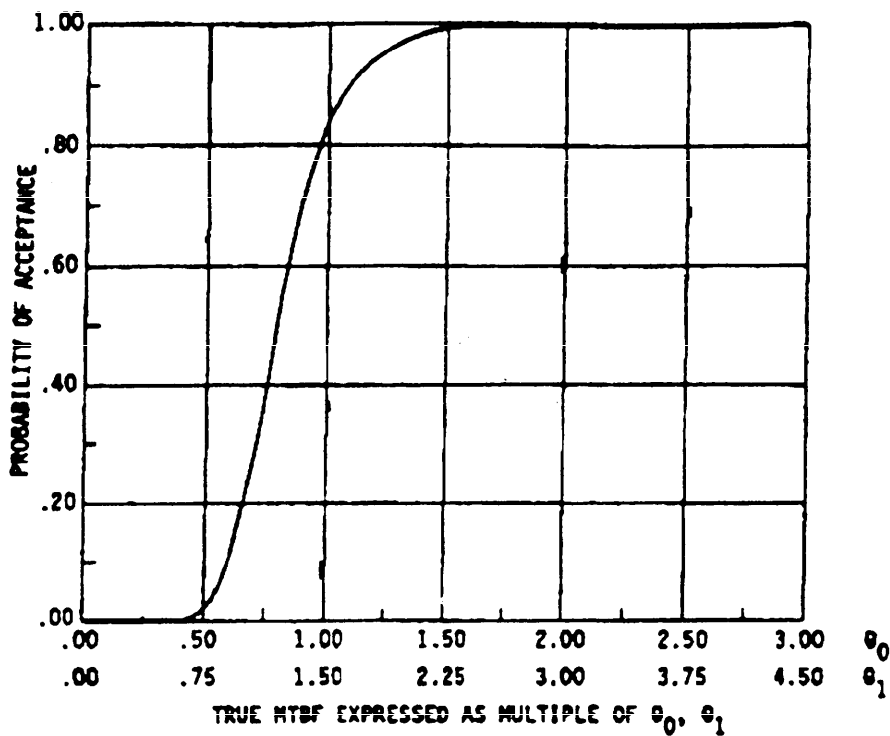

FIGURE 25. Test Plan XI-D

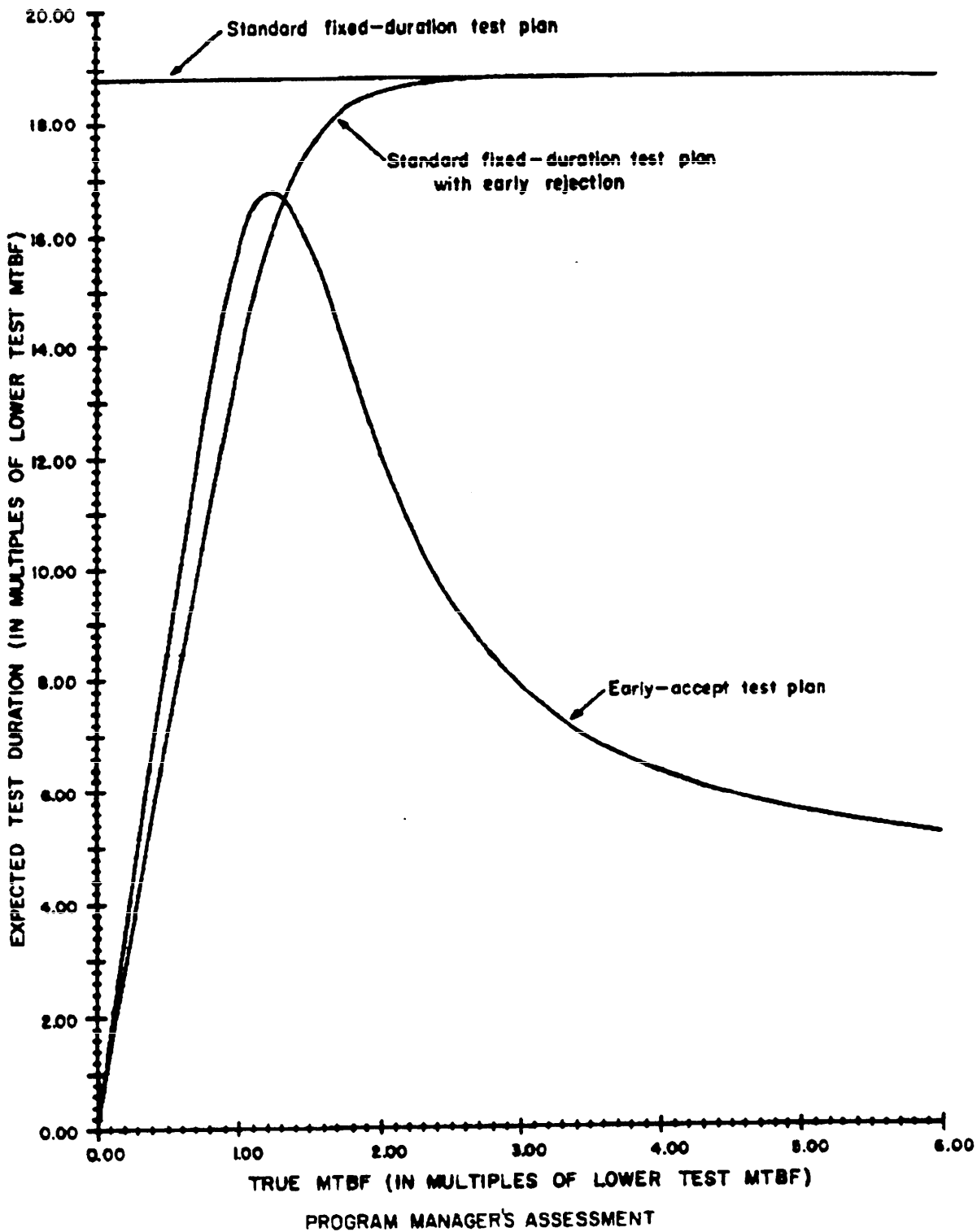

FIGURE 26. Test Plan XII-D.

### OC CURVE

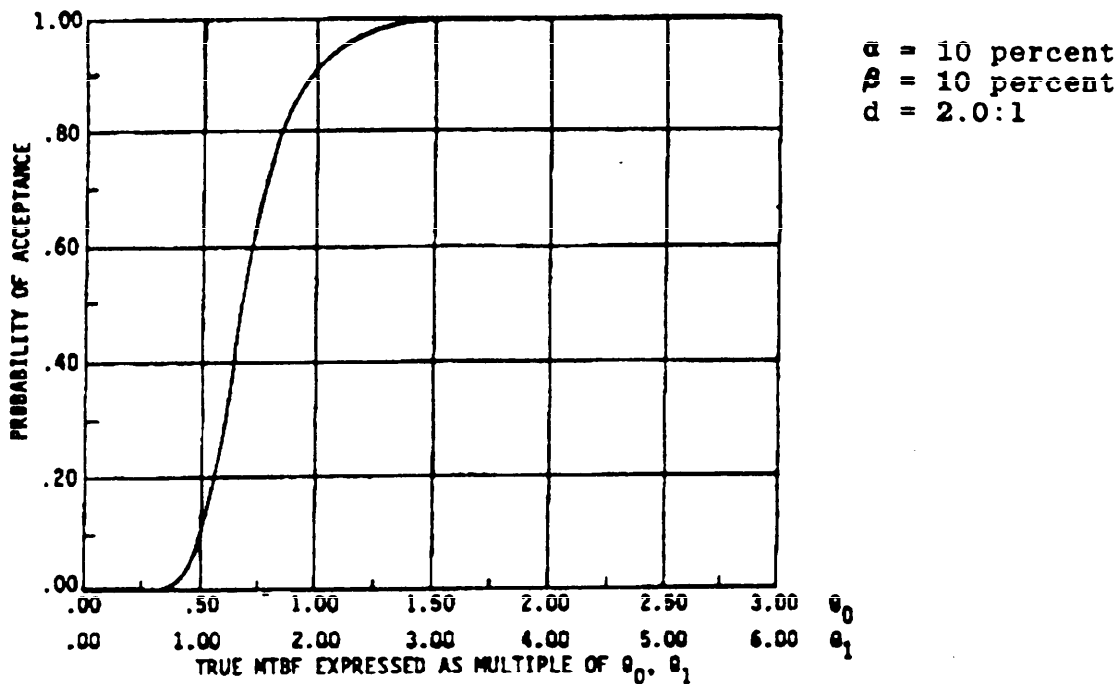
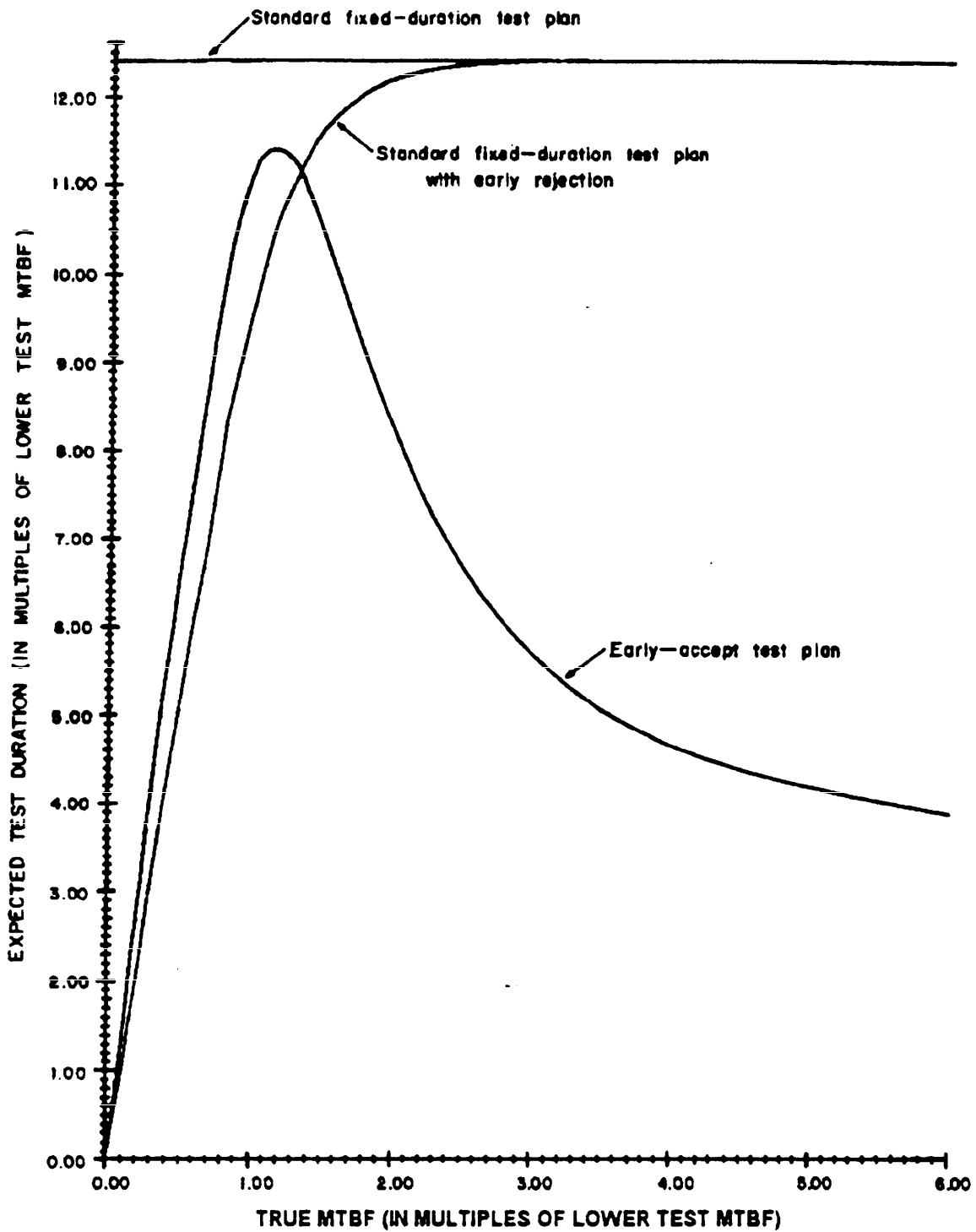

FIGURE 26. Test Plan XII-D. (Continued)



PROGRAM MANAGER'S ASSESSMENT

FIGURE 27. Test Plan XIII-D.

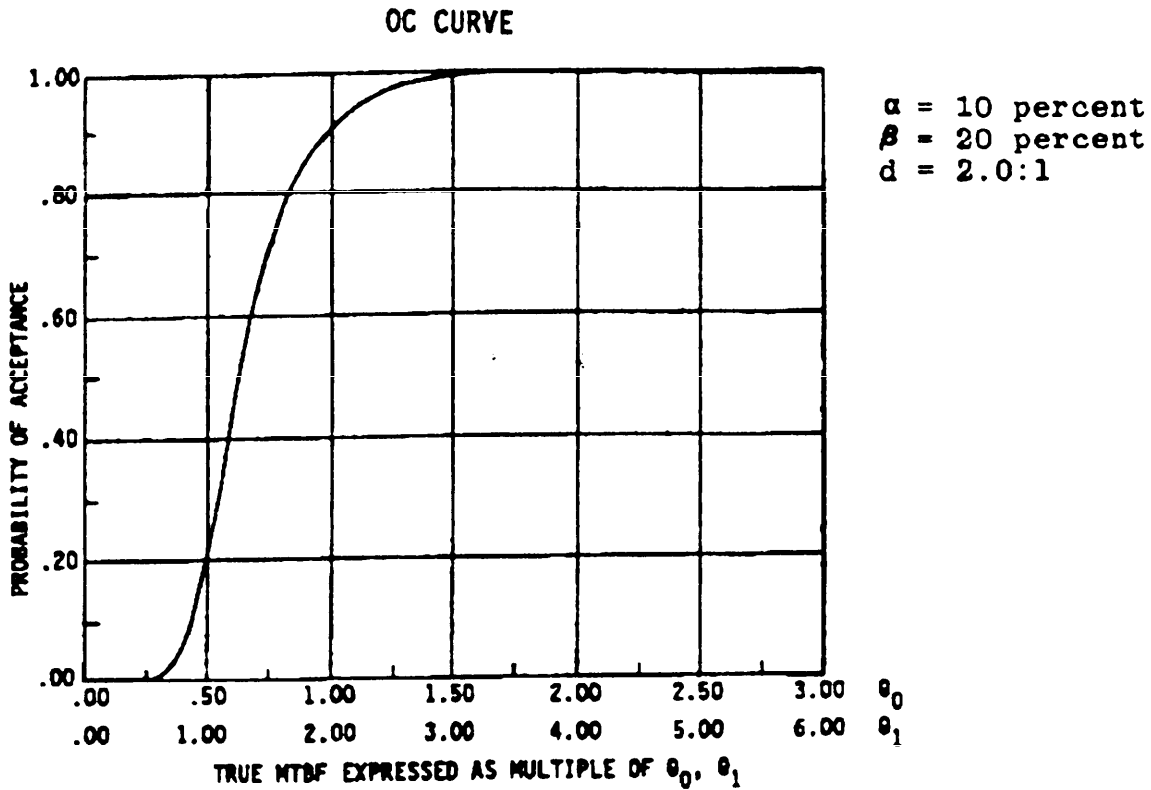

FIGURE 27. Test Plan XIII-D. (Continued)

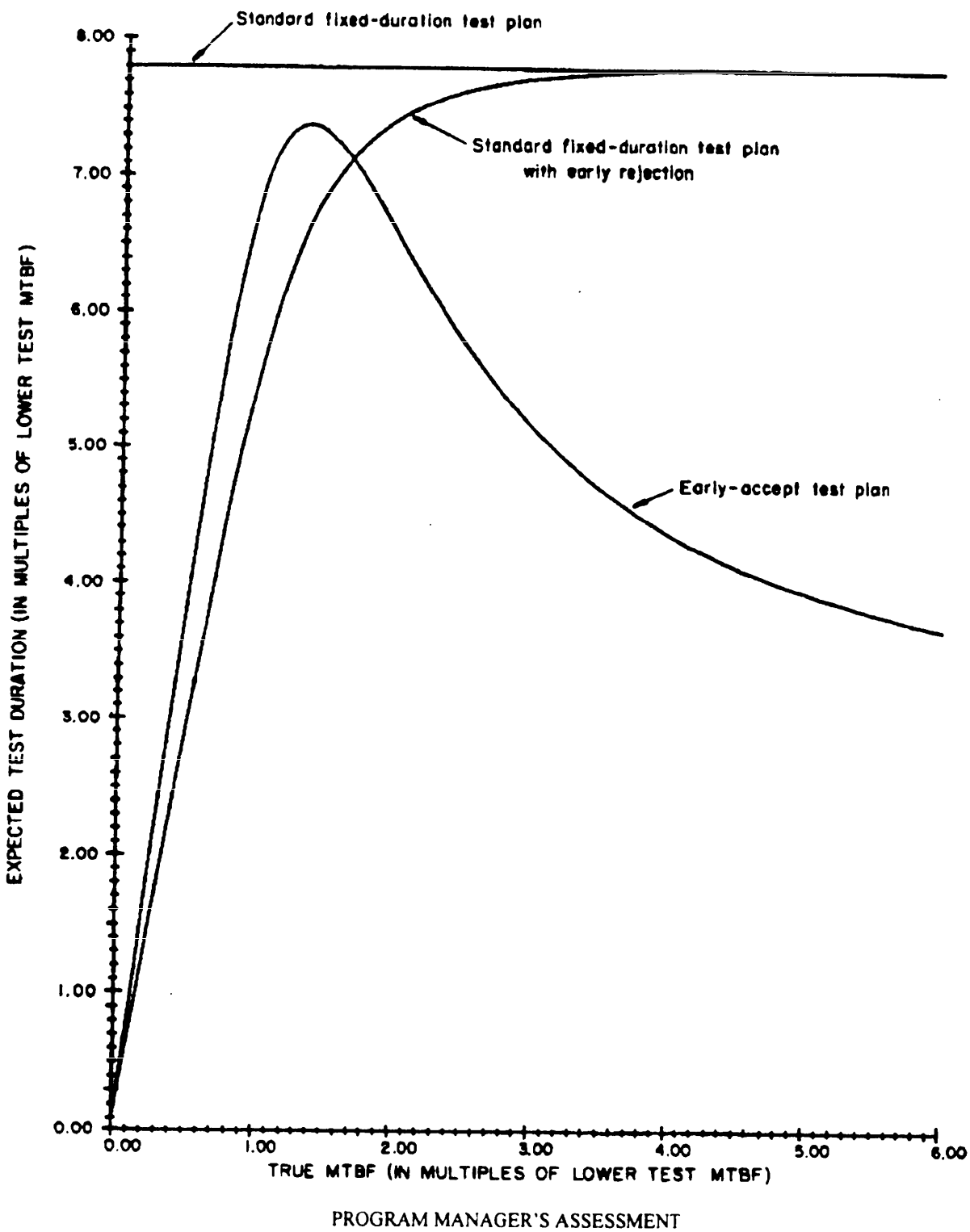

FIGURE 28. Test Plan XIV-D.

### OC CURVE

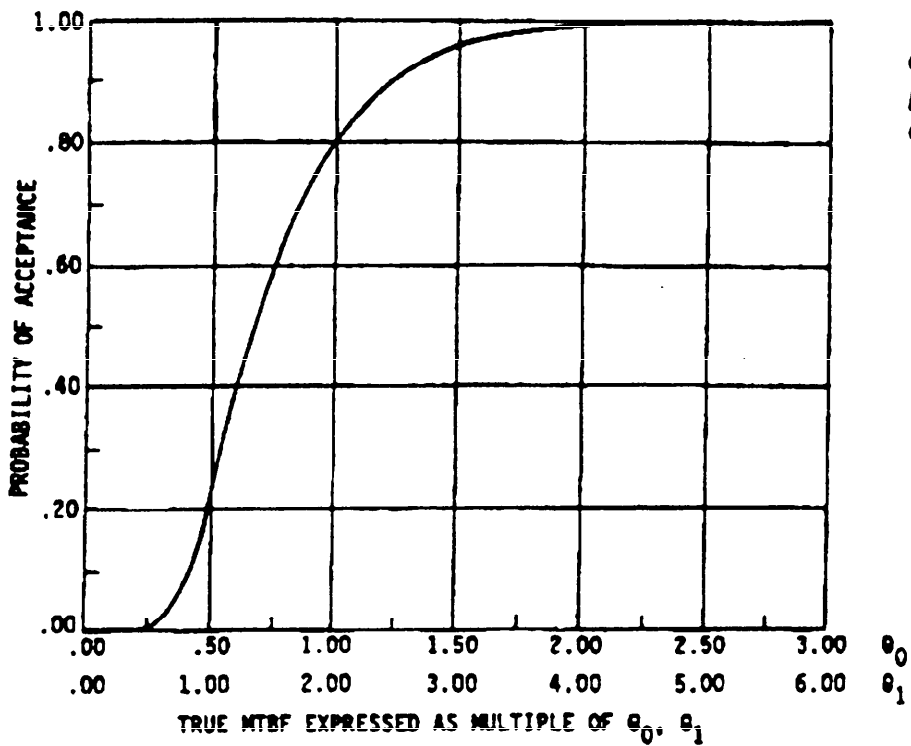
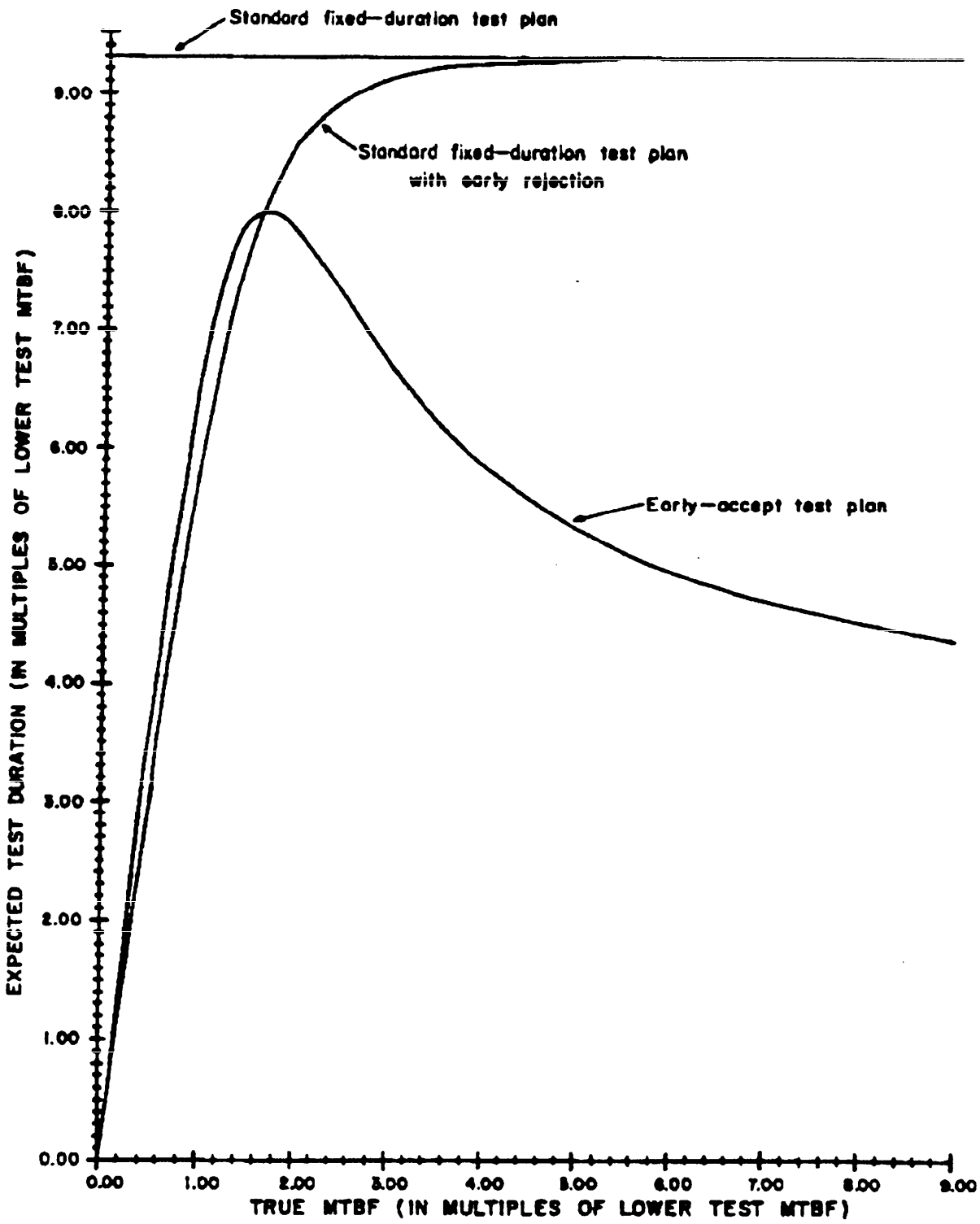

FIGURE 28. Test Plan XIV-D. (Continued)



PROGRAM MANAGER'S ASSESSMENT

FIGURE 29. Test Plan XV-D.

OC CURVE

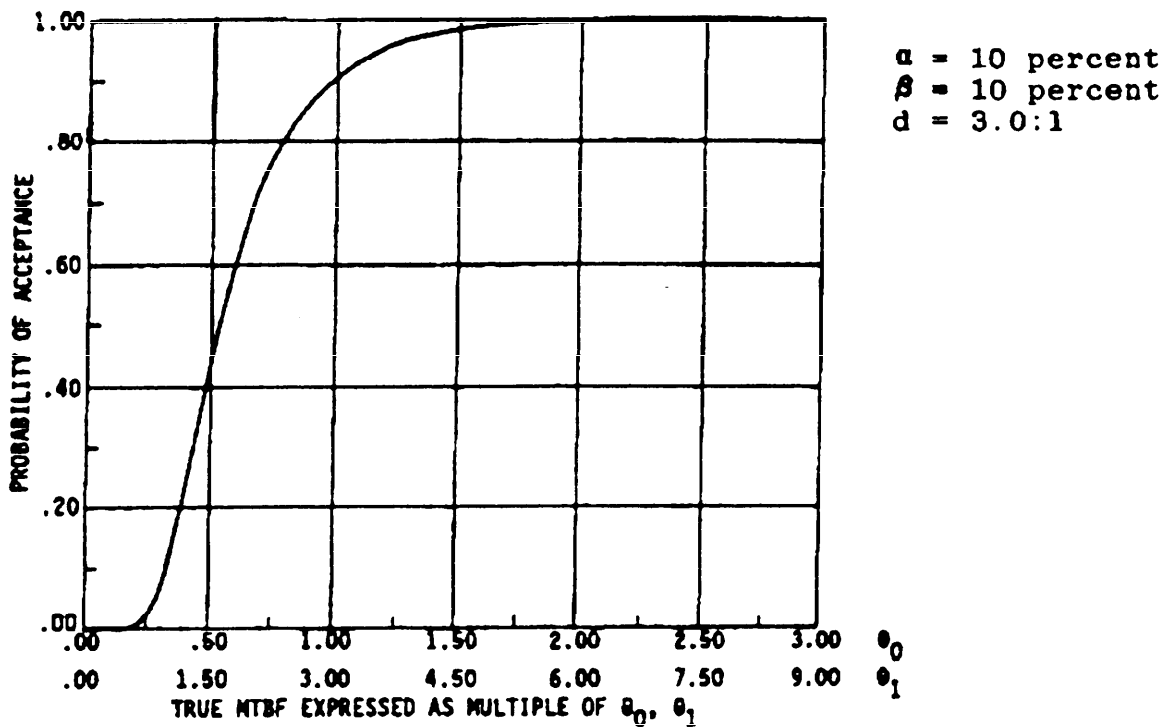
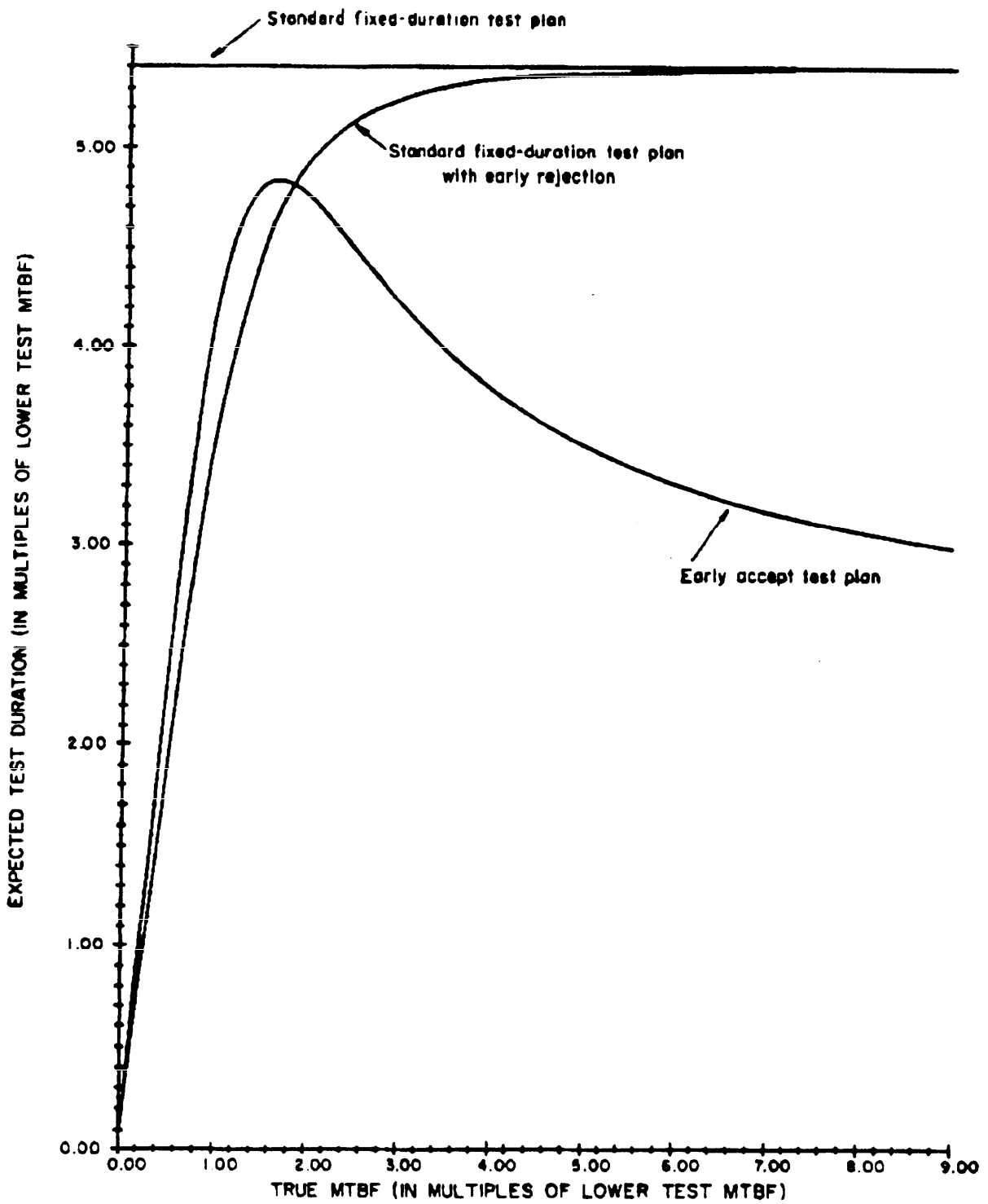

FIGURE 29. Test Plan XV-D. (Continued)



PROGRAM MANAGER'S ASSESSMENT

FIGURE 30. Test Plan XVI-D.

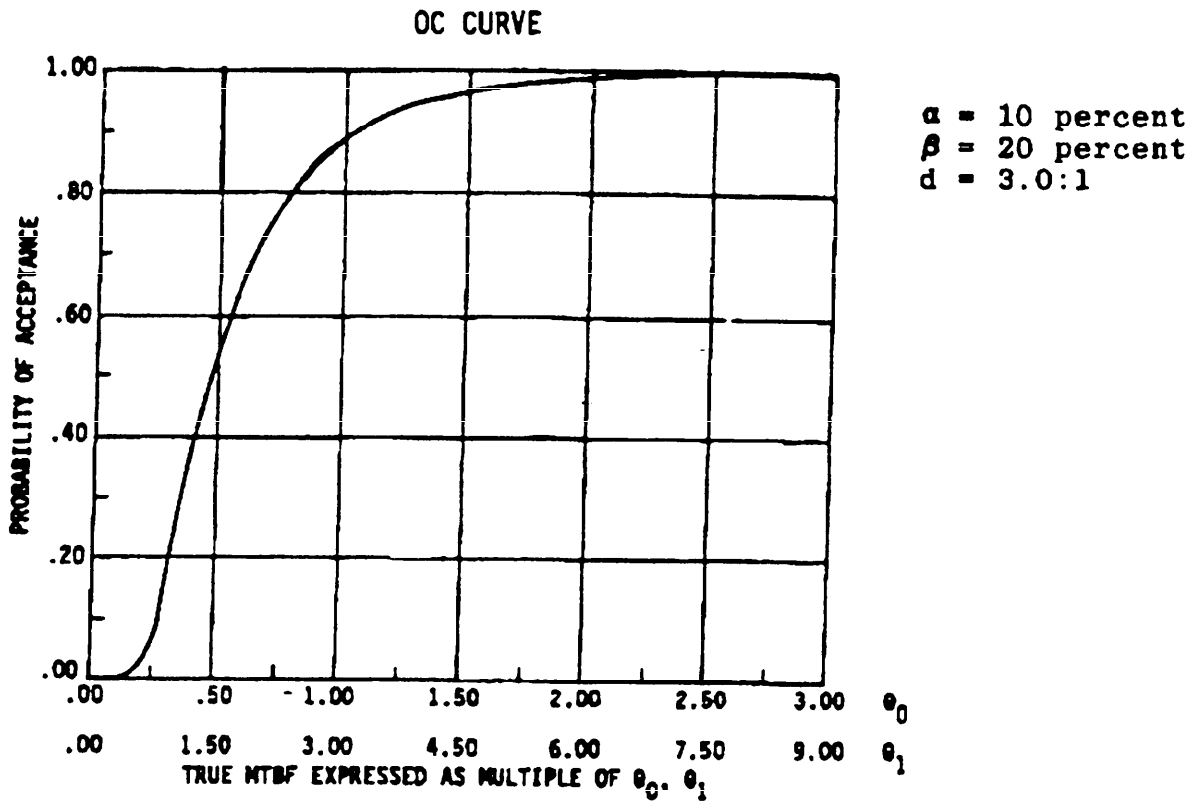

FIGURE 30. Test Plan XVI-D (Continued)

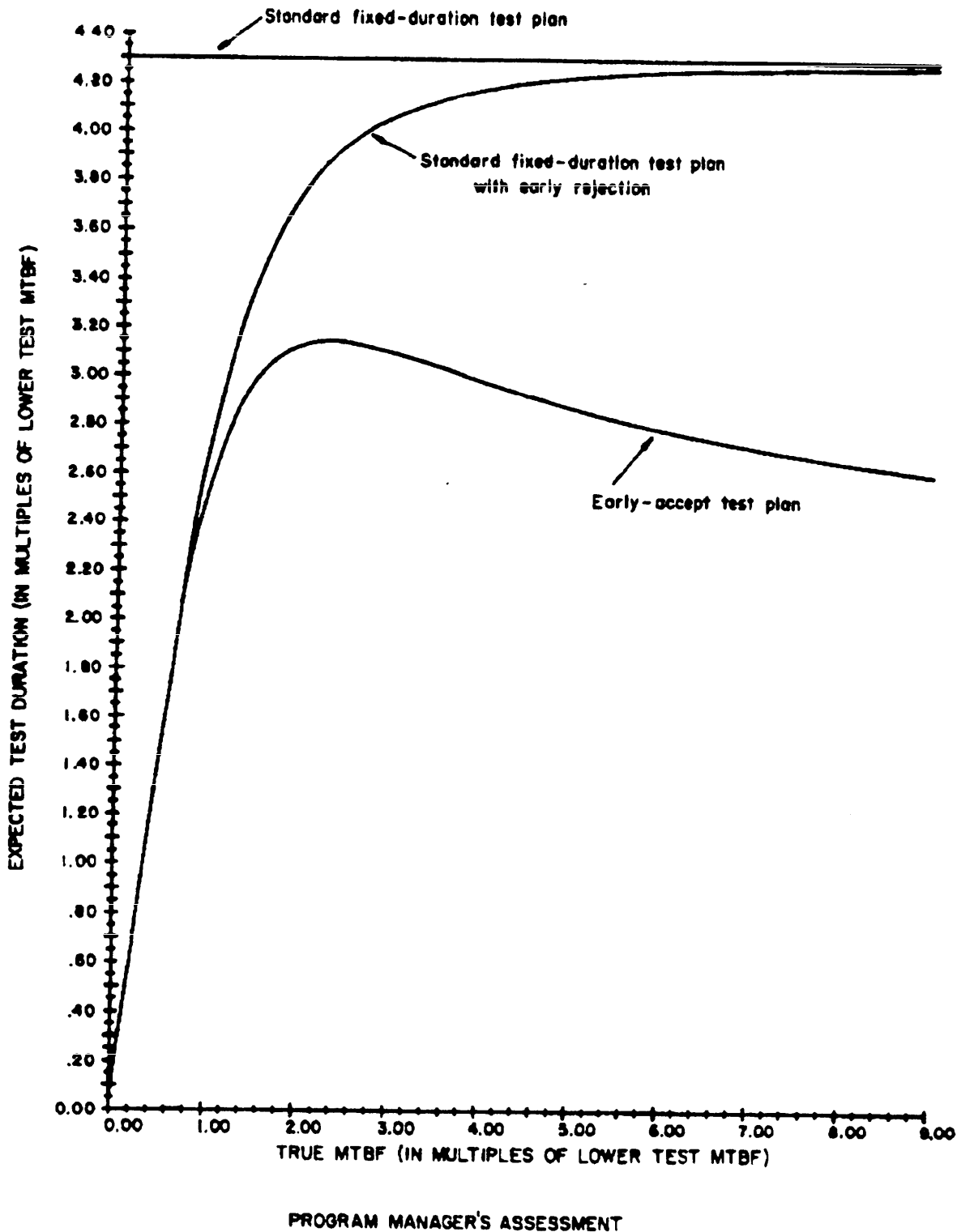

FIGURE 31. Test Plan XVII-D.

### OC CURVE

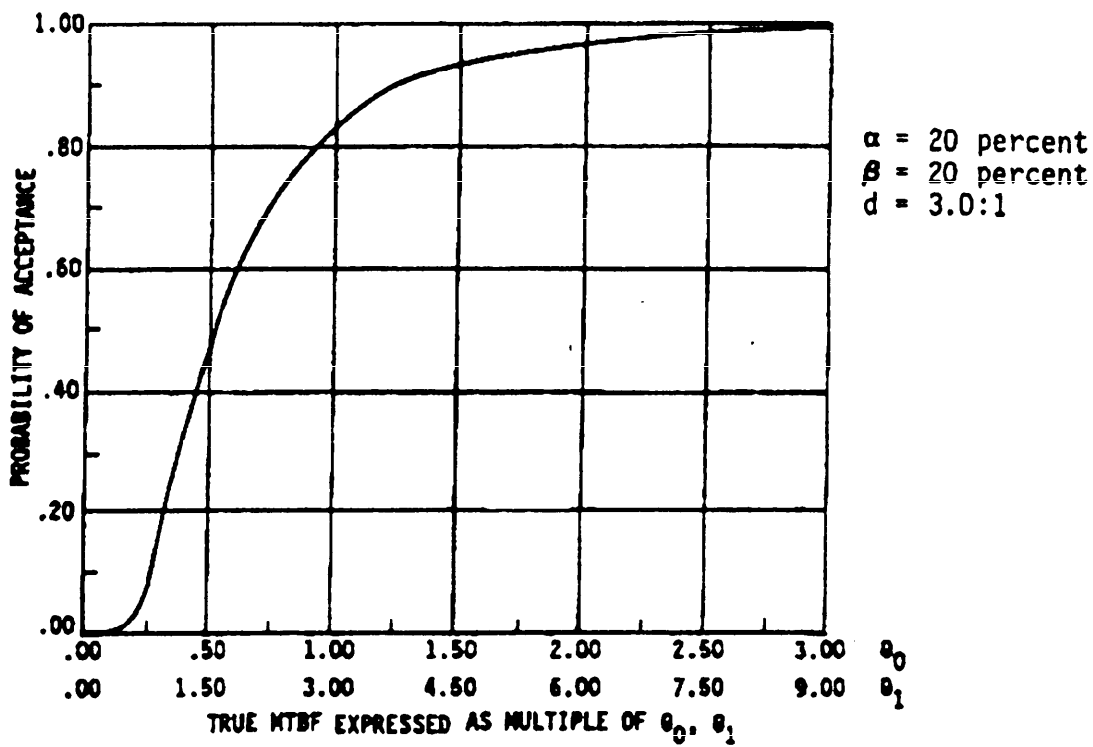

FIGURE 31. Test Plan XVII-D. (Continued)

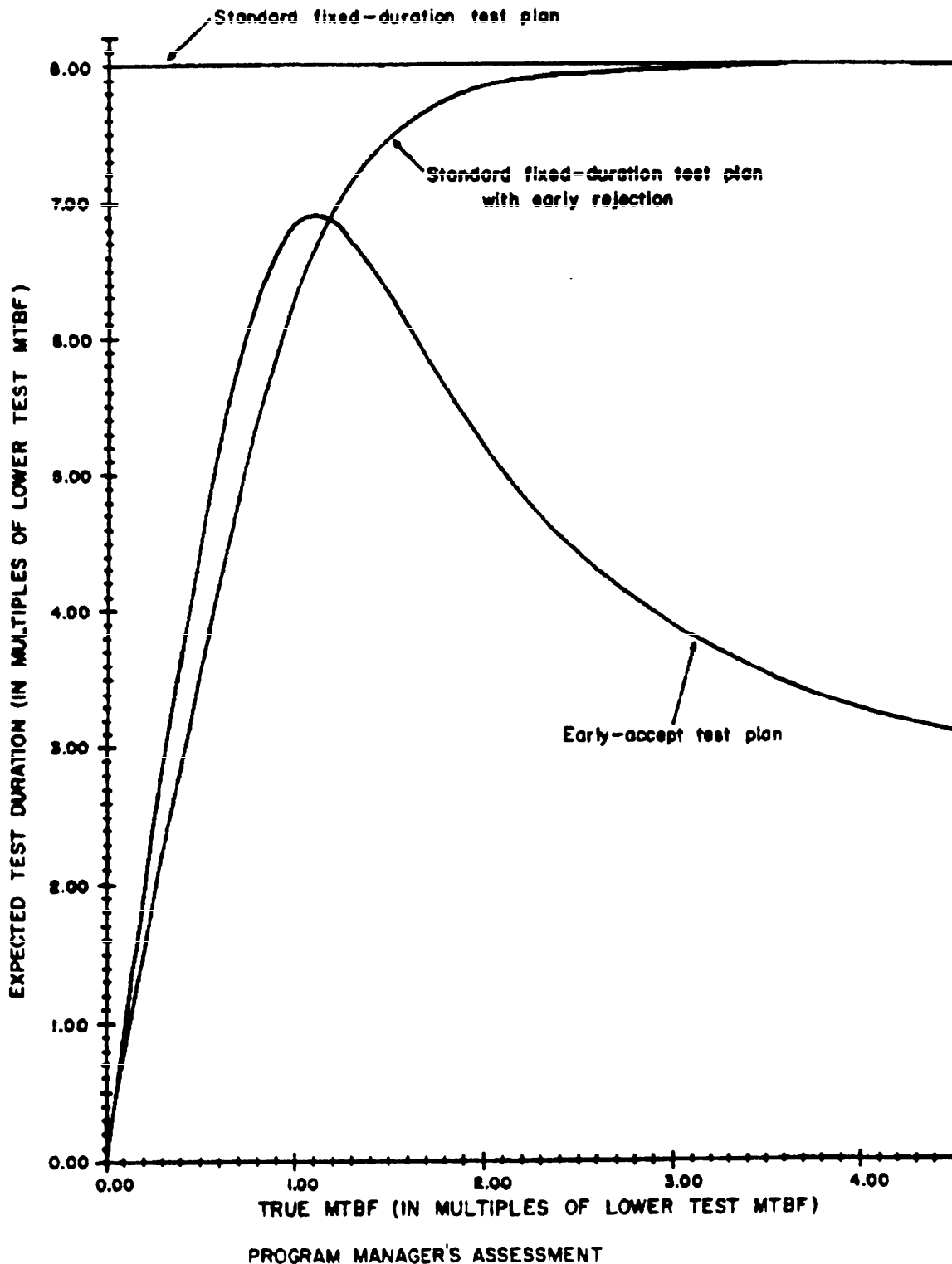

FIGURE 32. Test Plan XIX-D.

OC CURVE

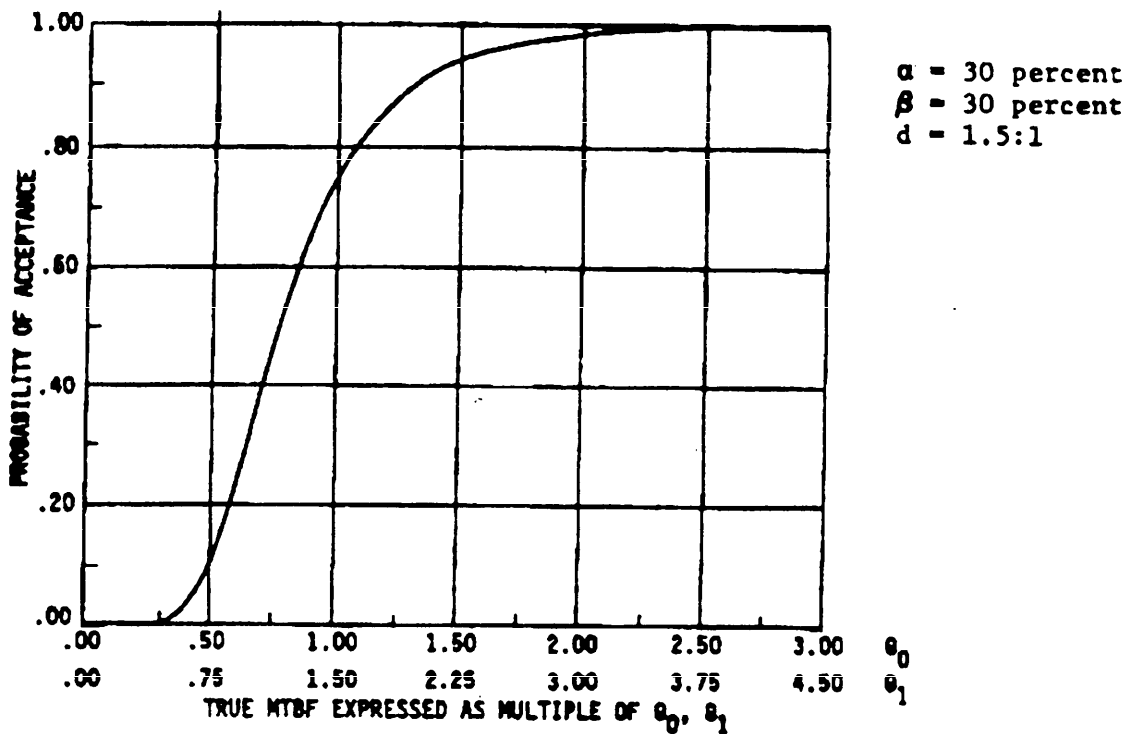
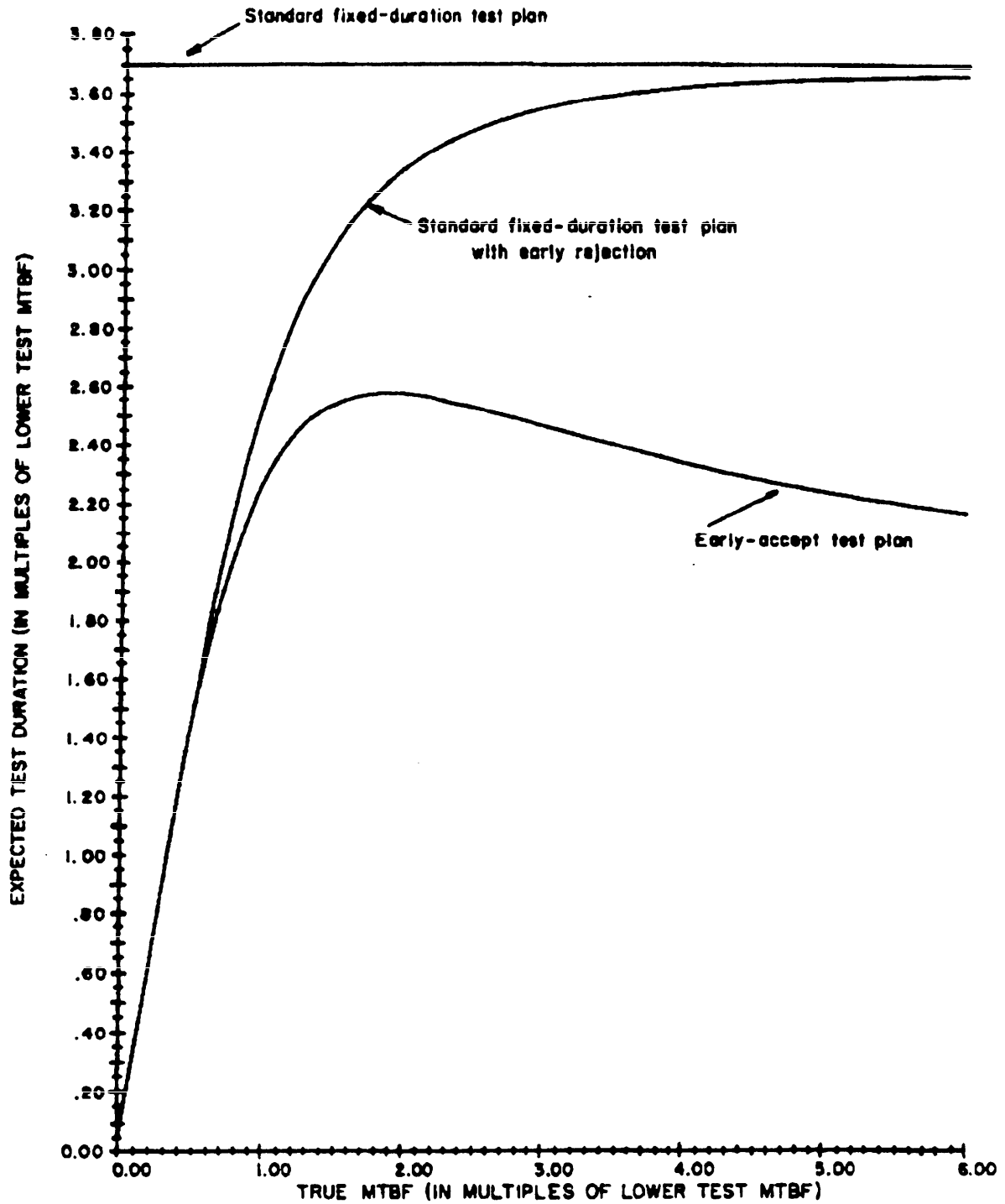

FIGURE 32. Test Plan XIX-D. (Continued)



PROGRAM MANAGER'S ASSESSMENT

FIGURE 33. Test Plan XX-D.

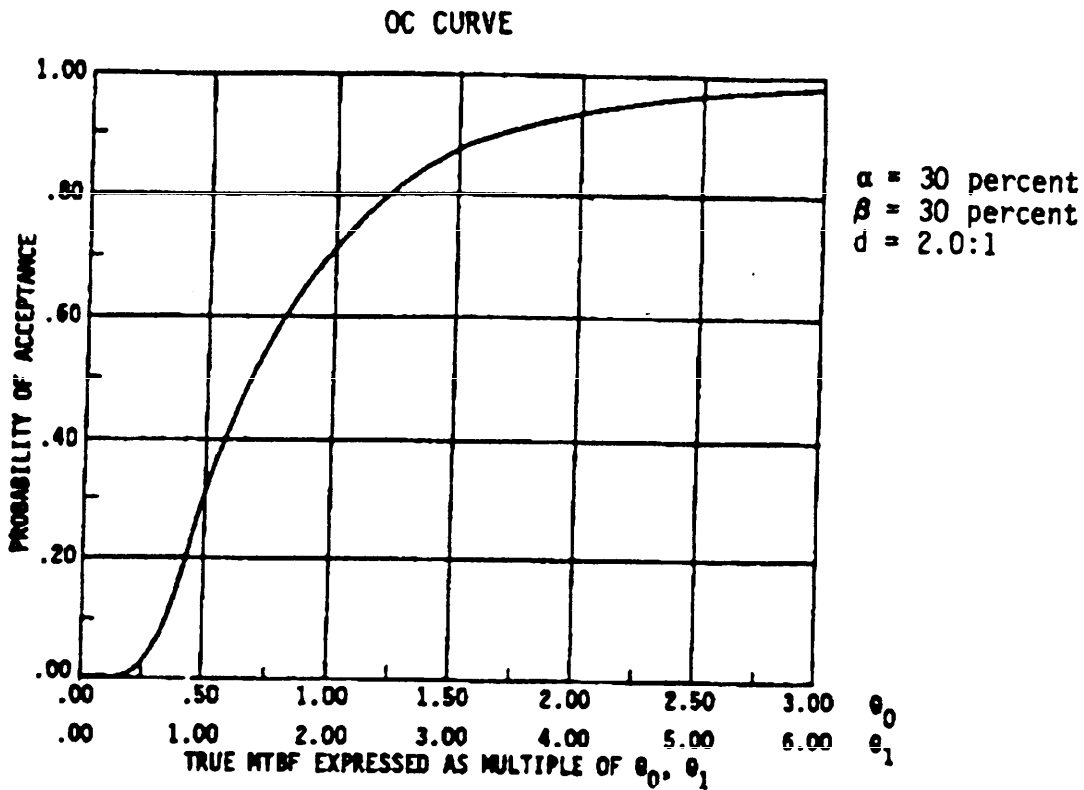
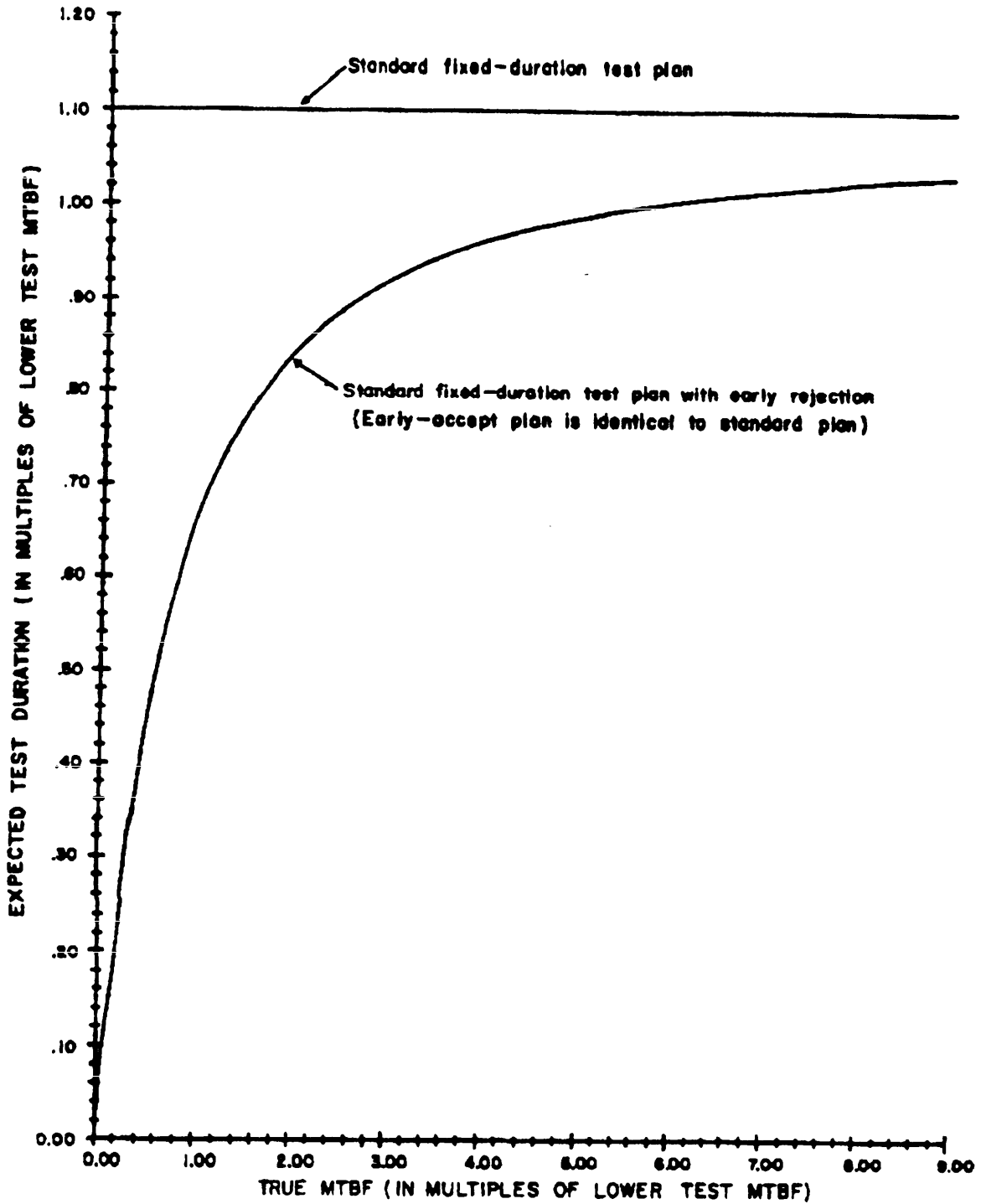

FIGURE 33. Test Plan XX-D. (Continued)



PROGRAM MANAGER'S ASSESSMENT

FIGURE 34. Test Plan XXI-D

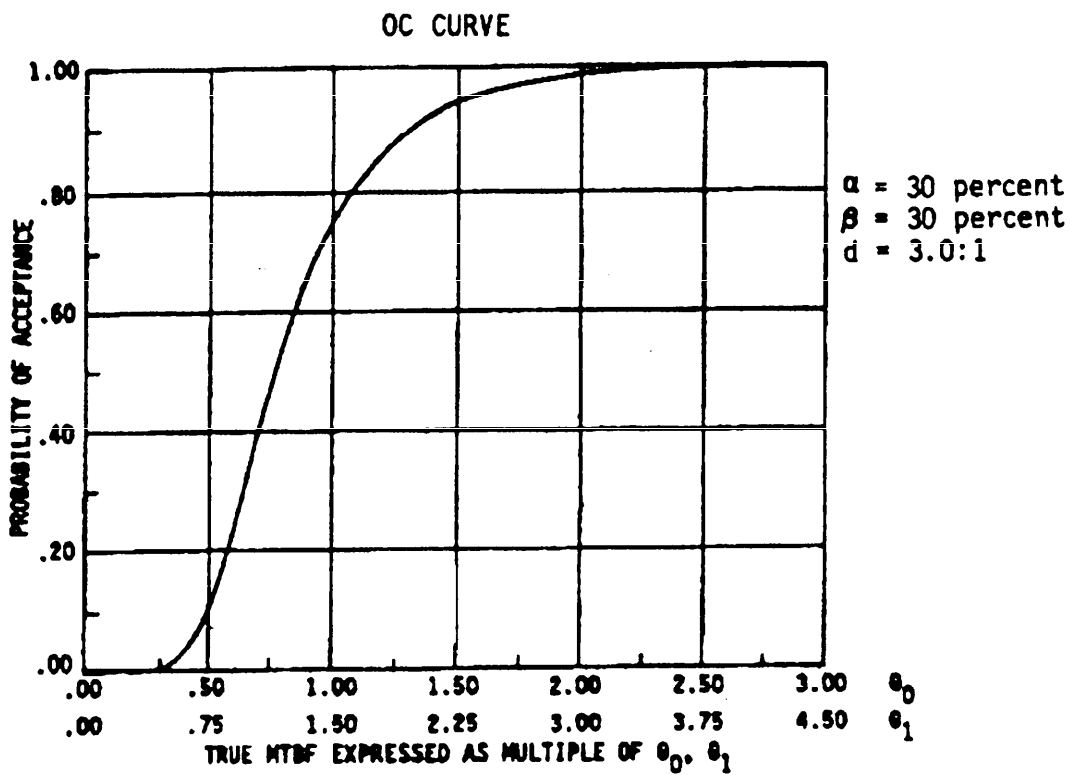
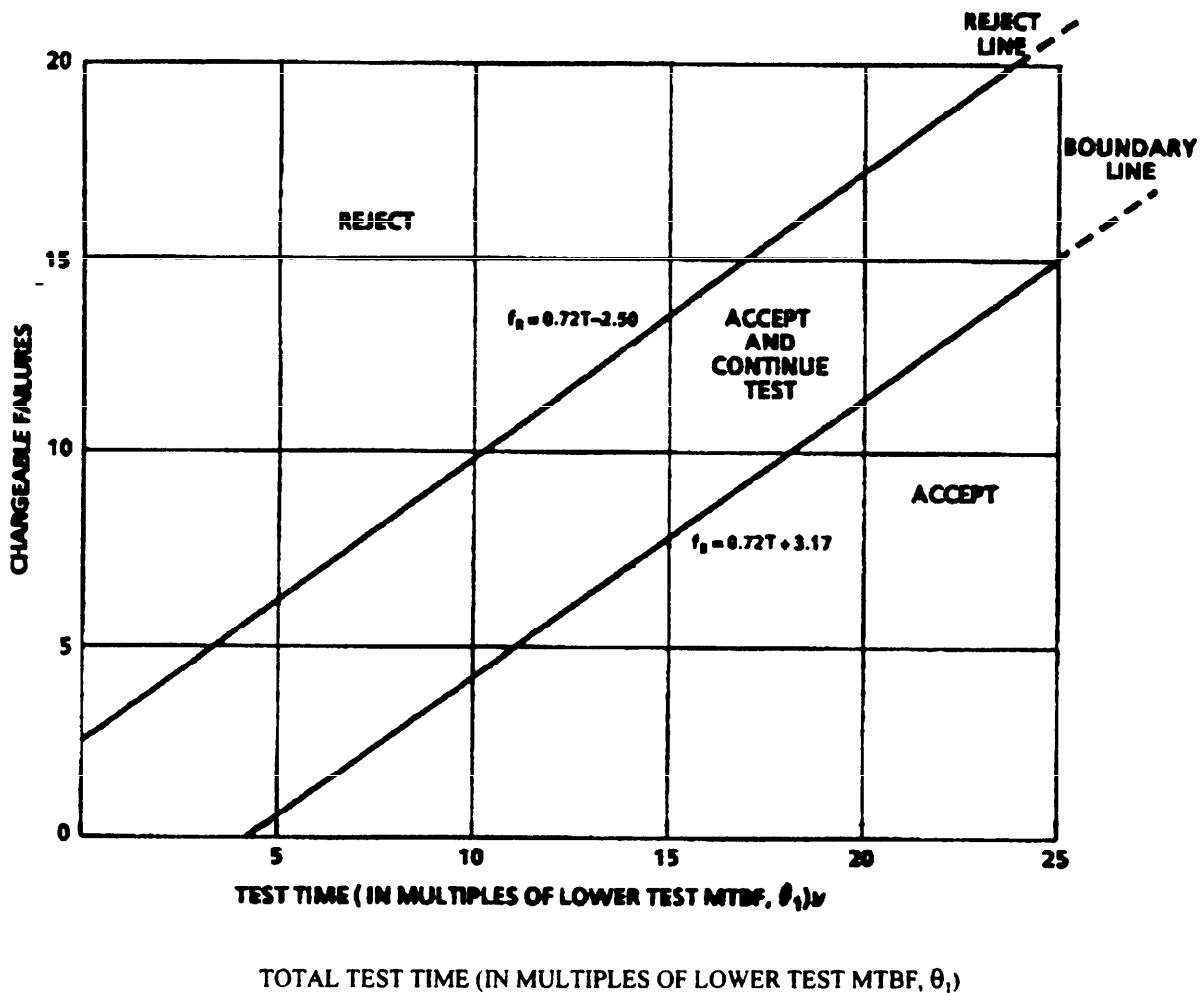

FIGURE 34. Test Plan XXI-D. (Continued)



Chargeable failures	Standardized test time, $t^2$		Chargeable failures	Standardized test time, $t^2$	
	Reject line	Boundary line		Reject line	Boundary line
0	N/A	4.40	9	9.02	16.88
1	N/A	5.79	10	10.40	18.26
2	N/A	7.18	11	11.79	19.65
3	.70	8.56	12	13.18	21.04
4	2.08	9.94	13	14.56	22.42
5	3.48	11.34	14	15.95	23.81
6	4.86	12.72	15	17.33	25.19
7	6.24	14.10	16	18.72	26.58
8	7.63	15.49			

<sup>1</sup> Total test time is the summation of operating time of all units included test sample.

<sup>2</sup> To determine the actual test time, multiply the standardized test time ( $t$ ) by the lower test MTBF ( $\theta_1$ ). (See 4.8.3.3.)

ALL-EQUIPMENT PRODUCTION RELIABILITY ACCEPTANCE TEST PLAN.

FIGURE 35. Test Plan XVIII-D.

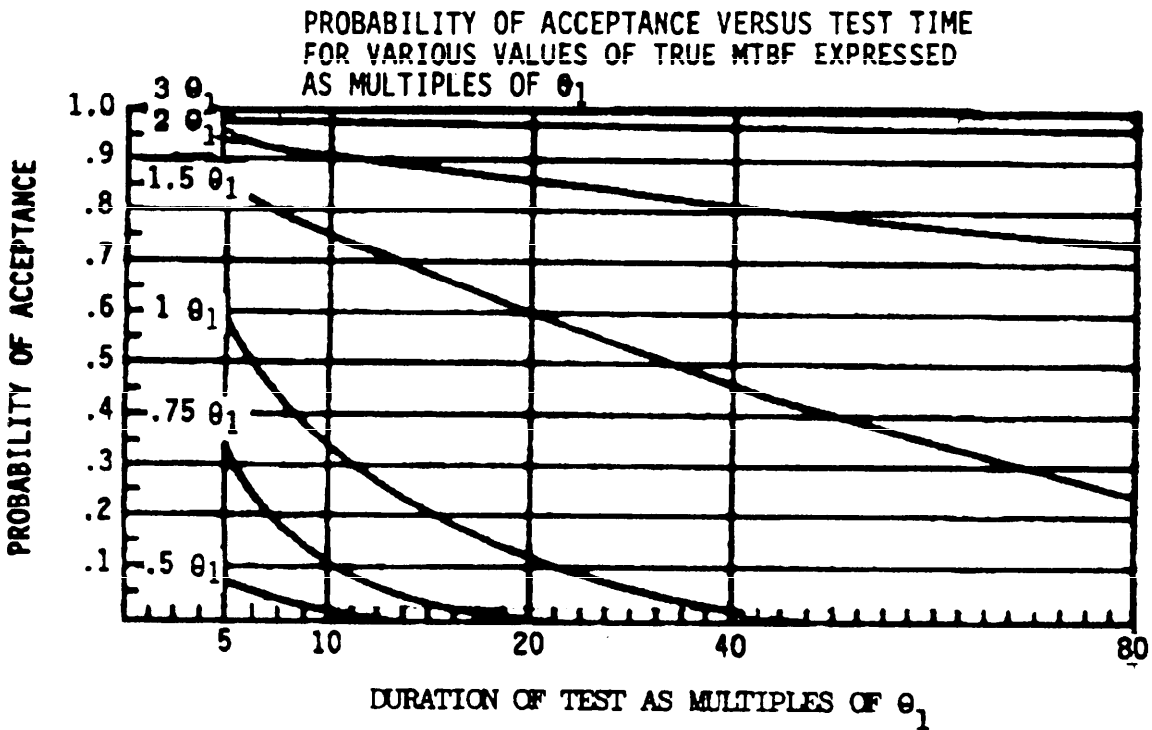
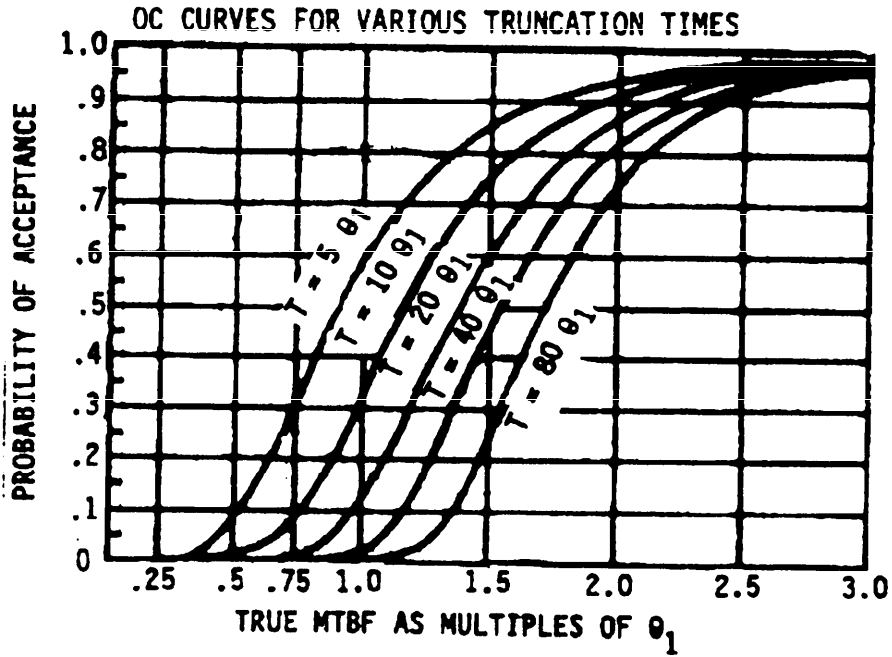
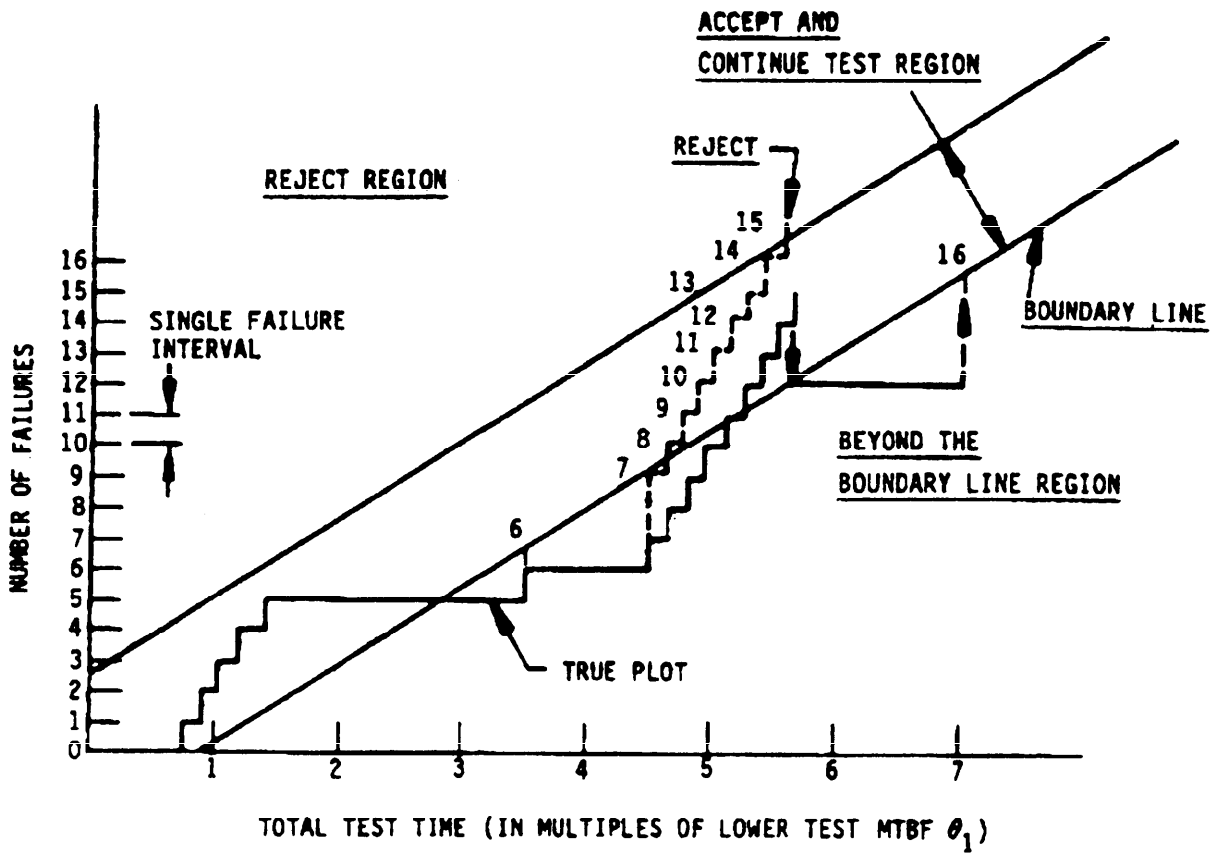
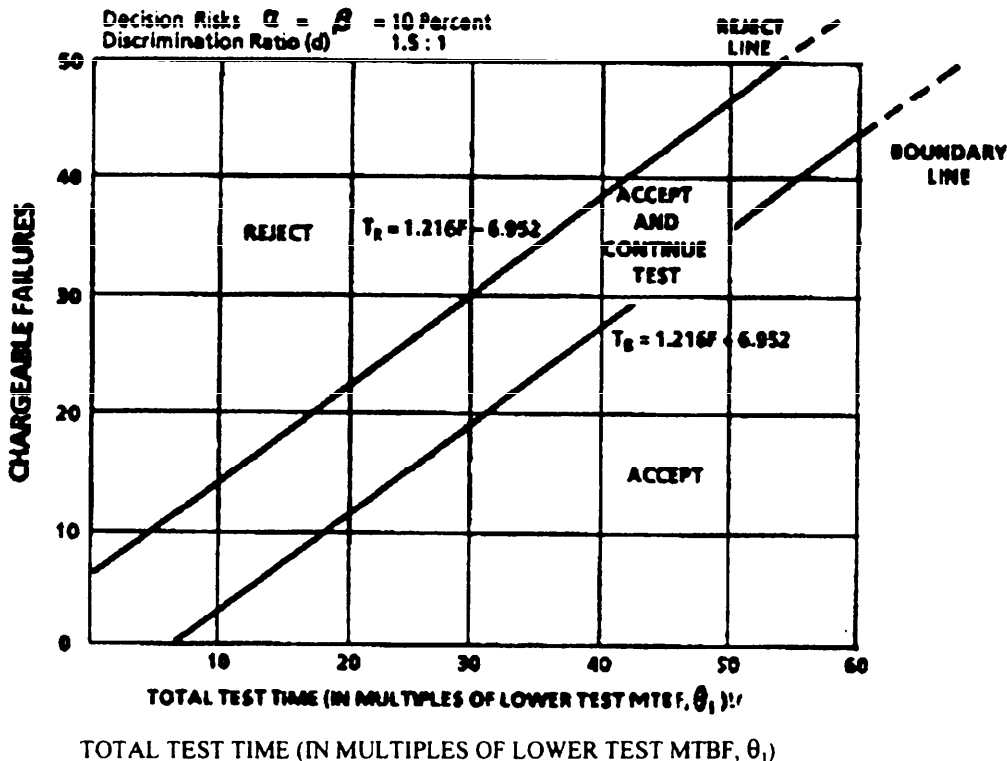

FIGURE 35. Test Plan XVIII-D. (Continued)



NOTE: THIS IS NOT TEST PLAN VIII-D

FIGURE 36. Boundary line criterion for reject-accept decision.



Chargeable failures	Standardized test time, $t$ <sup>2/</sup>		Chargeable failures	Standardized test time, $t$ <sup>2/</sup>	
	Reject line	Boundary line		Reject line	Boundary line
0	N/A	6.60	21	18.92	32.15
1	N/A	7.82	22	20.13	33.26
2	N/A	9.03	23	21.35	34.58
3	N/A	10.25	24	22.56	35.79
4	N/A	11.46	25	23.78	37.01
5	N/A	12.68	26	24.99	38.22
6	0.68	13.91	27	26.21	39.44
7	1.89	15.12	28	27.44	40.67
8	3.11	16.34	29	28.65	41.88
9	4.32	17.55	30	29.85	42.22
10	5.54	18.77	31	31.08	44.31
11	6.75	19.98	32	32.30	45.53
12	7.97	21.20	33	33.51	46.74
13	9.18	22.41	34	34.73	47.96
14	10.40	23.63	35	35.94	49.17
15	11.61	24.84	36	37.16	50.40
16	12.83	26.06	37	38.37	51.61
17	14.06	27.29	38	39.59	52.83
18	14.94	28.50	39	40.82	54.38
19	15.27	29.72	40	41.69	55.26
20	17.37	30.93	41	43.25	56.48

Accept-reject criteria

<sup>1/</sup> Total test time is the summation of operating time of all units included in test sample.

<sup>2/</sup> To determine the actual test time, multiply the standardized test time ( $t$ ) by the lower test MTBF ( $\theta_1$ ).  
 (See 4.8.3.3.)

FIGURE 37. All-equipment test plan derived from Test Plan I-D.

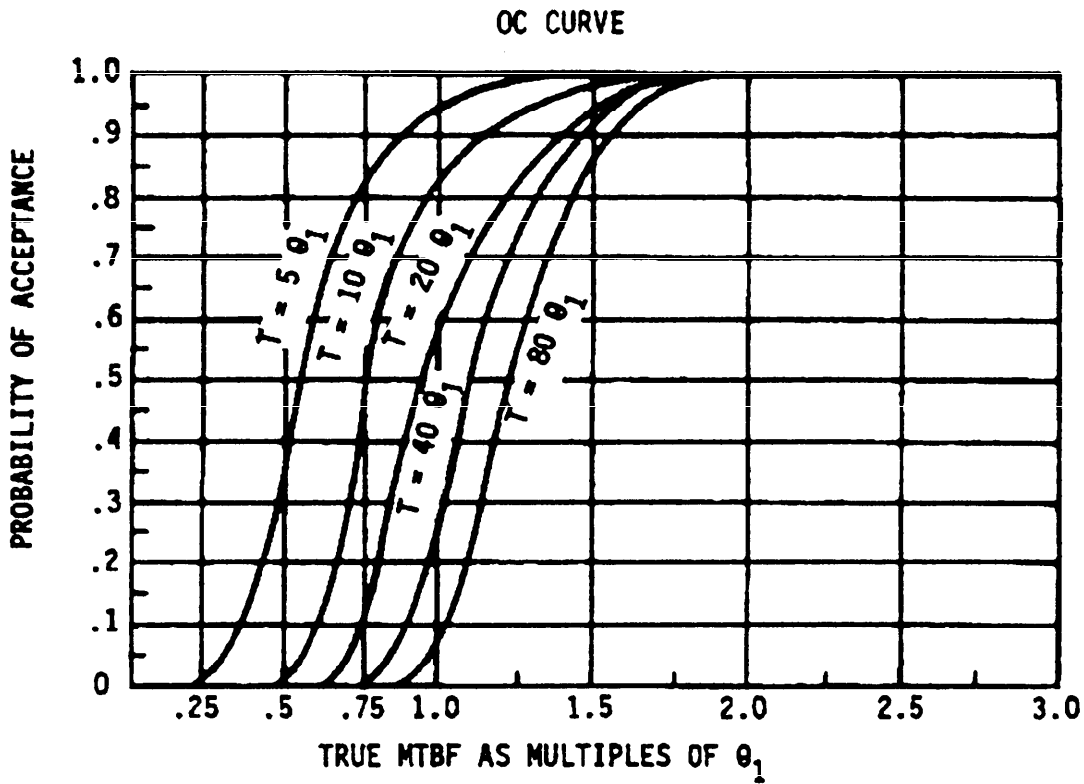
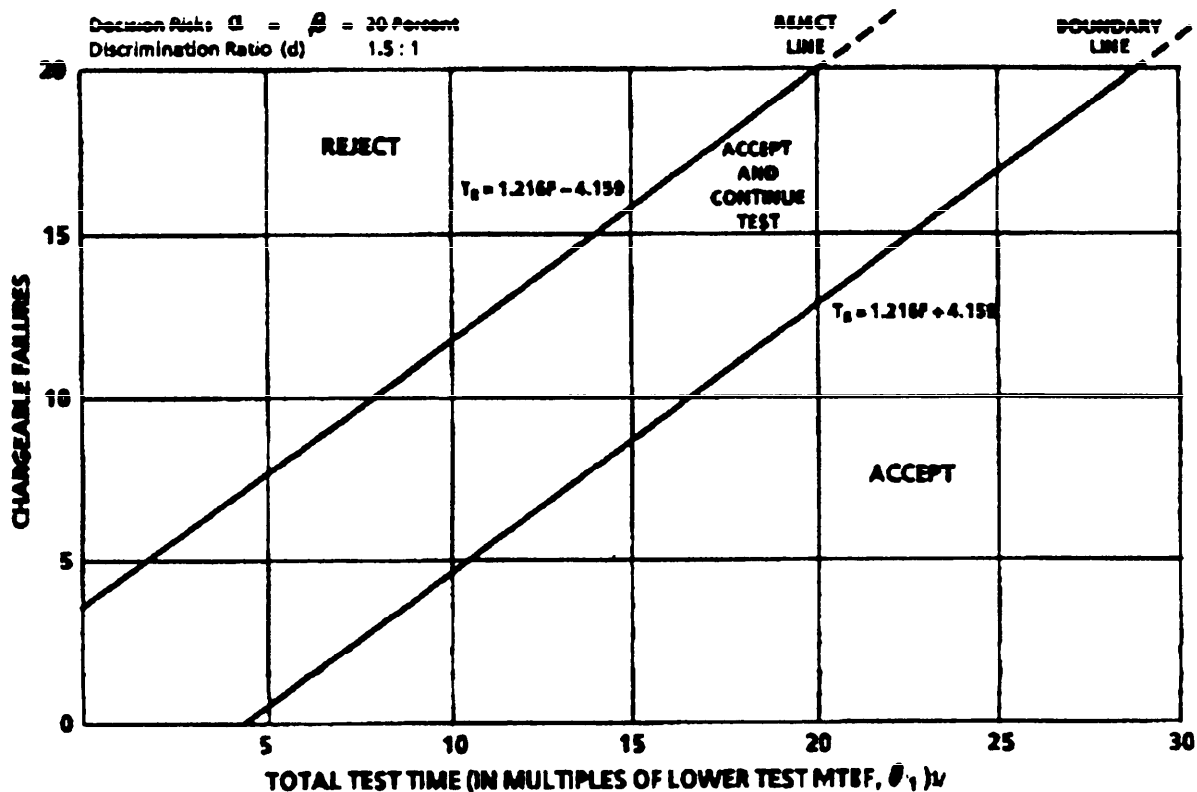

FIGURE 37. All-equipment test plan derived from Test Plan I-D (Continued)



TOTAL TEST TIME (IN MULTIPLES OF LOWER TEST MTBF,  $\theta_1$ )<sup>1</sup>

Chargeable failures	Standardized test time, t <sup>2</sup>		Chargeable failures	Standardized test time, t <sup>2</sup>	
	Reject line	Boundary line		Reject line	Boundary line
0	N/A	4.16	10	8.00	16.32
1	N/A	5.38	11	9.22	17.54
2	N/A	6.59	12	10.43	18.75
3	N/A	7.81	13	11.65	19.97
4	0.705	9.02	14	12.87	21.18
5	1.92	10.24	15	14.08	22.40
6	3.14	11.46	16	15.29	23.62
7	4.35	12.67	17	16.51	24.84
8	5.57	13.89	18	17.73	26.05
9	6.79	15.10	19	18.95	27.26

Accept-reject criteria

<sup>1</sup> Total test time is the summation of operating time of all units included in test sample.

<sup>2</sup> To determine the actual test time, multiply the standardized test time (t) by the lower test MTBF ( $\theta_1$ ).  
 (See 4.8.3.3.)

FIGURE 38. All-equipment test plan derived from Test Plan II-D.

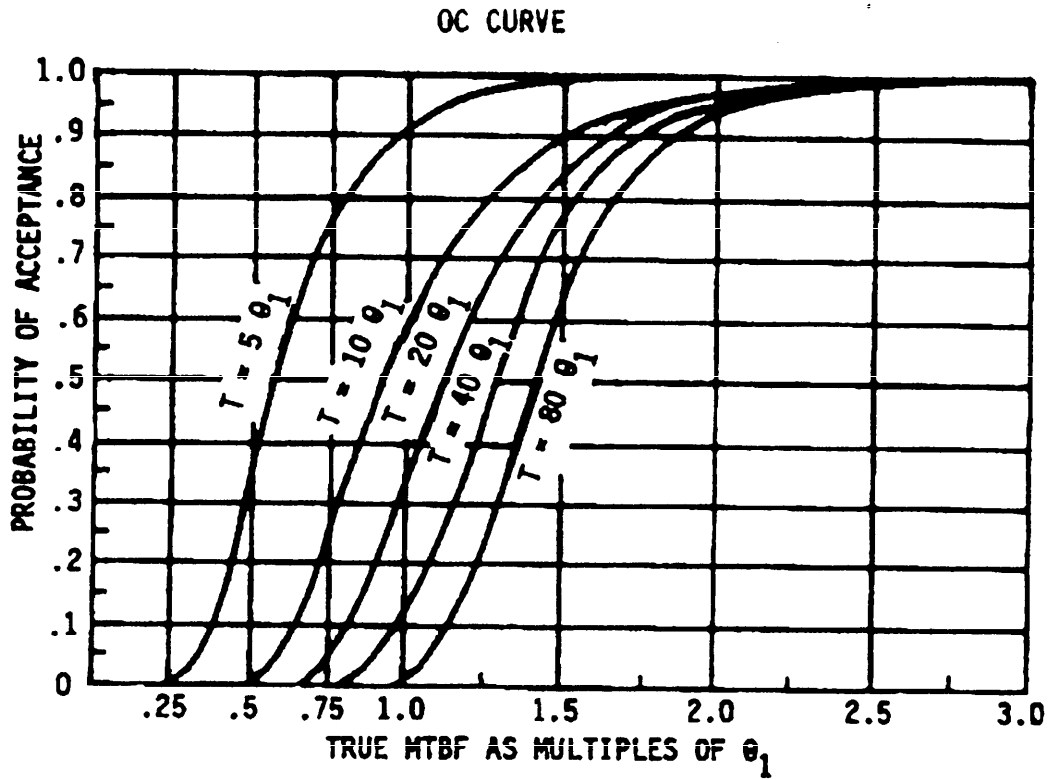
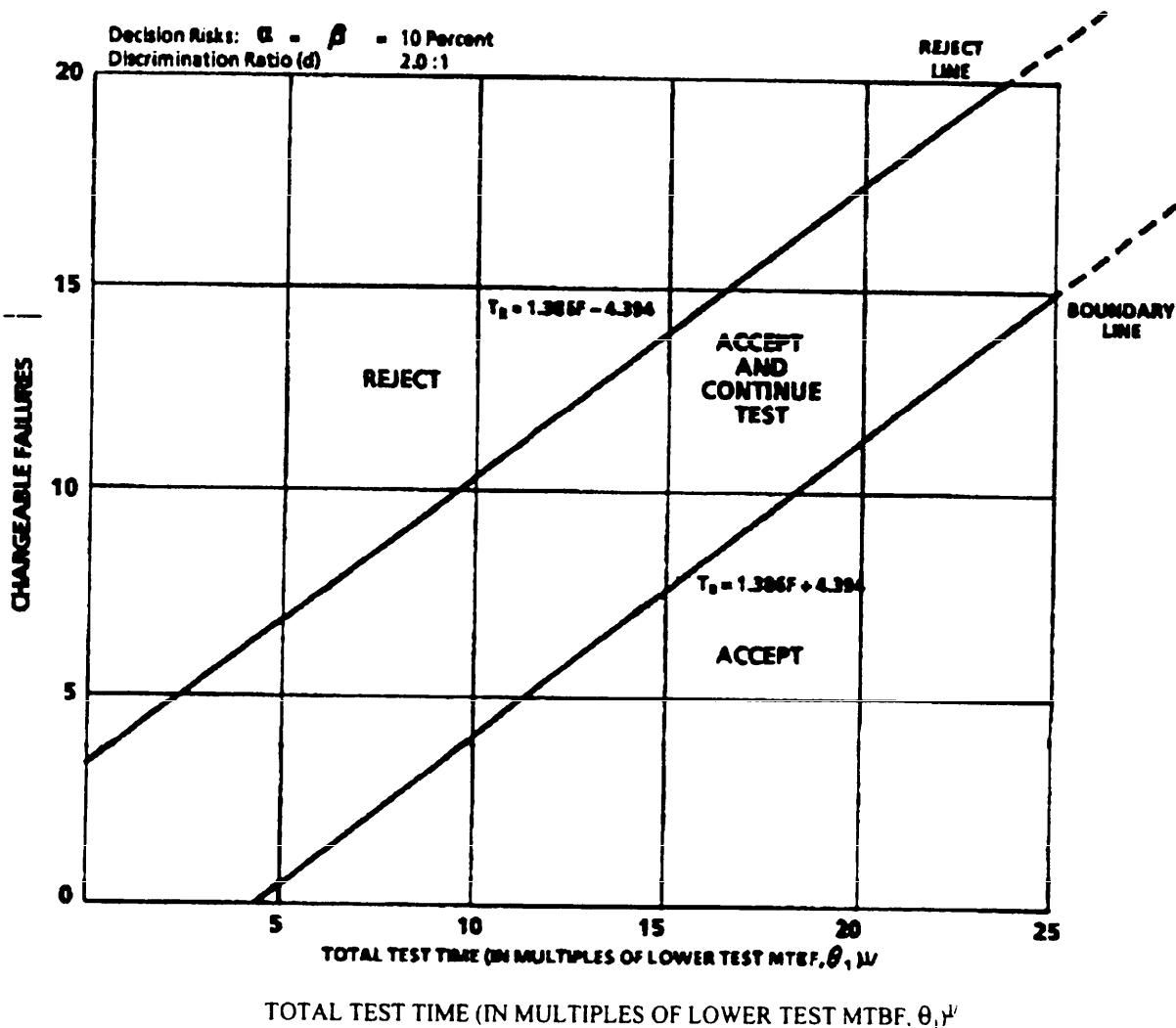

FIGURE 38. All-equipment test plan derived from Test Plan II-D. (Continued)



Chargeable failures	Standardized test time, $t^2$		Chargeable failures	Standardized test time, $t^2$	
	Reject line	Boundary line		Reject line	Boundary line
0	N/A	4.39	9	8.08	16.86
1	N/A	5.78	10	9.47	18.25
2	N/A	7.166	11	10.85	19.64
3	N/A	8.55	12	12.24	21.03
4	1.15	9.938	13	13.63	22.40
5	2.536	11.324	14	15.01	23.79
6	3.922	12.71	15	16.39	25.18
7	5.308	14.096	16	17.78	26.57
8	6.69	15.48			

Accept-reject criteria

<sup>1</sup> Total test time is the summation of operating time of all units included in test sample.

<sup>2</sup> To determine the actual test time, multiply the standardized test time (t) by the lower test MTBF ( $\theta_1$ ).

(See 4.8.3.3.)

FIGURE 39. All-equipment test plan derived from Test Plan III-D.

OC CURVE

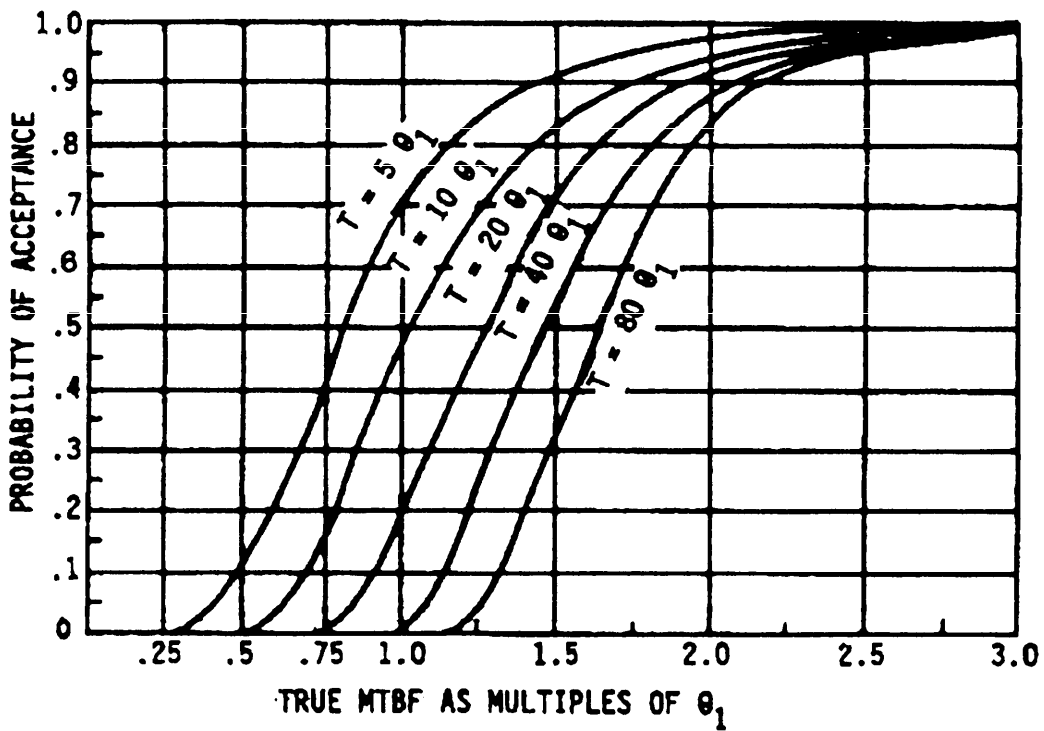
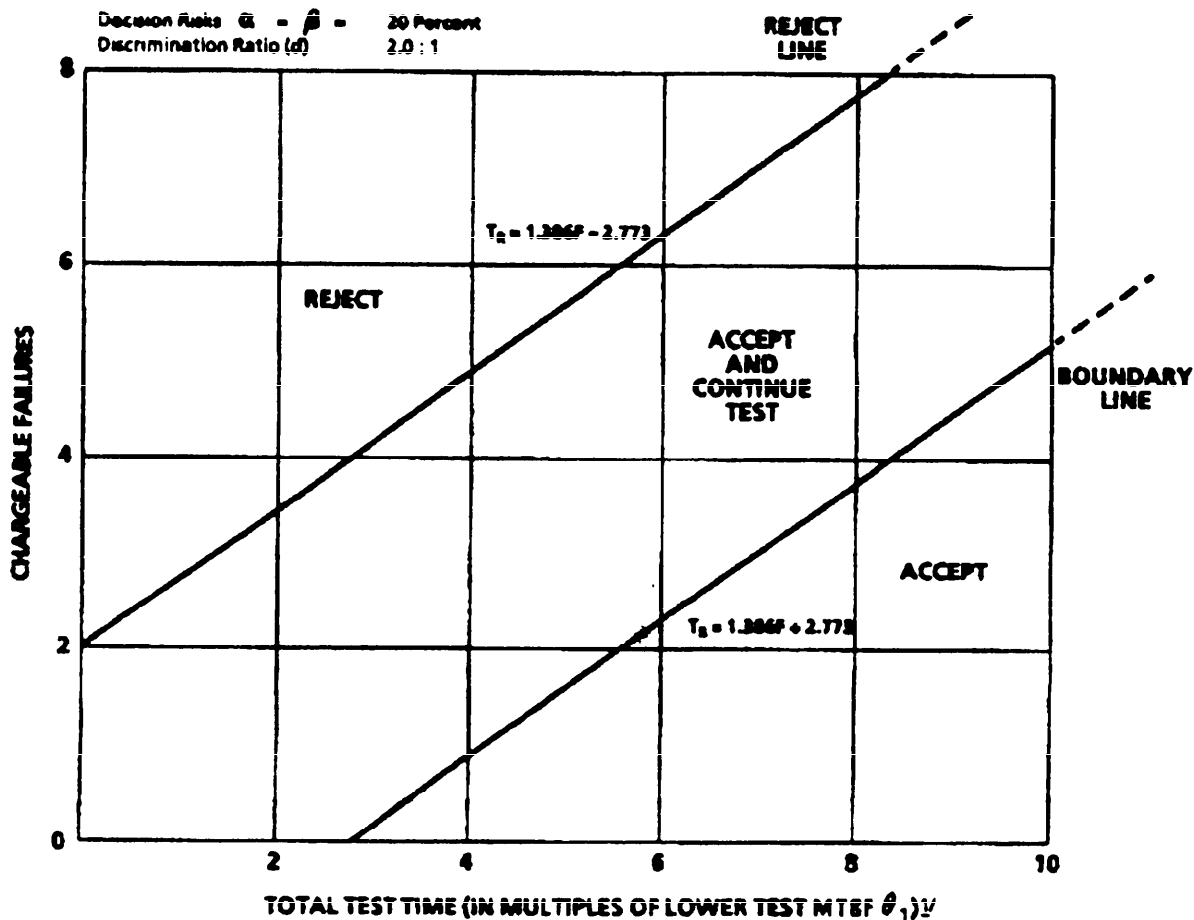

FIGURE 39. All-equipment test plan derived from Test Plan III-D (Continued)



TOTAL TEST TIME (IN MULTIPLES OF LOWER TEST MTBF  $\theta_1$ )<sup>1/2</sup>

Chargeable failures	Standardized test time, $t^2$	
	Reject line	Boundary line
0	N/A	2.77
1	N/A	4.16
2	N/A	5.55
3	1.39	6.93
4	2.77	8.32
5	4.16	9.70
6	5.54	11.09
7	6.93	12.48
8	8.32	13.86

Accept-reject criteria

- <sup>1/2</sup> Total test time is the summation of operating time of all units included in test sample.
- <sup>2</sup> To determine the actual test time, multiply the standardized test time ( $t$ ) by the lower test MTBF ( $\theta_1$ ). (See 4.8.3.3)

FIGURE 40. All-equipment test plan derived from Test Plan IV-D.

OC CURVE

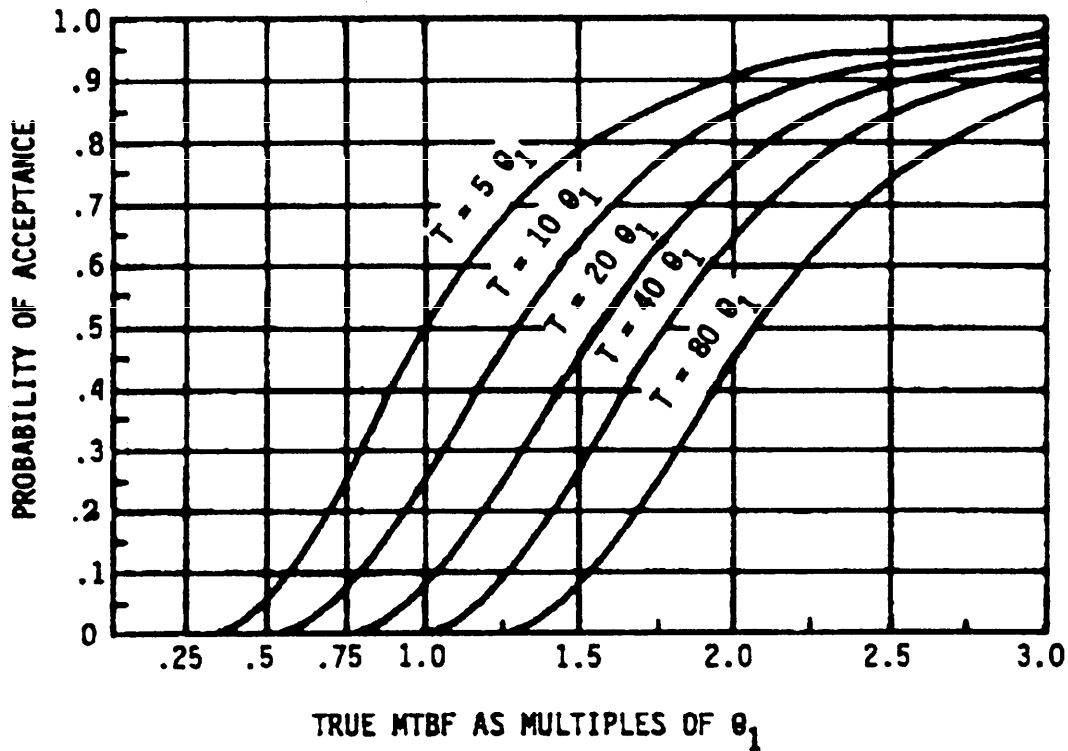
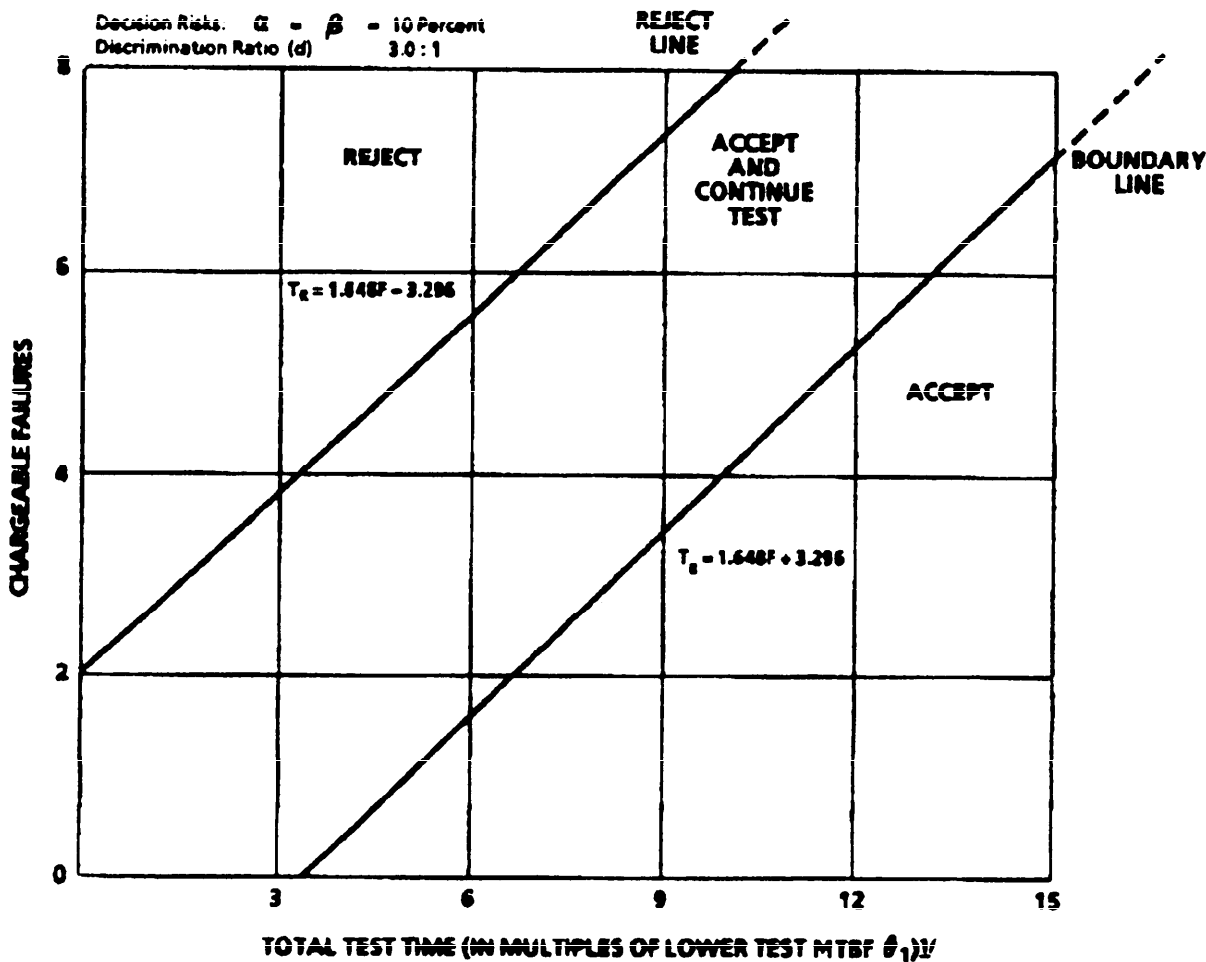

FIGURE 40. All-equipment test plan derived from Test Plan IV-D. (Continued)



TOTAL TEST TIME (IN MULTIPLES OF LOWER TEST MTBF  $\theta_1$ )<sup>1/</sup>

Chargeable failures	Standardized test time, $t$ <sup>2/</sup>	
	Reject line	Boundary line
0	N/A	3.30
1	N/A	4.94
2	0	6.59
3	1.65	8.24
4	3.30	9.87
5	4.94	11.54
6	6.59	13.18
7	8.24	14.83

Accept-reject criteria

<sup>1/</sup> Total test time is the summation of operating time of all units included in test sample

<sup>2/</sup> To determine the actual test time, multiply the standardized test time ( $t$ ) by the lower test MTBF ( $\theta_1$ ).  
 (See 4.8.3.3.)

FIGURE 41. All-equipment test plan derived from Test Plan V-D.

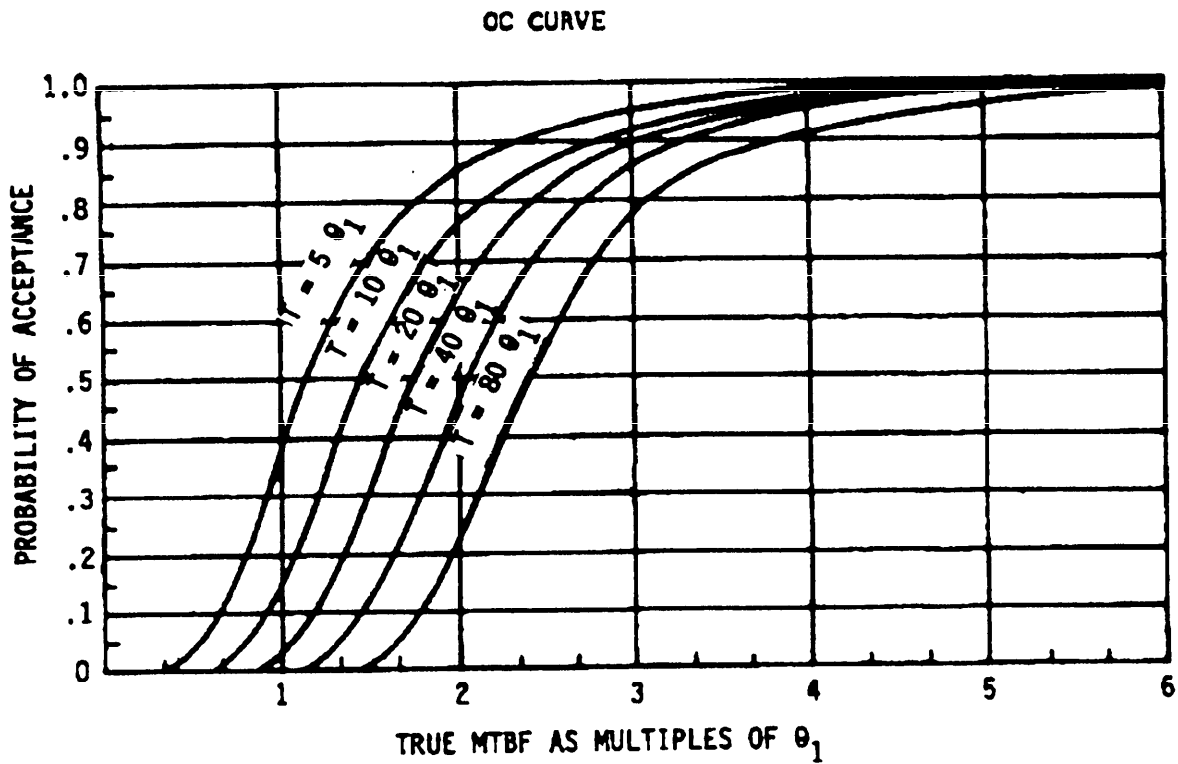
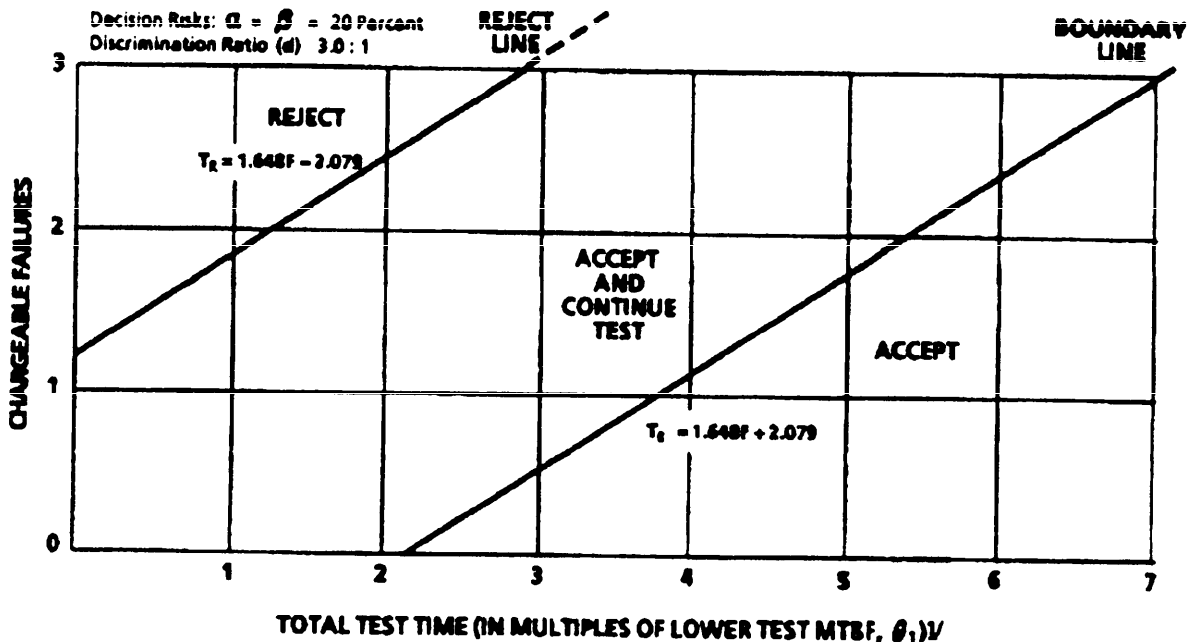

FIGURE 41. All-equipment test plan derived from Test Plan V-D.



TOTAL TEST TIME (IN MULTIPLES OF LOWER TEST MTBF,  $\theta_1$ )<sup>1/</sup>

Chargeable failures	Standardized test time, $t^2$	
	Reject line	Boundary line
0	N/A	2.08
1	N/A	3.73
2	1.22	5.38
3	2.87	7.02

Accept-reject criteria

<sup>1/</sup> Total test time is the summation of operating time of all units included in test sample.

<sup>2/</sup> To determine the actual test time, multiply the standardized test time ( $t$ ) by the lower test MTBF ( $\theta_1$ ). (See 4.8.3.3.)

FIGURE 42. All-equipment test plan derived from Test Plan VI-D

OC CURVE

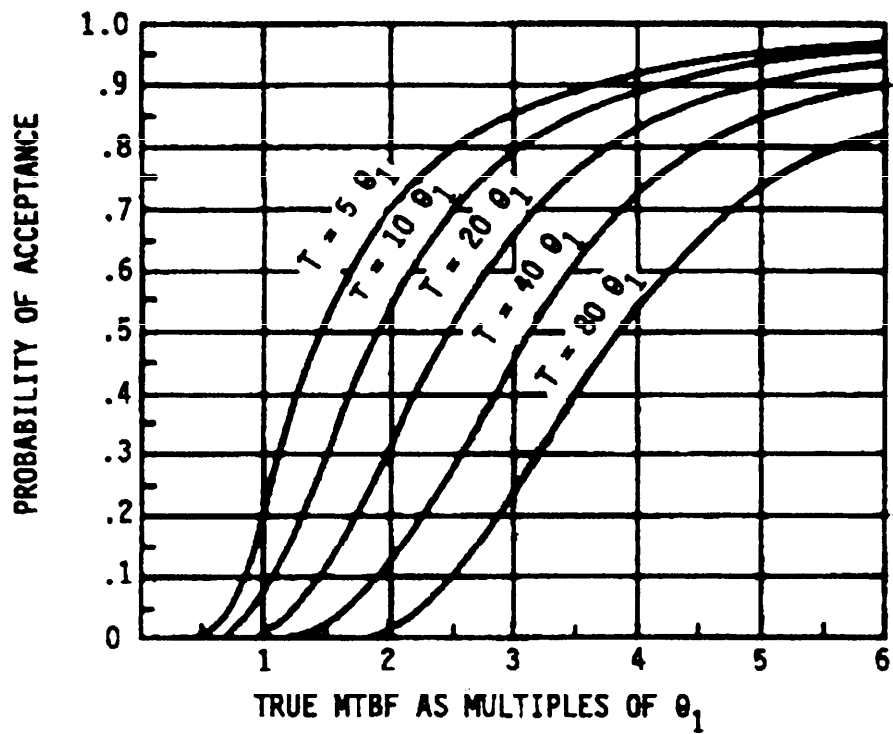
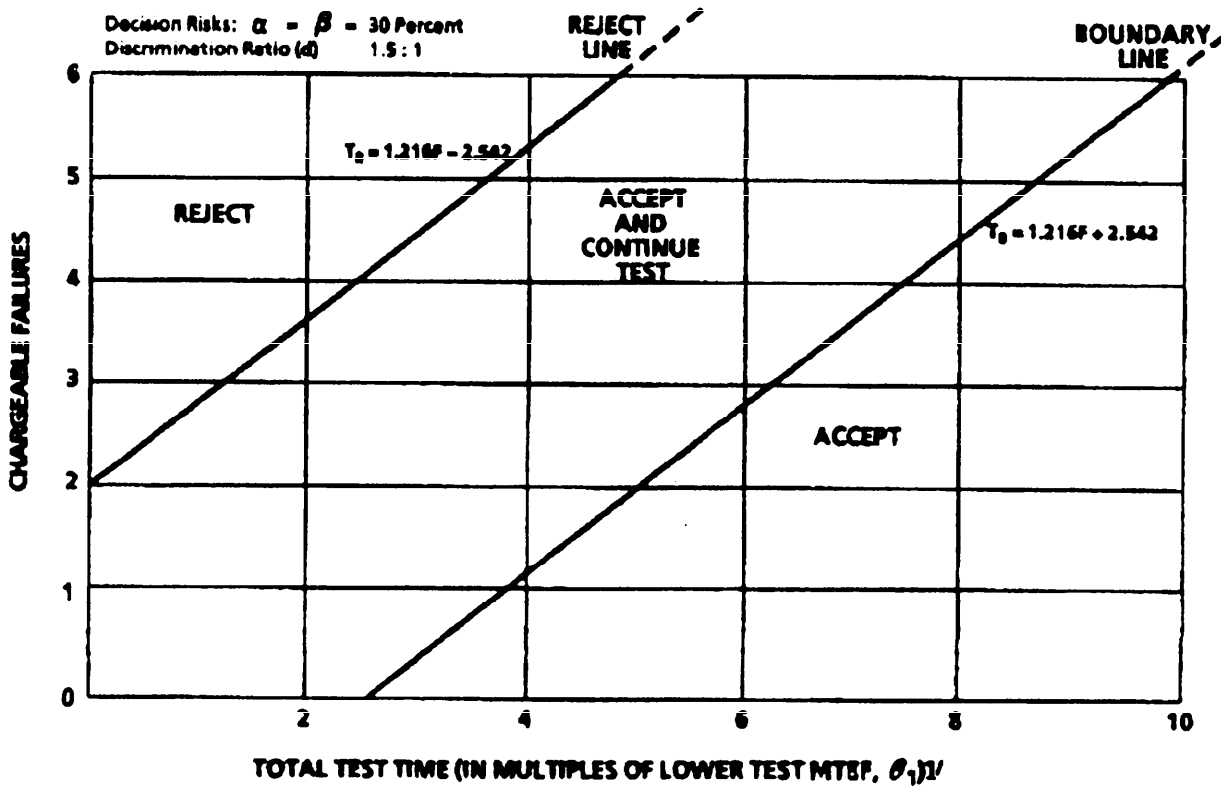

FIGURE 42. All-equipment test plan derived from Test Plan VI-D. (Continued)



TOTAL TEST TIME (IN MULTIPLES OF LOWER TEST MTBF,  $\theta_1$ )<sup>1/</sup>

Chargeable failures	Standardized test time, $t^2$	
	Reject line	Boundary line
0	N/A	2.54
1	N/A	3.76
2	N/A	4.97
3	1.106	6.19
4	2.32	7.40
5	3.54	8.62
6	4.75	9.84

Accept-reject criteria

<sup>1/</sup> Total test time is the summation of operating time of all units included in test sample.

<sup>2/</sup> To determine the actual test time, multiply the standardized test time ( $t$ ) by the lower test MTBF ( $\theta_1$ ).  
 (See 4.8.3.3.)

FIGURE 43. All-equipment test plan derived from Test Plan VII-D.

OC CURVE

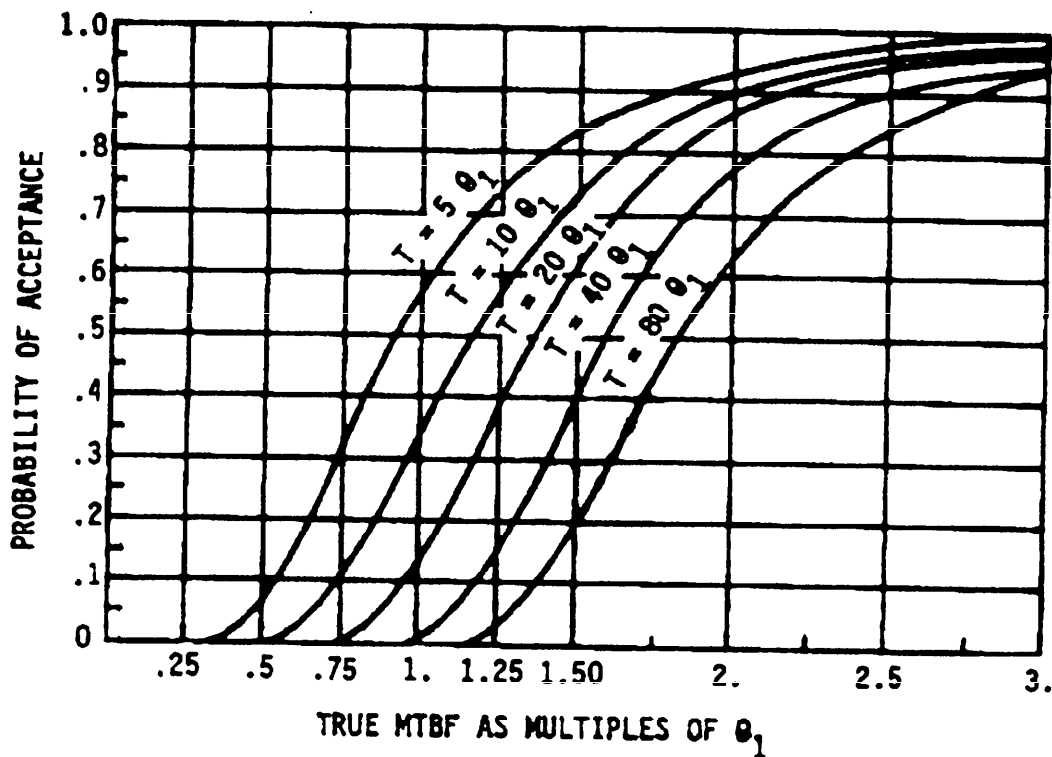
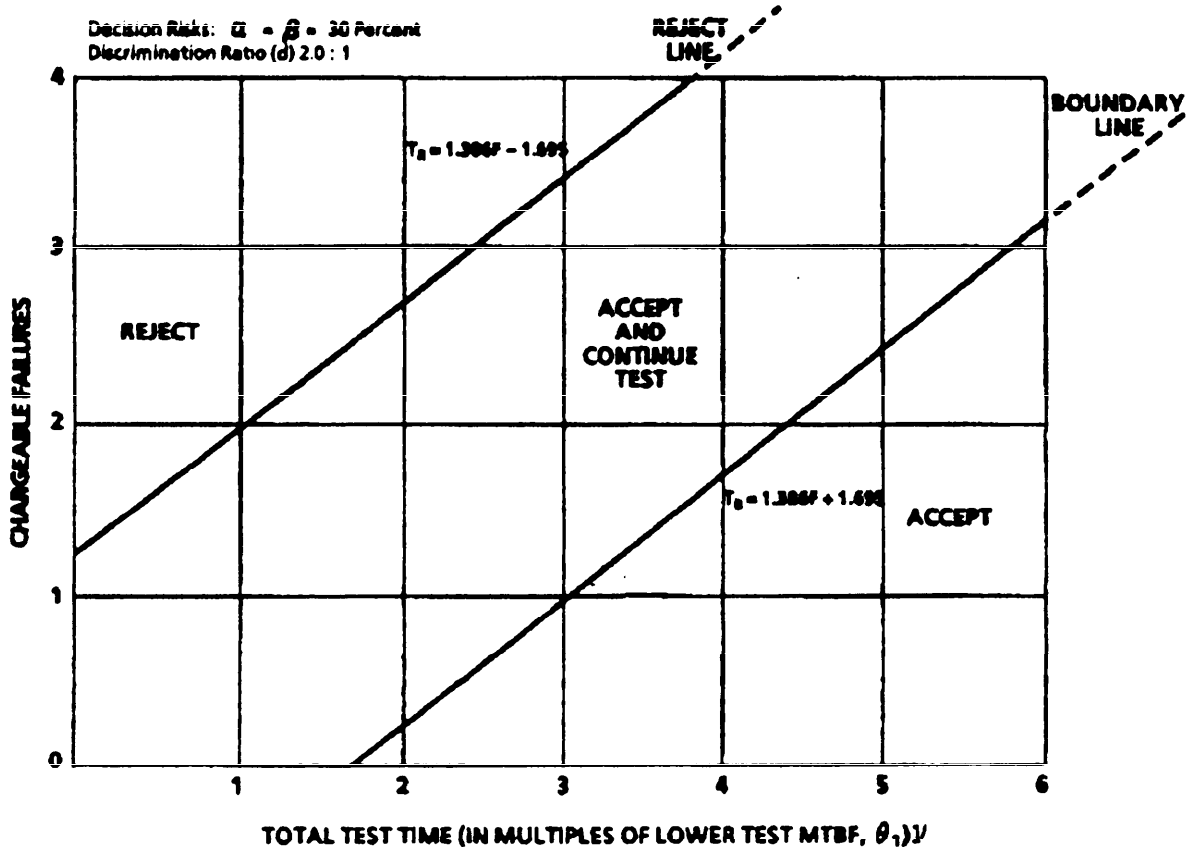

FIGURE 43. All-equipment test plan derived from Test Plan VII-D. (Continued)



TOTAL TEST TIME (IN MULTIPLES OF LOWER TEST MTBF,  $\theta_1$ )<sup>1</sup>

Chargeable failures	Standardized test time, $t^2$	
	Reject line	Boundary line
0	N/A	1.70
1	N/A	3.08
2	1.077	4.47
3	2.46	5.85

Accept-reject criteria

<sup>1</sup> Total test time is the summation of operating time of all units included in test sample.

<sup>2</sup> To determine the actual test time, multiply the standardized test time ( $t$ ) by the lower test MTBF ( $\theta_1$ ).  
 (See 4.8.3.3.)

FIGURE 44. All-equipment test plan derived from Test Plan VIII-D.

OC CURVE

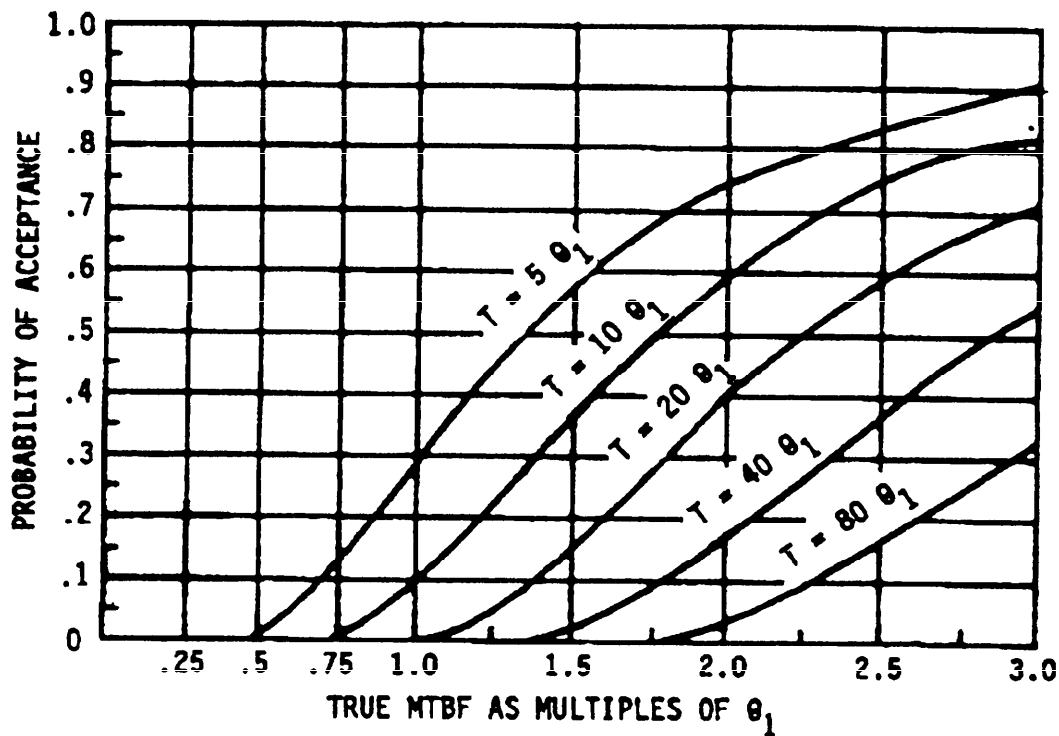

FIGURE 44. All-equipment test plan derived from Test Plan VIII-D. (Continued)

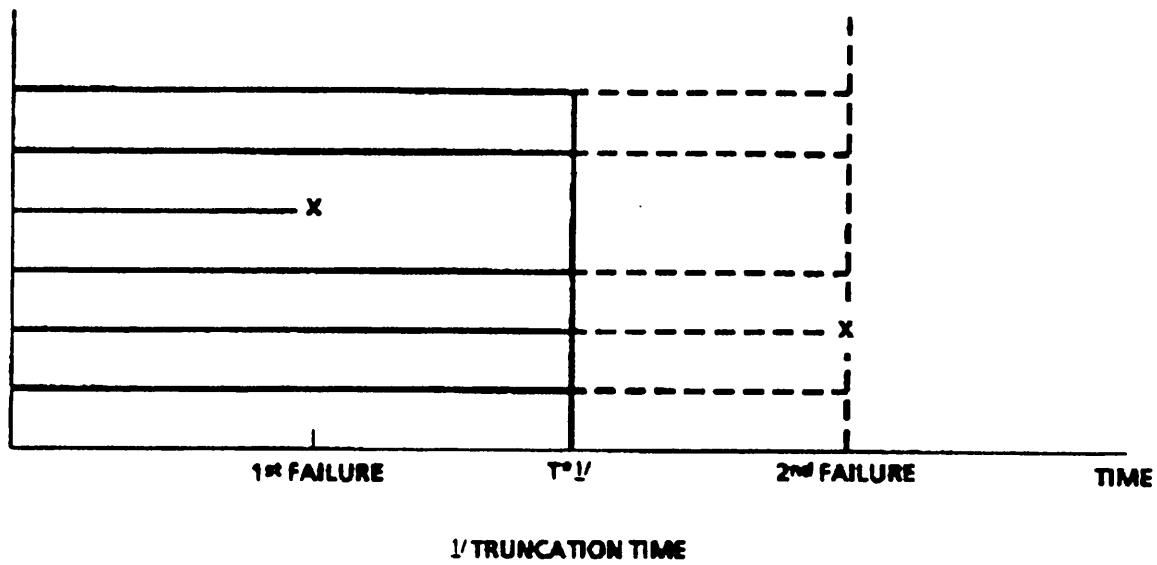

FIGURE 45. Time truncation (type I censoring)

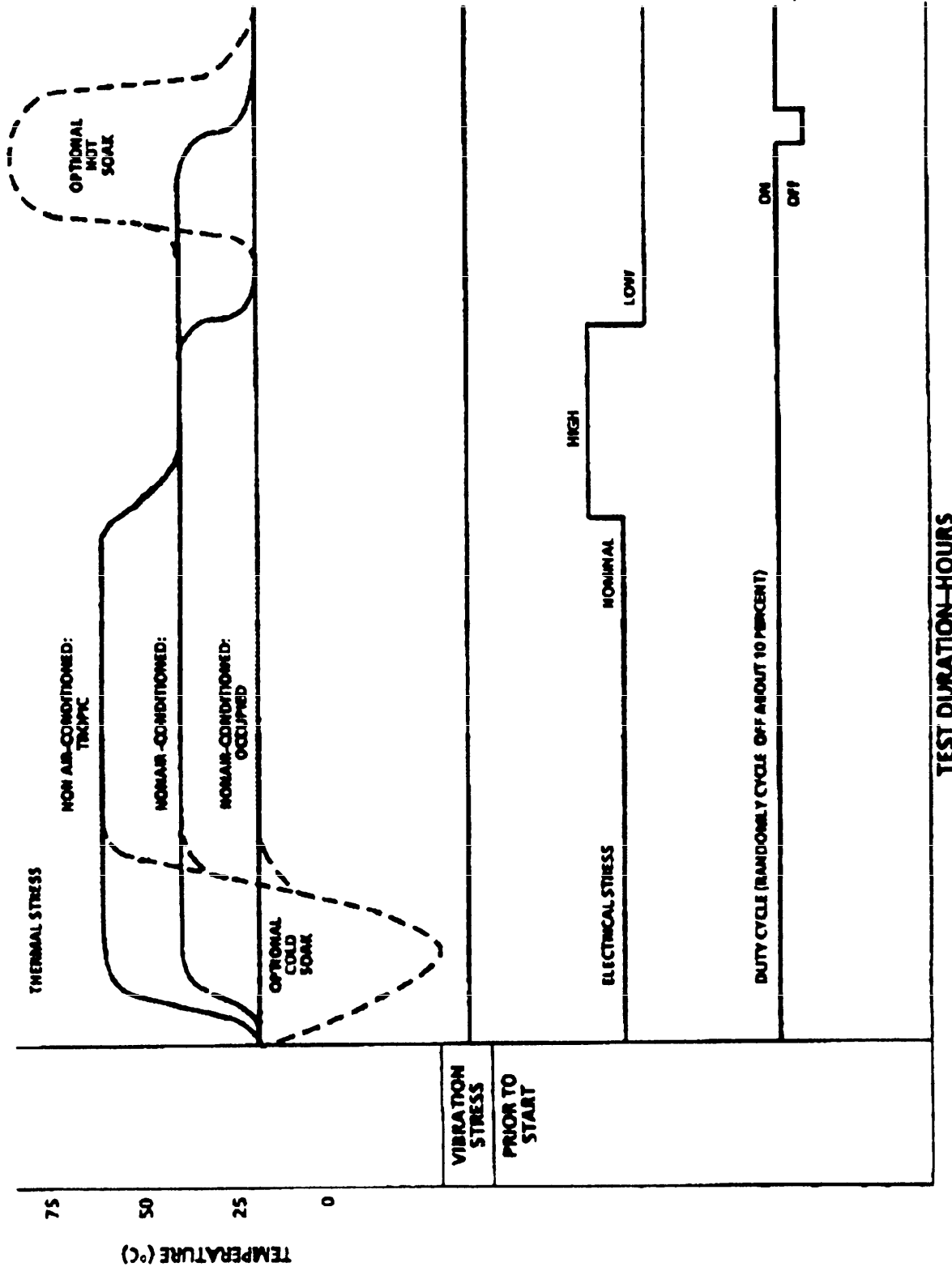
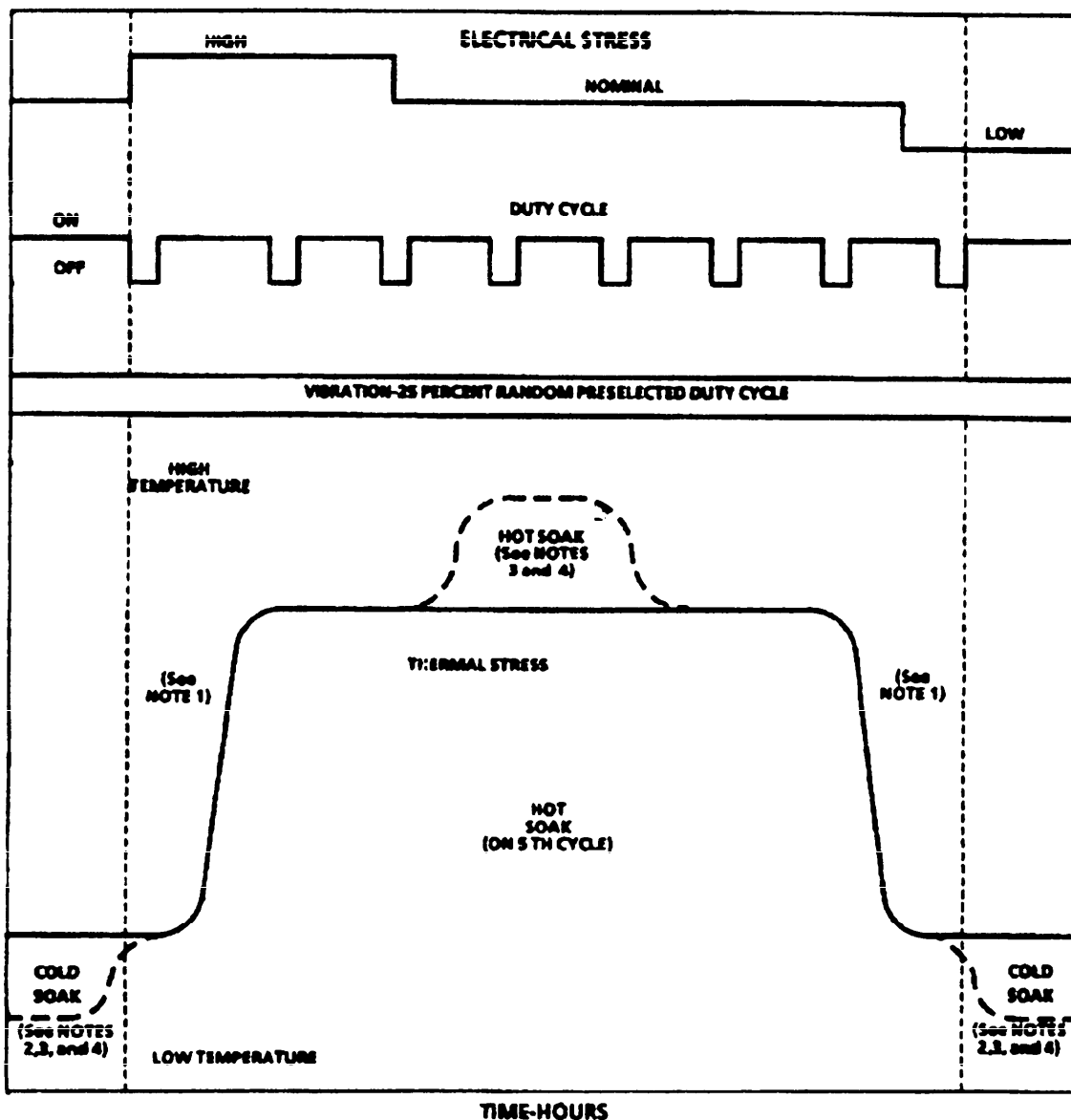

FIGURE 46. Combined environmental test profile for fixed ground equipment.



NOTES:

1. Rate of chamber temperature change shall be a minimum of 5°C per minute, unless otherwise specified or approved by the procuring activity.
2. Moisture level to be sufficient to cause visible condensation, frosting and freezing
3. Hot soad and cold soak are optional
4. Vibration, electrical stress, duty cycle OFF

FIGURE 47. Combined environmental test profile for mobile ground equipment

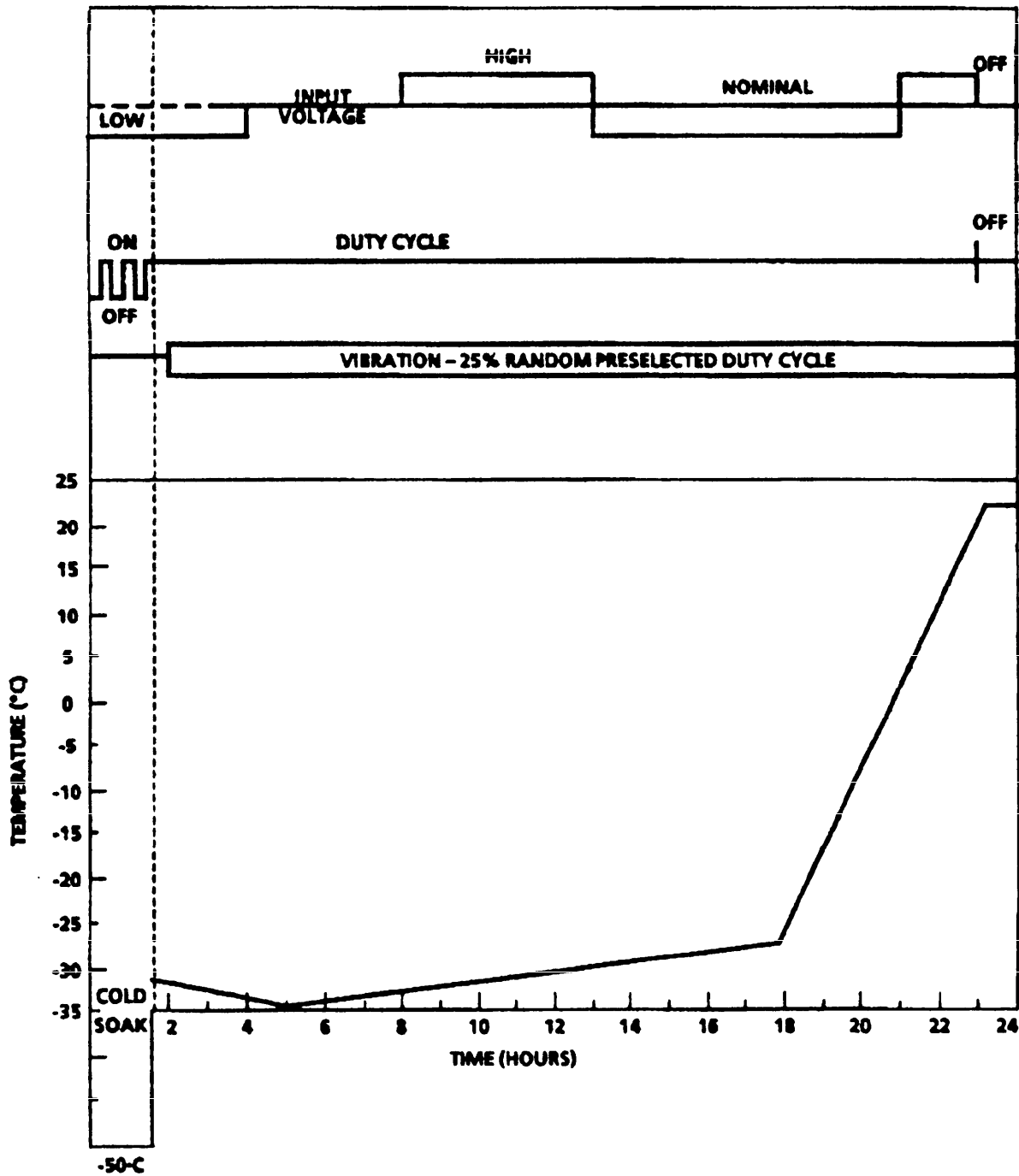

FIGURE 48. Naval surface craft, mission environmental profile for externally mounted equipment (cold cycle)

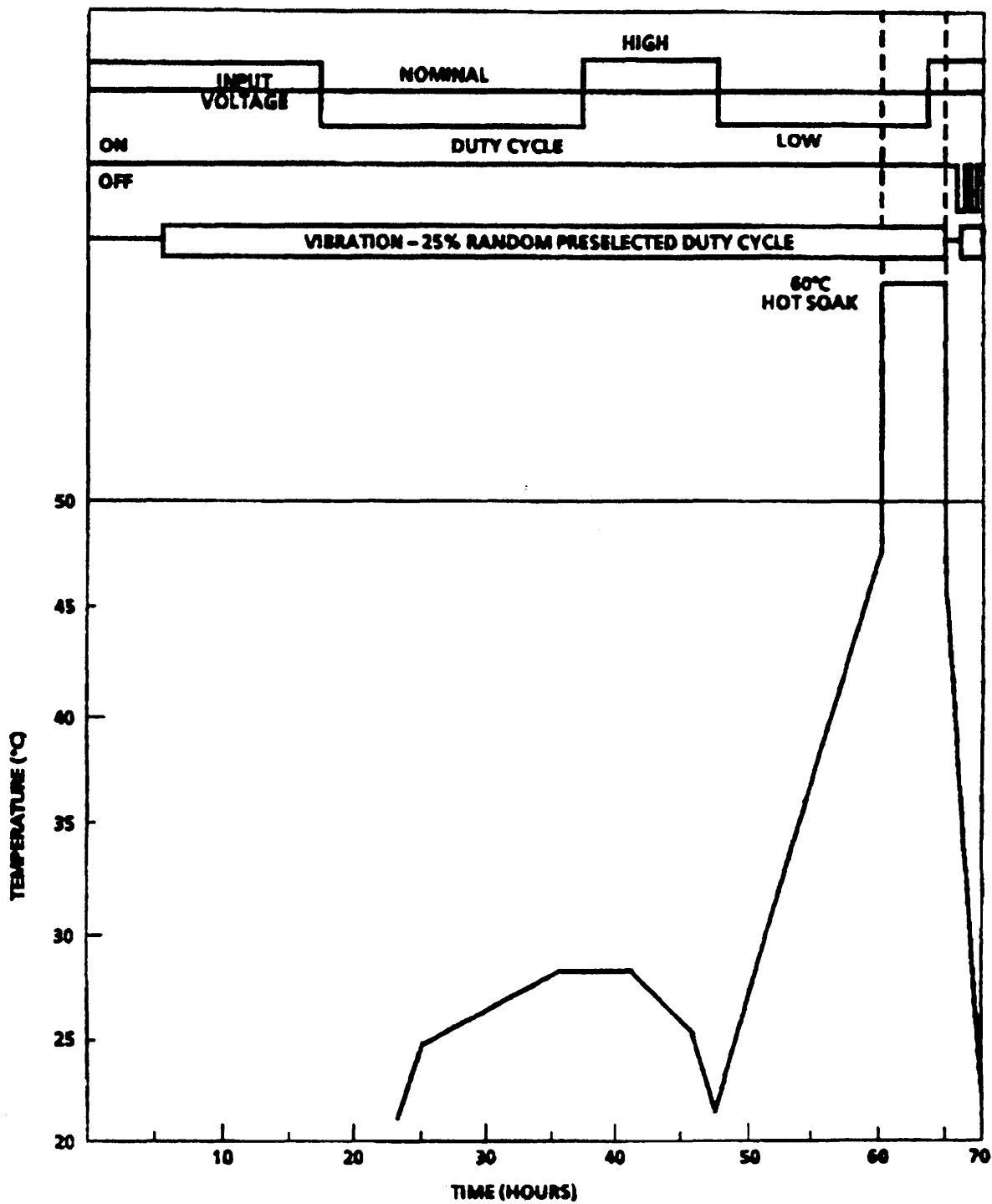

FIGURE 49. Naval surface craft, mission environmental profile for externally mounted equipment (hot cycle)

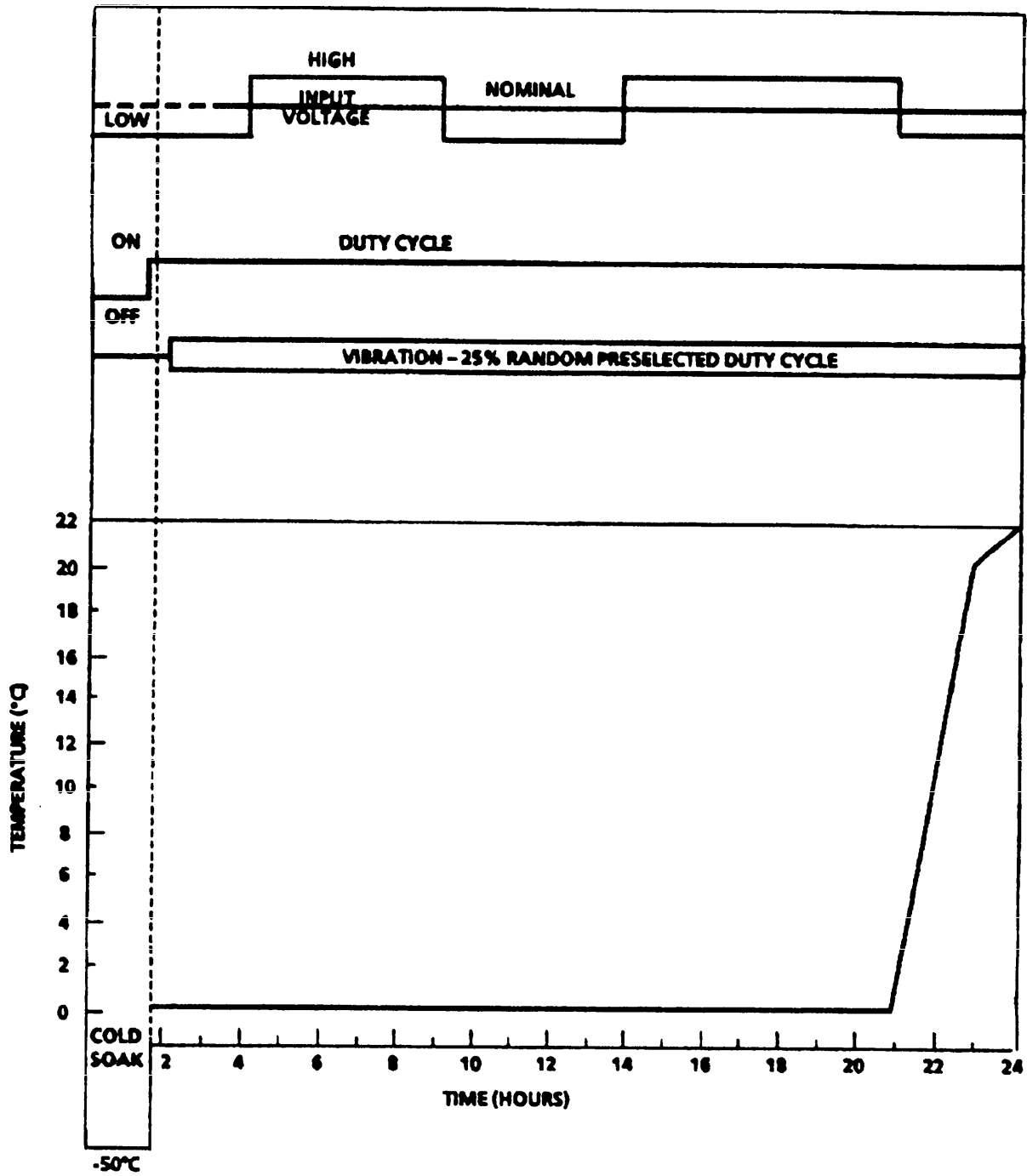

FIGURE 50. Naval surface craft mission environmental profile for externally mounted equipment (cold cycle)

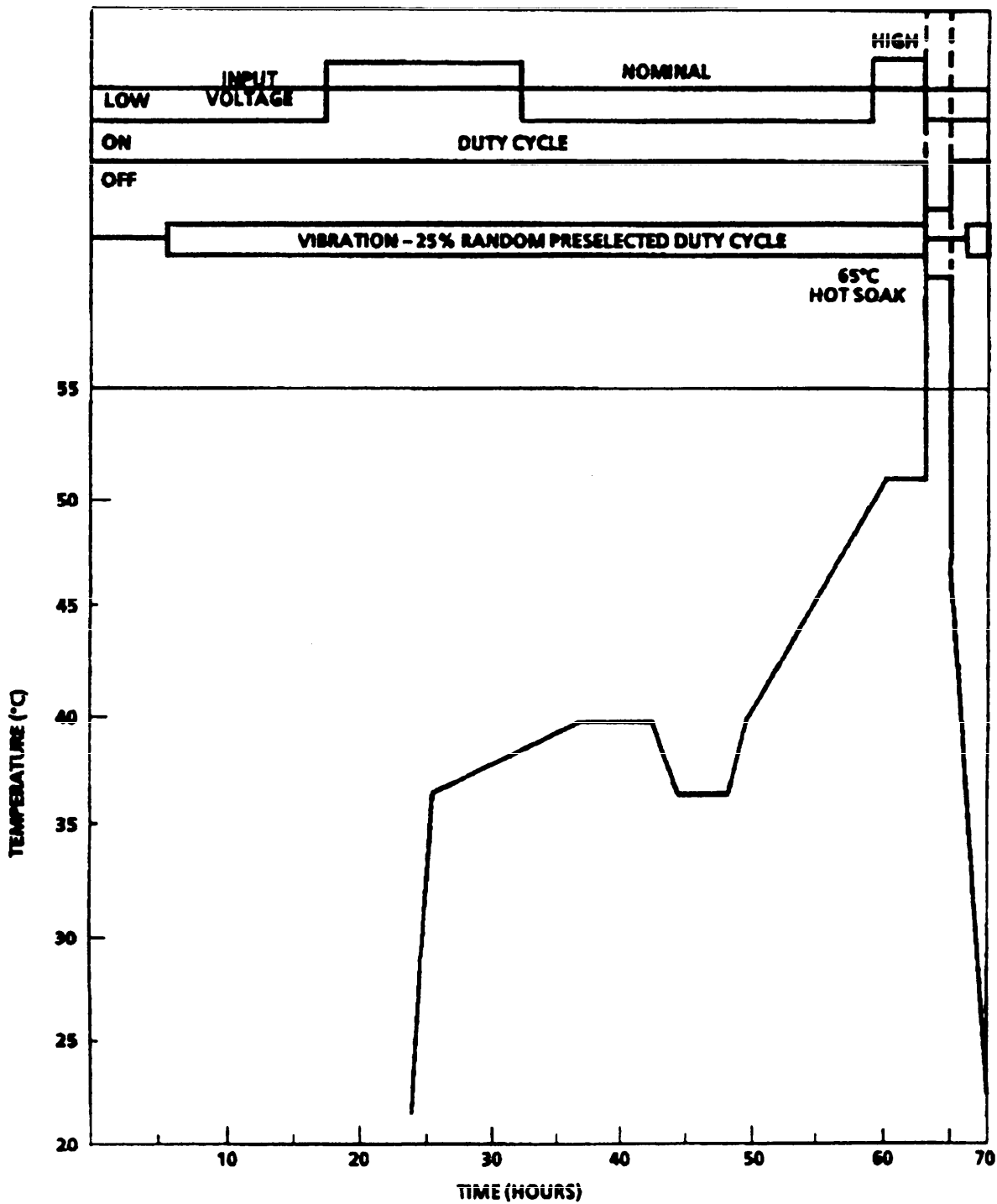

FIGURE 51. Naval surface craft mission environmental profile for externally mounted equipment (hot cycle)

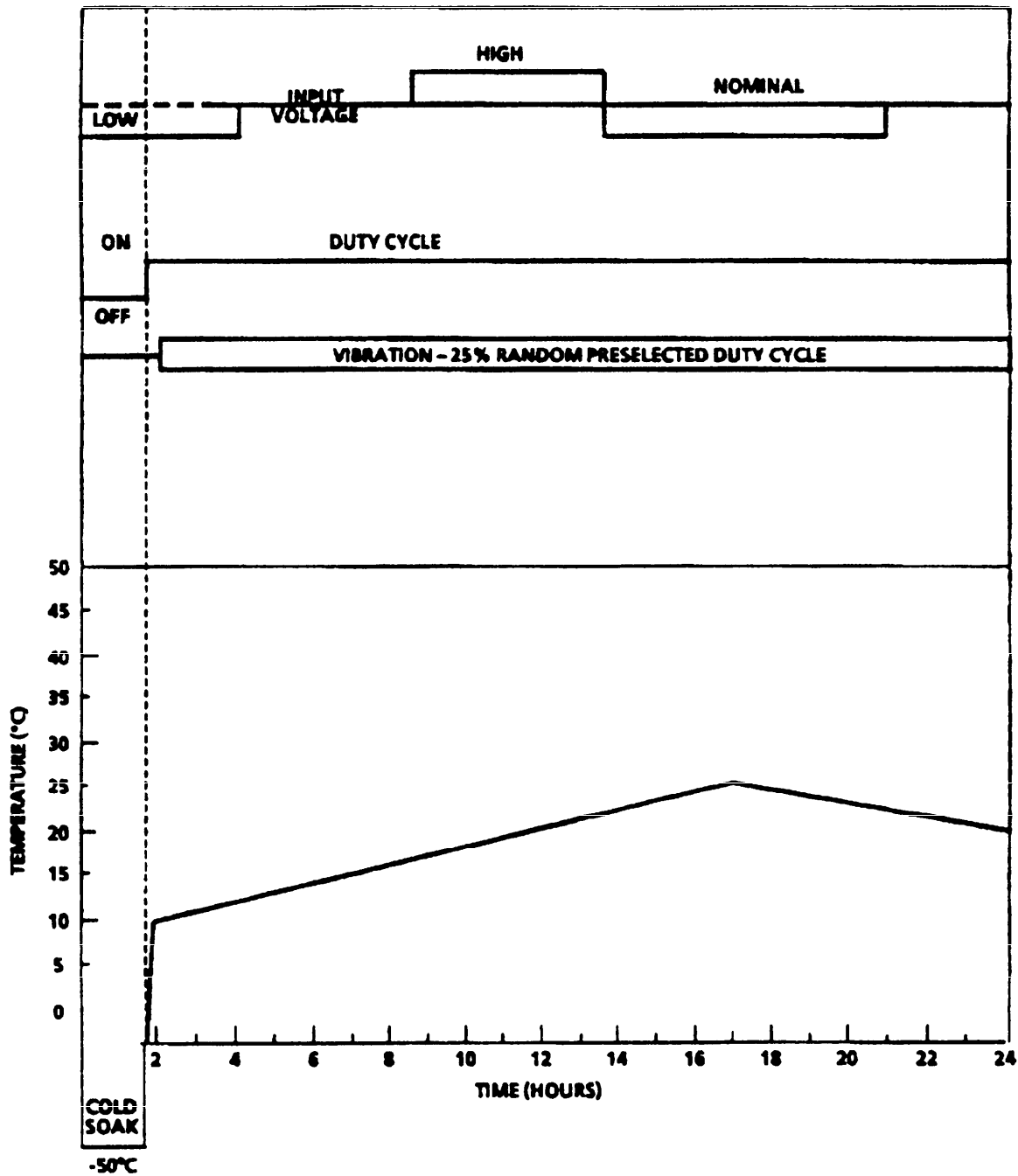

FIGURE 52. Naval surface craft, mission environmental profile for externally mounted equipment (temperature controlled)

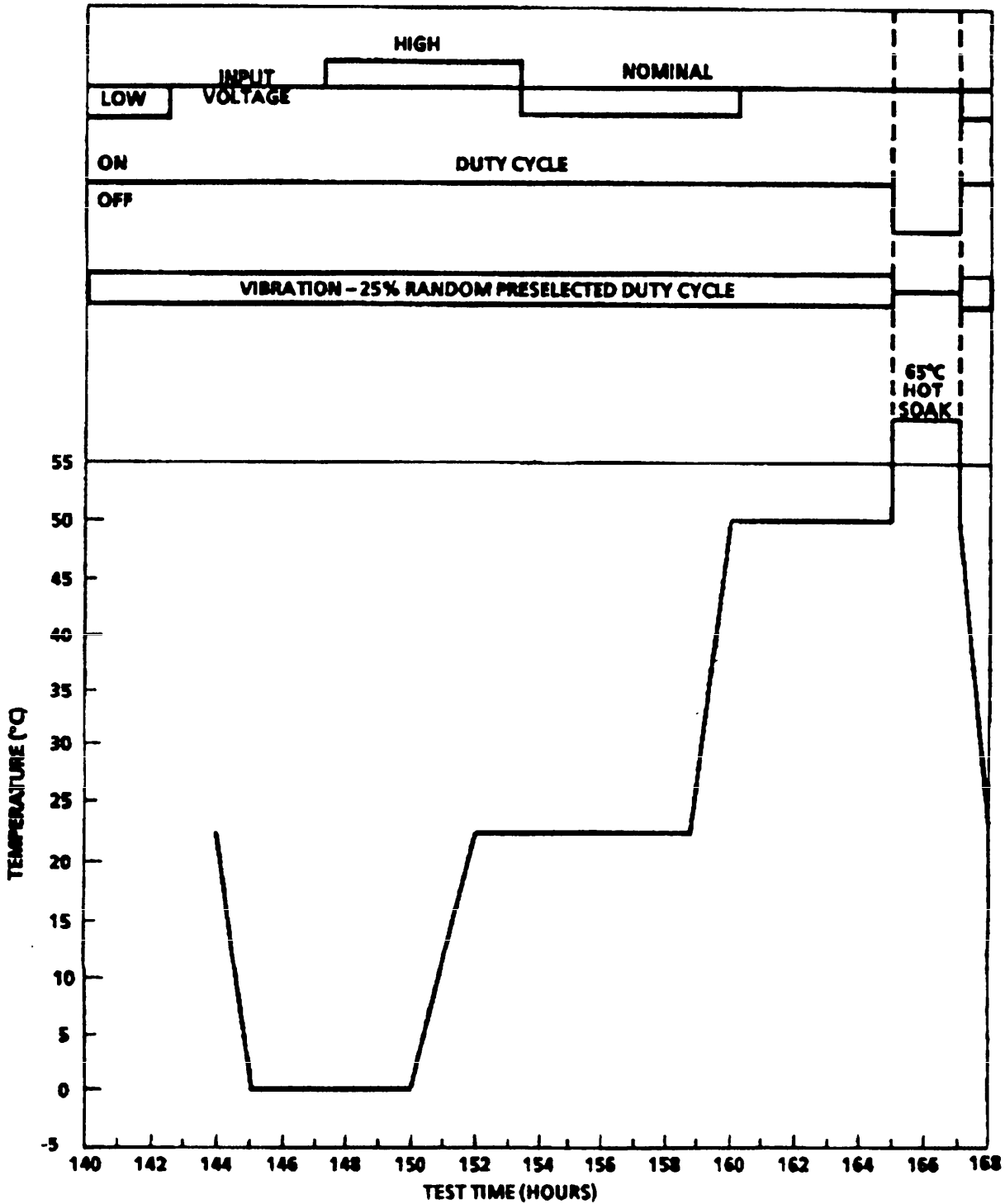
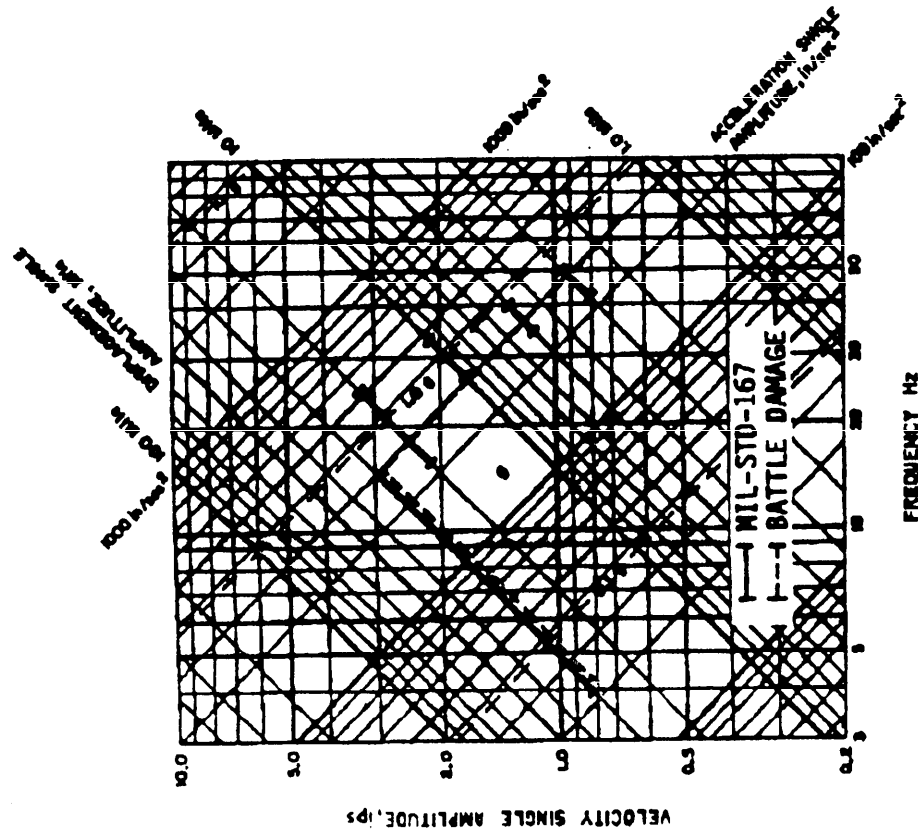
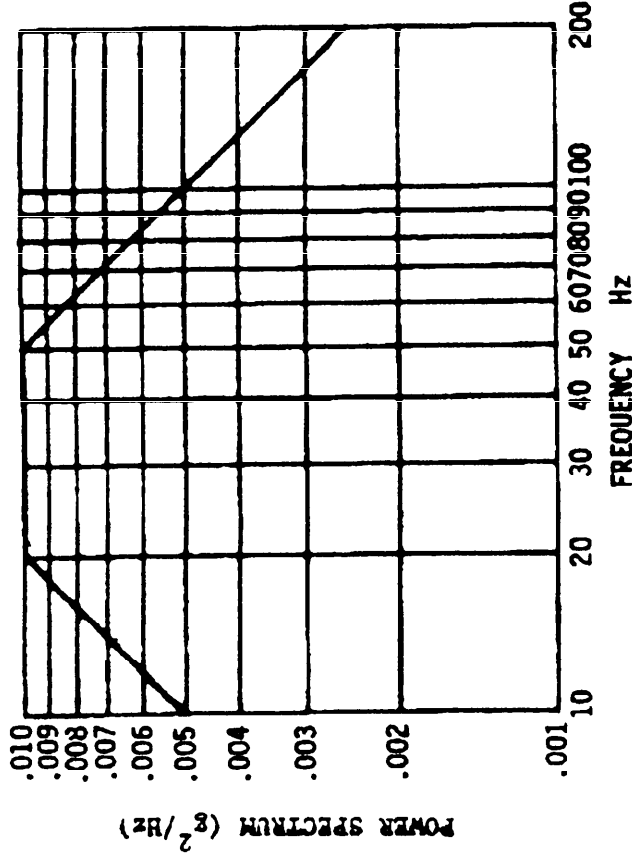

FIGURE 53. Naval surface craft, mission environmental profile for externally mounted equipment (temperature controlled)



A. Battle damage spectrum



Vibration schedule: 3 hours out of a 24-hour cycle.  
 Apply spectrum A once for 10 min. (5 min. up/5 min. down) 10 minutes with no vibration  
 Apply spectrum B for 20 min. (1  $g_{rms}$ ) with 10 minute breaks between cycles.

B. Transportation random spectrum

FIGURE 54. Surface craft and submarine vibration spectrum

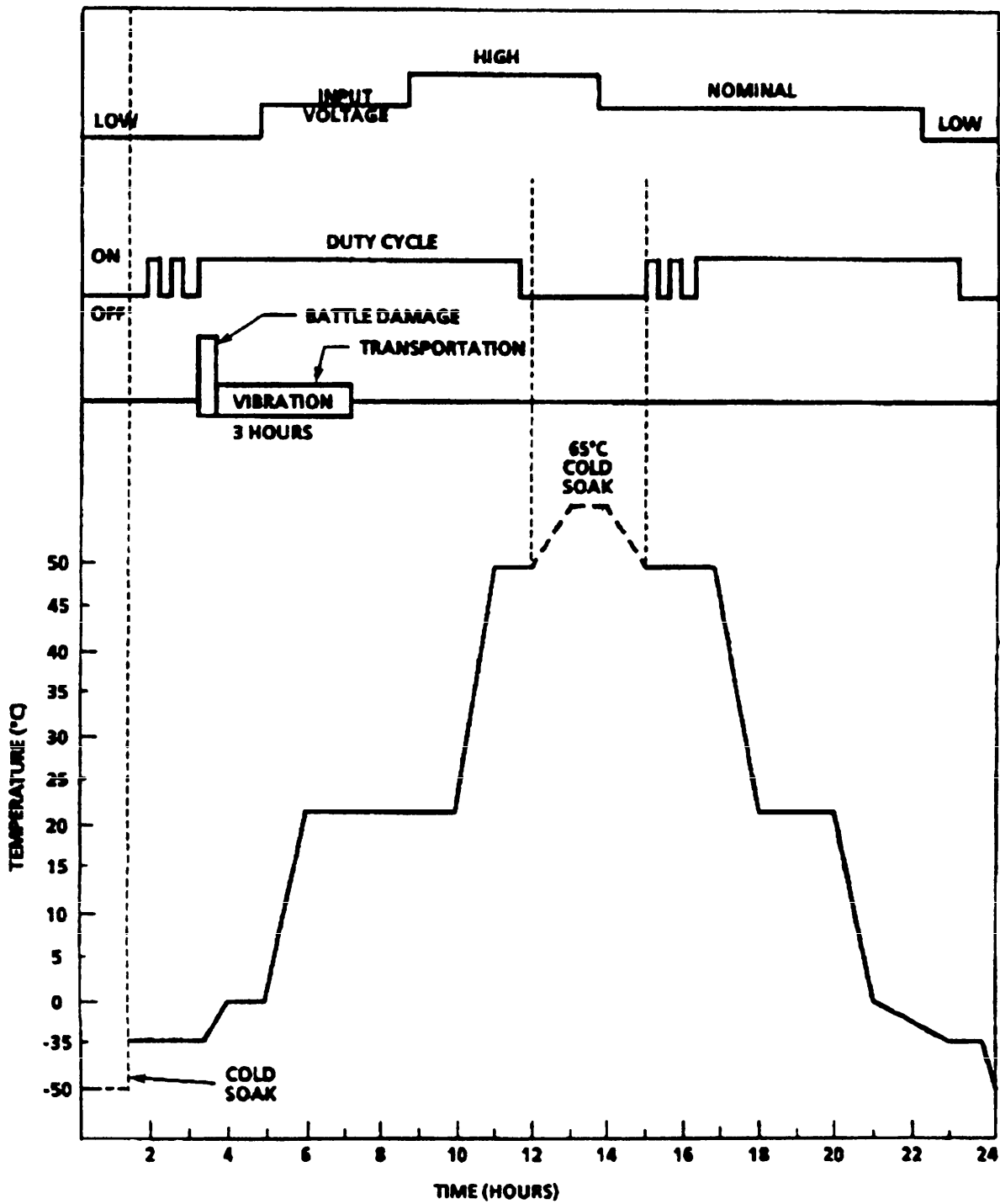
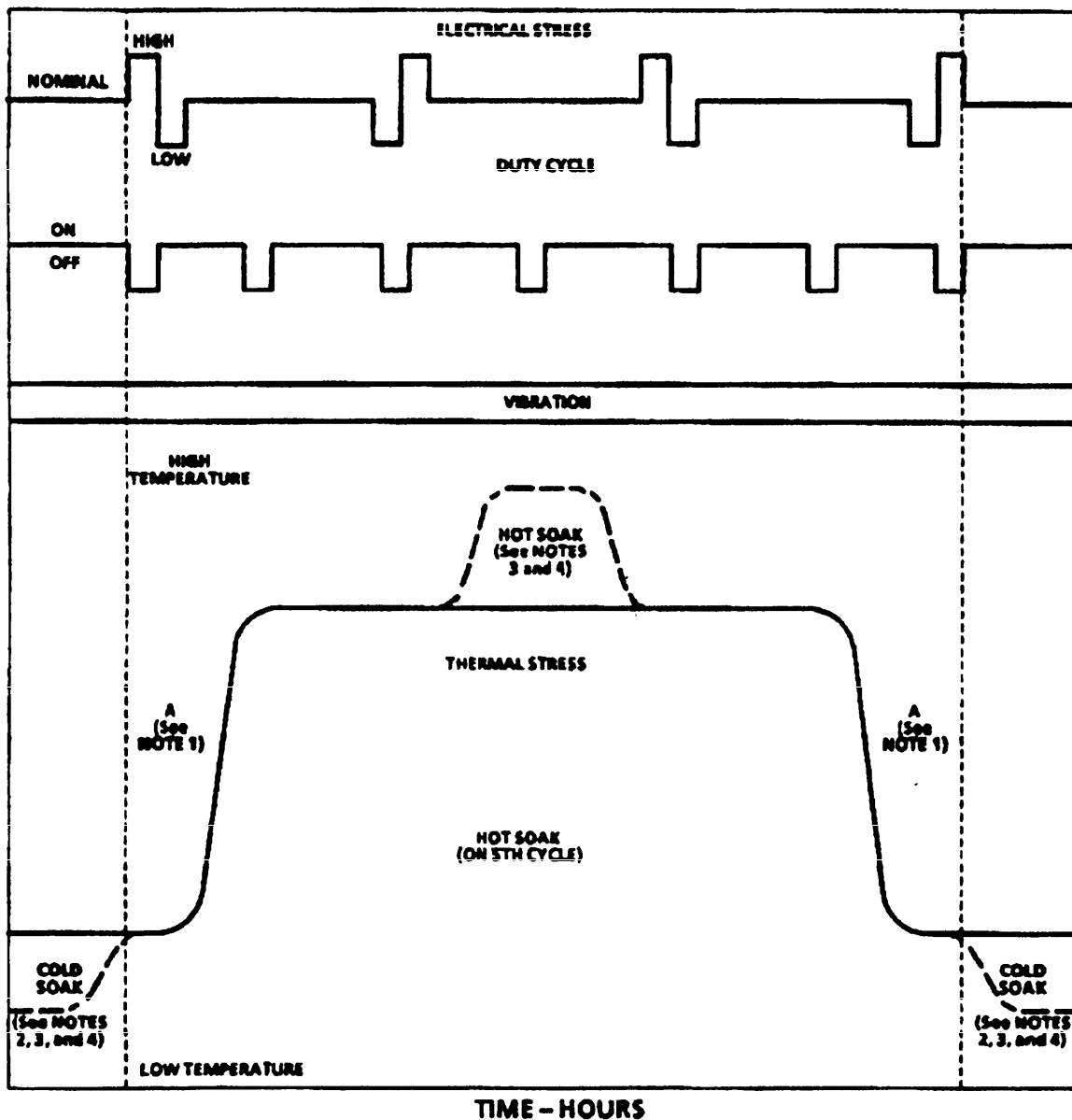

FIGURE 55. Submarine profile



**NOTES:**

1. Rate of chamber temperature change shall be a minimum of 5°C per minute, unless otherwise specified or approved by the procuring activity.
2. Moisture level to be sufficient to cause visible condensation, frosting and freezing
3. Hot soak and cold soak are optional
4. Vibration, electrical stress, duty cycle OFF.

FIGURE 56. Combined environmental test profile for marine craft equipment

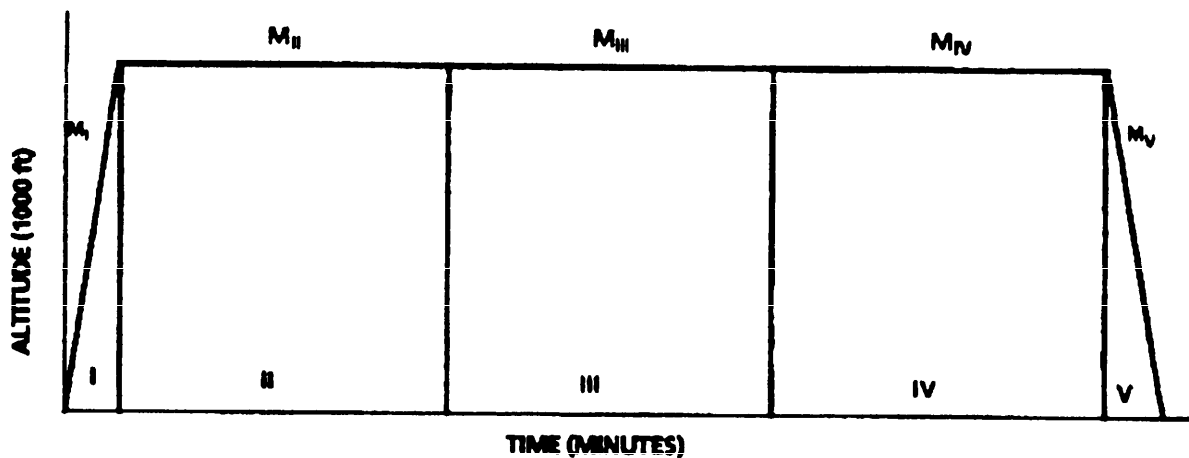

Mission Type	Characteristics	Phase				
		I	II	III	IV	V
<b>ATTACK AIRCRAFT</b>						
Low-Low- Low	Altitude (1000 ft)	0-2	2	2	2	2-0
	Mach No. (M)	0.6	0.4	0.68	0.4	0.4
	Duration (mm.)	2	60	8	67	3
Ferry	Altitude (1000 ft)	0-32		32		32-0
	Mach No. (M)	0.6		0.69		0.4
	Duration (mm.)	10		285		10
<b>ANTI-SUBMARINE WARFARE AIRCRAFT</b>						
Seek & Attack	Altitude (1000 ft)	0-40	40	40	40	40-0
	Mach No. (M)	0.6	0.6	0.65	0.6	0.4
	Duration (mm.)	15	60	265	55	20
Surface surveillance	Altitude (1000 ft)	0-		11		1-0
	Mach No. (M)	0.6		0.25		0.4
	Duration (mm.)	5		448		7
Ferry	Altitude (1000 ft)	0-38		38		38-0
	Mach No. (M)	0.6		0.6		0.4
	Duration (mm.)	14		565		21
<b>ELECTRONIC COUNTERMEASURES AIRCRAFT</b>						
Ferry	Altitude (1000 ft)	0-35		35		35-0
	Mach No. (M)	0.6		0.7		0.4
	Duration (mm.)	13		242		20

FIGURE 57. General mission profile and characteristics for six aircraft types and twelve missions.

**MIL-HDBK-781**

Mission Type	Characteristics	Phase				
		I	II	III	IV	V
<b>FIGHTER AIRCRAFT</b>						
Low-Low- Low	Altitude (1000 ft)	0-1	1	1	1	1-0
	Mach No. (M)	0.7	0.5	0.7	0.5	0.5
	Duration (mm.)	2	68	5	72	3
Ferry	Altitude (1000 ft)	0-35		35		35-0
	Mach No. (M)	0.7		0.7		0.5
	Duration (mm.)	12		231		17
<b>RECONNAISSANCE AIRCRAFT</b>						
Low- Low- Low	Altitude (1000 ft)	0-1	1	1	1	1-0
	Mach No. (M)	0.7	0.49	0.69	0.49	0.5
	Duration (mm.)	2	63	10	67	3
Ferry	Altitude (1000 ft)	0-38		38		38-0
	Mach No. (M)	0.7		0.74		0.5
	Duration (mm.)	13		244		18
<b>TANKER AIRCRAFT</b>						
Low-Low- Low refueling	Altitude (1000 ft)	0-5	5	5	5	5-0
	Mach No. (M)	0.6	0.44	0.44	0.44	0.4
	Duration (mm.)	4	40	60	37	6
Strike refuel	Altitude (1000 ft)	0-15	15	15	15	15-0
	Mach No. (M)	0.6	0.58	0.47	0.58	0.4
	Duration (mm.)	0.7	24	58	19	11

FIGURE 57. General mission profile and characteristics for six aircraft types and twelve missions. (Continued)

**MIL-HDBK-781**

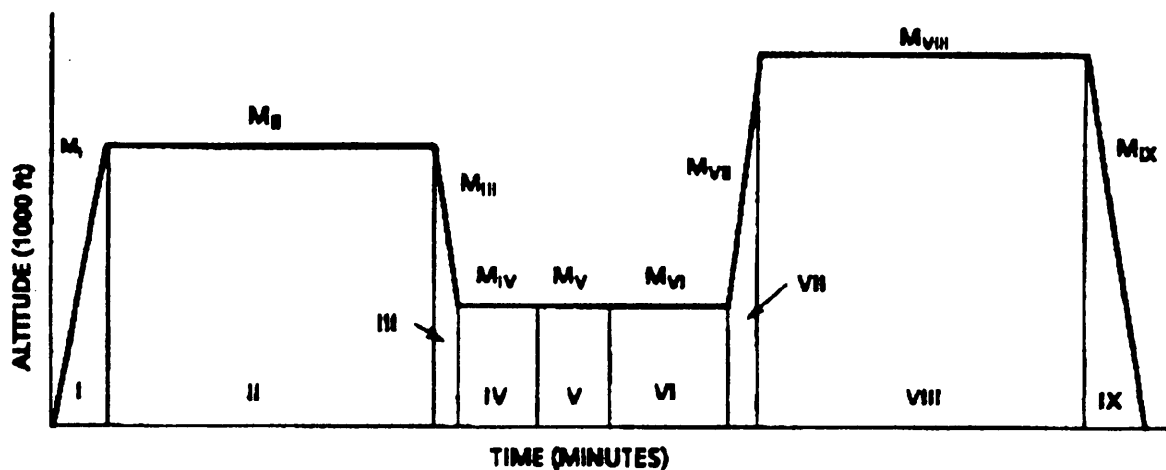

Mission Type	Characteristics	Phase								
		I	II	III	IV	V	VI	VII	VIII	IX
<b>ATTACK AIRCRAFT</b>										
Close Support	Altitude (1000ft)	0-32	32	32-5	5	5	N/A	5-40	40	40-0
	Mach No. (M)	0.607	0.68	0.40	0.73	0.837	N/A	0.70	0.68	0.40
	Duration (min.)	5	62	7	61	7	N/A	4	63	17
High-Low-High	Altitude(1000ft)	0-32	32	32-1	1	N/A	N/A	1-40	40	40-0
	Mach No. (M)	0.60	0.68	0.85	0.84	N/A	N/A	0.70	0.68	0.40
	Duration (min.)	5	55	4	5	N/A	N/A	5	51	18
<b>ANTI-SUBMARINE AIRCRAFT</b>										
Investigation and Attack	Altitude(1000ft)	0-38	38	38-0.5	0.5	N/A	N/A	0.5-40	40	40-0
	Mach No. (M)	0.6	0.6	0.4	0.25	N/A	N/A	0.7	0.6	0.4
	Duration (min.)	6	155	9	120	N/A	N/A	5	140	10
Contact Investigation and Intermediate	Altitude (1000 ft)	0-20	20	20-1	1	N/A	N/A	1-40	40	40-0
	Mach No. (M)	0.6	0.7	0.4	0.4	N/A	N/A	0.7	0.6	0.4
	Duration (min.)	4	86	6	211	N/A	N/A	5	108	10
Mine Laying	Altitude(1000ft)	0-36	36	36-1	1	N/A	N/A	1-40	40	40-0
	Mach No. (M)	0.6	0.6	0.4	0.6	N/A	N/A	0.7	0.7	0.4
	Duration (min.)	6	140	9	20	N/A	N/A	5	127	8

FIGURE 58. General mission profile and characteristics for six aircraft types and twelve missions.

**MIL-HDBK-781**

Mission Type	Characteristics	Phase								
		I	II	III	IV	V	VI	VII	VIII	IX
<b>ELECTRONIC COUNTERMEASURES AIRCRAFT</b>										
Penetration	Altitude(1000ft)	0-34	34	34-1	1	1	1	1-36	36	36-0
	Mach No. (M)	0.6	0.57	0.85	0.50	0.80	0.50	0.70	0.58	0.40
	Duration (mm.)	10	32	5	29	5	29	8	29	12
Standoff	Altitude(1000ft)	0-33	33	33-30	30	N/A	N/A	30-35	35	35-0
	Mach No. (M)	0.60	0.70	0.60	0.67	N/A	N/A	0.70	0.70	0.40
	Duration(min.)	10	42	1	49	N/A	N/A	1	41	16
<b>FIGHTER AIRCRAFT</b>										
Escort	Altitude (1000ft)	0-35	35	35-10	10	N/A	N/A	10-40	40	40-0
	Mach No. (M)	0.7	0.7	0.9	1.0	N/A	N/A	0.8	0.7	0.5
	Duration(min.)	8	87	3	7	N/A	N/A	7	75	17
High-Low Low-High	Altitude (1000ft)	0-30	30	30-1	1	1	1	1-42	42	42-0
	Mach No. (M)	0.7	0.7	0.85	0.8	0.85	0.85	0.85	0.7	0.5
	Duration(min.)	7	57	5	11	7	9	6	66	19
Close Support	Altitude (1000ft)	0-30	30	3-5	5	N/A	N/A	5-40	40	40-0
	Mach No. (M)	0.7	0.7	0.85	0.42	N/A	N/A	0.85	0.7	0.5
	Duration(min.)	7	69	3	59	N/A	N/A	4	74	17
<b>RECONNAISSANCE AIRCRAFT</b>										
High-Low High	Altitude(1000ft)	0-33	33	33-1	1	N/A	N/A	1-40	40	40-0
	Mach No. (M)	0.7	0.75	0.89	0.7	N/A	N/A	0.9	0.75	0.5
	Duration(min.)	8	75	3	17	N/A	N/A	9	86	17
<b>TANKER AIRCRAFT</b>										
High-Low- High refuel	Altitude (1000ft)	0-35	35	35-5	5	N/A	N/A	5-40	40	40-0
	Mach No. (M)	0.6	0.7	0.4	0.65	N/A	N/A	0.7	0.72	0.4
	Duration (min.)	12	40	9	61	N/A	N/A	7	39	18

FIGURE 58. General mission profile and characteristics for six aircraft types and twelve missions. (Continued)

**MIL-HDBK-781**

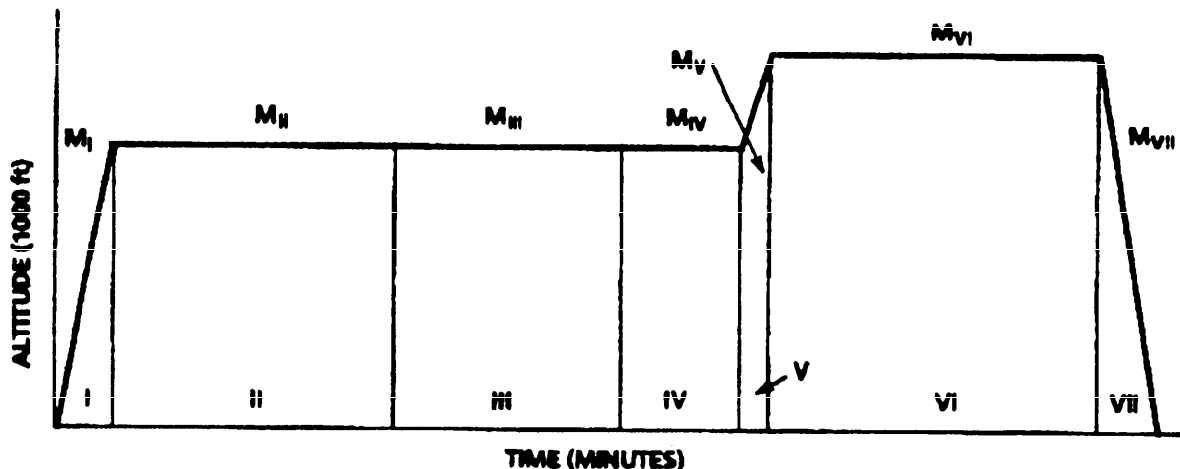

Mission Type	Characteristics	Phase						
		I	II	III	IV	V	VI	VII
<b>ATTACK AIRCRAFT</b>								
High-High-High	Altitude (1000 ft)	0-28	28	N/A	N/A	28-43	43	43-0
	Mach No. (M)	0.6	0.75	N/A	N/A	0.7	0.8	0.4
	Duration (mm.)	8	60	N/A	N/A	4	56	28
<b>ANTI-SUBMARINE WARFARE AIRCRAFT</b>								
High-High-High	Altitude (1000 ft)	0-38	38	N/A	N/A	38-40	40	40-0
	Mach No. (M)	0.6	0.6	N/A	N/A	0.7	0.6	0.4
	Duration (mm.)	15	105	N/A	N/A	6	104	15
<b>FIGHTER AIRCRAFT</b>								
High-High-High	Altitude (1000 ft)	0-35	35	35	N/A	35-40	40	40-0
	Mach No. (M)	0.7	0.7	0.9	N/A	0.8	0.7	0.5
	Duration (mm.)	7	46	5	N/A	1	43	13
Air Defense/ Capture	Altitude (1000 ft)	0-35	35	35	35	35-40	40	40-0
	Mach No. (M)	0.7	0.7	0.67	1.35	0.8	0.7	0.5
	Duration (mm.)	7	16	60	4	1	19	12
Low-Low-High	Altitude (1000 ft)	0-2	2	2	N/A	2-35	35	35-0
	Mach No.(M)	0.7	0.5	0.9	N/A		0.7	0.5
	Duration (mm.)	1	69	5	N/A	5	57	15

FIGURE 59. General mission profile and characteristics for four aircraft types and seven missions.

**MIL-HDBK-781**

Mission Type	Characteristics	Phase						
		I	II	III	IV	V	VI	VII
<b>RECONNAISSANCE AIRCRAFT</b>								
Low-Low-High	Altitude (1000 ft)	0-2	2	2	N/A	2-40	40	40-0
	Mach No. (M)	0.7	0.75	0.9	N/A	0.9	0.75	0.5
	Duration (mm.)	1	52	10	N/A	7	60	13
High-subsonic	Altitude (1000 ft)	0-35	35	35	N/A	35-40	40	40-0
	Mach No. (M)	0.7	0.85	0.9	N/A		0.85	0.5
	Duration (mm.)	7	58	16	N/A	2	64	13

FIGURE 59. General mission profile and characteristics for four aircraft types and seven missions. (Continued)

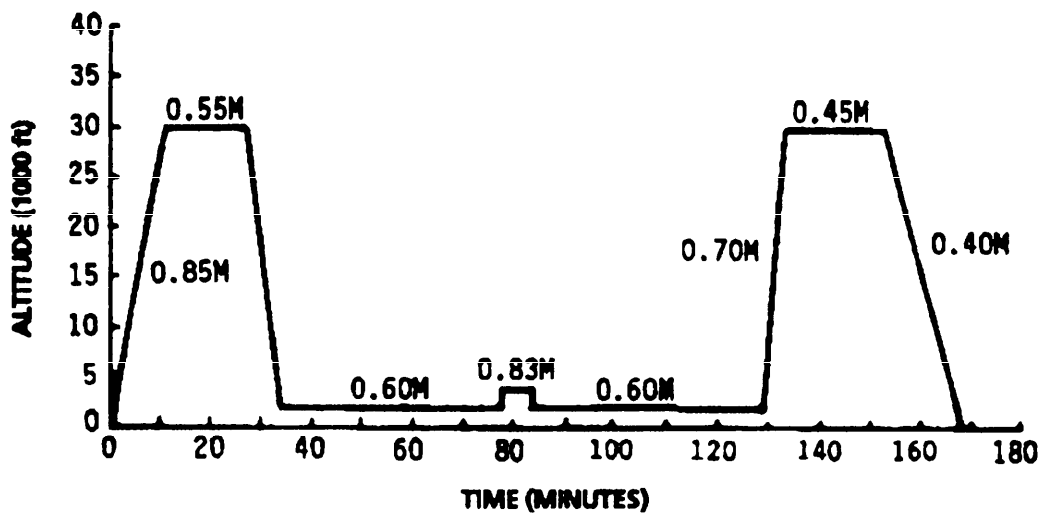

FIGURE 60. General mission profile and characteristics for an attack aircraft on a high-low-low-high mission

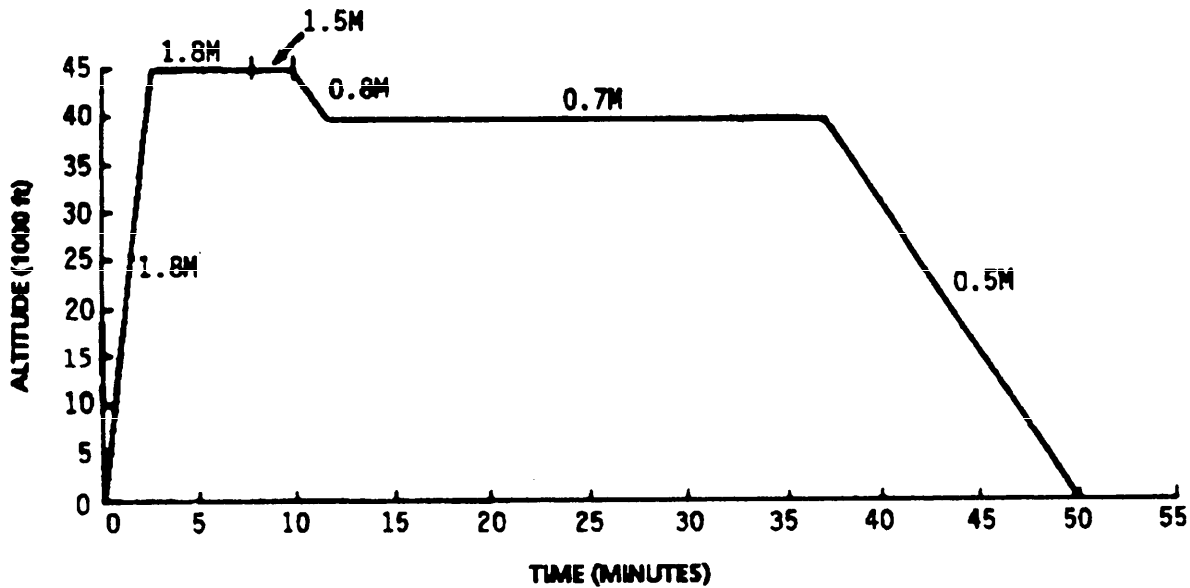

FIGURE 61. General mission profile and characteristics for a fighter aircraft on an intercept mission

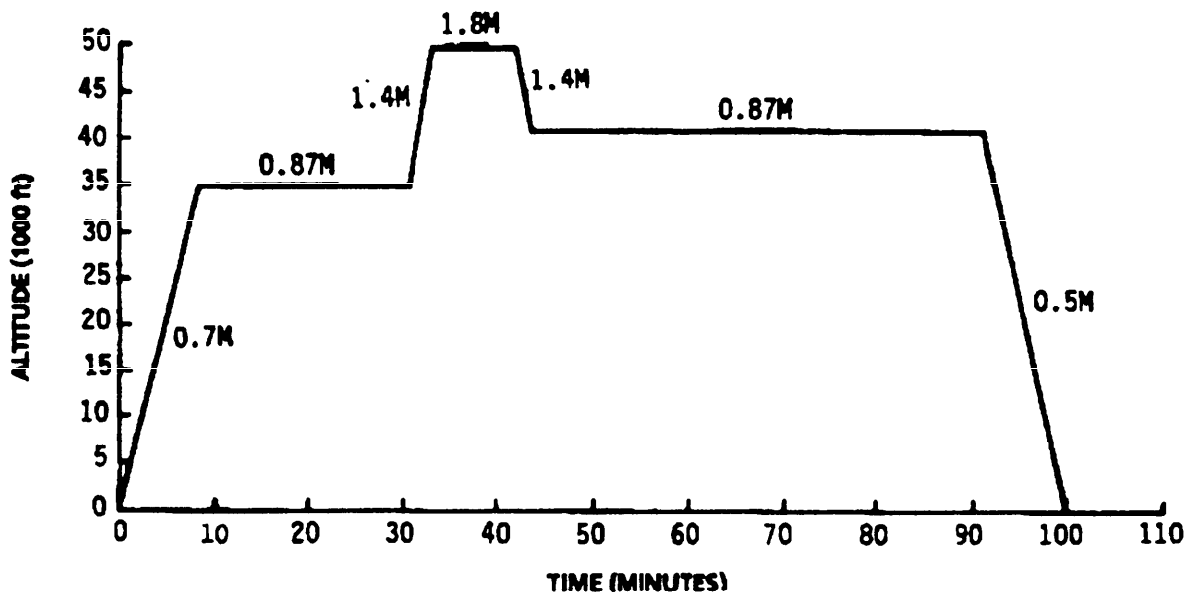

FIGURE 62. General mission profile and characteristics for a reconnaissance aircraft on a high-supersonic mission

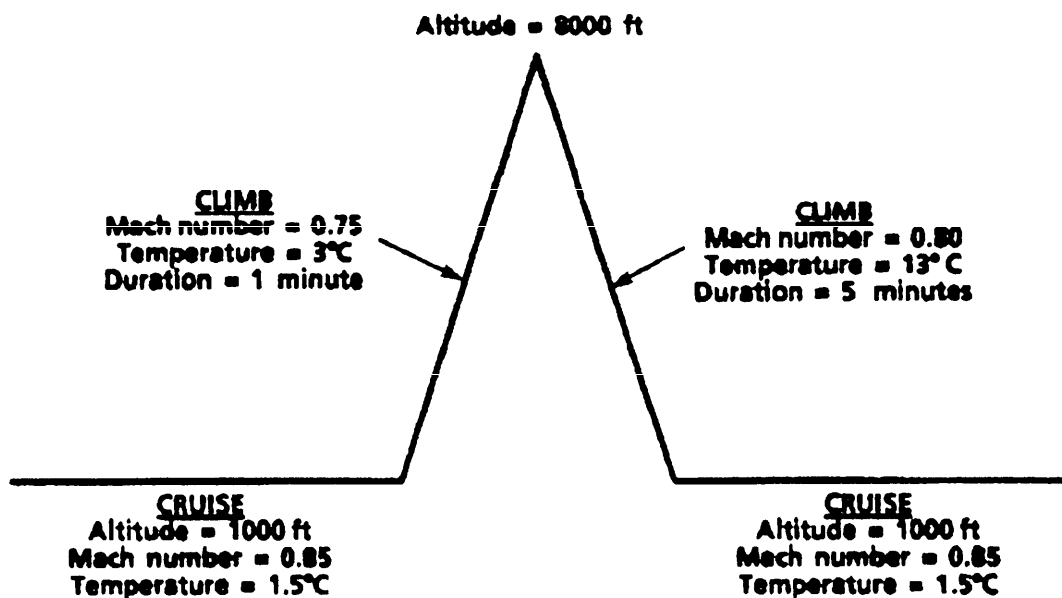

FIGURE 63. Mission profile for temperature rate of change calculation

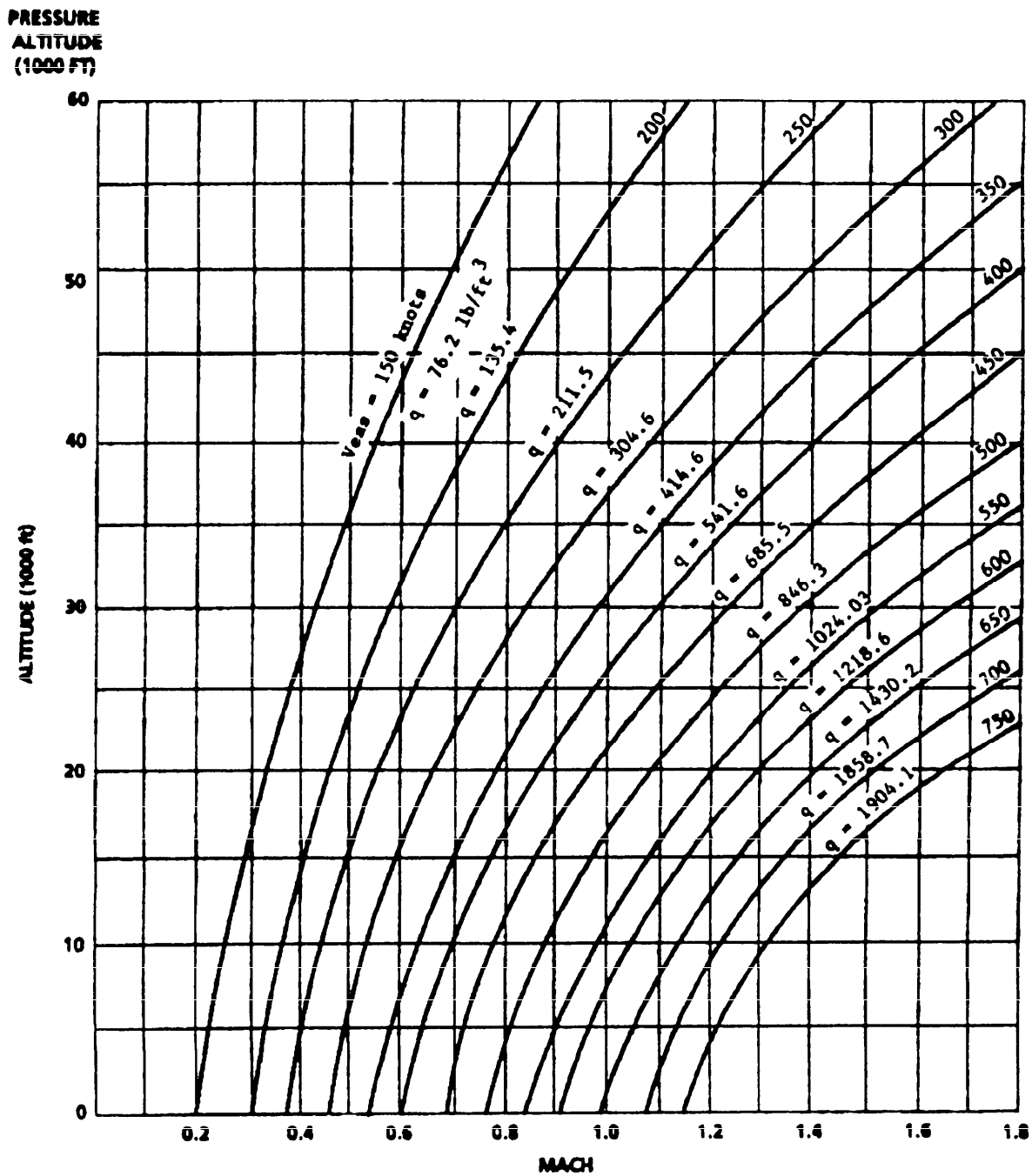

FIGURE 64. Dynamic pressure ( $q$ ) as function of Mach number and altitude

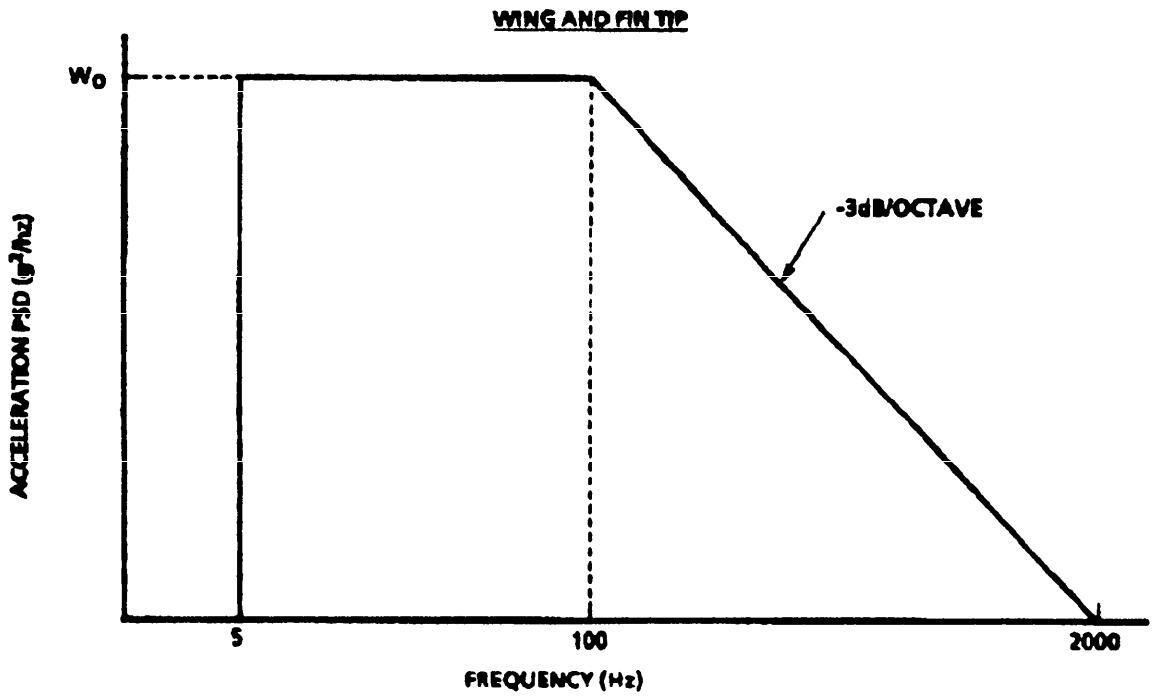
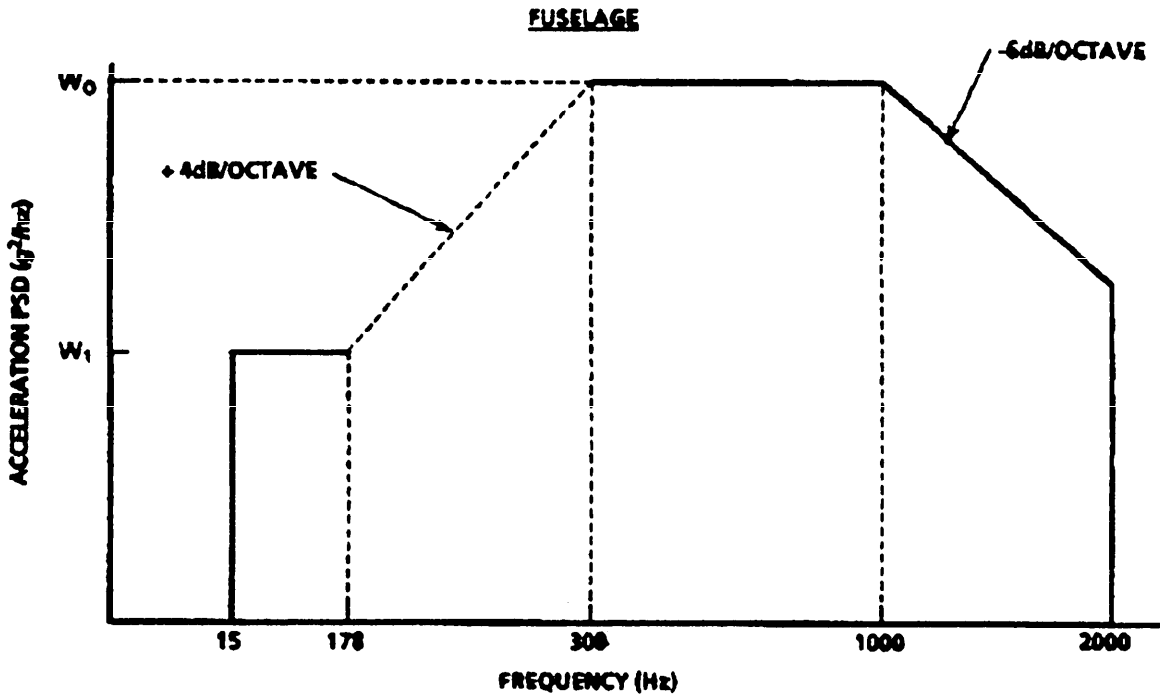

FIGURE 65. Random vibration test envelope for jet aircraft

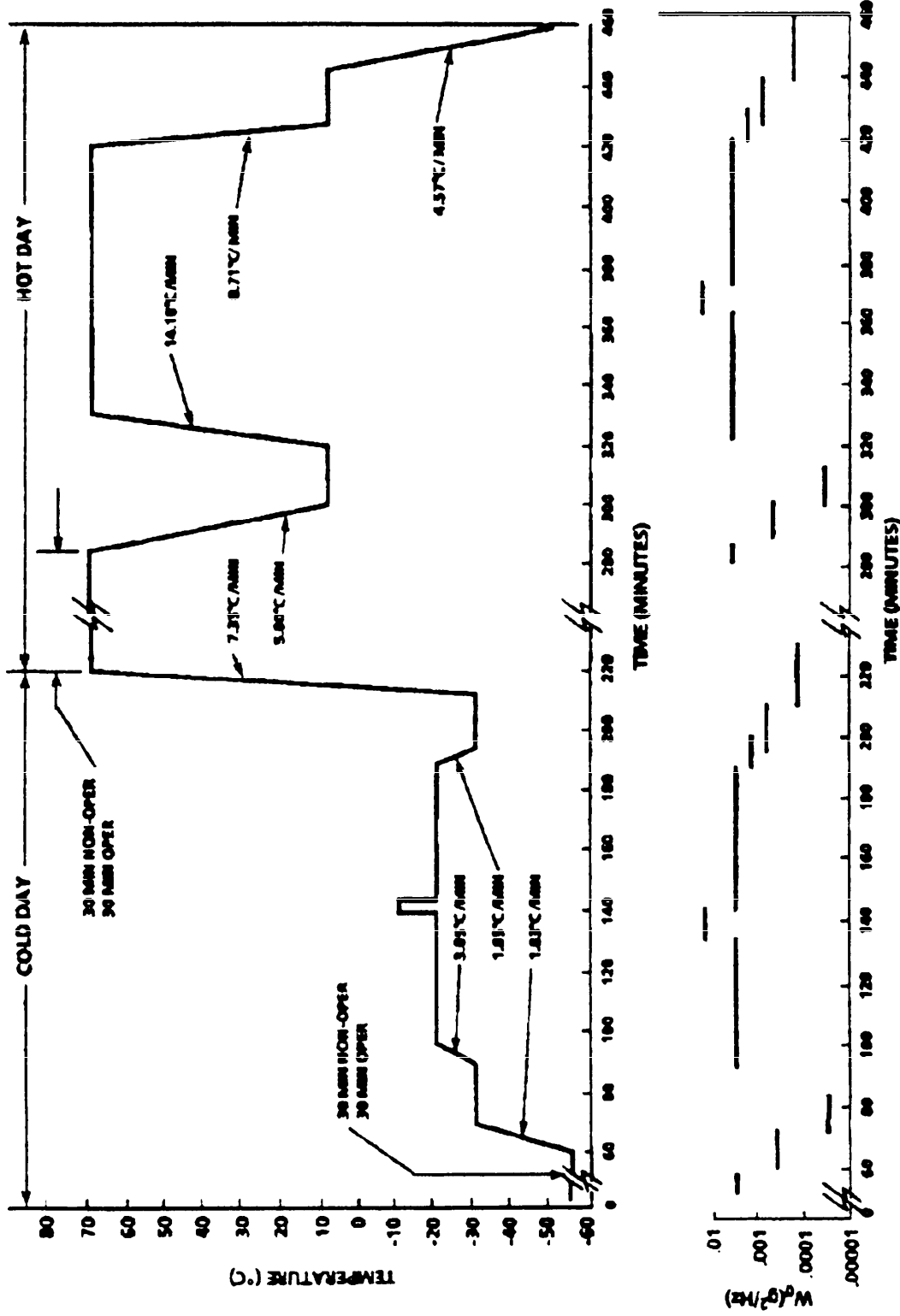

FIGURE 66. Environmental profile (example)

ML DBK-781

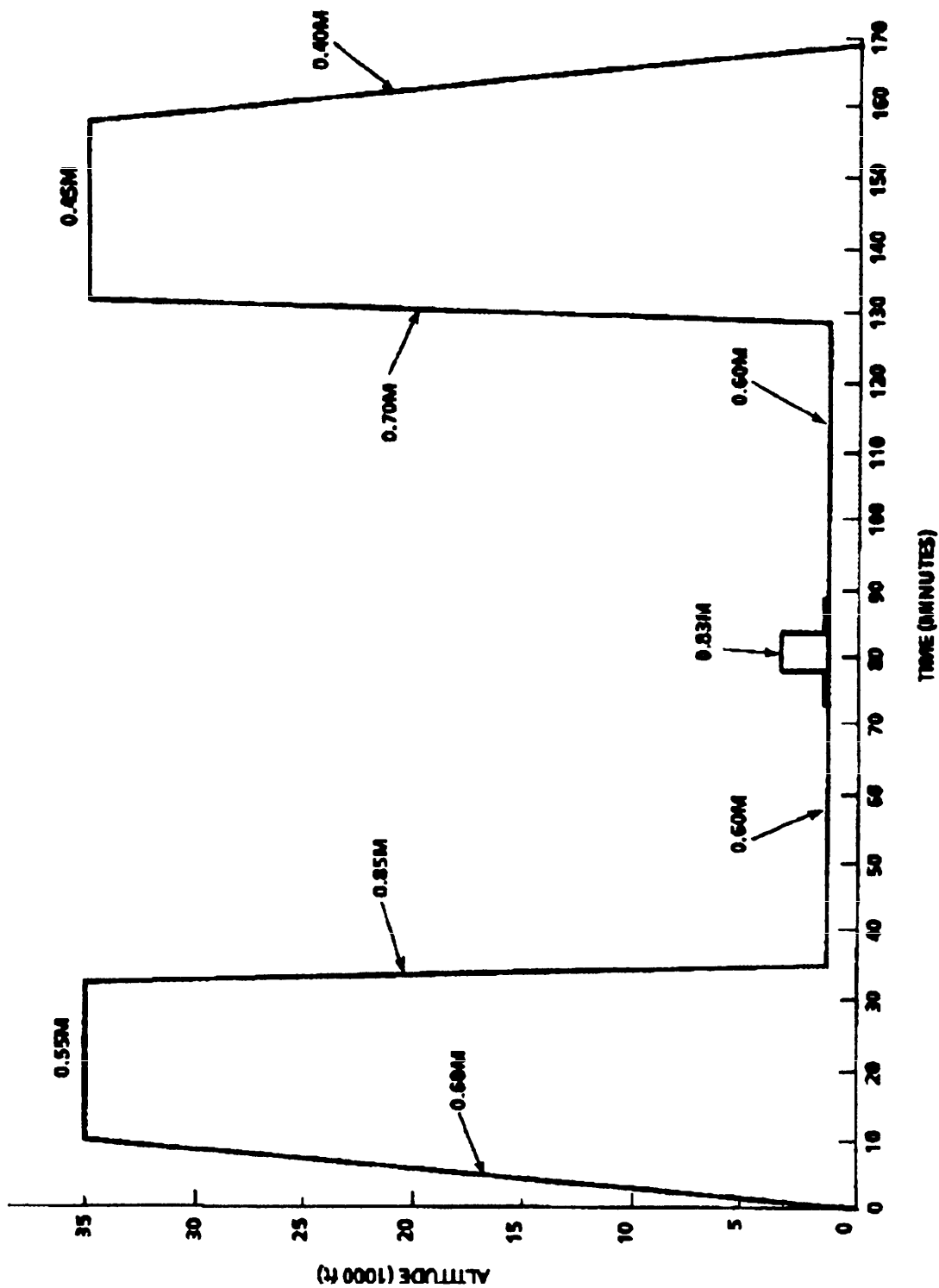

FIGURE 67. Mission profile (example)

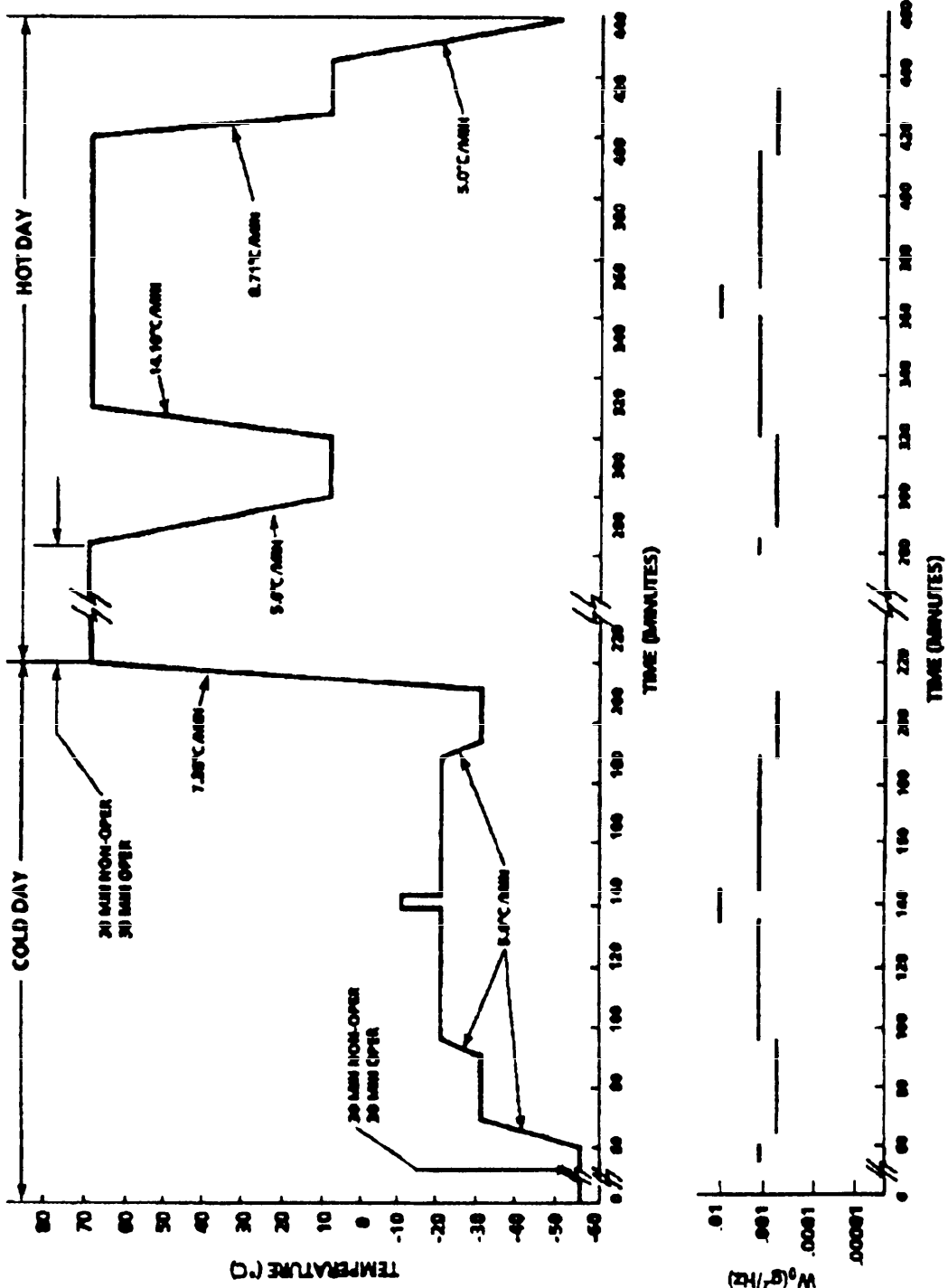

FIGURE 68. Test profile (example)

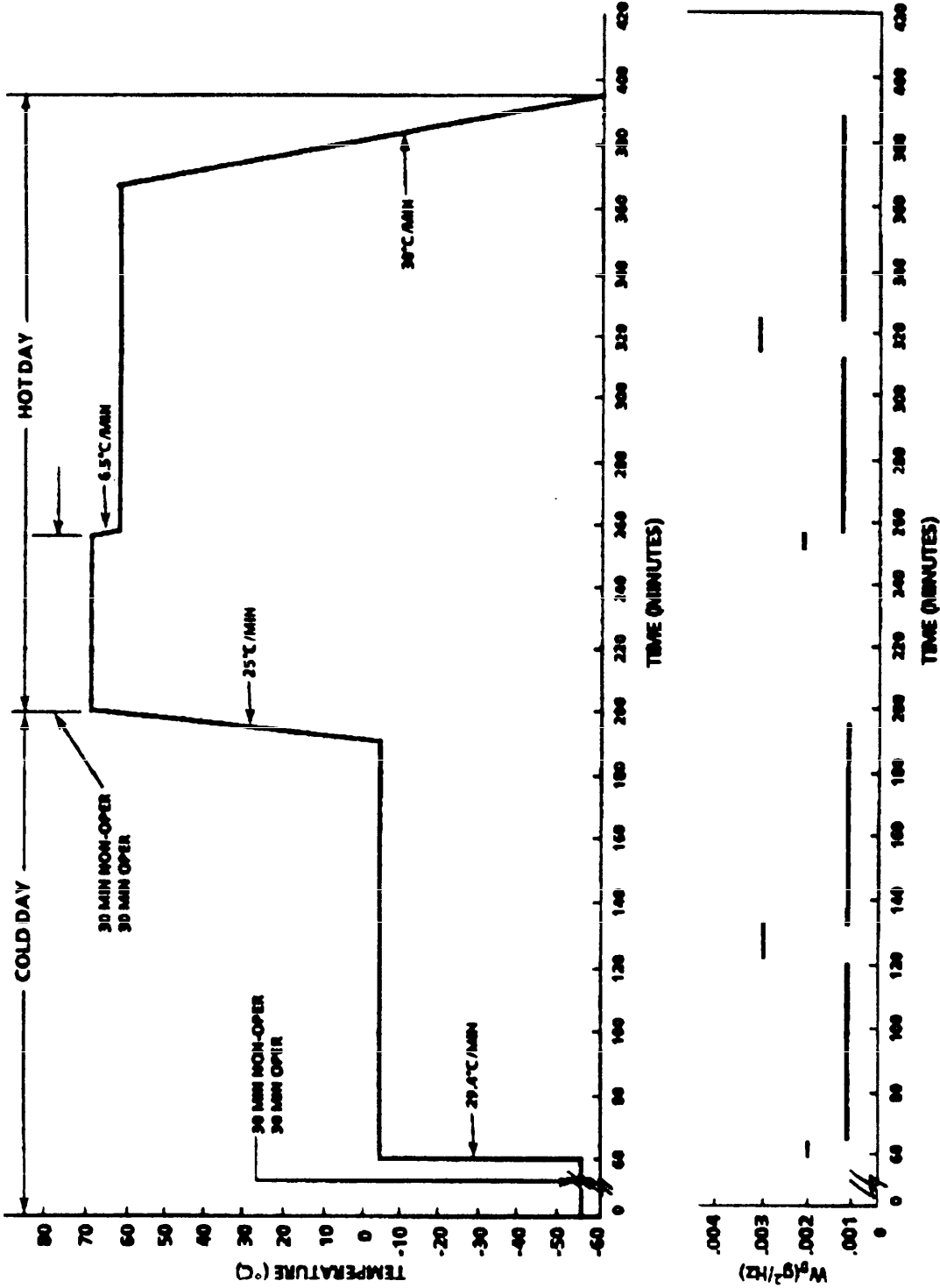

FIGURE 69. Attack aircraft test profile (low-low-low)

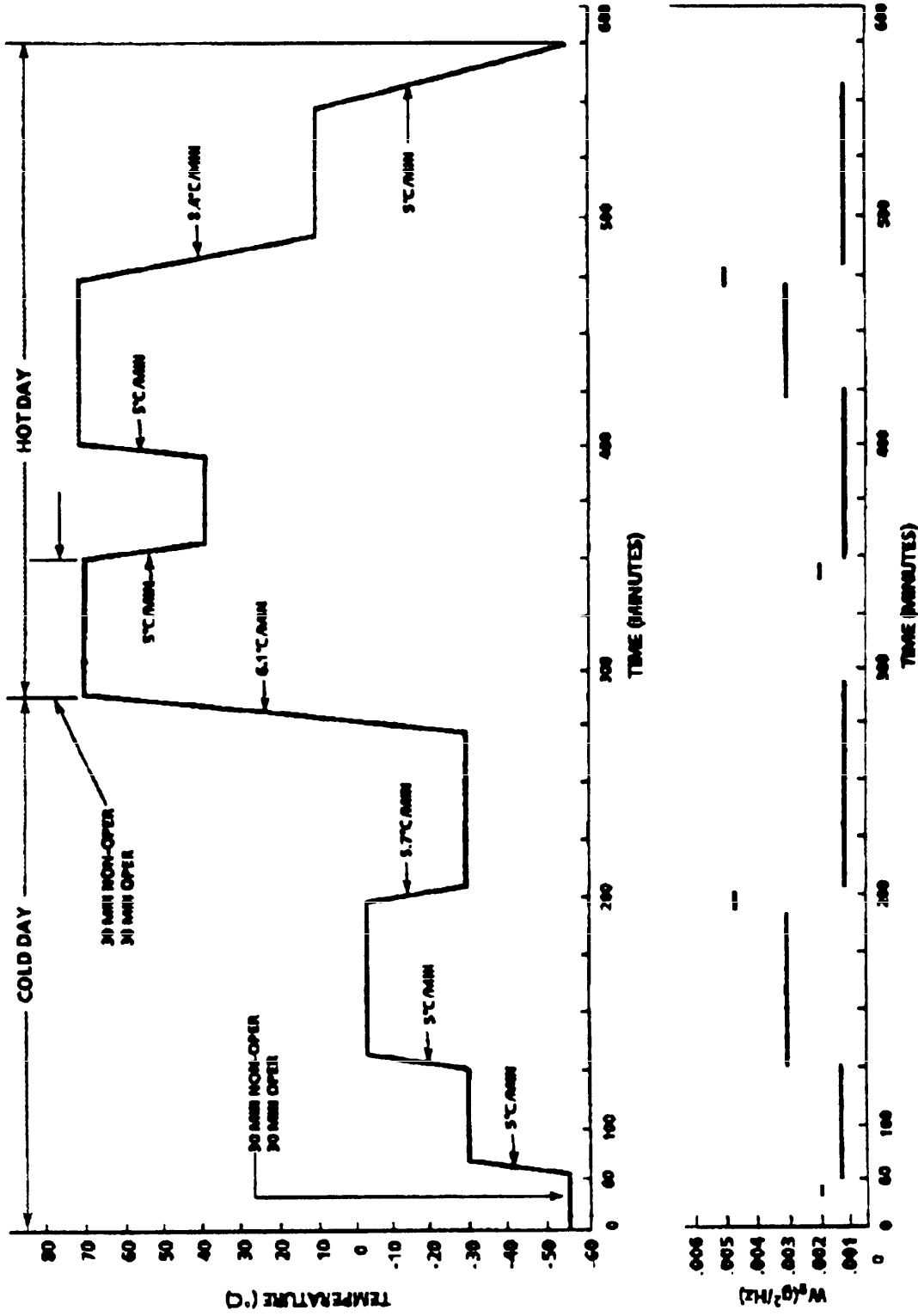

FIGURE 70. Attack aircraft test profile (close support)

MIL DBK-781

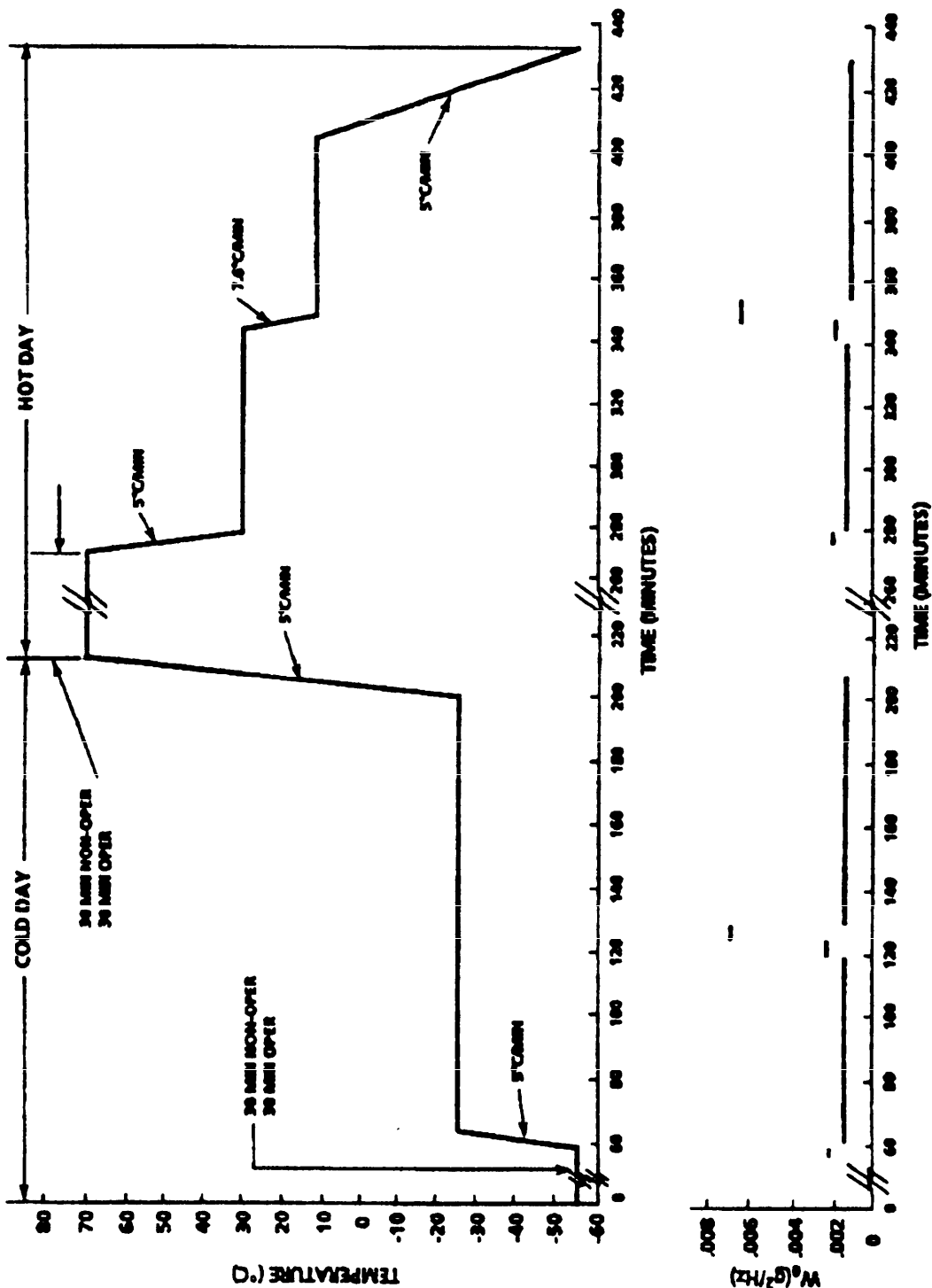

FIGURE 71. Attack aircraft test profile (high-low-high)

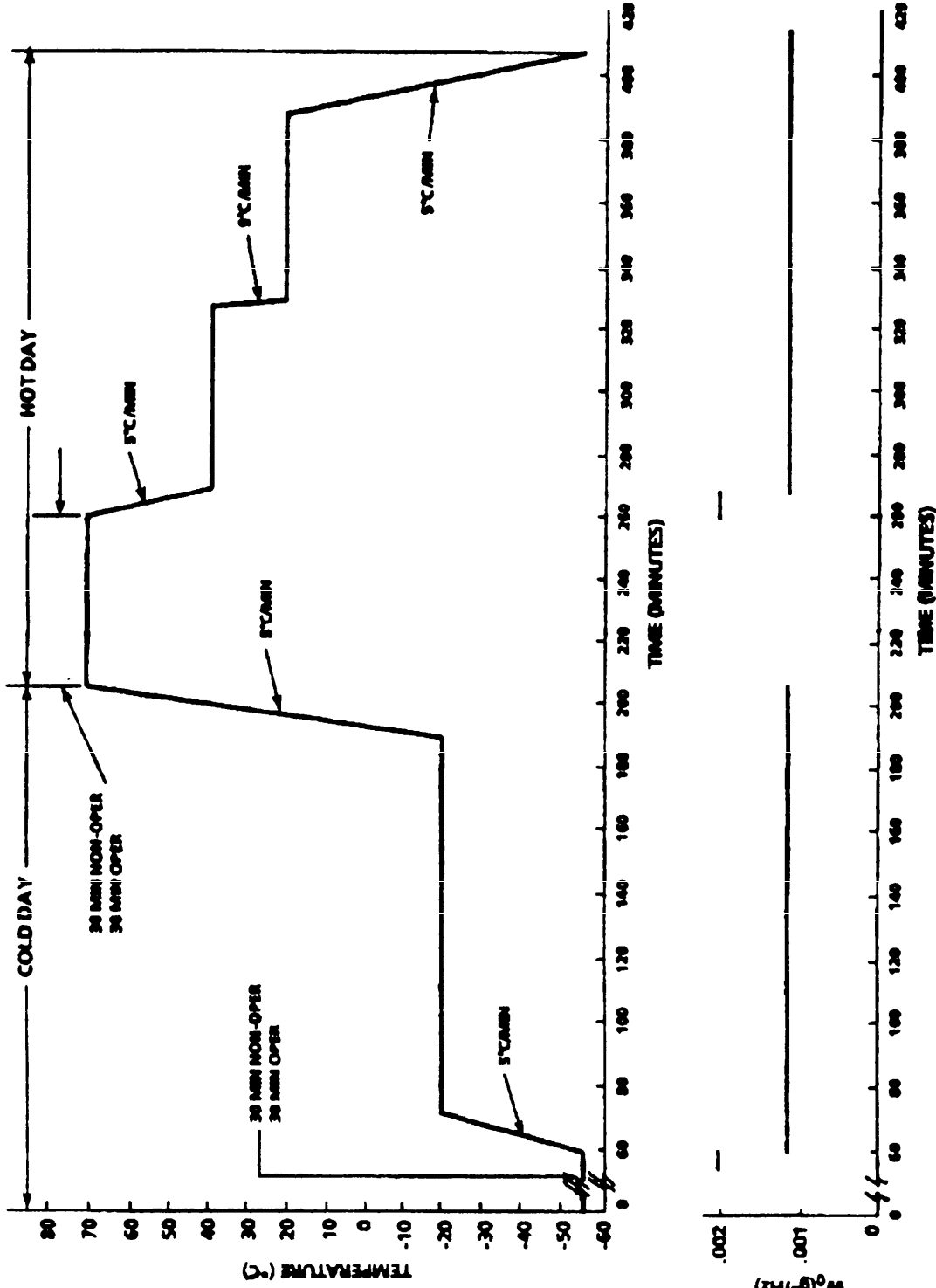

FIGURE 72. Attack aircraft test profile (high-high-high)

MII BK-781

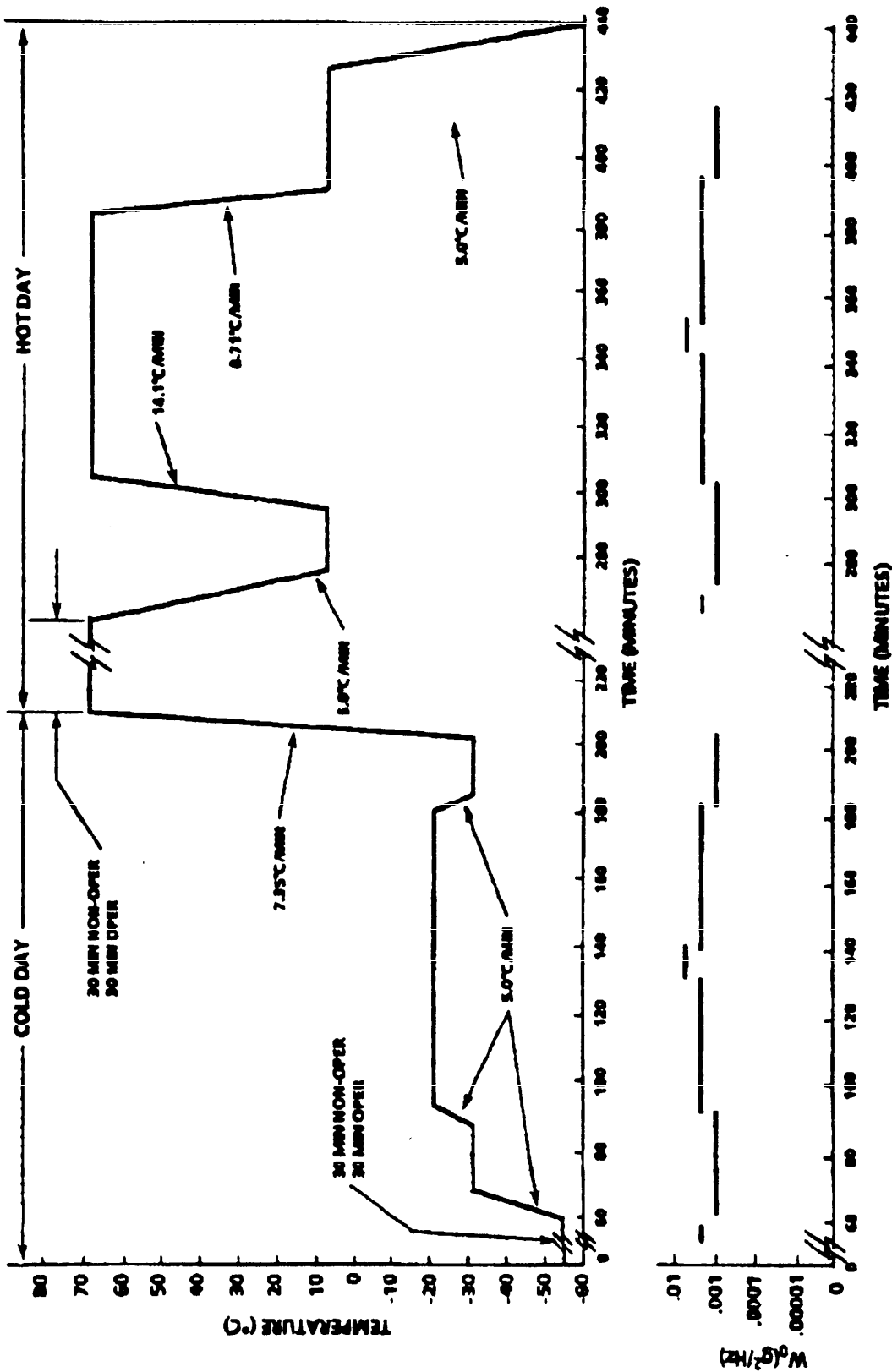

FIGURE 73. Attack aircraft test profile (high-low-low-high)

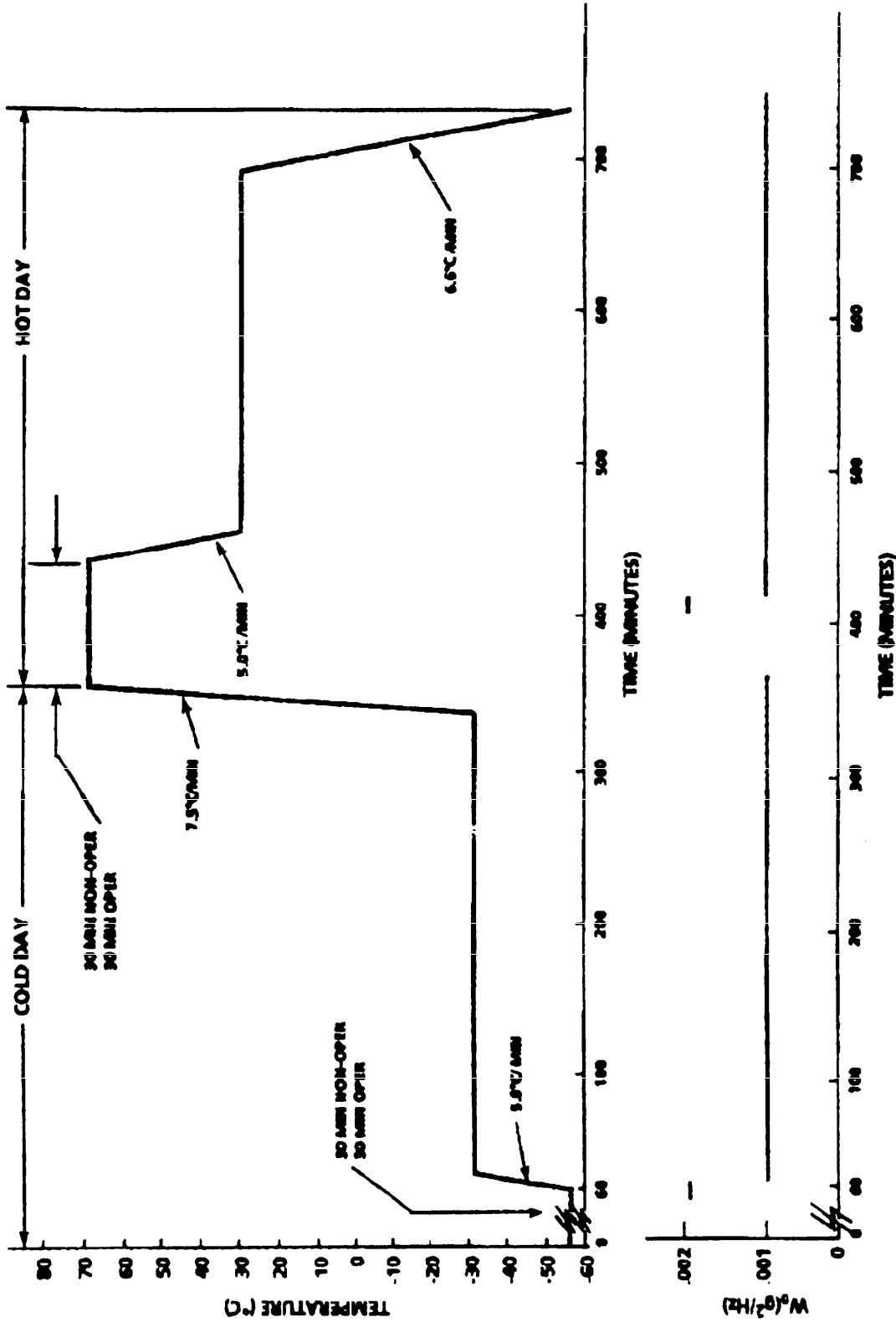

FIGURE 74. Attack aircraft test profile (ferry)

MI/ DBK-781

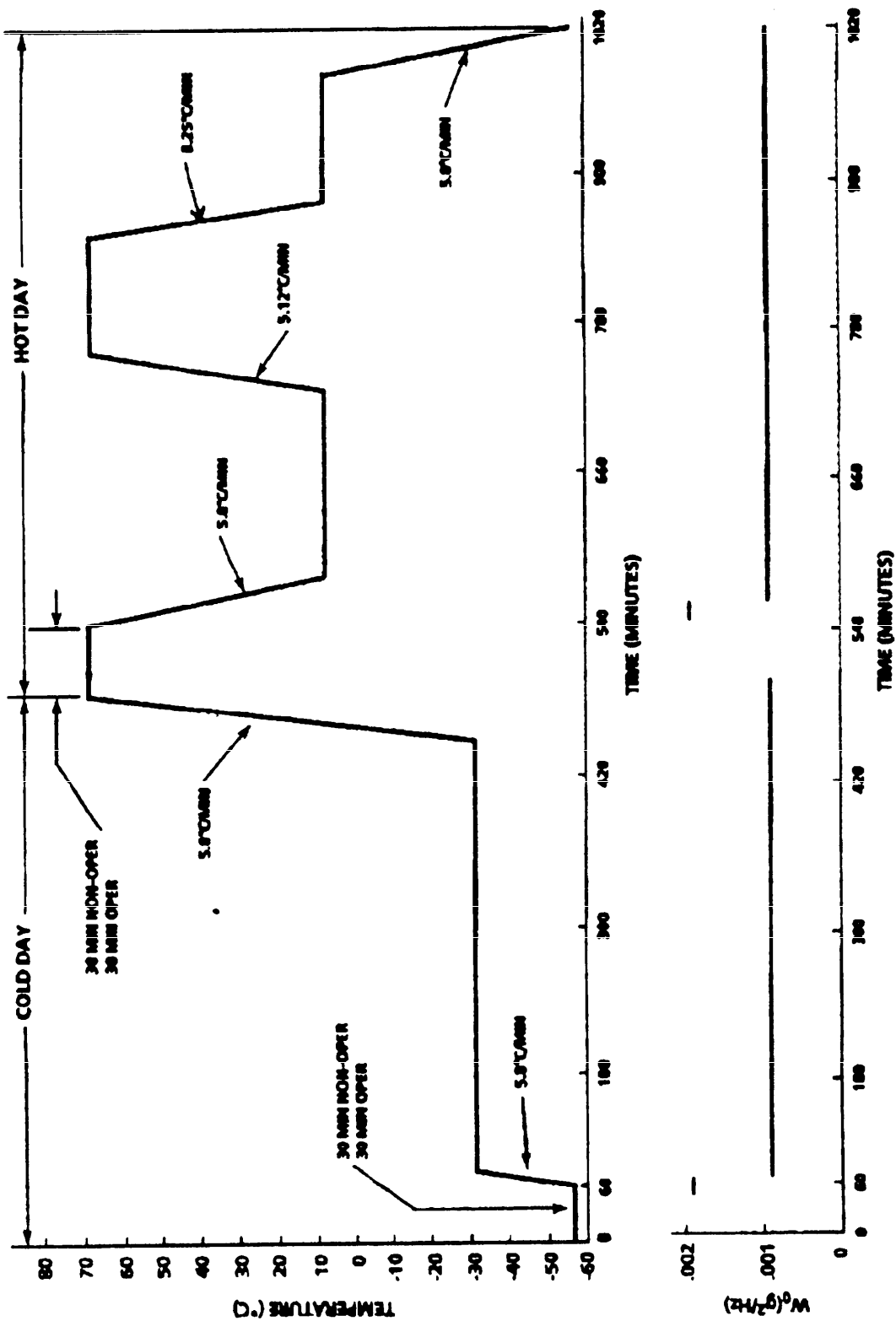

FIGURE 75. ASW aircraft test profile (contact investigation-high)

MIL-HDBK-781

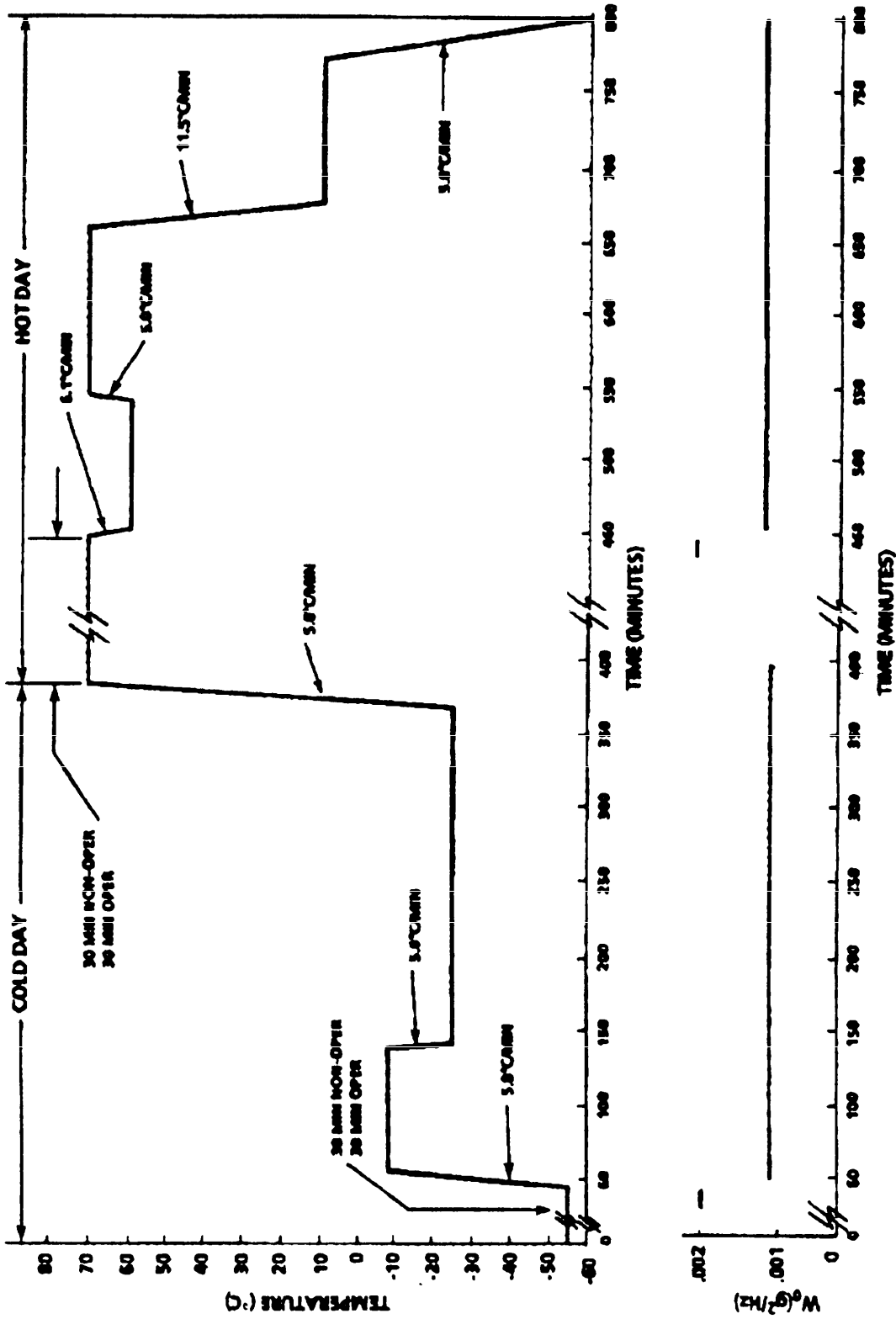

FIGURE 76. ASW aircraft test profile (contact investigation-intermediate)

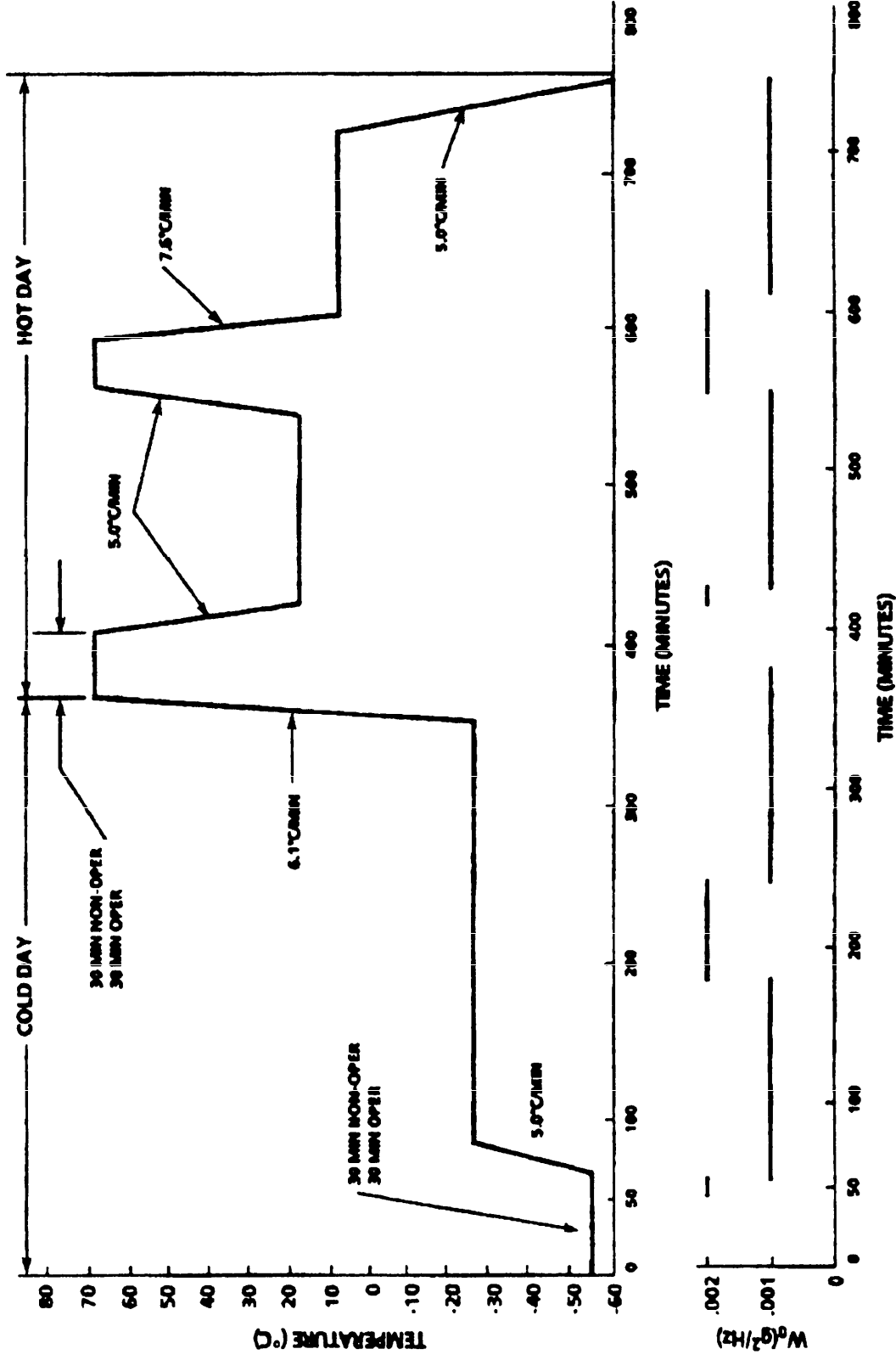

FIGURE 77. ASW aircraft test profile (mine laying)

MIL-HDBK-781

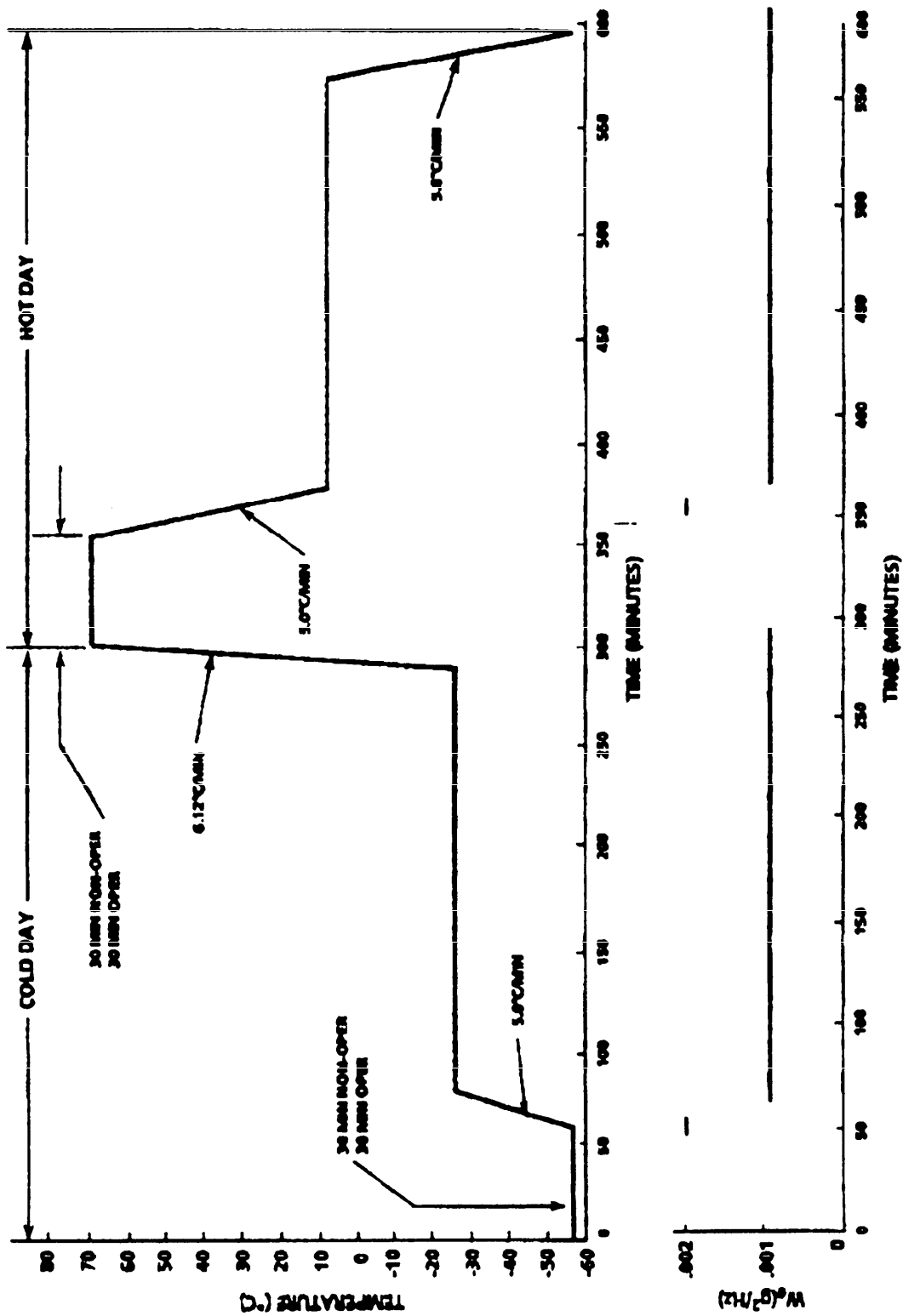

FIGURE 78. ASW aircraft test profile (high-high-high)

MIL-HDBK-781

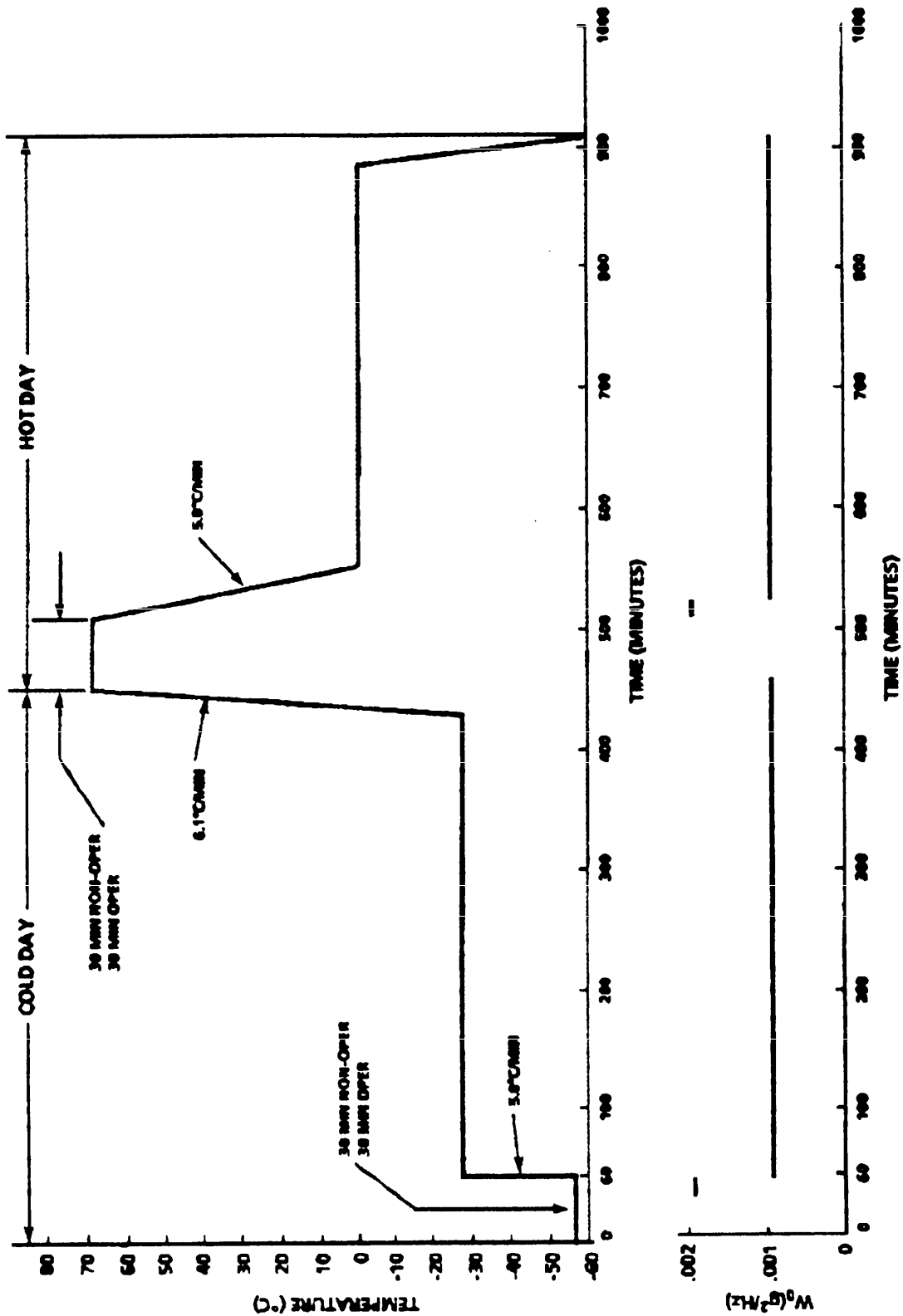

FIGURE 79. ASW aircraft test profile (search and attack)

MIL-HDBK-781

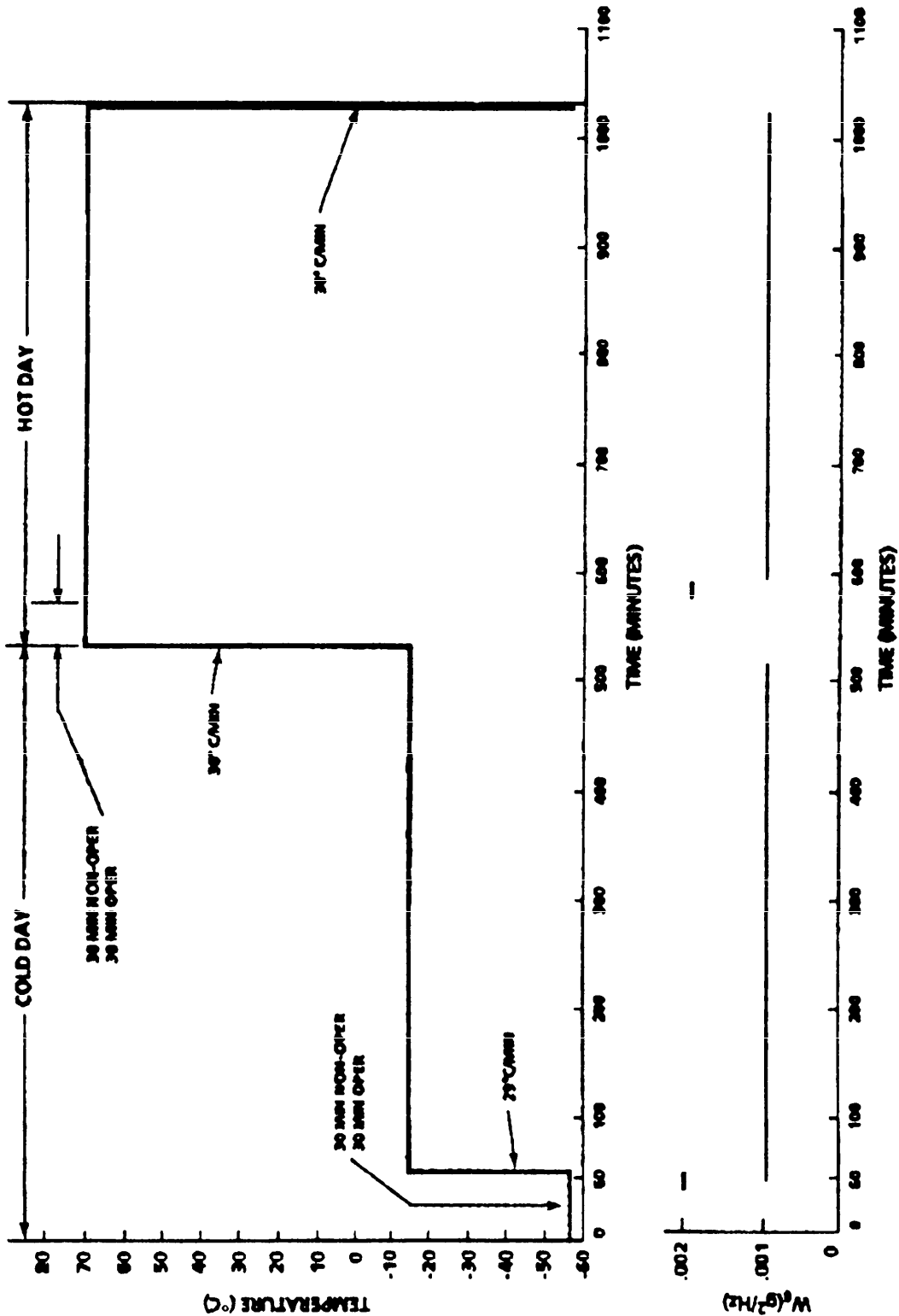

FIGURE 80. ASW aircraft test profile (surface surveillance)

MIL-HDBK-781

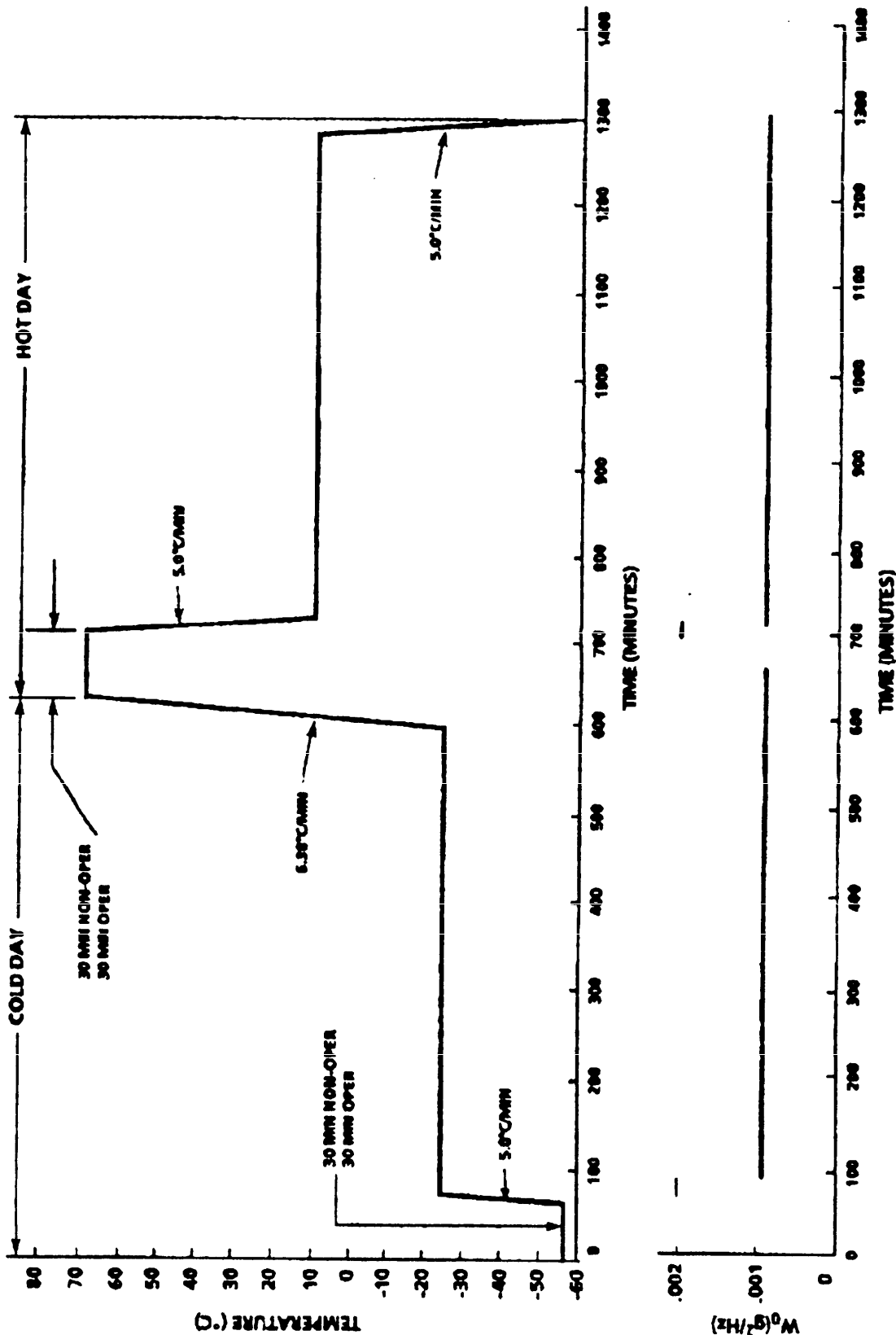

FIGURE 81. ASW aircraft test profile (ferry)

MIL-HDBK-781

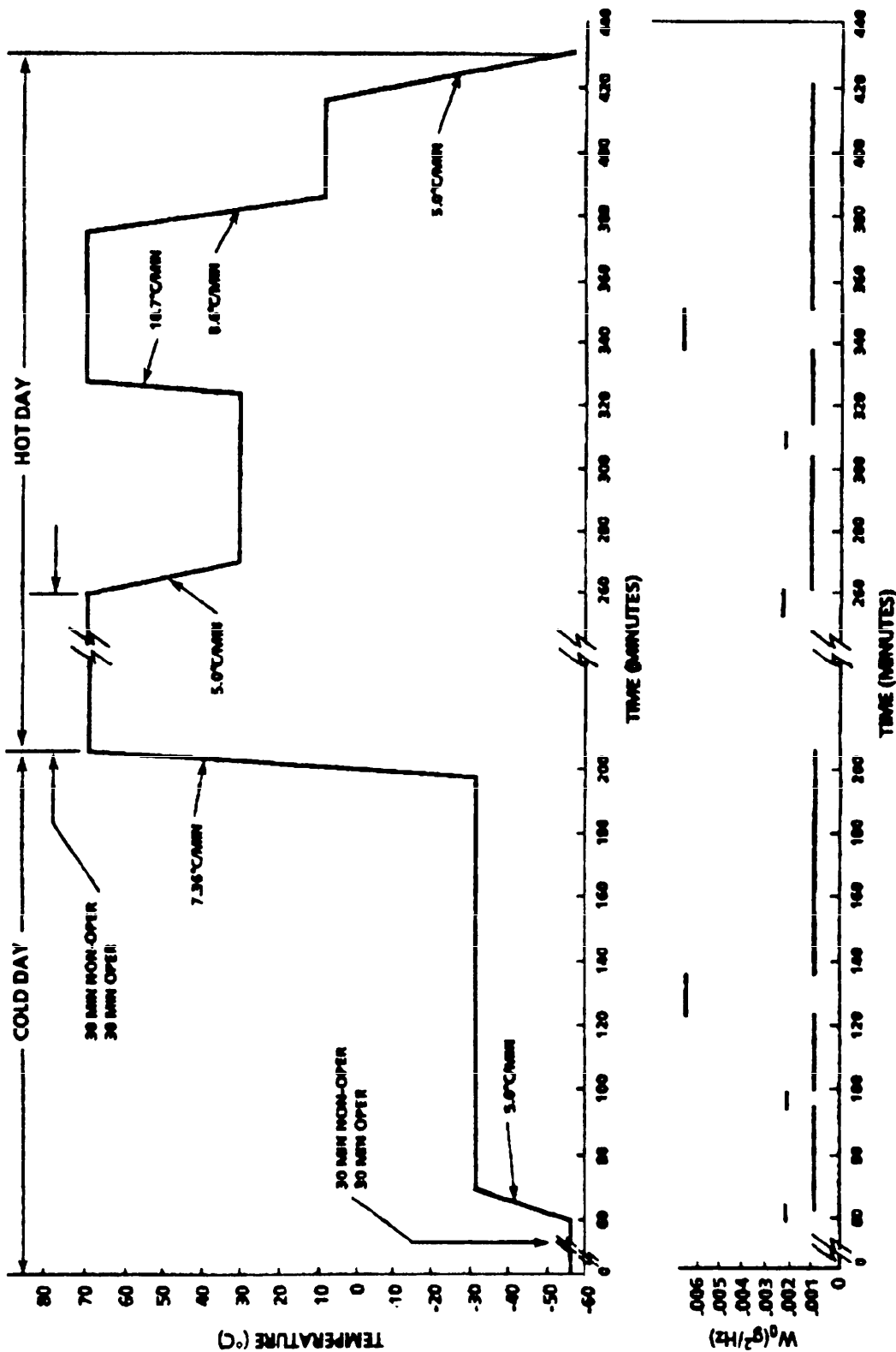

FIGURE 82. ECM aircraft test profile (penetration)

MIL-HDBK-781

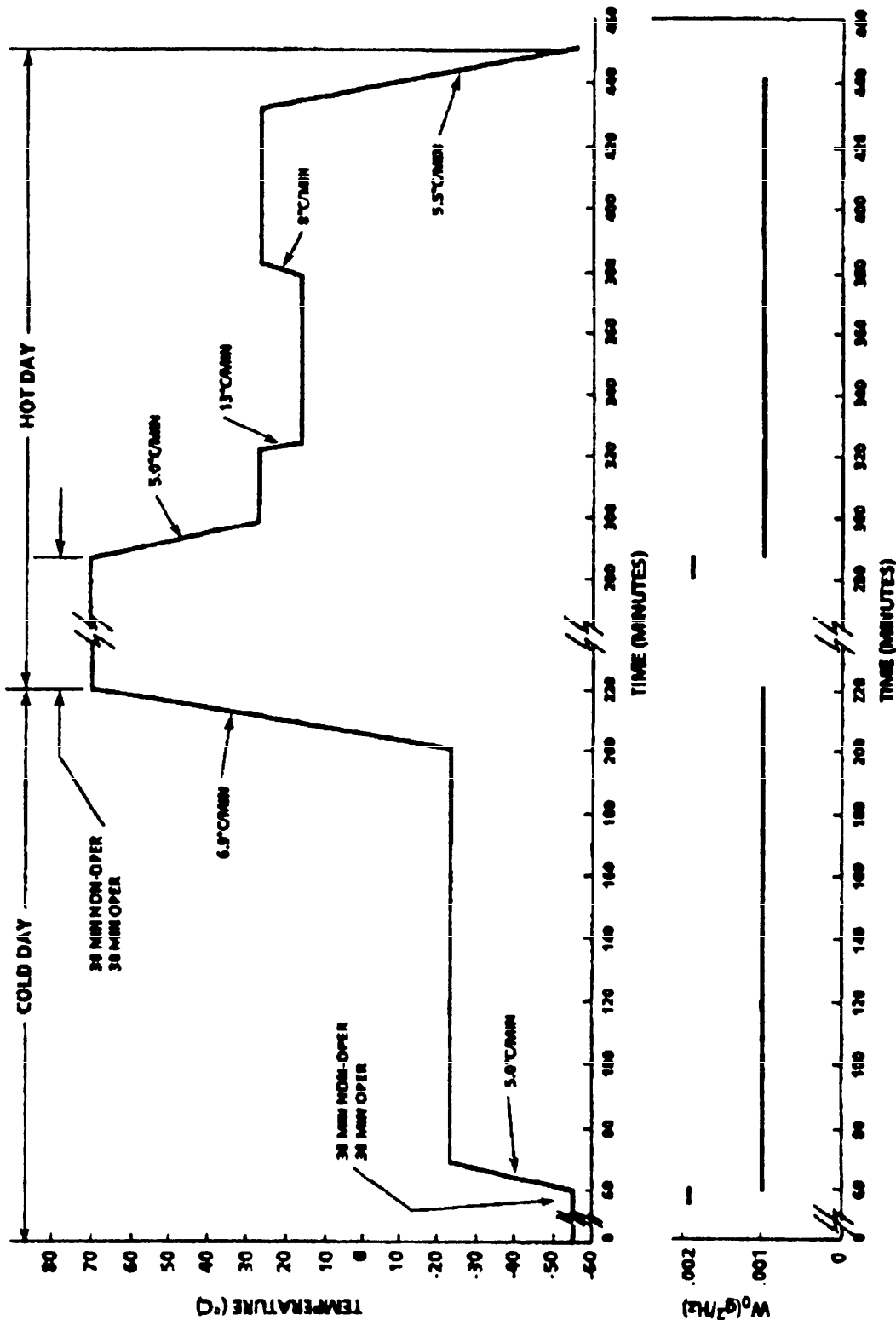

FIGURE 83. ECM aircraft test profile (stand-off)

MIL-HDBK-781

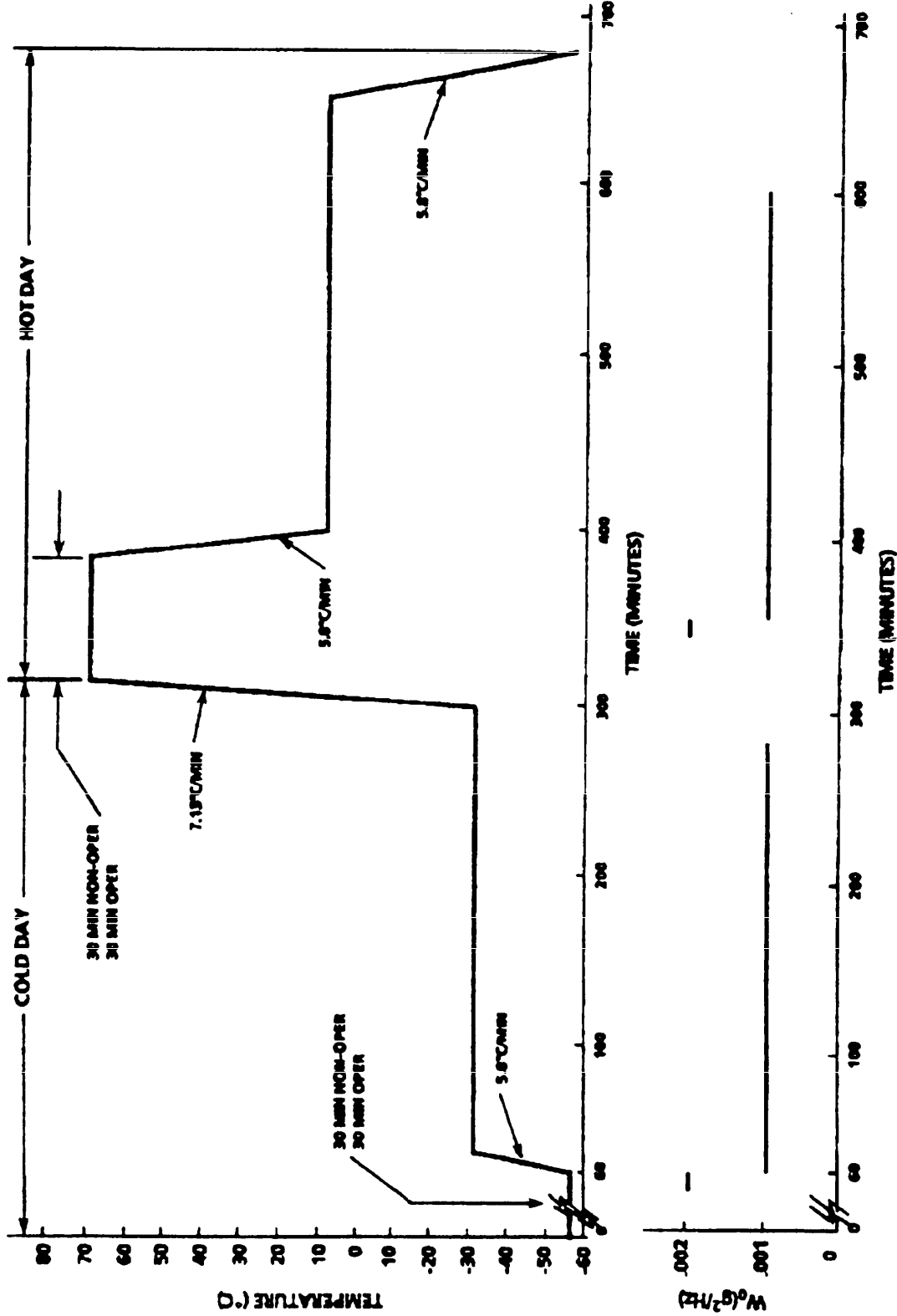

FIGURE 84. ECM aircraft test profile (ferry)

MIL-HDBK-781

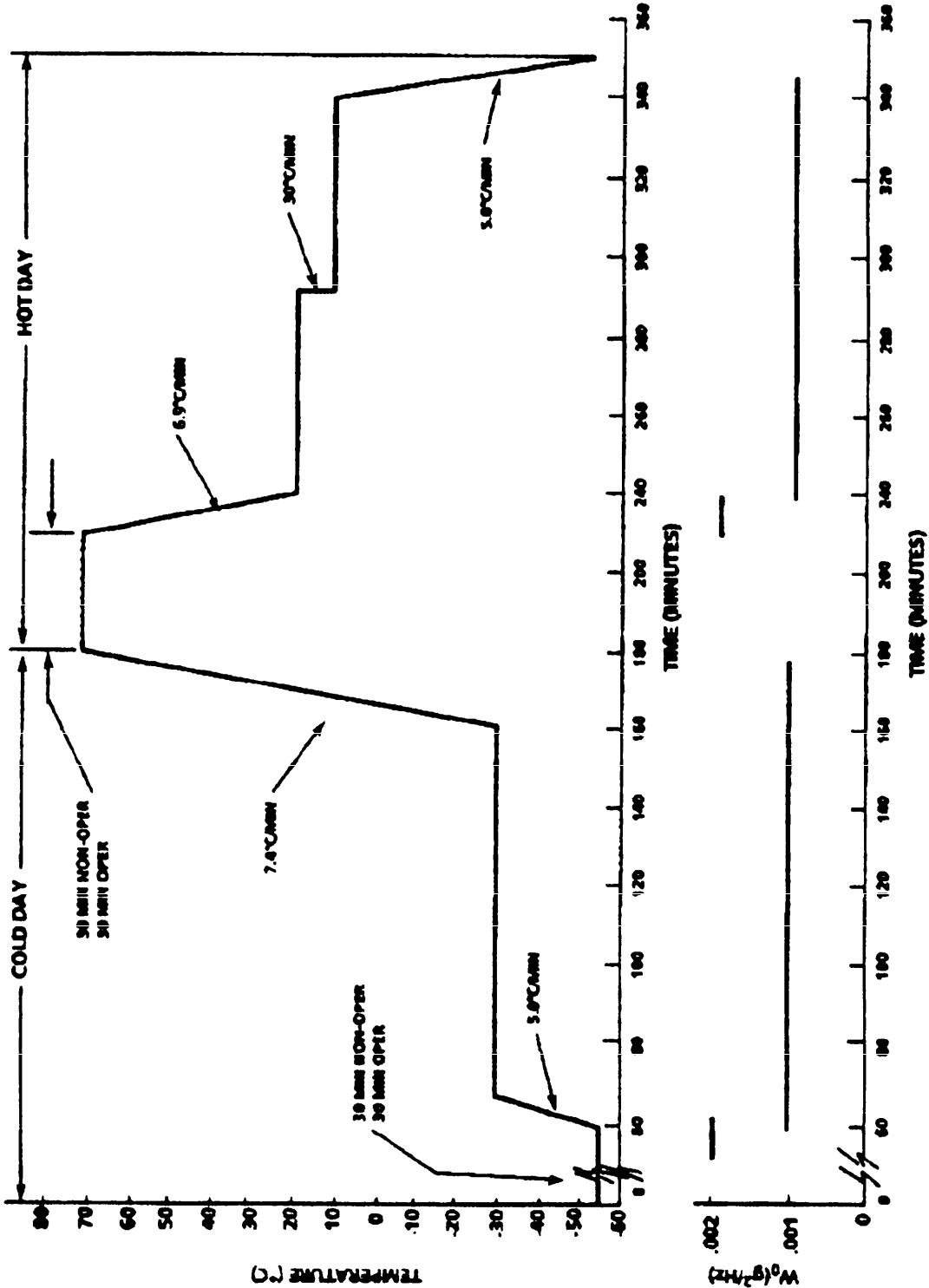

FIGURE 85. Eighter aircraft test profile (high-high-high)

MIL-HDBK-781

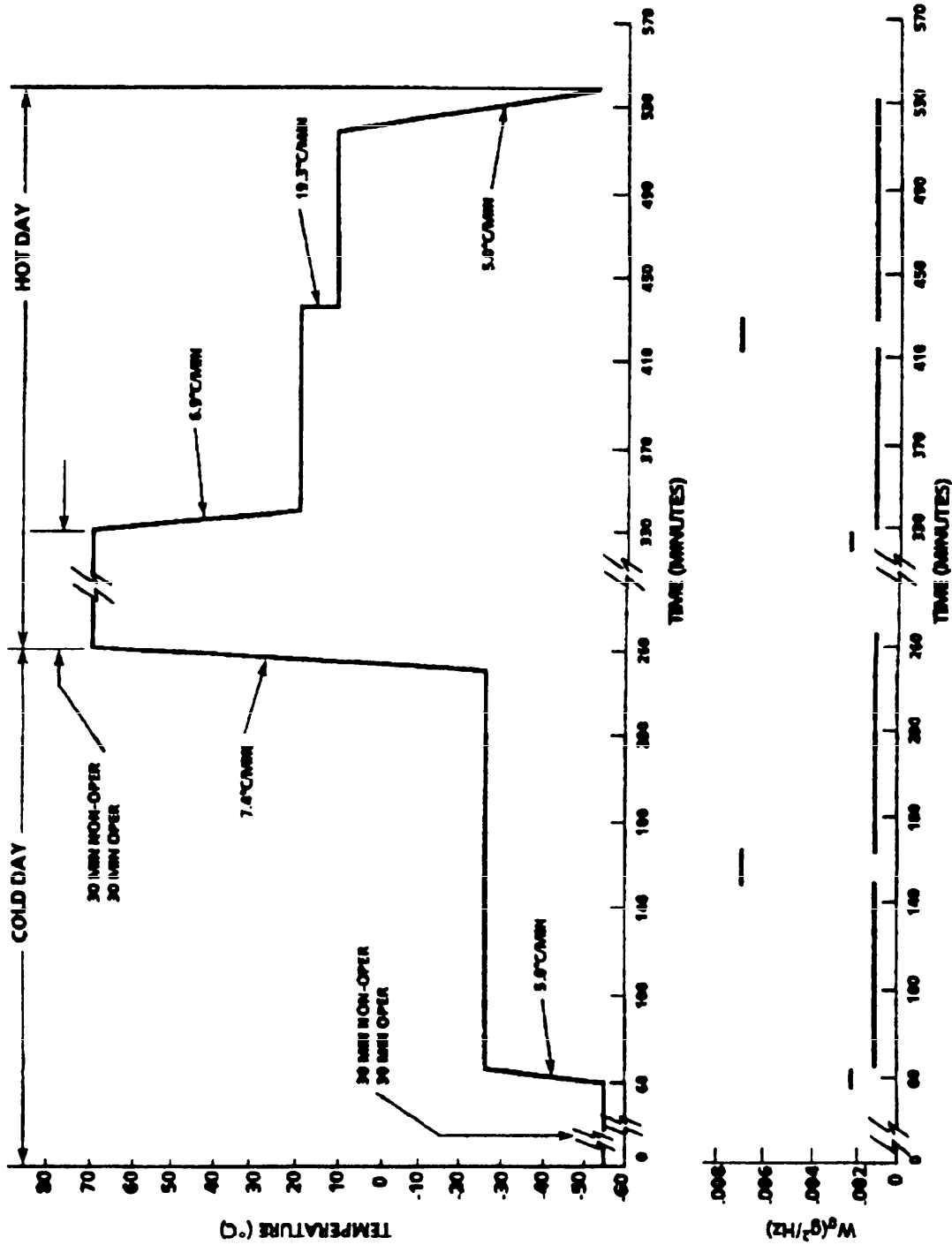

FIGURE 86. Eighter aircraft test profile (escort)

MIL-HDBK-781

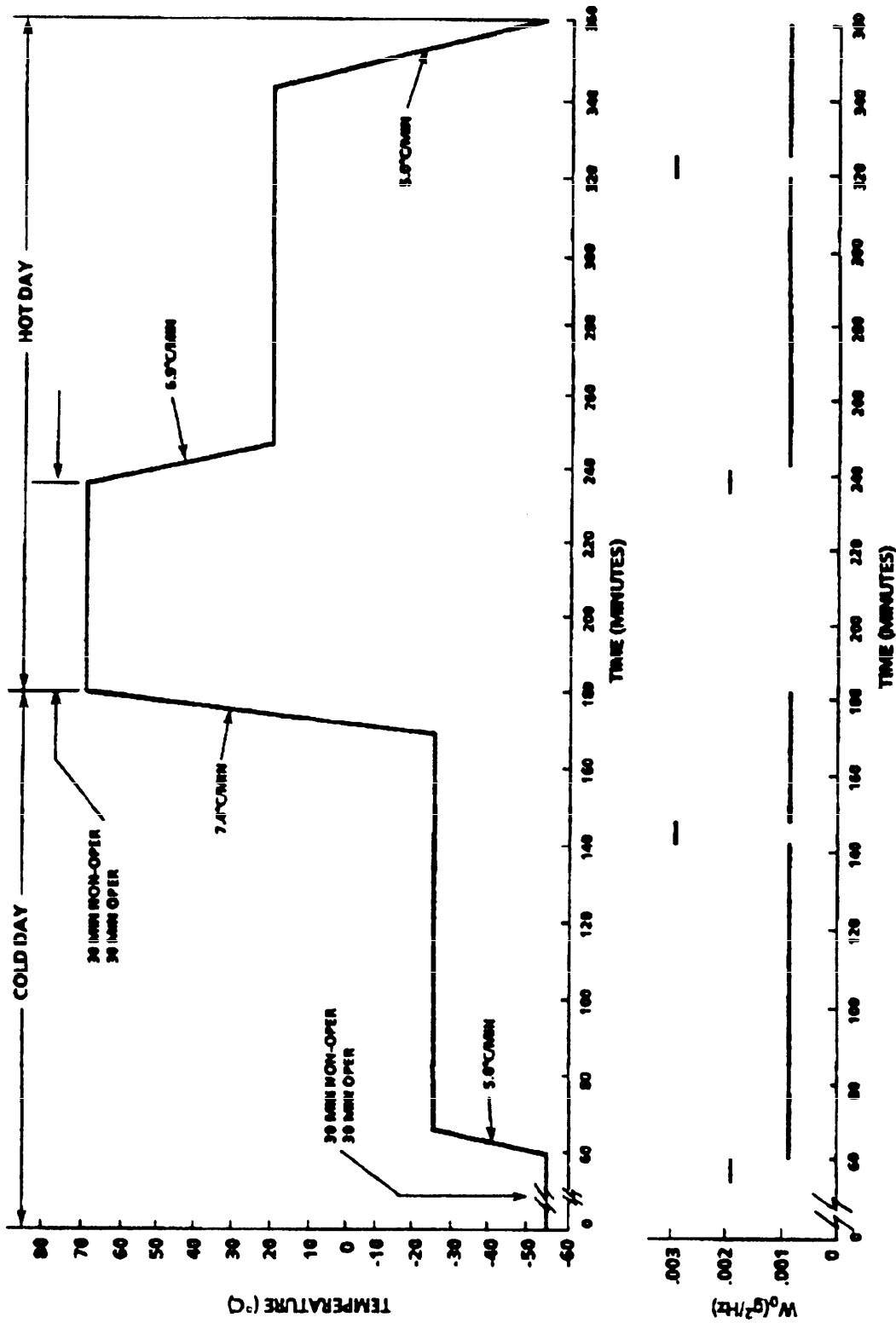

FIGURE 87. Eighter aircraft test profile (air defense and captive flight)

MIL-HDBK-781

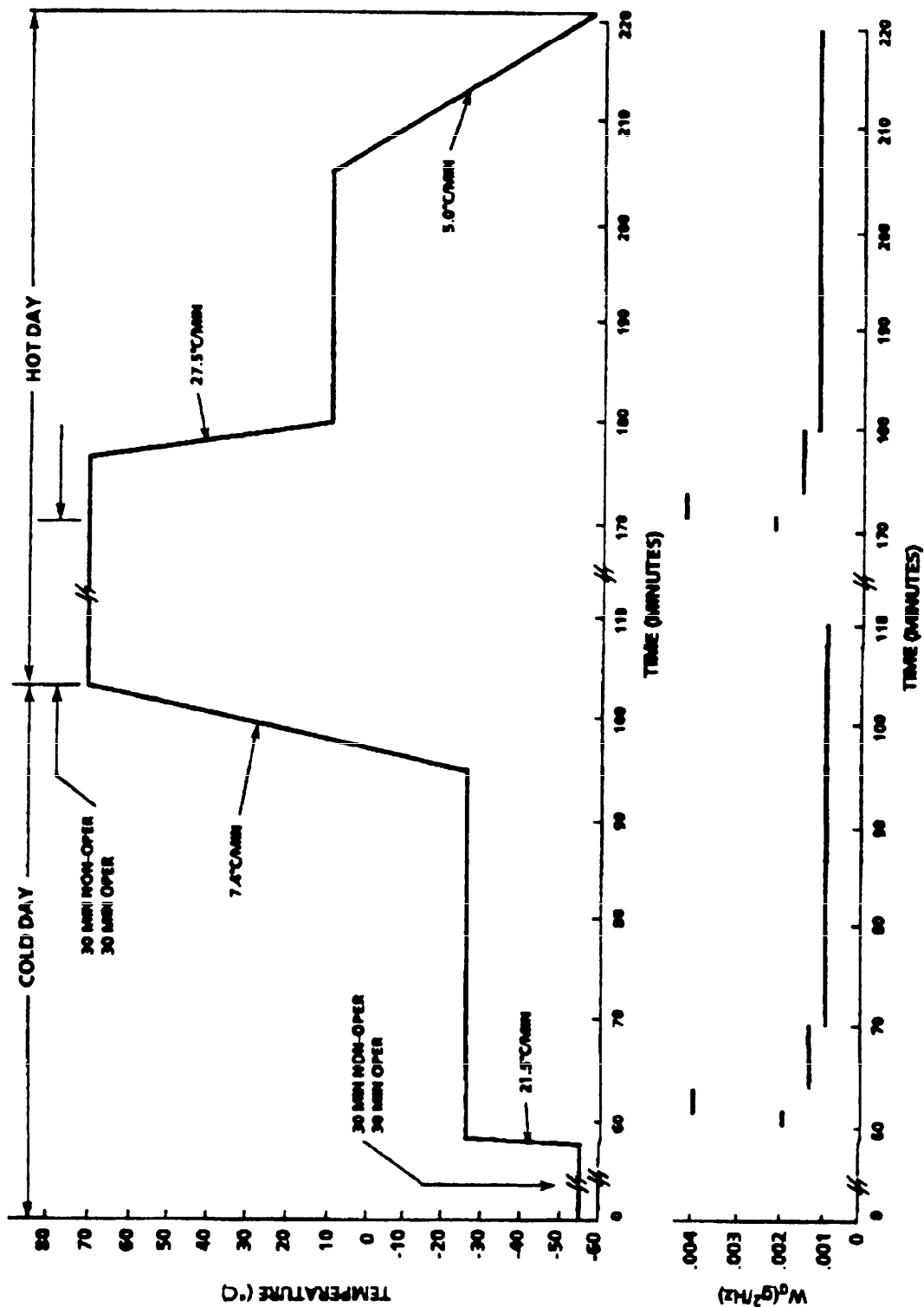

FIGURE 88. Fighter aircraft test profile (intercept)

MIL-HDBK-781

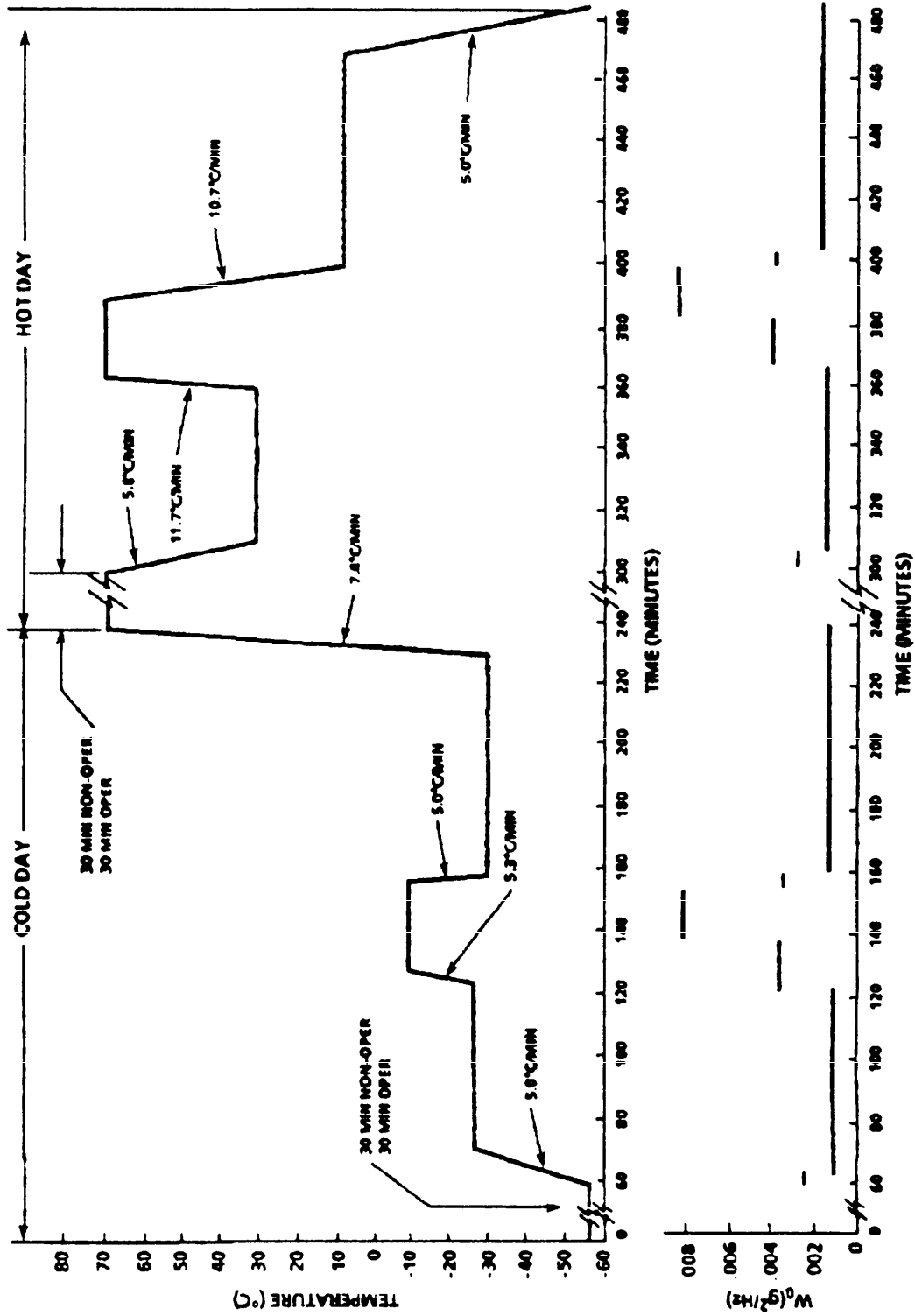

FIGURE 89. Fighter aircraft test profile (high-low-low-high)

MIL-HDBK-781

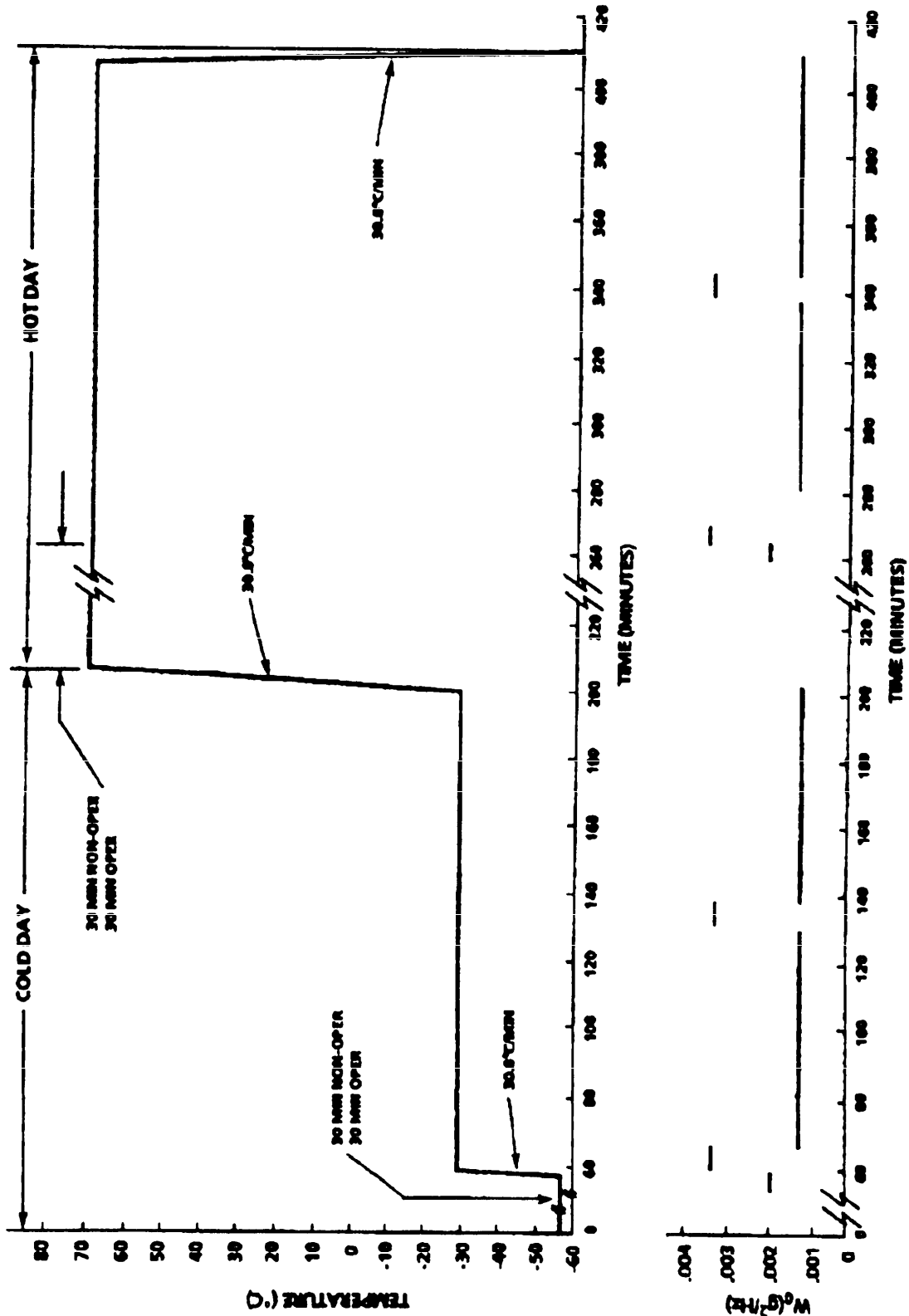

FIGURE 90. Fighter aircraft test profile (low-low-low)

MIL-HDBK-781

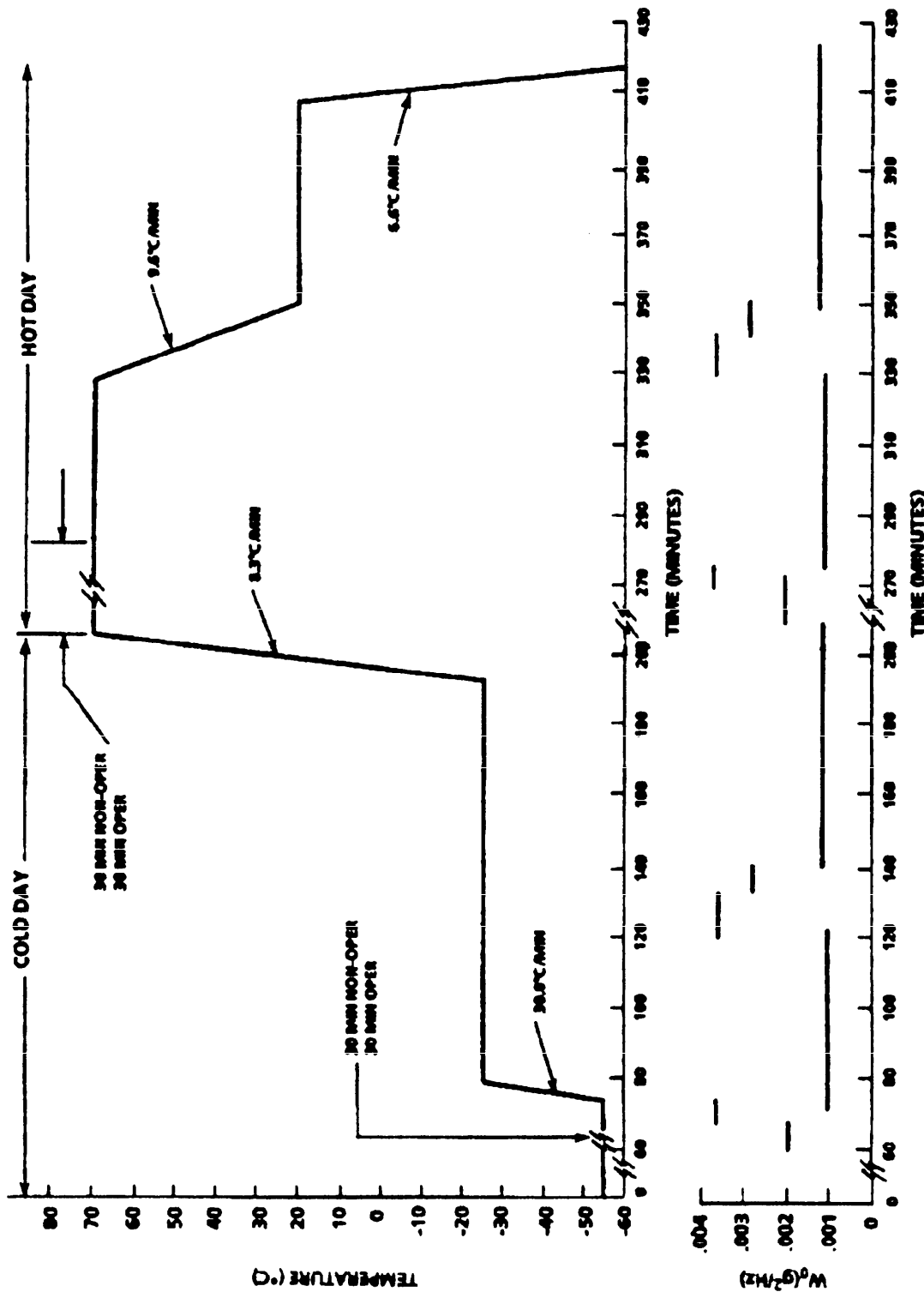

FIGURE 91. Fighter aircraft test profile (low-low-high)

MIL-HDBK-781

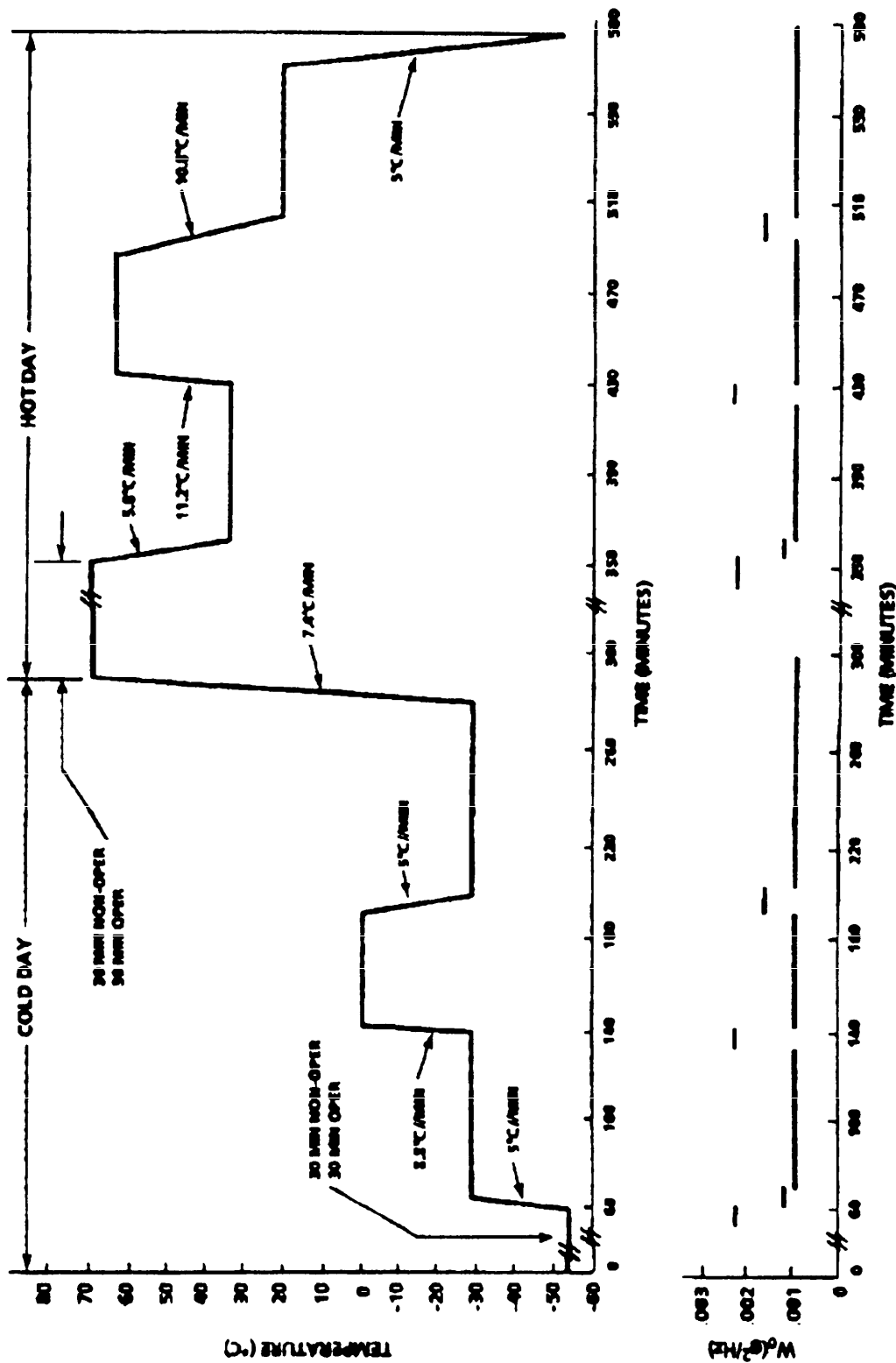

FIGURE 92. Fighter aircraft test profile (close support)

MIL-HDBK-781

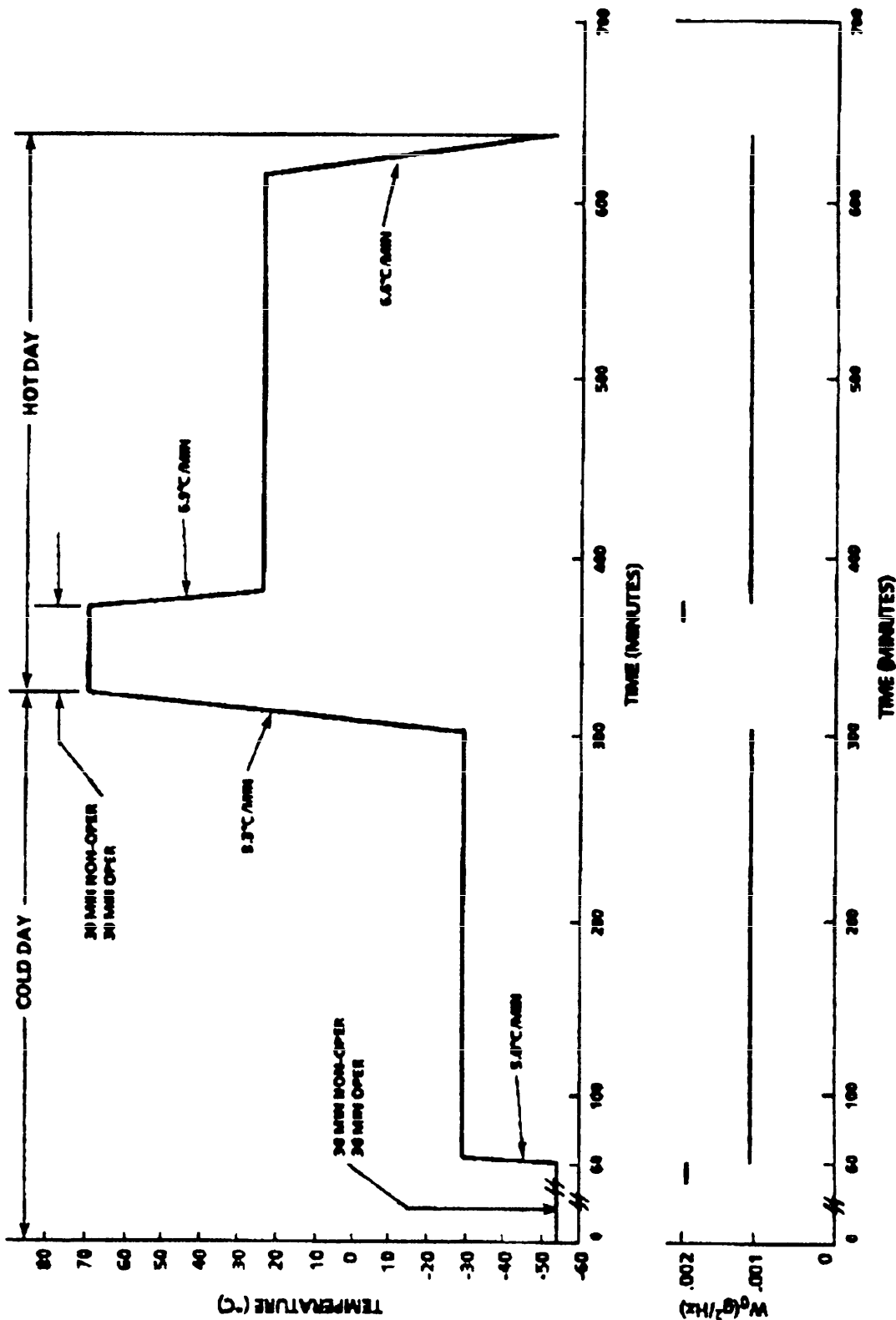

FIGURE 93. Fighter aircraft test profile (ferry)

MIL-HDBK-781

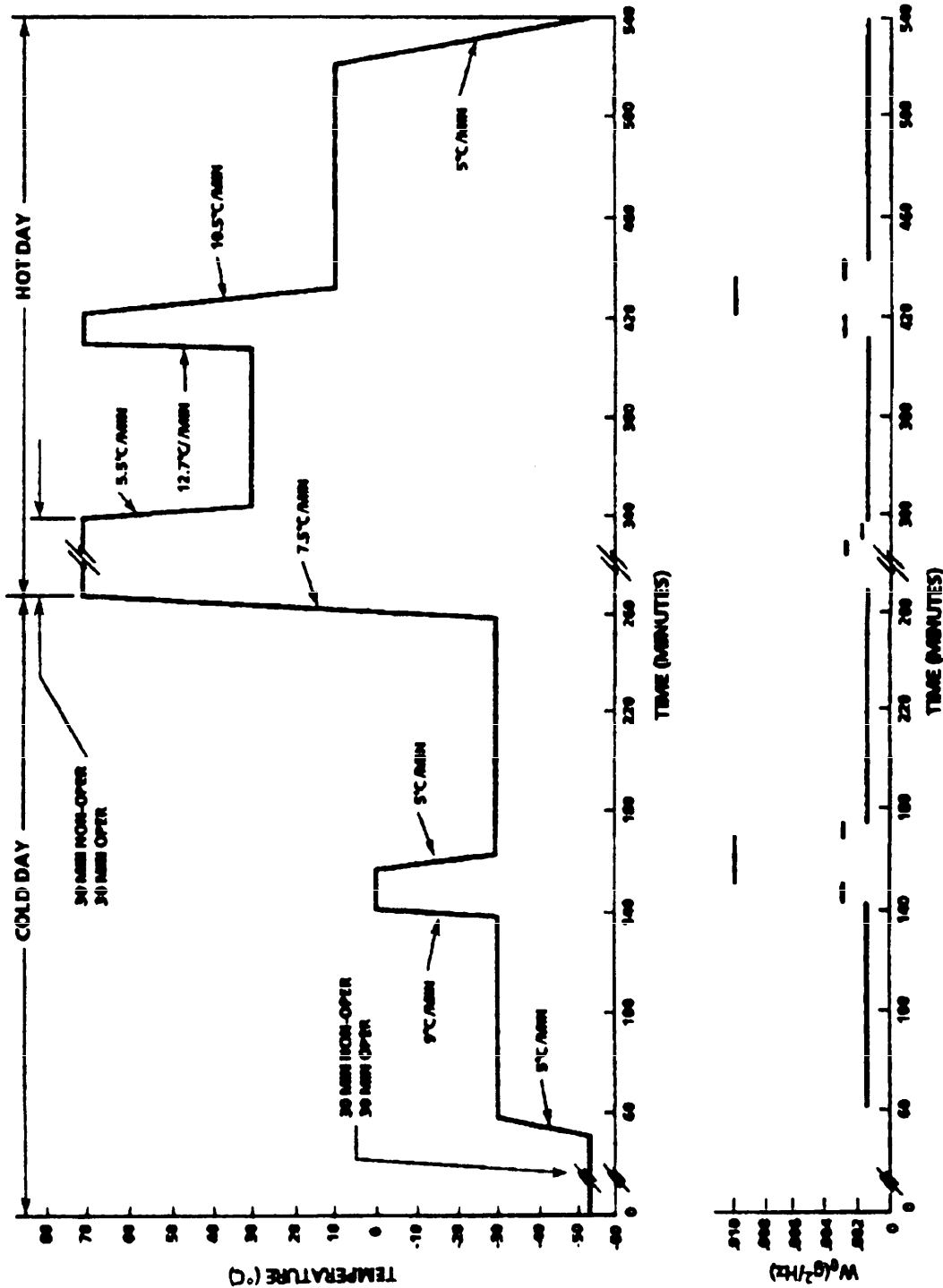

FIGURE 94. Reconnaissance aircraft test profile (high-low-high)

MIL-HDBK-781

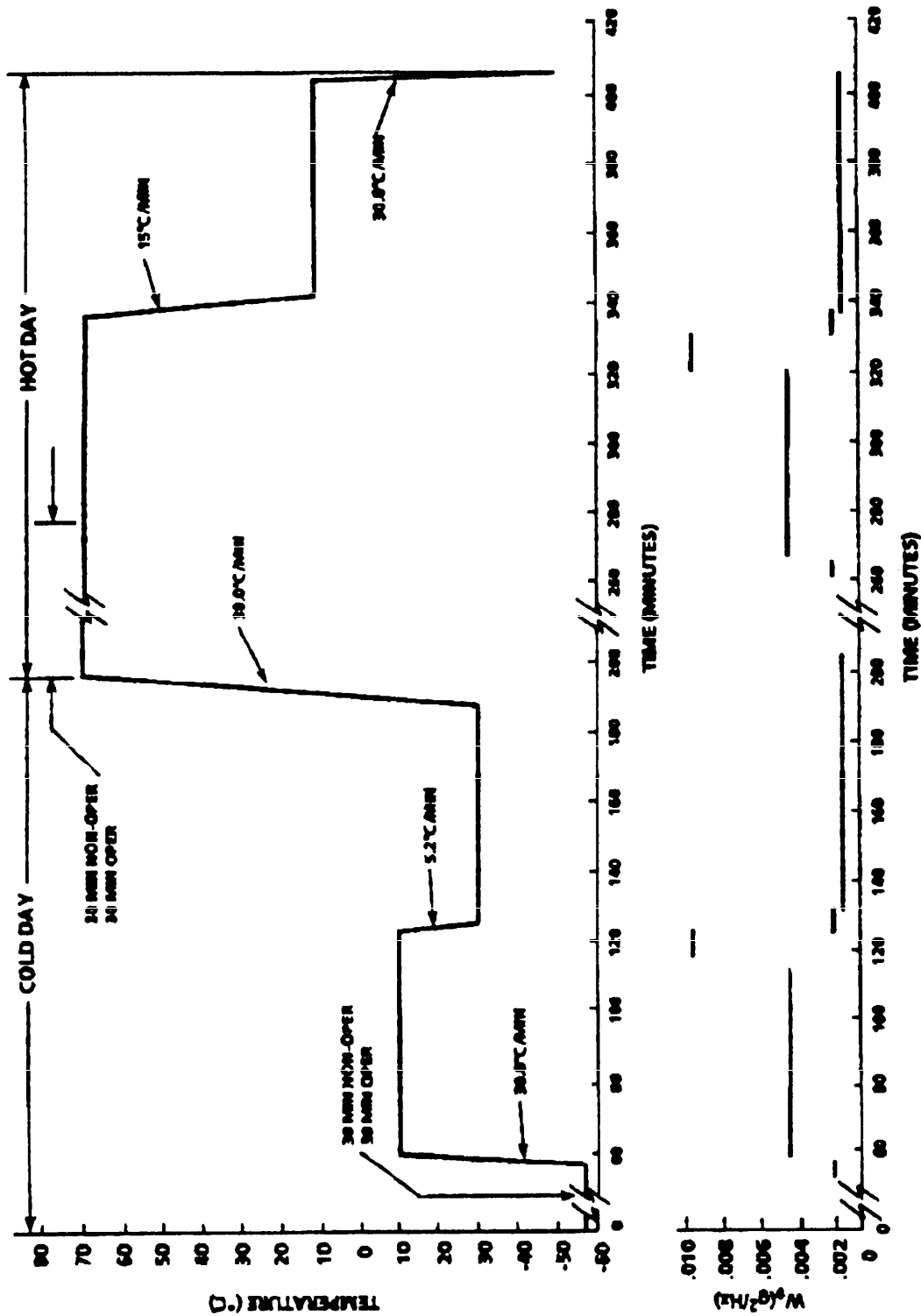

FIGURE 95. Reconnaissance aircraft test profile (low-low-high)

MIL-HDBK-781

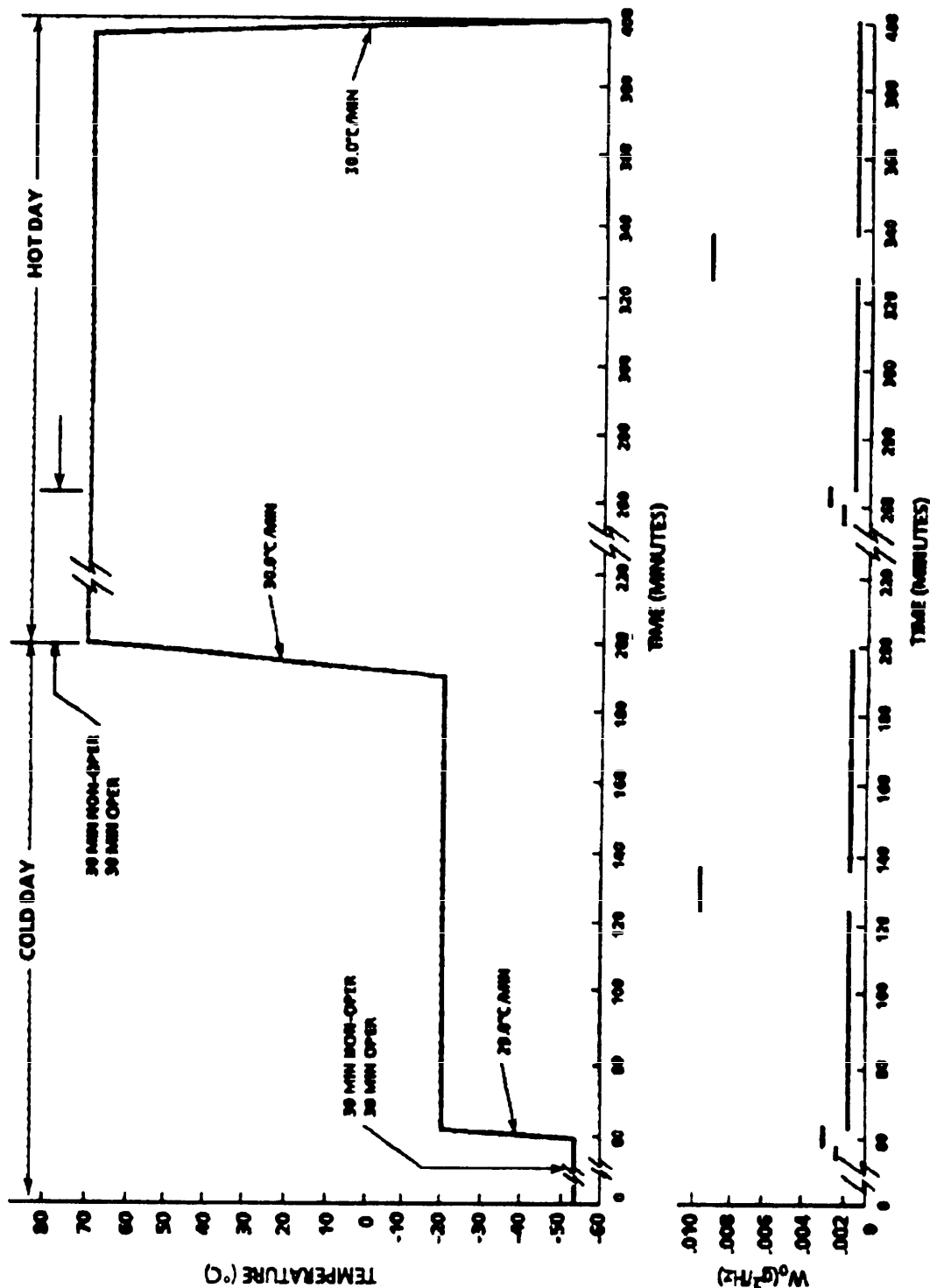

FIGURE 96. Reconnaissance aircraft test profile (low-low-low)

MIL-HDBK-781

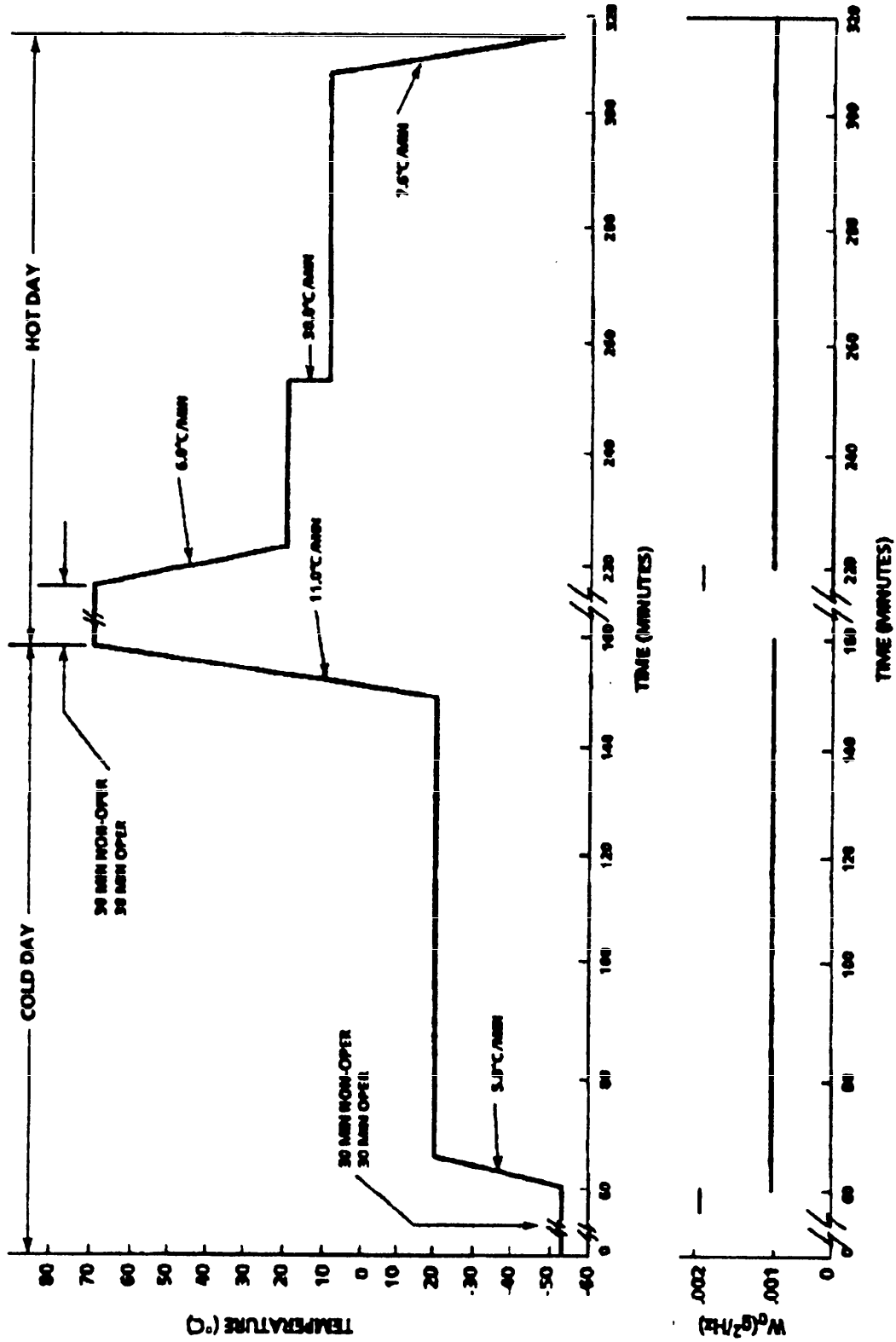

FIGURE 97. Reconnaissance aircraft test profile (high-supersonic)

MIL-HDBK-781

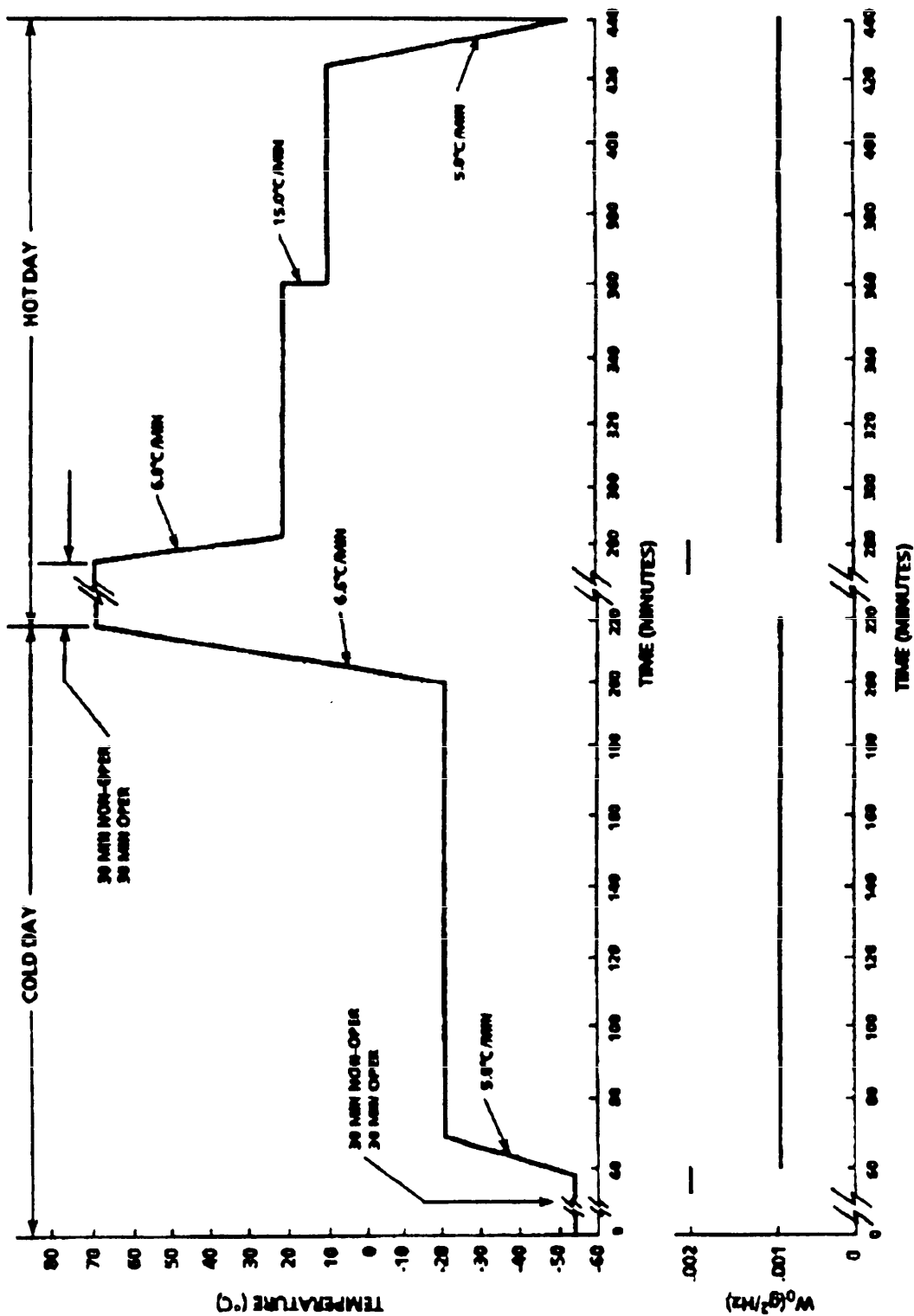

FIGURE 98. Reconnaissance aircraft test profile (high-subsonic).

MIL-HDBK-781

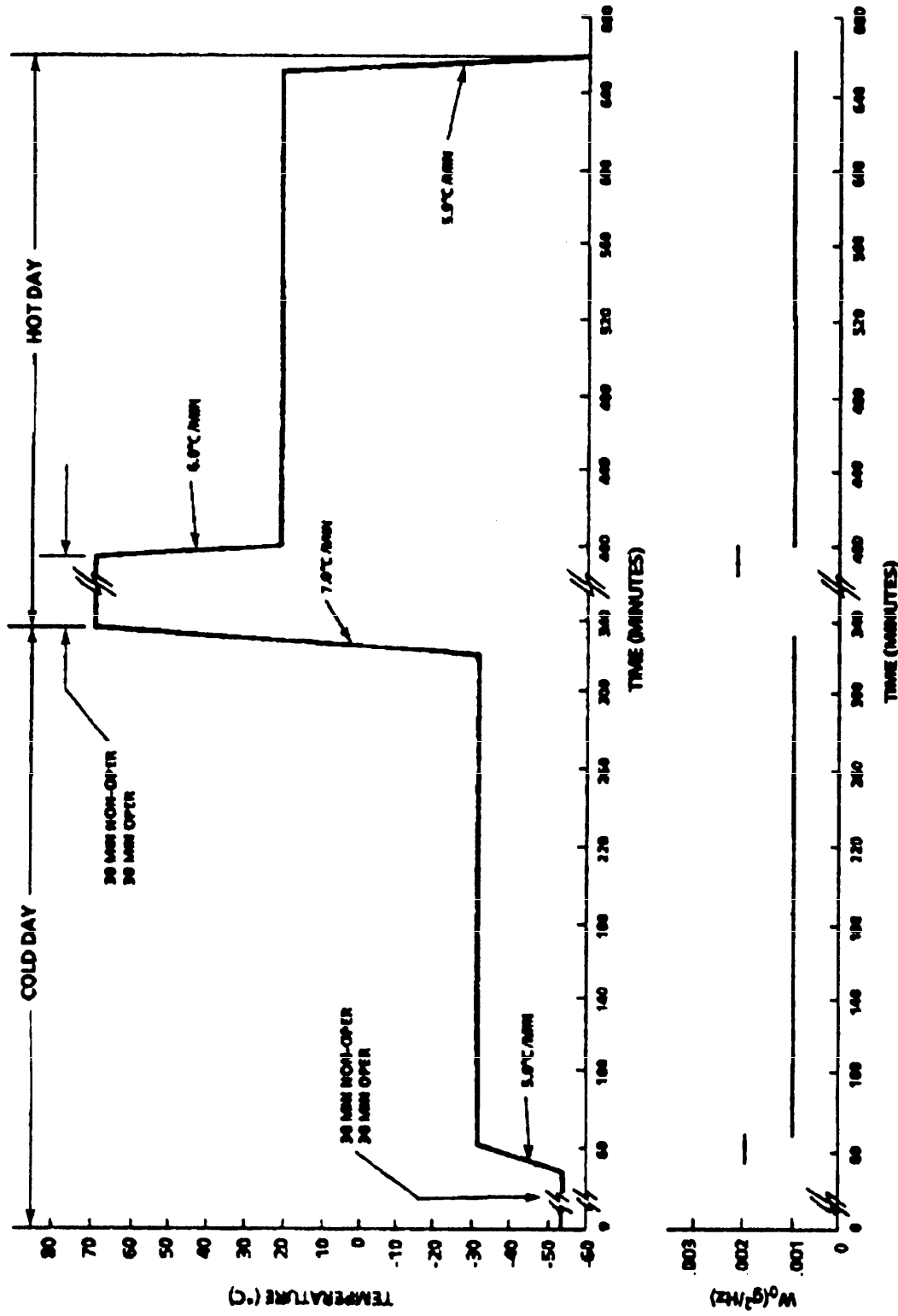

FIGURE 99. Reconnaissance aircraft test profile (ferry)

MIL-HDBK-781

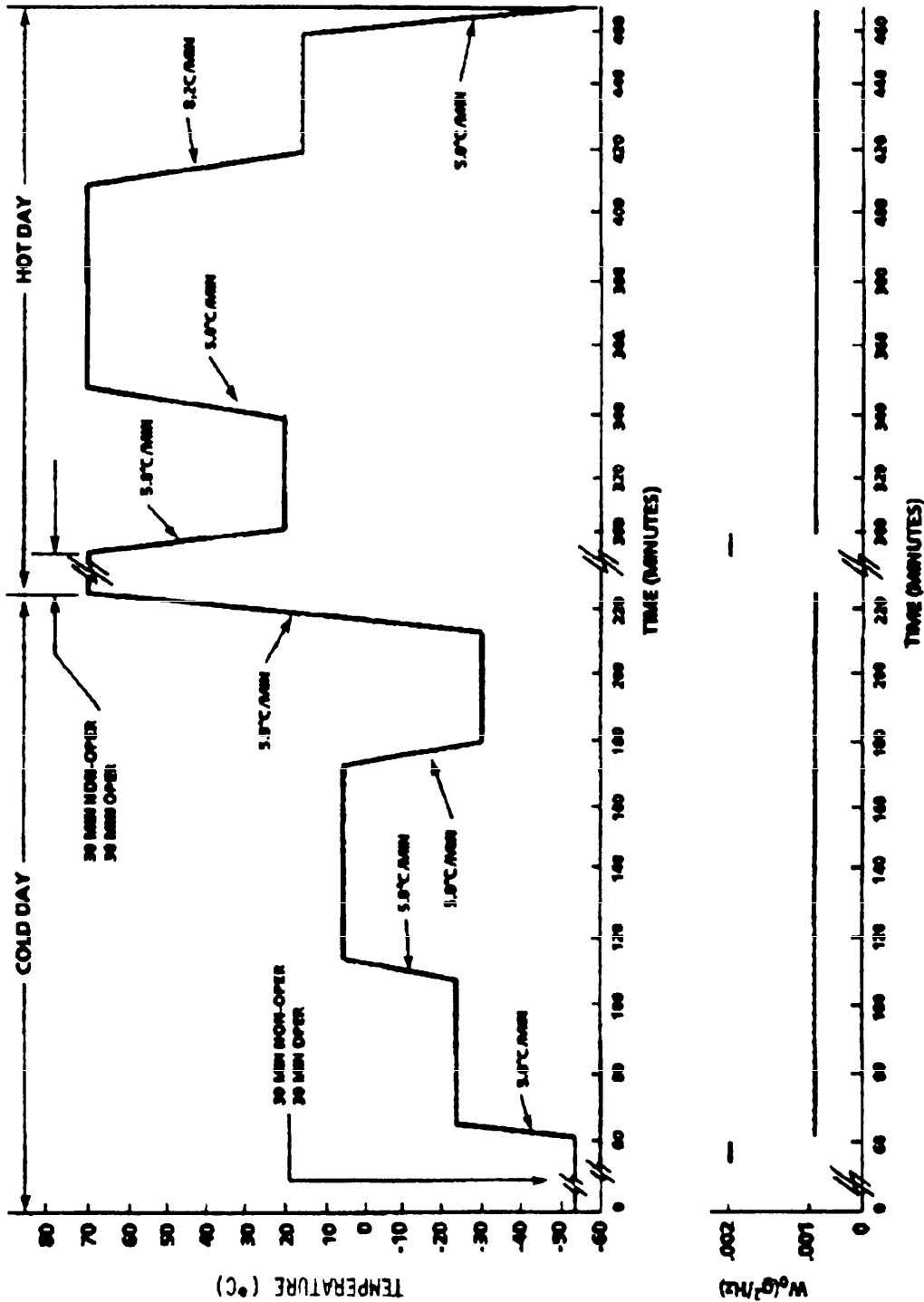

FIGURE 100. Tanker aircraft test profile (high-low-high refuel)

MIL-HDBK-781

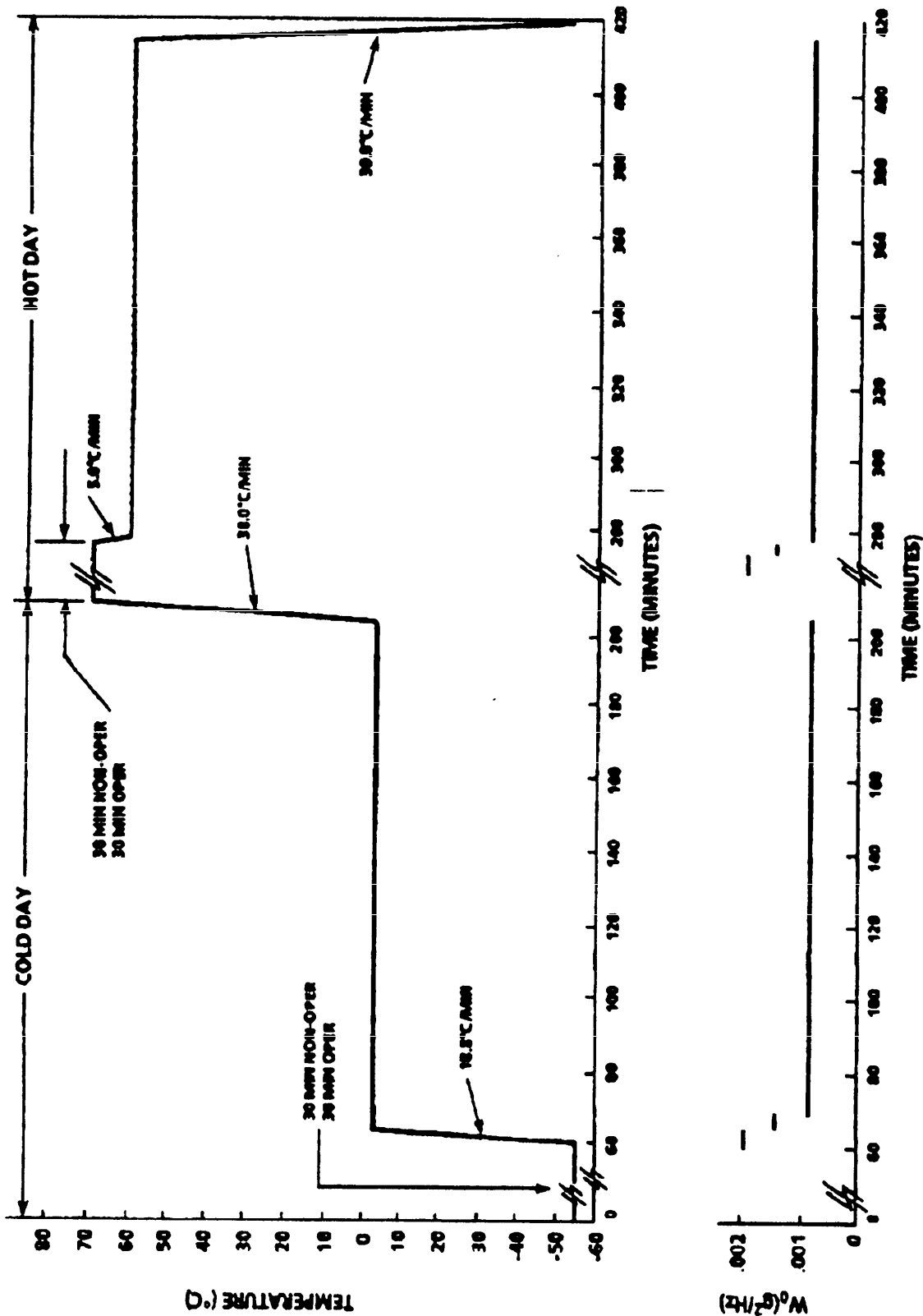

FIGURE 101. Tanker aircraft (low-low refuel)

MIL-HDBK-781

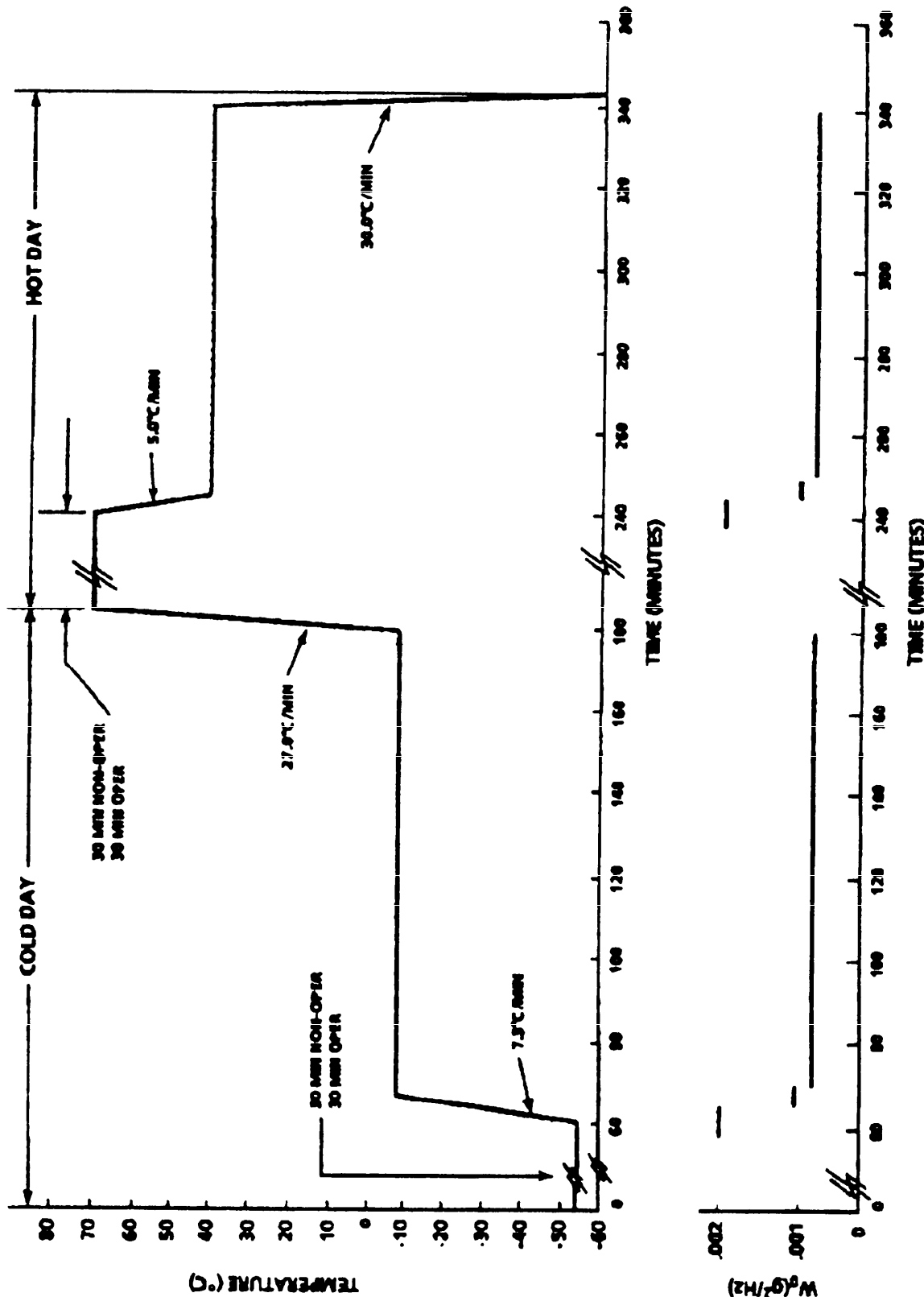

FIGURE 102. Tanker aircraft test profile (strike refuel)

MIL-HDBK-781

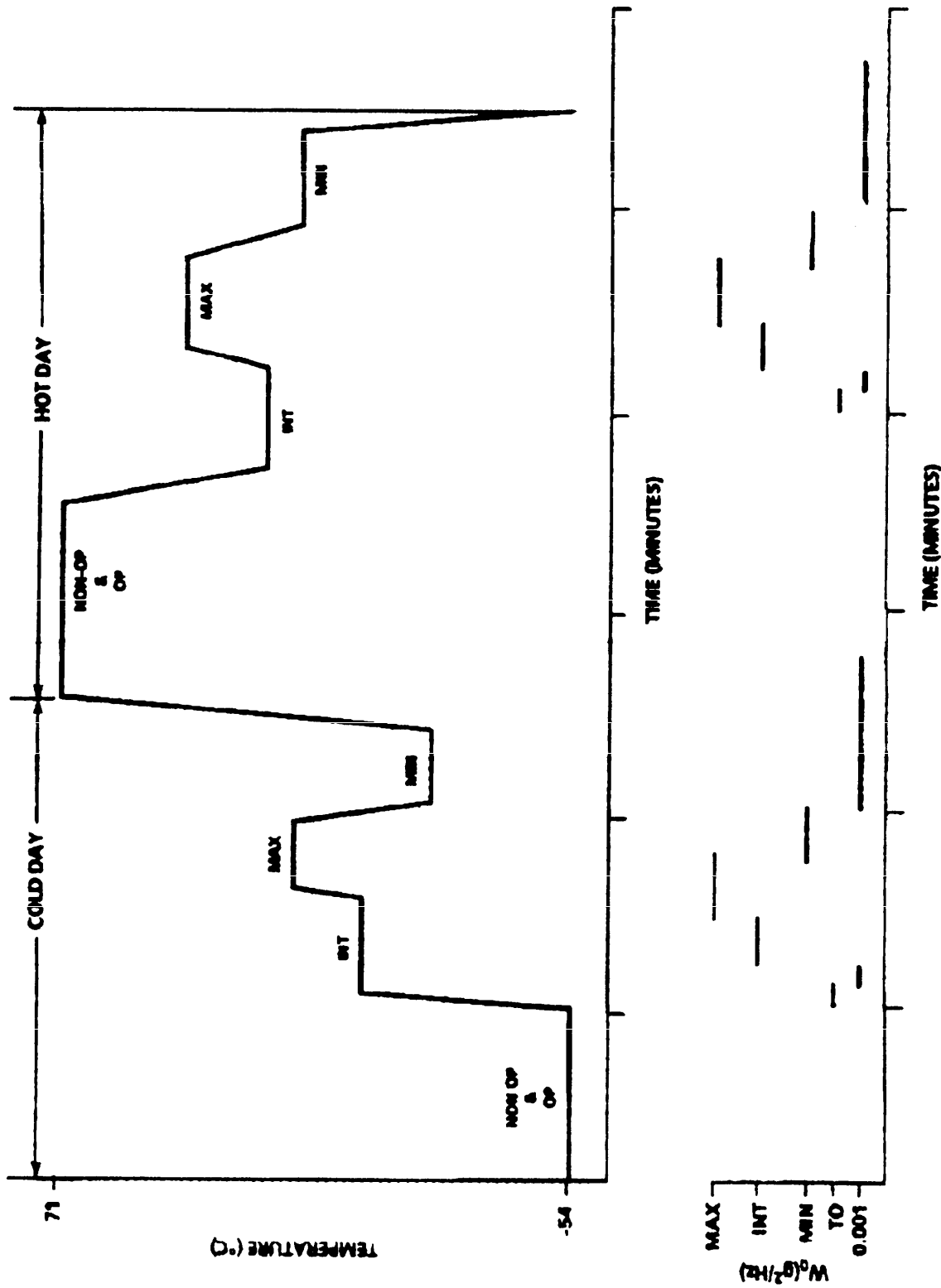

FIGURE 103. Composite test profile (example)

MIL-HDBK-781

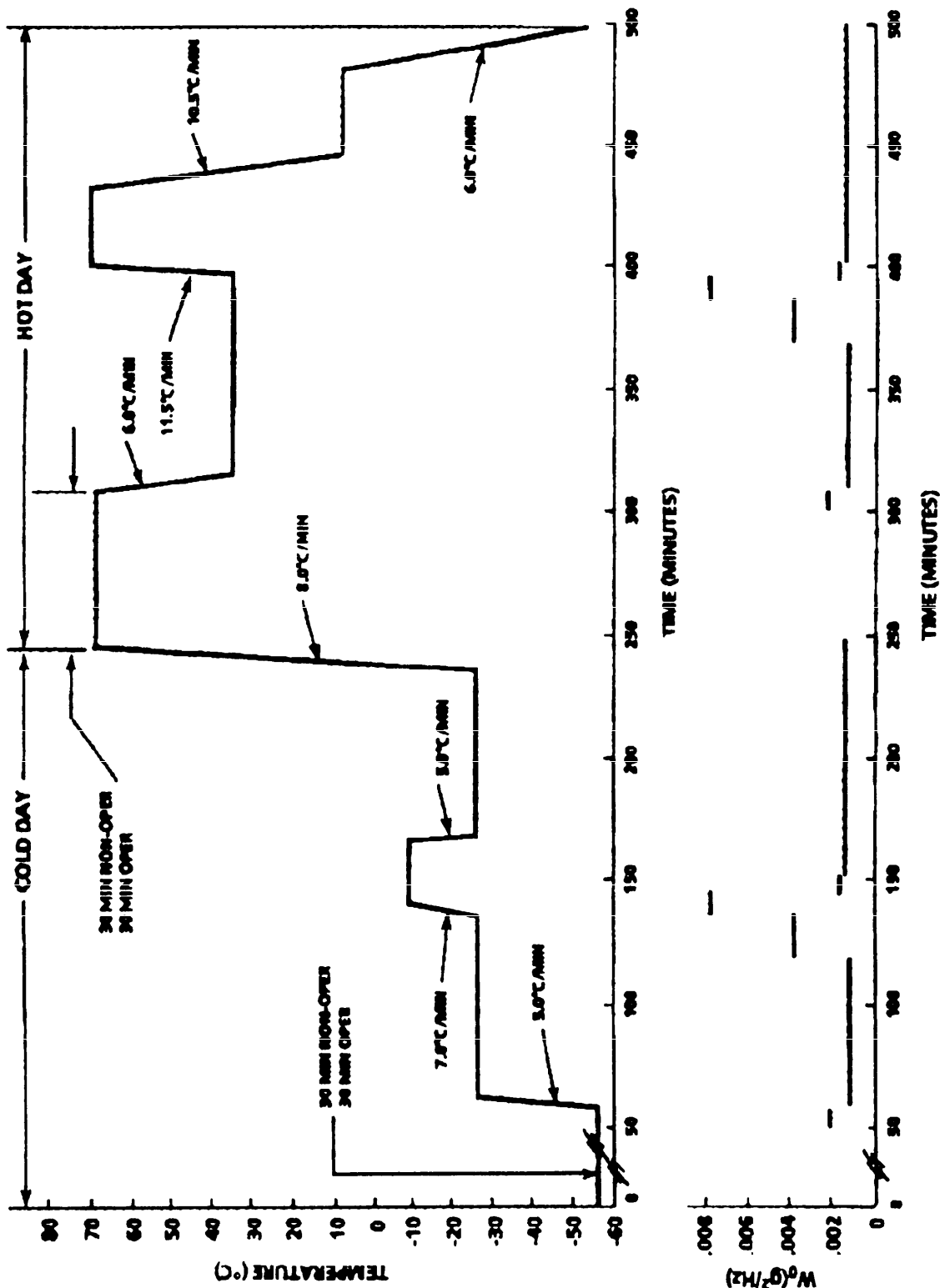

FIGURE 104. Composite test profile (example)

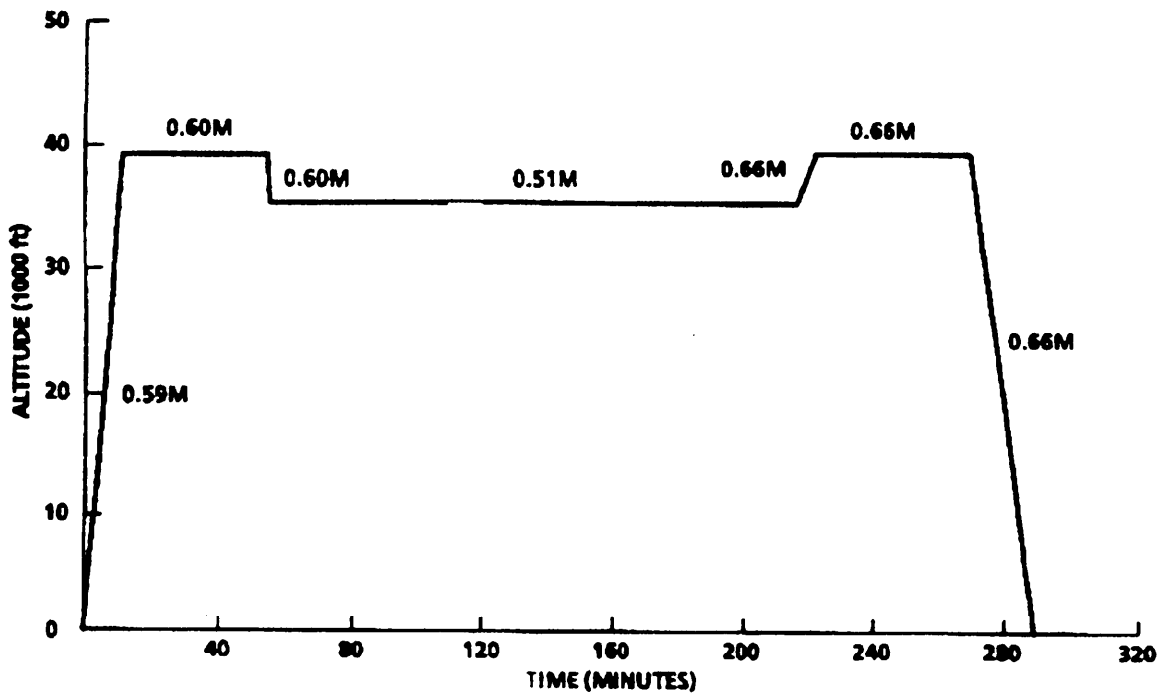

FIGURE 105. Type A V/STOL airborne early warning mission profile

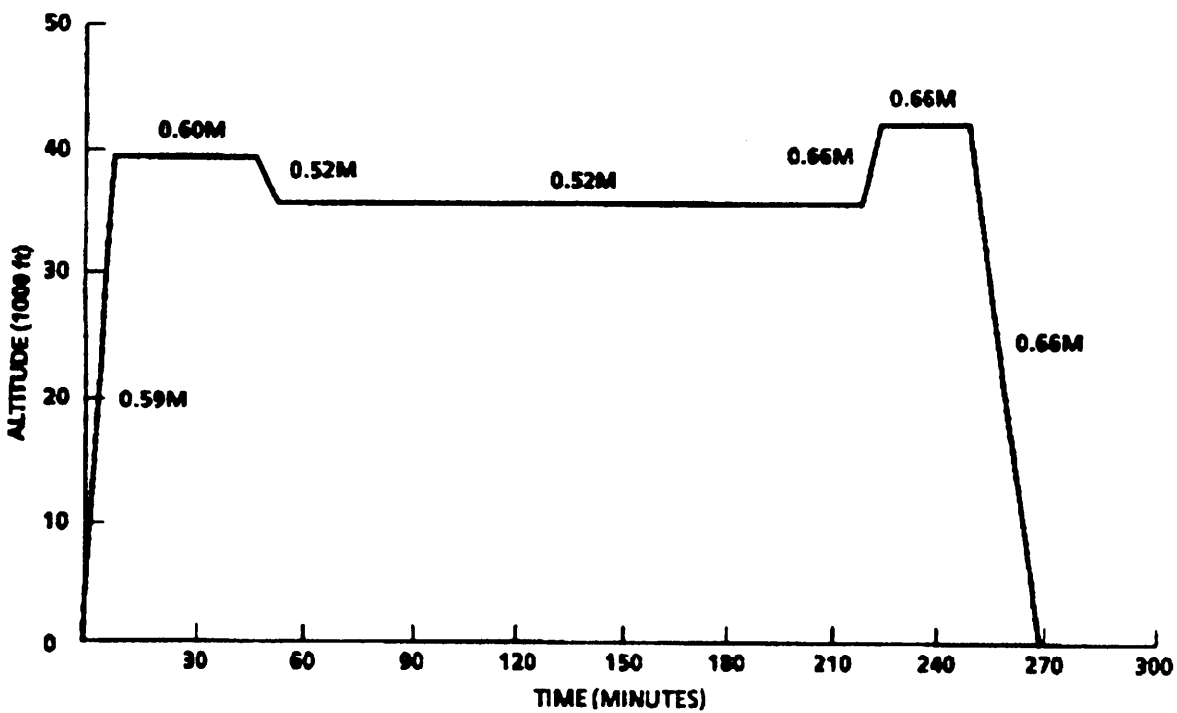

FIGURE 106. Type A V/STOL anti-submarine warfare mission profile

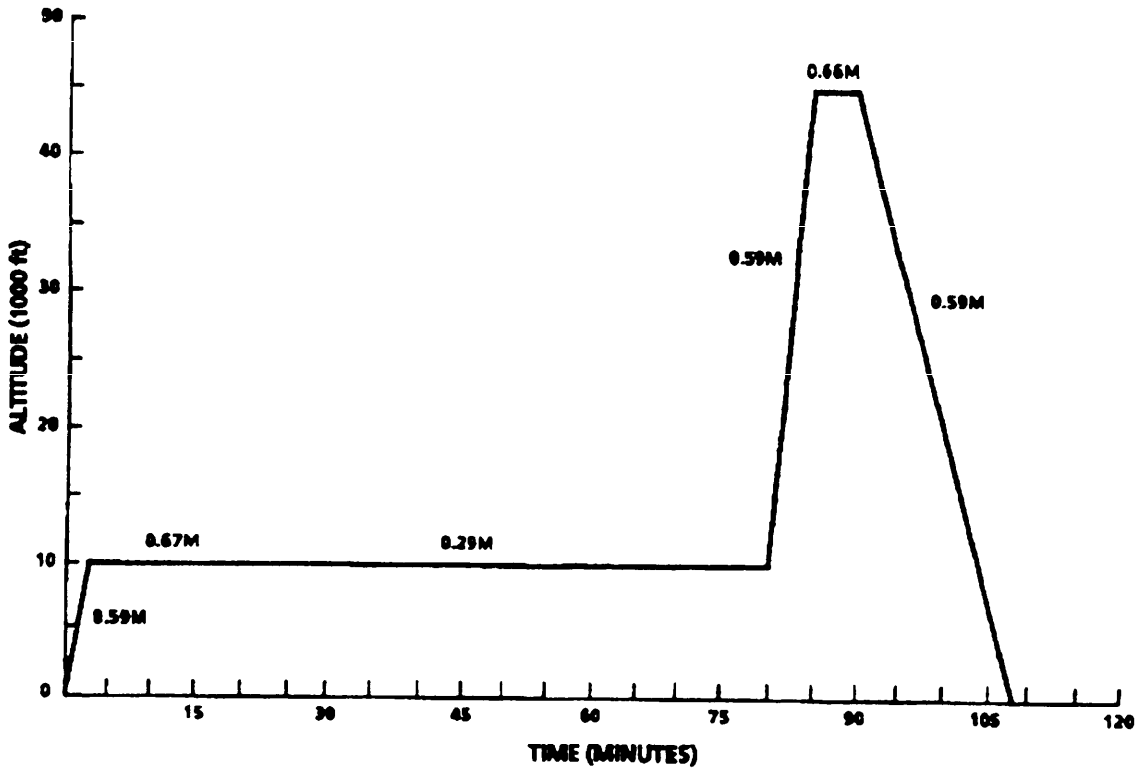

FIGURE 107. Type A V/STOL contact investigation mission profile

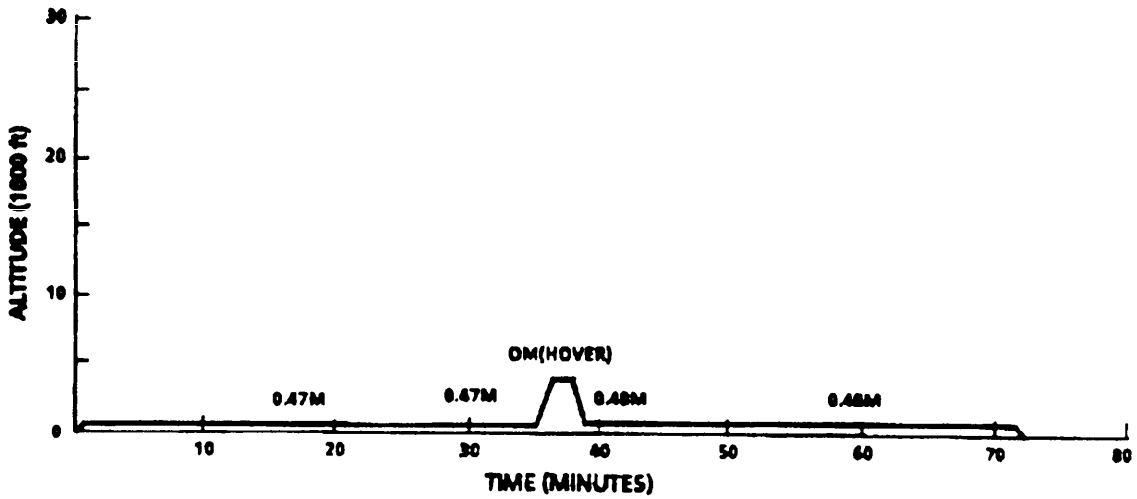

FIGURE 108. Type A V/STOL marine assault mission profile

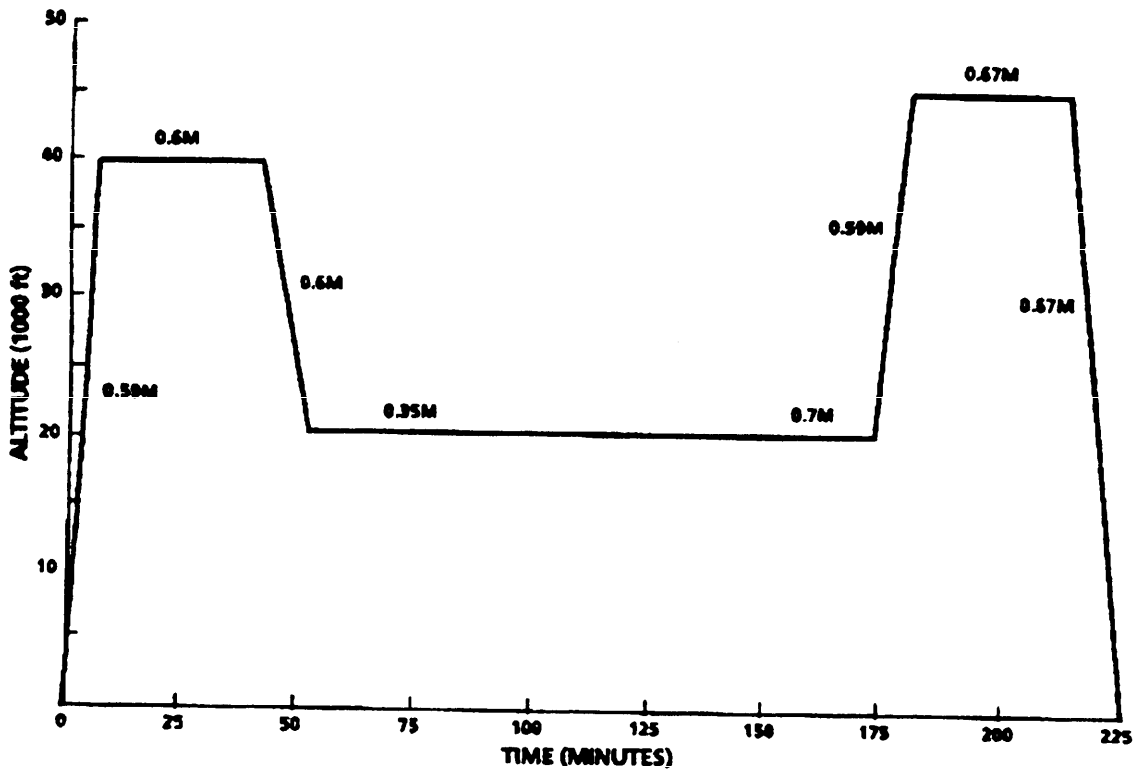

FIGURE 109. Type A V/STOL surface attack mission profile

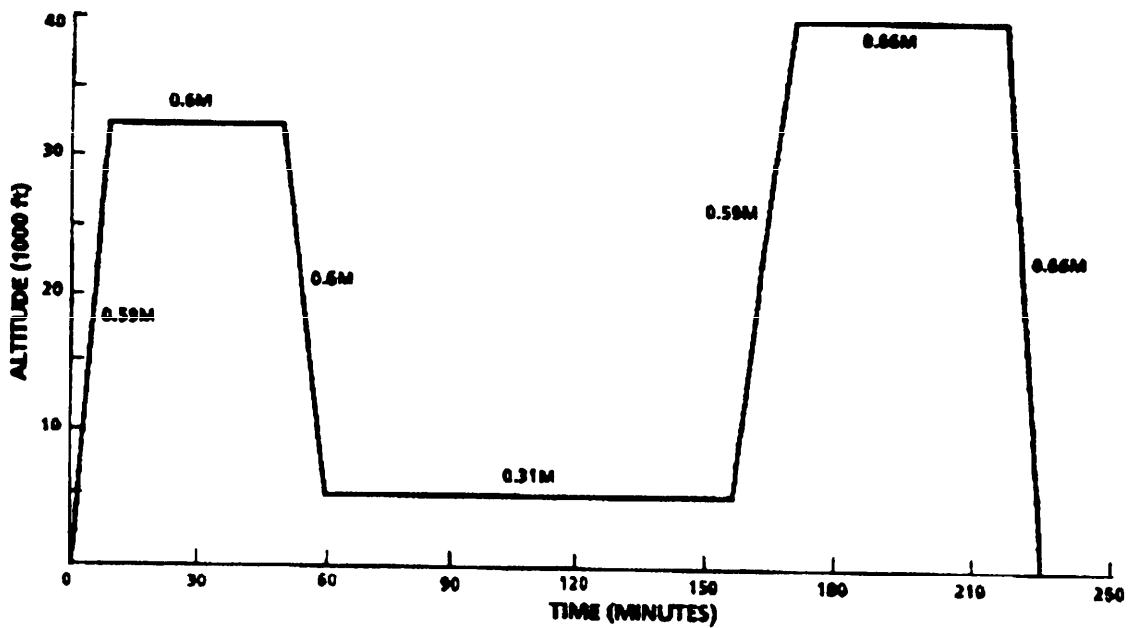

FIGURE 110. Type a V/STOL tanker mission profile

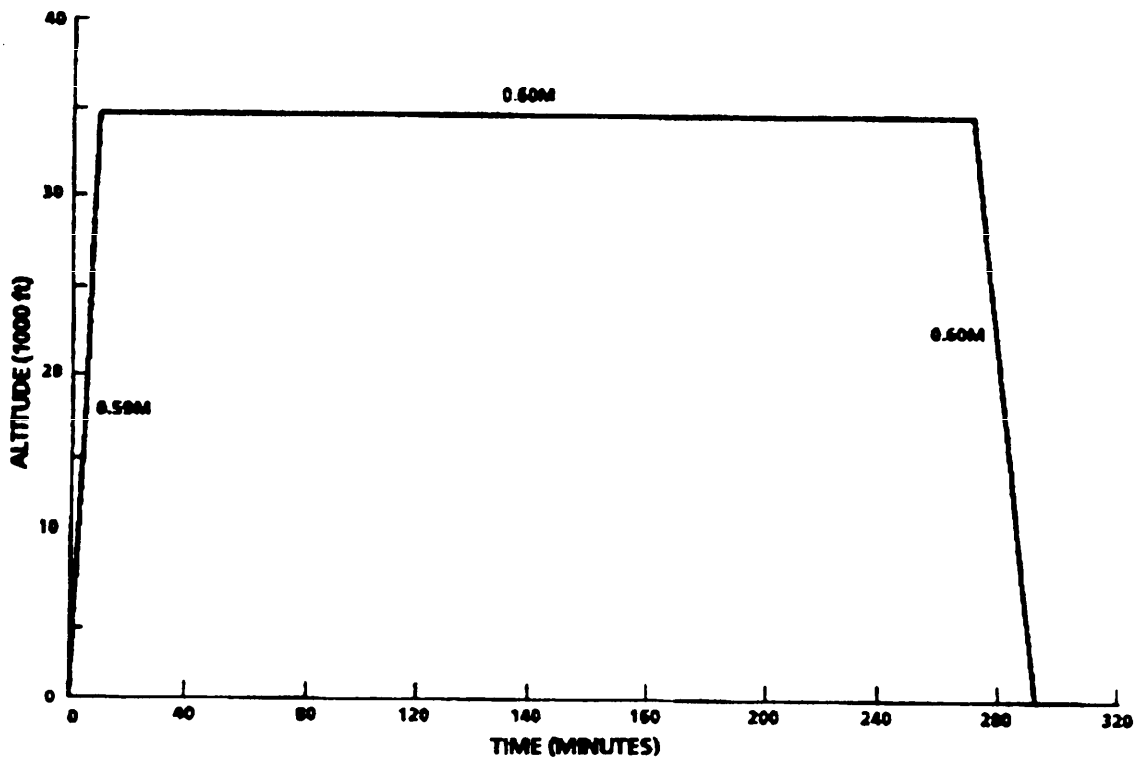

FIGURE 111. Type A V/STOL vertical onboard delivery mission profile

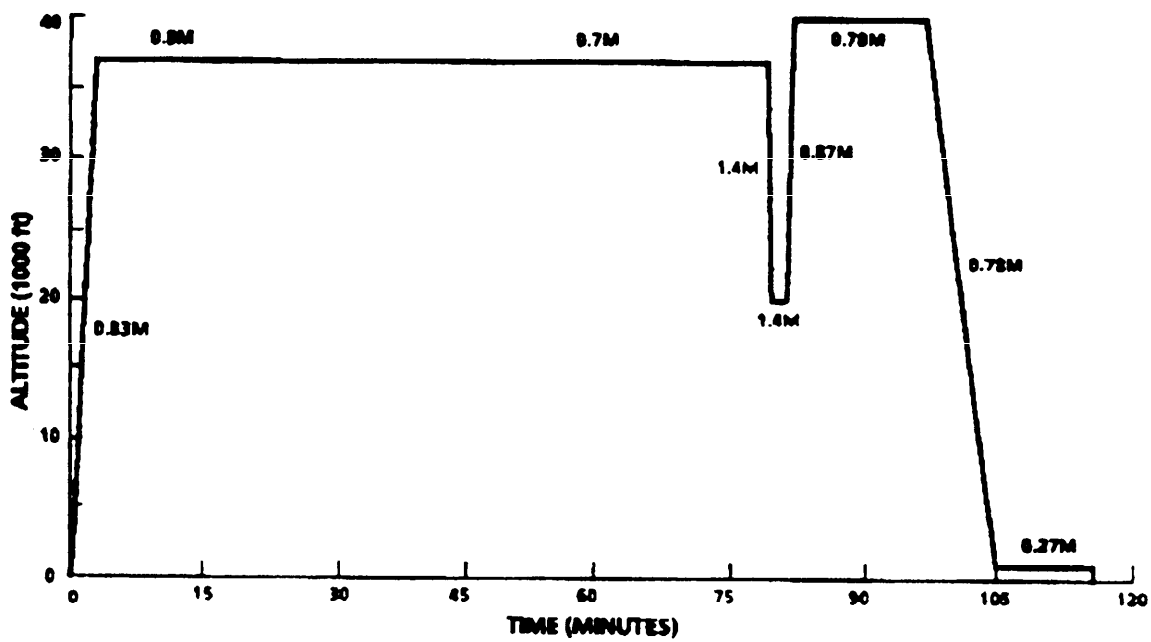

FIGURE 112. Type B V/STOL combat air patrol mission profile

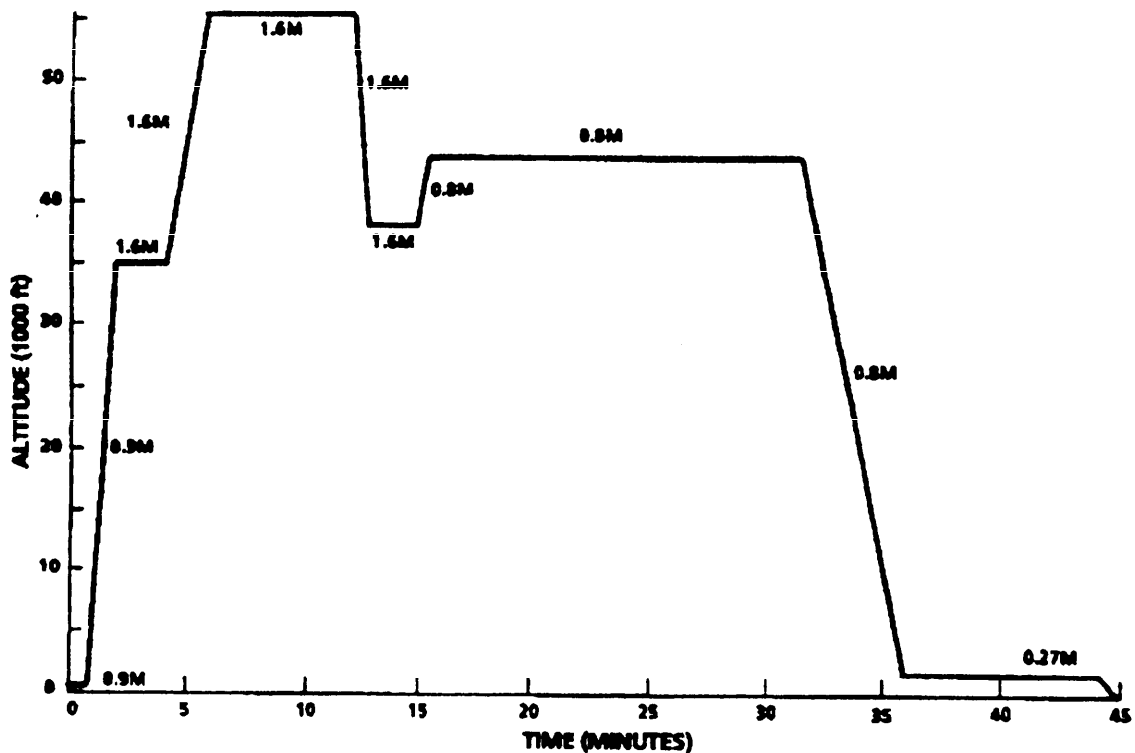

FIGURE 113. Type B V/STOL deck launched intercept mission profile

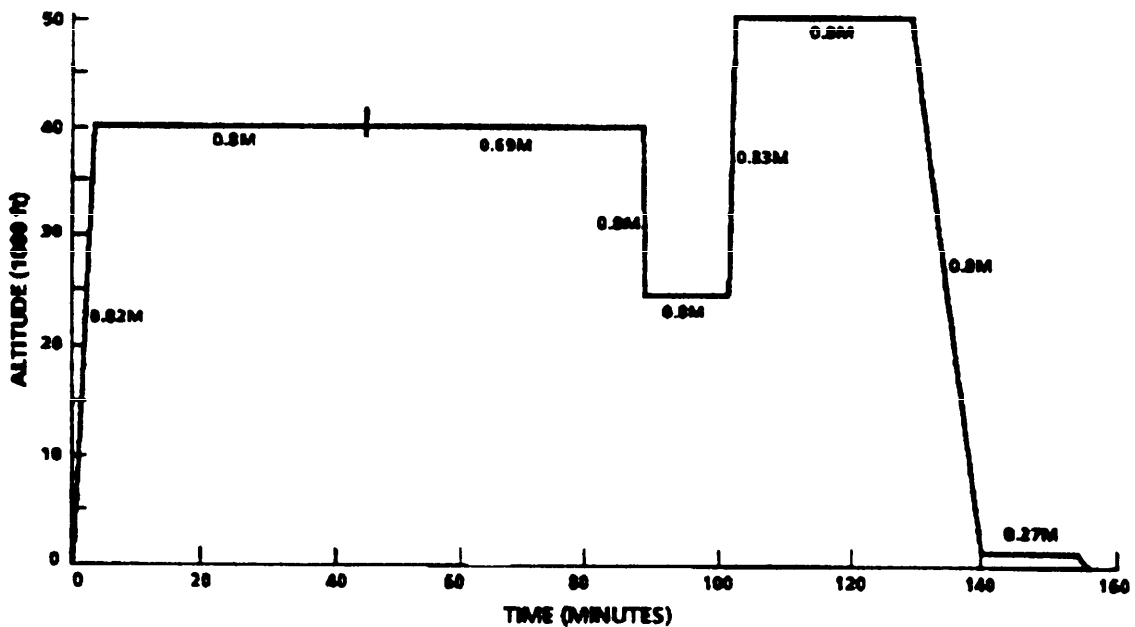

FIGURE 114. Type B V/STOL subsonic surface surveillance mission profile

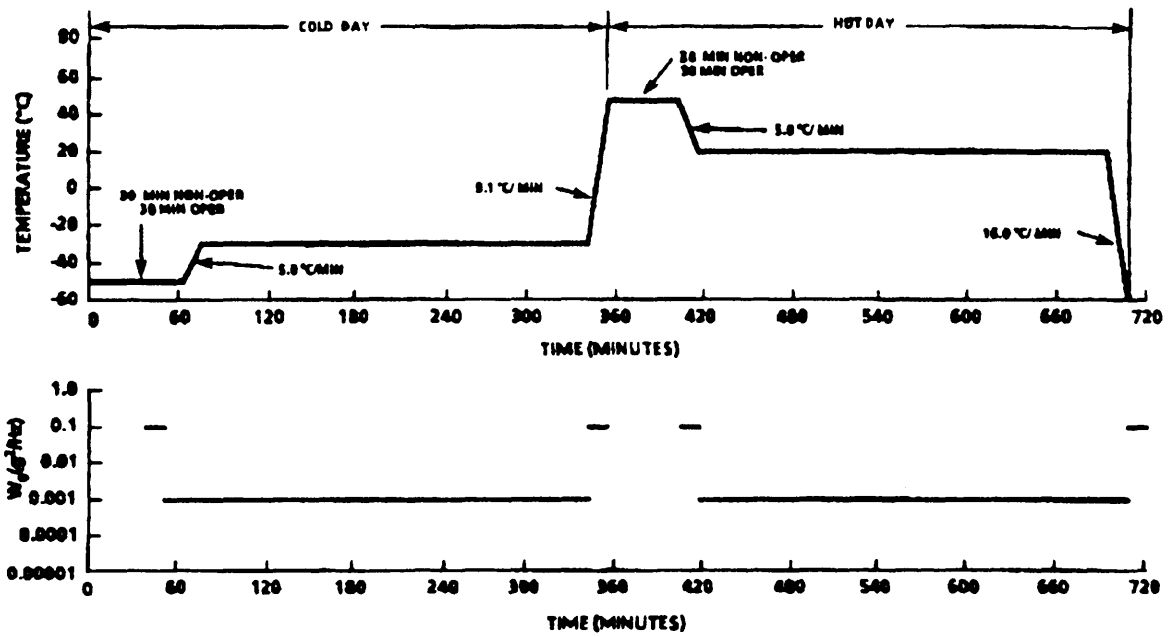

FIGURE 115. Type A V/STOL airborne early warning environmental profile

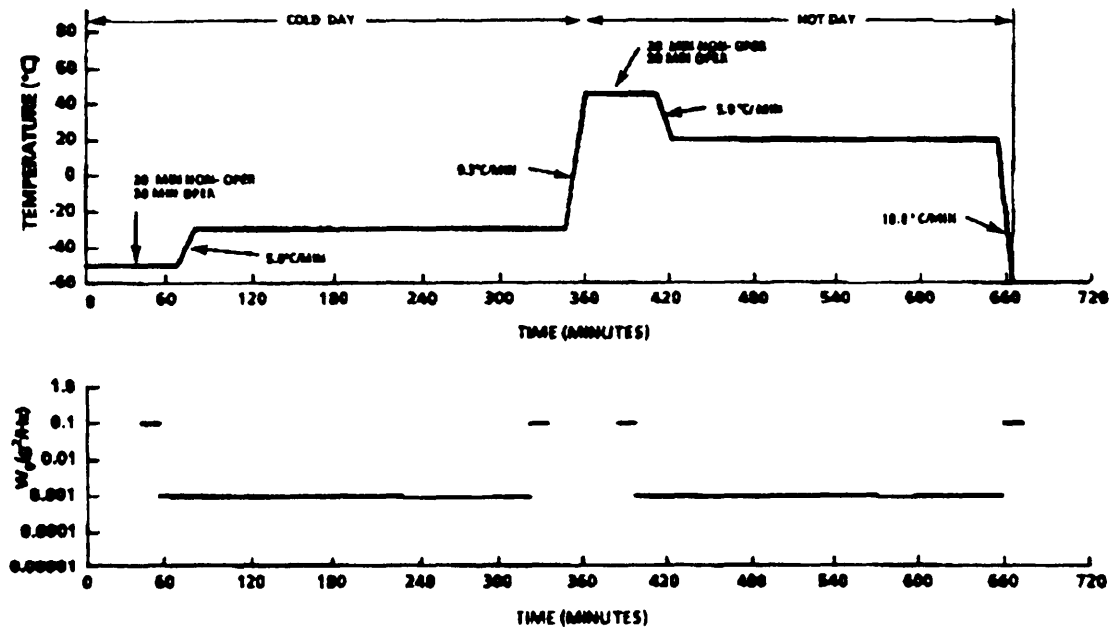

FIGURE 116. Type A V/STOL anti-submarine warfare environmental profile

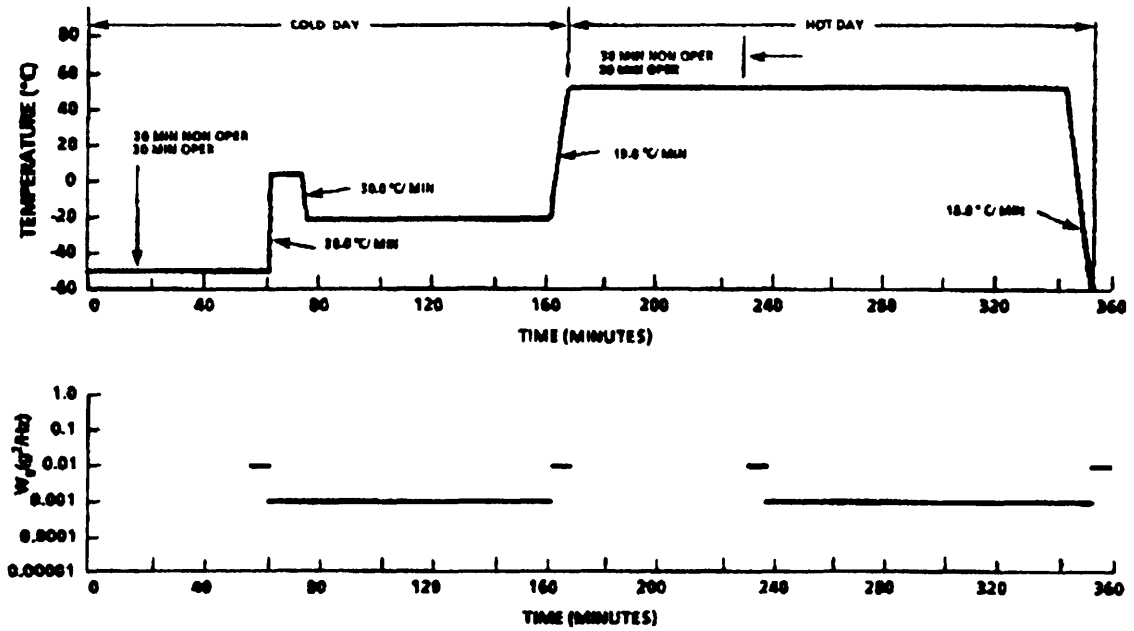

FIGURE 117. Type A V/STOL contact investigation environmental profile

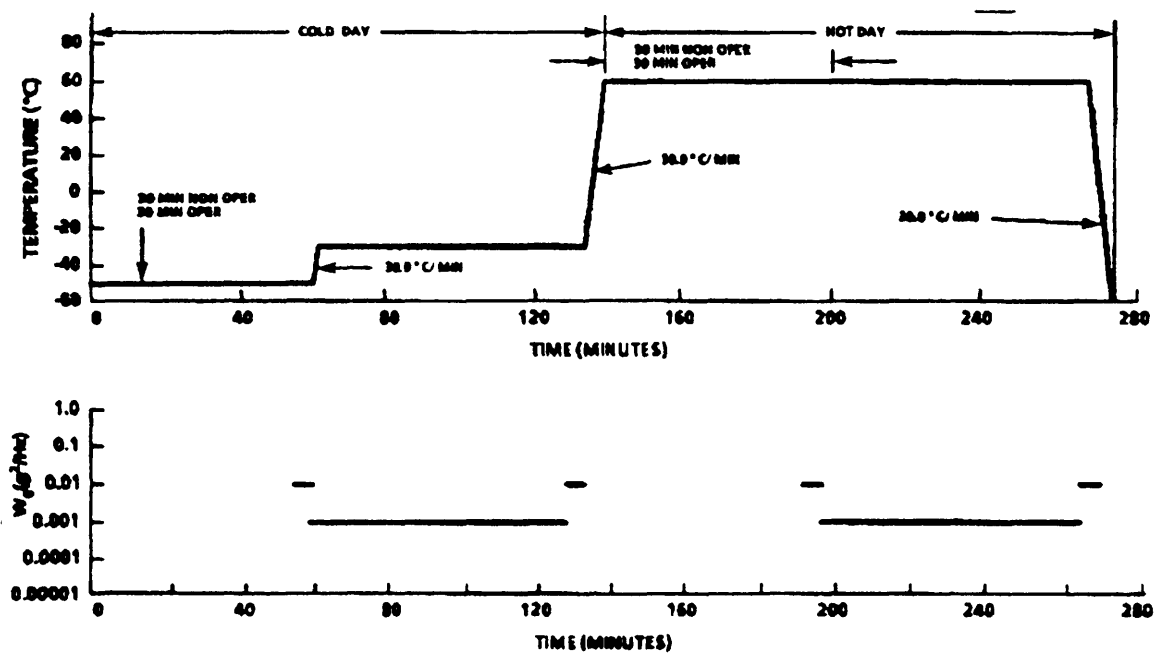

FIGURE 118. Type A V/STOL marine assault environmental profile

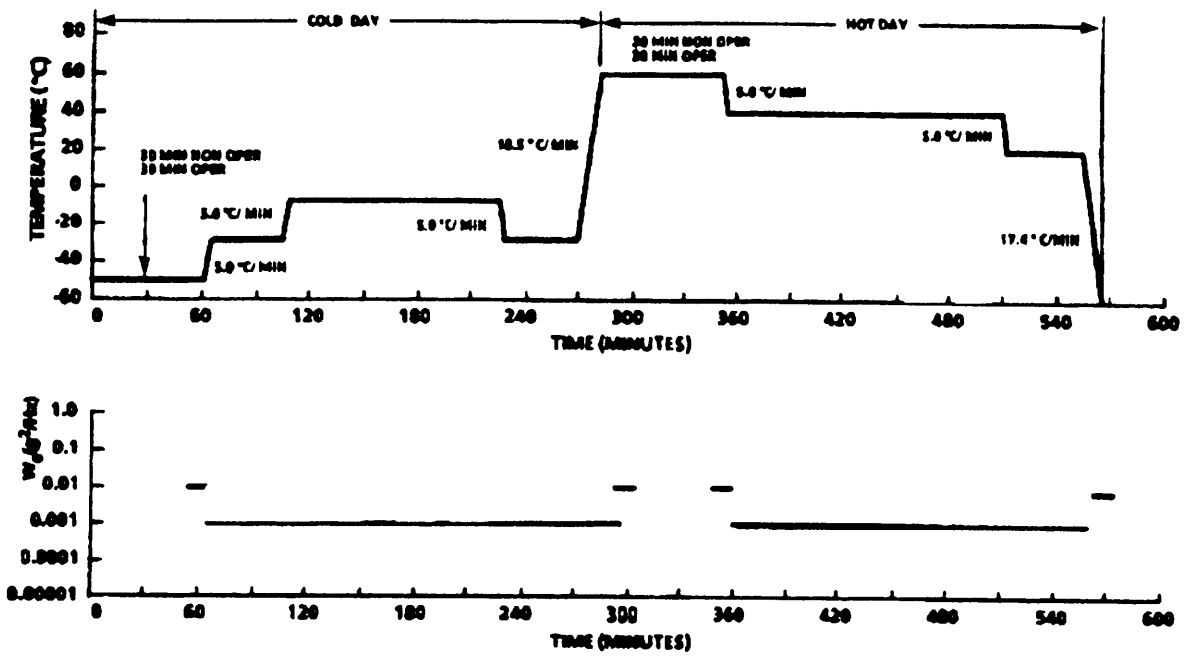

FIGURE 119. Type A V/STOL surface attack environmental profile

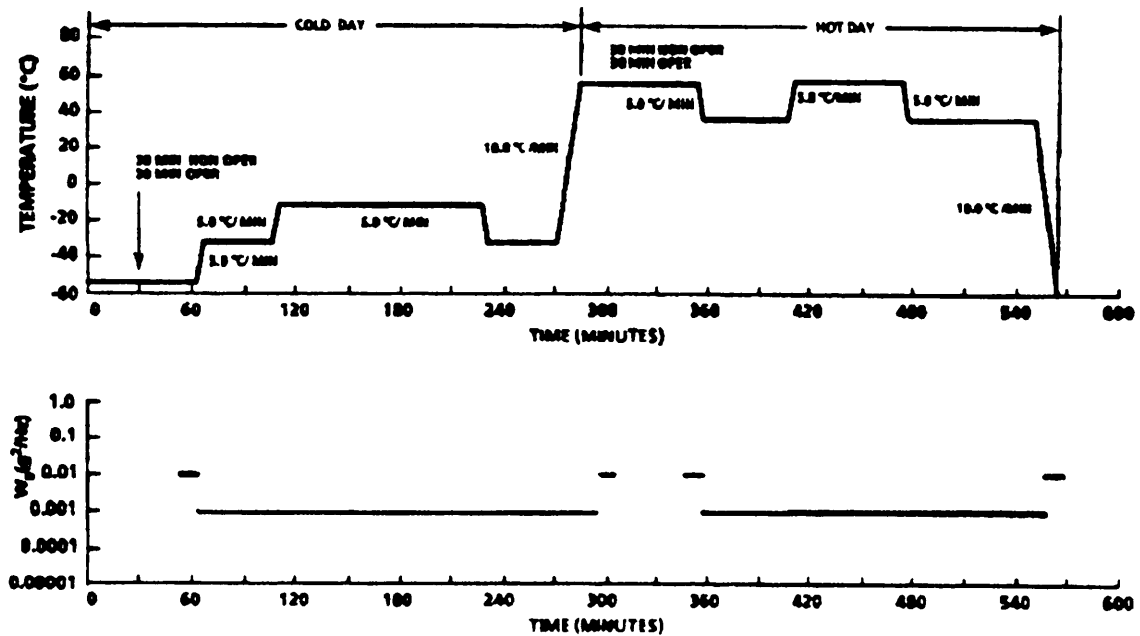

FIGURE 120. Type A V/STOL tanker environmental profile

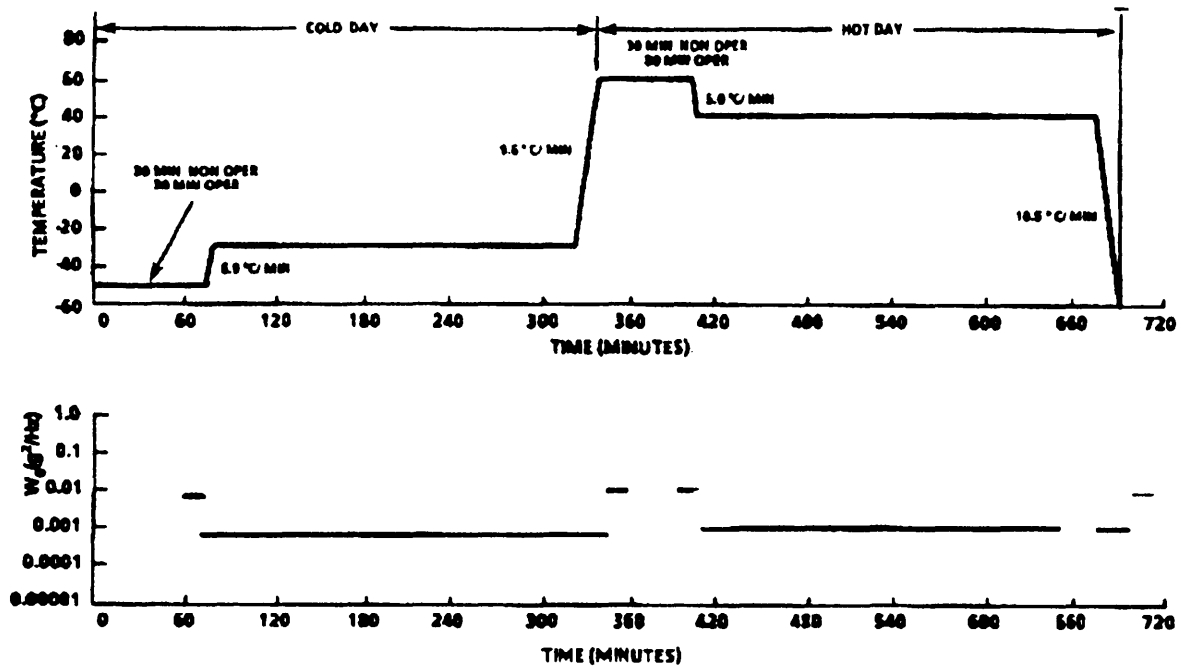

FIGURE 121. Type A V/STOL vertical onboard delivery environmental profile

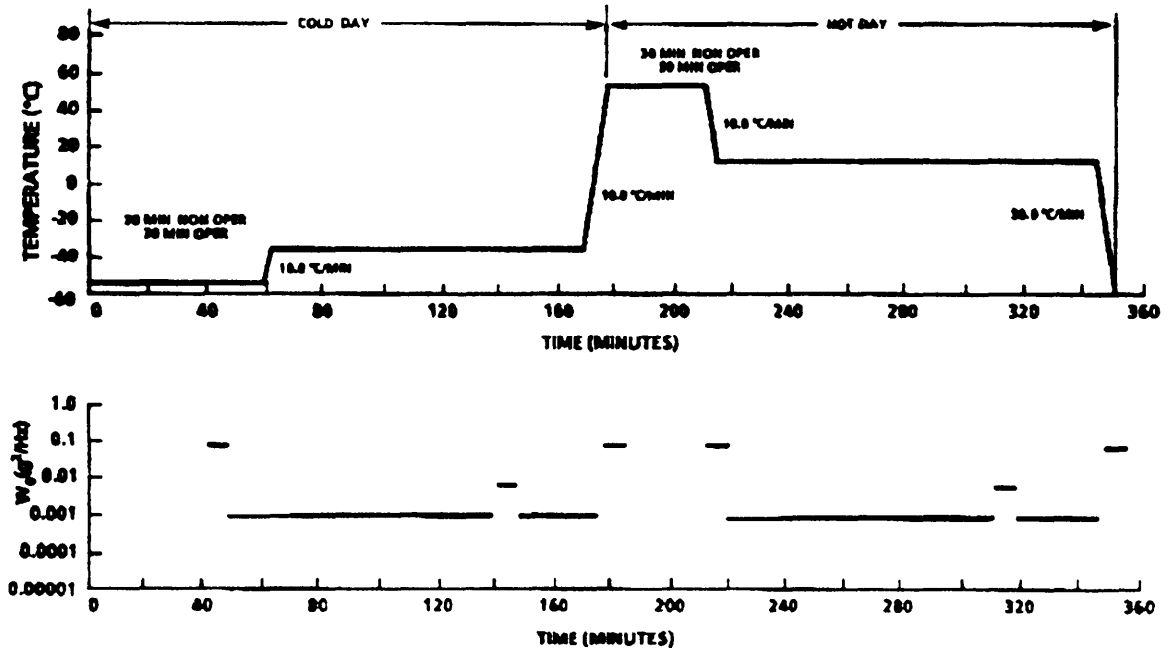

FIGURE 122. Type B V/STOL combat air patrol environmental profile

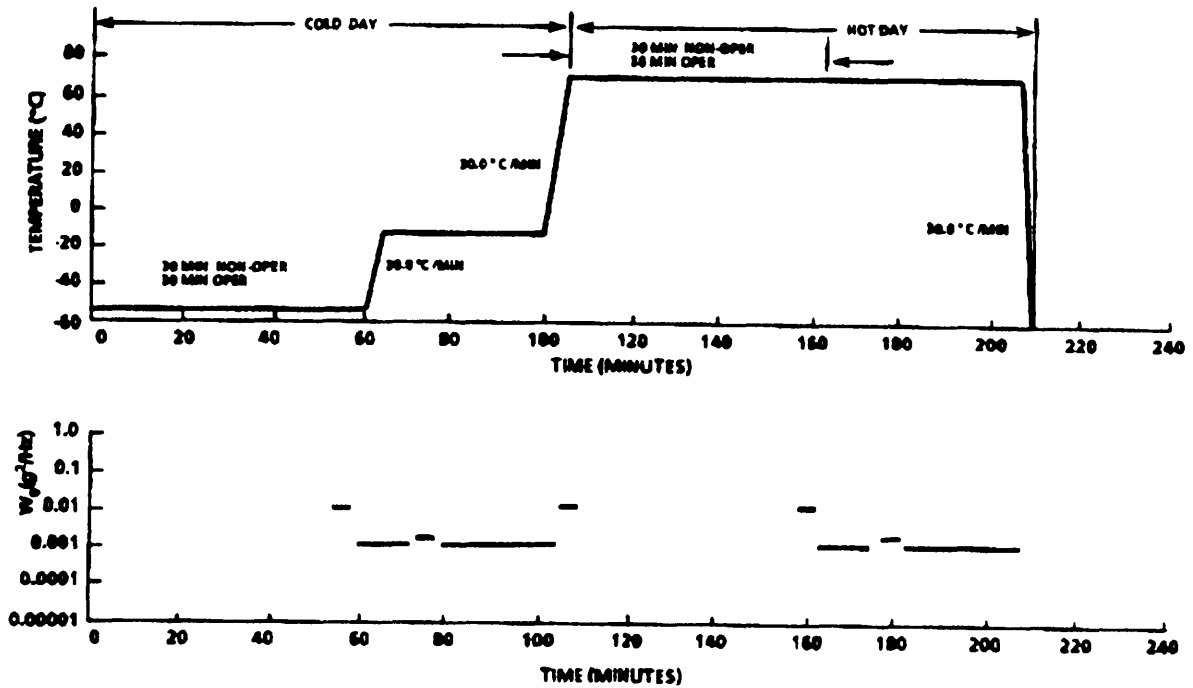

FIGURE 123. Type B V/STOL deck-launched intercept environmental profile

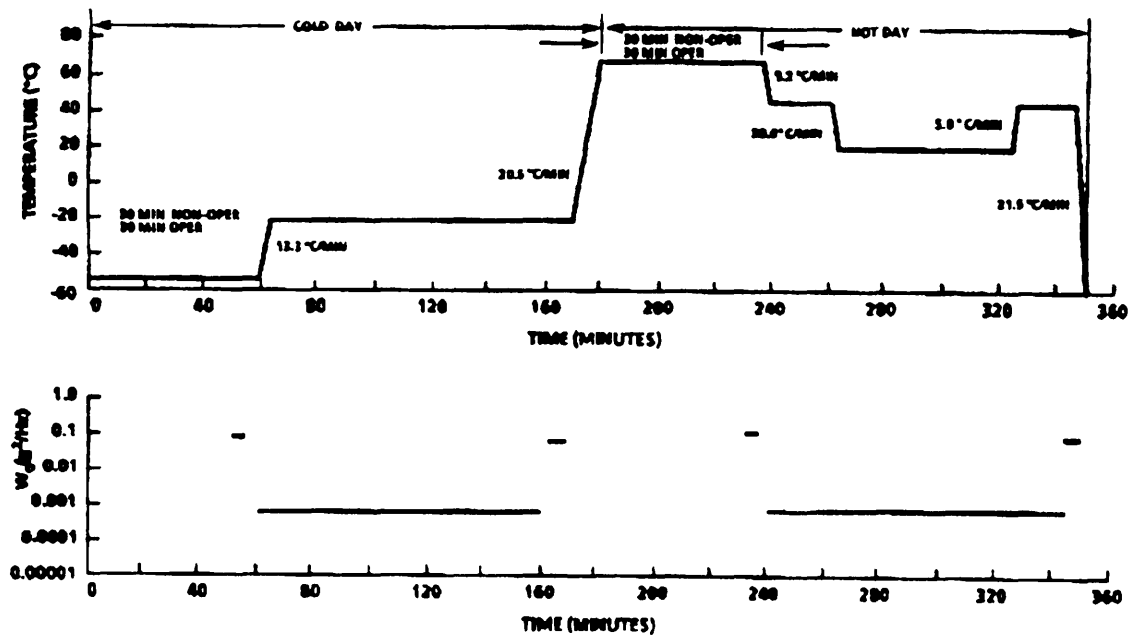

FIGURE 124. Type B V/STOL surface surveillance environmental profile



MIL-HDBK-781

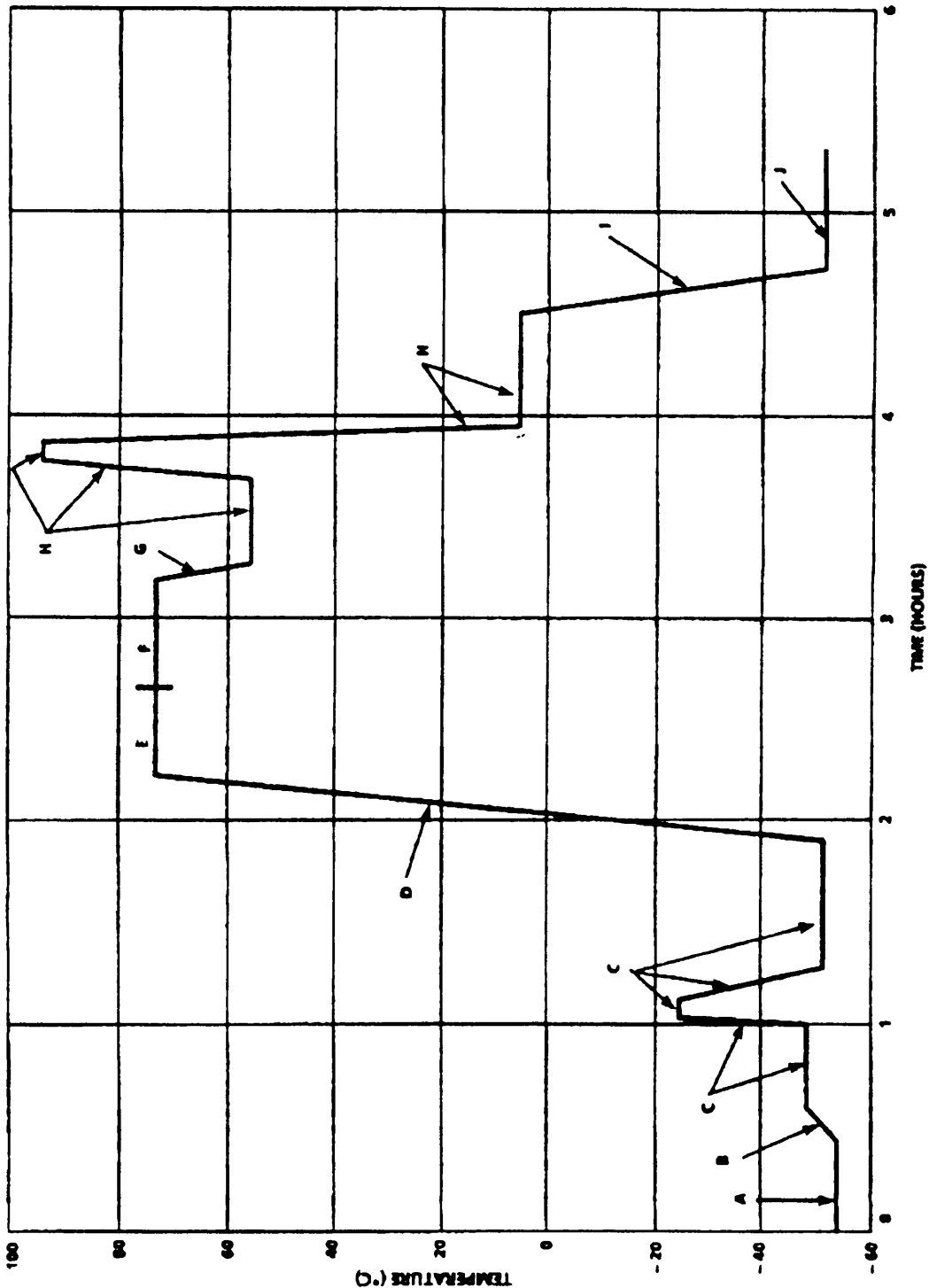
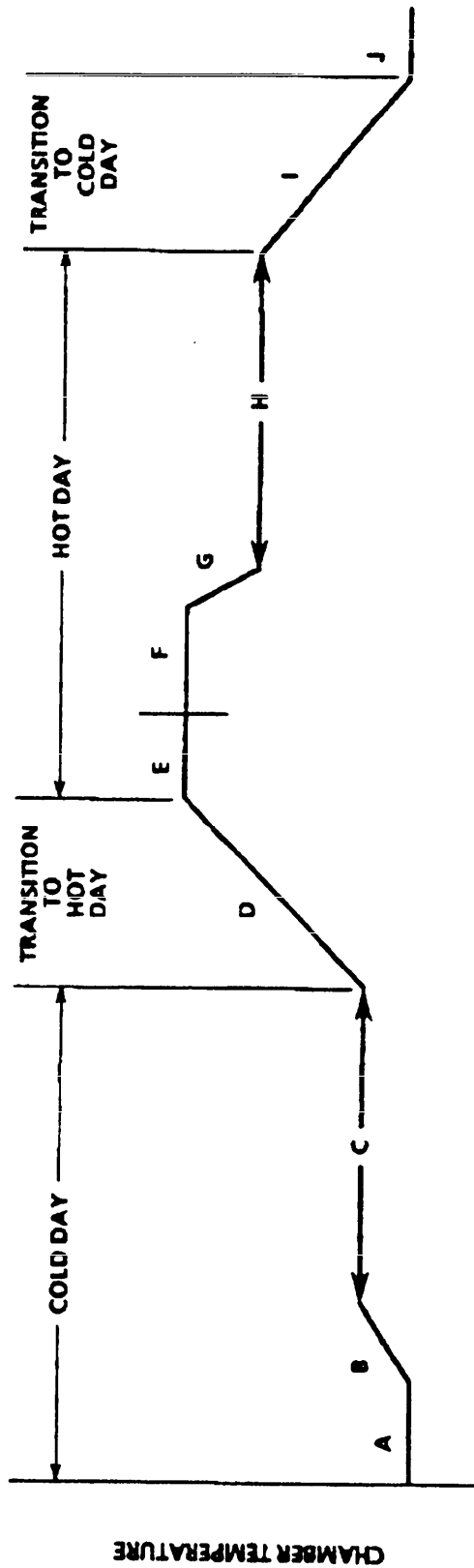

FIGURE 126. Thermal profile for turbopropeller aircraft

**MIL-HDBK-781**

Phase	Test Phase Definition	Duration	Operating/Non-Operating
A	Ground Operation-Cold Day	30 Minutes	Operating Operating Operating Operating
B	Takeoff/Climb to Altitude		
C	Mission Objective		
D	Idle Let Down and Landing	See NOTE	Non-Operating
E	Ground-Hot Day		
F	Ground Operation-Hot Day	30 Minutes	Operating Operating Operating Operating
G	Takeoff/Climb to Altitude		
H	Mission Objective		
I	Descent	See NOTE	Operating
J	Ground-Cold Day		



NOTE: See 5.6

FIGURE 127. Typical mission test cycle profile.

MIL-HDBK-781

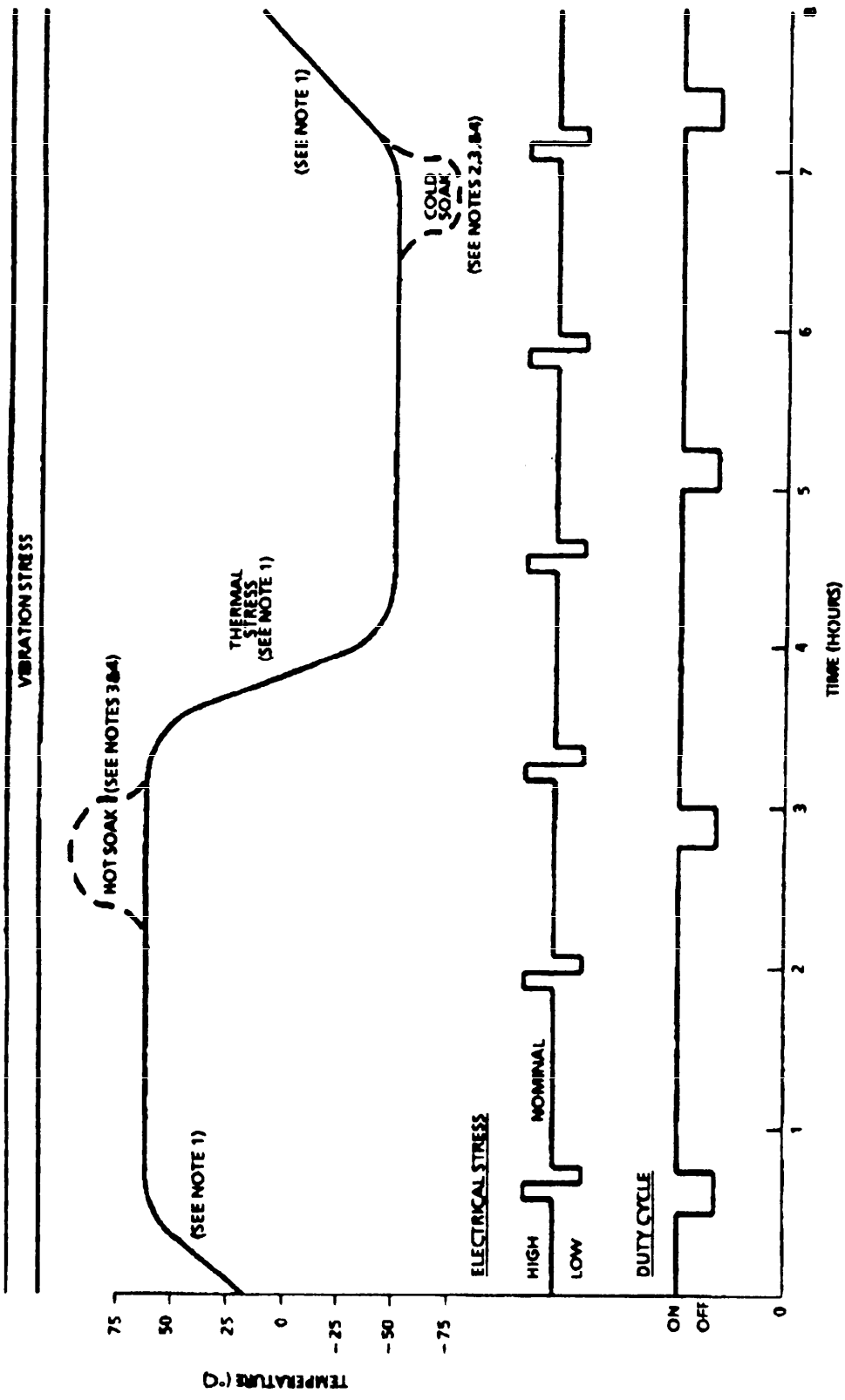

- NOTES:
1. RATE OF CHAMBER TEMPERATURE CHANGE SHALL BE 3°C PER MINUTE UNLESS OTHERWISE SPECIFIED OR APPROVED BY THE PROCURING ACTIVITY
  2. MOISTURE LEVEL TO BE SUFFICIENT TO CAUSE VISIBLE CONDENSATION, FROSTING AND FREEZING
  3. HOT SOAK AND COLD SOAK ARE OPTIONAL
  4. VIBRATION, ELECTRICAL STRESS, DUTY CYCLE OFF

FIGURE 128. Combined environmental test profile for rotary wing aircraft

MIL-HDBK-781

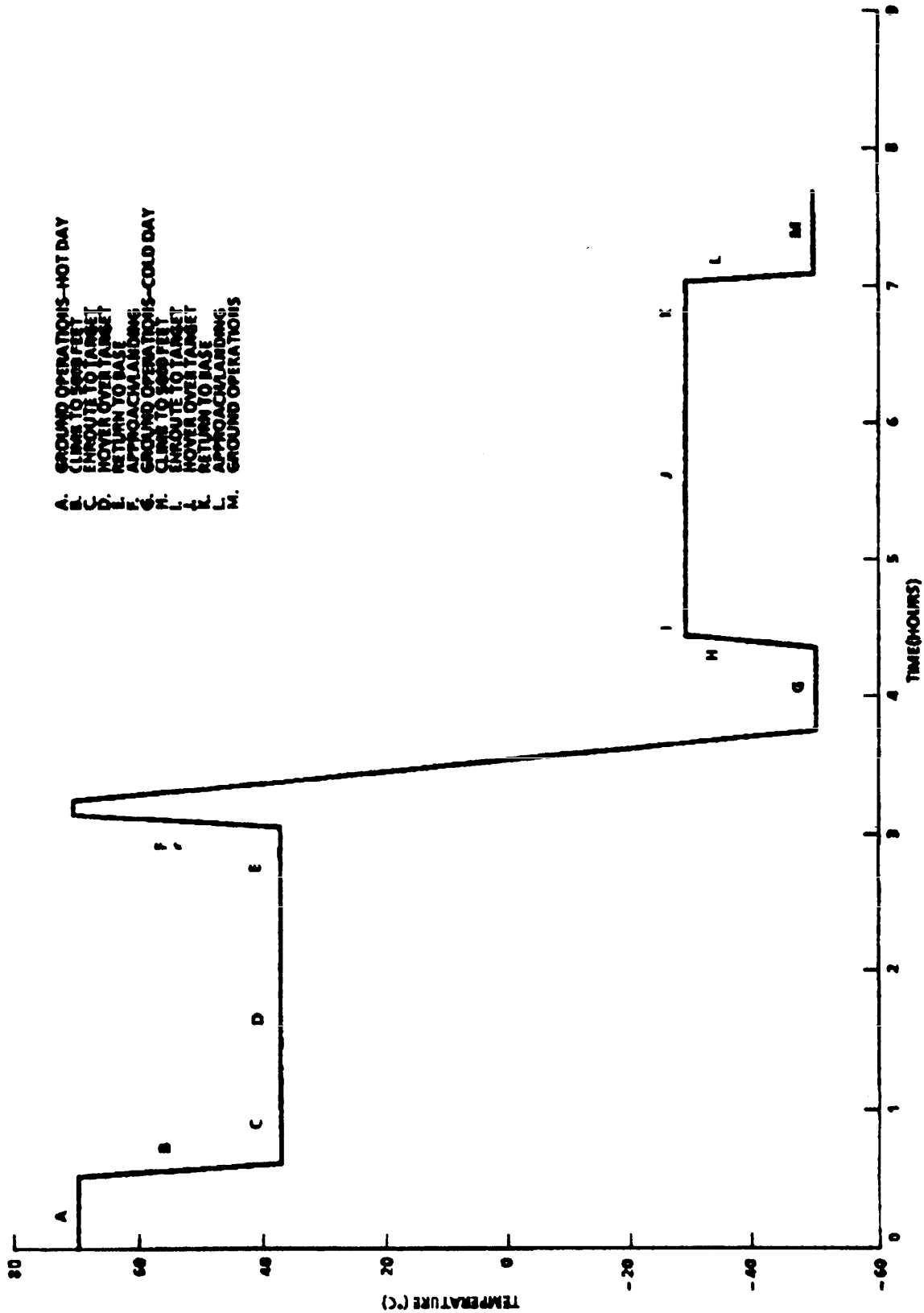

FIGURE 129. Combined mission profile for rotary wing aircraft (hot and cold day operation)

MIL-HDBK-781

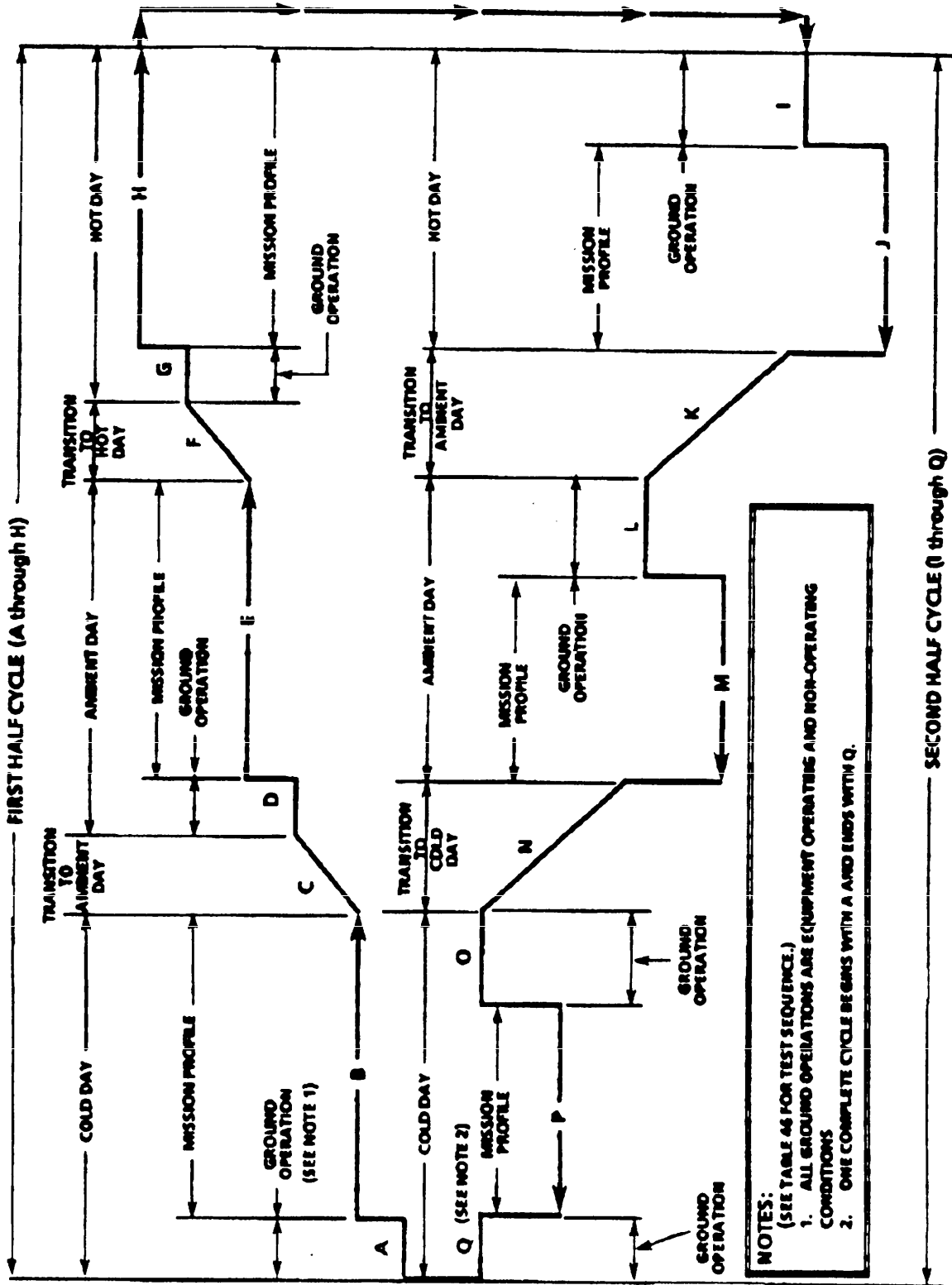

FIGURE 130. Typical reliability captive flight test sequence (one cycle)

MIL-HDBK-781

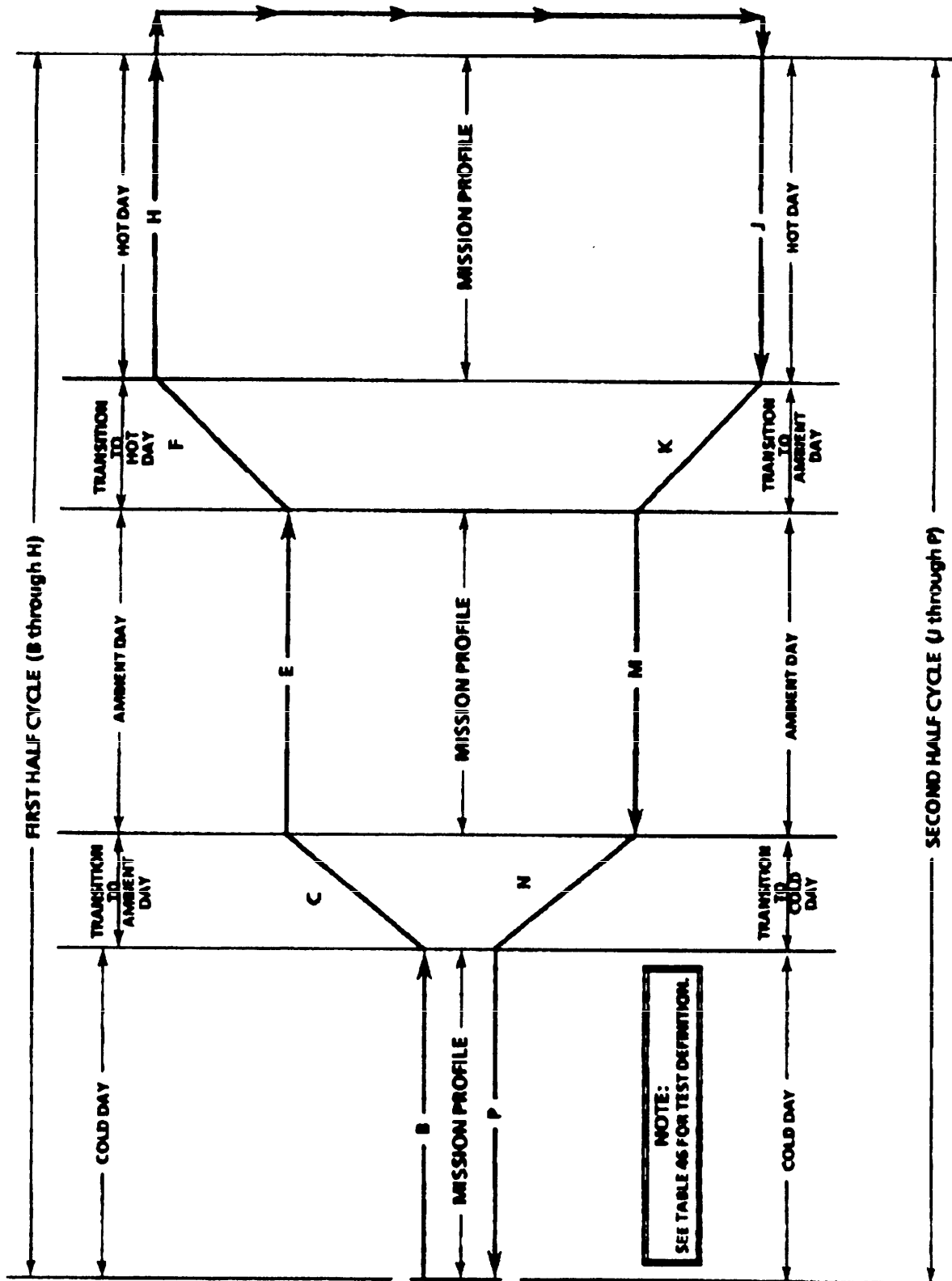
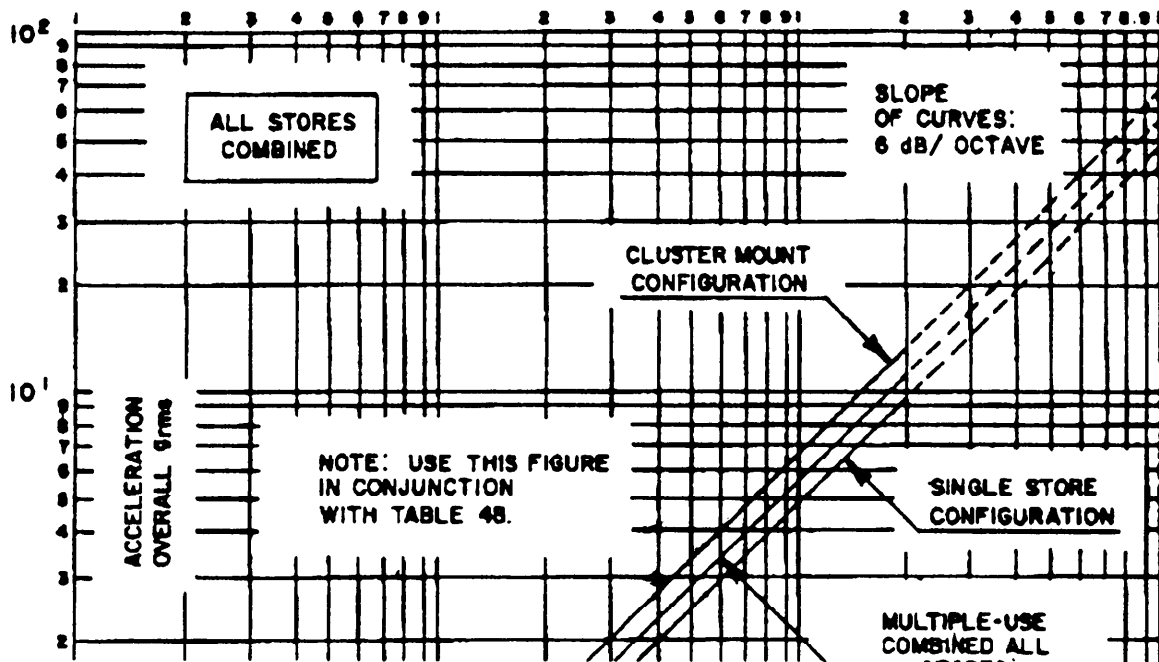
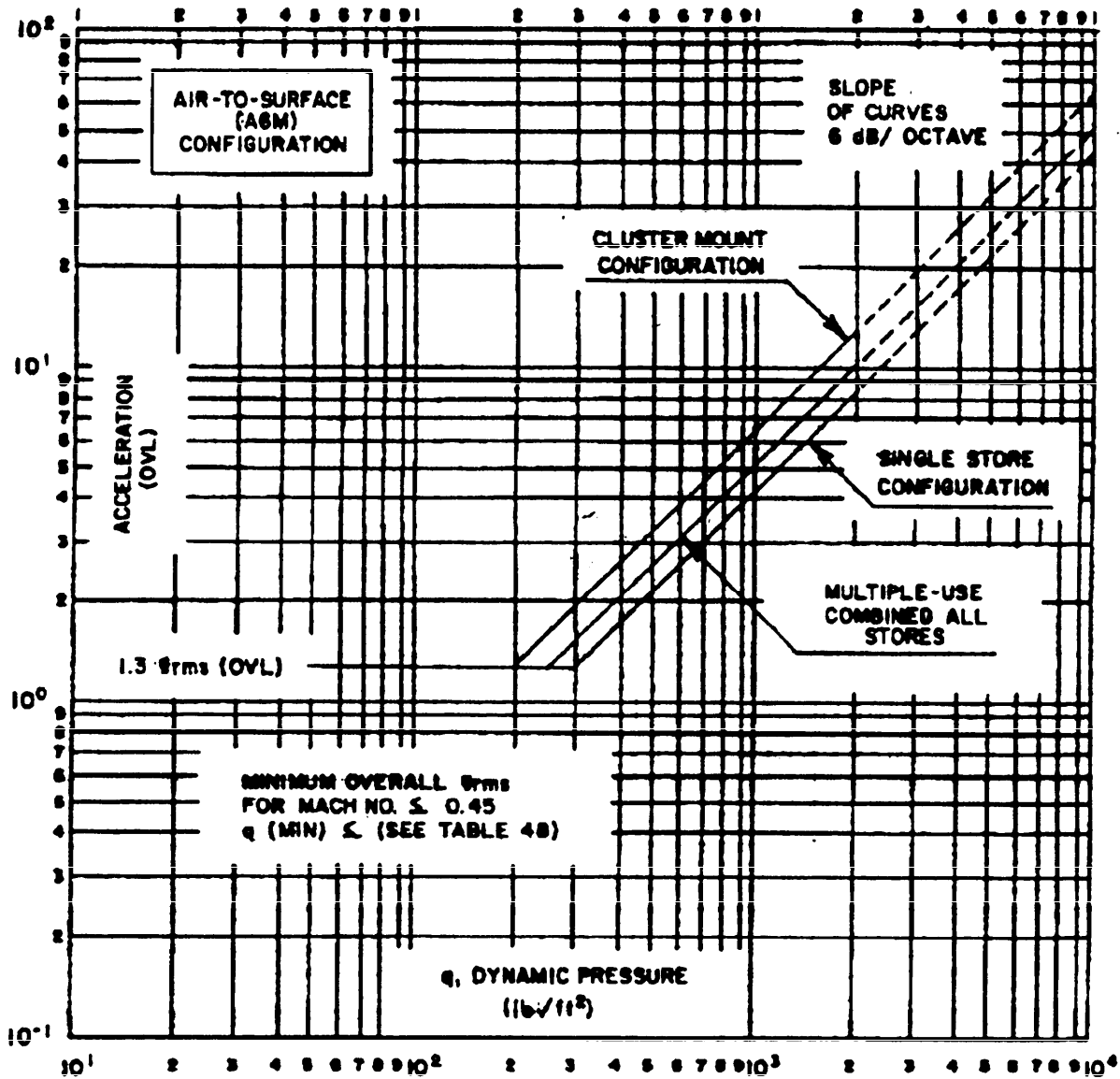

FIGURE 131. Typical reliability free-flight test sequence (one cycle)





**LINE EQUATIONS:**

$$\begin{aligned}
 \text{grms (OVL)} &= (10^{[\text{EXP}]}) (\text{FACTOR})_1 \quad (\text{FACTOR})_1 \text{-- SEE TABLE 48} \\
 [\text{EXP}] &= [\text{LOG}_{10}(q)_1 - (2.285332)] \quad q(\text{MIN}) \leq q \leq q(\text{MAX})
 \end{aligned}$$

NOTE: THIS FIGURE USED IN CONJUNCTION WITH TABLE 48.

FIGURE 133. Random vibration maximum predicted environmental for air-to surface (AGM) air-launched weapons

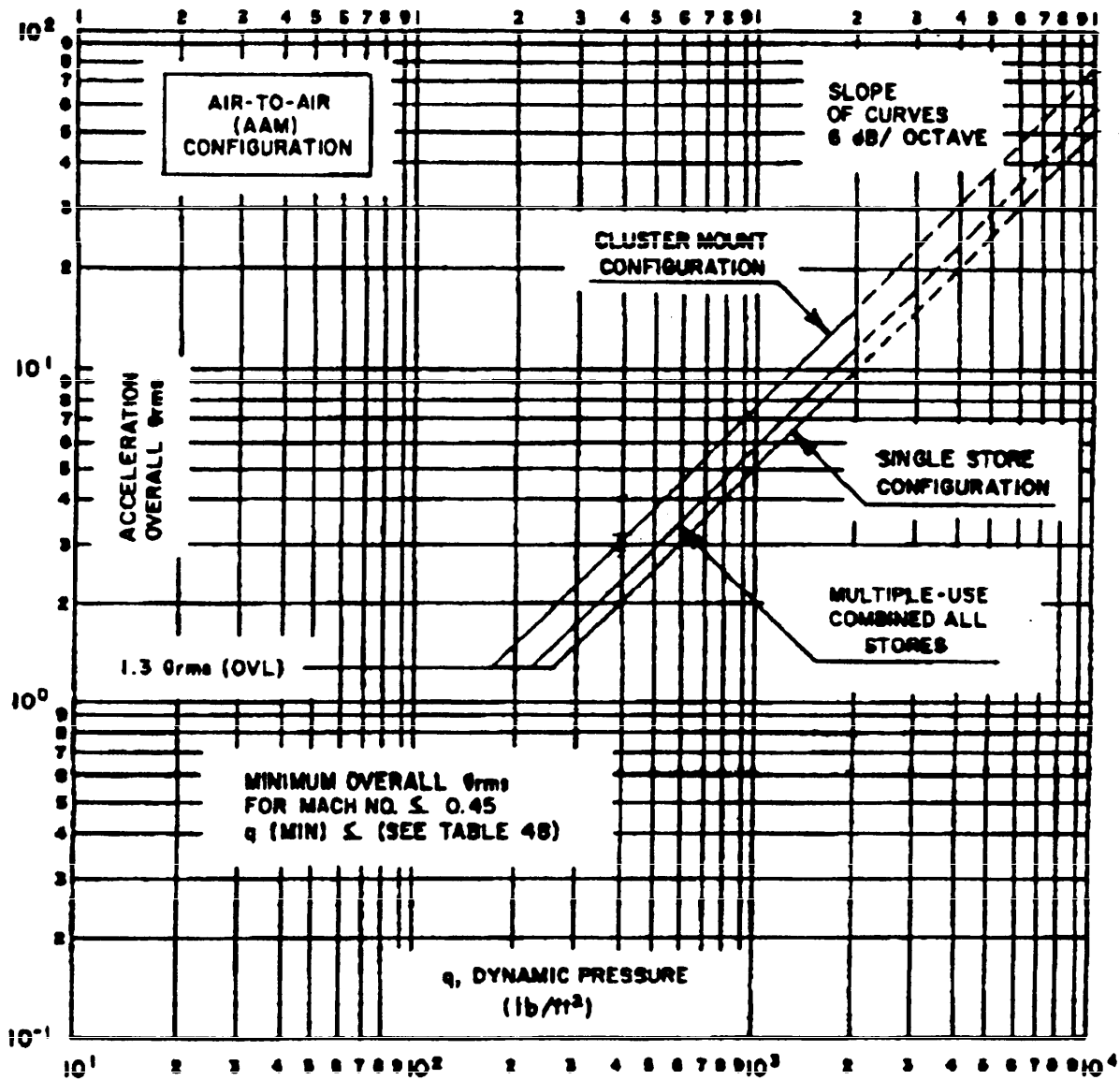

**LINE EQUATIONS:**

$$g_{rms} (OVL) = (10^{[EXP]}) (FACTOR)_i \quad (FACTOR)_i \text{ -- SEE TABLE 48}$$

$$[EXP] = [\log_{10}(q)_i - (2.285332)] \quad q (MIN) \leq q \leq q (MAX)$$

NOTE: THIS FIGURE USED IN CONJUNCTION WITH TABLE 48.

FIGURE 134. Random vibration maximum predicted environment for air-to-air (AAM) air-launched weapons

(a) WING AND FIN-TIP LOCATIONS ONLY ON AIRCRAFT

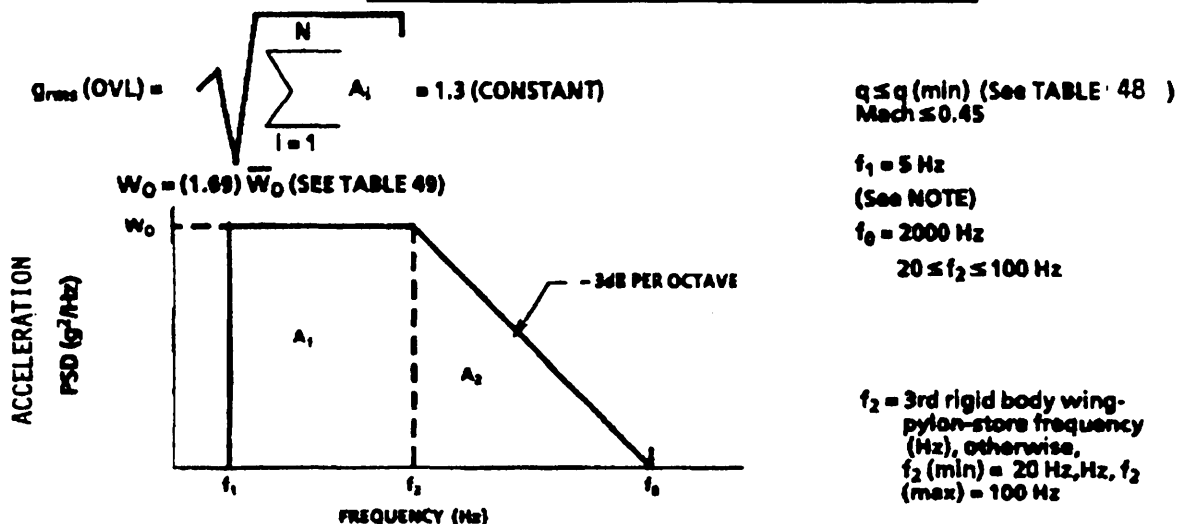

**NOTE:**  
 USE WITH EQUIPMENT REQUIREMENTS FROM FIGURE 136 AS WELL AS WITH FULLY ASSEMBLED EXTERNAL STORE.

(b) ALL PYLON LOCATIONS ON AIRCRAFT

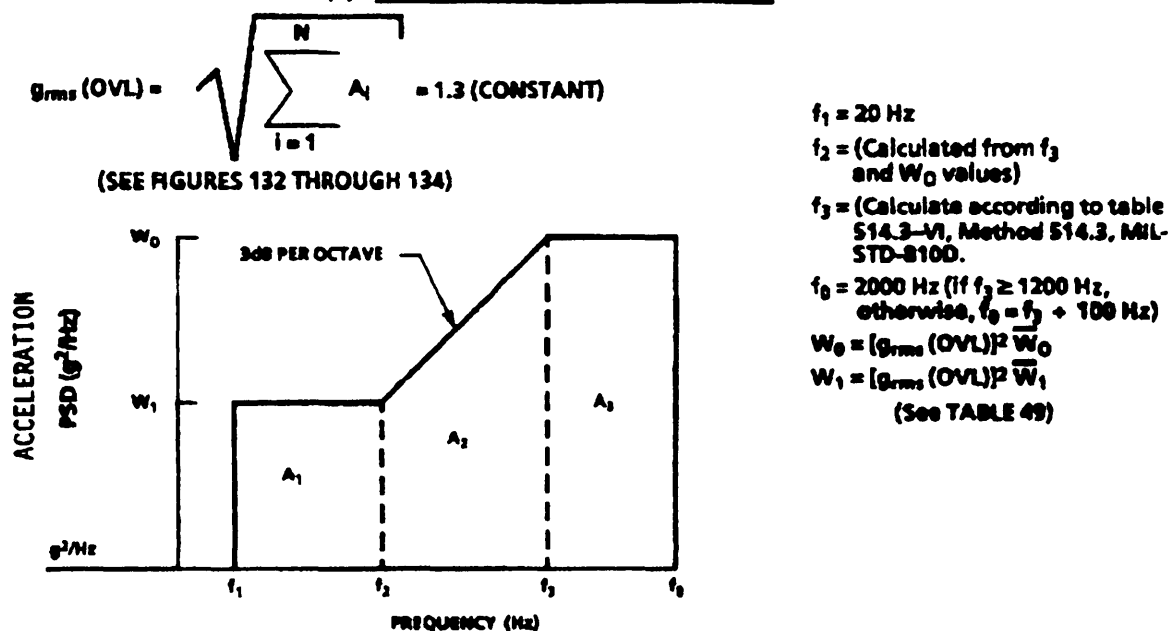

**NOTE:**  
 USE FOR ALL DYNAMIC PRESSURES (q) AT ALL LOCATIONS, EXCEPT AS LIMITED BY (a) ABOVE.  
 MINIMUM  $g_{rms} (OVL) = 1.3$  (SEE TABLE 48)

FIGURE 135. Assembled external stores and air-launched weapons-vibrational response acceleration PSD versus frequency spectra

$$g_{rms} (OVL) = \sqrt{\sum_{i=1}^N A_i}$$

(SEE FIGURES 132 THROUGH 134)

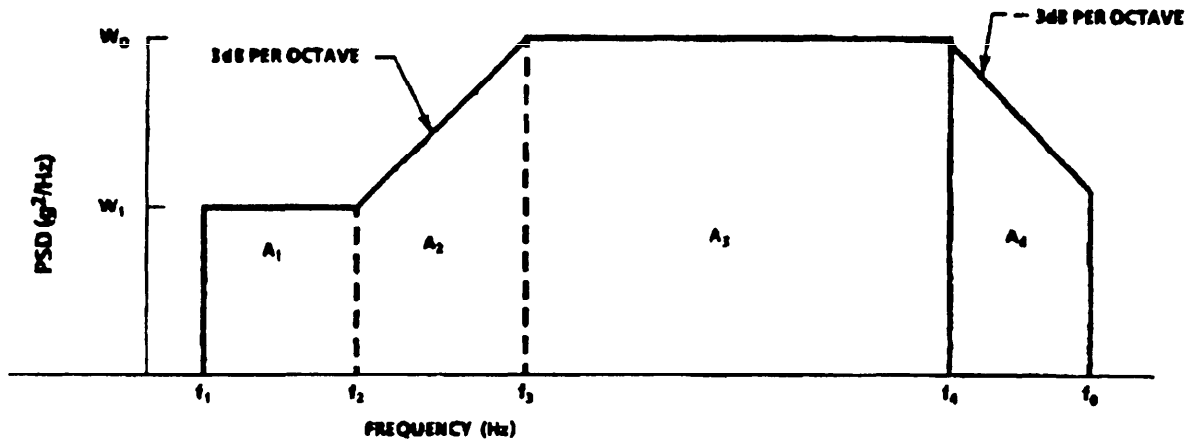

- $f_1 = 20 \text{ Hz}$
- $f_2 = (\text{Calculate from } f_3 \text{ and } W_0 \text{ values})$
- $f_3 = (\text{Calculate according to TABLE 514.3-VI. Method 514.3, MIL-STD-810})$
- $f_4 = f_3 + 1000 \text{ Hz } (\leq f_5)$
- $f_5 = 2000 \text{ Hz}$
- $W_0 = [g_{rms} (OVL)]^2 \bar{W}_0$
- $W_1 = [g_{rms} (OVL)]^2 \bar{W}_1$
- (SEE TABLE 49)

**NOTE:**  
 Use in conjunction with the limits shown in FIGURE 135 (a). For  $q \leq q (\text{min})$  (see TABLE 48) and Mach  $\leq 0.45$ , minimum  $g_{rms} (OVL) = 1.3$

FIGURE 136. Equipment installed in assembled external stores and air-launched weapons-vibrational response acceleration PSD versus frequency spectra

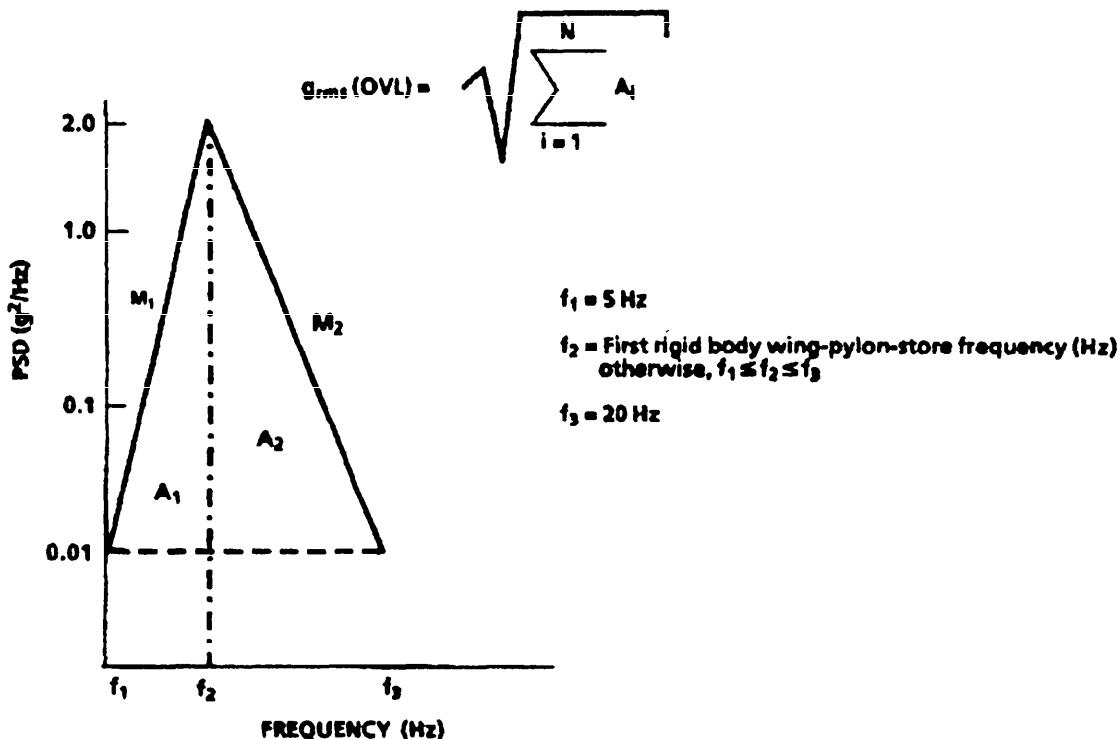

Test duration = 6(X) seconds (minimum total time for each mission profile = 18 seconds where:

- X = Number of buffet maneuvers (minimum of 3, phased during mission profile). Maneuver conditions inducing buffet include (but are not limited to): high-g dive attack, tight turns, RPO, and high and low speed stalls.
- 6 = Average induced buffet duration, in seconds.

**NOTES:**

1. This spectrum will be superimposed on the applicable acceleration PSD spectra of FIGURES 135 and 136, according to the mission profile definition of flight phasing.
2. Weight reduction factor not applicable for this spectrum.
3. See TABLE 49 for Equations to solve for  $M_1$ ,  $M_2$ ,  $A_1$  and  $A_2$ .

FIGURE 137. Induced buffet maneuver random vibration response spectrum

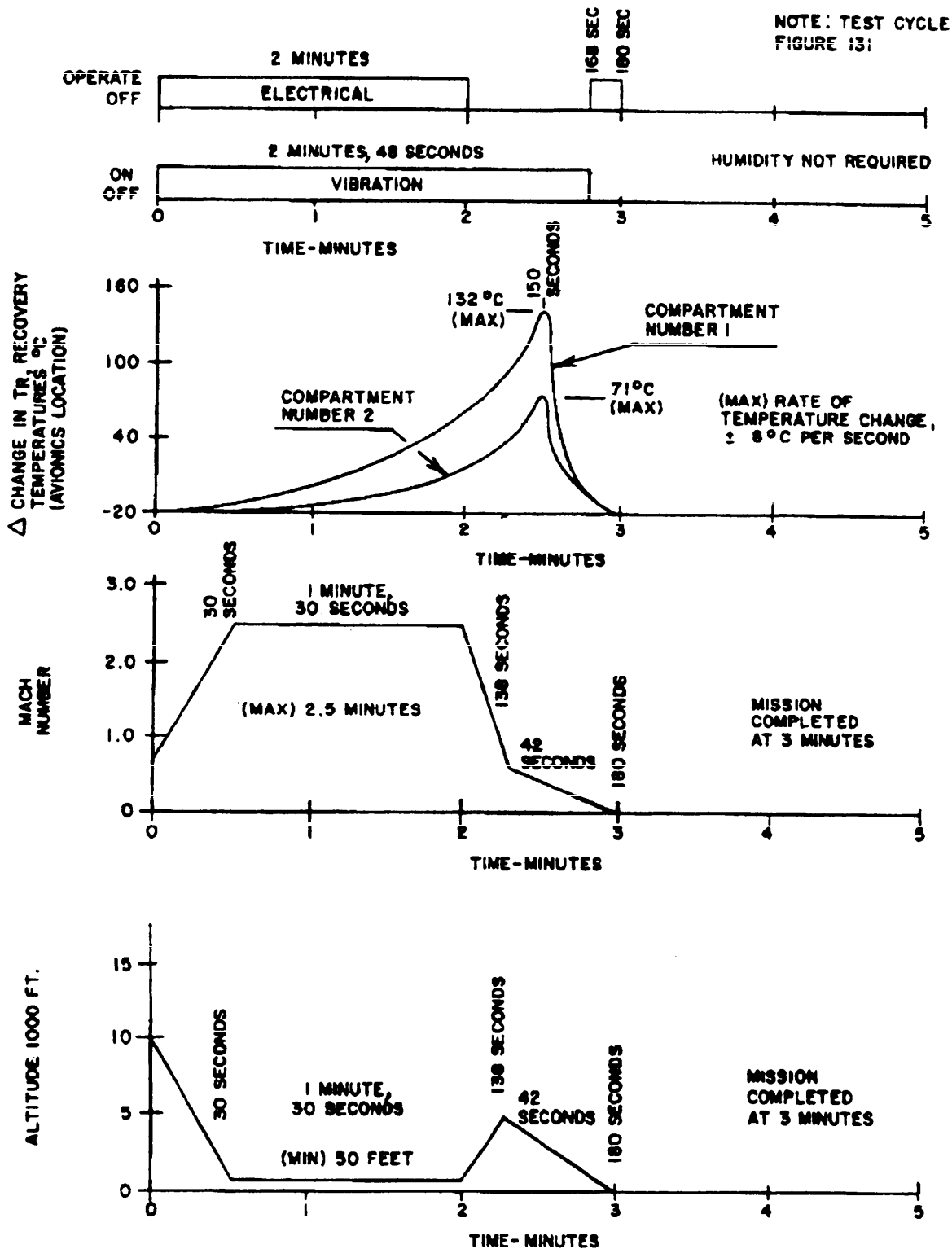

FIGURE 138. Low-low free-flight mission profile (example)

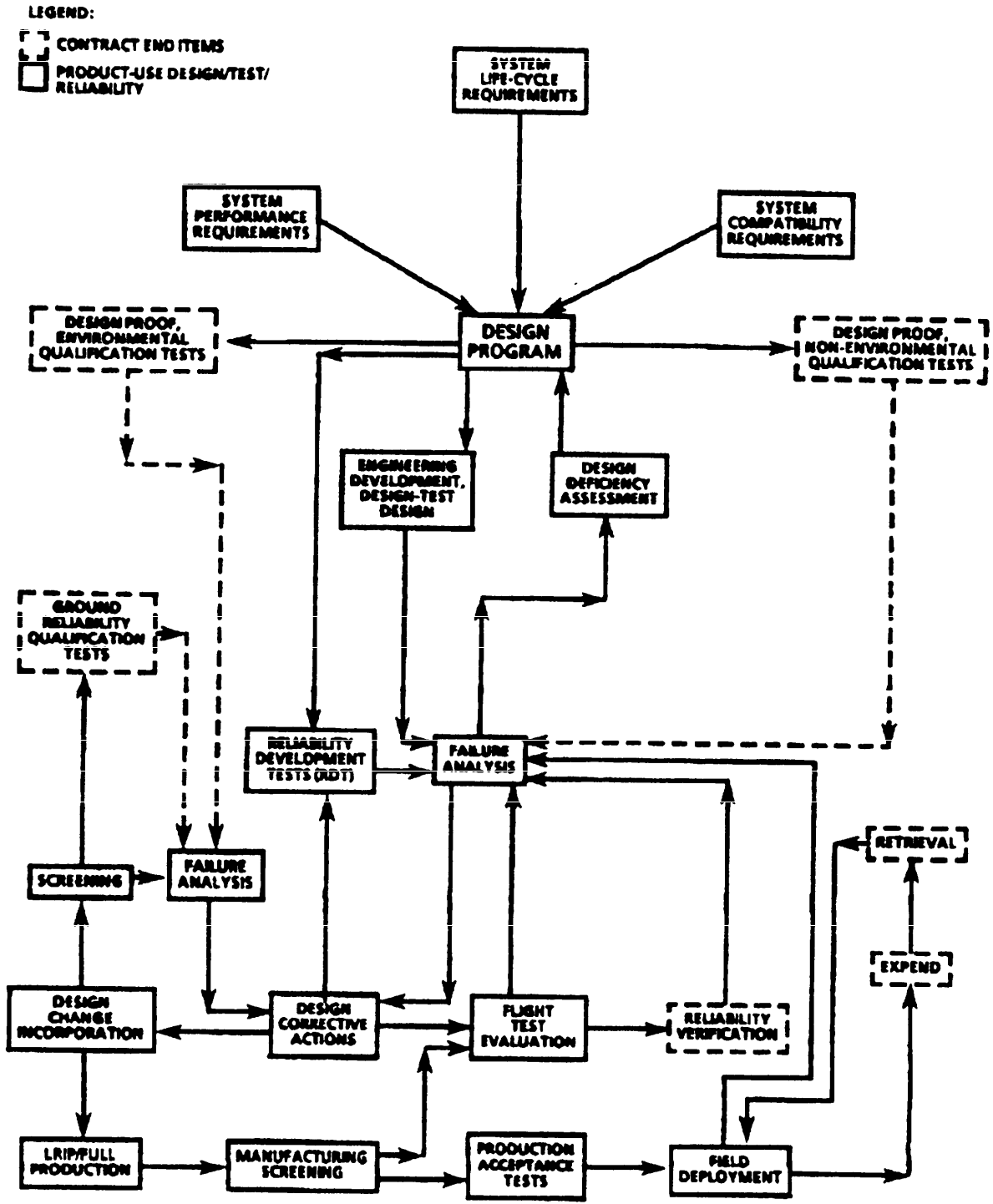

FIGURE 139. Environmental engineering program schematic

MIL-HDBK-781

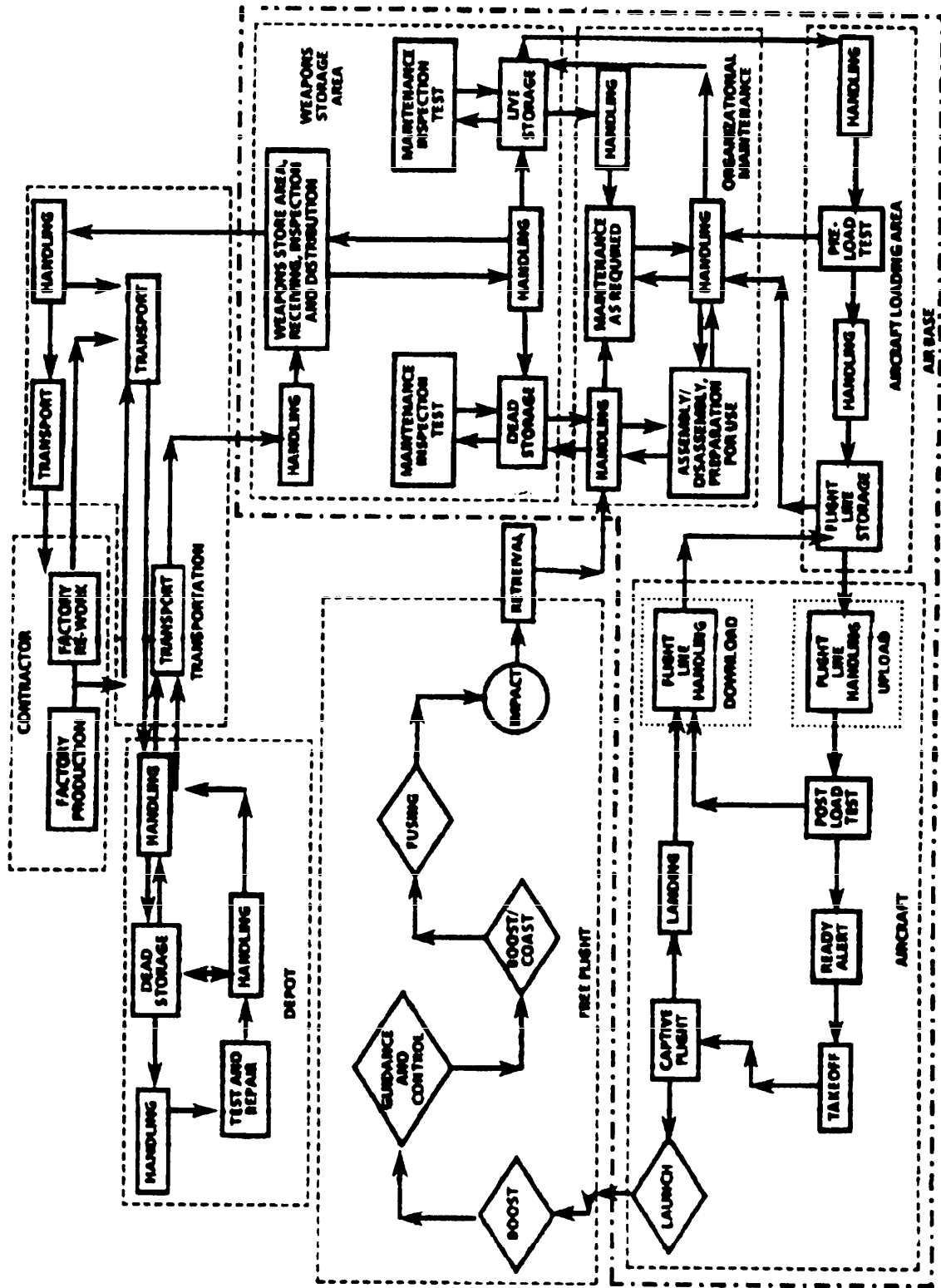

FIGURE 140. Logistics functional schematic diagram

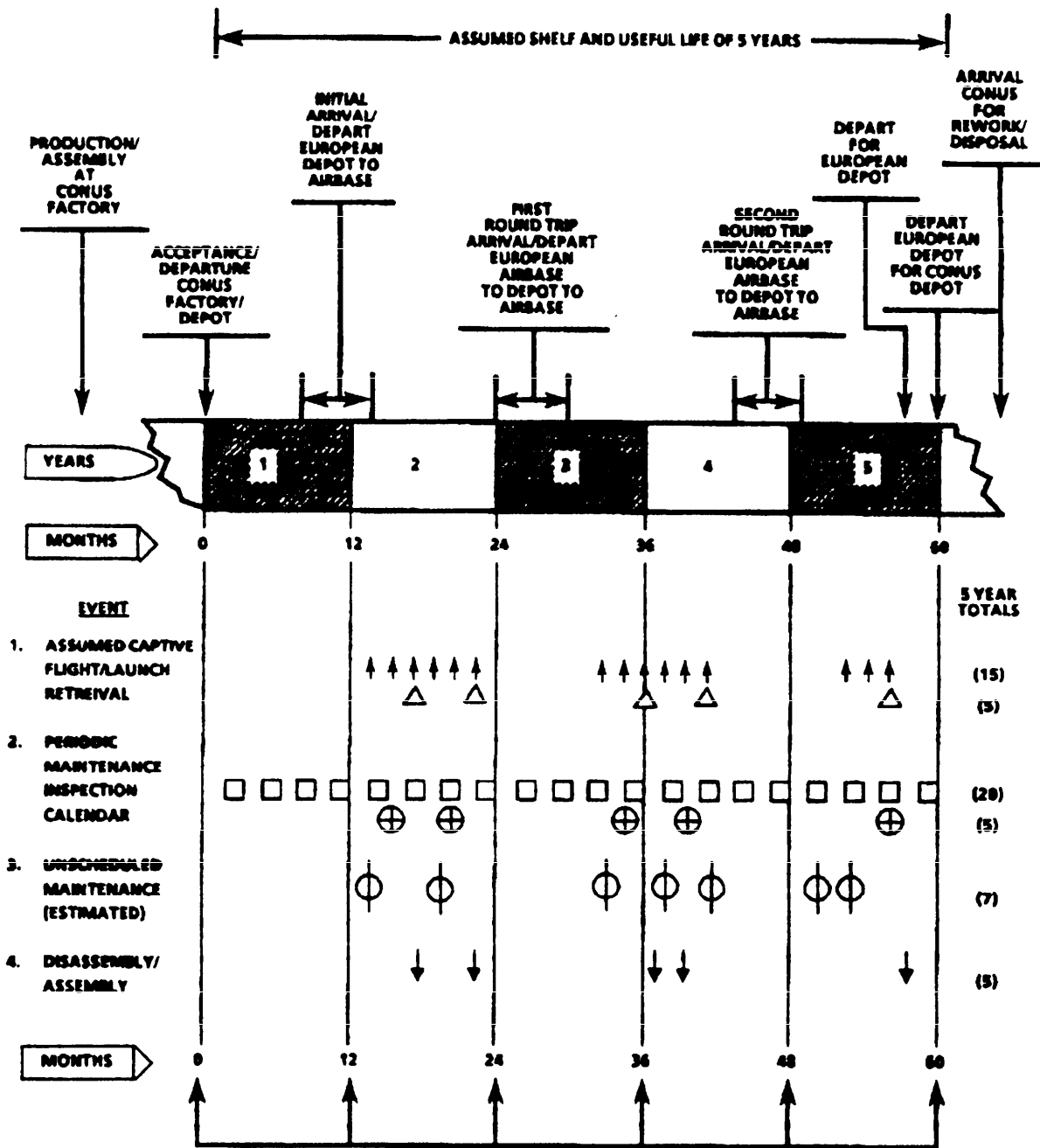

FIGURE 141. European scenario assumed maintenance schedule and possible operational utilization rate for environmental analyses (example)

MIL-HDBK-781

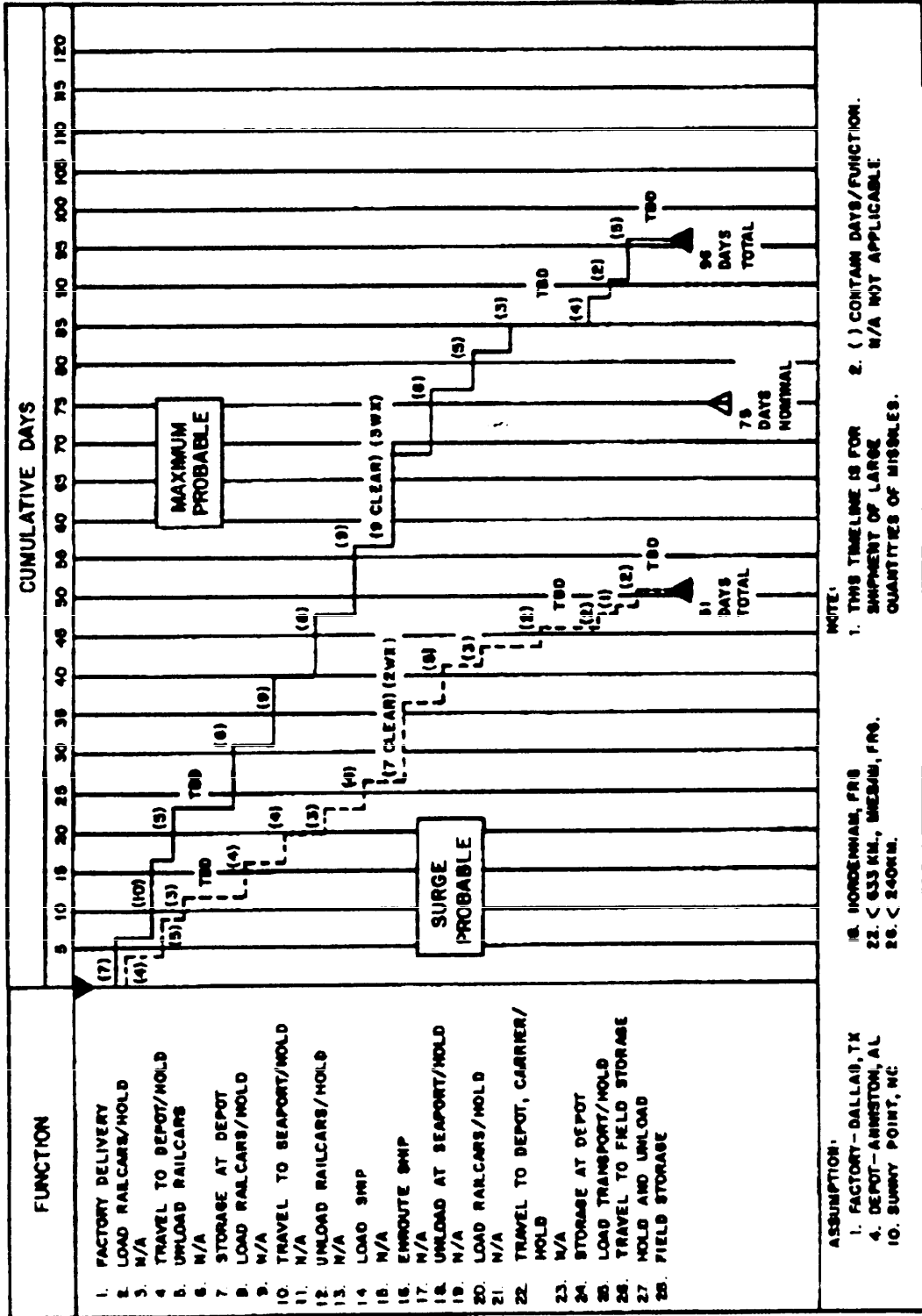

FIGURE 142. Target movement timeline for environmental design criteria (European scenario) large quantities (example)

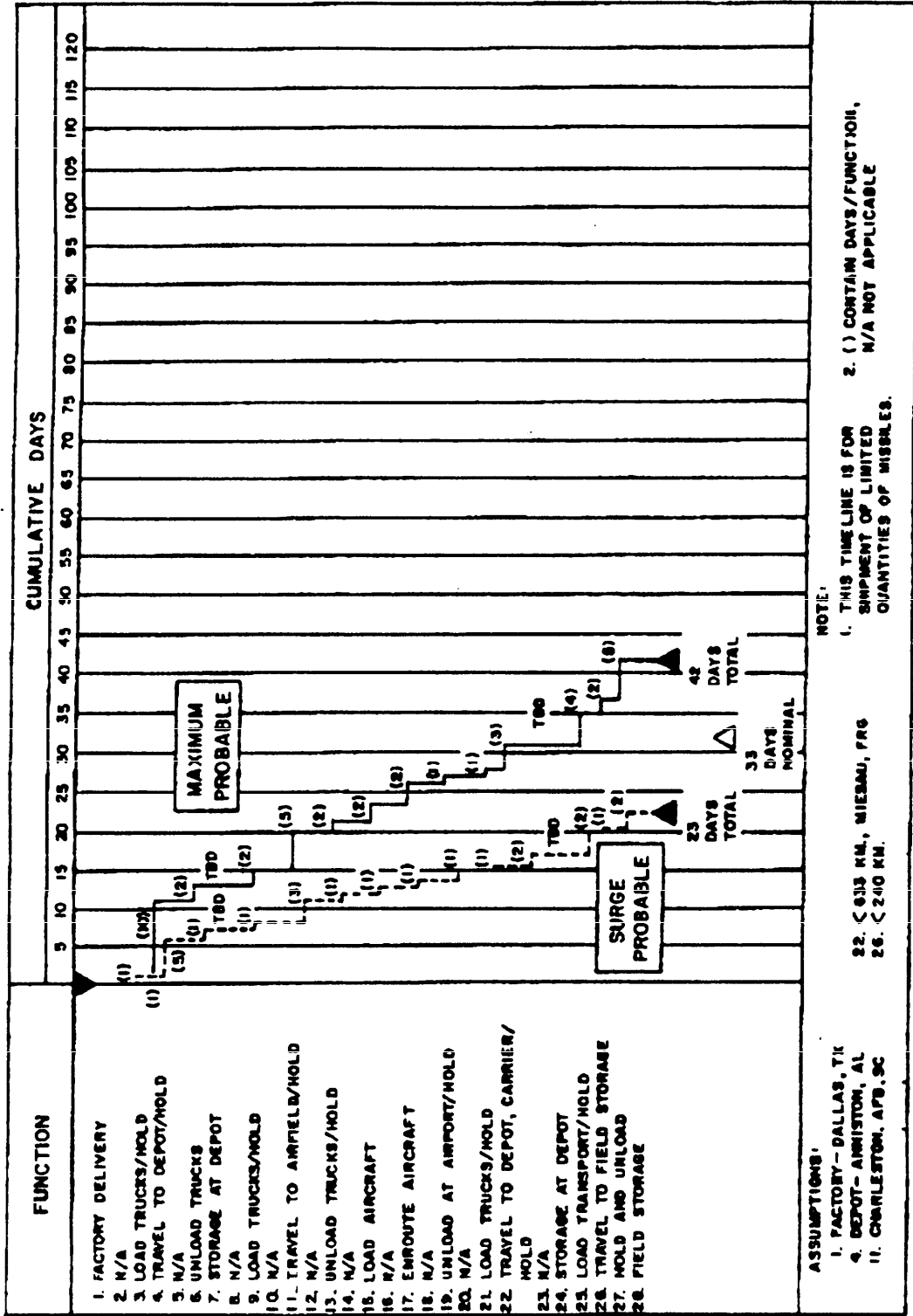
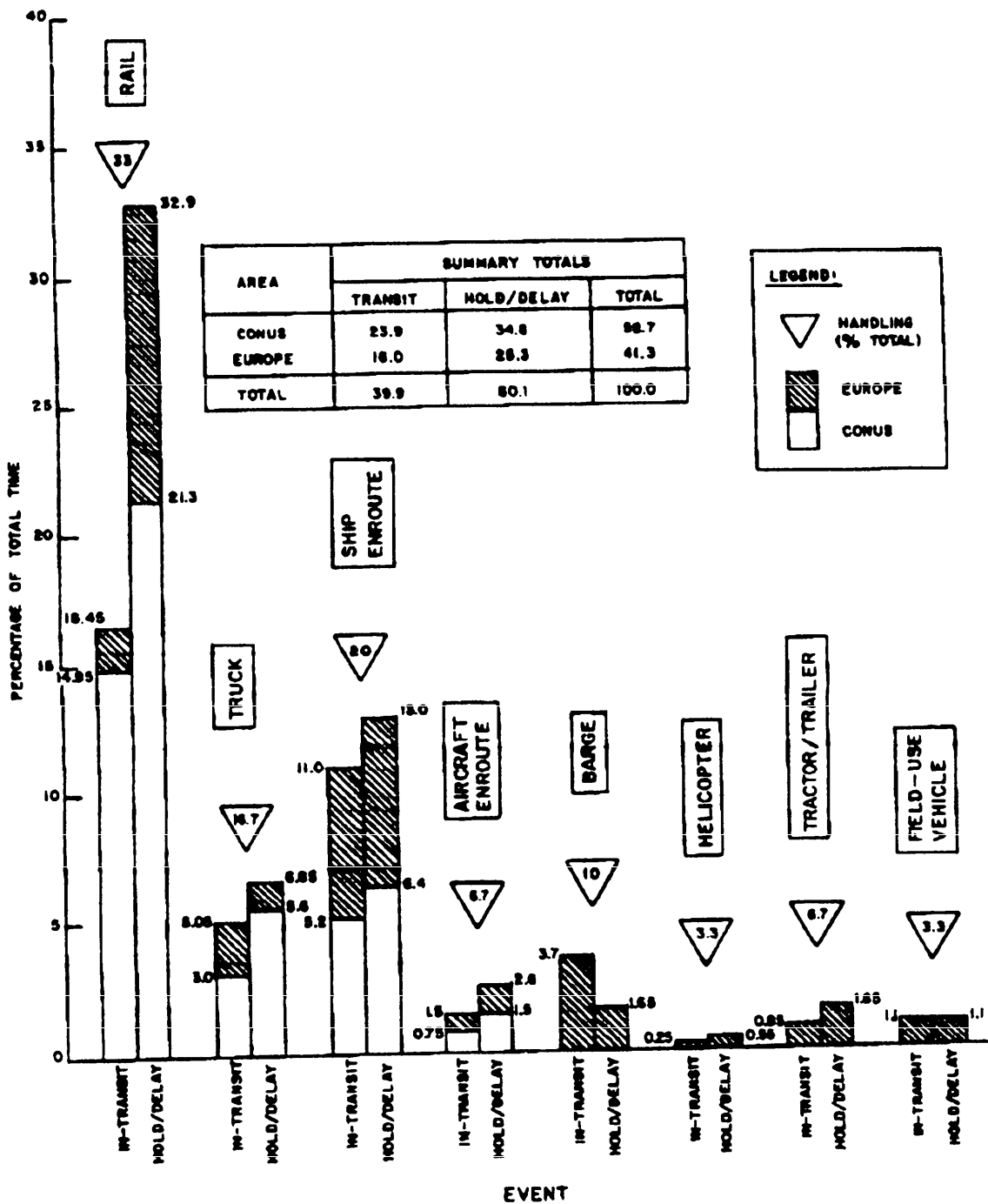

FIGURE 142. Target movement timeline for environmental design criteria (European scenario) large quantities (example)  
 (Continued)



NOTE:  
 FACTORY LOCATION ASSUMED TO BE IN CENTRAL CONUS FOR A EUROPEAN SCENARIO (DEPOT AND THEATER STORAGE NOT INCLUDED).

FIGURE 143. Estimated percentage of time distribution for transportation, hold/delay, and handling, for nominal-probable factor-to-theater movement timeline



MIL-HDBK-781

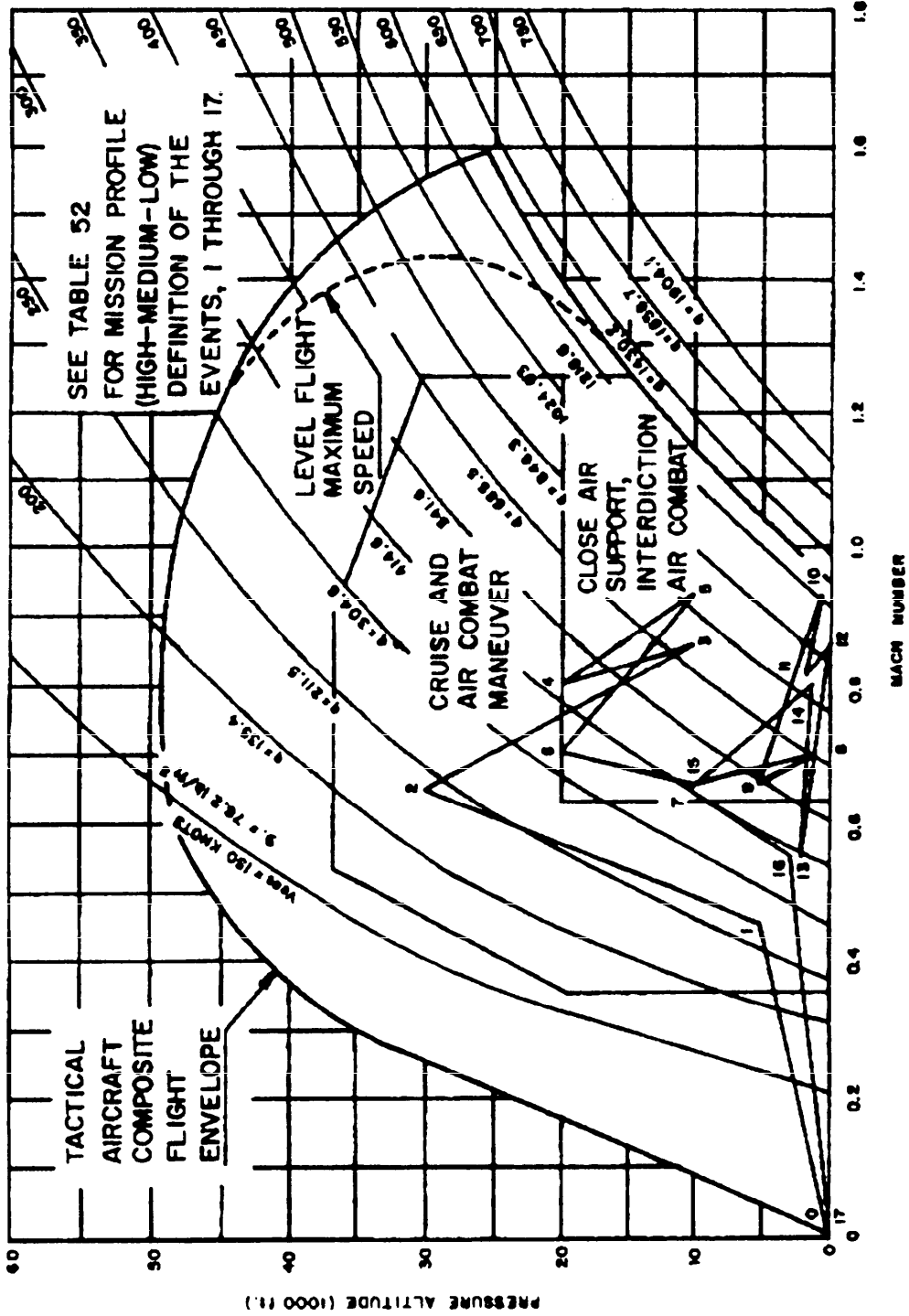

FIGURE 144. Assumed typical attack aircraft operating envelope (standard day) showing the assumed high-medium-low mission profile (Continued)

MIL-HDBK-781

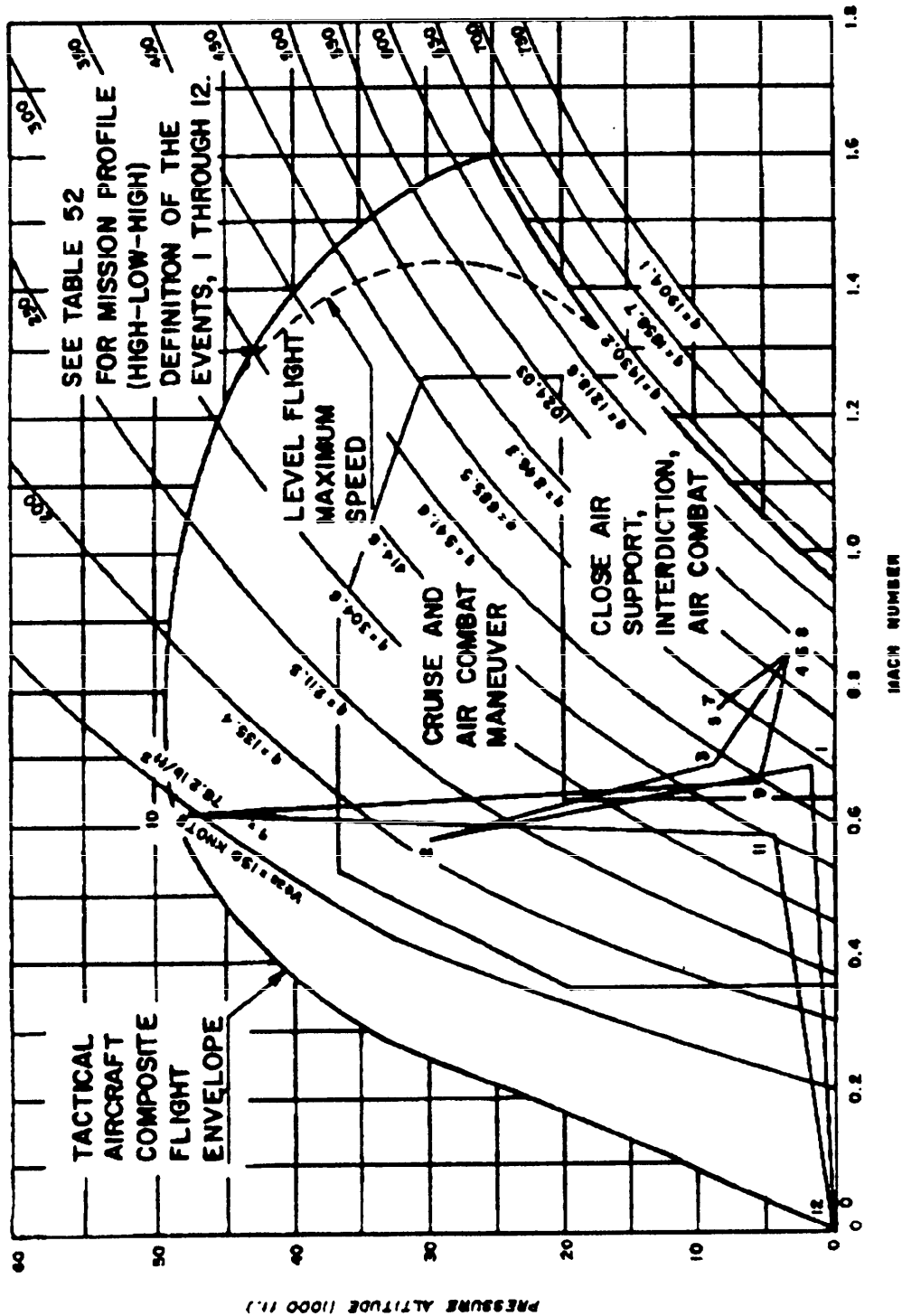

FIGURE 145. Assumed typical attack aircraft operating envelope (standard day) showing the assumed high-low-low mission profile

(HIGH-LOW-HIGH)  
 STANDARD DAY

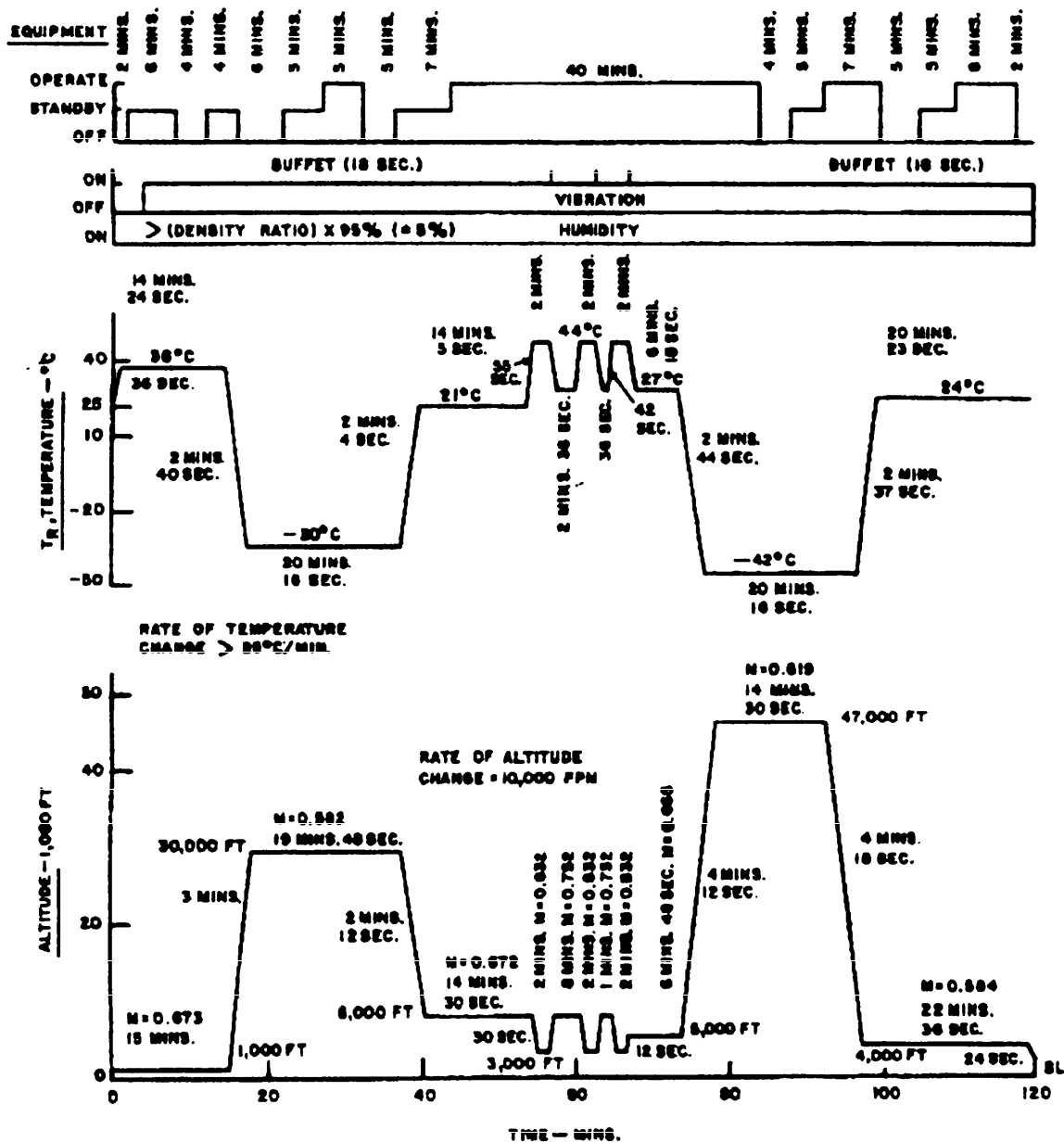

FIGURE 145. Assumed typical attack aircraft operating envelope (standard day) showing the assumed high-low-low mission profile

MIL-HDBK-781

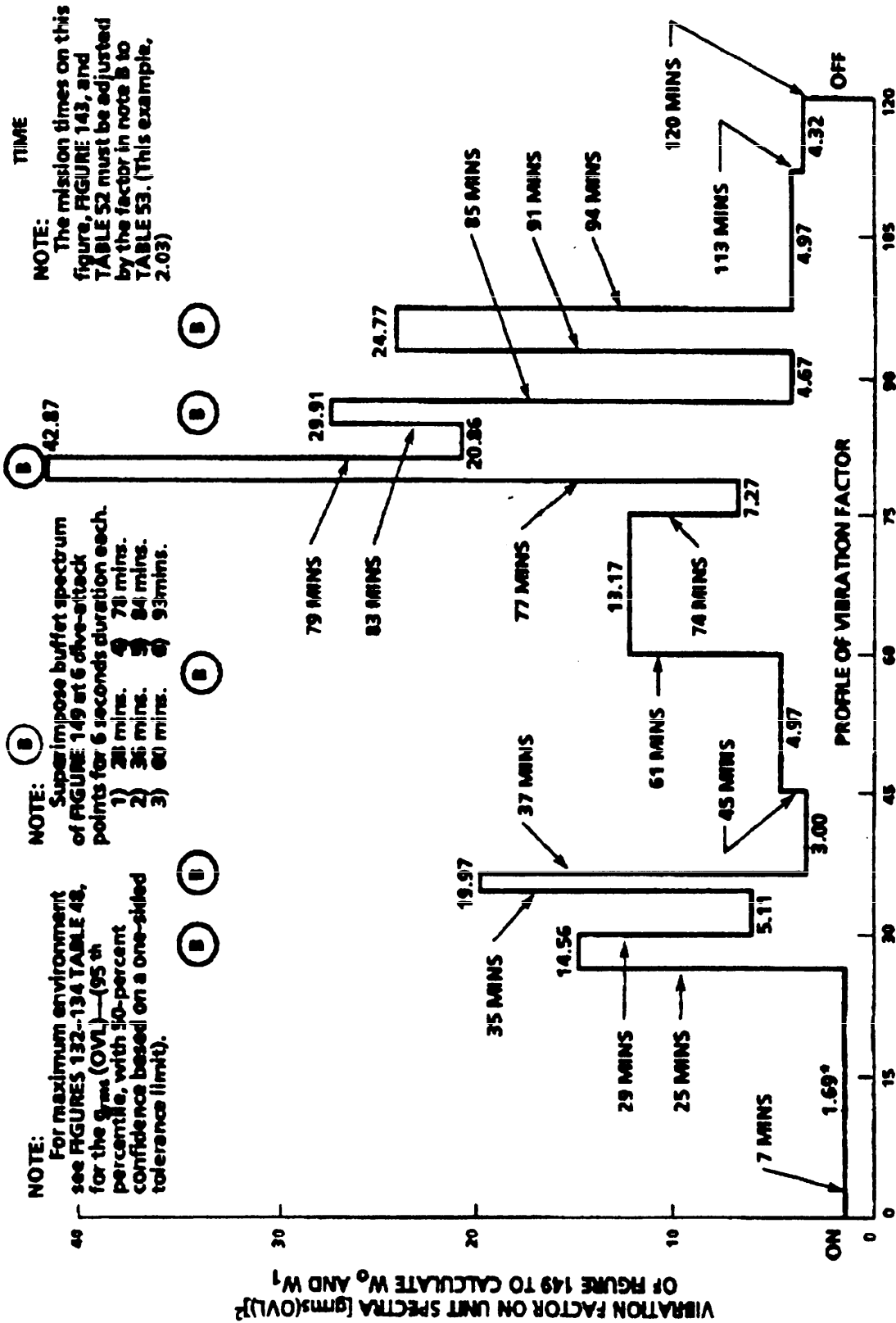

FIGURE 146. Vibration factor  $[g_{rms}(OVL)]^2$  flight mission profile high-medium-low use with FIGURES 130 and 143 except (") versus minimum  $g_{rms}(OVL)^2$  (example)

MIL-HDBK-781

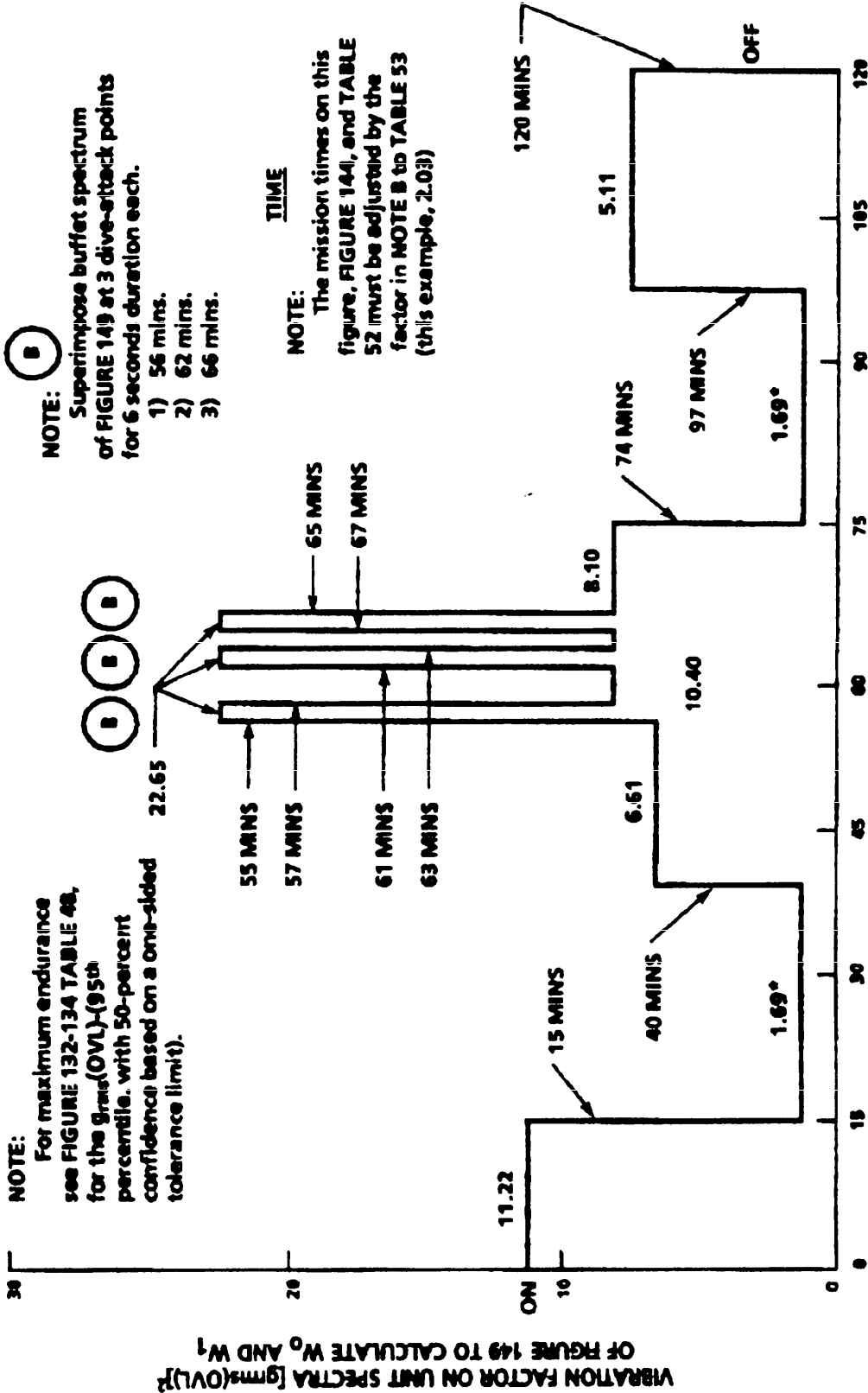

FIGURE 147. Vibration factor  $[g_{rms}(OVL)]^2$  flight mission profile high-low-high use with FIGURES 130 and 144 except (\*) versus minimum  $g_{rms}(OVL)^2$  (example)

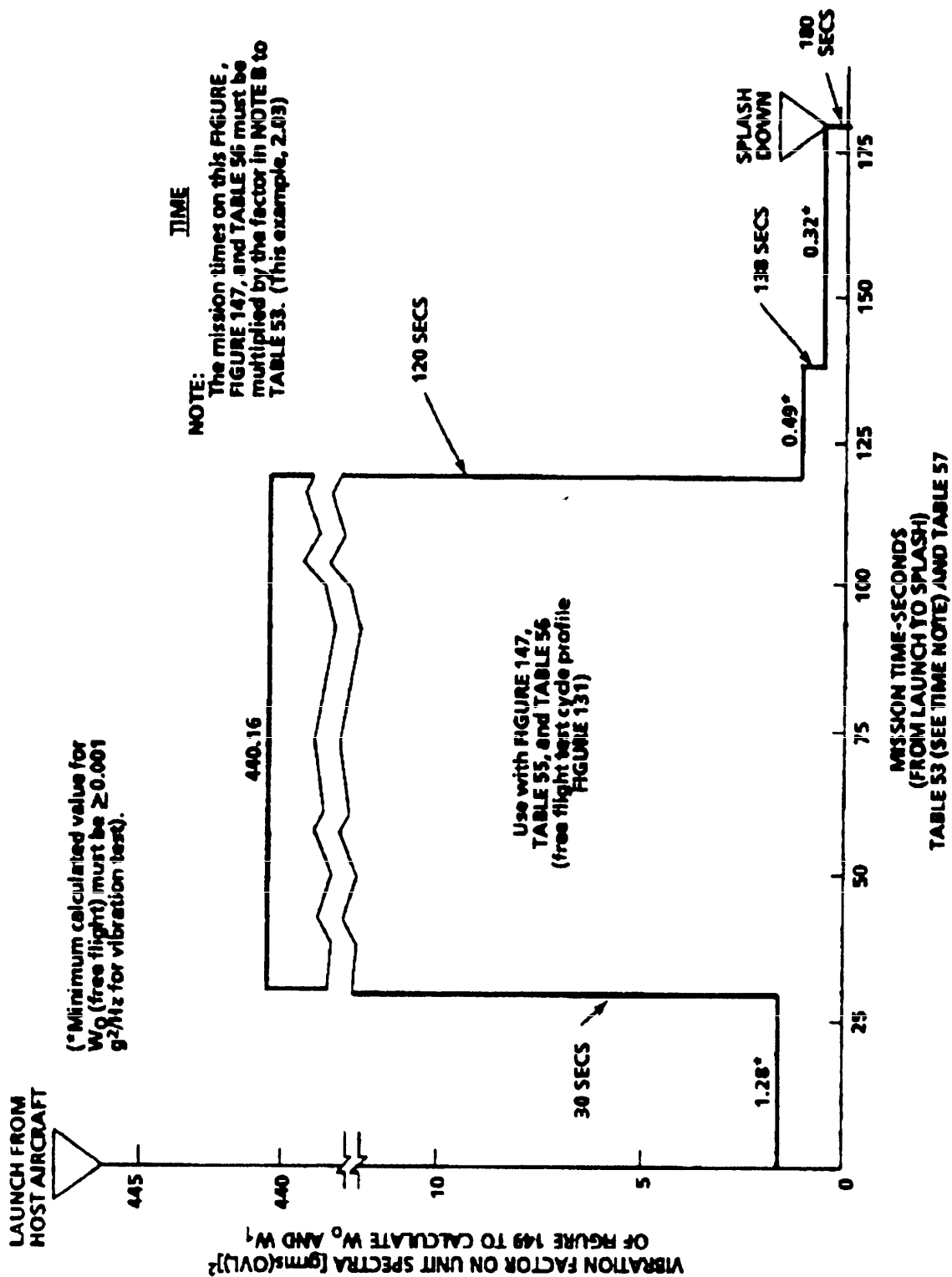
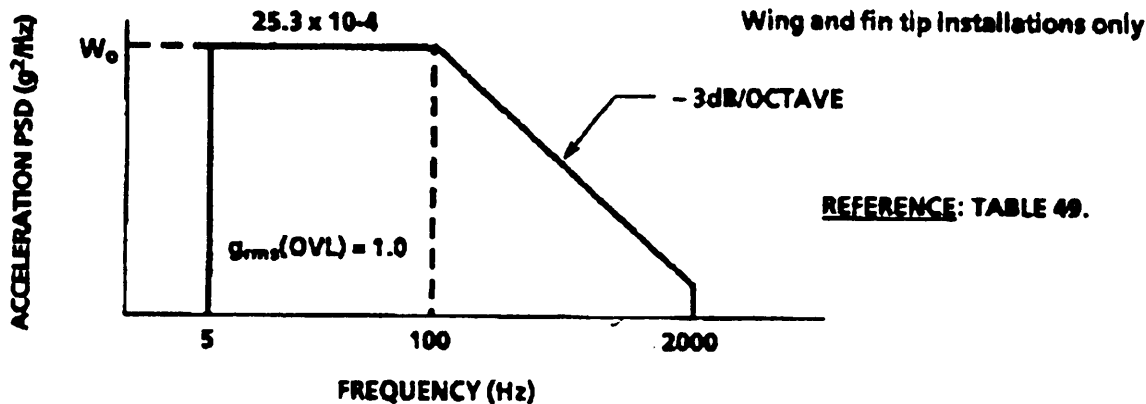

FIGURE 148. Store free-flight vibration factor ( $g_{rms}(OVL)$ )<sup>2</sup> flight mission profile (low-low) use with FIGURES 131 thru 134 and TABLE 48 (example)

**A. ASSEMBLED STORE AND ON-BOARD EQUIPMENT**

(No weight reduction factor)

$W_{\alpha(TTEST)} = \bar{W}_{\alpha}(g_{rms}(OVL))^2$  vibration factor  
 For:  $q \leq 250 \text{ lb/ft}^2, \text{Mach} \leq 0.45$



**B. ASSEMBLED STORE HIGH SPEED**

(No weight reduction factor)

$W_{\alpha(TTEST)} = \bar{W}_{\alpha}(g_{rms}(OVL))^2$  vibration factor

$W_{1(TTEST)} = \bar{W}_{1}(g_{rms}(OVL))^2$  vibration factor

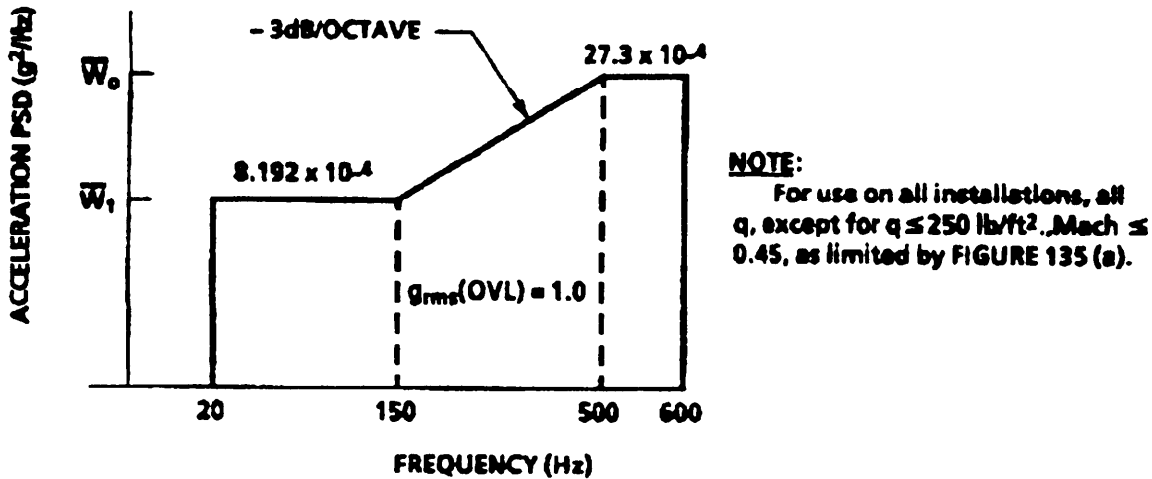

Frequencies should be determined by Method 514.3 of MIL-STD -810, as applicable.

FIGURE 149. Unit grms (OVL)-acceleration PDS versus frequency spectra

**C. ON-BOARD EQUIPMENT HIGH SPEED**

See FIGURE 135 (A) for wing and fin tip installation, otherwise, use at all dynamic pressures,  $q$ .

$W_1 (TEST) = \bar{W}_1 (g_{rms} (OVL))^2$  vibration factor  
 $W_0 (TEST) = \bar{W}_0 (g_{rms} (OVL))^2$  vibration factor  
 For:  $q \geq 250 \text{ lb/ft}^2$ , Mach  $\geq 0.45$

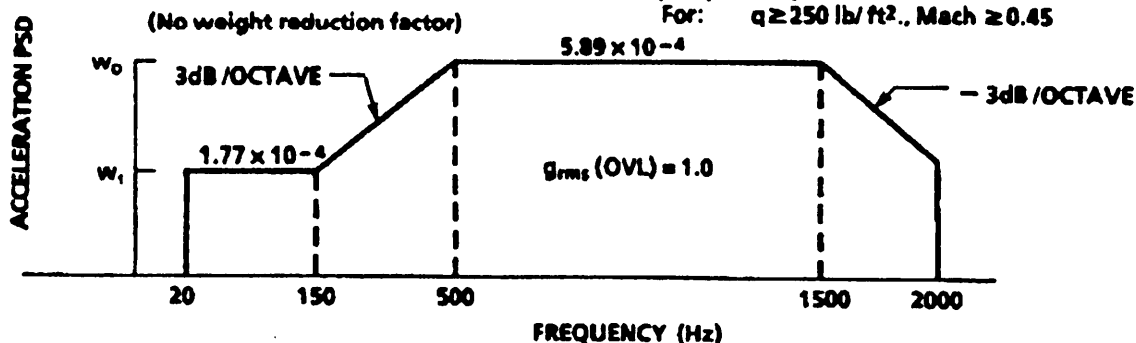

**D. BUFFET-ASSEMBLED STORES AND ON-BOARD EQUIPMENT.**  
 (Selected occurrences by maneuvers of mission)

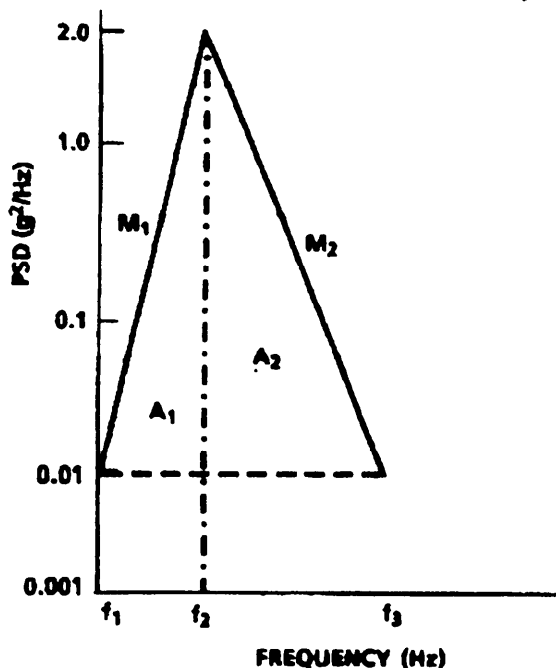

Time of application of spectrum : 6 seconds, per occurrence, minimum 3 occurrences per mission.

$f_1 = 5 \text{ Hz}$

$f_2 =$  First rigid body wing-pylon-store frequency (Hz)  
 otherwise,  $f_1 \leq f_2 \leq f_3$

$f_3 = 20 \text{ Hz}$

**NOTES:**

1. This spectrum will be superimposed on the applicable acceleration PSD spectra of FIGURES 135 and 136, according to the mission profile definition of flight phasing of buffet.
2. Weight reduction factor not applicable for this spectrum.
3. See TABLE 49 for equations to solve for  $M_1$ ,  $M_2$ ,  $A_1$  and  $A_2$ .

FIGURE 149. Unit grms (OVL)-acceleration PDS versus frequency spectra (Continued)

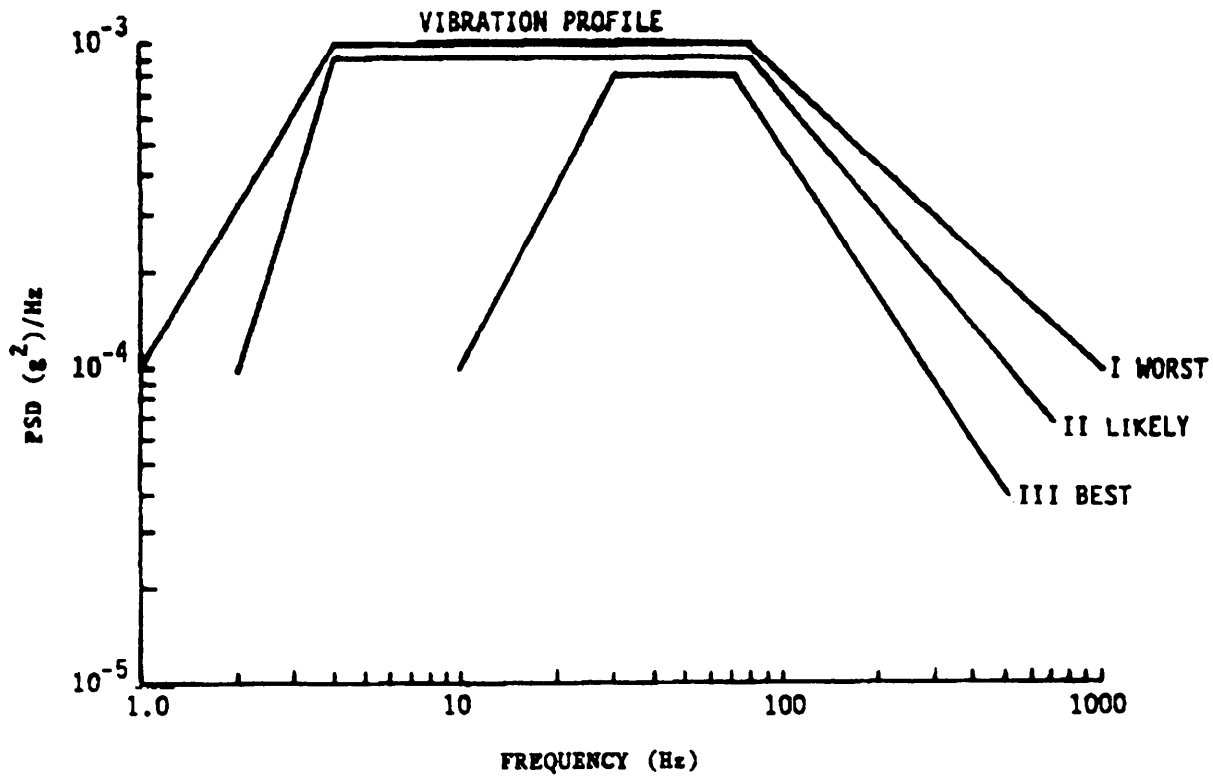

FIGURE 150. Vibration profiles for rail transportation



```

0020c
0030c      Approximately optimum Reliability bounds
0040c
0050      read m3, v3, m2, v2, m1, v1, s(20), c(20), tm, z(20), z2(20),
z3(20),
0060      & z4(20), tk, sum 1, sum 2, sum 3, sum 4, sum 5, r
0070      integer k, nf(20), n,l
0080c
0090c      Input # systems, time on test, # failures
0100c
0110      print 5000
0120 5000      format (2x, "Give number of subsystems.")
0130      read (5,6060)k
0140      print 5010
0150 5010      format (2x, "Enter data starting by subsystem with smallest total
0330c          time on test.")
0340      do 10 i = 1,k
0350      print 5050,i
0360 5050      format (2x, "Enter data for subsystem",i4)
0370      print 5060
0380 5060      format (2x, "Enter this subsystem's total time on test.")
0390      read (5,6060) z(i)
0400      print 5070
0410 5070      format (2x, "Enter this subsystem's number of failures.")
0420      read (5,6060) nf(i)
0425c
0430      if (nf(i) .gt. 0) go to 10
0440      print 5040
0445 5040      format (2x, "Zero failures: analysis impossible.")
0450      go to 105
0460 10      continue
0470c
0480c      Second part:
0490c      Calculation of M and V
0500c
0510c      Preliminaries:
0520c
0530      Do 20 i= 1,k
0540      zl(i) = 1.0/z(i)
0550      z2(i) = 1.0/(z(i)*z(i))

```

FIGURE 152. Program listing for FORTRAN program.

```
0560          z3(i) = 1.0/(z(i)**3)
0570          z4(i) = 1.0/z(i)**4
0580 20      continue
0590c
0600cc      Do 30 i-1,k
0610cc      print 5080,z(i),z1 (i), z2(i),z3(i), z4(i)
0620 5080   format (2x, f 12.3, 2x4 (f 12.9,2x))
0630cc 30   continue
0640c
0650c      More than one failure/subsystem
0660c
0670          sum1 = 0.0
0680          sum2 = 0.0
0690          sum3 = 0.0
0700          sum4 = 0.0
0710c
0720          Do 40i = 1,k
0730          n = nf(i)-1
0740          sum 1 = sum 1 +(n*z1(i))
0750          sum 2 = n*z2(i) + sum2
```

FIGURE 152. Program listing for FORTRAN program - Continued.

```

0760      sum3 = n*z3(i) + sum3
0770      sum4 = n*z4(i) + sum4
0790  40  continue
0795cc    print 5090,sum1, sum2, sum3, sum4
0800  5090 format(4 (f10.6,2x))
0860c
0870c      Original paper (1972)
0880c
0890      ml =sum1 + sum3/sum2
0900      vi = sum2 + sum4/sum2
0910cc    print 6000,ml,v1
0920  6000 format (2x,"M1 = ",f10.7,3x,"V1 = ,f10.7)
0930c
0940c      Modified version (1974)
0950c
0960      m2 = sum1 +z1 (1)
0970      v2 = sum2 + z2 (1)
0972cc    print 6005, m2, v2
0974  6005 format (2x, "M2 = ",f10.7, 3x, "V2 =",f10.7)
0980c
0990c      The Case of Only One Failure:
1000c
1010      Tk = 0.0
1020      Do 50 i = 1,k
1030      tk = tk + nf(i)
1040  50  continue
1050      tk = tk/float (k)
1060      do 60i = 1,k
1070      n = nf(i)+ 1
1080      s(i) = (z(i)-z(1))/(tk**n)
1090      s(i)=z(i)-s(i)
1100  60  continue
1110      do 70l = 1,k
1120      c(i) = nf(1)-1 + ((z(i)/(k*s(i)))**2)
1125cc    print 601°,i, s(i), i, c(i)

```

FIGURE 153. Program listing for FORTRAN program.

```

1130 70      continue
1140 6010   format (2x, "s(",i3,") = ",f10.5,2x,"c(",i3," = ", f10.5)
1150c
1160       sum1 = 0.0
1170       sum2 = 0.0
1180       sum3 = 0.0
1190       sum4 = 0.0
1200       sums = 0.0
1210       do 80i = 1,k
1220         n = nf(i)-1
1230         sum1 = n/s(i)+sum1
1240         sum2 = n/(s(i)*s(i)) + sum2
1250         sum3 = sum3+(c(i)/(s(i)*z(i)*i(i)))
1260         sum4 = sum4 + (c(i)/((s(i)**2)*(z(i)**2)))
1270         sum5 = sum5 + (c(i)/(z(i)**2))
1290 80      continue
1295cc     print 6020, sum1 ,sum2, sum3, sum4, sums
1300 6020   format (2x,5(f10.7,3x))
1310c
1320       m3 = sum1 +sum3/sum5
1330       v3 = sum2 + sum4/sum5
1332cc     print 6025,m3,v3
1334 6025   format (2x,~M3 =~,f10.3,2x,~V3 =~,f10.7)
1340c
1350c     Calculation of bounds

```

FIGURE 153. Program listing for FORTRAN program - Continued.

```
1360c
1370 500  continue
1375      print 6037
1380      print 6030
1390 6030 format (2x,"Enter confidence level percentile.")
1400      read (5,6060)p
1410      print 6035
1420 6035 format (2x,"Enter mission time.")
1430      read (5,6060)tm
1432      print 6037
1434      print 6037
1435      print 6032, tm
1436 6032 format (2x,"Mission Time:",f10.5)
1437      print 6036,p
1438 6036 format (6x,"percentile:",f10.5)
1439      print 6036,p
1436 6037 format (3x)
1440c      call result (m1,v1,tm p,r)
1445c      print 6000,m1,v1
1450c      print 6040,r
1460      call result (m2,v2, tm,p,r)
1465      print 6005, m2,v2
1470      print 6040,r
1475      print 6037
1480c      call result (m3,v3,tm, p,r)
1485c      print 6025,m3,v3
1490c      print 6040,r
1495      print 6037
1500 6040 format (2x,"Reliability Bound is:",f10.6)
1510      print 6050
1520 6050 format (2x,"Reliability Bound is:",f10.6)
1510      print 6050
1520 6050 format (2x,"If another confidence level or mission time, give 1.")
1530      read (5,6060)l
1532      print 6037
1540      if (l.eq.1) go to 500
1545      format (v)
1550      continue
```

FIGURE 154. Program listing for FORTRAN program.

```
1560      stop
1570      end
1590c
1590      subroutine result (m,v,tm,p,r)
1600      real m, v, tm, p, r
1610c
1620      r = p*(sqrt(v))/(3.0*m)
1630      r = 1.0-(v/(9.0*m*m)) + r
1640      r = r**3
1650      r = tm*m*r
1655      r = exp(r)
1660      return
1670      end
```

FIGURE 154. Program listing for FORTRAN program - Continued

## STANDARDIZATION DOCUMENT IMPROVEMENT PROPOSAL

### INSTRUCTIONS

1. The preparing activity must complete blocks 1, 2, 3, and 8. In block 1, both the document number and revision letter should be given.
2. The submitter of this form must complete blocks 4, 5, 6, and 7.
3. The preparing activity must provide a reply within 30 days from receipt of the form.

NOTE: This form may not be used to request copies of documents, nor to request waivers, or clarification of requirements on current contracts. Comments submitted on this form do not constitute or imply authorization to waive any portion of the referenced document(s) or to amend contractual requirements.

<b>I RECOMMEND A CHANGE:</b>		1. DOCUMENT NUMBER <b>MIL-HDBK-781A</b>	2. DOCUMENT DATE (YYMMDD) <b>960329</b>
3. DOCUMENT TITLE <b>HANDBOOK FOR RELIABILITY TEST METHODS, PLANS AND ENVIRONMENTS FOR ENGINEERING DEVELOPMENT QUALIFICATION, AND PRODUCTION</b>			
4. NATURE OF CHANGE (Identify paragraph number and include proposed rewrite, if possible. Attach extra sheets as needed)			
5. REASON FOR RECOMMENDATION			
<b>6. SUBMITTER</b>			
a. NAME (Last, First, Middle Initial)		b. ORGANIZATION	
c. ADDRESS (Include Zip Code)		d. TELEPHONE (Include Area Code)	e. DATE SUBMITTED (YYMMDD)
		(1) Commercial	
		(2) AUTOVON (if applicable)	
<b>8. PREPARING ACTIVITY</b>			
a. NAME		b. TELEPHONE (Include Area Code)	(2) AUTOVON
COMMANDER, SPACE AND NAVAL WARFARE SYSTEMS COMMAND (SPAWAR 052-2)		(1) Commercial (703) 802-9142	332-9142
c. ADDRESS (Include Zip Code)		IF YOU DO NOT RECEIVE A REPLY WITHIN 45 DAYS, CONTACT Defense Quality and Standardization Office 5203 Leesburg Pike Suite 1403 Falls Church VA 22041-3488 Telephone (703) 756-2340 AUTOVON 289-2340	
2451 CRYSTAL DRIVE ARLINGTON, VA 22245-5200			