

INCH-POUND

MIL-HDBK-1102/7  
10 NOVEMBER 1994

MILITARY HANDBOOK  
CONCRETE PAVEMENT REPAIR



AMSC N/A

AREA FACR

DISTRIBUTION STATEMENT A : APPROVED FOR PUBLIC RELEASE; DISTRIBUTION IS UNLIMITED.

ABSTRACT

This handbook describes methods and procedures for maintenance and repair of concrete pavements. Since surface failure must be corrected at the source, probable causes are discussed and repair measures are described. The principles outlined apply to reinforced and nonreinforced pavements for roads, airfields, and parking and open-storage areas. Normal maintenance on concrete pavements consists principally of the care of joints, sealing of cracks, replacement of random broken slabs or similar sections, and the correction of minor settlement and drainage faults. Repair consists of the work required to restore a distressed pavement so that it may be used at its originally designed capacity and to accommodate the current mission as provided for by applicable service instruction. Additional information can be found in the literature listed in the REFERENCES.

FOREWORD

This handbook is presented as a reference guide for installation personnel engaged in maintenance and repair of portland cement concrete surfaced areas. This handbook is not intended to present design details or complete specifications needed to undertake new construction, alterations, or additions. Such information should be obtained from the specific design manuals and specifications prepared for those purposes.

Recommendations for improvement are encouraged from within the Navy, other Government agencies, and the private sector and should be furnished on the DD Form 1426 provided inside the back cover to Commanding Officer, Northern Division, Naval Facilities Engineering Command, 10 Industrial Highway, Mail Stop #82, Code 164, Lester, PA 19113-2090; telephone commercial (215) 595-0661.

THIS HANDBOOK SHALL NOT BE USED AS A REFERENCE DOCUMENT FOR PROCUREMENT OF FACILITIES CONSTRUCTION. IT IS TO BE USED IN THE PURCHASE OF FACILITIES ENGINEERING STUDIES AND DESIGN (FINAL PLANS, SPECIFICATIONS, AND COST ESTIMATES). DO NOT REFERENCE IT IN MILITARY OR FEDERAL SPECIFICATIONS OR OTHER PROCUREMENT DOCUMENTS.

## CONCRETE PAVEMENT REPAIR MANUAL

## CONTENTS

		<u>Page</u>
Section 1	INTRODUCTION	
1.1	Objective . . . . .	1
1.2	Selection of Repair Materials . . . . .	1
Section 2	CONCRETE PAVEMENT	
2.1	Description and Composition . . . . .	2
2.2	Properties and Behavior . . . . .	2
2.2.1	Performance . . . . .	2
2.2.2	Rigidity . . . . .	2
2.2.3	Strength . . . . .	2
Section 3	DISTRESS TYPES AND THEIR CAUSES	
3.1	Blowups . . . . .	4
3.2	Corner Breaks . . . . .	4
3.3	Corner Spalling . . . . .	4
3.4	Crazing . . . . .	4
3.5	"D" Cracking . . . . .	4
3.6	Divided Slab (Shattered) . . . . .	4
3.7	Faulting . . . . .	4
3.8	Joint Spalling . . . . .	5
3.9	Joint Seal Damage . . . . .	5
3.10	Lane/Shoulder Drop Off . . . . .	5
3.11	Large Patch and Utility Cuts . . . . .	5
3.12	Linear Cracking (Longitudinal, Transverse, and Diagonal) . . . . .	6
3.13	Polished Aggregate . . . . .	6
3.14	Popouts . . . . .	6
3.15	Pumping . . . . .	6
3.16	Punchout . . . . .	7
3.17	Railroad Crossing Distress . . . . .	7
3.18	Scaling . . . . .	7
3.19	Shrinkage Cracks . . . . .	7
3.20	Small Patching . . . . .	7
Section 4	FULL DEPTH REPAIR OF PAVEMENTS	
4.1	Purpose of Full Depth Repair . . . . .	8
4.2	Need for Full Depth Repair . . . . .	8
4.3	Selection of Repair Boundaries . . . . .	8
4.4	Sawing of Repair Boundaries . . . . .	11
4.4.1	Partial Depth . . . . .	11
4.4.2	Full Depth . . . . .	11
4.5	Removal of Existing Concrete . . . . .	15
4.5.1	The Breakup and Cleanout Method . . . . .	15
4.5.2	The Lift Out Method . . . . .	15
4.6	Subgrade and Base Preparation . . . . .	15
4.7	Dowel and Tiebar Placement . . . . .	22
4.7.1	Grouting . . . . .	22
4.7.2	Smooth Steel Dowels . . . . .	22

		<u>Page</u>
4.7.3	Deformed Tie Bars . . . . .	22
4.7.4	Other Methods . . . . .	22
4.8	Replacing Reinforcement . . . . .	22
4.9	Expansion Joints . . . . .	26
4.10	Filler Material . . . . .	26
4.11	Dowels . . . . .	31
4.12	Concrete Placement . . . . .	31
4.13	Concrete Finishing and Texturing . . . . .	31
4.14	Curing . . . . .	31
4.15	Joint Sealing . . . . .	32
<b>Section 5</b>	<b>PARTIAL DEPTH REPAIR OF PAVEMENTS</b>	
5.1	Purpose of Partial Depth Repair . . . . .	33
5.2	Need for Partial Depth Repair . . . . .	33
5.3	Selection of Repair Boundaries . . . . .	33
5.4	Removal of Existing Concrete . . . . .	42
5.5	Cleaning . . . . .	43
5.6	Joint Preparation . . . . .	43
5.7	Patch Materials . . . . .	47
5.7.1	Normal Set . . . . .	47
5.7.2	Rapid Set . . . . .	47
5.8	Placement of Patch Material . . . . .	47
5.9	Finishing . . . . .	47
5.10	Sawcut Run-outs . . . . .	48
5.11	Sealing Patch/Slab Interface . . . . .	48
5.12	Curing . . . . .	48
5.13	Joint Resealing . . . . .	48
<b>Section 6</b>	<b>SLABJACKING</b>	
6.1	Purpose of Slabjacking . . . . .	51
6.2	Need for Slabjacking . . . . .	51
6.3	Location of Injection Holes . . . . .	51
6.4	Drilling Holes . . . . .	51
6.5	Grout Mixture . . . . .	58
6.6	Grout Pumping . . . . .	58
6.6.1	Lifting . . . . .	58
6.6.2	Leaks . . . . .	58
6.6.3	Gauge Pressures . . . . .	58
6.7	Elevation Control During Jacking . . . . .	62
6.8	Plugging and Cleanup . . . . .	62
<b>Section 7</b>	<b>SUBSEALING JOINTED CONCRETE PAVEMENTS</b>	
7.1	Purpose of Subsealing . . . . .	65
7.2	Void Detection . . . . .	65
7.2.1	Methods of Detection . . . . .	65
7.3	Need for Subsealing . . . . .	65
7.4	Hole Patterns . . . . .	71
7.5	Drilling Holes . . . . .	71
7.6	Grout Mixtures . . . . .	71
7.7	Grout Injection . . . . .	76
7.7.1	Slab Movement . . . . .	76
7.8	Retesting Slab Corners . . . . .	76

		<u>Page</u>
7.9	Plugging and Cleanup . . . . .	76
Section 8	ASPHALT UNDERSEALING	
8.1	Description . . . . .	81
8.2	Procedure . . . . .	81
Section 9	DIAMOND GRINDING	
9.1	Purpose of Grinding . . . . .	82
9.2	Need for Grinding . . . . .	82
9.3	Grinding Process . . . . .	82
9.4	Test Section . . . . .	82
9.5	Grinding Procedure . . . . .	82
9.5.1	Roughness Removal . . . . .	82
9.5.2	Fault Removal . . . . .	86
9.5.3	Improving Skid Resistance . . . . .	86
9.6	Acceptance Testing . . . . .	86
Section 10	LOAD TRANSFER RESTORATION	
10.1	Purpose of Load Transfer Restoration . . . . .	87
10.2	Need for Load Transfer Restoration . . . . .	87
10.3	Selection of Joints/Cracks . . . . .	87
10.4	Methods of Restoration of Load Transfer . . . . .	87
10.5	Dowels . . . . .	89
10.6	Dowel Installation . . . . .	89
10.7	Shear Device Installation . . . . .	93
10.8	Patching Material . . . . .	93
10.9	Placing Patching Materials . . . . .	93
Section 11	JOINT AND CRACK SEALING	
11.1	Purpose of Joint and Crack Sealing . . . . .	101
11.2	Sealant Types of Concrete Pavement . . . . .	101
11.2.1	Field Poured . . . . .	101
11.2.2	Preformed Elastomeric . . . . .	101
11.2.3	Others . . . . .	101
11.2.4	Silicone Joint Sealant . . . . .	101
11.2.5	Nitrile Rubber Sealant . . . . .	101
11.3	Sealant Removal . . . . .	102
11.4	Refacing Joints . . . . .	102
11.5	Rebuilding Joints . . . . .	102
11.6	Cleaning Joints . . . . .	102
11.7	Crack Preparation . . . . .	110
11.8	Sealant Removal . . . . .	110
11.9	Routing of Cracks . . . . .	110
11.10	Cleaning Cracks . . . . .	110
11.11	Sealing Operations . . . . .	110
11.11.1	Lower Portion . . . . .	111
11.11.2	Backer Material . . . . .	111
11.11.3	Temperature . . . . .	111
11.11.4	Examination . . . . .	111
11.12	Compression Seals . . . . .	114
11.13	Silicone Sealant Installation . . . . .	114
11.13.1	Proprietary Materials . . . . .	114

		<u>Page</u>
11.13.2	Silicone Joint Sealant . . . . .	114
11.14	Nitrile Rubber Sealant Installation . . . . .	115
11.15	Hot-applied Sealing Equipment . . . . .	115
11.16	Cold-applied Sealing Equipment . . . . .	116
11.17	Preformed Compression Seal Equipment . . . . .	116
11.18	Silicone Sealant Equipment . . . . .	116
11.19	Nitrile Rubber Sealant Equipment . . . . .	117
<b>Section 12</b>	<b>PAVEMENT EDGE DRAINAGE</b>	
12.1	Purpose of Pavement Edge Drainage . . . . .	118
12.2	Need for Pavement Edge Drainage . . . . .	118
12.3	Drainage Systems . . . . .	118
12.4	Subsurface Drain Functions . . . . .	118
12.4.1	Base Drainage . . . . .	118
12.4.2	Subgrade Drainage . . . . .	118
12.4.3	Interceptor Drainage . . . . .	118
12.5	Subsurface Drain Materials . . . . .	121
12.5.1	Pipe . . . . .	121
12.5.2	Filter Material . . . . .	121
12.6	Filter Fabrics . . . . .	123
12.6.1	Geotextile to Wrap . . . . .	123
12.6.2	Geotextile to Line . . . . .	123
12.6.2.1	Adjacent to Granular Materials . . . . .	123
12.6.2.2	Adjacent to Other Soil Types . . . . .	127
12.6.2.3	Criteria . . . . .	127
12.7	Subsurface Drain Installation . . . . .	127
12.7.1	Filter Material . . . . .	127
12.8	French Drains . . . . .	129
<b>Section 13</b>	<b>POLYMER CONCRETE</b>	
13.1	Identification . . . . .	132
13.2	Surface Preparation . . . . .	132
13.3	Polymer Concrete Patching Materials . . . . .	133
13.3.1	Monomers . . . . .	133
13.3.2	Curing . . . . .	133
13.3.3	Epoxy Compounds . . . . .	133
13.3.4	Aggregates . . . . .	133
13.4	Polymer Concrete Placement . . . . .	133
13.5	Safety . . . . .	134
<b>Section 14</b>	<b>STEEL FIBER REINFORCED CONCRETE</b>	
14.1	Description . . . . .	135
14.2	Steel Fibers . . . . .	135
14.3	Aggregates . . . . .	135
14.4	Admixtures . . . . .	135
14.4.1	Additive Caution . . . . .	135
14.4.2	Water-reducing . . . . .	135
14.4.3	Air-Entraining . . . . .	136
14.5	Mixture Proportions . . . . .	136
14.6	Mixing SFRC . . . . .	136
14.7	Transporting and Placing SFRC . . . . .	136
14.7.1	Pumping . . . . .	137

		<u>Page</u>
14.7.2	Forms and Equipment . . . . .	137
14.7.3	Temperature . . . . .	137
Section 15	HEAT RESISTANT CONCRETE	
15.1	Condition . . . . .	138
15.2	Exposure . . . . .	138
15.3	Materials . . . . .	138
15.4	Repair . . . . .	139
15.5	Joint Sealant . . . . .	139
15.6	Conventional Concrete . . . . .	139

#### FIGURES

Figure 1	Example of Shattered Slab . . . . .	9
Figure 2	Example of Deterioration at Joint, Bottom of Slab . . . . .	10
Figure 3	Example of Sawing Repair Boundary Limits . . . . .	12
Figure 4	Example of Spalling at Bottom of Slab Caused by Pavement Breaker . . . . .	13
Figure 5	Plan View of Saw Cuts for Aggregate Interlock . . . . .	14
Figure 6	Section View of Saw Cuts for Reinforced Pavement . . . . .	16
Figure 7	Example of Concrete Removal Using a Backhoe . . . . .	17
Figure 8	Plan View of Saw Cuts for Breakup Method . . . . .	18
Figure 9	Example of Concrete Removal Using the Lift- Out Method . . . . .	19
Figure 10	Plan View of Saw Cuts for Lift-Out Method . . . . .	20
Figure 11	Example of Recompacting Base in Repair Area . . . . .	21
Figure 12	Example of Installed Smooth Dowel Bars . . . . .	23
Figure 13	Example of Deformed Steel Tie Bar . . . . .	24
Figure 14	Example of Gang Drill . . . . .	25
Figure 15	Section View of Welded Reinforcing Installation. . . . .	27
Figure 16	Section View of Thickened-edge Expansion Joint. . . . .	28
Figure 17	Section View of Thickened-edge Slip Joint . . . . .	29
Figure 18	Section View of Doweled-type Expansion Joint. . . . .	30
Figure 19	Example of Spalling at a Joint . . . . .	34
Figure 20	Example of Sawn Repair Boundaries at a Joint Spall . . . . .	35
Figure 21	Plan of Spall Repairs . . . . .	36
Figure 22	Spall Repair at Keyed Construction Joint . . . . .	37
Figure 23	Spall Repair at Weakened Plane or Contraction Joint . . . . .	38
Figure 24	Spall Repair at Expansion Joint . . . . .	39
Figure 25	Groove for Joint Sealant at Spall Repair . . . . .	40
Figure 26	Typical Section: Popout Repair . . . . .	41
Figure 27	Example of Vertical Faces Provided by Sawing. . . . .	44
Figure 28	Example of Resounding Bottom of Repair Area . . . . .	45
Figure 29	Example of Spall Repair Failure Caused by Point Bearing . . . . .	46



	<u>Page</u>
Figure 30	Example of Bonding Agent Application to Repair Area . . . . . 49
Figure 31	Example of a Small Diameter Vibrator. . . . . 50
Figure 32	Grout Fills Voids Under Slab Restoring Uniform Support . . . . . 52
Figure 33	Evidence of Concrete Slabs Pumping . . . . . 53
Figure 34	Example of Injection Hole Layout . . . . . 54
Figure 35	Location of Holes Varies for Defect to be Corrected . . . . . 55
Figure 36	Example of Drilling Holes for Grout Injection . . . . . 56
Figure 37	Example of Injection Hole . . . . . 57
Figure 38	Example of Flow Test . . . . . 59
Figure 39	Pumping Sequence for Dip in Pavement . . . . . 60
Figure 40	Example of Expanding Rubber Packer . . . . . 61
Figure 41	Elevation Control for Dip in Pavement Using a String Line . . . . . 63
Figure 42	Example of Tapered Wooden Plug . . . . . 64
Figure 43	Grout Will, Without Raising the Slab, Fill the Voids Under It . . . . . 66
Figure 44	Deflection Measurement Locations . . . . . 67
Figure 45	Deflection Measurements Over Time Per Day . . . . . 68
Figure 46	Deflection Measurements Over Time Per Year. . . . . 69
Figure 47	Falling Weight Deflectometer . . . . . 70
Figure 48	Common Hole Pattern . . . . . 72
Figure 49	Location of Additional Holes at Longitudinal Joints or Shoulder. . . . . 73
Figure 50	Example of Injection Hole . . . . . 74
Figure 51	Example of Flow Test . . . . . 75
Figure 52	Example of Expanding Rubber Packer . . . . . 78
Figure 53	Example of Device for Monitoring Slab Movement. . . . . 79
Figure 54	Example of Tapered Wooden Plug. . . . . 80
Figure 55	Example of Grinding Machine . . . . . 83
Figure 56	Example of Gang-Mounted Diamond Saw Blades. . . . . 84
Figure 57	California Profilograph . . . . . 85
Figure 58	Falling Weight Deflectometer. . . . . 88
Figure 59	Example of Saw Cuts for Dowel Bar Installation. . . . . 90
Figure 60	Example of Installed Dowel Bar. . . . . 91
Figure 61	Section View of Dowel Bar Installation . . . . . 92
Figure 62	Example of Filler Board in Completed Repair . . . . . 94
Figure 63	Example of Core Drill . . . . . 95
Figure 64	Device for Grooving Core Hole Walls . . . . . 96
Figure 65	Example of Inserted Double V-Device (Note Grooved Walls) . . . . . 97
Figure 66	Example of Bonding Agent Application. . . . . 98
Figure 67	Example of Placing and Consolidating Patch Material by Vibration . . . . . 99
Figure 68	Example of Consolidating Patch Material by Tamping . . . . . 100
Figure 69	Example of Rectangular Joint Plow . . . . . 103
Figure 70	Example of Joint Plow with Spring-Holding Device. . . . . 104

	<u>Page</u>
Figure 71	Example of Joint Damage Caused by Improper Plowing . . . . . 105
Figure 72	Example of V-shaped Plow Tool (Do Not Use). . . . . 106
Figure 73	Example of Joint Refacing by Sawing . . . . . 107
Figure 74	Example of Joint Cleaning by Sandblasting . . . . . 108
Figure 75	Example of Joint Cleaning by Waterblasting. . . . . 109
Figure 76	Joint Reservoir using Backer Material . . . . . 112
Figure 77	Joint Repair using Separating Material . . . . . 113
Figure 78	Example of Pavement Distress Caused by Water under Pavement . . . . . 119
Figure 79	Example of Water in Pavement Base Material. . . . . 120
Figure 80	Example of Flexible Drainage Pipe . . . . . 122
Figure 81	Filter Fabric used to Wrap Collector Pipe . . . . . 124
Figure 82	Filter Fabric used to Line Trench . . . . . 125
Figure 83	Example of Fabric-Lined Trench . . . . . 126
Figure 84	Example of Trenching Machine . . . . . 128
Figure 85	French Drain . . . . . 130
Figure 86	Example of Protected Drain Outlet . . . . . 131
BIBLIOGRAPHY	. . . . . 141
REFERENCES	. . . . . 142
GLOSSARY	. . . . . 144

Section 1: INTRODUCTION

1.1 Scope. The objective of this handbook is to provide a simple step-by-step "how to" procedure for concrete pavement repair.

This handbook was developed so the subject matter will correspond with NAVFAC Manual MO-102.2, Maintenance and Repair Alternatives, Pavement Condition Index Field Manual, Jointed Concrete Roads, and Parking Lots; and NAVFAC Manual MO-102.4, Maintenance and Repair Alternatives, Pavement Condition Index Field Manual, Jointed Concrete Airfields.

1.2 Selection of Repair Materials. A variety of concrete repair materials are available on the market today. A properly designed, placed, and cured conventional portland cement concrete (PCC) remains as one of the more widely used and reliable patching materials for concrete pavements. It is most effective for full depth patches or complete slab replacement. The use of portland cement concrete in partial depth patches has given mixed results. By using high early strength cement (Type III) and accelerators, concrete mixes can be produced that will allow traffic in 24 hours or less.

A wide variety of special products sold under proprietary names for patching concrete is available. These include both organic and inorganic materials such as epoxies, methacrylates, magnesium phosphate cements, gypsum based cements, and many others. Most of these products are sold under trade names so it is often difficult to identify the specific cementitious material in the patching material. All claims of performance for these proprietary products should be treated with caution, and it is always prudent to establish the performance of new products through trials prior to committing to the purchase of any large quantities.

The selection and evaluation of specific patching materials are specialized topics and outside the scope of this manual.

## Section 2: CONCRETE PAVEMENT

2.1 Description and Composition. Concrete is a material manufactured from portland cement, water, fine aggregate (sand), and coarse aggregate (gravel or crushed rock) blended, and sometimes additives (air entraining, fly ash, etc.) are used to achieve the strength and durability of a natural stone. Concrete generally achieves its initial set within 1 hour after water is added and will become fairly hard within 6 hours of placement. Concrete will continue to gain strength at an ever decreasing rate for many years as long as moisture is retained within the consolidated mass and there is no adverse chemical reaction due to internal or external action.

2.2 Properties and Behavior

2.2.1 Performance. Concrete pavement has a relatively long economic life when properly designed, constructed, and maintained. In general, the economic life of a pavement ends when the surface can no longer be used satisfactorily or repaired economically. Durability is improved by keeping the surface maintained, especially at joints and cracks. Maintaining the joints to minimize the infiltration of water and to prevent the entrance of incompressible foreign material is essential under most conditions for long life. Frequent loadings greater than those for which the pavements were designed will cause early failure of the pavement.

2.2.2 Rigidity. PCC is classified as a rigid pavement. Because of its beam action or resistance to bending, it can bridge small, soft, or settled areas of a subgrade. Overloading of concrete pavements can result from applied loads being greater than the design load or the foundation support being reduced as a result of pumping, excessive moisture, etc. Usually, once cracking has commenced, continued loading will cause additional cracks or breaks until complete failure of the pavement results.

2.2.3 Strength. The design of concrete for use in pavements is based on limiting the concrete tensile stresses produced by applied loads. Flexural strength is used in the design of rigid pavement. Loads applied to the pavement surface cause bending with tensile stresses at the bottom of the slab and compressive stresses at the top. Since compressive strength of concrete is typically 8 to 10 times greater than the tensile or flexural strength, the ratio of load induced tensile stresses at the bottom of the slab to the concrete's flexural strength controls the concrete pavement behavior. The relative strength as well as the durability is directly affected by:

- a) Quality of cement;
- b) Purity of water;
- c) Cleanliness, durability, and gradation of the aggregates;
- d) Water-cement ratio;
- e) Density of concrete;
- f) Amount and types of admixtures;

- g) Proportioning and mixing of materials;
- h) Placement and curing methods.

## Section 3: DISTRESS TYPES AND THEIR CAUSES

3.1 Blowups. A buckling blowup is the localized upward movement of a rigid pavement. The buckling may take the form of a rather serious blowup or may merely shatter the upper portion of the concrete near the joint. This condition is caused primarily by infiltration of nearly incompressible material in joints. During hot weather, slab expansion pressure builds up at transverse joints or cracks until buckling or shattering occurs. Buckling or blowups normally occur in pavements that are less than 8 inches (203 mm) thick, but they have occurred in pavements over 11 inches (279 mm) thick.

3.2 Corner Breaks. A corner break in a rigid pavement is a break which occurs diagonally across the corner of a slab. The corner break has the approximate shape of a triangle, the sides of which are formed by a transverse joint or irregular crack and a longitudinal joint or slab edge. Corner breaks are commonly caused by overloading or loss of uniform subgrade support. The lack of proper support may be caused by curling or warping in the slab, pumping which has removed a portion of the supporting material below the broken or cracked corner, or loss of load transfer at the transverse or longitudinal joints.

3.3 Corner Spalling. Corner spalling is characterized by cracking and breaking or chipping of the pavement at the corner of the slab. This breakdown of pavement usually occurs within 2 feet (0.61 m) of the corner. The primary and other causes of corner spalling are the same as that described for joint spalling.

3.4 Crazing. Crazing refers to a network of shallow, fine, or hairline cracks which extend only a small distance downward from the upper surface of the concrete. These cracks tend to intersect at an angle of approximately 120 degrees forming a pattern similar to chicken wire. Crazing usually results from rapid loss of moisture at the surface through evaporation during the early curing period causing excessive shrinkage of the surface mortar. The condition can be aggravated by excessive finishing which brings moisture to the surface. Almost all concrete has some surface crazing; however, severe crazing can lead to scaling or other surface deterioration associated with weathering.

3.5 "D" Cracking. "D" cracking is the progressive formation on the surface of a series of fine cracks at close intervals, paralleling edges and joints, curving around corners formed by joint intersections or where cracks intersect edges. "D" cracking is caused by repetitive freezing and thawing cycles in the presence of aggregates having an undesirable pore structure. Moisture is critical to the development of "D" cracking; thus, if excessive moisture can be kept out of the concrete, this type of distress can be retarded.

3.6 Divided Slab (Shattered). A divided slab is divided by cracks into four or more pieces due to overloading, fatigue failure and/or inadequate support. These cracks are usually vertical and extend full depth through the slab.

3.7 Faulting. When filled areas are not thoroughly and uniformly compacted, differential consolidation or settlement of material underlying the slabs can occur, resulting in faulting of concrete slabs. This condition may result also from curling of slab edges due to temperature and moisture changes,

loss of fines through improperly designed subdrains or other drainage systems, pumping under traffic, differential frost heave, and swelling soils.

3.8 Joint Spalling. Joint spalling is characterized by cracking and breaking or chipping of the pavement along joints, edges, or cracks. The primary cause of spalling is inferior concrete or excessive stress concentration at the joint or crack. The stress concentration may result from several different factors. Major factors include hard pieces of gravel or other debris lodged in a joint or crack, improper forming or sawing of joints, poorly designed (oversized) keyways, incorrect type or improperly installed load transfer devices, and rusted "frozen" sliding dowels. Inferior concrete at a joint or insufficient pavement thickness may cause spalling under normal loading. If the thickness is not adequate, excessive deflections under traffic will occur at the joints promoting cracks that result in spalling or raveling of the concrete. Dowels used as load transfer devices across expansion and contraction joints may cause spalling when not placed perpendicular to the expansion joint and parallel to the surface of the pavement. Improperly formed joints and mislocated keyways may also cause spalling.

3.9 Joint Seal Damage. Joint seal damage is any condition that enables any solid material to accumulate in the joints, restrict proper joint movement, or allow significant water infiltration. Accumulation of incompressible materials prevents the slabs from expanding and may result in buckling, shattering, or spalling. A properly applied pliable joint sealant bonded to the edges of the joint will protect the joint from material accumulation and subsequent water infiltrations. Typical types of joint seal damage are:

- a) Stripping of joint sealant;
- b) Extrusion of joint sealant;
- c) Weed growth;
- d) Hardening of the sealant (oxidation);
- e) Loss of bond to the joint edges;
- f) Lack or absence of sealant in the joint.

3.10 Lane/Shoulder Drop Off. Lane/shoulder dropoff is the differential settlement or erosion of the shoulder at the pavement edge. This distress can be a severe safety hazard for vehicles which cross it. This distress can also cause increased water infiltration, loss of support at the pavement edge, and subsequent damage.

3.11 Large Patch and Utility Cuts. These patches include those that have a surface area greater than 5 square feet (0.46 square meter). A large patch is an area where the original pavement has been removed and replaced with a suitable repair material. The patches are usually constructed of concrete but may also be constructed of asphalt, epoxy, or other repair material. A utility cut is made to allow the installation of underground utilities. The causes of distress of these patches are the same as for any pavement; however, the most frequent problem is poor compaction of the backfill when filling the cut area.

Where a patch is made to correct a pavement distress, if the underlying cause of the distress cause is not corrected (i.e. the subgrade and/or base course), the patch will fail as the original pavement before it.

3.12 Linear Cracking (Longitudinal, Transverse, and Diagonal). Linear cracks can result from a number of individual causes or a combination of these causes. The principal causes include traffic, lateral contraction, or shrinkage of the concrete (particularly if the slab width to length ratio is improper or if a sawed longitudinal joint is not of sufficient depth), lateral warping or curling of the slab when subjected to heavy traffic loadings, loss of support under the edge of the slab due to nonuniform support, pumping, and the presence of expansive subgrade soils under the center of the pavement. Longitudinal cracking usually occurs in thin slabs without the benefit of a proper

longitudinal joints is found in pavements between transverse joints. The primary causes of transverse cracking are traffic, excessive joint spacing, and improperly cut contraction joints. Overloading and upward curled slabs combined with pumping are also possible causes.

3.13 Polished Aggregate. Polished aggregate is caused by repeated applications of traffic to a concrete with aggregates that are susceptible to polishing. Some aggregates such as certain limestones will wear rapidly and become very smooth when exposed to traffic. The traction between the vehicle tires and the pavement is considerably reduced by polished aggregate.

3.14 Popouts. The Mississippi watershed and especially the Ohio River Valley have problems with soft porous chert, other silicas, and some dolomites in the natural gravel normally obtained from streambeds. These materials are potentially reactive with alkalis in cement and are susceptible to the phenomenon known as "popouts." The cause of popouts is physical (absorption of water and freezing), chemical (alkali reactivity), or a combination of both. The aggregate will expand and fracture, leaving a hole in the surface of the pavement which may or may not require maintenance. Also treated as, but not true popouts, are cavities in PCC paving resulting from washout of clay balls and rotting of roots, sticks, wood, and other debris found in some concrete mixes.

3.15 Pumping. Pavement pumping is the forceful ejection of water by traffic from the base course and/or subgrade due to deflection of a pavement slab. This flow usually carries subgrade particles in suspension from beneath the slab and up through cracks, joints, and along pavement edges. Stains on the pavement surface adjacent to joints are usually evidence of pumping joints. Pumping is caused by an unfavorable combination of free water, subgrade material susceptible to pumping, and continuous use by traffic. The slab is forced downward under wheel loads, compressing any free water below the slab which forces the water and soil out through cracks and joints. Repetition of this pumping action displaces foundation materials and results in voids and cavities beneath the slab which leave the slab unsupported and subject to cracking. Nonplastic coarse grained soils such as sands and gravels are practically free from pumping because the soil grains are larger and less susceptible to transport when the water is forced out. Clays, silts, and some fine sands are susceptible to pumping. Good surface drainage, subdrains, and sealed joints reduce the probability of free water accumulation that contributes to pumping.



During construction, provisions for a granular base or filter course immediately under the concrete slab will eliminate or minimize the probability of pumping. The use of stabilized layers (asphalt or portland cement) beneath the PCC pavement will also reduce the occurrence of pumping.

3.16 Punchout. A punchout is a localized area of a slab that is broken into pieces. This distress is usually defined by a crack and a joint or two closely spaced cracks (usually 5 feet (1.52 m) apart). It is caused by heavy repeated loads, inadequate slab thickness, loss of foundation support, and/or localized concrete construction deficiencies (e.g. honeycombing).

3.17 Railroad Crossing Distress. Railroad crossing distresses are characterized by depressions or bumps around the tracks. These distresses are usually a construction defect which causes an uneven surface and poor ride quality. When railroad crossing distresses are not directly related to the original construction, they should be classified into one of the other distresses categorized in this section.

3.18 Scaling. Scaling is the progressive disintegration and loss of the concrete wearing surface. The major causes of scaling are the physical and chemical reactions of deicing materials in the presence of repetitive freeze-thaw or wet-dry cycles, a weakened surface created by improper mixing, improper curing or overfinishing, or the use of unsuitable aggregates in the mix. Extensive scaling most commonly occurs at locations heavily treated with deicing chemical such as on hills, curves, bridge decks, or near intersections. Scaling is seldom seen in high quality portland cement concrete where severe frost action does not occur. Scaling may be reduced to a minimum by entraining 4 to 7 percent air in the concrete mix.

3.19 Shrinkage Cracks. Shrinkage cracks often result from stresses caused by contraction or warping of the pavement. Poor jointing arrangements and/or inadequate curing contribute to excessive contraction movement prior to attainment of the design strength in new concrete.

3.20 Small Patching. Small patches are those less than 5 square feet (0.46 square meter) in area. As with a large patch, an area where the original pavement has been removed and replaced with a repair material.

Detailed distress identification criteria and repair alternatives can be found in NAVFAC Manual MO-102.2 for vehicular pavements and in NAVFAC Manual MO-102.4 for airfield pavements.

## Section 4: FULL DEPTH REPAIR OF PAVEMENTS

4.1 Purpose of Full Depth Repair. When normal maintenance procedures can no longer adequately correct effects of ordinary pavement wear or use, full depth repair may become necessary to restore damaged areas to their original condition. Full depth repairs are generally necessary when slabs have been shattered or have deteriorated to such an extent that the safe support of the required load is no longer possible (Figure 1).

4.2 Need for Full Depth Repair. There are several types of distress that occur at or near transverse joints which may require full depth repair when classified as medium or high severity level distress. Comprehensive distress manuals (NAVFAC Manual MO-102.2 for vehicular pavements and NAVFAC Manual MO-102.4 for airfield pavements) are available which define distress and severity levels.

Types of distress that occur in rigid pavements which may justify full depth repair when classified as medium or high severity distresses include:

- a) Blowup;
- b) Corner break;
- c) Durability "D" cracking;
- d) Patch deterioration;
- e) Shattered slab;
- f) Spalling;
- g) Punchout;
- h) Railroad crossing distress.

Many rigid pavements are also subject to spalling and faulting at intermediate cracks. This deterioration may be caused by repeated heavy traffic loads, failure of doweled joints to function properly, and/or the intrusion of incompressible materials in the open cracks.

4.3 Selection of Repair Boundaries. At the onset, it is recommended that a detailed survey be done to accurately delineate the required repair areas so that all significant underlying distresses are found. Quite often, and particularly in freeze-thaw climates, the deterioration near joints and cracks is greater at the bottom of the slab than is apparent from the top of the slab (Figure 2).

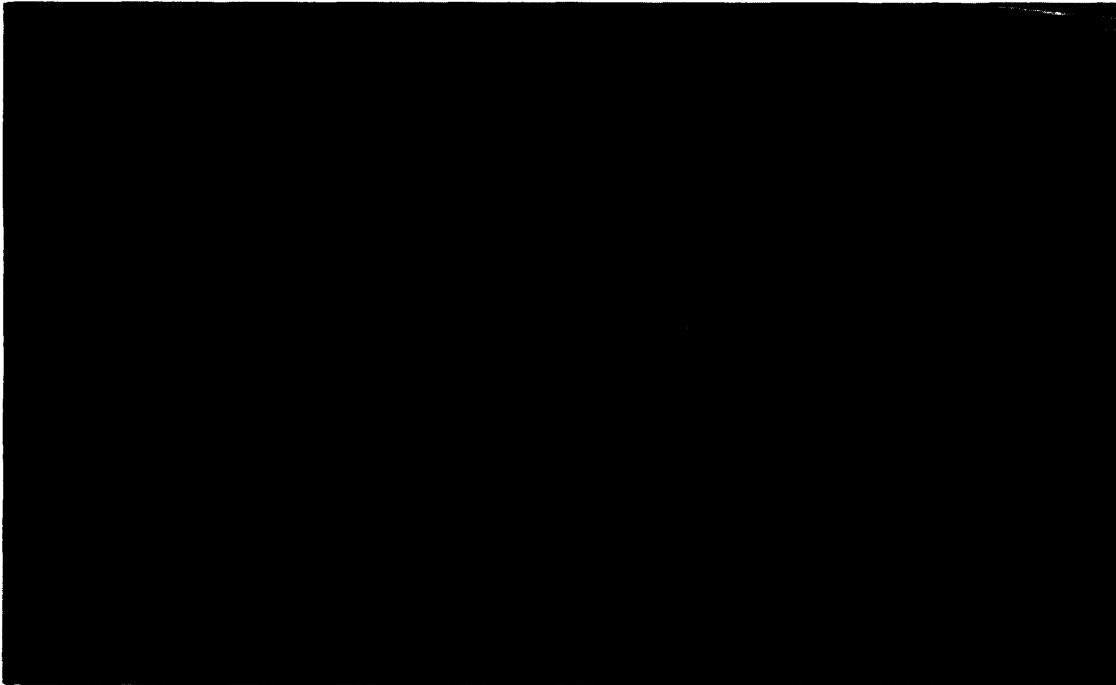

Figure 1  
Example of Shattered Slab

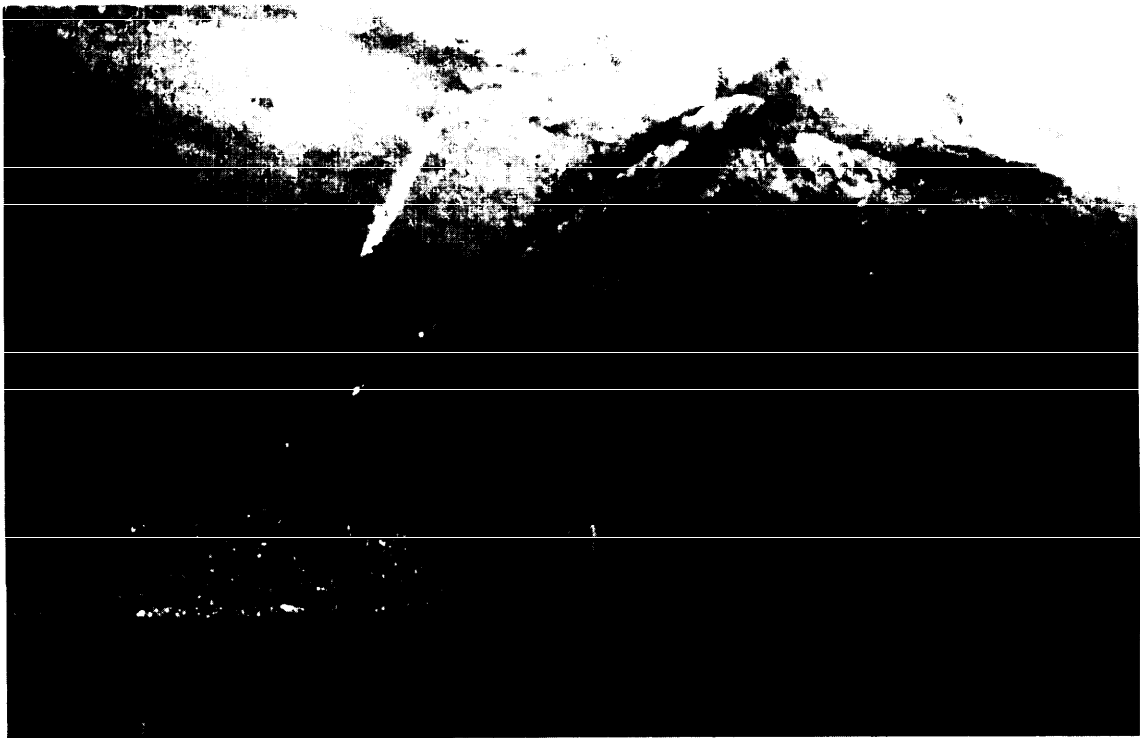

Figure 2  
Example of Deterioration at Joint, Bottom of Slab

In both plain jointed and reinforced jointed concrete pavement, partial slab patching is acceptable where the distresses are within one-half of the slab width. Full width slab patching is required where distresses exceed one-half the slab width. A minimum slab length is required to avoid rocking and pumping of the repair. The general experience indicates that 6 feet (1.83 m) in length is a minimum when load transfer is provided. A minimum of 4 feet (1.22 m) in length has performed satisfactorily but has also shown significant problems under heavy traffic. The recommended minimum patch dimensions are:

a) Where patch is doweled, tied, or undercut for load transfer along transverse joints, 4 feet (1.22 m) minimum length, and not less than one-half the slab width.

b) Where patch is not doweled, tied, or undercut along transverse joints, 6 feet (1.83 m) minimum length for low traffic areas, 8 to 10 feet (2.44 to 3.05 m) minimum length for high traffic areas, and not less than one-half the slab width.

The patch boundaries should not be too close to an existing transverse joint or crack or adjacent slab distress will occur. Recommended guidelines are:

a) Tight non-working joint or crack (a joint or crack which is not opening or closing) containing reinforcing steel should not have a repair within 3 feet (0.91 m).

b) Working joint or crack (a joint or crack which opens and closes from temperature changes) with or without reinforcing steel should not have a repair within 6 feet (1.83 m). The patch boundaries should be extended to include working cracks spaced closer than 6 feet (1.83 m).

4.4 Sawing of Repair Boundaries. The repair boundaries of mesh reinforced, plain doweled, and plain jointed concrete pavement are typically provided by diamond blade sawing (Figure 3). Sawing is the recommended method. Air hammers should not be used. The rough joint formed by air hammers typically spalls in service and causes difficulties in lifting out the concrete within the repair boundaries.

4.4.1 Partial Depth. The partial depth saw cut does provide some aggregate interlock due to a rough face, but the bottom of the slab may spall when using a large pavement breaker to shatter the concrete within the repair boundaries (Figure 4). If this occurs, the saw cut must be made deeper, the size of the pavement breaker should be limited, and the pavement breaker should not be used in the immediate joint area.

4.4.2 Full Depth. The full depth saw cuts will completely separate the concrete that is to be removed leaving vertical faces and eliminating unwanted damage at the bottom of the slab; however, it will not provide adequate aggregate interlock for the patch. Where aggregate interlock is required (utility cuts or low traffic areas), an additional partial depth saw cut at least 25 percent of the slab thickness is made approximately 2 inches (50 mm) outside the full depth saw cut (Figure 5). A light hammer should be used to chip the joint face to the outer saw cut. It is important that chipping does not undercut the outer partial depth saw cut.

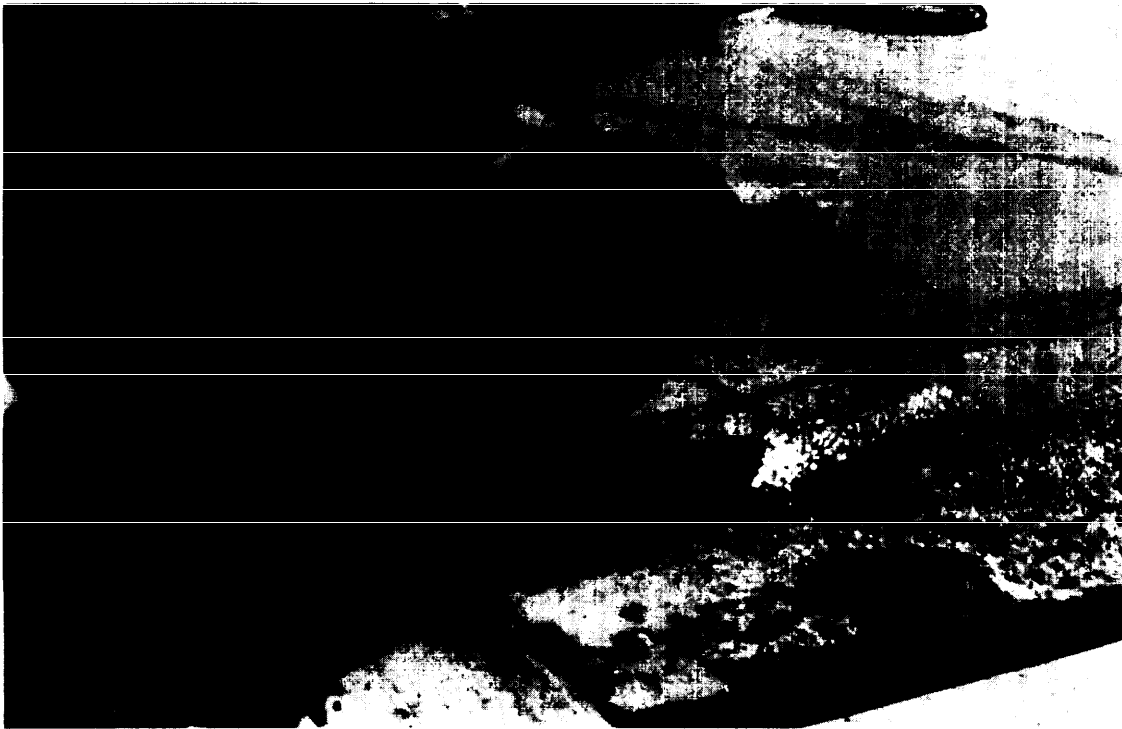

Figure 3  
Example of Sawing Repair Boundary Limits

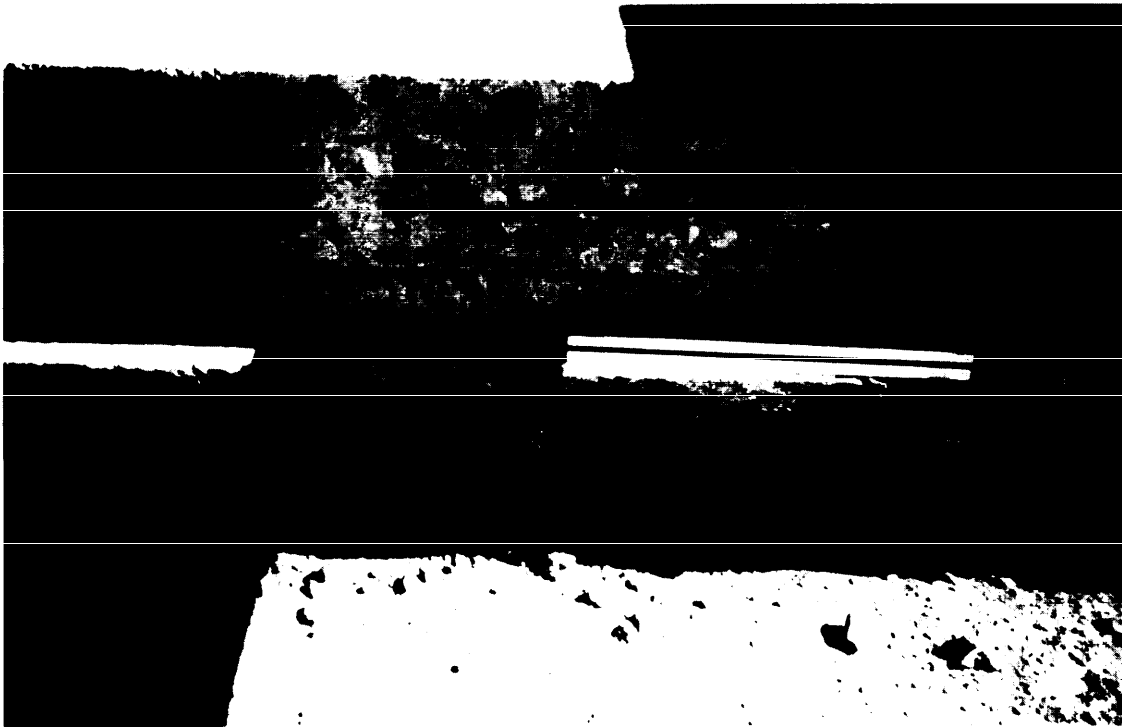

Figure 4  
Example of Spalling at Bottom of Slab Caused by Pavement Breaker

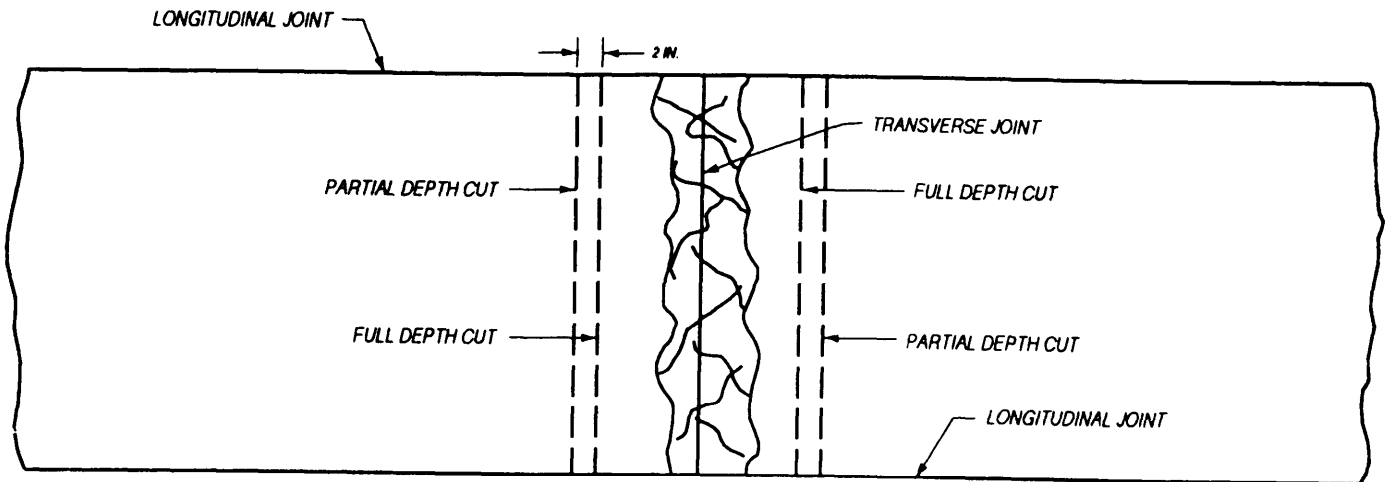

Figure 5  
Plan View of Saw Cuts for Aggregate Interlock



The repair boundaries of continuously reinforced concrete pavement are provided by sawing full depth at the repair boundaries. Partial depth saw cuts above the reinforcing steel are then provided at a distance required by the lap length of the reinforcement (Technical Manual TM 5-825-3/AFM 88-6, Chapter 3) from the repair boundaries (Figure 6). The partial depth saw cuts should be located at least 18 inches (457 mm) from the nearest tight crack and should not cross an existing crack. Should any of the reinforcing steel be cut while sawing, the repair area must be increased by the required lap length of the reinforcement.

4.5 Removal of Existing Concrete. Procedures used for removal must not spall or crack adjacent concrete or significantly disturb the base or subgrade. There are two basic methods to remove the existing mesh reinforced, plain doweled or plain jointed concrete pavement.

4.5.1 The Breakup and Cleanout Method. This is normally accomplished using a pavement breaker with removal by a backhoe (Figure 7). This method usually disturbs the base requiring replacement or filling with concrete and also has the potential to damage the adjacent slab if proper sawing procedures are not followed. After the repair area is isolated by full depth saw cuts, additional saw cuts are made within the repair area, parallel and approximately 1 foot (0.31 m) from each perimeter saw cut or joint (Figure 8). Breakup should begin in the center of the removal area within the inner saw cuts. After breakup of the inner area, the pavement breaker can then be used to tap the outer region free of the adjacent slab.

4.5.2 The Lift Out Method. This is normally accomplished using a crane or front-end loader to lift the deteriorated concrete from its position (Figure 9). This method does not generally disturb the base or damage the adjacent slab. After the repair area is isolated by full depth saw cuts, holes are drilled through the slab and fitted with lift pins; the slab is then lifted in one or more pieces. During hot weather, the sawing equipment may bind during initial transverse sawing procedures. It may be necessary to perform sawing at night when the temperatures are lower and the slabs are contracting. Another solution is to use a carbide-tipped wheel saw to provide a pressure relief cut within the patch area prior to boundary sawing (Figure 10). It is strongly recommended that the wheel saw cut be made no closer than 6 to 8 inches (152 to 203 mm) from the proposed patch boundary due to damage and microcracking that this type of saw can impart on adjacent concrete.

The same procedures may be used for the removal of continuously reinforced concrete. Concrete in the two reinforcing lap areas must be carefully removed so as not to damage the reinforcing and to avoid spalling of the concrete at the bottom of the joint.

4.6 Subgrade and Base Preparation. After the deteriorated concrete has been removed, the surface should be examined. All disturbed material should be removed and the patch area compacted (Figure 11). If excessive moisture exists in the repair area, it should be removed or dried before replacing.

It is difficult to adequately compact granular material in a confined area, which may result in settlement of the patch. Replacing some or all disturbed base material with lean concrete or flowable fill may be the best alternative.

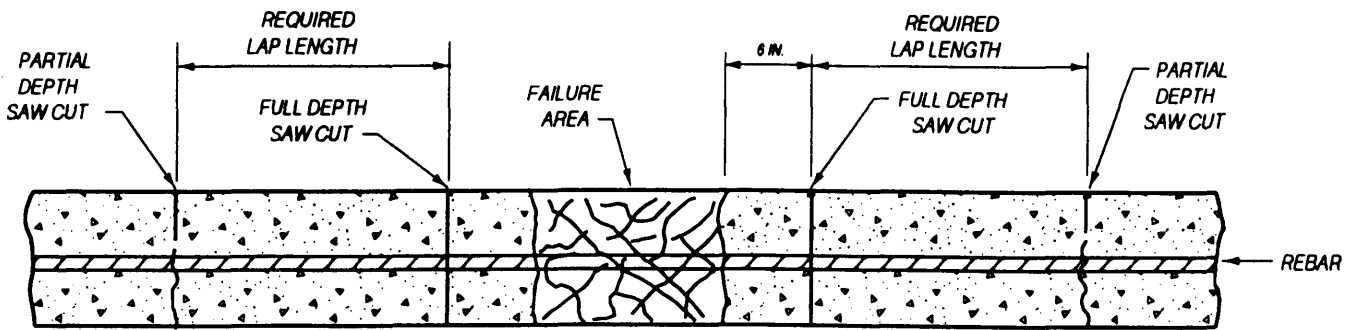

Figure 6  
Section View of Saw Cuts for Reinforced Pavement

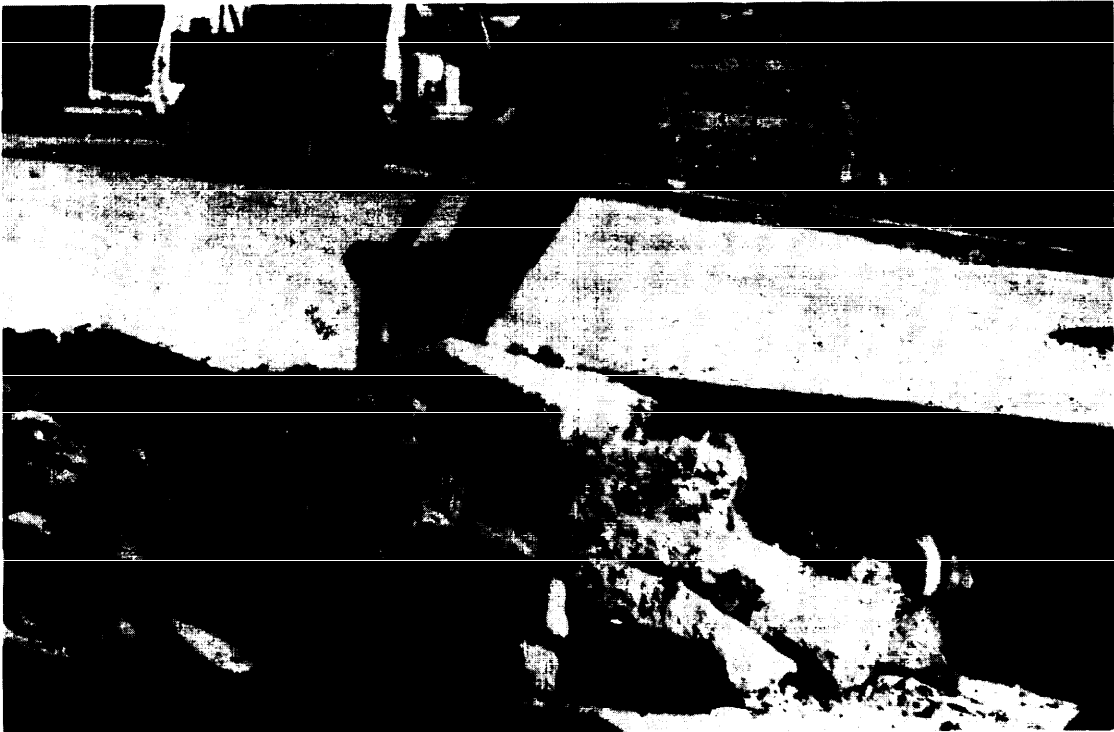

Figure 7  
Example of Concrete Removal Using a Backhoe

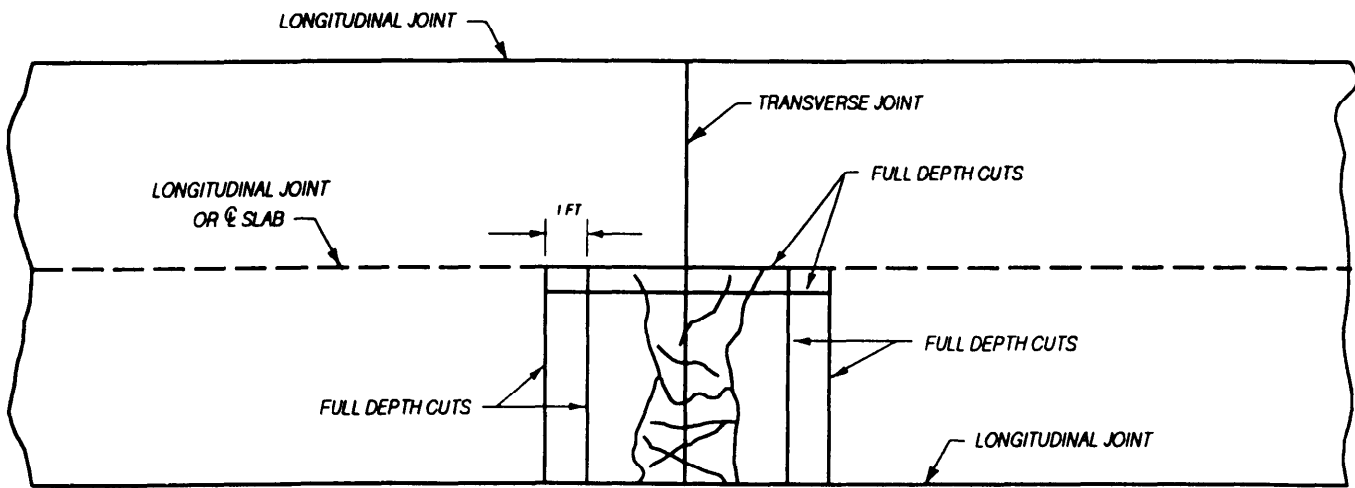

Figure 8  
Plan View of Saw Cuts for Breakup Method

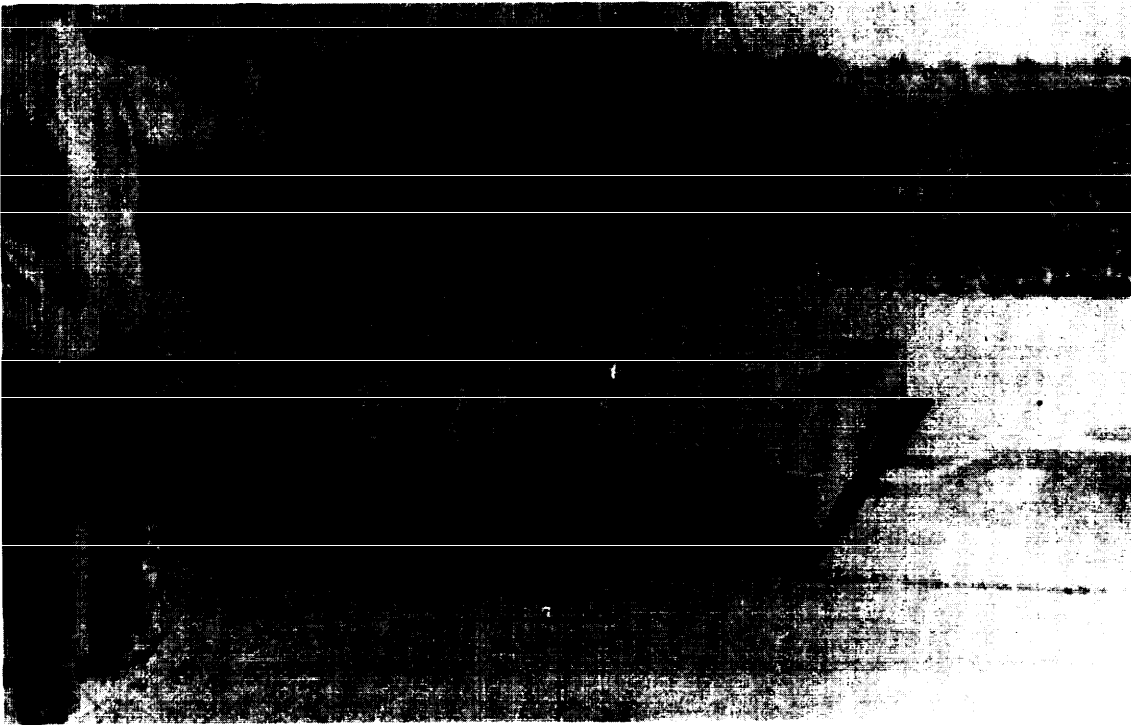

Figure 9  
Example of Concrete Removal Using the Lift-Out Method

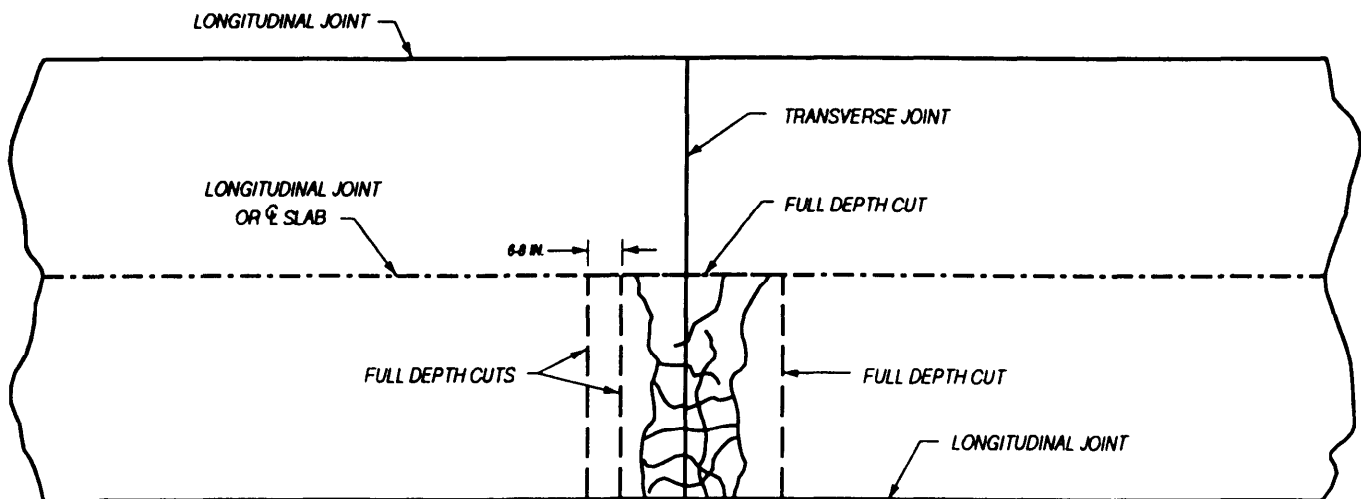

Figure 10  
Plan View of Saw Cuts for Lift-Out Method

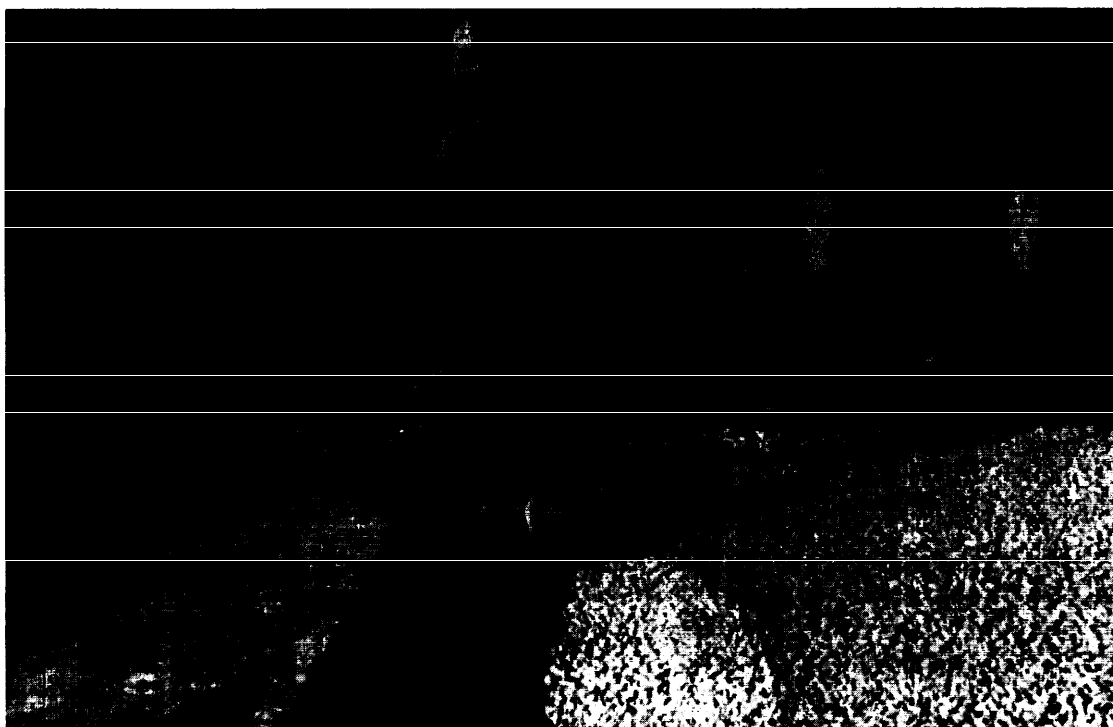

Figure 11  
Example of Recompacting Base in Repair Area

4.7 Dowel and Tiebar Placement. In repair of jointed concrete pavements, good load transfer across the transverse repair joints appears to be the most critical factor affecting full depth repair performance and best achieved by properly installing dowel bars of sufficient size and numbers. Both smooth steel dowels (Figure 12) and deformed reinforcement (Figure 13) can be provided in the patch joint. This is accomplished by drilling holes at specified locations into the exposed face of the existing slab; equipment is available to drill multiple holes at the same time (Figure 14). The holes should be drilled by placing the drills in a rigid frame that prevents the drill bit from wandering and holds it in a horizontal position and at the correct height. The holes should be drilled approximately one-half the dowel bar or tie bar length. Hole diameters exceeding the bar diameter by 0.25 inch (6 mm) are recommended when using a cement grout. Hole diameters exceeding the bar diameter by 0.0625 inch (1.6 mm) or less are recommended when using premixed epoxy mortar materials.

4.7.1 Grouting. Care must be exercised in grouting or epoxying dowels or tie bars to ensure complete coverage and support of the device. Grout retention devices that fit tightly over the dowel or tie bar and effectively seal the hole preventing the grout or epoxy from running out of the hole, should be used.

4.7.2 Smooth Steel Dowels. Smooth steel dowels are provided in concrete pavement slabs to transfer loads to adjacent slabs and to help maintain the alignment of adjoining slabs. Dowels are placed in joints that are intended to accommodate movement of the adjoining slabs. When using dowels, the end that extends into the repair area should be painted and oiled to prevent bonding with the patch material. Dowels used at expansion joints should be capped at one end, in addition to painting and oiling, to permit further penetration of the dowels into the concrete when the joints close.

4.7.3 Deformed Tie Bars. Deformed tie bars have surface ridges which provide a locking anchorage with surrounding concrete. Tie bars are placed in joints that are not intended to have movement, such as the patch/slab interface.

4.7.4 Other Methods. Other methods of providing load transfer include aggregate interlock and undercut or inverted tee repairs. These types of load transfer systems have been subject to widespread premature failure due to frost heave, rocking and faulting, and have been the source of much reflective cracking in asphalt concrete overlays. It is recommended that these systems only be used in dry climates, on stabilized base materials, and/or under low volumes of heavy traffic.

4.8 Replacing Reinforcement. Successful performance of continuously reinforced concrete pavements requires good load transfer across all transverse cracks and repair joints. Failure to do so and to carry the longitudinal reinforcing steel through the repair will cause the repair and the surrounding pavement to fail as the cracks in the vicinity open. The longitudinal reinforcing is generally carried through these repairs by careful removal of the old concrete to allow the appropriate length of steel (lap length) from the existing pavement to extend into the repair area. This steel is then tied, welded, or mechanically connected to additional reinforcing steel that extends through the repair area.



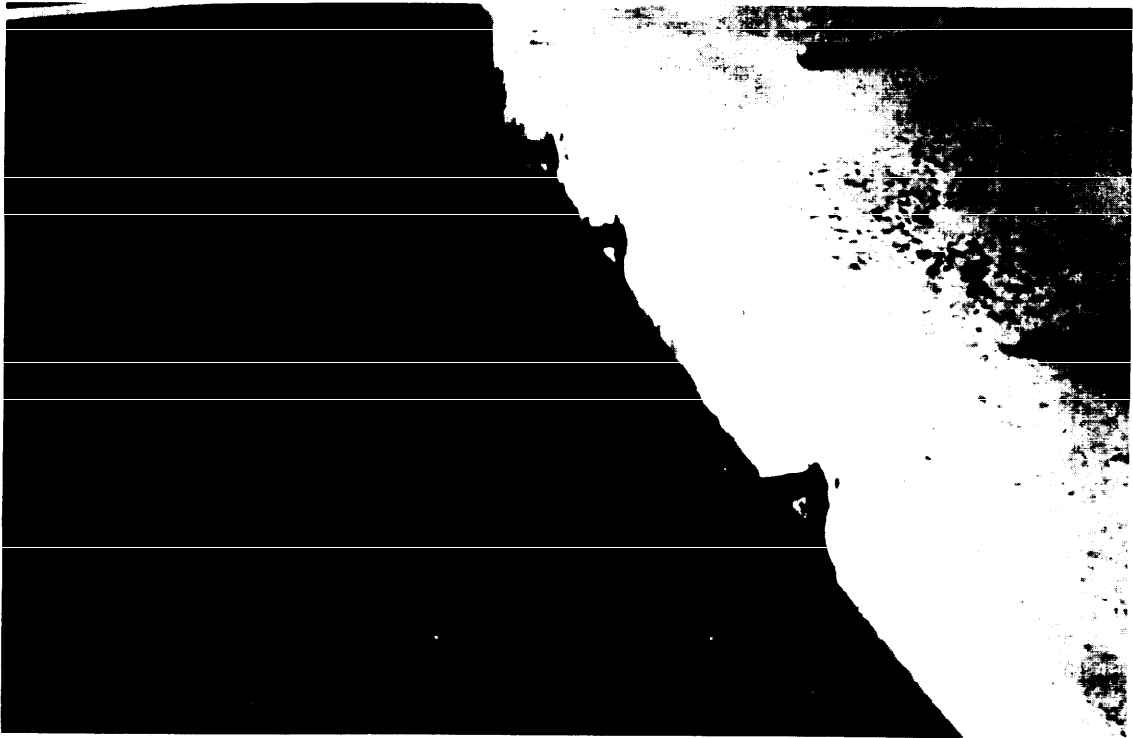

Figure 12  
Example of Installed Smooth Steel Dowel Bars



Figure 13  
Example of Installed Deformed Steel Tie Bar

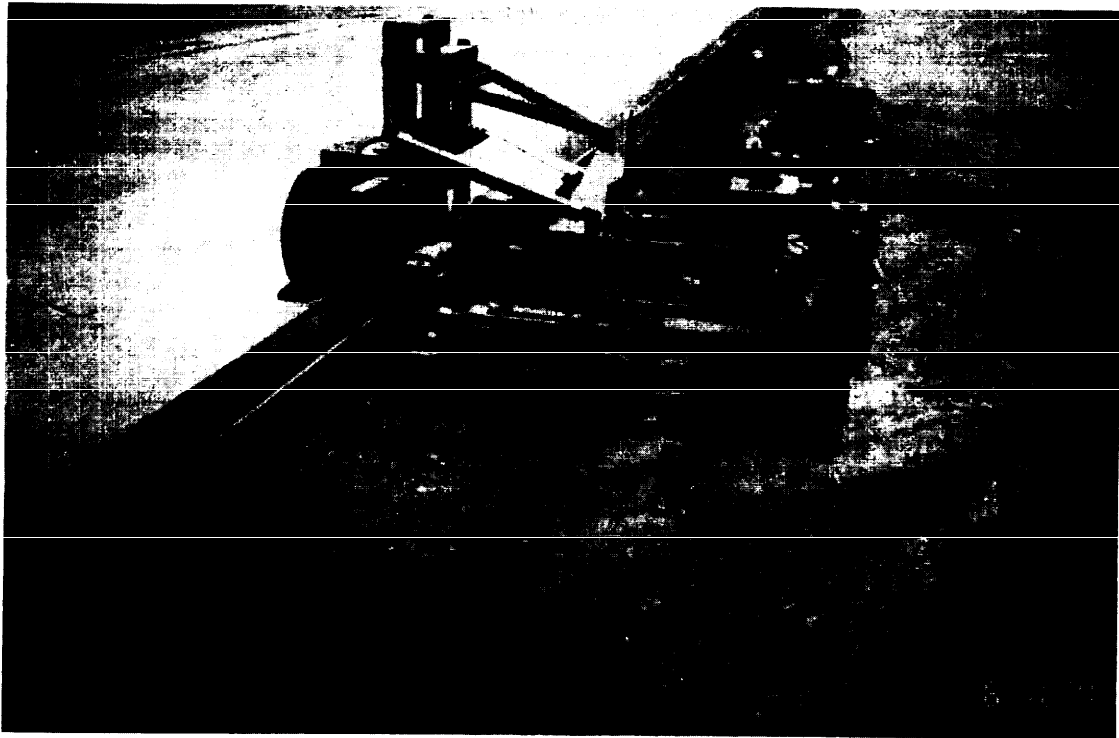

Figure 14  
Example of Gang Drill

When replacing reinforcing in the patch area, the type of bars should match the original in grade, quality, and number. The new bars should be placed on bar supports to ensure proper position and cover; they should not extend closer than 2 inches (50 mm) to the patch/slab interface. Tied splices should be lapped the proper length (TM 5-825-3/AFM 88-6 Chap. 3) to provide full bar strength.

Welded splices should be of the proper length for the welding procedure chosen and should be lapped at the center of the repair area to avoid the potential buckling of bars on hot days (Figure 15).

4.9 Expansion Joints. Expansion joints are placed in concrete pavements to provide relief for expansion due to temperature changes. Generally, expansion joints are installed at all intersections of pavements with structures and may be required within the pavement features. Expansion joints may be required if full depth repairs are made during cool weather when adjacent concrete is in a contracted state; crushing and spalling of concrete at the joints may occur during subsequent hot weather when the concrete expands.

Expansion joints in pavements are difficult to construct and maintain, and they often contribute to pavement failures. Their use should be kept to the absolute minimum necessary to prevent excessive stresses in the pavement from expansion of the concrete or to avoid distortion of a pavement feature through expansion of an adjoining pavement. The types of expansion joints are the thickened-edge (Figure 16), the thickened-edge slip joint (Figure 17), and the doweled type (Figure 18). Longitudinal expansion joints within pavements should be of the thickened-edge type. Dowels are not recommended in longitudinal expansion joints because differential expansion and contraction parallel with the joints may develop undesirable localized strains and possibly failure of the concrete, especially near the corners of slabs at transverse joints.

A special expansion joint required at pavement intersections is the thickened-edge slip joint. The thickened-edge slip joint is normally the best suited expansion joint to surround or separate from the pavement any structures that project through, into, or against the pavement, such as at the approaches to buildings or around drainage inlets and hydrant refueling outlets. Dowels are not used in slip joints. Transverse expansion joints within pavements should be of the doweled type. However, there may be instances when it is desirable to allow some slippage in the transverse joints, such as at the angular intersection of pavements to prevent the expansion of one pavement from distorting the other. In these instances, the design of the transverse expansion joints should be similar to the thickened-edge slip joints.

4.10 Filler Material. Filler material for the thickened-edge and doweled-type expansion joint should be a nonextruding type. The type and thickness of a filler material will depend upon the particular case. Usually a preformed material of 3/4 inch (19 mm) will be adequate, but in some instances a greater thickness may be required. Filler material for slip joints should be either a heavy coating of bituminous material not less than 1/16 inch (2 mm) in thickness when the joints match or normal nonextruding type material not less than 1/2 inch (13 mm) in thickness when joints do not match.

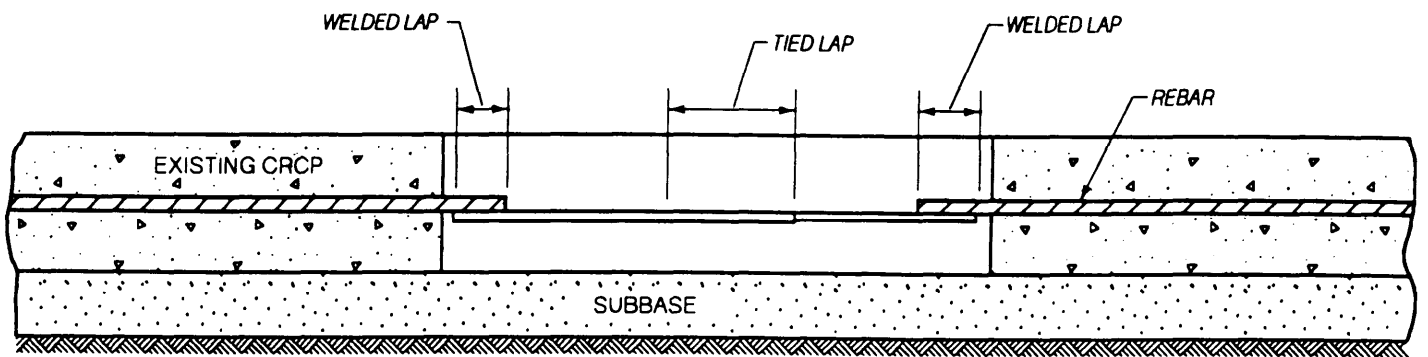

Figure 15  
Section View of Welded Reinforcing Installation

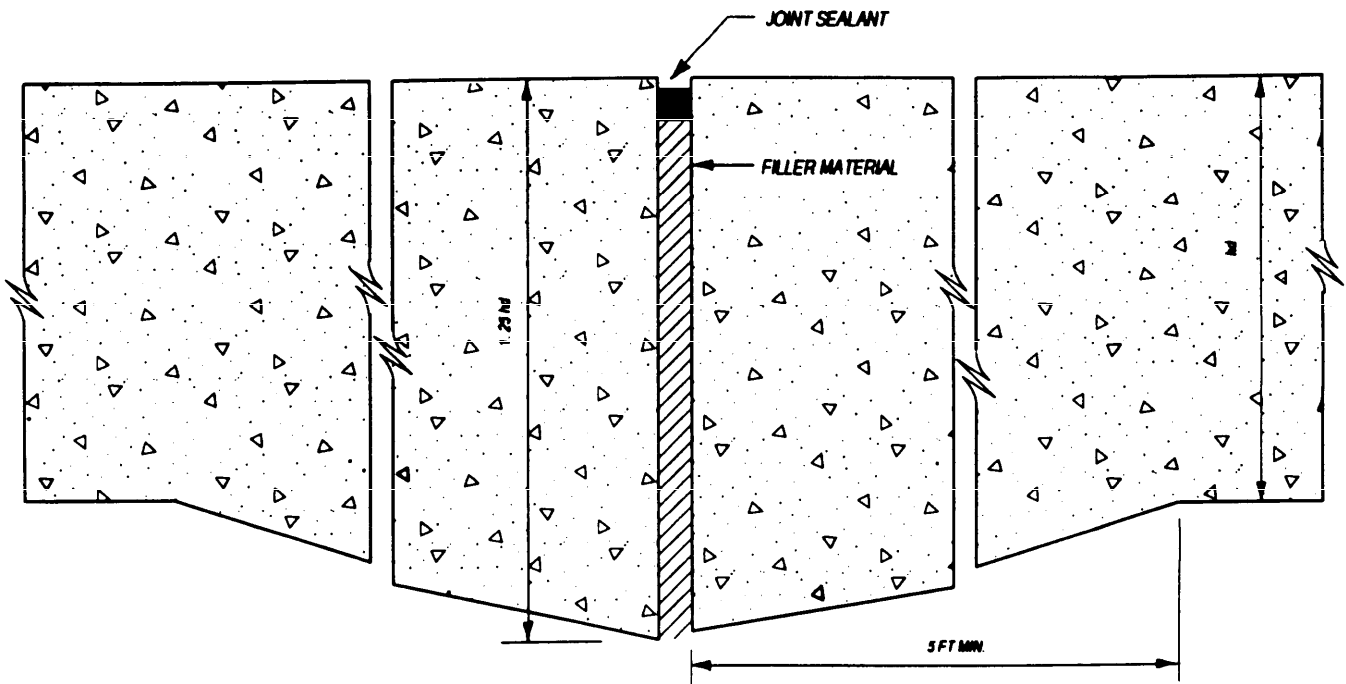

Figure 16  
Section view of Thickened-Edge Expansion Joint

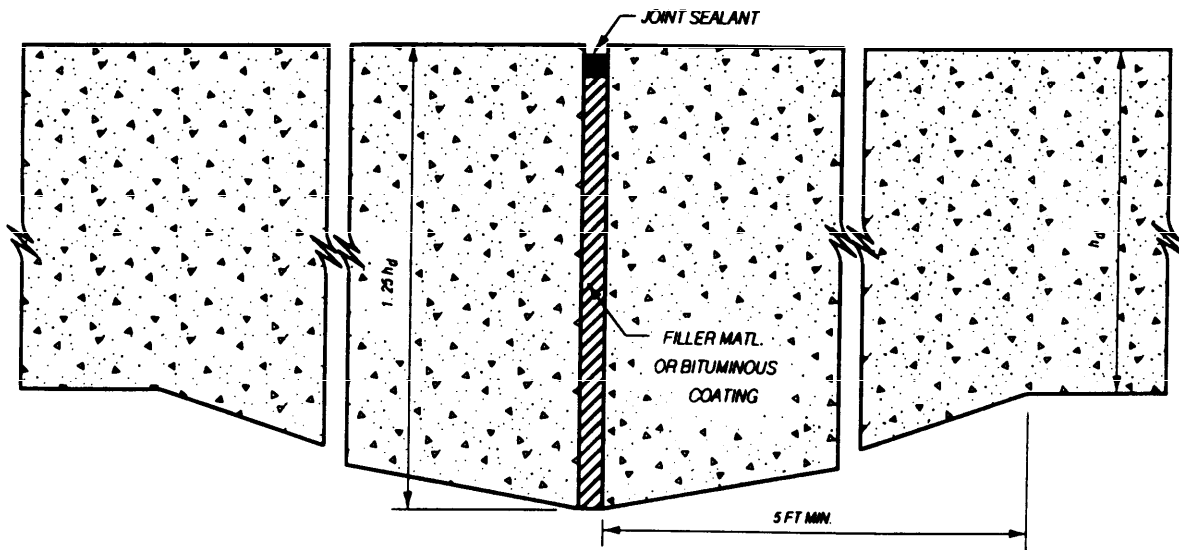

Figure 17  
Section view of Thickened-Edge Slip Joint

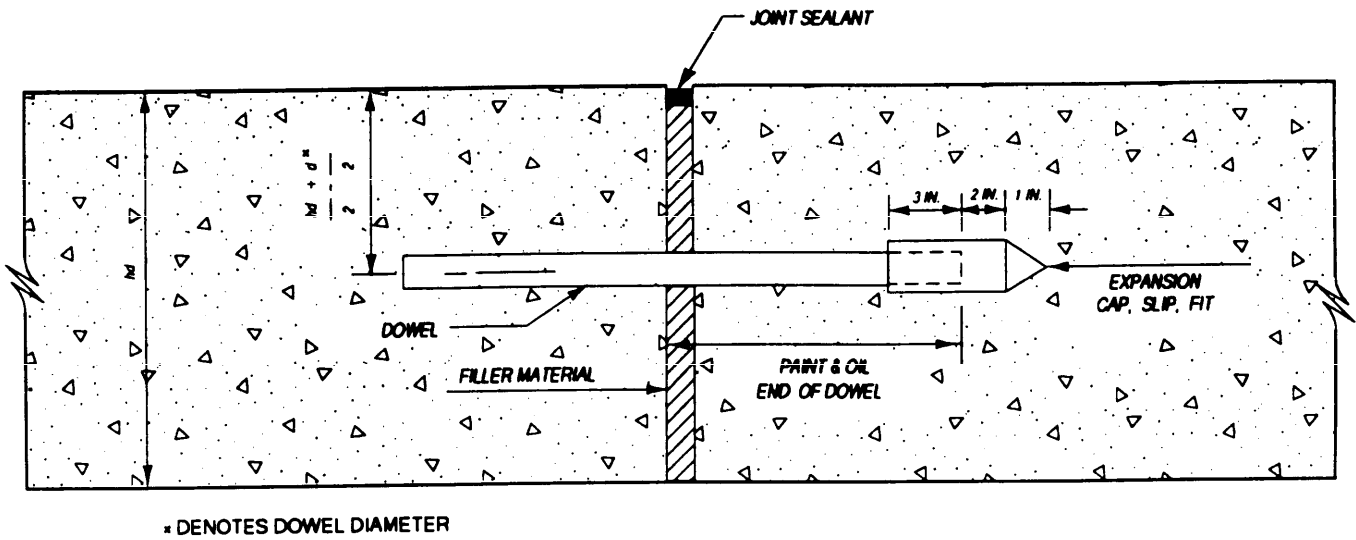

Figure 18  
Section view of Doweled-Type Expansion Joint



4.11 Dowels. Expansion joints where dowels are used require that the dowels be securely and accurately placed. The nonextruding filler material should be drilled or punched to the exact diameter and at the location of the dowels. It should be furnished in lengths equal to the width of the placement. Where more than one length is used in a joint, the abutting ends of the filler should be held in alignment. It should be held firmly in place and extend downward to the bottom of the slab; the top edge should be held about 1/2 inch (13 mm) below the surface of the pavement. The top edge of the filler material should be protected while the concrete is being placed.

The important functions of dowels or any other load-transfer device in concrete pavements are to:

- a) Help maintain the alignment of adjoining slabs.
- b) Limit or reduce stresses resulting from loads on the pavement.

Different sizes of dowels should be specified for different thicknesses of pavements. (See Section 10).

4.12 Concrete Placement. The concrete mixture selected depends on the available curing time before the repair area is opened to traffic. If it is acceptable for the concrete to cure for several days (similar to new construction), regular paving mixtures can be used. If earlier opening times such as 1 to 3 days are needed, high early strength portland cement concrete, usually using Type III cement can be used, or the cement content should be increased, minimal mixing water used, and an accelerator added. The concrete placement techniques should follow standard procedures. Extra attention should be given to ensure that the concrete is vibrated well around the edges and beneath the reinforcement. Where new concrete is to be bonded, all exposed concrete faces should be cleaned by sandblasting. Temperatures for the concrete placement should be between 40 and 90 degrees Fahrenheit (4.4 and 32.2 degrees Centigrade).

Rapid set proprietary cementitious materials are available that attain sufficient strength for traffic in as little as 4 hours. Rapid set proprietary patching materials should be used in compliance with the manufacturer's recommendations--this includes bonding, placing, time required before opening to traffic, and temperature ranges.

4.13 Concrete Finishing and Texturing. Finishing techniques should follow standard procedures. For repairs less than 12 feet (3.66 m) in length the surface of the concrete should be struck off with the screed parallel to the center line of the pavement (to follow any ruts in the existing pavement). For repairs more than 12 feet (3.66 m) in length the surface should be struck off with the screed perpendicular to the center line of the pavement. Extra attention should be given to ensure that the concrete is not overfinished.

Before the concrete becomes non-plastic, the surface should be given a burlap drag or broom finish to approximately match the surface finish of the existing adjacent concrete pavement, unless a grinding operation is to follow.

4.14 Curing. Wet burlap, impervious paper or pigmented membranes can be used for curing the repair area. They should be applied as soon as the concrete has set sufficiently for application without damage.

4.15 Joint Sealing. One additional feature that has been found to improve the performance of jointed concrete placement repairs is the sealing of the repair joints. This reduces the entry of water, which may cause pumping and faulting, and reduces the incidence and severity of spalling.

The transverse and longitudinal joint sealant reservoirs at the repair area may be formed or sawn. It is recommended that the reservoir be a minimum of 2 inches (50 mm) deep to avoid point to point bearing at the top of the patch surface and reduce the potential for spalling. However, the reservoir shape factor (width to depth ratio) should be designed consistent with the joint spacing and sealant type.

The longitudinal joint should also be sealed to reduce spalling and water infiltration. A bond-breaking material such as fiberboard, placed along the joint face, will prevent bonding of the patch and reduce the potential for spalling.

## Section 5: PARTIAL DEPTH REPAIR OF PAVEMENTS

5.1 Purpose of Partial Depth Repair. The purpose of partial depth repairs is to correct localized areas of concrete pavement distress. Repair of this type restores rideability, deters further deterioration, reduces foreign object damage (FOD) potential, and provides proper edges so joints can be effectively resealed.

5.2 Need for Partial Depth Repair. Partial depth repair is typically used to repair spalling either at pavement joints (Figure 19) or at midslab locations. Generally, joint spalling occurs when unsealed joints are filled with incompressibles preventing movement of the slab in hot weather and results in breakage of the concrete. Other causes of spalling at joints include keyway failures (of oversized, poorly designed keyways), poor construction, poor repairs, dowel bar lockup, improperly located dowels, and dowels in reamed out sockets. "D" cracking can also be a major cause of spalling at joints. Spalling at midslab is generally caused by reinforcement that is too close to the surface or by foreign matter in the original PCC.

Spalls create a rough ride and can accelerate deterioration. Spalling is typically a localized distress and therefore warrants a localized repair.

If several severe spalls are present on one joint, it may be more economical to place a full depth repair along the entire joint than to repair individual spalls.

5.3 Selection of Repair Boundaries. Prior to commencement of work, a survey to determine areas of unsound or delaminated concrete should be made to establish the repair boundaries. During the survey, all areas of unsound concrete or delamination should be determined using a sounding technique. Sounding the pavement to find delamination and spall removal areas is accomplished by striking the existing concrete surface with a steel rod or carpenter's hammer. Delaminated or unsound concrete will produce a dull or hollow sounding thud, while a sharp metallic ring will indicate sound concrete.

The repair boundaries should be extended beyond the detected delaminated or spalled area by 3 times the aggregate size if known, 2 inches (50 mm) minimum if not known to assure removal of all unsound concrete (Figure 20). The repair boundaries should be kept square or rectangular to avoid irregular shapes. Irregular shapes may cause cracks to develop in the repair material. If repair areas are closer than 24 inches (609 mm) apart, they should be combined. This will help reduce costs and eliminate numerous small patches. The actual construction of the concrete repair should comply with the Department of the Navy, Naval Facilities Engineering Command Guide Specifications (NFGS),

NFGS-02564, "Patching of Rigid Pavement Partial Depth."

The following details of spall and popout repairs were extracted from NFGS-02564 (Figures 21 through 26 and Notes a-k).

a) Approximate location, length (L), and width (W) of each spall repair are shown on joint layout drawings. Exact location and dimensions shall be determined and marked in the field and approved as specified.

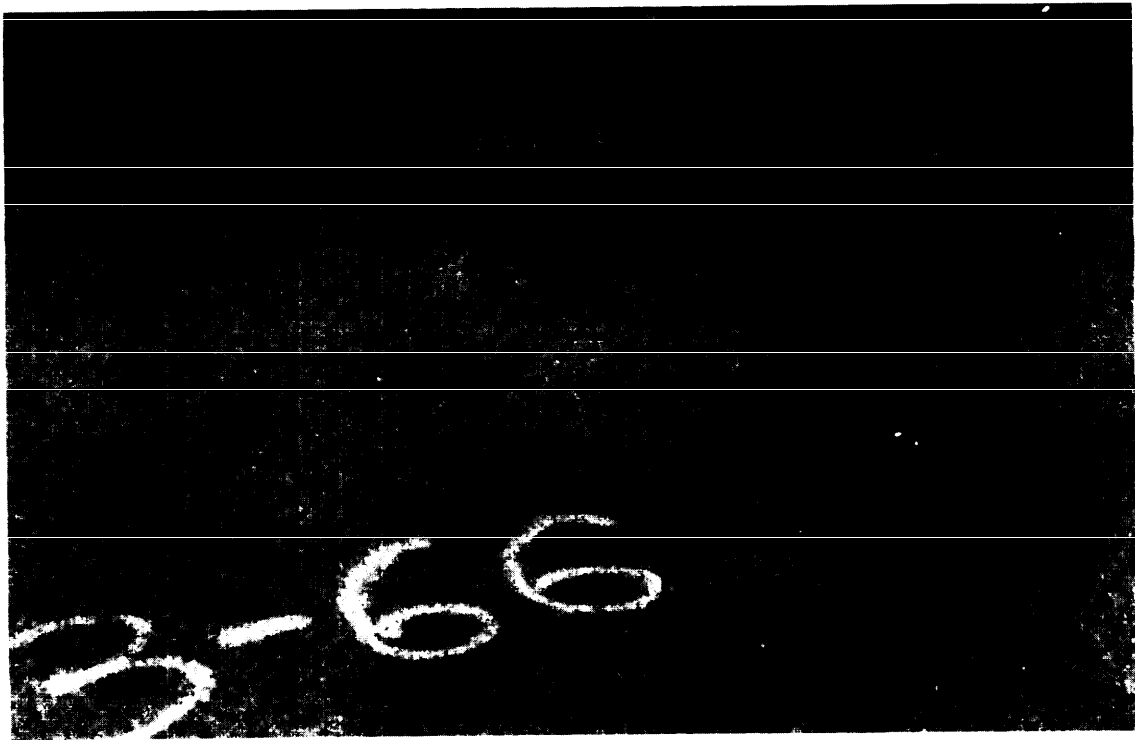

Figure 19  
Example of Spalling at a Joint

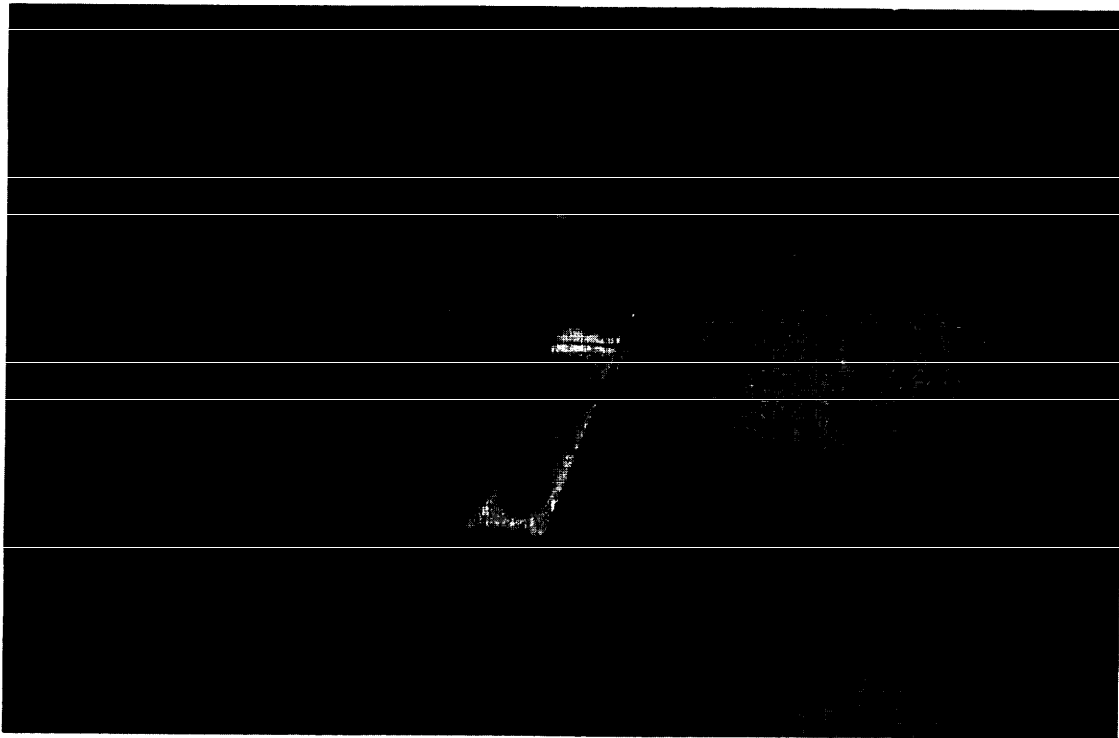

Figure 20  
Example of Sawn Repair Boundaries at a Joint Spall

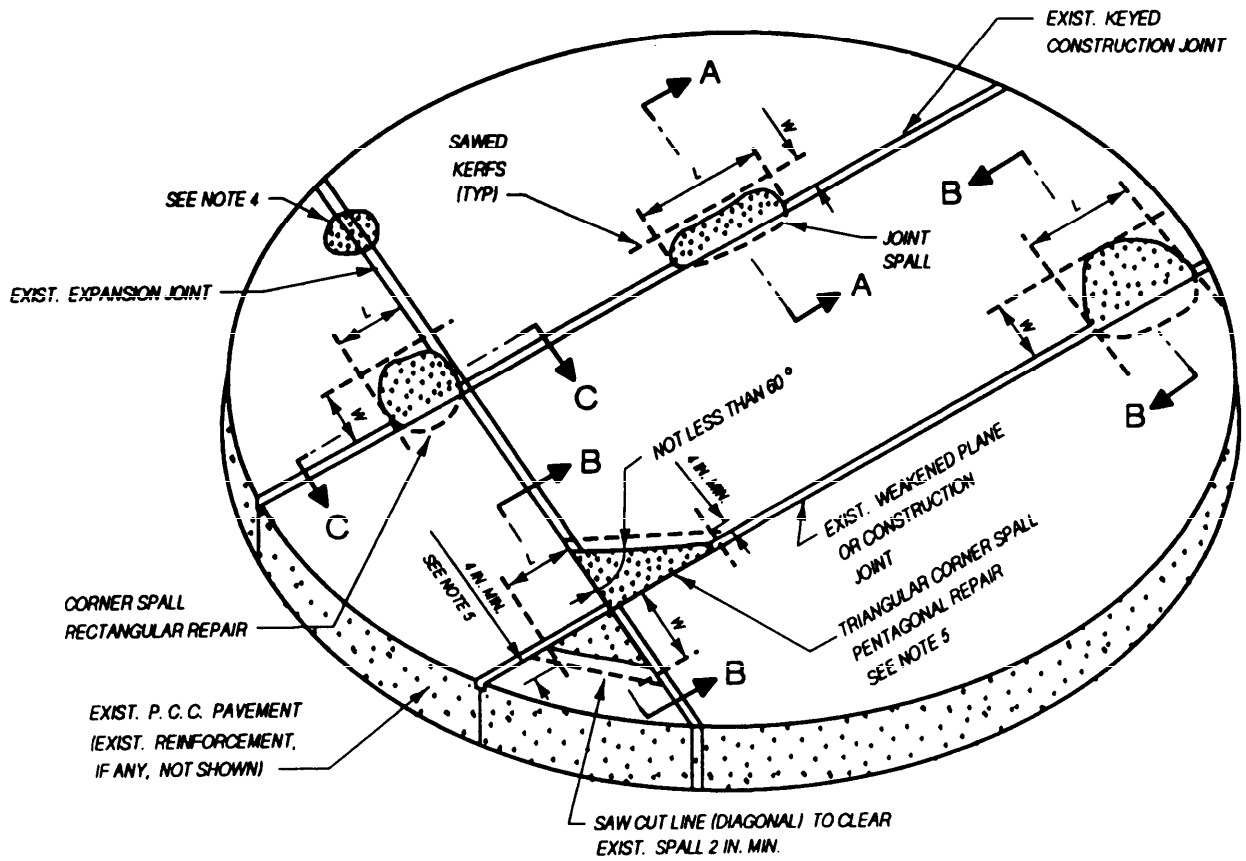

Figure 21  
Plan of Spall Repairs

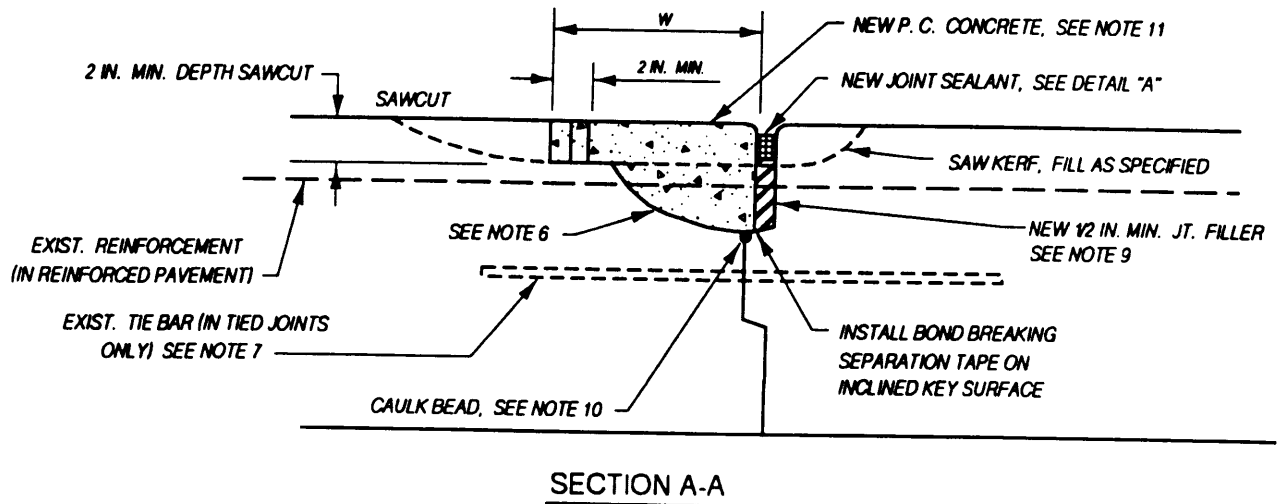
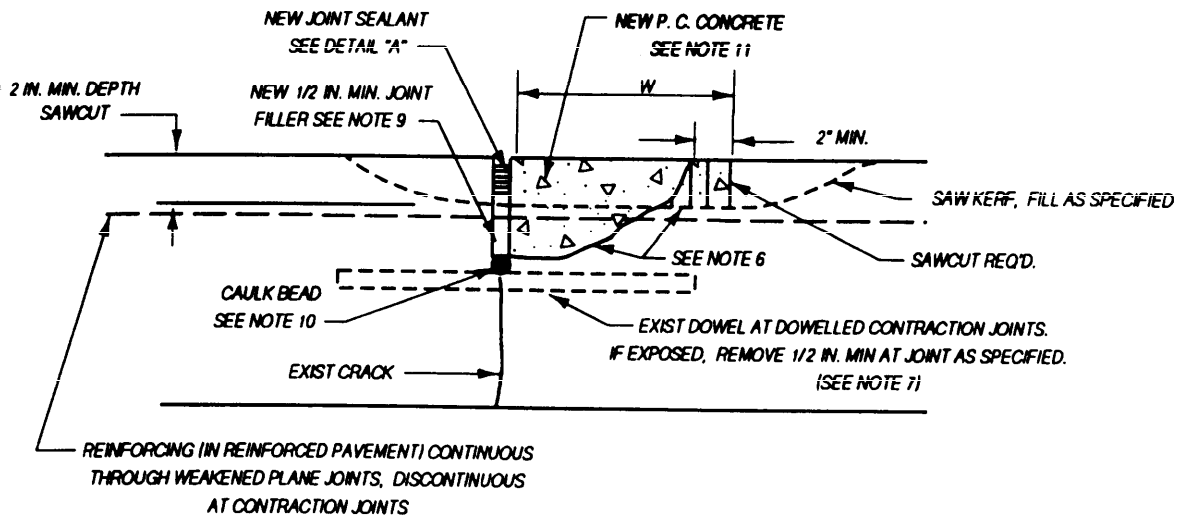

Figure 22  
Spall Repair at Keyed Construction Joint



SECTION B-B

Figure 23  
Spall Repair at Weakened Plane or Contraction Joint



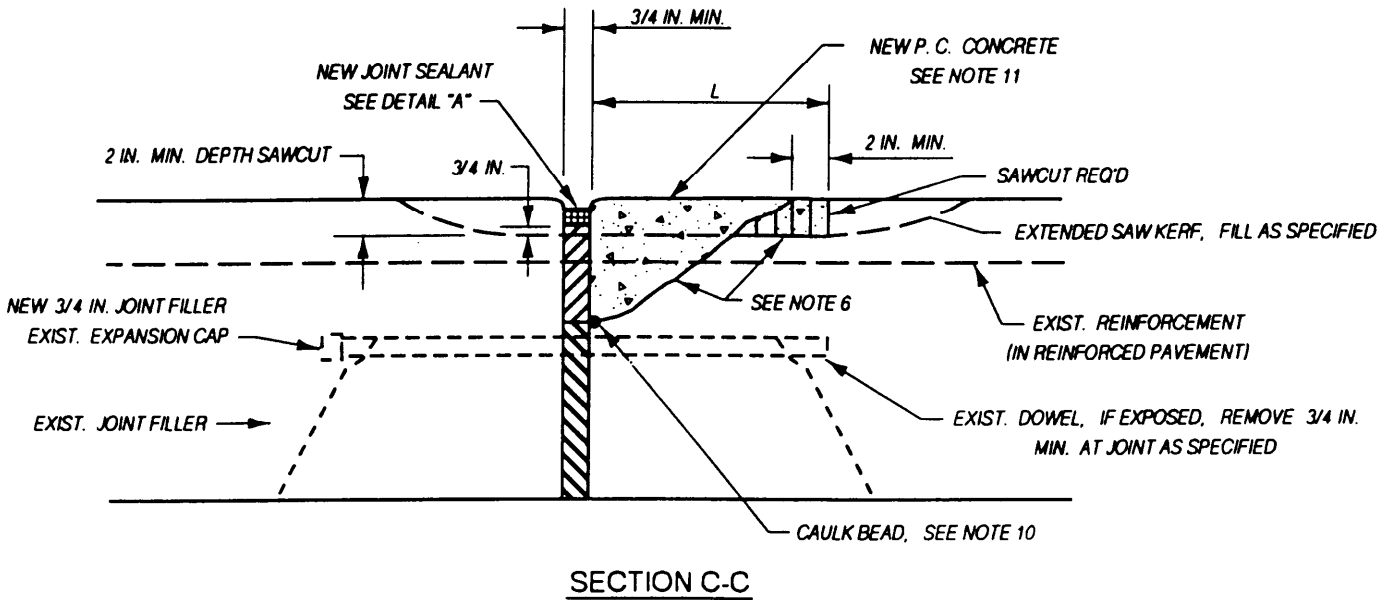
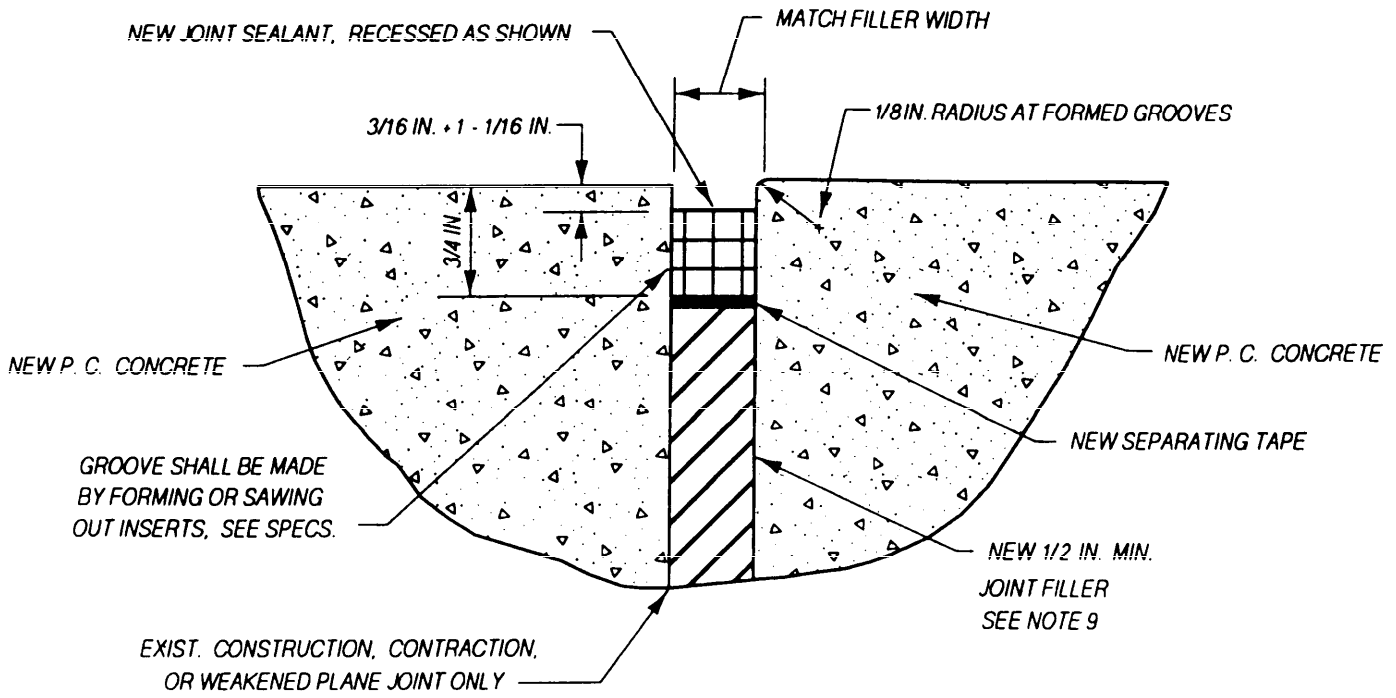

Figure 24  
Spall Repair at Expansion Joint



DETAIL "A"

Figure 25  
Groove for Joint Sealant at Spall Repair

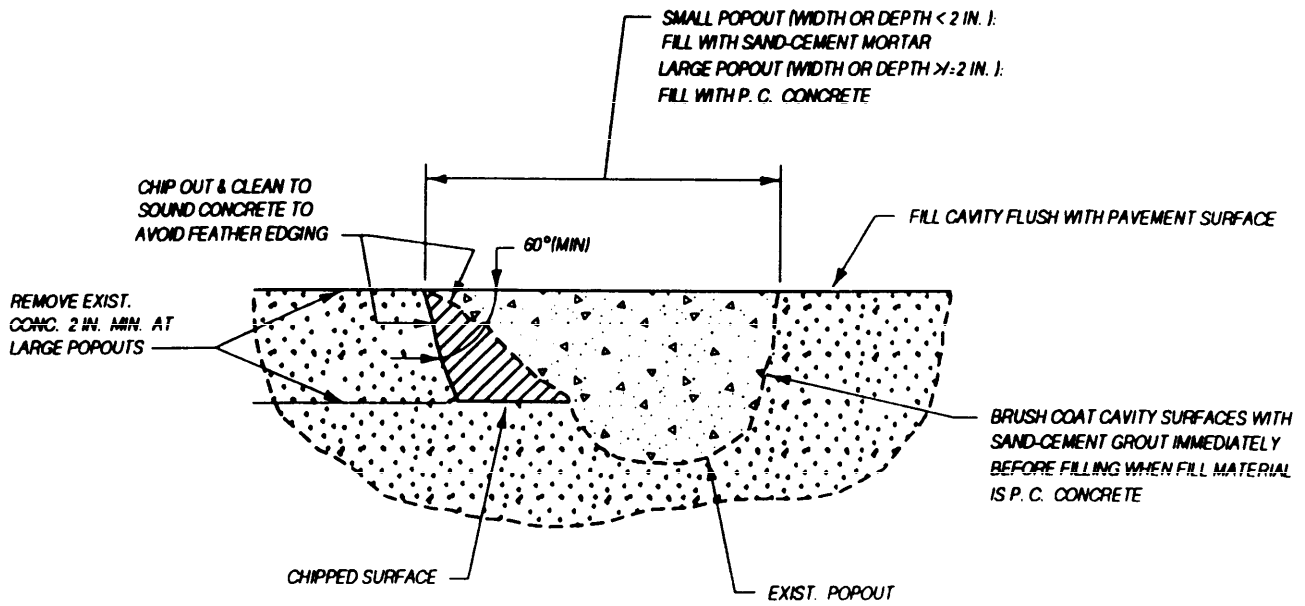

Figure 26  
Typical Section: Popout Repair

b) Spalls occur in many sizes and shapes. Repair details shown are intended to remove and replace all deteriorated concrete, and to maintain the size of the spall repair to the minimum practical to avoid unnecessary removal of unsound concrete.

c) Joint spalls with actual cavity widths less than 2 inches (50 mm) shall be repaired by cleaning and filling with joint sealant in lieu of portland cement concrete.

d) Where spall repairs are required on each side of a joint or crack, a non-flexible type filler or insert shall be secured in alignment with the joint or crack after breaking out the spalled concrete. The spall repairs shall be completed on one side at a time as specified.

e) At triangular spalls where both the length and width of the repair exceed 12 inches (305 mm), the repair shall be made pentagonal to avoid feather edged corners and to minimize size of repair area. Sawcuts shall be made to intersect joint lines at approximately 90 degrees (60 degrees minimum) for not less than 4 inches (102 mm) as shown.

f) Breakout and remove pavement and unsound concrete within sawcuts to a depth not less than 2 inches (50 mm). Clean exposed cavity surfaces as specified.

g) Dowels, tiebars, or continuous reinforcing exposed during preparation of spalled areas shall be removed as specified for the width of joint but not less than 1/2 inch (13 mm).

h) Where practical and at the option of contractor, a 1/2 inch (13 mm) minimum width groove may be sawed at existing joint lines to a point 1/2 inch (13 mm) minimum below the prepared cavity surface to hold new filler inserts during concrete placement.

i) Provide joint filler to maintain existing joints and working cracks. Width of filler shall be about equal to width of existing gap at the joint or crack but not less than dimensions shown. Depth of filler shall be not less than depth of new patch material. Install filler neatly to prevent new grout or concrete from by-passing filler and entering the joint space.

j) At option of contractor, a neat bead of caulk may be applied as indicated to prevent grout or concrete from by-passing filler and entering the joint space.

k) Apply and scrub sand-cement grout bonding course on all exposed cavity surfaces except faces of joints and working cracks. Fill cavity flush with pavement surface with concrete as specified.

5.4 Removal of Existing Concrete. Removal of existing concrete can be accomplished by sawing and chipping, or by a milling process. To remove concrete by sawing and chipping, a saw cut should be made around the perimeter of the repair area a minimum of 2 inches (50 mm) in depth. This will provide a vertical face of sufficient depth to give integrity to the patch (Figure 27). Additional saw cuts within the repair area to speed chipping may be used.

Concrete within the repair area should be removed to the bottom of the saw cuts or to sound and clean concrete with light pneumatic tools. It is important that the proper size tools are used. The recommended maximum size of the chipping hammer for partial depth repairs is 30 pounds (13.6 kg). Concrete within the repair area can also be removed by carbide-tipped cold milling equipment. Cold milling is especially effective where the repair area extends over the majority of the slab width. Milling machines must be equipped with a device for stopping at a preset depth in order to prevent excessive removal or damage to existing dowel bars or reinforcement. After removal of concrete in the repair area, either by sawing and chipping or cold milling, the bottom of the repair area should be sounded again to ensure all unsound or delaminated concrete has been removed (Figure 28).

Occasionally, what appears to be spalling at the surface will actually extend through the full slab depth, or for more than one-half the slab thickness. Partial depth repair should not be tried at such locations. The area should be marked, and full depth repair accomplished. Full depth repair should also be made if the concrete below one-half the slab depth is damaged during chipping or if dowel bars or reinforcing are encountered during removal. Steel that is encountered in spall areas and spans the adjacent joint must be at least partially removed. Steel that doesn't span the adjacent joint may be cleaned and reembedded in the patch material. Under no circumstances should partial depth repair material rest upon dowel bars or reinforcement.

5.5 Cleaning. The exposed faces of the concrete and any exposed steel should be sandblasted to remove all loose particles, oil, dirt, dust, asphaltic concrete, rust, and other contaminants prior to patching. The prepared surface must be checked prior to placing the new patch material. Any contamination of the surface will reduce the bond between the new material and the existing concrete.

5.6 Joint Preparation. When placing a partial depth patch adjacent to any joint, there must be no bond of the repair patch to the face of the adjacent concrete. Elimination of bond can be accomplished by using either a compressible insert (styrofoam or asphalt-impregnated fiber-board are commonly used) along the joint prior to placing the patch material. Patches that abut working joints, or cracks that penetrate the full depth of the slab, require a compressible insert or other bond-breaking medium to reform the joint or crack. This medium will form a uniform face against which the joint or crack can be properly sealed and will separate the patch from the adjacent slab. The new joint should be not less than the same width as the existing joint or crack. Failure to reform the joint or crack as described will result in point bearing and cause failure by blowup, delamination, or new shear planes, sometimes in the adjacent slab (Figure 29).

In highway work, when placing a partial depth patch along a shoulder joint, the patch must be formed. This will require the placement of a piece of plywood or other material along the slab edge even with the surface and slightly below the patch depth. This form must be securely anchored. If the patch material is allowed to penetrate into the shoulder interface, the material may restrict longitudinal movement of the slab in response to thermal changes and result in damage to the repair or the shoulder.

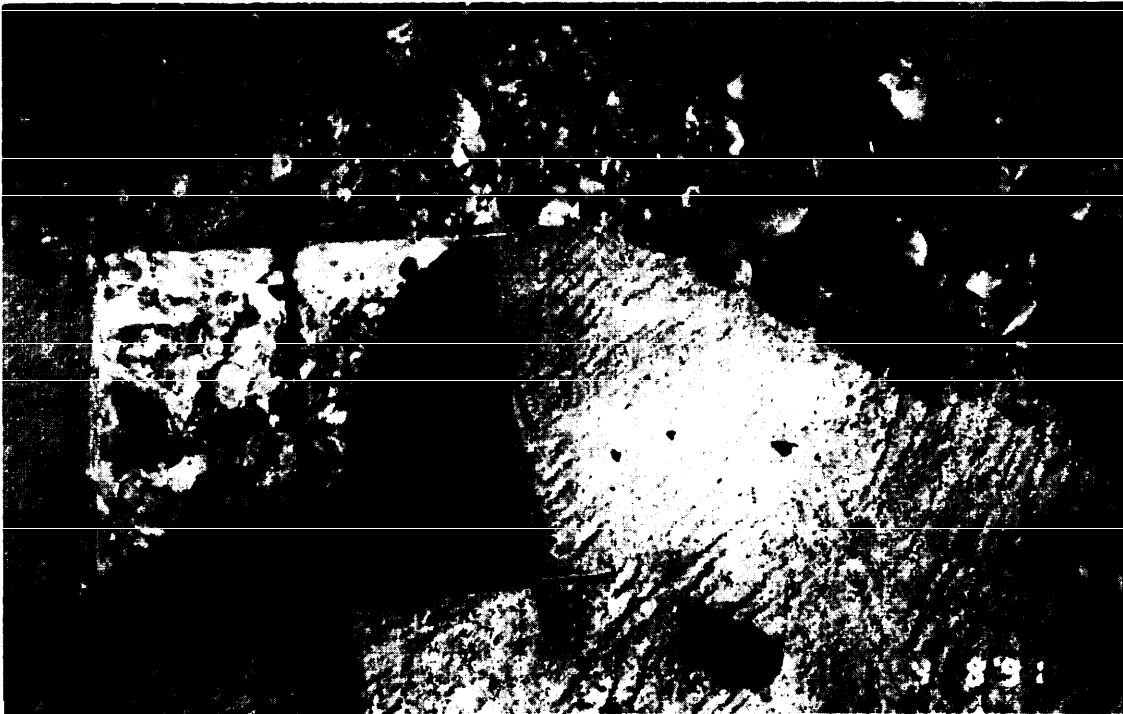

Figure 27  
Example of Vertical Faces Provided by Sawing

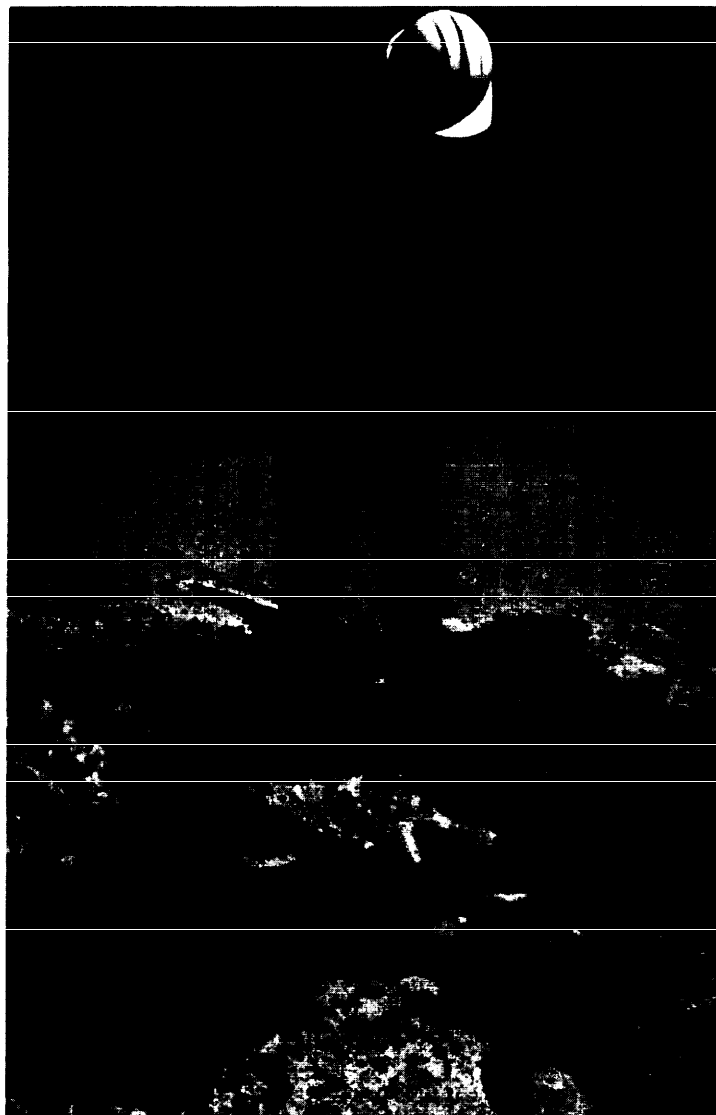

Figure 28  
Example of Resounding Bottom of Repair Area

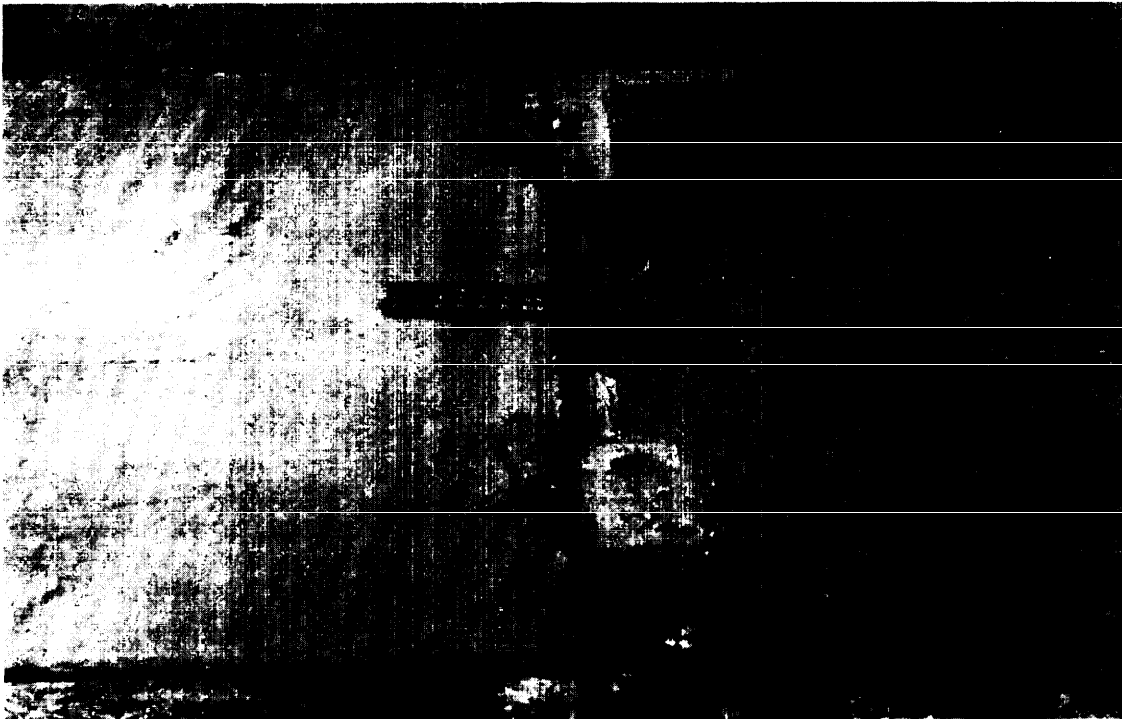

Figure 29  
Example of Spall Repair Failure Caused by Point Bearing



5.7 Patch Materials. High early strength portland cement concrete, usually using Type III cement, should be used where early opening to traffic is required. When using this material, an epoxy bonding agent should be used. The concrete should not be placed until the epoxy becomes tacky.

5.7.1 Normal Set. Normal set Type I portland cement concrete can be used when the patch material can be protected from traffic for 24 hours. A bonding mortar composed of 1 part portland cement to 1 part sand by volume with sufficient water to produce a mortar with a creamy consistency is applied to the patch area. The concrete must be placed before the grout dries. If the grout dries or hardens prior to placement of the concrete, it should be removed by sandblasting. Patches using normal set concrete should not be placed when the air temperature is below 50 degrees Fahrenheit (10 degrees Centigrade). At temperatures below 55 degrees Fahrenheit (12.8 degrees Centigrade), a longer curing period and/or insulation mats may be required.

5.7.2 Rapid Set. Rapid set proprietary patching materials should be used in compliance with the manufacturer's recommendations. This includes bonding, placing, time required before opening to traffic, and temperature ranges.

Epoxy mortar and epoxy concrete mix designs should be evaluated in the laboratory before use. The epoxy resin catalyst should be preconditioned before blending to produce a liquid blended between 75 and 90 degrees Fahrenheit (23.9 and 32.2 degrees Centigrade). The epoxy components should be mixed in compliance with the manufacturer's recommendations prior to addition of aggregate. The material should be blended in a suitable mixer until homogenous. Only the quantity of material that can be used within 1 hour (dependent on materials and air temperature, may be less than 1 hour) should be mixed in each batch.

5.8 Placement of Patch Material. All sandblasting residue should be removed using oil free airblowing equipment just prior to placing the bonding agent. The bonding agent should be applied with a stiff bristle brush and scrubbed into the patch area; it should be applied evenly and in a thin coat and should not be allowed to puddle (Figure 30).

The volume of material required for a partial depth repair is usually less than 2.0 cubic feet (0.057 cubic meter). Therefore, patching material should be mixed on site in small mobile drum or paddle mixers. Transit mix trucks and other large equipment cannot efficiently produce such small quantities since maximum mixing times for a given temperature may be exceeded, resulting in waste of material. However, on large partial depth patches or many small partial depth patches in the same locality that are ready to fill at the same time, a transit mixer may be more economical. The repair area should be slightly over filled to compensate for consolidation. The patch material is consolidated to eliminate any voids at the interface of the patch and the existing concrete, using small spud vibrators (Figure 31). Vibrators greater than 1 inch (25 mm) in diameter are not recommended for this work. On very small repairs, hand tools should be sufficient to work the repair and attain adequate consolidation.

5.9 Finishing. The repair area should be finished to the cross section of the existing pavement without leaving excess material on the adjacent pavement surface. The recommended finishing procedure is to screed from the center of the patch area to the patch boundaries. By moving the screed toward

the patch boundaries, the material is pushed toward the interface increasing the potential for high bond strength.

After finishing, the patch should be given a burlap drag or broom finish to approximately match the surface finish of the existing adjacent concrete pavement, unless a grinding operation is to follow.

5.10 Sawcut Run-outs. Excess mortar from finishing can be used to fill any sawcut run-outs that extend beyond the patch perimeter at patch corners. The mortar will help to prevent moisture penetration that may undermine the bond.

5.11 Sealing Patch/Slab Interface. An important procedure in placement of partial depth repairs is sealing the patch/slab interface. The patch/slab interface is sealed using a one to one cement grout which is painted along the patch/slab interface. This grout will form a moisture barrier over the interface and impede delamination of the patch (delamination of the patch can occur if water at the interface freezes during the winter).

5.12 Curing. Proper curing of partial depth repairs is very important, due to the large surface area of small patches compared with the volume of patch material. This relationship is conducive to quick moisture loss and is different from most other concrete applications. Proper curing generally employs the application of curing compound at the time bleed water has evaporated from the surface. Because curing is critical for partial depth patches, the first 24 hours should be wet curing with wet burlap or similar material. The balance of the 7-day curing period may be with liquid membrane compounds. In general, the procedures used for curing full depth repairs can be considered for partial depth repairs.

5.13 Joint Resealing. Resealing the repair joint is extremely important because it will help prevent moisture and incompressibles from causing further damage. It is important that the new transverse and longitudinal joints constructed within the patch area be formed or sawn to provide the proper joint seal reservoir. The joint faces must be clean and dry for good sealant performance. Resealing of joints should be done in accordance with the recommendations outlined in Section 11.



Figure 30  
Example of Bonding Agent Application of Repair Area

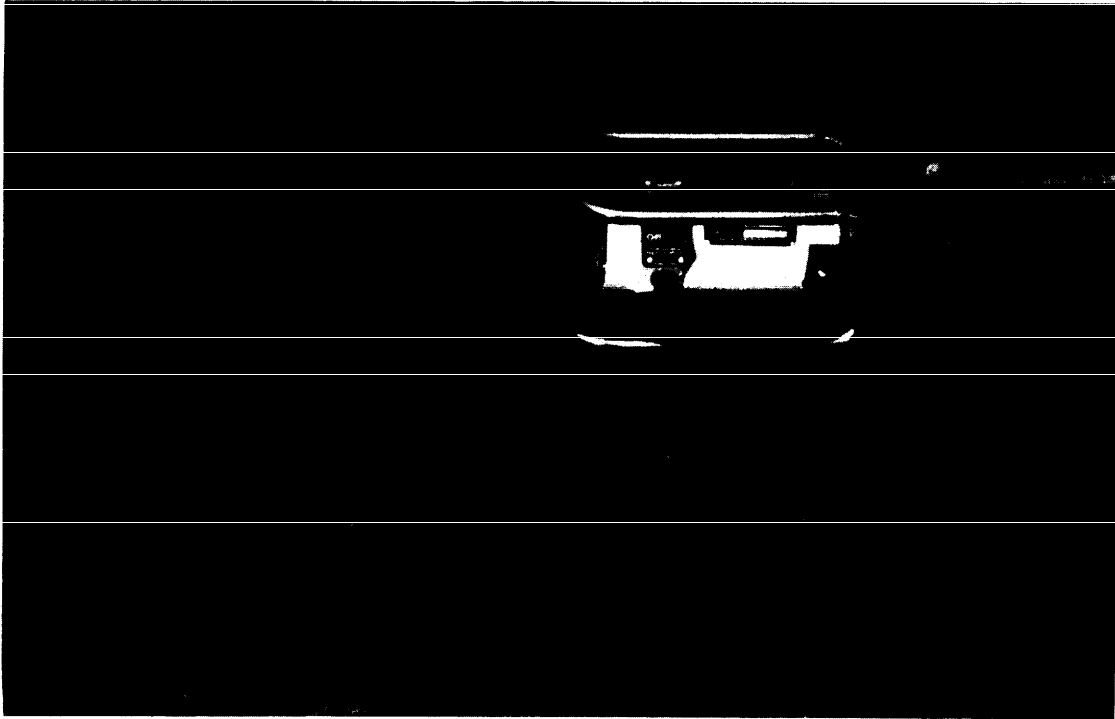

Figure 31  
Example of a Small Diameter Vibrator

## Section 6: SLABJACKING

6.1 Purpose of Slabjacking. The purpose of slabjacking is to raise a slab in place permanently, prevent impact loading, correct faulty drainage, and prevent pumping at transverse joints by injection of a grout under the slab. The grout fills voids under the slab, thereby restoring uniform support. When necessary, it can also be used to raise the slab (Figure 32).

6.2 Need for Slabjacking. Slabjacking should be considered for any condition that causes nonuniform slab support such as embankment settlement, settlement of approach slabs, settlement over culverts or utility cuts, voids under the pavements, differences in elevation of adjacent pavements, joints in concrete pavements that are pumping or expelling water or soil fines (Figure 33) and pavement slabs that rock or teeter under traffic.

6.3 Location of Injection Holes. Location of injection holes must be determined in the field. The jacking crew superintendent normally locates the holes and must take into consideration the size or length of the pavement area to be raised, the elevation difference, subgrade and drainage conditions, location of joints or cracks, and the manner in which the slabs will be tilted or raised (Figure 34). As a general rule, holes should not be placed less than 12 inches (305 mm) or more than 18 inches (457 mm) from a transverse joint or slab edge. The holes should not be placed more than 6 feet (1.83 m) center to center so that not more than approximately 25-30 square feet (23.2 to 27.8 square meters) of slab is raised by pumping any one hole. Additional holes may be required if the slab is cracked.

The proper location of holes varies according to the defect to be corrected (Figure 35). For slabjacking a joint where faulting has not yet occurred, a minimum of two holes can be used. For slabjacking, a joint, where one corner of the slab has faulted the hole at the low corner, should be set back to avoid raising the adjacent slab. Where the pavement has settled and the slabs are in contact with the subbase, a single hole located in the middle of the panel may be sufficient.

6.4 Drilling Holes. Holes 1-1/4 to 2 inches (32 to 50 mm) in diameter are drilled by either pneumatic drills, core drills, or other devices which are capable of drilling grout injection holes through the concrete pavement and the base material (Figure 36). The equipment must be in good condition and operated in such a manner that the holes are vertical and round (Figure 37). The down feed pressure whether by hand or mechanical means should not exceed 200 pounds (91 kg).

Where the concrete pavement is tight against the base material, the use of an airline or blow pipe may be necessary to form a cavity under the pavement slab for the grout pressure to take effect. Where the pavement is placed on and bonded to a cement treated or other stabilized base material, grout holes should be drilled all the way through the base material. The grout should be injected below the base material rather than between the pavement and base material.

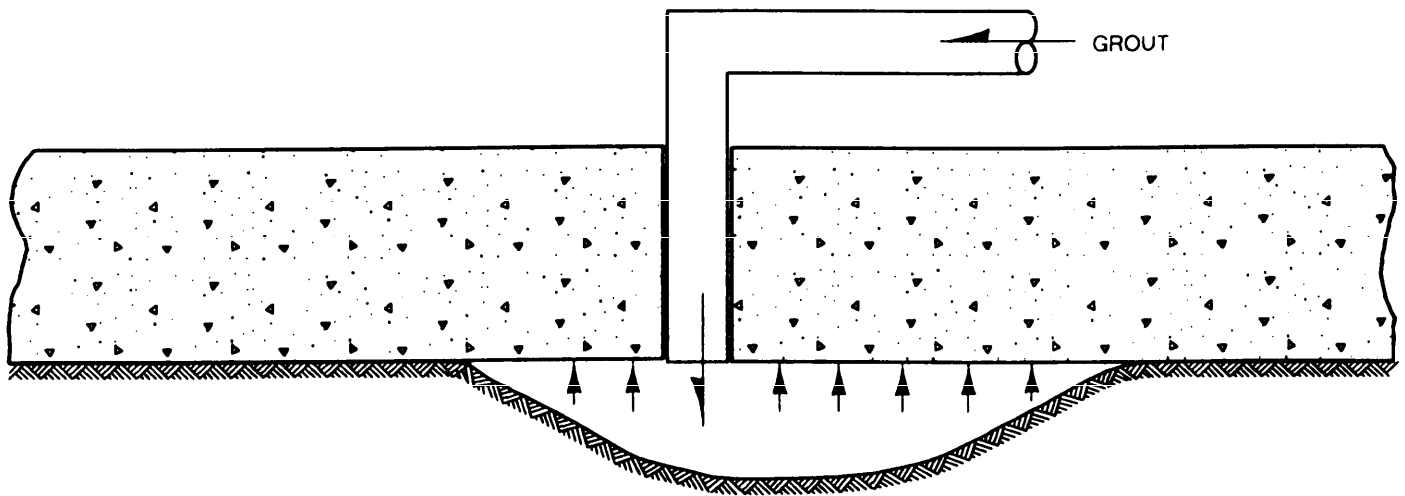

Figure 32  
Grout Fills Voids Under Slab Restoring Uniform Support

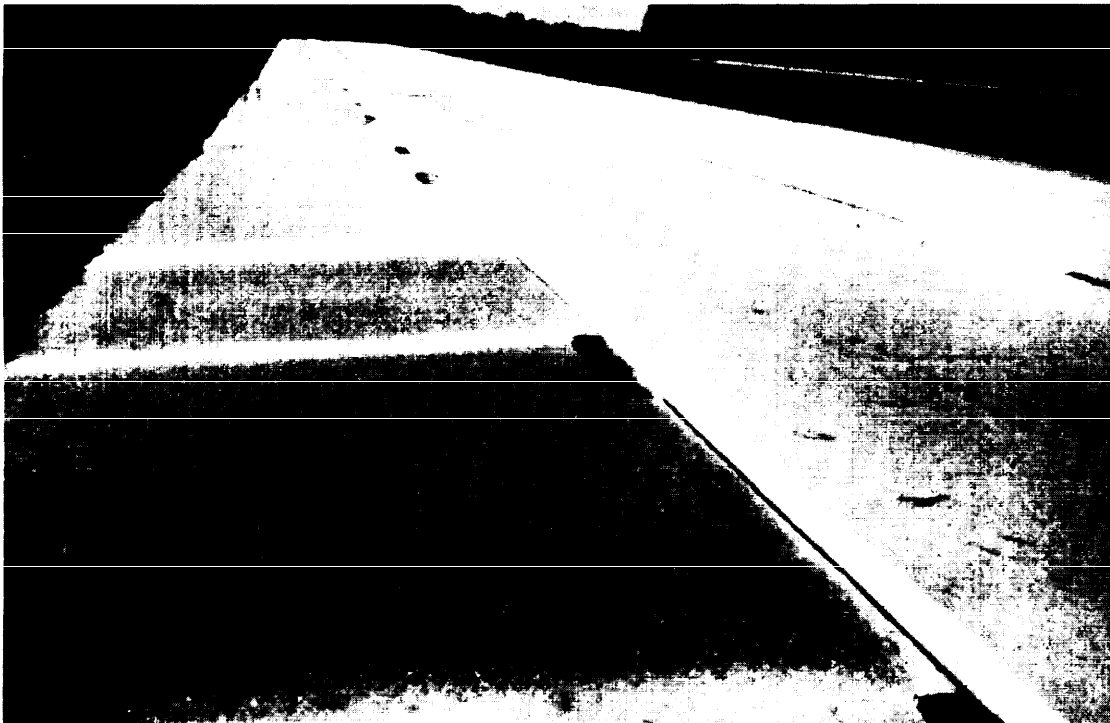

Figure 33  
Evidence of Concrete Slabs Pumping

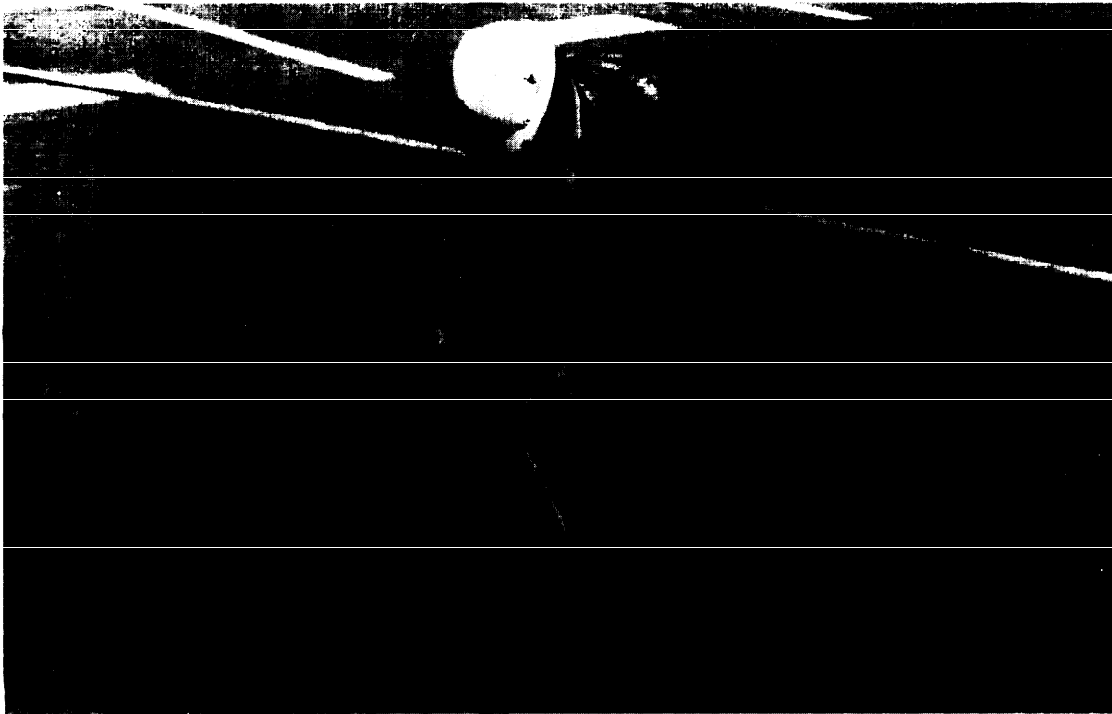

Figure 34  
Example of Injection Hole Layout



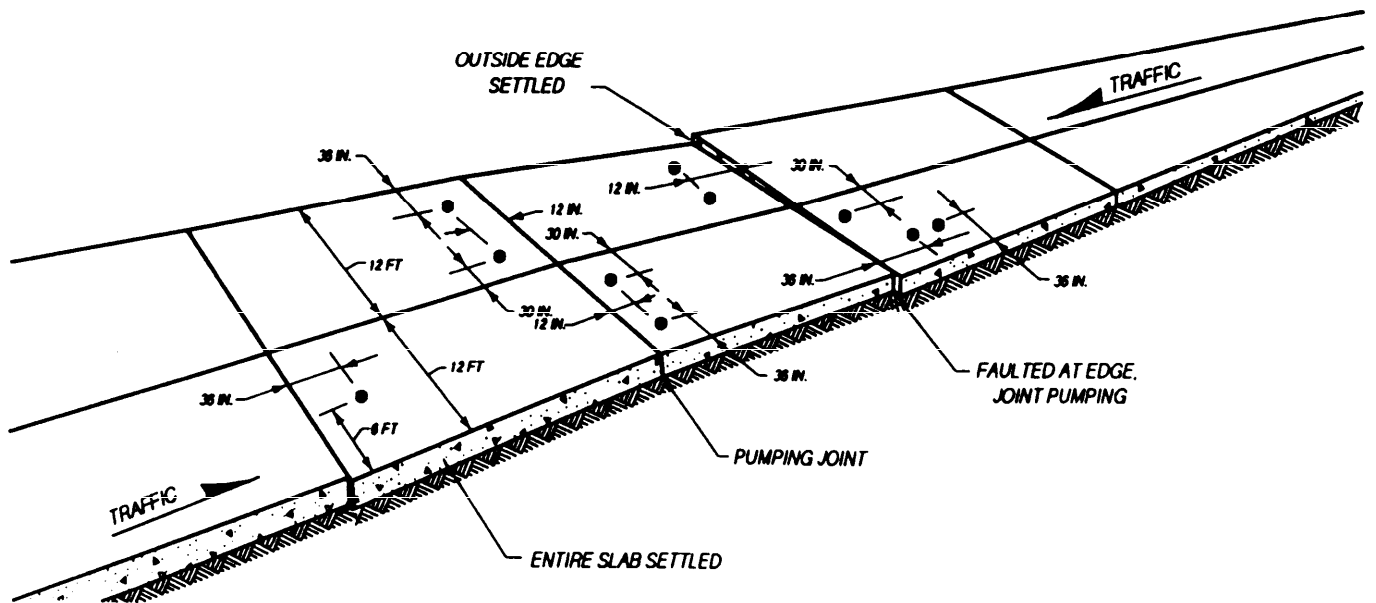

Figure 35  
Location of Holes Varies for Defect to be Corrected



Figure 36  
Example of Drilling Holes for Grout Injection

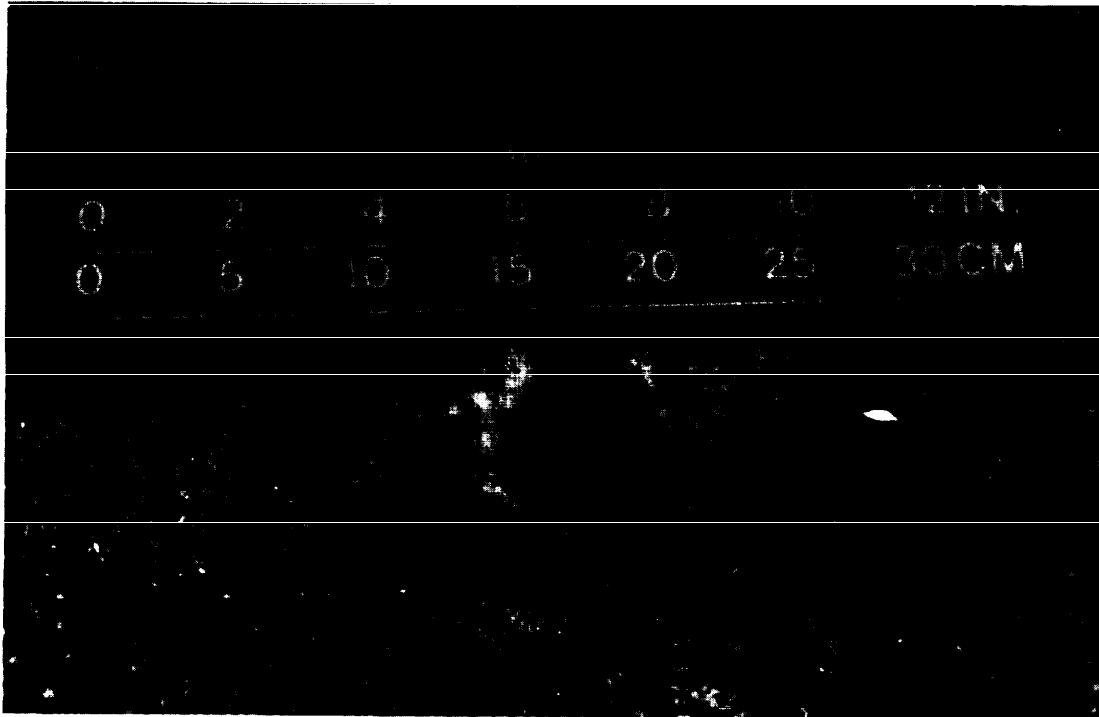

Figure 37  
Example of Injection Hole

6.5 Grout Mixture. A variety of grout mixtures have been successfully used for slabjacking. They generally consist of 3 to 7 parts fine aggregates or a mixture of aggregate and pozzolans or flyash to 1 part portland cement with enough water to produce the desired consistency. Wetting agents or other additives may also be used to increase the flowability. The use of a wetting agent lubricates the grout and permits runs of up to 6 feet (1.83 m); it also tends to reduce "pyramiding" (a stiff grout may form a pyramid under the slab, leaving unfilled cavities).

A definite method of proportioning the grout mixture should be used to ensure uniform consistency. The proper consistency to be used for any given condition is best determined by experience. Generally, a mix of stiff consistency is used to raise the pavement slabs and a more fluid mix is used for filling voids. The consistency should be checked by a flow cone (American Society for Testing and Materials ASTM-C-939) at least twice each day (Figure 38). Typical flow cone times vary between 16 to 30 seconds depending on the type of materials used in the grout mix. Strength requirements of the grout mixture should be specified, a common requirement is 600 pounds per square inch (4.14 MPa) at 7 days as determined by ASTM-C-39.

6.6 Grout Pumping. Pumping and jacking operations should normally start at the lowest point in a depressed area and work outward in both directions (Figure 39). Pumping proceeds by lowering into successive holes a pipe connected to the discharge hose of the grout pump. An expanding rubber packer is used to seal the open space between the pipe and the drill hole (Figure 40). The discharge pipe should not extend below the bottom of the pavement. The injection pipe should be equipped with a return line to circulate the grout while no grout is being placed.

6.6.1 Lifting. Lifting should be done in increments of about 1/4 inch (6 mm) with frequent changes in injection locations to keep slab stresses at a minimum and avoid cracking. The rate of grout injection should be uniform and as slow as possible, usually a minimum of 1/2 cubic foot (0.015 cubic meter) per minute to a maximum of 2.0 cubic feet (0.057 cubic meter) per minute. Initial pumping is normally at the lower rate and is increased as lifting progresses. As the desired elevation is approached, the lifting rate should be reduced.

6.6.2 Leaks. When grout leaks from joints, cracks, or from the pavement edge before the target elevation is reached, regrouting in new drill holes and additional slabjacking will be necessary.

6.6.3 Gauge Pressures. Gauge pressures for slabjacking are normally in the range of 75 to 200 pounds per square inch (0.5 to 1.38 MPa), with short pressure surges up to 600 pounds per square inch (4.14 MPa) to initiate lifting of bonded slabs. Constant observation and analysis of pressure behavior is the most important single factor affecting good slabjacking. A rapid increase could signal a stoppage of flow that could be followed by a buildup of pressure and excessive lift and cracking if pumping continues. A sudden reduction of pressure could indicate a loss of lift due to subsurface leakage.

In slabjacking operations, the temperature is important when raising slabs to correct faulted joints or other elevation differences. If the temperature is high the concrete may be in compression at the slab ends and may not be free to move. This may require freeing the joints by sawing in order to complete the lifting process.

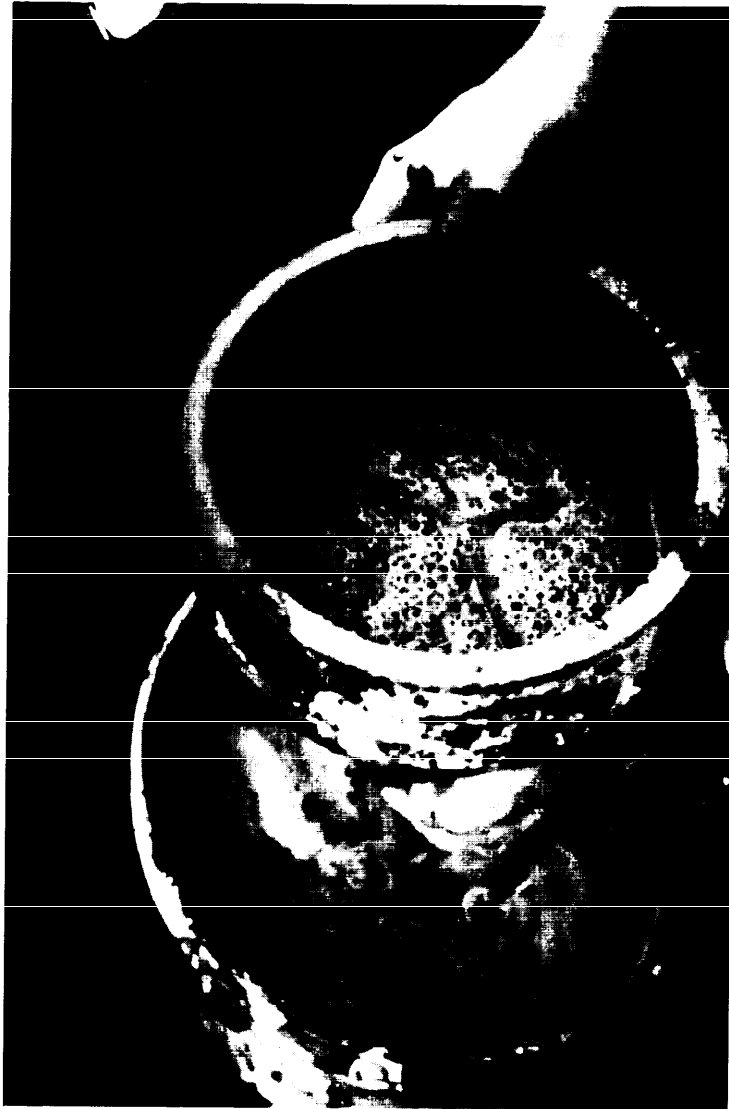

Figure 38  
Example of Flow Test

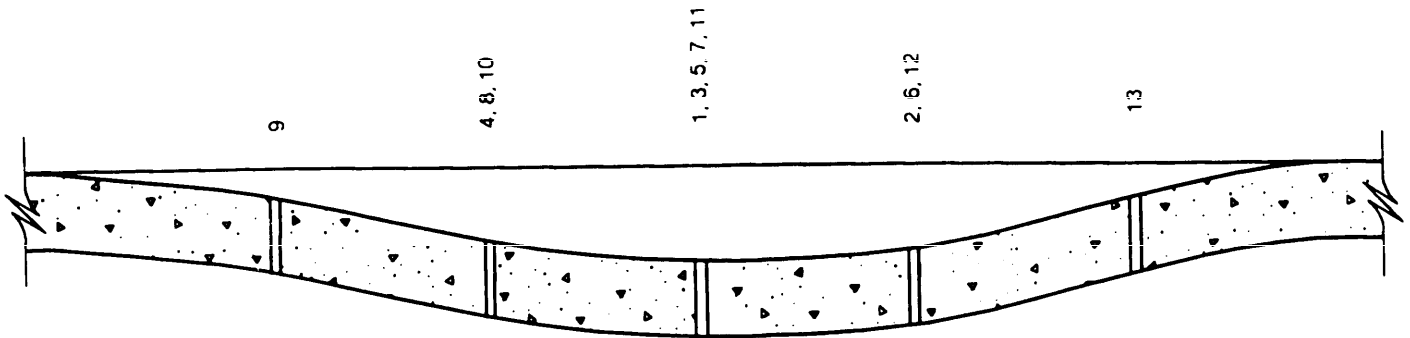

Figure 39  
Pumping Sequence for Dip in Pavement

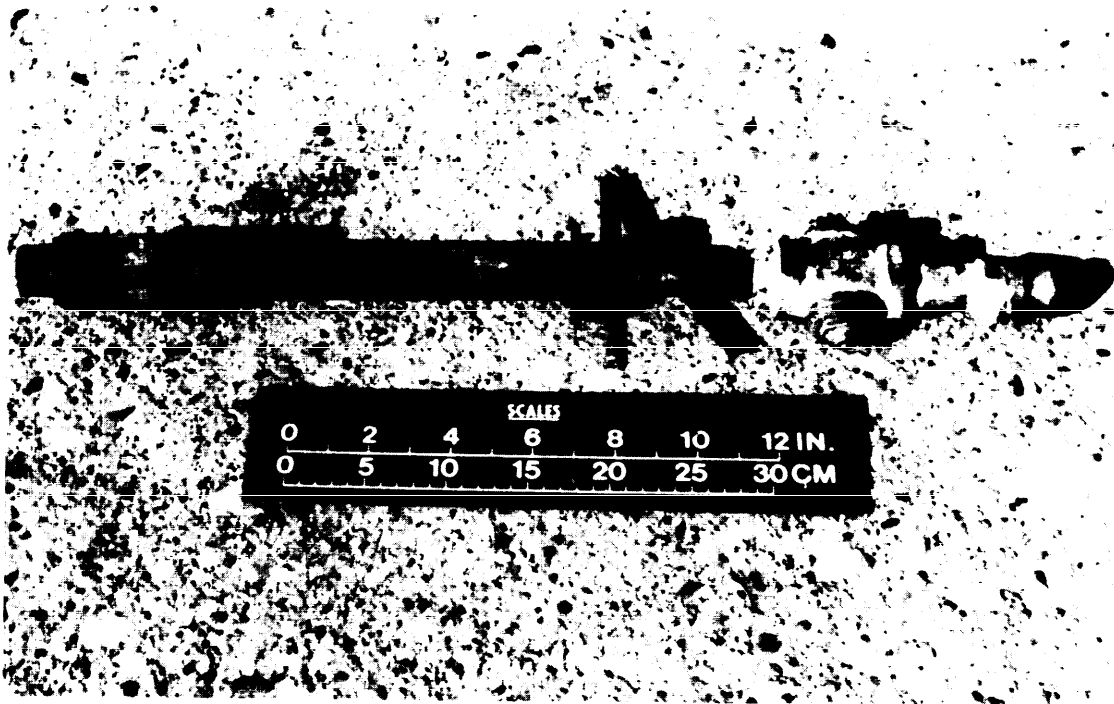

Figure 40  
Example of Expanding Rubber Packer

6.7 Elevation Control During Jacking. Before slabjacking operations are started, some method of controlling the amount the slab that is to be raised and the finished elevation of the pavement should be determined. For correcting faulted slabs, a straight edge may be used. For short dips up to approximately 50 feet (15.24 m) in length, a tight string line is adequate provided the joints are true and plane with those of the adjacent pavement (Figure 41). For dips in excess of 50 feet (15.24 m) in length, an engineer's level and rod should be used to check the profile well beyond the dip. This will avoid building a bump into the pavement.

6.8 Plugging and Cleanup. After slabjacking has been completed and the discharge pipe removed, the hole should be plugged immediately. Tapered wooden plugs are temporarily placed into the injection hole to retain the pressure of the grout and stop any return flow of the mixture (Figure 42). When slabjacking to the desired elevation has been accomplished, the temporary plugs are removed and the injection holes are filled with a stiff one-to-three cement grout or approved concrete mixture. These areas are then finished to approximately match the existing pavement.

Surfaces adjacent to the grouting operation should be kept clean of excess grout and other materials. Grout and cement slurry on the pavement should be broomed and washed off to avoid unsightly discoloration and to remove the grout slurry before it bonds to the surface.



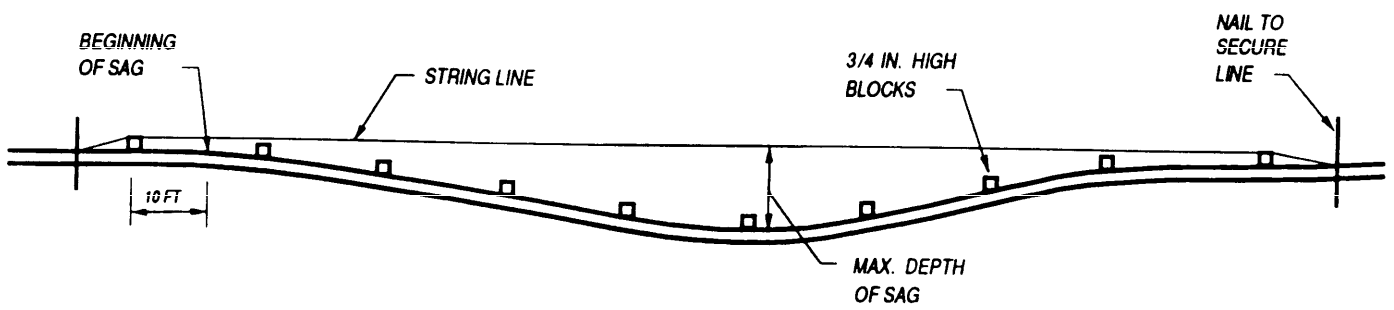

Figure 41  
Elevation Control for Dip in Pavement Using a String Line

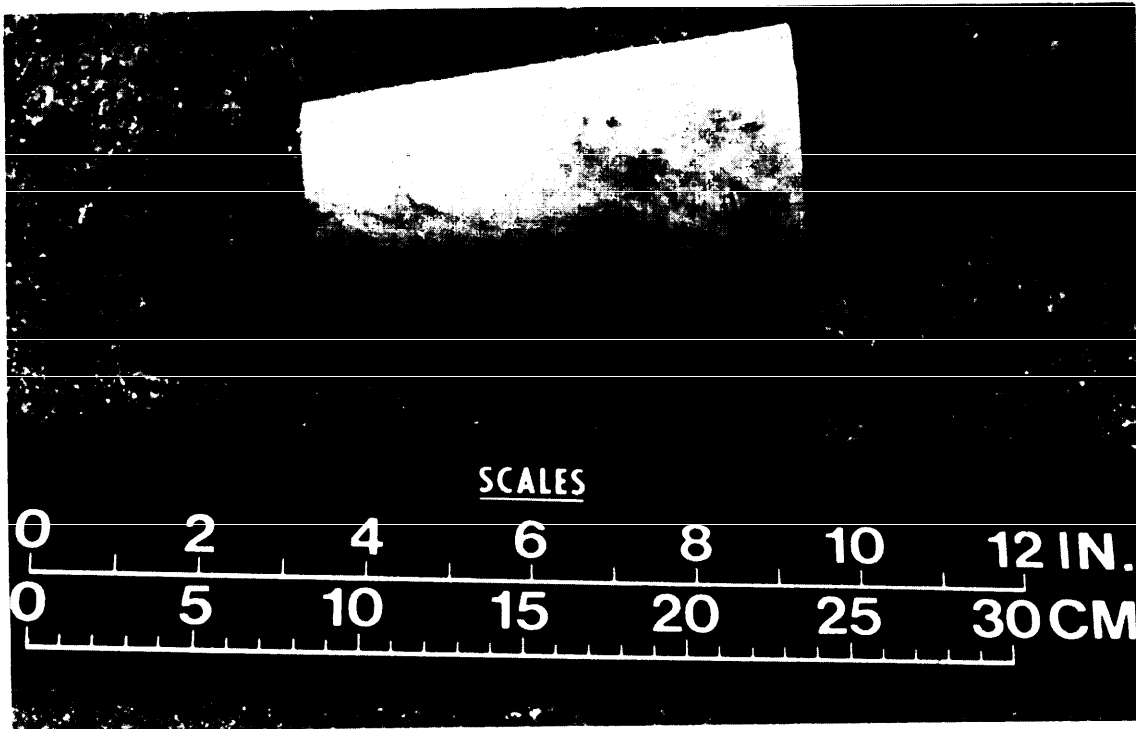

Figure 42  
Example of Tapered Wooden Plug

## Section 7: SUBSEALING JOINTED CONCRETE PAVEMENTS

7.1 Purpose of Subsealing. The purpose of subsealing is to stabilize the pavement slab by the pressurized injection of a cement grout through holes drilled in the slab. The cement grout will, without raising the slab, fill the voids under it (Figure 43), displace water from the voids, and reduce the damaging pumping action caused by excessive pavement deflections.

7.2 Void Detection. A thorough survey should be conducted to determine the void locations beneath the concrete pavement. Void detection measurements should be taken during the preliminary evaluation and during the repair process. Deflections should be taken on both sides of the joint to determine the amount of load transfer. Deflections should also be taken at mid-slab (Figure 44). Since there is low probability of having voids in the middle of the slabs, these measurements will give a good indication of what uniform support could be expected at the "perfect" joint. The time of day (Figure 45) and the time of year (Figure 46) will affect the deflection measurements at the joints. During the heat of the day slabs may expand and cause the joints to lock-up, the slabs may be curled upward or downward, and, during the winter with below freezing temperatures, any water which may be in the voids will freeze and deflection will indicate good support.

7.2.1 Methods of Detection. Several methods of void detection are in use. Perhaps the simplest is a visual inspection of the pavement to locate areas of distress. The presence of ejected subgrade or base material, staining of pavement surfaces adjacent to joints, vertical movement at joints or cracks, and faulting of joints are evidence of possible voids under the slab.

a) The most common method of determining the presence of voids is called "proof rolling." This is the procedure of slowly driving a heavily loaded vehicle (minimum 18,000 pound (8,165 kg) axle load) over a transverse joint while observing deflection of the slabs. If deflection can be visually observed, the joint should be undersealed. Deflection can also be measured with devices equipped with sensitive dial gauges which contact the pavement and are attached to a firm base located off the pavement; the dial gauges can be read visually or recorded electrically. When deflection is measured in this way, any slab showing deflection in excess of 0.015 inch (0.38 mm) should be undersealed.

b) Other methods for measuring deflection to locate voids include nondestructive equipment such as the Falling Weight Deflectometer, which measures the deflection response of the pavement under a dynamic load (Figure 47).

7.3 Need for Subsealing. For jointed concrete pavement, subsealing should be accomplished as soon as any significant loss of support is detected at slab corners. Symptoms of loss of support include increased deflections, transverse joint faulting, corner breaks, and the accumulation of fines in or near joints or cracks on traffic lanes or shoulders. Subsealing should also be considered at all existing repairs that show evidence of pumping or settlement. To be effective, subsealing should be performed before the voids become so large that they cause pavement failure. The only exception is when the pavement is to be overlaid with asphalt or concrete. In this case, subsealing is necessary, regardless of the pavement condition, to ensure support of the original slab and to prevent transmission of foundation problems to the overlay, which will cause premature failure.

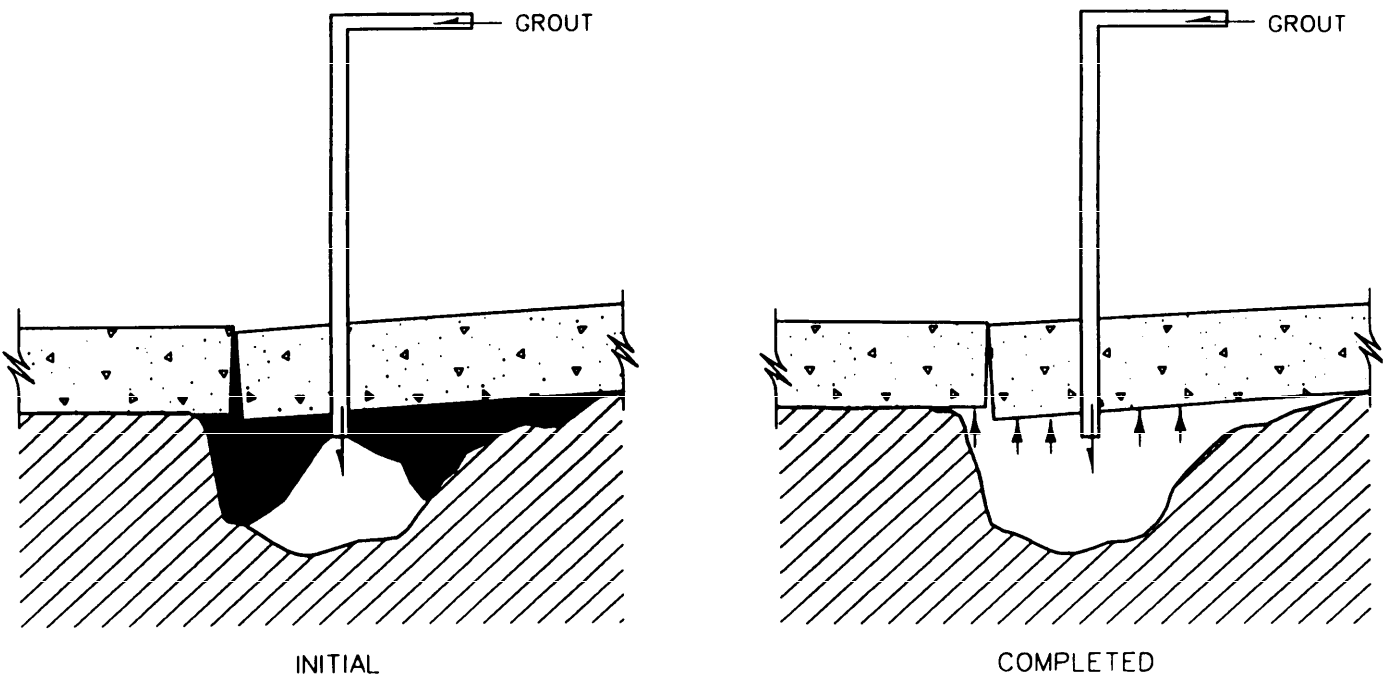

Figure 43  
Grout Will, Without Raising the Slab, Fill the Voids Under It

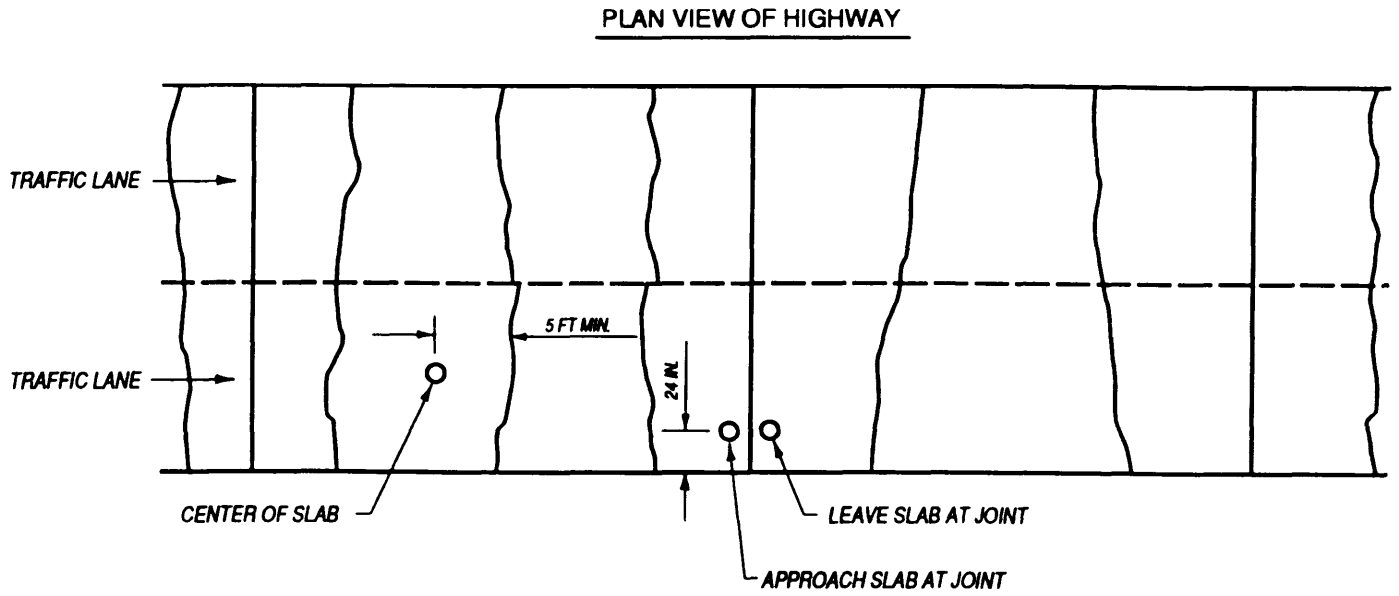

Figure 44  
Deflection Measurement Locations

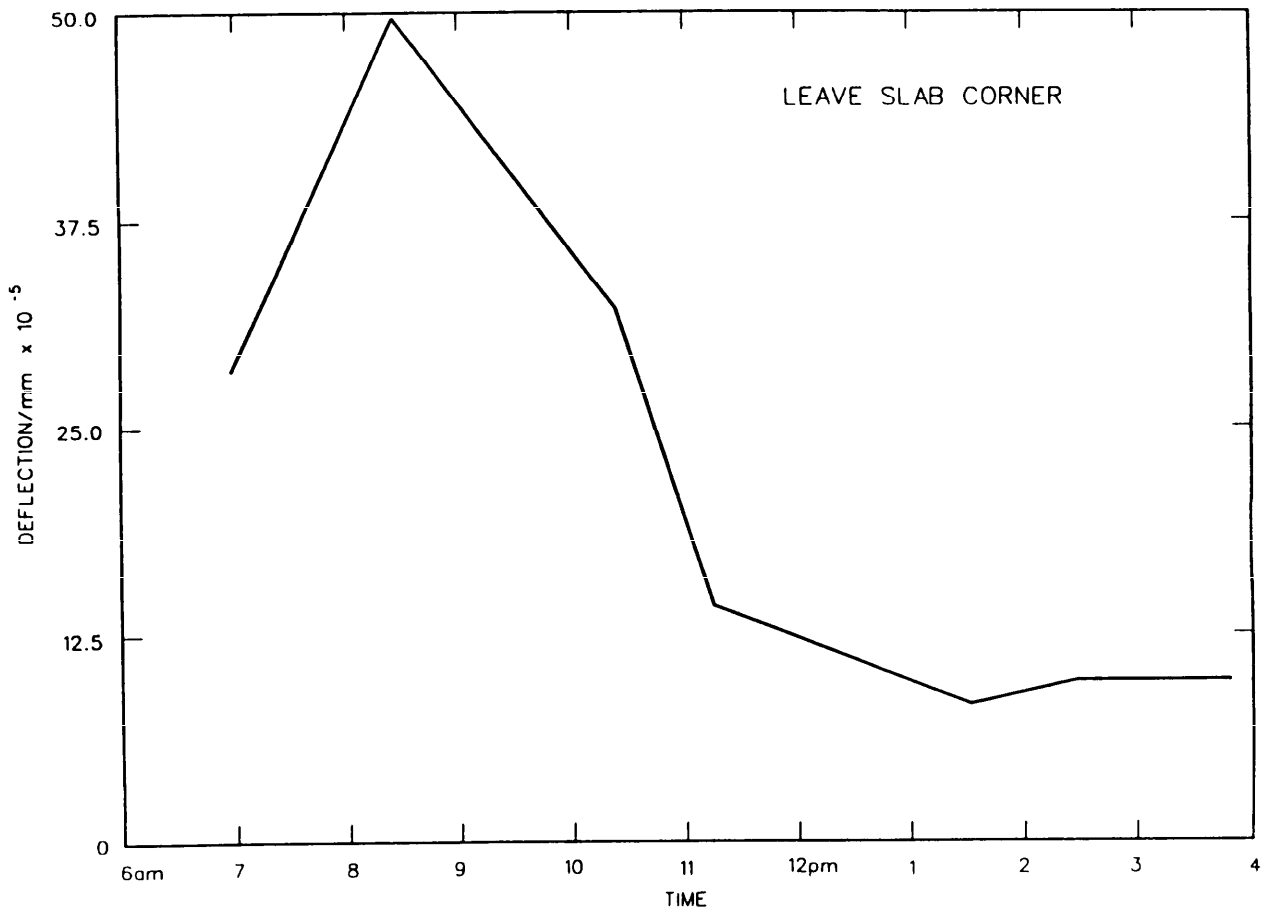

Figure 45  
Deflection Measurements Over Time Per Day

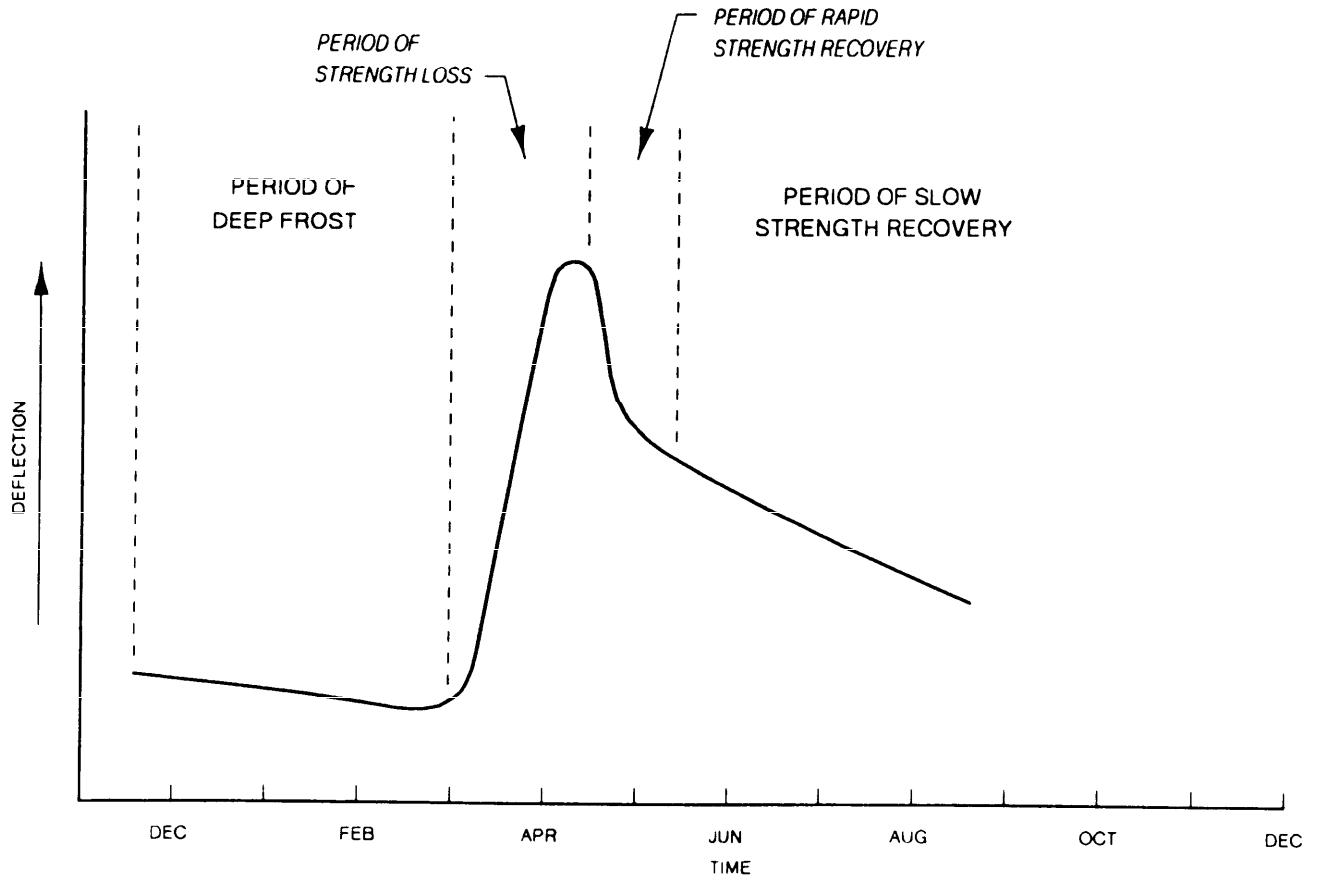

Figure 46  
Deflection Measurements Over Time Per Year

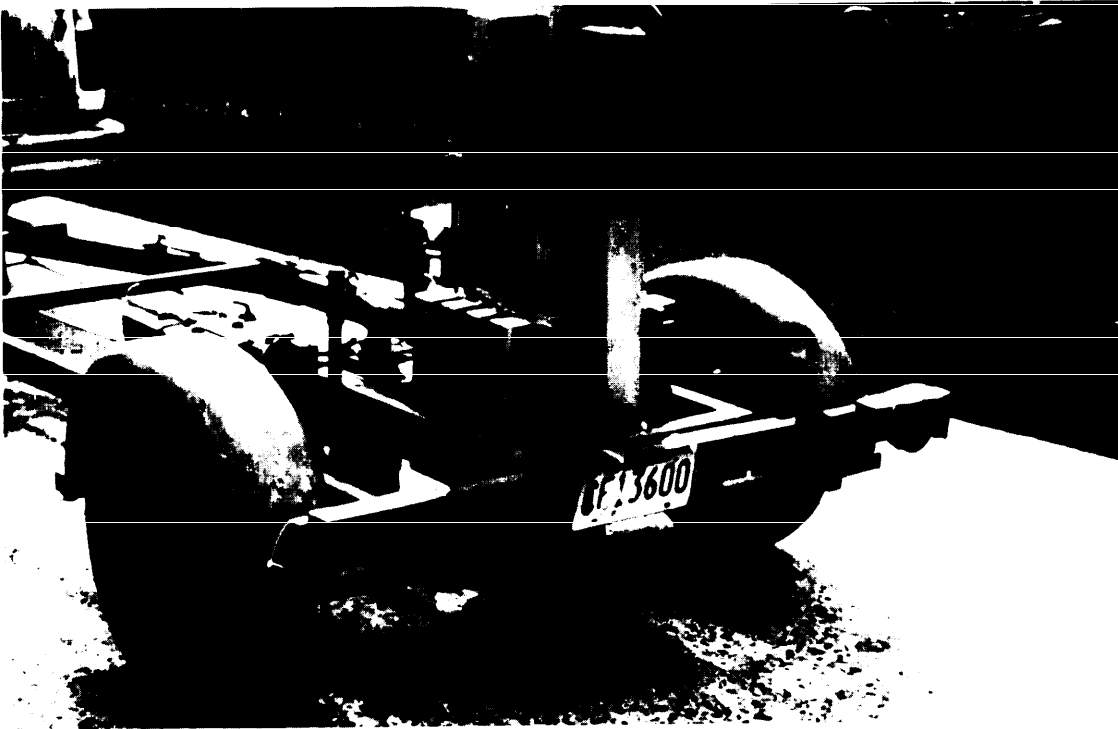

Figure 47  
Falling Weight Deflectometer



7.4 Hole Patterns. Hole patterns for effective distribution of cement grout under the pavement is not easily determined in advance. Some preliminary testing is often necessary in advance to locate holes in a way that will ensure good grout distribution. Where a hole pattern is selected for repetition, it should provide sufficient holes to permit grout to reach all voids beneath the pavement. The most common hole pattern is a four-hole pattern with two holes on each side of a transverse joint. The holes are located in the wheel tracks, with the approach slab holes closer to the joint than those in the leave slab. Typical distances from the joint are 12 to 18 inches (305 to 457 mm) for the approach slab (Figure 48) and 18 to 24 inches (457 to 610 mm) for the leave slab. Additional holes may be required for voids under the longitudinal joints or at the shoulder (Figure 49). Usually, one hole 24 to 36 inches (610 to 914 mm) from the shoulder and 4 to 6 feet (1.22 to 1.83 m) from the transverse joint is adequate. Ideally, the hole should be placed as far from the adjacent joints and cracks as possible but within the void area so the grout can flow from the injection hole toward the joint or crack.

7.5 Drilling Holes. Grout holes may be drilled with pneumatic, hydraulic, or diamond core drills. An important factor is hole size. Holes should not be larger than 2 inches (51 mm) in diameter (Figure 50). The downward pressure whether by hand or mechanical means should be less than 200 pounds per square inch (psi (1.38 MPa)), particularly at the bottom portion of the slab. Excessive down pressure can cause breakout of the concrete adjacent to the injection hole. This breakout can seriously weaken the slab and may result in premature cracking. Usually, the breakout material drops in such a way that it seals the hole, preventing the grout from reaching the void. The grout holes should be drilled vertically and round and to a depth sufficient to penetrate through any stabilized base, but not more than 3 inches (76 mm) into the subbase.

Grout holes should not be left ungrouted overnight, and preferably should be grouted within 4 hours.

7.6 Grout Mixtures. Grout mixtures for subsealing are typically cement grouts consisting of approximately 1 part portland cement to 3 parts pozzolan either natural or artificial or 3 parts limestone dust with enough water to achieve the required consistency.

Other additives may include super plasticizers, water reducers, fluidifiers, expanding agents, and calcium chloride. Each must be tested and evaluated in the laboratory to ensure compatibility of the materials.

Consistency should be checked by a flow cone (ASTM C 939) at least twice each day (Figure 51). Flow cone time varies between 9 and 20 seconds depending on the type of materials used in the grout mix. Typically flow cone times for limestone grouts are 16 to 22 seconds. Flyash grouts generally have flow times from 10 to 16 seconds. Strength requirements of the grout mixture should be specified, a common requirement is 600 pounds per square inch (4.14 MPa) at 7 days as determined by ASTM-C-109.

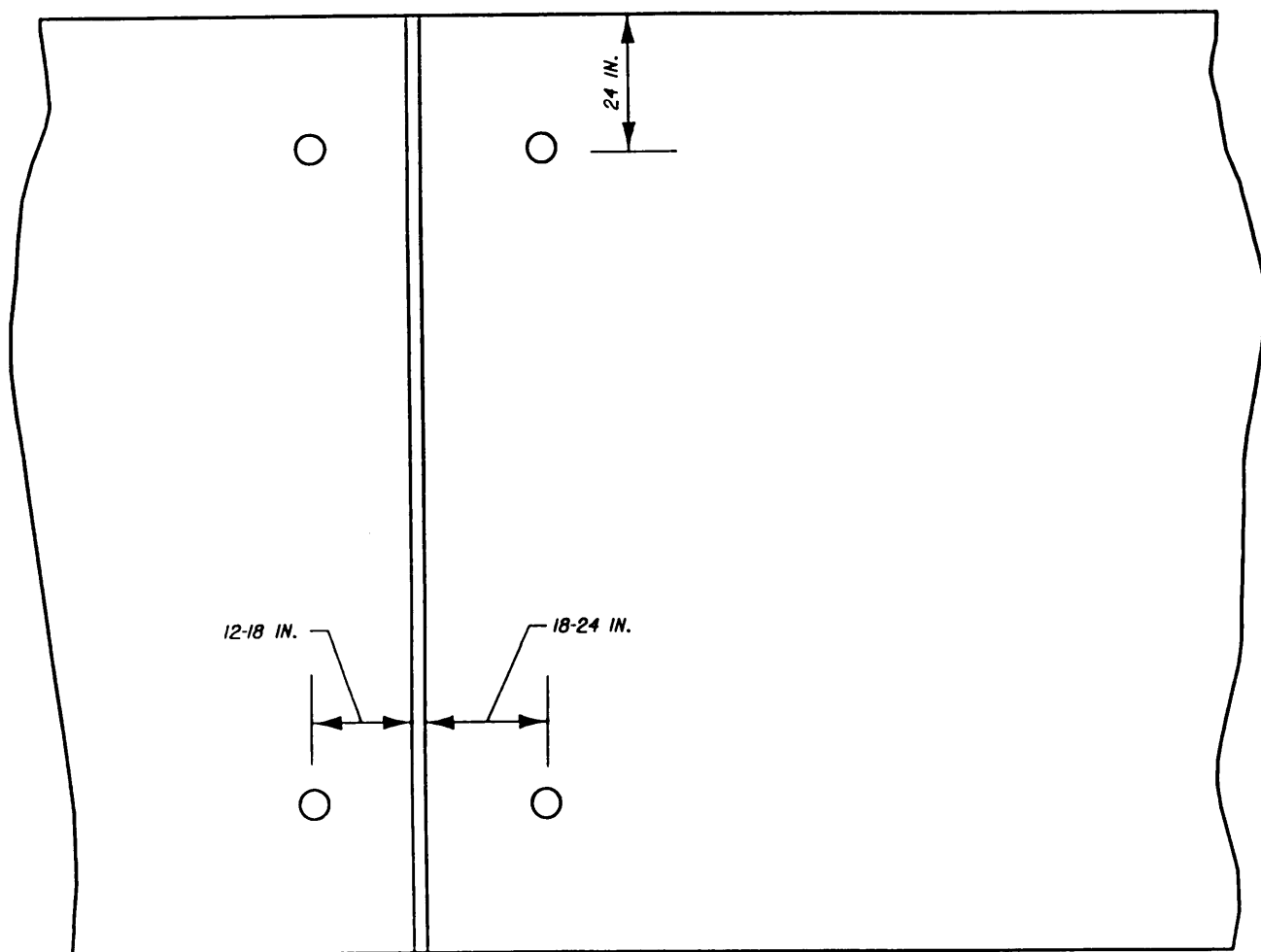

Figure 48  
Common Hole Pattern

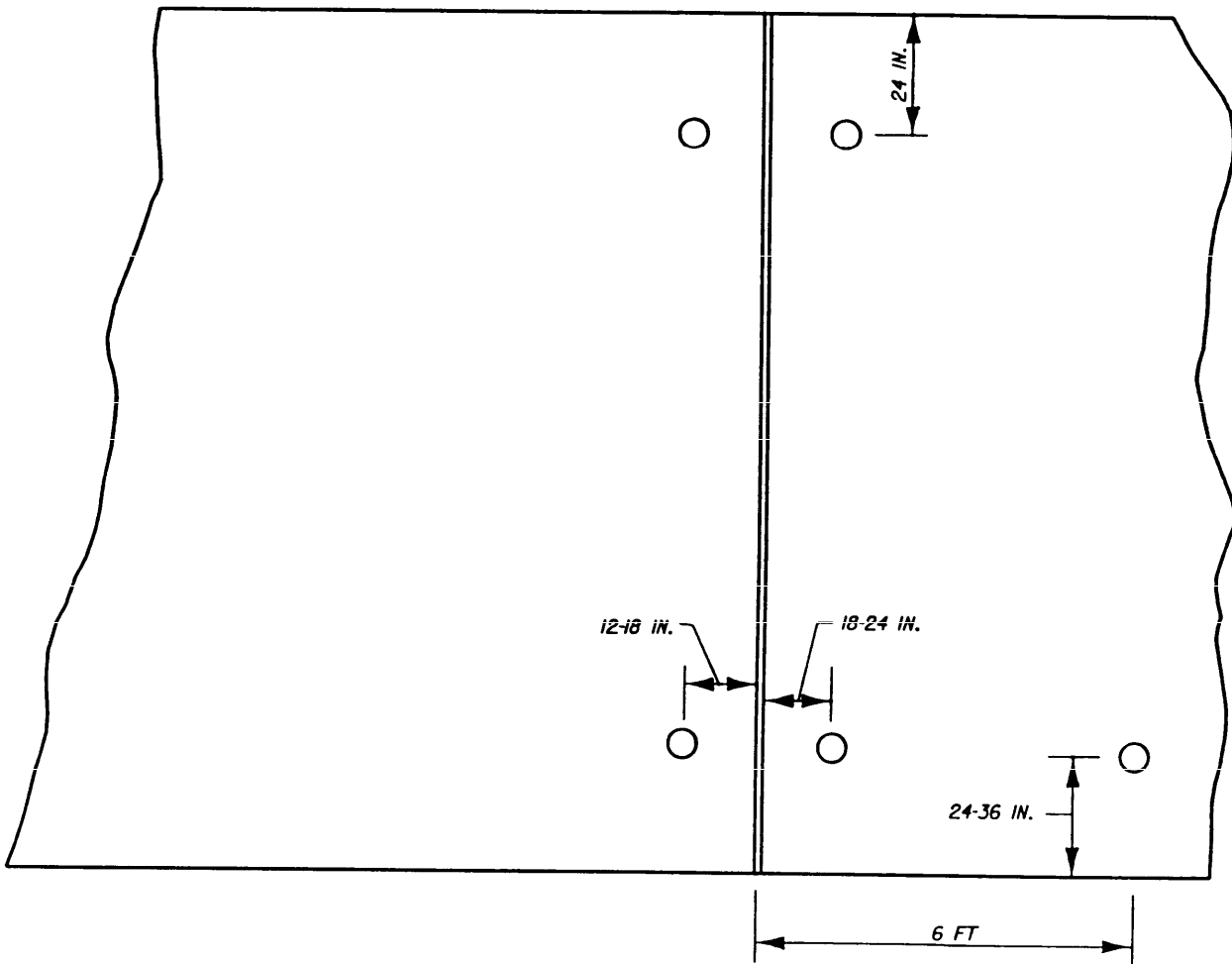

Figure 49  
Location of Additional Holes at Longitudinal Joints or Shoulder

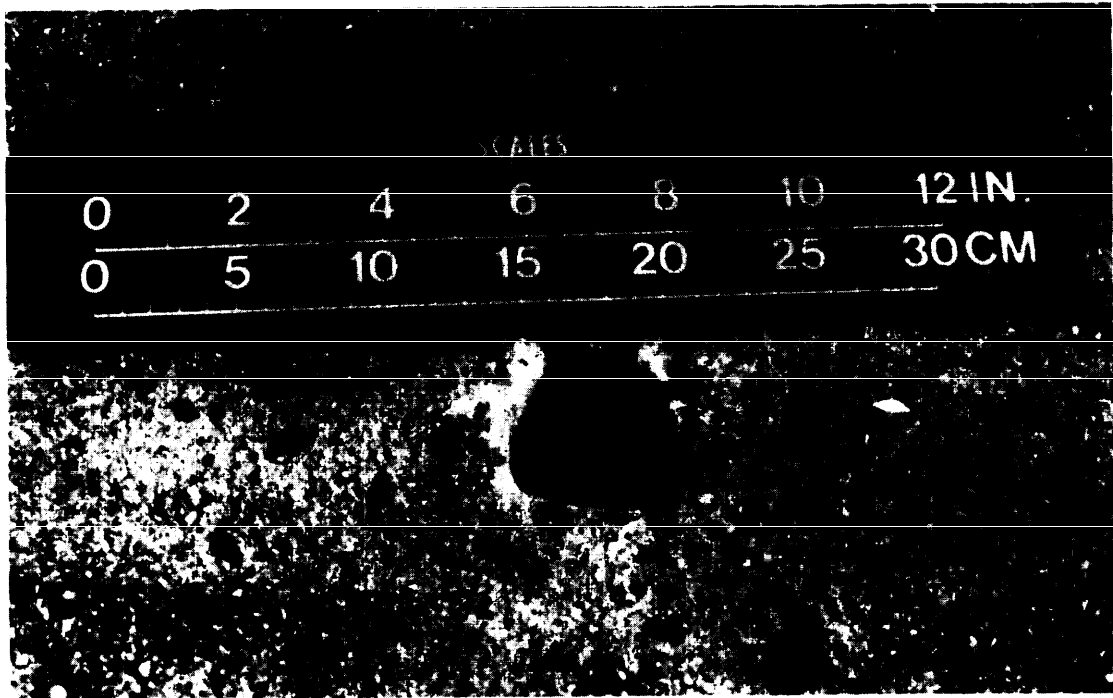

Figure 50  
Example of Injection Hole



Figure 51  
Example of Flow Test

7.7 Grout Injection. Grout injection proceeds by lowering into successive holes a pipe connected to the discharge hose of the grout pump. The grout hole is sealed by a device called a packer. Two types are commonly used:

a) The drive packer, consisting of a tapered pipe which is tapped into and out of the grout hole; drive packers are used with 1-inch (25 mm) diameter holes.

b) The expanding rubber, packer consisting of a threaded inner pipe, a thin-walled steel outer sleeve, and a short rubber sleeve at the bottom (Figure 52); this type of packer is used with 1.5 inch (38 mm) diameter and larger holes.

7.7.1 Slab Movement. Movement of the slabs must be monitored during the grouting operation. To properly monitor movement of the slabs, gages capable of reading movement of one one-thousandths of an inch have to be used. The base for the gage should be 3 to 4 feet (0.91 to 1.22 m) off the slab being monitored (Figure 53). The gages are set up at the outside edge of the slabs at the joints and not moved until grouting of the joint is completed. Typical pumping pressure should be in the 40 to 60 pounds per square inch (0.27 to 0.41 MPa) range. Grout injection should always start with a low pumping rate and pressure. Pumping should stop if the slab begins to rise, or when no material is being injected at the maximum allowable pressure of 100 pounds per square inch (0.69 MPa). Short surges up to 200 pounds per square inch (1.38 MPa) are allowed when starting to pump in order for the grout to penetrate the void structure. If grout returns through an adjacent hole, pumping should stop, and the packer should be inserted into another hole. If grout is observed flowing from joints or cracks in the pavement, pumping should continue until undiluted grout is observed.

Generally, when pumping the four-hole pattern, pumping should start at the center-line holes in each slab first and then continue with the holes closest to the shoulder. This sequence will drive any trapped water to the outside of the slab and through the transverse and shoulder joints.

Where there is an additional shoulder void and extra holes are required, the sequence becomes more complicated. Usually, the shoulder joint is pumped last. If, however, the transverse joint is wider than the shoulder joint, it may be necessary to pump the shoulder hole first.

7.8 Retesting Slab Corners. After a minimum time of 24 hours has elapsed after completion of subsealing, testing of the grouted slabs for stability should be accomplished at the same points as previously tested. This testing should also include some joints that were not grouted for use as control. If loss of support still exists after grouting, the slab should be regouted. In each regrouting, new holes will be needed. It is recommended that if after three attempts to stabilize the slab voids are still present, no further regrouting should be attempted; other methods of repair should then be considered such as full depth repair.

7.9 Plugging and Cleanup. After grouting has been completed at any one hole, the packer is removed from the hole and the hole is plugged with tapered wooden plugs to permit the grout to set, thus preventing back pressure forcing

the grout back through the hole (Figure 54). The plugs are removed and the hole is filled with a cement grout and finished to approximately match the existing pavement.

Surfaces of the pavement adjacent to the holes should be kept clean of excess grout and other materials. Grout and cement slurry on the pavement should be broomed and washed off to avoid unsightly discoloration and to remove the grout and slurry before it bonds to the pavement.

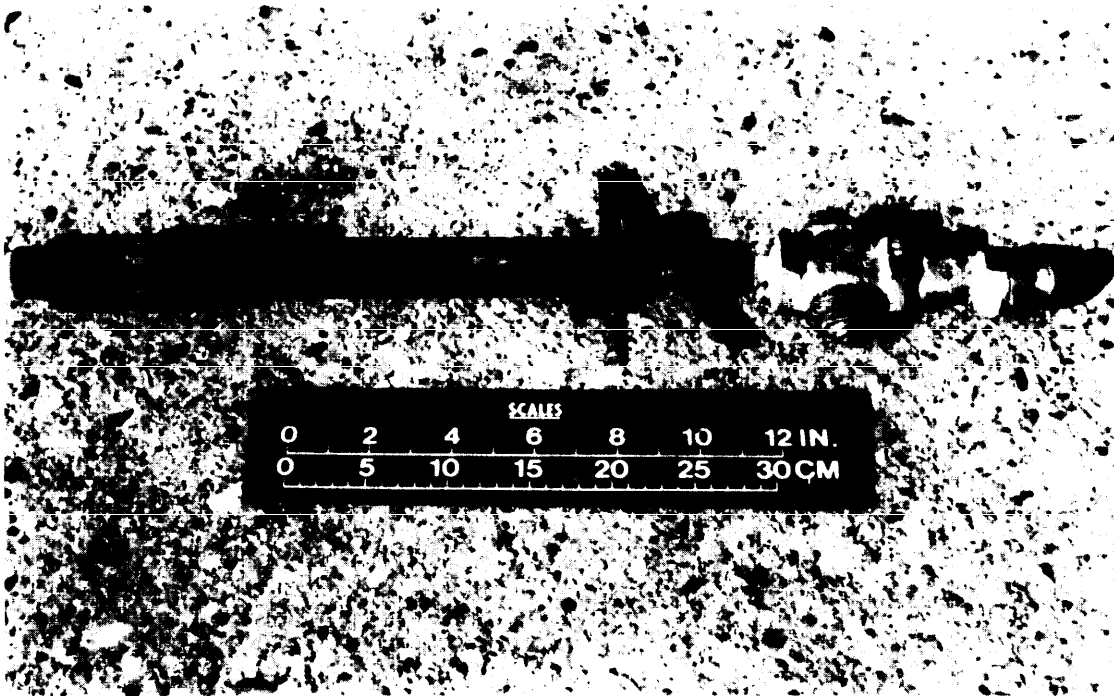

Figure 52  
Example of Expanding Rubber Packer



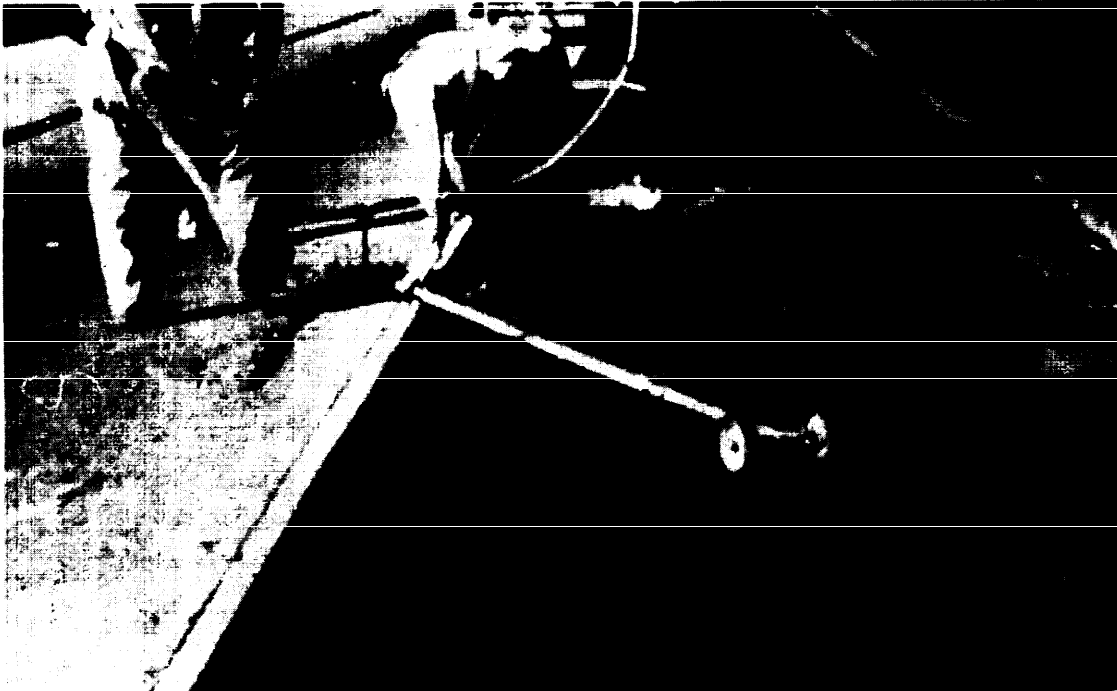

Figure 53  
Example of Device for Monitoring Slab Movement

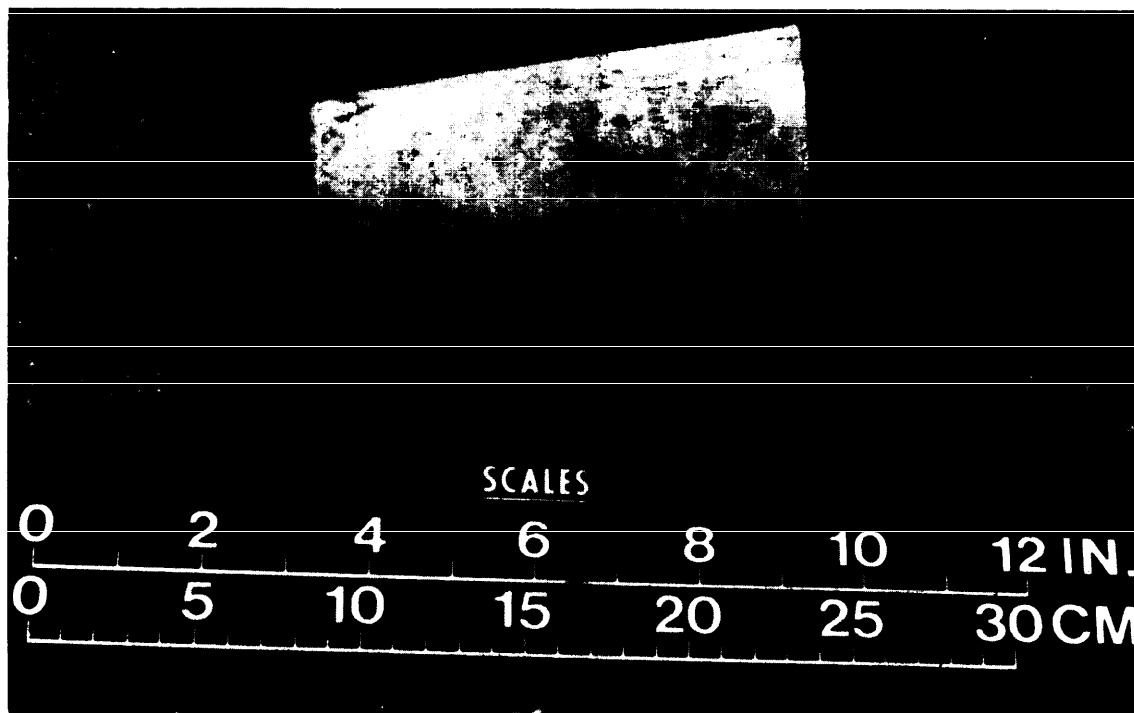

Figure 54  
Example of Tapered Wooden Plug

## Section 8: ASPHALT UNDERSEALING

8.1 Description. Asphalt undersealing is the injection of bituminous material under pavements to fill minor voids caused by pumping. Use of asphalt to fill voids greater than 1-inch (25 mm) in depth or to raise slabs is not recommended. Bituminous undersealing is mainly used to fill voids about 1/2 inch (12.7 mm) deep. Only asphalt especially prepared for undersealing should be used. Recommended asphalt should have a penetration range of 15 to 30, a softening point range of 180 to 200 degrees Fahrenheit (82.2 to 93.3 degrees Centigrade), be of suitable consistency for pumping when heated to a temperature of 400 to 500 degrees Fahrenheit (204.4 to 260.0 degrees Centigrade), and be resistant to displacement in the pavement when cooled.

8.2 Procedure. The method of placing bituminous undersealing is practically the same as that used for cement grout undersealing. The asphaltic cement should be heated in the bituminous distributor tank to a temperature of between 400 and 450 degrees Fahrenheit (204.4 to 232.2 degrees Centigrade). All water should be removed from beneath the slab with compressed air prior to pumping of the hot asphalt. The tapered nozzle on the asphalt hose is driven tightly into the drilled hole and asphalt injected under pressure. The nozzle should be allowed to remain in a hole for approximately 1 minute after pumping ceases and pressure is reduced and then will be removed and the hole plugged. Pumping pressures should range from 20 to 40 pounds per square inch (0.14 to 0.27 MPa) under normal conditions. During pumping, water should be sprayed on the pavement adjacent to the drilled holes to prevent discoloration of the surface; water saturated with hydrated lime is considered most suitable since spilled asphalt will then chill quickly and can be easily removed. Asphalt seeping up through cracks or joints can be quickly chilled and hardened by application of cold water.

## Section 9: DIAMOND GRINDING

9.1 Purpose of Grinding. Diamond grinding removes faults, reprofiles pavements, removes surface defects, and restores a smoothness to the pavement surface. Because the hardness of the aggregate will influence the grinding operation, the type of aggregate in the portland cement concrete pavement should be identified when the grinding work is contracted.

9.2 Need for Grinding. When a pavement survey reveals surface defects such as faulted joints in excess of 1/8 inch (3 mm), roughness in excess of 1/8 inch (3 mm) in a 10-foot (3.05 m) length, or rutting up to 3/8 inch (9.5 mm) diamond grinding should be considered. If skid resistance is to be examined, it should be examined on the areas not scheduled for grinding for any of the previously mentioned defects. If a large area requires grinding to improve skid resistance, economics may favor grinding the entire pavement surface.

9.3 Grinding Process. The diamond grinding process is free of impact and does not damage joints. The pavement grinder is similar to a wood plane. The front wheels are designed to pass over a fault or bump, the cutting head shaves it off, and the rear wheels ride in a smooth path left by the cutting head.

Diamond grinding requires heavy, specially designed equipment (Figure 55) that uses diamond saw blades gang mounted on a cutting head (Figure 56). Spacers are placed between the saw blades to reduce the amount of cutting that is to be done. This combination of saw blades and spacers gives the pavement the characteristic corduroy texture that improves skid resistance.

9.4 Test Section. Before work begins, the equipment should be used in a test section to ensure that proper blade spacing is being used for the specific aggregate on the project. The width of the spacers between the saw blades is varied depending on the hardness of the aggregates. The harder the aggregate the thinner the spacing between the blades.

As the diamond grinding head cuts the surface of the pavement, thin fins of concrete are left between the cutting blades. These fins should break off during the grinding process. If these fins do not break off, a grinding head with thinner spacers should be used.

When grinding aggregate susceptible to polishing, the spacing must be wider to provide more area between the blades. The grinding chip thickness measured at the thickest point should be 0.080 inch (2 mm) minimum and have an average thickness of 0.1-inch (2.5 mm). For harder aggregates not subject to polishing, the minimum chip thickness should be 0.065-inch (1.7 mm) and an average of 0.080-inch (2 mm).

## 9.5 Grinding Procedure

9.5.1 Roughness Removal. When areas have been identified as being too rough, a level of restoration must be set and sections having excess roughness ground. Following grinding, the roughness should be tested again. Testing is typically accomplished using equipment such as the California Profilograph (Figure 57) or the Mays Ride Meter. Prior to grinding, the grade should be established. The old pavement surface should not be used as the reference unless a long beam or skid is used. Where sags in the pavement are encountered,

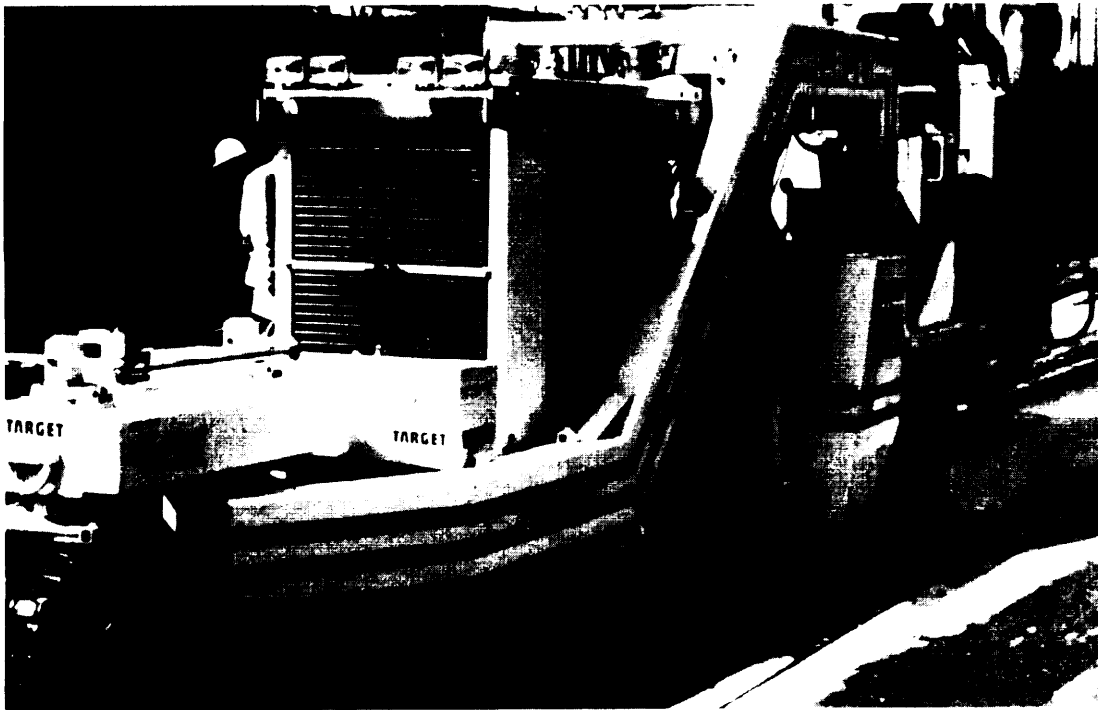

Figure 55  
Example of Grinding Machine



Figure 56  
Example of Gang-Mounted Diamond Saw Blades

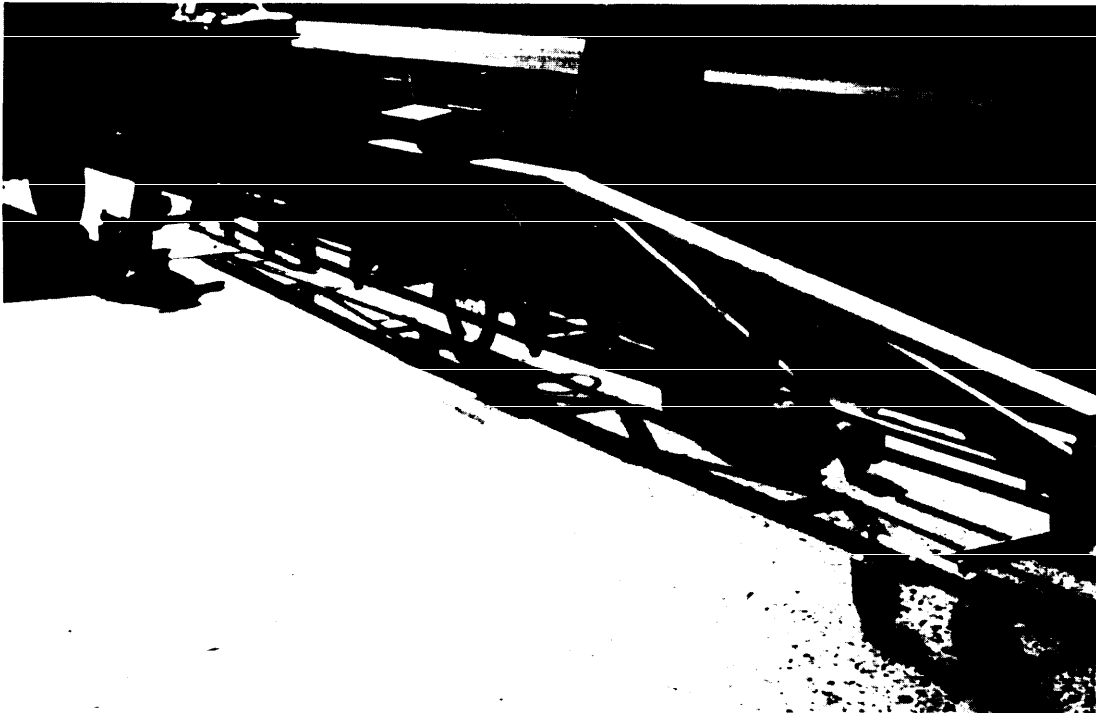

Figure 57  
California Profilograph

the sags should be removed by slabjacking. Grinding a sag will not remove roughness. The pavement should be reinvestigated following slabjacking to determine if grinding requirements were altered.

9.5.2 Fault Removal. Prior to grinding the faulted joints, the slabs should be undersealed to prevent the fault from recurring. The joints must be cleaned, resawed to the proper depth, and resealed. This is necessary to prevent infiltration of water from the grinding operation. Grinding should cut into faulted joints--this produces smoother joints and a more efficient operation.

The fault must be feathered back some distance into the slab. The distance required depends on the allowable roughness. The American Concrete Paving Association has a general guideline of 1 foot (0.30 m) for every 0.1 inch (2.5 mm) of faulting. This is slightly rougher than 1/8 inch (3 mm) in 10 feet (3.05 m). Feathering distance necessary to meet straight edge requirements of 1/8 inch (3 mm) in 10 feet (3.05 m) are:

<u>Fault Distance</u> inches	<u>Feathering Distance</u> feet
1/8	2.5
1/4	5.0
3/8	7.5
1/2	10.0
5/8	12.5
3/4	15.0

If the entire slab is to be ground, the depth of cut to remove the fault will be feathered out to the next joint.

9.5.3 Improving Skid Resistance. Improving skid resistance can be accomplished by the grinding process and should only be done on those lanes needing the treatment. The edges of the ground areas should be feathered into the adjoining areas to eliminate a sharp drop off.

The pavement should be ground in a longitudinal direction that begins and ends at lines normal to the pavement center line. The grinding operation should produce a uniform finished surface free of joint or crack faults and provide positive lateral surface drainage. The removal of slurry residue resulting from the grinding operation should be continuous. Grinding slurry should not be permitted to flow across adjacent lanes, into gutters, or other drainage facilities.

9.6 Acceptance Testing. After completion of the grinding and texturing, the pavement should be tested for smoothness. The pavement should meet the specifying agency's surface tolerance for a new pavement.

The test equipment to be used in the acceptance testing should be the same as that used in the initial evaluation and should be specified along with procedures to be followed in acceptance testing.



## Section 10: LOAD TRANSFER RESTORATION

10.1 Purpose of Load Transfer Restoration. New pavement joints typically exhibit good load transfer, particularly if the joints are doweled. However, repeated heavy loads can cause an elongation of the dowel sockets, resulting in dowel looseness and a reduction of load transfer efficiency. As load transfer efficiency decreases, many types of distress rapidly increase, including pumping, spalling, faulting, and slab cracking. Restoration of load transfer is used to retard further deterioration of the concrete pavement by reducing the potential for the distress and the mechanisms described above.

10.2 Need for Load Transfer Restoration. Transverse joints or cracks that would benefit from improved load transfer must be identified by measuring the existing load transfer efficiency with heavy weight nondestructive deflection testing devices such as the Falling Weight Deflectometer (Figure 58). These tests must be conducted during periods of cooler temperatures (less than about 80 degrees Fahrenheit) (26.7 degrees Centigrade) when the slab joints and cracks are not tightly closed. Joints or cracks having a measured load transfer efficiency (ratio of the deflection on the unloaded side of a joint or crack divided by the deflection of the loaded side) of less than 50 percent should be considered for load transfer restoration.

The deflection measurements should be taken as close as possible to the joint or crack, or, if measured by a sensor, in the center of the load plate and 12 inches (305 mm) across the joint. The measurements should be corrected for normal slab bending as measured in the center of the slab.

10.3 Selection of Joints/Cracks. Before any load transfer devices are installed, it is necessary to determine the cause of the joint or crack distress. Attempts should be made to correct these deficiencies prior to load transfer restoration. Heavily distressed slabs may require portions or all of the slab be replaced.

Successful installation of load transfer devices requires sound concrete adjacent to the joint or crack. If the concrete near the joint or crack is significantly deteriorated, full depth repair should be placed (with provisions for load transfer) in lieu of load transfer devices.

Additional work that must be performed prior to load transfer restoration may include subsealing (essential if loss of support exists) to fill voids in the pavement structure and to restore support to the pavement slabs, and full depth and spall repairs to replace highly distressed joints and slabs with corner breaks, "D" cracking, etc.

10.4 Methods of Restoration of Load Transfer. Two methods of restoring load transfer of existing joint or cracks have been used--proprietary shear devices and dowels. Short term experience indicates that both methods can be effective in transferring loads across joints and cracks.

Proprietary shear devices such as the Double Vee Device and the Plate Stud Connector have been used and are reported to be effective for load transfer across joints and cracks.

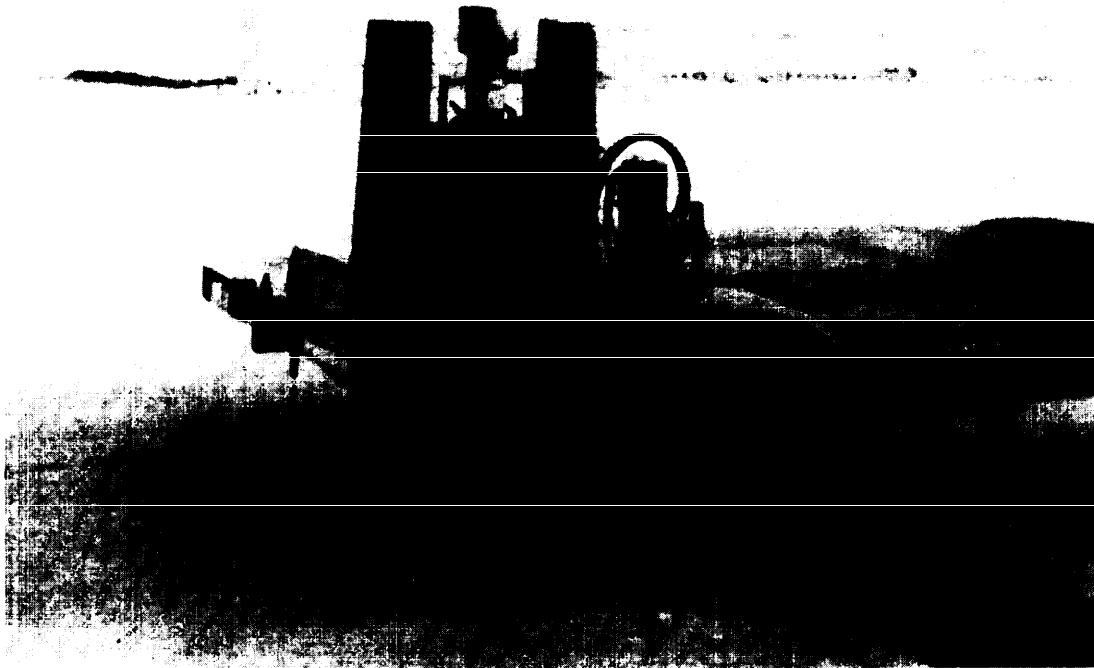

Figure 58  
Falling Weight Deflectometer

10.5 Dowels. The important functions of dowels or any other load transfer device in concrete pavements are to:

- a) Maintain alignment of adjoining slabs.
- b) Limit or reduce stresses resulting from loads on the pavement.

Different sizes of dowels should be specified for different thicknesses of pavements. Dowel size and spacing for construction, contraction, and expansion joints are:

<u>Pavement Thickness inches</u>	<u>Minimum Dowel Length inches</u>	<u>Maximum Dowel Spacing inches</u>	<u>Dowel Diameter and Type</u>
8	16	12	3/4-inch bar
8-11.5	16	12	1-inch bar
12-15.5	20	15	1 to 1 1/4-inch bar or 1-inch extra-strength pipe
16-20.5	20	18	1 to 1 1/2-inch bar or 1 to 2 1/2-inch extra-strength pipe
21-21.5	24	18	2-inch bar or 2-inch extra-strength pipe
>26	30	18	3-inch bar or 3-inch extra-strength pipe

When extra-strength pipe is used for dowels, the pipe should be filled with either a stiff mixture of sand-asphalt or portland cement mortar, or the ends of the pipe should be plugged. If the ends of the pipe are plugged, the plug must fit inside the pipe and be cut off flush with the end of the pipe so that there will be no protruding material to bond with the concrete and prevent free movement of the dowel.

10.6 Dowel Installation. When using smooth steel dowels, slots for the dowels are cut using diamond bladed saws (Figure 59); multiple bladed saws may be used to speed operations. The slots should be cut so that the dowels are allowed to rest horizontally and perpendicular to the crack or joint and at mid-depth of the slab (Figure 60). Light weight chipping hammers are used to remove the concrete within the slots. The slot is then cleaned by sandblasting or any method that will ensure removal of all sawing residue, dirt, or oil that may prevent bonding of the patch material to the slot faces.

Each dowel is placed upon a support chair to allow the patch material to surround the dowel. Unless it is certain that the joint or crack is completely closed at the time of repair, grease and an expansion cap should be placed on one end of the dowel (Figure 61). The dowels must be provided with a filler board or styrofoam material at mid-length to prevent intrusion of the patch material into the joint or crack and to form the joint in the slot (Figure 62).

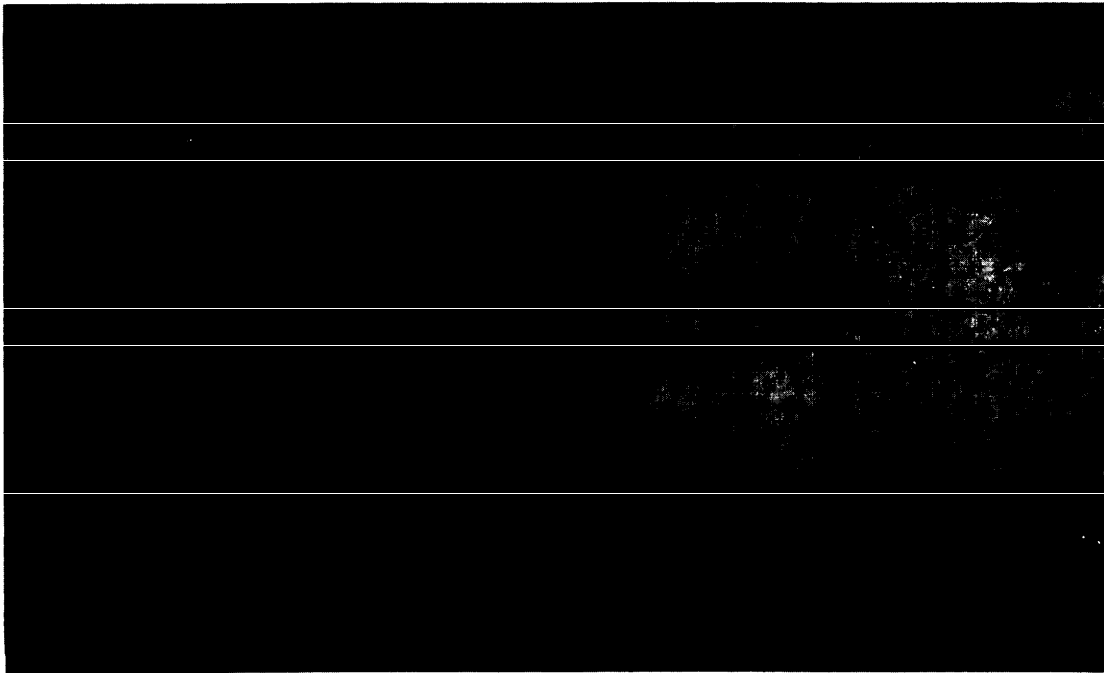

Figure 59  
Example of Saw Cuts for Dowel Bar Installation

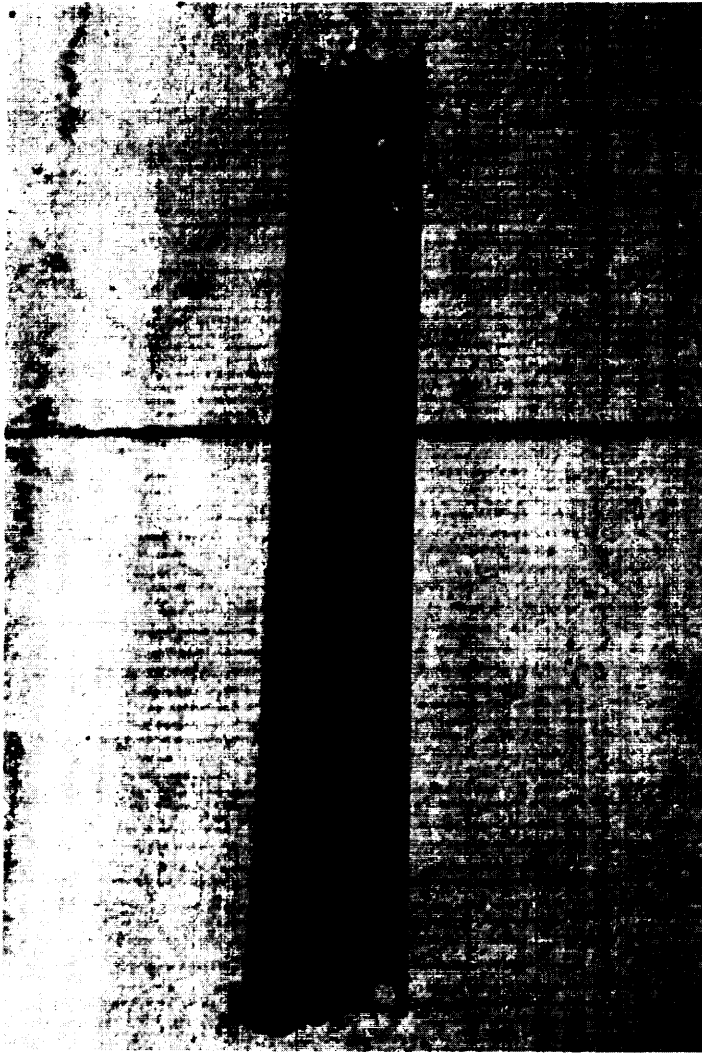

Figure 60  
Example of Installed Dowel Bar

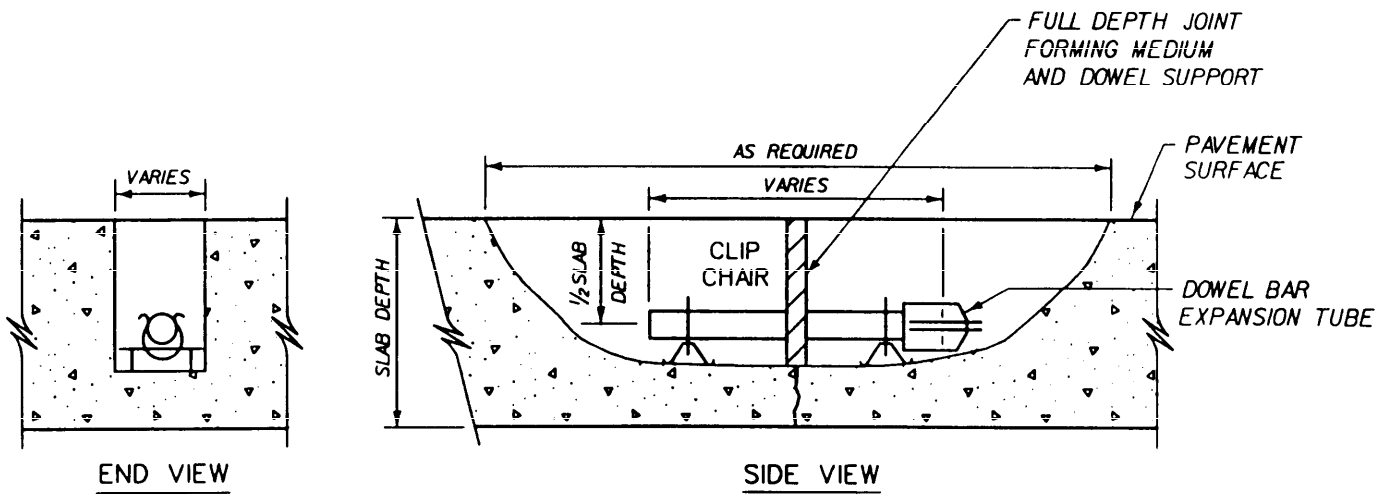

Figure 61  
Section View of Dowel Bar Installation

10.7 Shear Device Installation. The placement of proprietary shear devices must be done in accordance with the manufacturer's recommendations. The following are general recommendations for the Double Vee Device:

a) Core a 6-inch (152 mm) diameter hole centered over the joint or crack (Figure 63), the core hole should extend entirely through the slab depth and should be cored in the coolest weather possible. The core sidewalls should be grooved to assist in creating a mechanical interlock (Figure 64). The core hole sidewalls are then roughened by sandblasting or brushed clean to keep dust from interfering with bond of the patch material with the existing slab. The joints or cracks, and the bottom of the core hole must be completely sealed to prevent loss of the liquid portion of the polymer concrete.

b) The pre-compressed Double Vee Device is inserted and properly oriented with the joint or crack at a depth of 1 inch (25 mm) below the slab surface. A joint sealant reservoir must be provided at the top of the slab above the shear device (Figure 65).

10.8 Patching Material. Polymer concretes and high early strength portland cement concrete have been used in most installations to date.

The quality of the patch material used with load transfer devices is the most critical factor in performance, particularly with shear devices. Sufficient bond must be established between the device and the patching material as well as between the existing concrete and the patching material. For this reason, a thorough laboratory evaluation must be made of any patch material utilized for the load transfer devices. Prime factors which must be evaluated are working time, rapid early strength gain, and shrinkage.

10.9 Placing Patching Materials. After the patch area has been properly cleaned, a bonding agent should be applied (Figure 66). The type of bonding agent will depend on the bond development requirements for opening to traffic and type of patching material used. The manufacturer's recommendations should be followed with all patching materials. Bonding agents should be that recommended by the manufacturer for the placement conditions.

The patch material should be placed and consolidated to eliminate essentially all voids at the interface of the patch and the existing concrete and at the load transfer device and the patch (Figures 67 and 68).

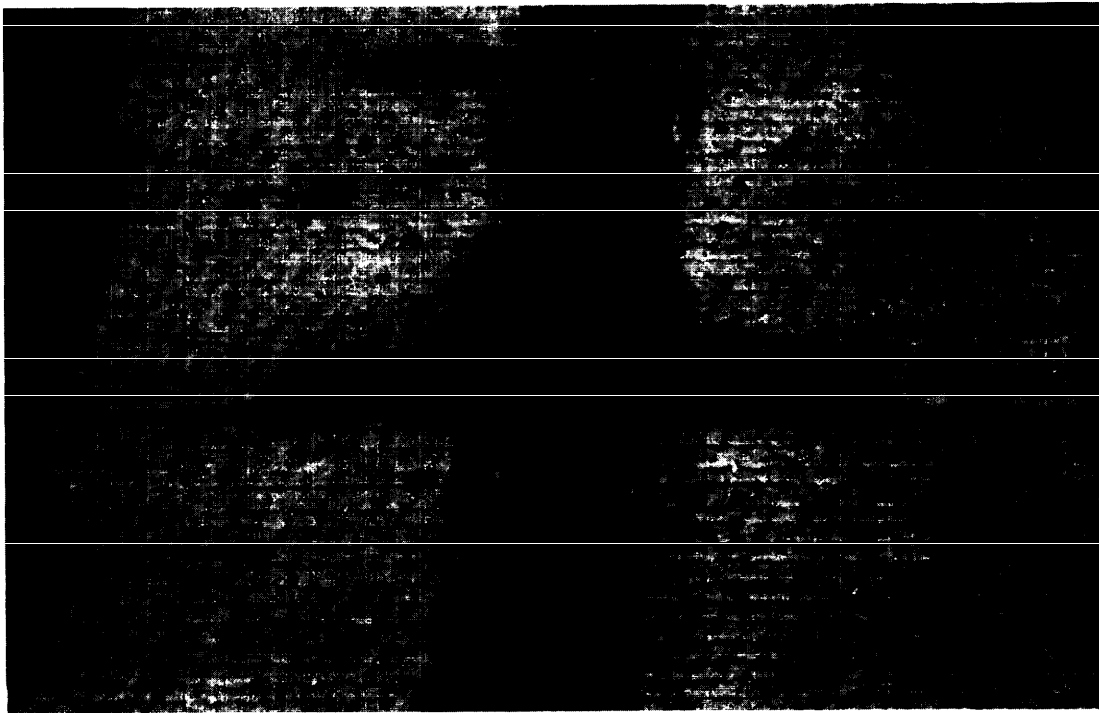

Figure 62  
Example of Filler Board in Completed Repair



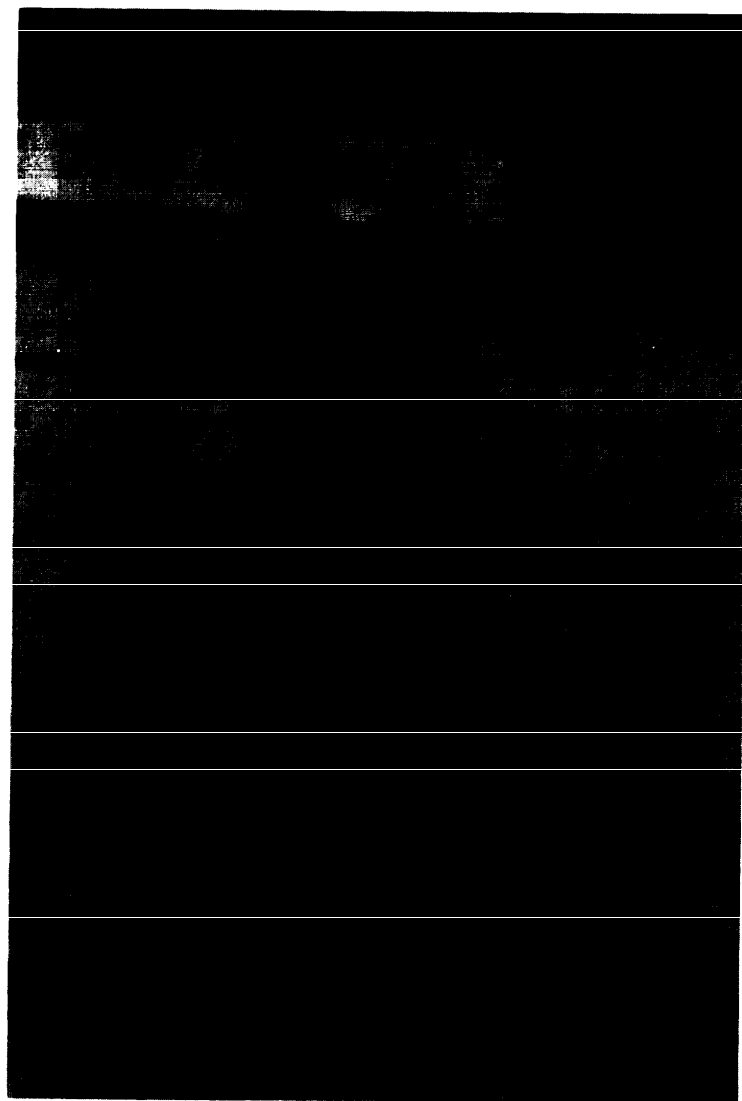

Figure 63  
Example of Core Drill

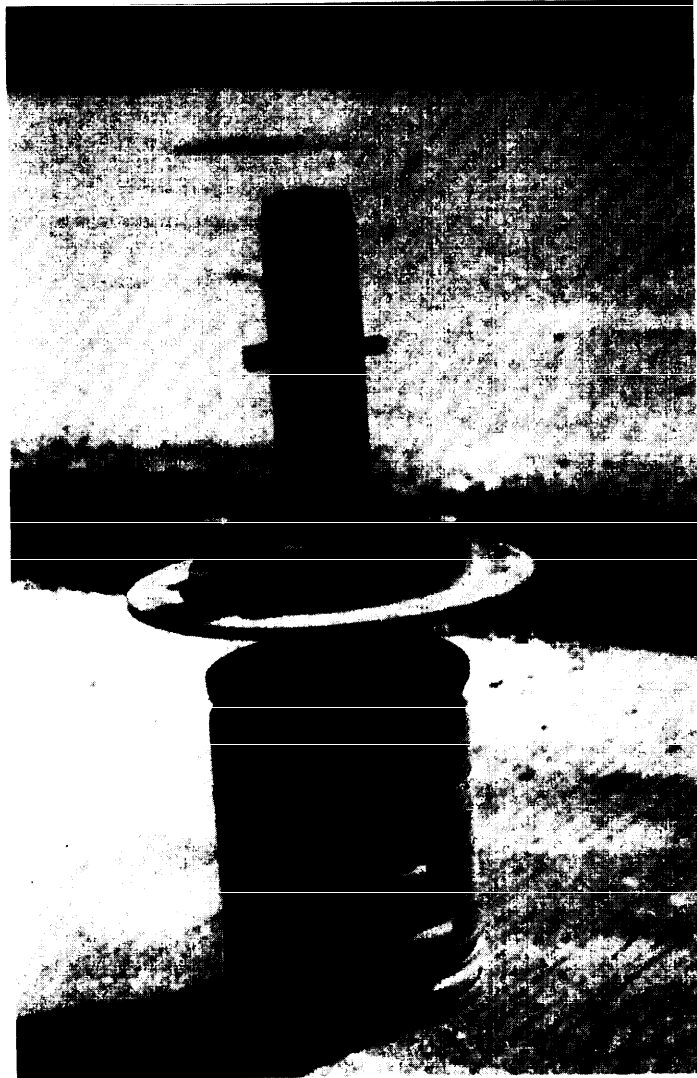

Figure 64  
Device for Grooving Core Hole Walls

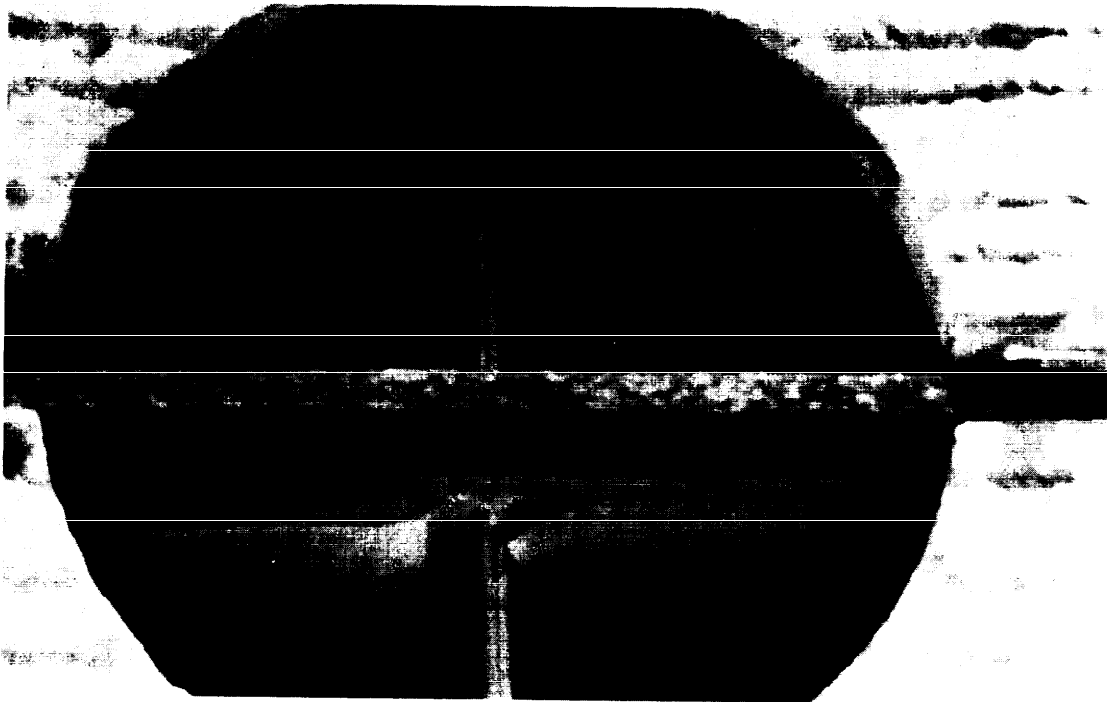

Figure 65  
Example of Inserted Double V-Device (Note Grooved Walls)

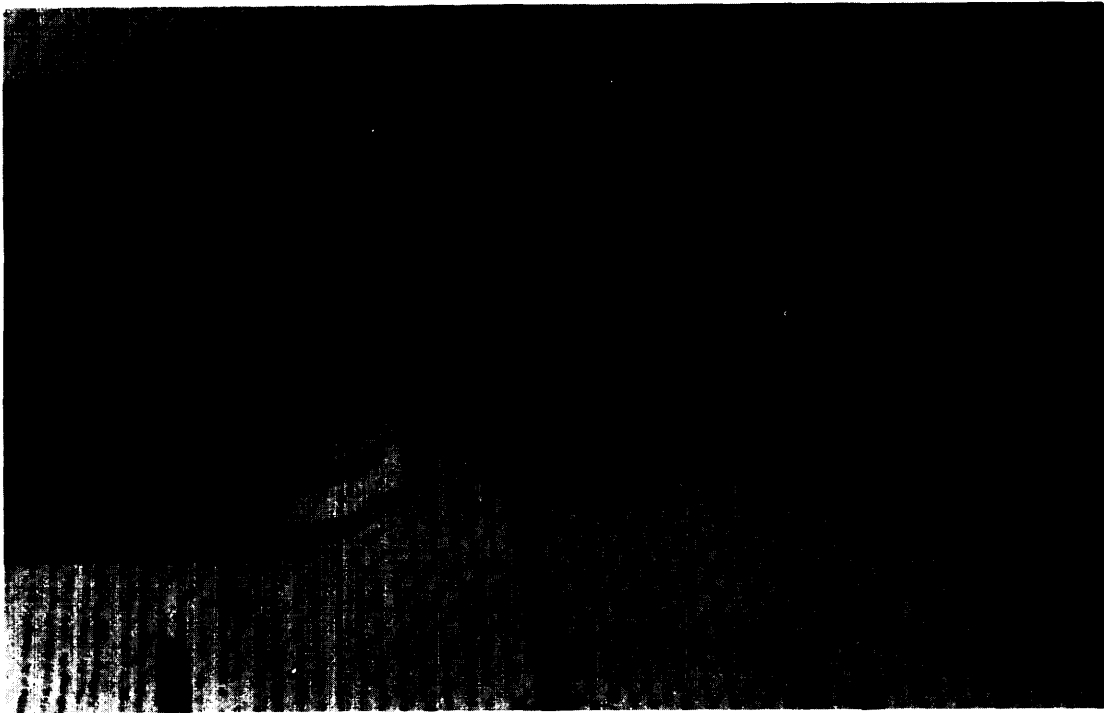

Figure 66  
Example of Bonding Agent Application

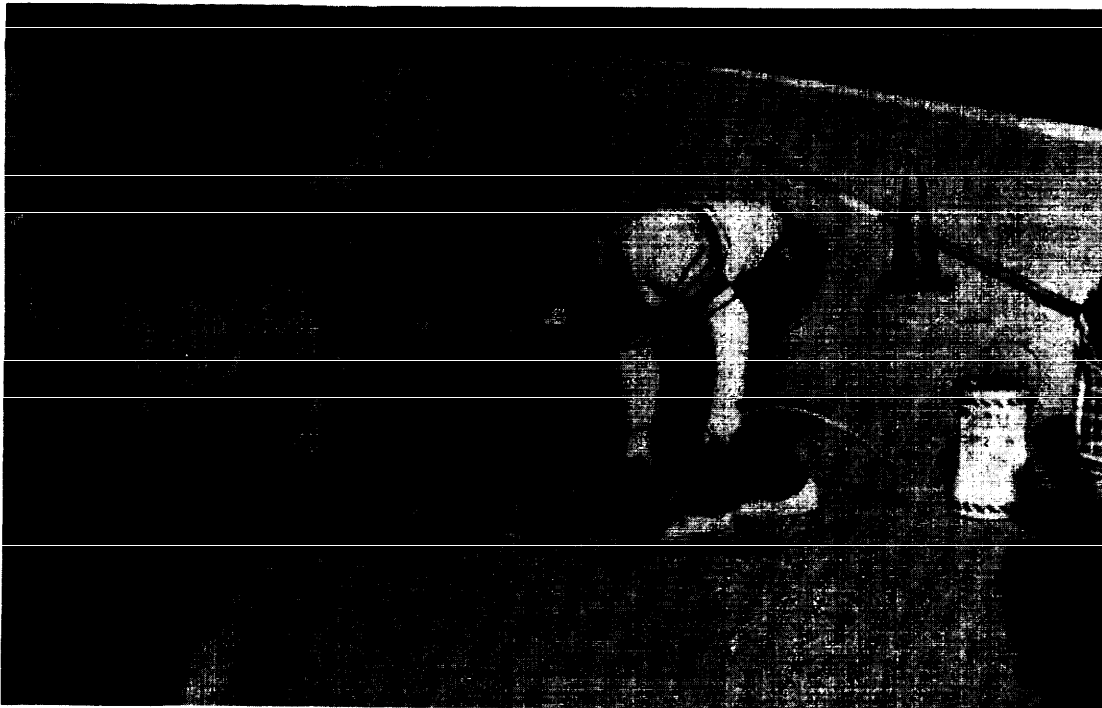

Figure 67  
Example of Placing and Consolidating Patch Material by Vibration

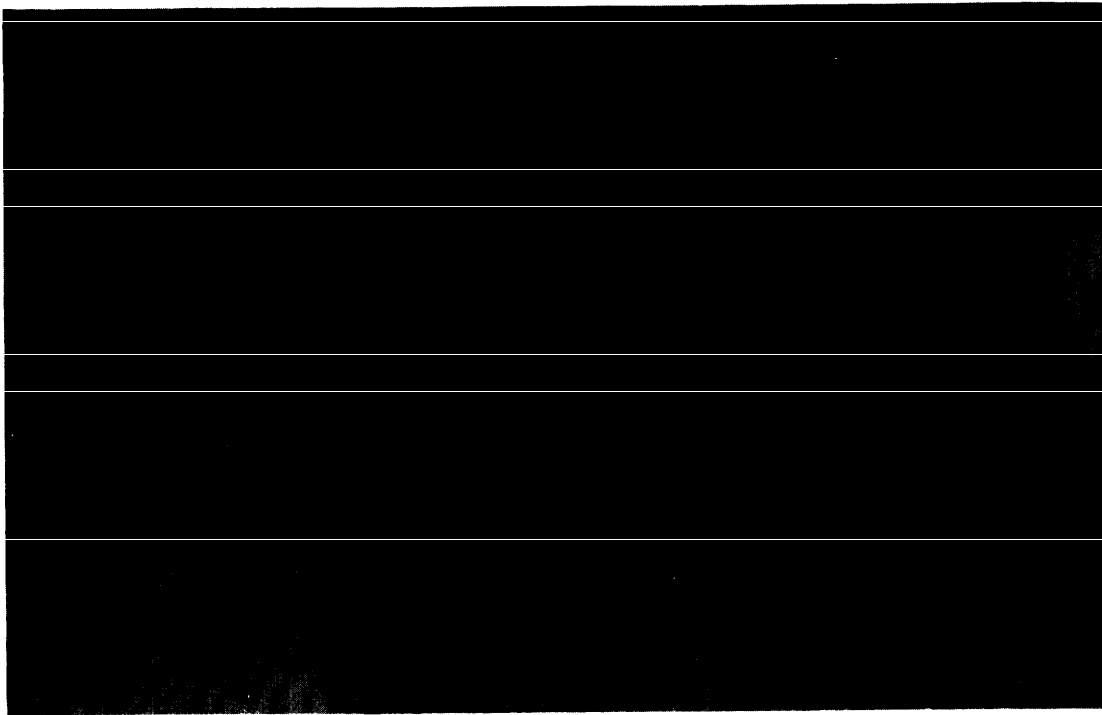

Figure 68  
Example of Consolidating Patch Material by Tamping

## Section 11: JOINT AND CRACK SEALING

11.1 Purpose of Joint and Crack Sealing. Rigid pavements that do not receive adequate joint seal maintenance will rapidly deteriorate due to the intrusion of water and incompressible materials that migrate through and into the pavement joints. Incompressible materials lodged between the individual pavement slabs restrict the area between the slabs that allows for expansion and contraction. This restriction of movement causes spalling and cracking along the joints' edges and can result in breakage and blowup of entire slabs. The intrusion of water into the joint and underlying materials causes the deterioration and failure of load transfer dowel bars. Water in the subgrade material causes a migration of fines that eventually results in loss of support under the edge of the pavement slab.

Joint or crack sealing may not be necessary in some situations. For example, pavement structures that feature free-draining bases and or subgrades may not be susceptible to moisture related damage. In addition, pavements with very low heavy traffic volumes may not benefit from joint or crack sealing. In most cases, however, joint or crack sealing is considered an effective rehabilitation technique.

11.2 Sealant Types for Concrete Pavement. There are three major types of sealant material that are used when sealing or resealing joints:

- a) Field poured hot-applied.
- b) Field poured cold-applied.
- c) Preformed elastomeric seals.

11.2.1 Field-Poured. Field-poured sealant materials are liquids at the time of application and solidify by either cooling or by physical or chemical reaction. The hot-applied sealants solidify by cooling and are referred to as thermoplastic-type materials. The cold-applied materials are referred to as thermosetting because their actions are irreversible. These sealants may be classified as either jet-fuel resistant or non-jet-fuel resistant.

11.2.2 Preformed Elastomeric. Preformed elastomeric seals are solid at the time of installation and therefore must be sized for a given joint. Not all preformed seals are jet-fuel resistant.

11.2.3 Others. Other joint and crack sealing materials that are coming more into use include silicon and nitrile rubber.

11.2.4 Silicone Joint Sealant. Silicone joint sealant is a one-part silicone formulation that can be installed over a wide temperature range. It cures on exposure to atmospheric moisture to form a flexible, low modulus, high elongation, silicone rubber joint seal. Primer is not required on most applications. During application, no heating or cooling of the sealant is required, as the material consistency remains relatively unchanged.

11.2.5 Nitrile Rubber Sealant. Nitrile rubber sealant is a one-part solvent evaporation curing material. Primer is not required for bonding to concrete. During application, heating is not required, it may be applied to damp surfaces without loss of adhesion.

All sealants must have the capability to withstand the effects of the environment, such as extreme temperatures, moisture, object intrusion, and ultraviolet light.

11.3 Sealant Removal. All old sealant and or joint filler must be removed. The tools and techniques used for removal of the existing sealant or joint filler will be determined by the material in the joint and available equipment. The old sealant can be removed by cutting, plowing, or saw cutting, which also widens the joint to the required dimensions.

Removal of field-poured sealant is usually accomplished using a rectangular or square-shaped joint plow of the proper size (Figure 69). The joint plow cutting tool should be equipped with a properly adjusted spring or hydraulic holding device (Figure 70) so that contact with any wedged foreign object, irregular joint wall surface, nonalignment, or joint at intersections will release pressure on the cutting tool prior to causing damage along the joint edges (Figure 71). If the plow tools are sized properly, it will not be necessary to exert excessive force to remove the old sealant. If excessive force is being used, a smaller sized tool should be used. V-shaped plow tools (Figure 72) must not be used because they will spall and chip the concrete without completely removing the old sealant. Hand tools are required to remove sealant in areas where mechanized removal equipment cannot operate.

Other methods such as high pressure water blasting and power-driven concrete saws with diamond or abrasive blades may also be effective. Preformed elastomeric compression seals can be removed by hand when lengths are short. Longer length can be started by hand and then tied to a tractor, and the tractor can pull the seal out of the joint.

11.4 Refacing Joints. Some joints will require sawing to produce the depth and width required in the specifications (Figure 73). The sawing will also provide clean joint faces to which the field-poured sealant can bond. Refacing the joint will also provide vertical sidewalls which will prevent the new sealant from being pushed out of the joint. Joints that are greater than 1-1/8 inch (28.6 mm) wide should not be widened unless they are expansion joints. When preformed compression seals are removed, refacing is generally not required unless the joint width is smaller than required or spalling has occurred.

11.5 Rebuilding Joints. Joints that are wider than 1-1/8 inch (28.6 mm) or that are severely spalled should be examined to determine if rebuilding is required. If preformed elastomeric seals are being installed, the condition of the joint sidewalls must be excellent. Field-poured sealants may preform adequately with some minor spalling present (spalls less than 2 inches (50 mm) in width). Joints should be rebuilt in accordance with Section 5 using appropriate materials.

11.6 Cleaning Joints. Once the old sealant has been removed and any required refacing or rebuilding of the joints has been accomplished the joints are ready for cleaning. Failure to properly clean the joints is the leading cause of joint sealant failure. The joints can be cleaned by using multiple passes of sandblasting (Figure 74) or waterblasting (Figure 75). If waterblasting is used, the joint must be thoroughly dried by airblowing afterward to remove all moisture.



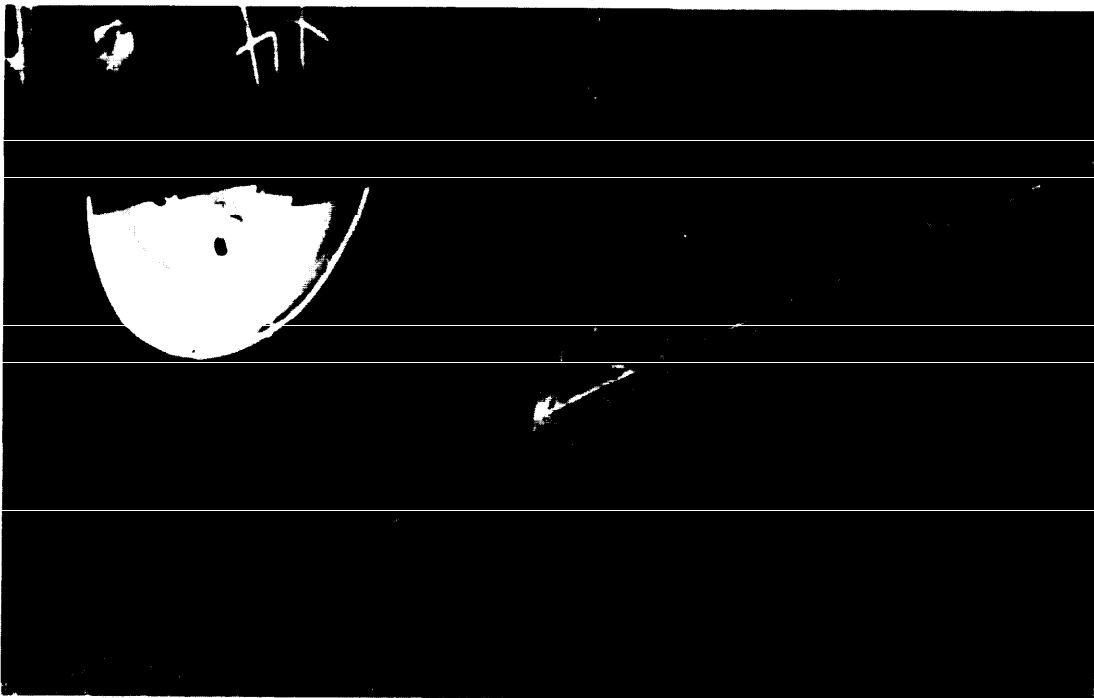

Figure 69  
Example of Rectangular Joint Plow



Figure 70  
Example of Joint Plow with Spring-Holding Device

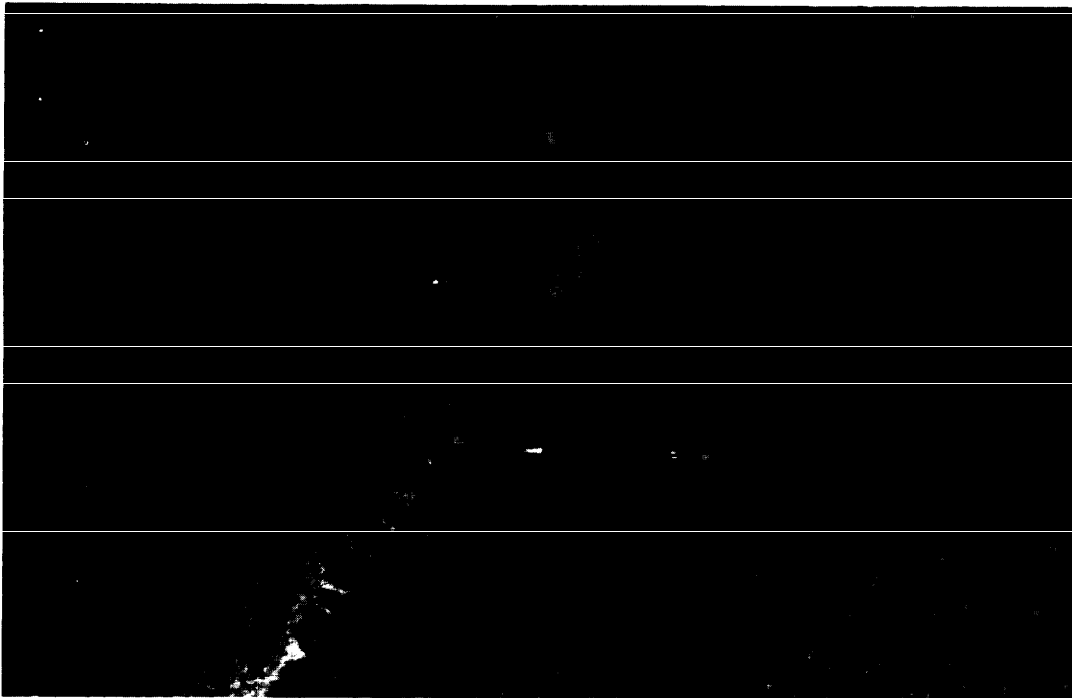

Figure 71  
Example of Joint Damage Caused by Improper Plowing

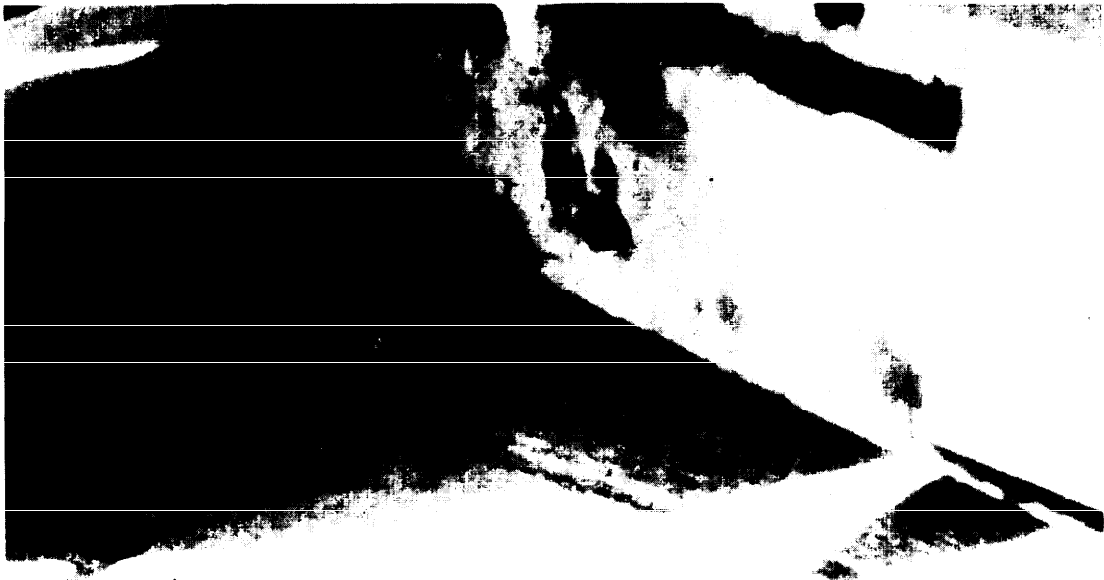

Figure 72  
Example of V-Shaped Plow Tool (Do Not Use)

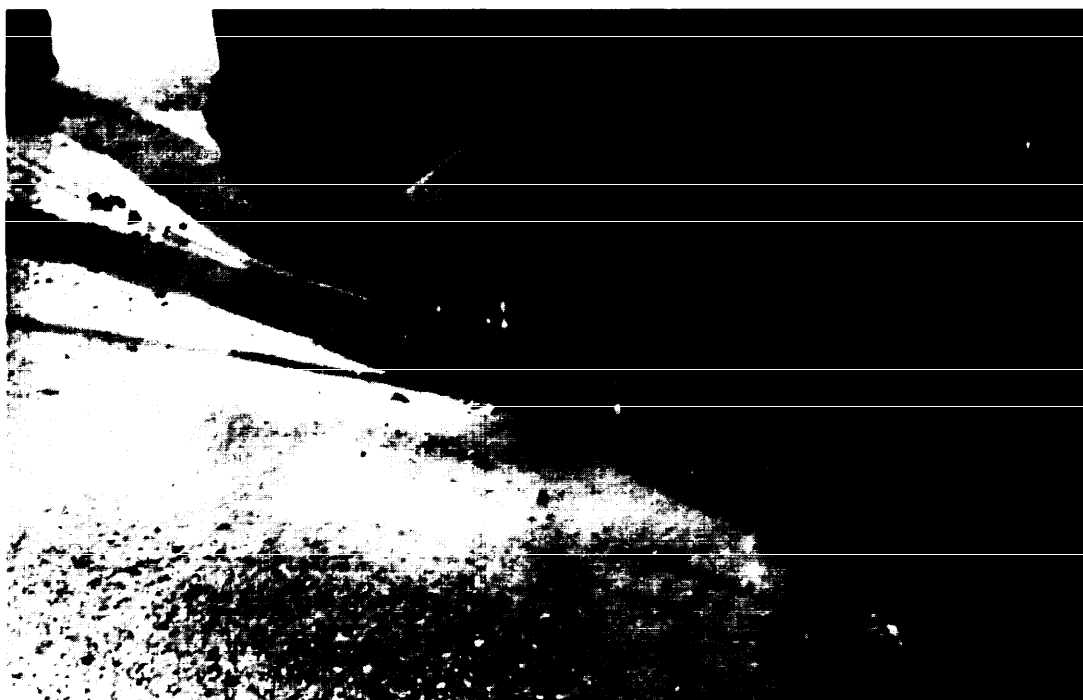

Figure 73  
Example of Joint Refacing by Sawing

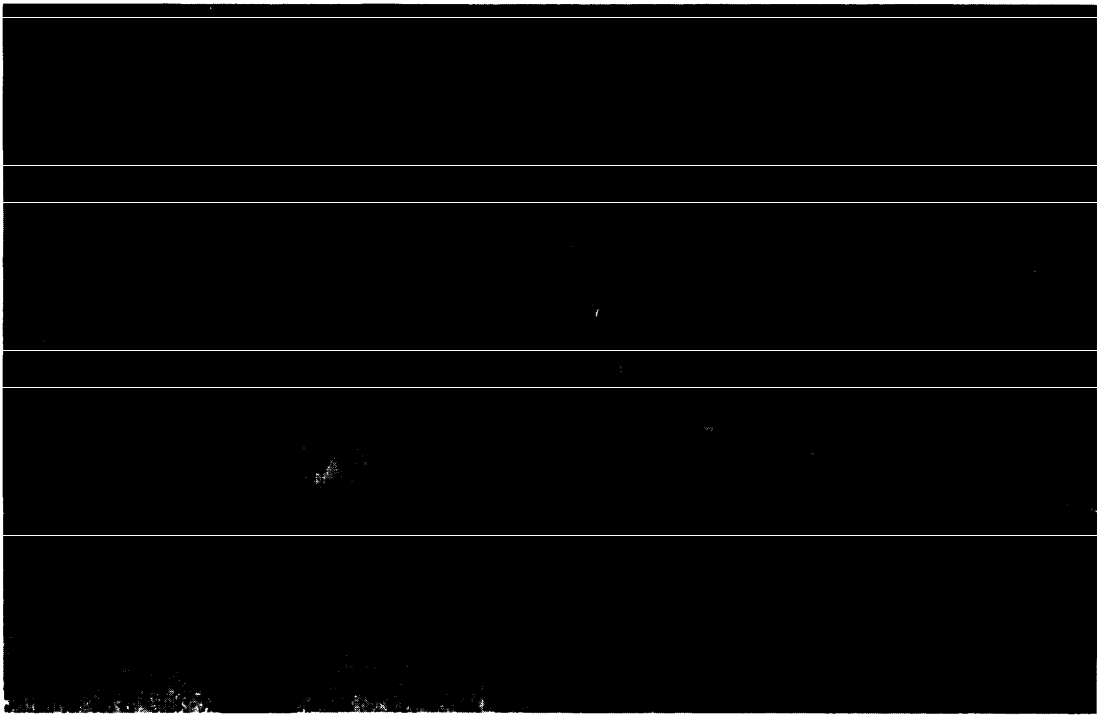

Figure 74  
Example of Joint Cleaning by Sandblasting



Figure 75  
Example of Joint Cleaning by Waterblasting

Another technique that has been used successfully is dry sawing. Dry sawing is accomplished by using a diamond blade concrete saw without water. The blade of the saw is placed against one of the joint faces to allow the minimal removal of concrete. After one joint face is finished, the opposite joint face is dry sawed. The final step of cleaning the joint is airblowing to remove remaining dust and debris. Airblowing should be accomplished just prior to installing the backer or separating material and sealing the joint.

Backer or separating material serves the same purpose in old joints as in new joints--to prevent three-sided adhesion and to provide the correct shape factor. In an old joint, it also prevents compatibility problems between the new sealant and any old sealant that remains in the bottom of the joint.

11.7 Crack Preparation. Cracks are normally irregular in dimension and direction, making them more difficult to prepare and seal. Because of the irregular nature, the equipment used to prepare joints may not be suitable. The techniques change, however, the procedures remain basically the same. Former plastic shrinkage cracks and other fine, non-deteriorated cracks should not be routed and sealed; they are best left unsealed until signs of unacceptable deterioration becomes apparent.

11.8 Sealant Removal. Sealant removal is usually accomplished using hand tools. Mechanical devices often do not adequately remove the sealant because the sealant becomes tacky when subjected to the heating action of mechanical bits and saws.

11.9 Routing of Cracks. Routing of the crack is accomplished using a vertical spindle router. The machine is equipped with a bit that rotates around its vertical axis similar to a drill. Rotary impact routers should not be used on concrete pavements because they spall the concrete. Power-driven concrete saws may also be used, if the crack is straight enough. Small diameter blades (6 inches (152 mm) or less) may be used to more closely follow the crack. The blade thickness should be 1/8 to 1/4 inch (3 to 6 mm) wider than the crack to remove all damaged pavement. A small width blade may be used if two passes are made, one on each side of the crack. This produces a sealant reservoir similar to those of a prepared joint. The reservoir of a crack should be similar to those of a normal joint.

11.10 Cleaning Cracks. Once the crack has been routed and damaged areas repaired, it is cleaned and dried in the same manner as joints.

Cracks that have a depth greater than 3/4 inch (19 mm) will require a backer material to maintain the proper shape factor and to support the sealant.

11.11 Sealing Operations. When the joints or cracks have been properly prepared and materials and equipment approved, the sealing operation can begin. Joint or crack preparation and the sealing operation are a continuous process. Prepared joints or cracks should not be left for more than one day, and it is recommended that preparation not be completed on more joints than can be sealed in one working day.



11.11.1 Lower Portion. The lower portion of the joint reservoir should be plugged or sealed at a uniform depth with backer material to prevent entrance of the sealant below the specified depth (Figure 76). The size of the backer material should be approximately 25 percent wider than the nominal width of the joint. The backer material should be compatible with the sealant used.

11.11.2 Backer Material. The backer material should not be stretched, twisted, or otherwise damaged during installation. When the existing sealant has been removed to the required depth and the bottom of the joint opening is formed by a previously installed material such as in an expansion joint, a nonreactive separating material should be inserted in lieu of a backer material (Figure 77). This separating material should be 1/8-inch (3 mm) wider than the width of the joint. The separating material prevents compatibility problems between the new sealant and any old sealant that remain in the bottom of the joint and prevents three sided adhesion.

11.11.3 Temperature. Sealant should not be placed unless the joint is dry and clean. The face of the joint should be surface dry and the temperature of the pavement and atmosphere should be at least 50 degrees Fahrenheit (10 degrees Centigrade) at the time of application of sealant. Installation of the sealant should be such that the in-place sealant will be well bonded to the pavement faces and free of entrapped air. This can be accomplished by applying the sealant under pressure from the bottom of the reservoir to the top. A standard recess of 1/8 to 1/4-inch (3 to 6 mm) is required to prevent damage to the sealant. In cases where the pavement is faulted or where future surface grinding is anticipated, the backer material and sealant may be installed deeper than normal so that after grinding the sealant is at the recommended recess. Any areas damaged by grinding should be repaired.

11.11.4 Examination. During the sealing operations, all joints and cracks should be examined in a continuous and repetitive process. Items that should be examined include:

a) Bond. When the sealant has cooled or cured, several joints should be examined to determine if the sealant has bonded to the concrete. The sealant should not separate from the joint faces when pulled lightly with the fingertips across the joint. If the sealant separates easily from the joint face, the area of the sealant that was in contact with the concrete should be examined for debris. Traces of debris indicate that the joint face was probably not prepared adequately.

b) Curing. Puncture the sealant with a wire or pin to determine if the sealant is curing. If the sealant adheres to the pin or wire, the sealant has not cured. If the sealant does not cure in the recommended time, the uncured sealant must be replaced.

c) Floating material. No backer material should be floating in the sealant.

d) Over or underfilled. Joints or cracks should not be over or underfilled.

e) Spills. All spilled sealant should have been removed.

f) Debris. No debris should be left on the pavement surface.

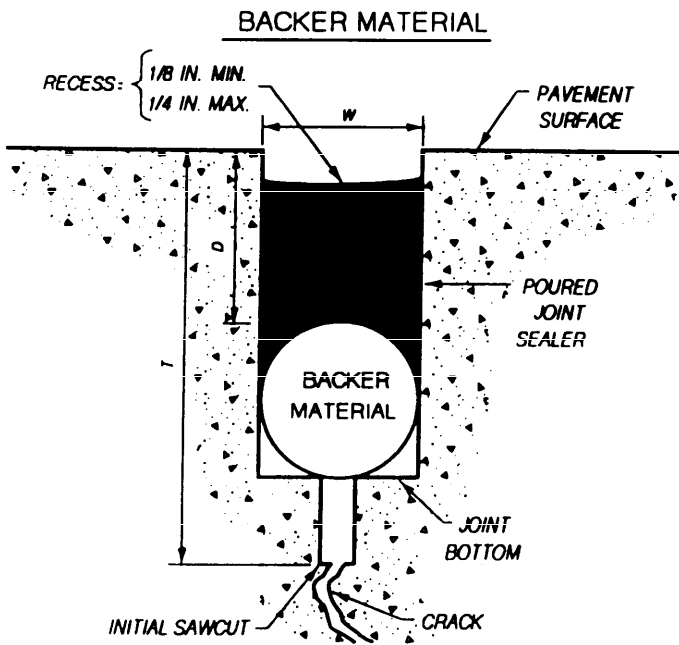

W: WIDTH OF SEALANT RESERVOIR (SEE TABLE 1)

D: DEPTH OF SEALANT (1.0 TO 1.5 x W)

T: DEPTH OF INITIAL SAWCUT

- a. 1/4 SLAB THICKNESS FOR PAVEMENTS LESS THAN 12 IN.
- b. 3 IN. FOR PAVEMENTS 12-18 IN.
- c. 1/8 SLAB THICKNESS FOR PAVEMENTS MORE THAN 18 IN.

TABLE 1

JOINT SPACING FT	WIDTH, IN.	
	MIN.	MAX.
<25	1/2	5/8
25-50	3/4	7/8
>50	1/0	1-1/8

NONABSORBENT BACKER MATERIAL REQUIRED TO PREVENT SEALANT FROM FLOWING INTO SAWCUT; TO SEPARATE NONCOMPATIBLE MATERIALS AND PREVENT JOINT SEALANTS FROM BONDING TO BOTTOM OF RESEVOIR.

Figure 76  
Joint Reservoir Using Backer Material

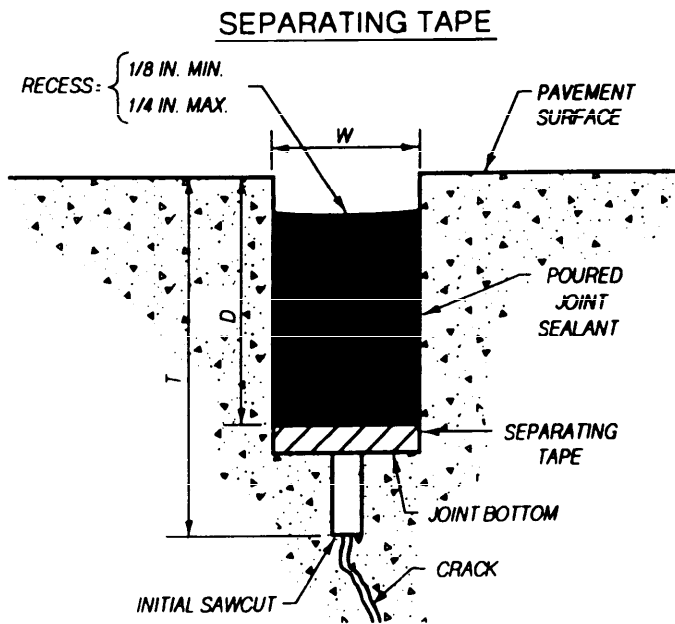

W: WIDTH OF SEALANT RESRVOIR (SEE TABLE 1)

D: DEPTH OF SEALANT (1.0 TO 1.5 x W)

T: DEPTH OF INITIAL SAWCUT

- a. 1/4 SLAB THICKNESS FOR PAVEMENTS LESS THAN 12 IN.
- b. 3 IN. FOR PAVEMENTS 12-18 IN.
- c. 1/6 SLAB THICKNESS FOR PAVEMENTS MORE THAN 18 IN.

Figure 77  
Joint Repair Using Separating Material

11.12 Compression Seals. All joint preparations for the installation of poured-type sealants apply to compression seals with the exception of backing or separating materials. The neoprene compression seal should be installed in an upright position free of twisting, distortion, or stretching. The joint face should be surface dry and the temperature of the atmosphere and pavement should be at least 30 degrees Fahrenheit (-1.1 degrees Centigrade) and rising. A coating of lubricant/adhesive should be applied to the joint faces, the compression seal, or both. The seal should be installed to a depth of 1/8 to 1/4-inch (3 to 6 mm) below the pavement surface. Transverse joints less than 24 feet (7.32 m) should not be spliced. Transverse joints in excess of 24 feet (7.32 m) should not have more than one splice.

If field splices cannot be avoided they should be made in the least critical location as far as maintaining a sealed joint is concerned. Usually, the seal is spliced simply by butting it against the next length with some extra adhesive/lubricant. At intersecting joints, it is preferable to install the transverse seal prior to the installation of the longitudinal seal. Since the transverse joint is larger and has more depth, normal procedure is to cut a slit in its top (being careful not to cut through the seal); this provides a space for the longitudinal seal to cross the transverse joint. The longitudinal seal is then roller-installed through the slit.

11.13 Silicone Sealant Installation. Joint preparations for poured-type sealants can be applied to silicone sealant. Before sealing, the joint or crack must be clean and dry. Portland cement concrete repairs should be allowed to cure for a minimum of 7 days in good drying weather. Cold wet inclement weather will require a longer drying time. Moisture is difficult to detect in the concrete but is usually noticeable by a surface darkening. Moisture detection equipment is available and may prove helpful.

11.13.1 Proprietary Materials. Proprietary materials used for repairs may be additives or substitutions for portland cement concrete. When using any of these materials, adhesion testing of the silicone joint sealant is recommended.

11.13.2 Silicone Joint Sealant. Silicone joint sealant should be pumped directly from the original container into the joint or crack by use of an air-powered pump. The nozzle should be moved steadily along the joint or crack, pushing the sealant ahead to form a uniform bead. The sealant should fill the joint or crack from the bottom to the top. Immediately after placement and before a skin forms, the sealant must be tooled, forcing it onto the backer material, against the joint faces, and recessing the bead the required 1/4-inch (6 mm) below the pavement surface. Self-leveling silicone sealants are available that do not require tooling. Temperatures should be above 40 degrees Fahrenheit (4.4 degrees Centigrade) at the time of sealant installation.

If the specifications call for nonsilicone sealants in the longitudinal joints and silicone sealants in the transverse, care must be exercised at the intersection of the two. Silicone sealants should be installed first to prevent contamination of the joint faces. It is recommended, that the silicone sealant also be installed a minimum of 1 foot (0.30 m) in both directions from the transverse joint. This should reduce the possibility of a weak point in the more important transverse joint.

Recommended joint reservoir dimensions for silicone sealants are as follows:

Joint Width Inches	Sealant Bead Thickness Inches	Minimum Joint Depth Inches	Backer Material Diameter Inches	Backer Material Placement Inches
1/4	1/4	1	3/8	1/2
3/8	1/4	1-1/4	1/2	1/2
1/2	1/4	1-1/4	5/8	1/2
5/8	5/16	1-1/2	3/4	9/16
3/4	3/8	1-3/4	1	5/8
7/8	7/16	1-7/8	1	11/16
1	1/2	2	1-1/4	3/4
>1	1/2	>2	>1-1/4	3/4

11.14 Nitrile Rubber Sealant Installation. Joint preparation for the installation of nitrile rubber sealant requires that the joint or crack be clean and free of old sealant materials. Some dampness will not interfere with the performance of the sealant. Nitrile rubber sealant should be pumped directly from the container into the joint or crack by the use of an air-powered pump, pushing the sealant ahead to form a uniform bead. The sealant should fill the joint or crack from the bottom to within 1/16-inch (1.6 mm) of the pavement surface. No tooling is required. The self-leveling characteristics allow the product to flow, and, when cured, it will produce the desired concave configuration. Recommended joint reservoir dimensions for nitrile rubber sealants are as follows:

Joint Width Inches	Sealant Bead Thickness Inches	Total Joint Depth Inches	Backer Material Diameter Inches	Backer Material Placement Inches
1/4	1/4	7/8 to 1	3/8	1/2
3/8	1/4	1 to 1-1/8	1/2	1/2
1/2	1/4	1-1/8 to 1-1/4	5/8	1/2
3/4	3/8	1-1/2 to 1-5/8	7/8	5/8
1	1/2	2-1/4 to 2-3/8	1-1/4	3/4

Note: Pavements with joints spaced more than 20 feet (6.09 m) increase joint widths 1/8-inch (3 mm).

11.15 Hot-applied Sealing Equipment. The equipment used for heating and installing solid hot-applied joint sealant materials must be equipped with a double-boiler, agitator-type kettle to prevent localized overheating. Thermometers to measure the temperature of the sealant should be calibrated and located where they can be easily read. The melter should be designed to circulate the sealant through the delivery hose and return to the inner kettle when not in use.

The equipment used for heating and installing liquid hot-applied joint sealant materials is equipped with a reservoir tank that is not maintained at the application temperature. The sealant is drawn from the tank and is pumped through tubes in a heated oil bath which brings the sealant to the application temperature. This type of equipment is not designed to recirculate the sealant material.

11.16 Cold-applied Sealing Equipment. The equipment used for proportioning, mixing, and installing cold-applied, two-component, machine-mix joint sealants are designed to deliver two semifluid components through hoses to a portable mixer at a preset ratio of 1 to 1 by volume. The reservoir for each component is equipped with mechanical agitator devices to maintain the components in a uniform condition without entrapping air. Provisions should be incorporated to permit thermostatically controlled indirect heating when required. Screens should be provided near the top of each reservoir to remove any debris or partially polymerized material.

The equipment used for cold-applied, two-component, hand-mix joint sealants normally consist of a slow-speed electric drill or air-driven mixer with a stirrer in accordance with the manufacturer's recommendations.

The sealing equipment for installing cold-applied, single component joint sealants consists of an extrusion pump, air compressor, following plate, hoses, and nozzle to transfer the sealant from the storage container into the joint opening.

11.17 Preformed Compression Seal Equipment. The automatic self-propelled preformed compression joint seal equipment must be a two-axle, four-wheel machine that includes an apparatus for compressing and inserting the seal into the joint as well as a reel capable of holding one full spool of preformed seal. Auxiliary equipment must be provided to coat both sides of the joint with the manufacturer's recommended adhesive/lubricant prior to installation of the preformed seal.

Hand-operated preformed compression seal application equipment must be a two-axle, four-wheel machine that includes an apparatus for compressing and inserting the preformed seal into the joint as well as a reel capable of holding one full spool of preformed seal. Auxiliary equipment must be provided to coat both sides of the joint with lubricant/adhesive prior to installation of the preformed seal.

11.18 Silicone Sealant Equipment. The equipment used for installation of silicone sealants may be power or manually operated. Powered equipment is recommended because of the speed and ease of application. The major pieces of powered equipment required to install silicone sealants are an extrusion pump to transfer the material from the container to the joint and an air compressor. Complete units including air-powered pump, follower plate and hose are required for both pails and drums. Manually operated equipment can be successfully used for small applications. Air-powered versions of the small, hand held caulking guns are also available.

Silicone sealants cure on exposure to atmospheric moisture, so hoses should be selected that will prevent or minimize moisture penetration. Hose runs should be kept to a minimum and of a reasonable length to reduce pressure drops. A hose inside diameter of at least 3/4-inch (19 mm) is recommended. When long runs are needed, it is suggested that a larger diameter hose be coupled with a smaller, 3/4-inch (19 mm), whip hose near the wand to minimize the overall pressure drop.

11.19        Nitrile Rubber Sealant Equipment. Air-powered extrusion pumps are used in the application of nitrile rubber sealants. The major pieces of the air-powered equipment required to install nitrile rubber are an extrusion pump to transfer the material from the container to the joint and an air compressor. Complete units including air-powered pump, follower plate, and hose are required for both pails and drums.

## Section 12: PAVEMENT EDGE DRAINAGE

12.1 Purpose of Pavement Edge Drainage. Water is a fundamental factor in most problems associated with pavement performance and is responsible directly or indirectly for many of the distresses found in pavement systems. One of the most prevalent sources of pavement distress is the loss of support to the pavement structure caused by removal of underlying fine-grained material by pumping. The infiltration of water through the pavement causes saturation of the base and subbase. When traffic loads are applied, pumping occurs unless these pavement systems are very porous and able to quickly remove the water out of the system. Repeated cycles lead to loss of support for the pavement structure with deflection and cracking (Figure 78).

12.2 Need for Pavement Edge Drainage. Pavement edge drainage may be required to control one or more sources of water such as:

- a) Where surface drainage facilities within the vicinity are inadequate.
- b) Where the water table may rise.
- c) Where surface water may enter the pavement system at joints or cracks, at the edges of the surfacing or percolate through the surfacing and shoulders.
- d) Where water may move vertically in capillaries or interconnected water films.

12.3 Drainage Systems. Drainage systems consist of two major classifications: surface or subsurface. When both types are required for efficient maintenance and protection of the pavement, it is generally a good practice for each system to function independently.

12.4 Subsurface Drain Functions. Subsurface drainage is provided to intercept, collect, and remove any ground water from the subgrade or base, to lower high water tables, to drain water pockets or perched water tables, or a combination of these.

12.4.1 Base Drainage. Base drainage is required in areas where frost action occurs in the subgrade beneath the pavement, areas where ground water rises to the base course layer, areas where the pavement may become inundated and free drainage from the base is not possible (Figure 79).

12.4.2 Subgrade Drainage. Subgrade drainage is required in areas where seasonal fluctuations of ground water may be expected to rise in the subgrade to less than one foot below the bottom of the base course.

12.4.3 Interceptor Drainage. Interceptor drainage is required in areas where seeping water in a pervious stratum will raise the ground water table to a depth of less than one foot below the bottom of the base course.





Figure 78  
Example of Pavement Distress Caused by Water Under Pavement



Figure 79  
Example of Water in Pavement Base Material

Both base and subgrade drains are normally required only at pavement edges. Interceptor drains are required wherever a need for them exists. Subsurface drainage systems include open jointed, perforated or porous collector pipes, observation risers and cleanouts, filters and blind drains, and outlet structures.

12.5 Subsurface Drain Materials

12.5.1 Pipe. Currently, several different types of perforated pipe of various lengths and diameters are being used in pavement subsurface drainage systems such as clay tile, concrete tile and pipe, perforated plastic bituminous fiber pipe, perforated corrugated metal pipe, corrugated plastic tubing and wafer drains. Most of the newer drainage pipes are flexible rather than rigid (Figure 80). The type selected should be based on local requirements such as the condition of the soil, loading and amount of cover, cost, and availability of pipe.

12.5.2 Filter Material. When possible, locally available processed sands and gravels should be used for economic reasons. Standard concrete aggregate can often be used as a filter but the filter criteria must be met. A filter material must meet two basic requirements:

a) The filter material must be fine enough to prevent infiltration of the material from which drainage is occurring. The following criteria should be met to avoid contamination of the filter by fines from the material being drained.

$$\frac{\text{D15(Note 1) percent passing size of filter material}}{\text{D85 percent passing size of material being drained}} \leq 5$$

and

$$\frac{\text{D50 percent passing size of filter material}}{\text{D50 percent passing size of material being drained}} \leq 25$$

The criteria should be used when protecting all soils except for nondispersive lean clay (CL) or fat clay (CH) soils without sand or silt particles--the 50 percent size relationship can be disregarded with these materials. In this case, it is essential that the filter be well graded and have a coefficient of uniformity of not more than 20. The coefficient of uniformity is:

$$\frac{\text{D60 percent passing size of filter material}}{\text{D10 percent passing size of filter material}}$$

For dispersive clays, filter tests will need to be conducted to evaluate the effectiveness of the filter material. Dispersive clays normally deflocculate when exposed to water of low salt content, the opposite of aggregated clays that remain flocculated in the same soil-water systems. Generally, dispersive clays are highly erosive, are subject to high shrink-swell potential and have lower permeability rates than aggregated clays (ASTM D 4221).

(Note 1) D(x) represents the size which will have (x)% of the material smaller than that size.

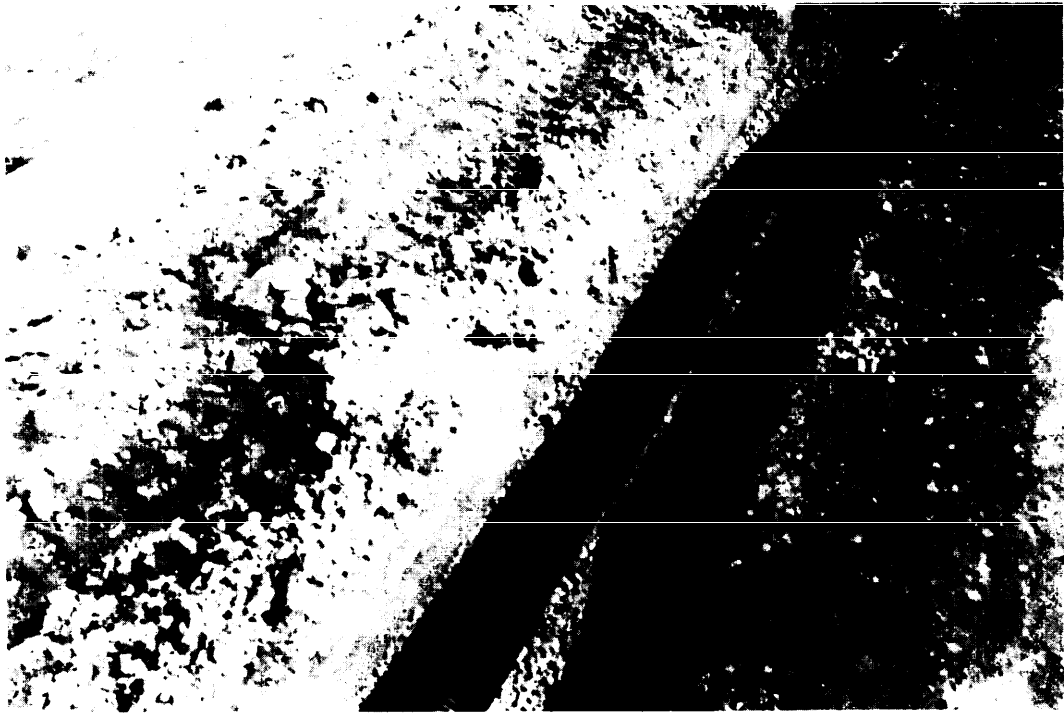

Figure 80  
Example of Flexible Drainage Pipe

b) The filter material must be much more permeable than the material being drained. The following conditions should be met:

$$\frac{\text{D60 percent passing size of filter material}}{\text{D15 percent passing size material being drained}} \geq 5$$

To prevent clogging of perforated pipe or screens the following criteria should be met:

$$\frac{\text{D85 percent passing size of filter material}}{\text{slot or hole diameter}} \geq 1.2 \text{ (slots) or } 1.0 \text{ (holes)}$$

To prevent clogging of the openings in porous pipe the following criteria should be met:

$$\frac{\text{D15 percent passing size of aggregate in porous pipe}}{\text{D85 percent passing size of filter material}} \leq 5$$

12.6 Filter Fabrics. The use of geotextile materials as filters is widely accepted in underdrains. These materials may in some instances be used to replace one or more components of a graded filter. Filter fabrics may be used to wrap the collector pipe (Figure 81), thus permitting a relatively fine backfill material to be used, or to line the trench (Figure 82), allowing a relatively coarse backfill material to be used (Figure 83). Filter fabrics are rarely used to replace the entire granular filter system. Probably, the only instance where a geotextile can completely replace a granular system is where the soil is a clean granular material.

12.6.1 Geotextile to Wrap. When a geotextile is used to wrap the collector pipe, the following criteria should be met:

a)  $\frac{\text{D85 percent passing size of granular filter material (mm)}}{\text{Equivalent opening size (EOS) of geotextile (mm)}} \geq 1.0$

b) Gradient Ratio  $\leq 3$

c) For woven geotextiles, open area of the cloth should not be less than 4 percent or greater than 36 percent. Where these criteria are met, the criteria given for perforated pipe or screens are no longer applicable.

12.6.2 Geotextile to Line. Where geotextiles are used to line the drainage trench, the following criteria should be followed:

12.6.2.1 Adjacent to Granular Materials. Geotextile adjacent to granular materials containing 50 percent or less by weight of fines (minus No. 200 materials).

a)  $\frac{\text{D85 percent size of the material (mm)}}{\text{EOS (mm)}} \geq 1$

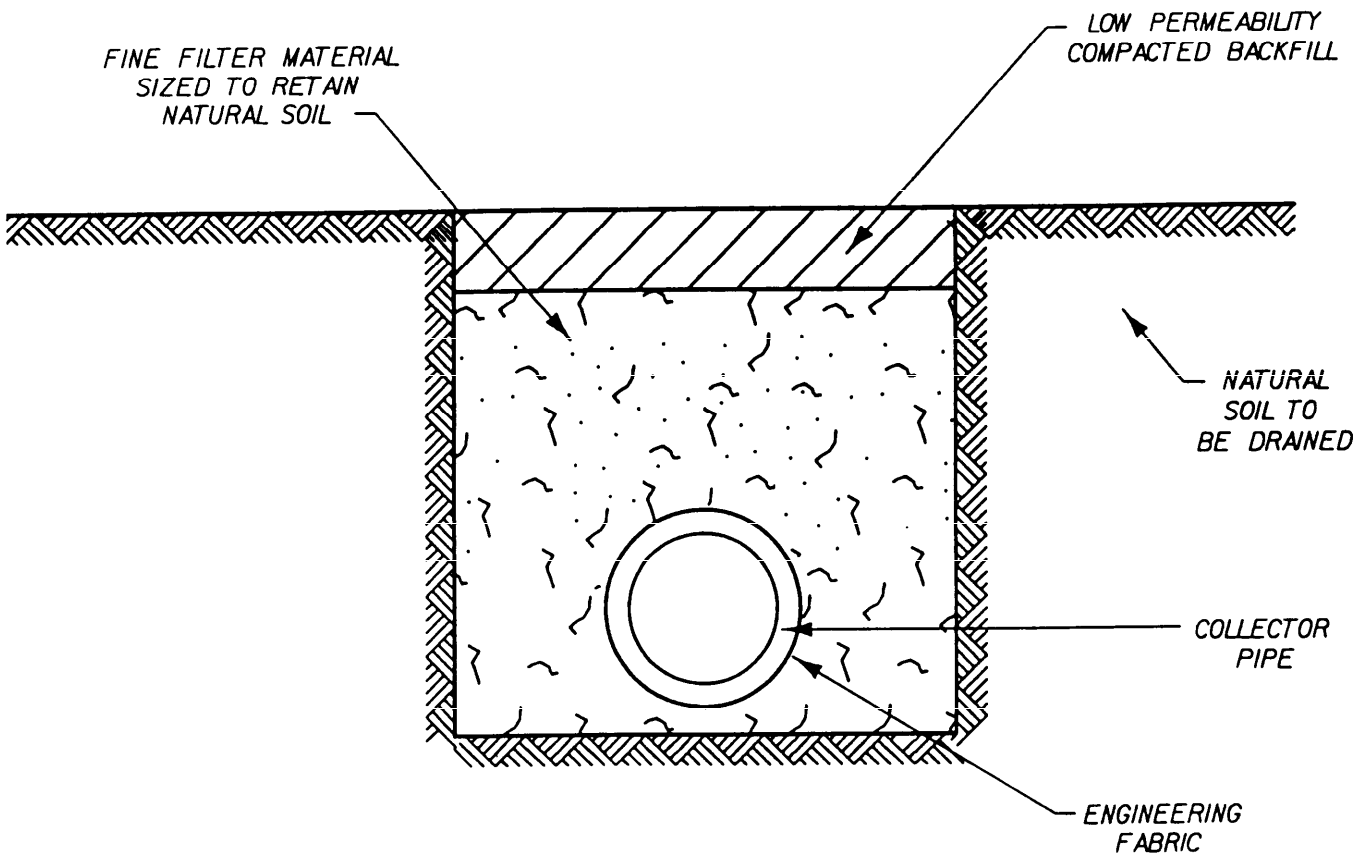

Figure 81  
Filter Fabric Used to Wrap Collector Pipe

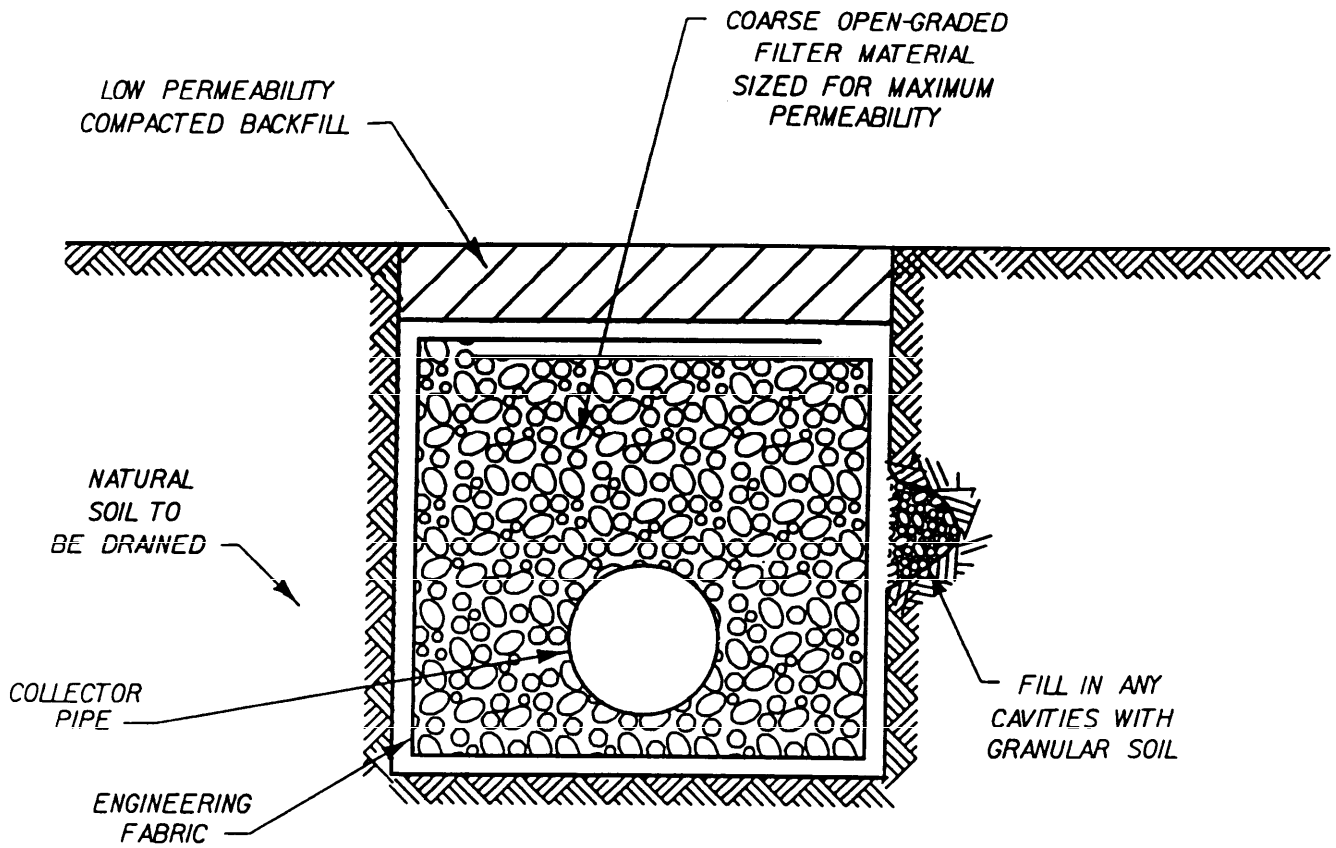

Figure 82  
Filter Fabric Used to Line Trench

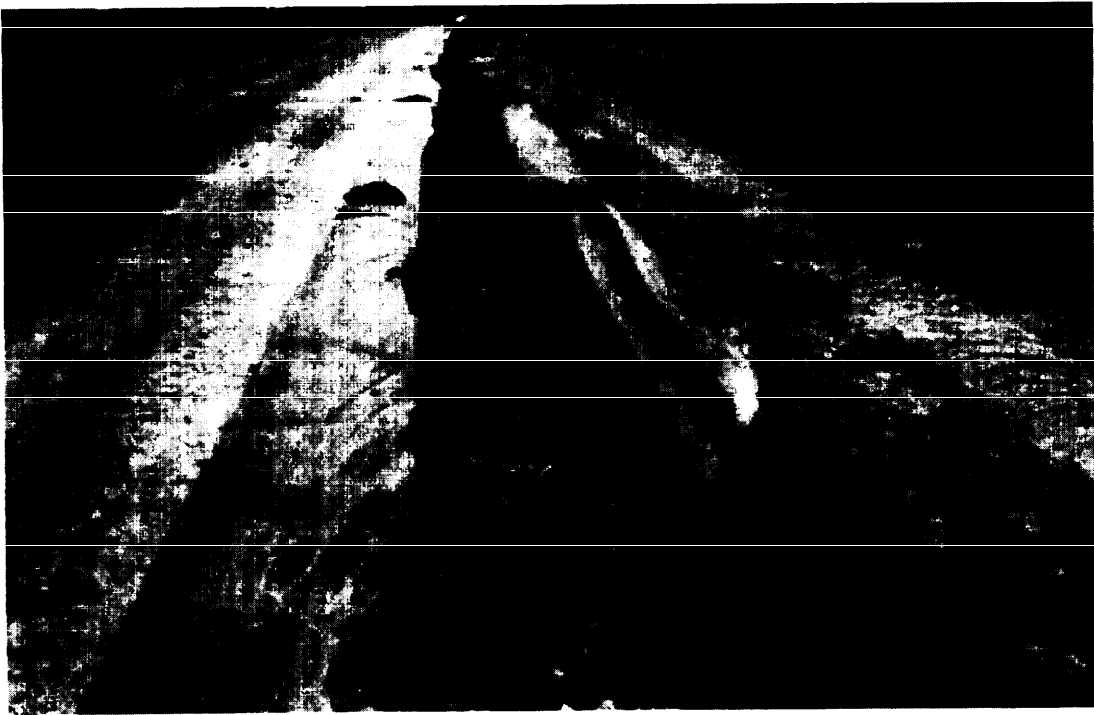

Figure 83  
Example of Fabric-Lined Trench



b) Gradient ratio  $\leq 3$

c) For woven geotextiles, open area of the cloth should not be less than 4 percent or greater than 36 percent.

12.6.2.2 Adjacent to Other Soil Types. Geotextile adjacent to all other types of soil:

a) EOS no larger than the opening in the U.S. Standard Sieve No. 70.

b) Gradient ratio  $\leq 3$

c) For woven geotextiles, open area of the cloth should not be less than 4 percent or greater than 10 percent.

12.6.2.3 Criteria. Where these criteria are met, the criteria for stability and permeability are no longer applicable and the backfill may be selected based on the criteria for perforated pipe or screens. To reduce the chance of clogging, no geotextile should be specified with an EOS smaller than the openings of a U.S. Standard Sieve No. 100. When possible, it is preferable to specify a geotextile with openings as large as allowed by the criteria. Geotextiles should not be used for soils with 85 percent or more passing the No. 200 sieve.

NOTE: Methods for determining the EOS and gradient ratio of geotextile are given in Guide Specification for Geotextiles Used As Filters CW-02215.

NOTE: Percent open area is defined as the summation of the open areas divided by the total area of the geotextile (refers to woven geotextiles only), Engineer Technical Letter 1110-3-261.

12.7 Subsurface Drain Installation. Subsurface drains are typically installed using trenchers or other suitable equipment (Figure 84). Grade control and elevations are normally obtained from the pavement surface. A minimal slope of 0.15 foot in 100 feet (0.04 m in 30.5 m) is recommended for subsurface drains.

A minimum thickness of 6 inches (152 mm) of filter material should be placed around all types of subsurface drains (with the exception of perforated drainage pipe with the holes on the top) when the filter is placed below the pipe; the holes should be placed downward. When the pipe is placed on a cradle-shaped impervious bed, the holes should be placed up.

Gap or skip graded filter material should never be allowed since it will result in the coarse particles floating in the fine material or the fine material having no stability within the voids produced by the coarse material.

12.7.1 Filter Material. Filter material must not become segregated or contaminated prior to, during, or after installation. Segregation results in zones of material too fine to meet the permeability requirements and other zones too coarse to meet the stability requirements. Contamination can clog voids in the material rendering the drainage system useless.

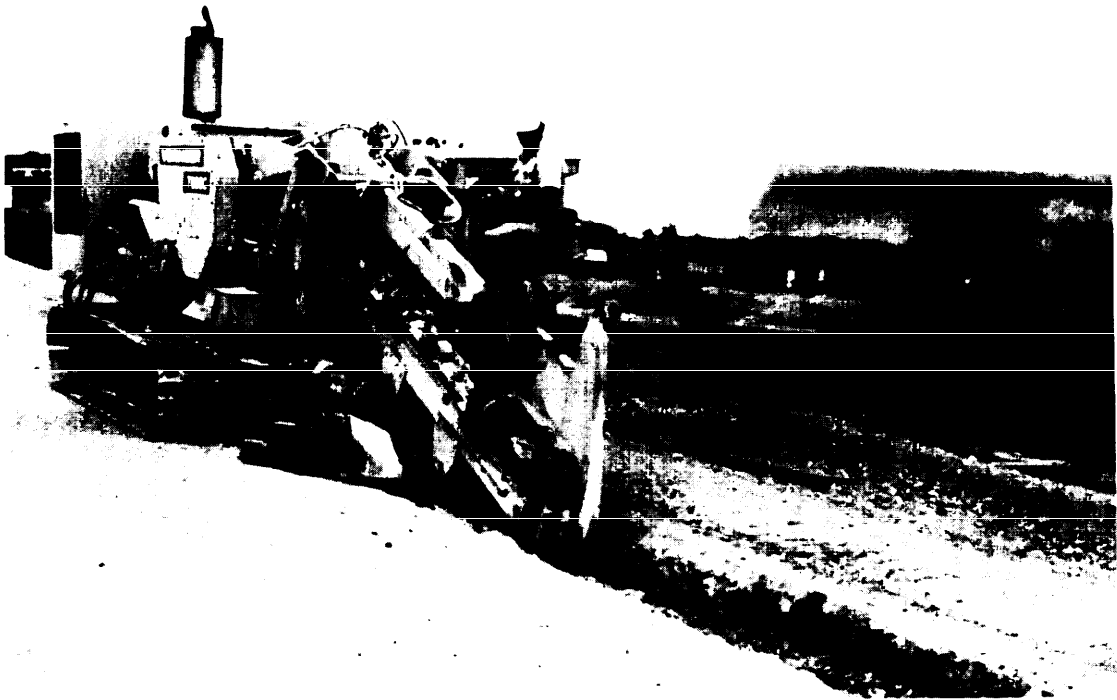

Figure 84  
Example of Trenching Machine

Outlets should feed into existing storm drainage manholes where practicable. Outlets 12 inches (305 mm) in diameter and smaller not terminating in a manhole should be protected with rodent screens (Figure 85), located to prevent surface water from entering the system, and protected and marked to prevent damage by mowers or other equipment.

The upstream end of drainage pipes not terminating in a structure should be capped or plugged.

12.8 French Drains. French drains should be used only in emergencies. These systems quickly clog if not properly designed and constructed. They are expensive to repair if clogged, and cannot be inspected. If French drains are required, a double filter system (Figure 86) should be used and is essential to prevent the drain from clogging after relatively short periods of use. The criteria for the double filter system is as follows:

D15 percent passing size of filter material	
-----	≤ 5
D85 percent passing size of protected material	

D50 percent passing size of filter material	
-----	≤ 25
D50 percent passing size of protected material	

D15 percent passing size of inner material	
-----	≤ 5
D85 percent passing size of filter material	

D50 percent passing size of inner material	
-----	≤ 25
D50 percent passing size of filter material	

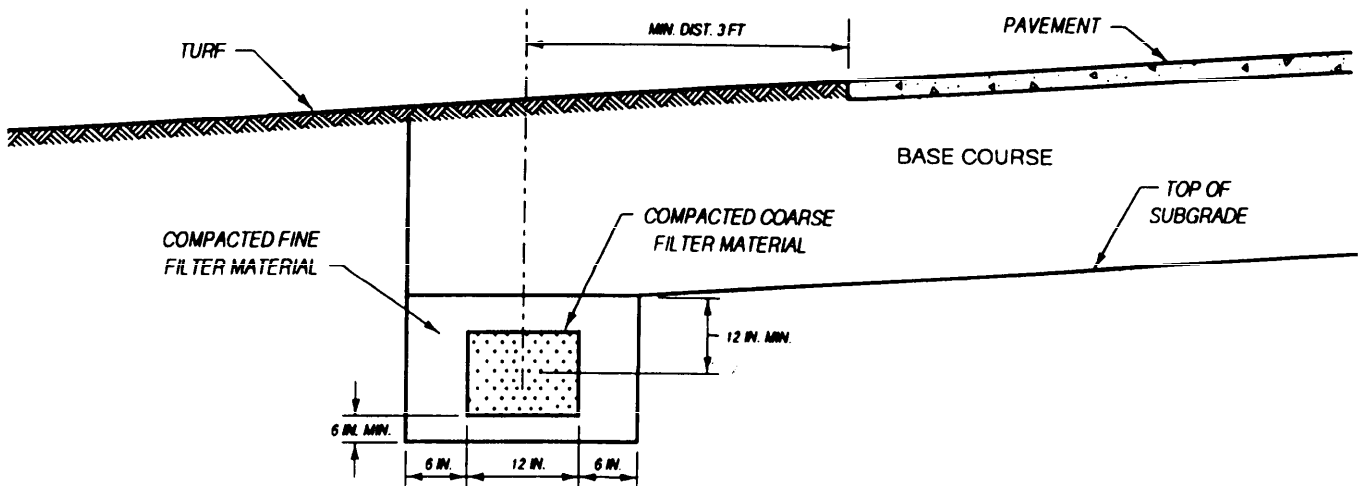

Figure 85  
French Drain

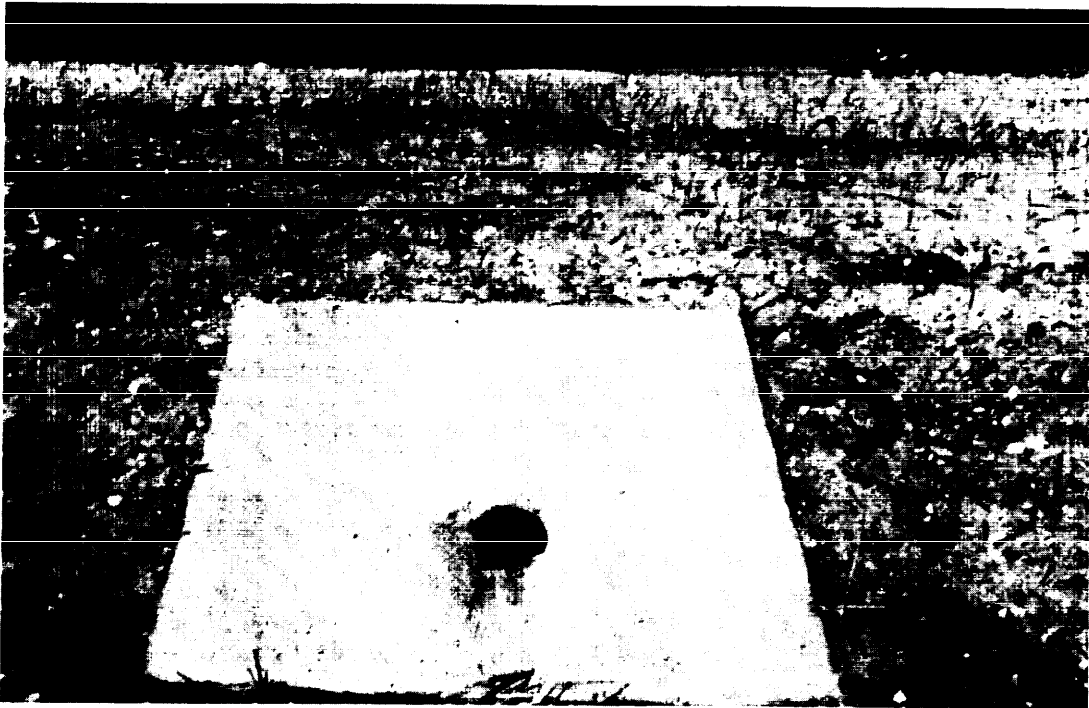

Figure 86  
Example of Protected Drain Outlet

## Section 13: POLYMER CONCRETE

13.1 Identification. There are many kinds of new specialty polymer concretes (PC) such as furan and sulfur concretes, polyester, vinyl ester, vinyl ester novolac polymer concretes, epoxy and epoxy-novolac polymer concretes, etc. Most of the work on PC has been with methyl methacrylate, epoxies, and polyester-styrene resin systems. PC is a composite material in which aggregate is held together in a dense matrix with a polymer binder. The composites do not contain a hydrated cement phase; portland cement, however, can be used as an aggregate or filler. PC composites possess a unique combination of properties dependent upon the formulation, these include:

- a) Rapid curing at ambient temperatures from 0 to 104 degrees Fahrenheit (-17.8 to 40.0 degrees Centigrade);
- b) High tensile, flexural, and compressive strengths;
- c) Good adhesion to most surfaces;
- d) Good long-term durability with respect to cycles of freezing and thawing;
- e) Low permeability to water and aggressive solutions;
- f) Good chemical resistance.

Application and performance of PC is dependent upon the specific polymeric binder as well as the type of aggregate and its gradation. Copolymerization techniques allow the production of a variety of binders with a wide range of physical properties.

13.2 Surface Preparation. Prior to starting the work, it is necessary to determine the condition of the surface to be treated and to determine what surface preparation is required. Two surface conditions must be met if repairs are to be successful:

a) The concrete surface must be strong and sound; all loose deteriorated and unsound material should be removed. Patching over delaminated areas is not recommended. The delaminations can be repaired by epoxy injection or similar techniques but providing long-term durability of such patches over repaired delaminations is likely to be impaired. In spalled areas, concrete removal may require the use of chipping hammers, scarifiers, sand blasters, high pressure water blasters, or a combination of these.

b) The concrete surface must be dry and clean (free from laitance, dirt, oil, grease, paints, and curing compounds). Moisture on the concrete surface should be removed unless it is known that the adhesion of the PC material to be used is not affected by moisture. Dust and debris may be removed by blowing with clean, dry compressed air. Mechanical abrasion may also be necessary to achieve the desired bond between the PC and the concrete surface. Any exposed reinforcing steel in the repair area should also be cleaned by mechanical abrasion prior to the application of PC patching material. Mechanical abrasion that results in damage to the reinforcing steel should not be used.

13.3 Polymer Concrete Patching Materials. PC patching materials are particularly useful for the repair of portland cement pavements where traffic conditions allow closing of the repair area for only a few hours. The fast-curing, high-strength characteristics of PC patching materials are well suited to these applications. However, PC's are not limited to that usage and can be formulated for a wide variety of application needs; thus, care must be exercised in selecting the right material for the job it is to perform.

13.3.1 Monomers. Some of the most widely used monomers for PC patching materials include methyl methacrylate (MMA), styrene (STY), unsaturated polyester resins (PE's), vinyl esters (VE's), and high molecular weight methacrylate (HMWM), a relatively new material.

13.3.2 Curing. Curing of the formulations for PC patching materials is generally an exothermic reaction. The working and curing time for PC is affected by the amount of the promoter and initiator concentrations--the ambient, substrate and component temperatures, thickness, and the time required to mix, transport, and place the materials. Many factors affect the performance of these materials so it is essential that the manufacturer's recommendations are carefully followed.

13.3.3 Epoxy Compounds. Epoxy compounds are generally formulated in two or more parts. Part A is most often the portion containing the resin and Part B is usually the hardener system. Epoxy systems are formulated for specific uses so the proper epoxy must be selected for the specific job requirements.

The ratio of resin to hardener varies considerably with the formulation of the epoxies. The range of curing temperatures also varies depending on the specific formulation. Curing has taken place at temperatures varying from 140 to 5 degrees Fahrenheit (60 to -15 degrees Centigrade) or below. Users of epoxy PC materials should refer to publications issued by ACI Committee 503 for additional guidance.

13.3.4 Aggregates. Aggregates used in PC systems should be of the highest quality available. The aggregate must usually be dry and always free of dirt, asphalt, and other organic materials. The required aggregate size distribution is dependent upon the depth of the patch to be made. The maximum size should not be greater than one-third the depth of the patch. The distribution should provide for a minimum void volume. This will minimize the voids and the amount of monomer required to ensure proper bonding of all aggregate particles and will result in a more economical PC.

13.4 Polymer Concrete Placement. Methods of placing PC patching include:

a) Dry pack placement: the graded aggregate is placed in the repair area and compacted by tamping. The compacted aggregate is saturated with the monomer mixture, using sprinkling cans or a similar system. Care must be taken to ensure that the aggregate is wetted with monomer, therefore, several monomer applications are necessary. This method usually requires a higher concentration of monomer than the premixing methods and is generally limited to monomer systems with viscosities less than 100 cP.

b) Premix placement: this method is identical to that used for the placement of portland cement concrete. The polymer binder is added directly to the mixer, then the fine aggregates are added, and the coarse aggregates are added last. Mixing is continued until all particles are completely wetted. This method can be used for binders with low or high viscosities and use a predetermined quantity of polymer binder. Depending on the product, consolidation of the PC can be obtained by tamping, vibrating screed, or small diameter vibrators. The repair area is usually primed with the polymer binder prior to placement of the PC patch material.

c) Prepackaged PC: systems can be mixed by hand or in mechanical mixers. If a rotating mixer is used, all of the monomer or resin system should be added to the mixer and blended first. The powders and fine aggregates, followed by the coarse aggregates, are then added and the entire blend is mixed for the specified time. The entire composite is then placed and consolidated utilizing the manufacturer's recommendations. Once the PC has been placed by any of the described methods, it can be finished by manual or vibrating screed, or manual or power trowels.

13.5 Safety. The chemicals used in the production of some PC's may be flammable, volatile, and/or toxic. The degree of hazard is greater for the high-vapor pressure materials. With proper precautionary measures, these materials can be handled safely. The manufacturers of the chemicals and the prepackaged systems will provide recommendations for safe storage, mixing, and handling. Additional safety recommendations are provided in Chapter 5 of the American Concrete Institute Manual of Concrete Practice (ACI 548.1).



## Section 14: STEEL FIBER REINFORCED CONCRETE

14.1 Description. Steel fiber reinforced concrete (SFRC) is a composite made of hydraulic cements, fine or fine and coarse aggregate, and a random dispersion of discontinuous, small, steel fibers. It may also contain pozzolans and other additives commonly used with conventional concrete.

The addition of steel fibers can provide significant improvements in many of the engineering properties of mortars and concrete including impact strength, toughness, flexural strength, fatigue strength, and the ability to resist cracking and spalling. The degree of improvement by addition of steel fibers depends on the type and quantity used, the concrete mix design and quality, the quality of the bond achieved between the steel fiber and the concrete matrix, and the consolidation of the concrete.

In the United States, the majority of experience with SFRC has been with mixes using normal weight aggregate and portland cement as the binder. Most existing concrete specifications can be used for the manufacture and placement of SFRC. The greater difficulty in handling SFRC requires more deliberate planning and workmanship to account for the differences in materials and techniques.

14.2 Steel Fibers. Steel fibers that have been used successfully in field applications include deformed crimped half-round fibers, irregularly shaped melt-extract fibers, crimped end smooth drawn wire fibers, straight smooth slit sheet fibers, straight deformed drawn wire fibers, and straight smooth drawn wire fibers. As a general rule, the steel fibers should have a yield strength in excess of 50,000 psi (344.7 MPa); they are available up to 300,000 psi (2,068 MPa) and be neither excessively brittle nor contain excessive rust or drawing lubricant on their surfaces. Steel fibers should have a minimum aspect ratio, i.e., fiber length divided by diameter (or equivalent diameter, in the case of nonround fibers), in the range of 30:100 for lengths of 0.5 to 2.5 inches (12.7 to 63.5 mm).

14.3 Aggregates. The fine aggregates should comply with the requirements given in ASTM C 33. The coarse aggregate should comply with ASTM C 33 and grading size No. 8 (2.36 mm) or equivalent for normal 3/8-inch (9.5 mm) maximum size aggregate mixtures and should be size No. 67 or equivalent for 3/4-inch (19 mm) maximum size mixtures. Aggregate sizes larger than 3/4-inch (19 mm) are not generally used for SFRC.

14.4 Admixtures. In both conventional and SFRC, the various types of mixtures perform several useful functions. All admixtures, however, should be tested in advance to determine how they will modify the properties of the job concrete.

14.4.1 Additive Caution. Calcium chloride should not be added to SFRC in excess of amounts permitted to be added to conventional concrete as shown in ACI 318-86, Table 4.5.4.

14.4.2 Water-reducing. Water-reducing admixtures reduce the need for water and are recommended for SFRC. Both regular and high-range (superplasticizer) water reducers are suitable.

14.4.3 Air-Entraining. Air-entraining admixtures improve workability and can also reduce bleeding, thus allowing earlier finishing, and are recommended for SFRC exposed to freezing and thawing conditions.

14.5 Mixture Proportions. SFRC mixtures employ a variety of mixture proportions depending upon the end use. They may be specially proportioned for a project or selected to be the same as a previously used mixture. In either case, they must be adjusted for yield, workability, and other factors.

ACI 544.1, Chapter 3, discusses SFRC mixtures and includes a table showing the range of proportions for normal weight fiber reinforced concrete.

14.6 Mixing SFRC. To obtain good dispersion of the fibers and to prevent fiber clumping, the fibers should be added to an already fluid mix and should not be added to the mix before the water. The batching procedure is critical to obtaining a good dispersion of the fibers with the concrete. Several methods have previously been used with success, and information to assist in choosing a suitable procedure may be obtained from the fiber manufacturers. Methods that have been successful for the addition of uncollated individual fibers to a fluid mix are:

a) Addition of fibers last to a transit mix truck. The concrete to be used is prepared first (without the fibers). The slump of the concrete following mixing should be 2 to 3 inches (50 to 76 mm) greater than the final slump desired for the SFRC. With the mixer operating at normal charging speed, the fibers are added. A convenient way to do this is to dump the fibers through a coarse mesh screen (3- to 4-inch (76 to 102 mm) openings) into a hopper and then onto a moving conveyor belt going to the mixer. It is important that not any clumps be introduced into the mixture or the clumps will remain undispersed. Once all the fibers have been introduced into the mixer, it should be slowed to the rated mixing speed for approximately 30 to 40 revolutions.

b) Addition of fibers to aggregate on a conveyor belt. In a plant set up to charge a central mixer or transit mixers, the fibers are added by a shaker or through a hopper to the fine aggregate on a conveyor belt during aggregate addition and mixed in the normal manner. This method does not require as much care as to where the fibers land in the mixer, but they should not be allowed to pile up and form clumps on their way to the mixer. This method has been for the majority of fibrous concrete projects where large quantities of concrete were mixed using bulk individual fibers.

Fibers collated into bundles of about 30 fibers per bundle using a water-reactive glue may be dumped directly into a fluid mix as the last step with little or no likelihood of fiber clumping.

14.7 Transporting and Placing SFRC. The transporting and placing of SFRC can be accomplished with most conventional equipment that is properly designed, maintained, and clean. SFRC with the proper water-cement ratio appears very stiff and unworkable until subjected to vibration. Then it usually places very easily. The material tends to resist movement or compaction if an attempt is made to handle it without vibration. Batch plant operators and transit truck drivers must be instructed not to add water to the mixture based on its appearance and their experience with conventional concrete. Water-cement ratios for SFRC must be carefully controlled. At the upper end of the water-cement

spectrum, tests have shown that further addition of water causes an increase in slump without a change in workability under vibration. This water addition reduces the quality of the mixture without improving the placeability.

Discharging SFRC from transit mix trucks is usually accomplished with little trouble. A well proportioned mixture usually barely slides down the chute by itself and may need to be pushed by the truck operator. Driving the truck up on a ramp to discharge unusually stiff mixtures may be helpful.

Concrete buckets should have steeper slopes, be clean and smooth inside, and have a minimum gate opening dimension of 12 inches (305 mm). The fibers may bridge a smaller gate opening, and the mix will not drop under its own weight. A vibrator attached to the underside of the bucket will prevent bridging and ease placement of stiff mixes.

14.7.1 Pumping. Pumping has been used to transport SFRC on a number of projects. A good fiber mixture generally has proportions of sand and admixtures which make it well suited for pumping. Because of its composition, a SFRC mixture will move through the line without slugs and will pump more easily and more trouble free than conventional concrete. Pumps should be capable of handling the volume and pressures needed; a screen should be provided over the hopper to prevent any fiber clumps from entering the line. A 2- by 3-inch (50 X 76 mm) mesh usually is adequate. Large diameter lines at least 6 inches (152 mm) are recommended, and flexible hoses should be avoided. An overly wet mix should not be used. Under these conditions pump pressures can squeeze or force the fluid paste and fine aggregate out ahead of the rest of the mixture, leaving behind a mat of fibers and coarse aggregate. Additional information on pumping is available in ACI 304.2R.

14.7.2 Forms and Equipment. Fixed forms and slipform equipment have been used to place SFRC. A fiber mix will normally require somewhat more vibration than normal for good consolidation. Properly controlled internal vibration is acceptable, but external vibration of the forms and surface is preferable to prevent fiber segregation. SFRC is more easily handled with forks and rakes, the fibrous nature of the mix making the use of shovels and hoes difficult. Standard screeding and floating methods can be used to finish fibrous concrete. A textured surface can be obtained by brooming with a stiff brush, but this should be delayed as long as possible to prevent pulling fibers to the surface. A burlap drag should not be used because it will lift fibers and tear up the surface.

14.7.3 Temperature. Curing and protection of SFRC from freezing or excessively hot or cold temperatures should be done as for conventional concrete. Since SFRC is often placed in thin sections, as overlays for example, and has a high cement content, it is particularly vulnerable to plastic shrinkage cracking. This will occur on warm days where it is exposed to the direct sun or a breeze. Such placements must be shaded from the sun and sheltered from the wind to prevent this type of damage. Additional information on hot and cold weather placement requirements is available in ACI 305R for hot weather and ACI 306R for cold weather.

## Section 15. HEAT RESISTANT CONCRETE

15.1 Condition. Concrete pavement exposed to high temperatures from aircraft jet blast or from auxiliary power units can suffer damage. If the concrete is wet when the heat is suddenly applied, the production of steam within the concrete can cause spalling. If the concrete is dry or the heat is applied slowly, relatively little permanent damage is done up to concrete temperatures of 400 to 500 degrees Fahrenheit (204.4 to 260.0 degrees Centigrade). At concrete temperatures above this, water of hydration is lost, and the concrete strength decreases. At about 1,000 degrees Fahrenheit (537.2 degrees Centigrade), compressive strength loss can be 55 to 80 percent of the original strength. The concrete's degree of saturation at the time of heating influences the severity of strength loss, and repetitions of heating and cooling cycles further degrades the concrete. Around 1,060 degrees Fahrenheit (570.5 degrees Centigrade), silica in the concrete aggregates undergoes a crystal change and expands, and in the range of 1,300 to 1,800 degrees Fahrenheit (703.7 to 981.2 degrees Centigrade), carbonate aggregates undergo a chemical change. As the concrete surface is heated, a large temperature gradient develops between the surface concrete and the cooler slab depths which can lead to separation and spalling. The behavior of concrete exposed to high temperatures is complex. Typical concrete pavement damage from high temperatures from jet blast includes spalling, aggregate popouts, scaling, cracking, and loss of joint sealant.

15.2 Exposure. The time that the concrete is exposed to the jet engine or auxiliary power unit exhaust is critical since there is considerable thermal lag in concrete. For instance, test of concrete slabs exposed to an ASTM E 119 standard fire for 2 hours found that after 2 hours the concrete temperature at about 3/4-inch (19 mm) below the surface was 1,200 degrees Fahrenheit (648.2 degrees Centigrade), at 1-1/2 to 2 inches (38 to 50 mm) it was 800 degrees Fahrenheit (426.2 degrees Centigrade), and at about 3-1/2 inches (89 mm) it was 400 degrees Fahrenheit (204.4 degrees Centigrade). The atmosphere temperature for a standard ASTM E 119 fire rises to 1,000 degrees Fahrenheit (537.2 degrees Centigrade) at 5 minutes, 1,700 degrees Fahrenheit (925.7 degrees Centigrade) at 1 hour, and 2,300 degrees Fahrenheit (1,258.7 degrees Centigrade) at 8 hours. Normally, concrete would not be exposed to jet or auxiliary power unit exhaust for extended periods of time, so any thermal damage will be concentrated in the upper surface concrete.

Concrete exposed to high temperatures must be of high quality. It should have a low water/cement ratio, and it must be properly cured. Leaner concrete mixes seem to perform better than richer mixes. Construction must also be of high quality. Proper consolidation and proper finishing are critical. Finishing techniques that cause a paste on the surface will result in scaling.

15.3 Materials. Selection of the proper materials in the concrete also has a dramatic effect on heat resistance. Aggregate selection probably is the most important single materials-related factor, however, no standard specification has been developed for heat resistant aggregate. An aggregate with a low coefficient of thermal expansion is generally considered to be desirable, and one rating system roughly groups aggregates as follows in descending order of desirability for heat resistant concrete:

Group	Rating	Description	Typical Aggregates
I	Most Desirable	Calcareous	Limestone, Dolomite
II	Intermediate	Nonquartzose Silicates	Basalt, Dolorite Gabbro, Andesite, Diabase (traprock)
III	Aggregates that Spall and Crack at High Temperature	High Silica Content Quartzose	Granites, High Silica Content Igneous Rocks, Quarts Bearing Schists & Gneisses
IV	Least Desirable	Silica Not Combined to Form Silicates	Quartzite, Quartz, Chert, Flint

Lightweight aggregates such as expanded shale tend to perform better than conventional natural concrete aggregates when exposed to high temperatures. Good results have also been reported for air-cooled slag aggregates. Hydrated portland cement that has lower calcium hydroxide content appears to be preferable to those with higher contents for high temperature applications. Therefore, some benefit may be obtained by using portland cement blended with slag cement. For temperatures of 1,500 degrees Fahrenheit (814.7 degrees Centigrade) or more, high alumina cement will provide superior performance over conventional portland cement.

15.4 Repair. Repair of concrete that has suffered thermal damage is a difficult problem. Proper patching procedures for spalls and popouts must be meticulously followed, and the repair material should have similar thermal characteristics to the original concrete. Even so, the repairs may only be temporary. Overlays using heat resistant concrete are potential repairs for scaled areas or for areas with concrete of poor heat resistance. If scaling is due to a paste on the concrete surface but the concrete is otherwise acceptable, grinding the surface may be adequate.

15.5 Joint Sealant. Joint sealant used in concrete pavements exposed to high temperatures should conform to Federal Specification, SS-S-200E. This specification does require testing of the material at 500 degrees Fahrenheit (260.0 degrees Centigrade) for 2 minutes so some resistance to high temperatures can be achieved. However, when high temperatures are combined with jet blast, the sealant may still be damaged or blown out of the joint. Under these circumstances, increased periodic resealing must be accepted as routine maintenance.

15.6 Conventional Concrete. Conventional concrete and joint sealants should provide reasonable service up to concrete temperatures of about 500 degrees Fahrenheit. Above this temperature, deterioration of concrete and increased loss of sealant can be expected. High quality concrete with selected aggregates can reduce the amount of damage. Above 1,000 degrees Fahrenheit (537.2 degrees Centigrade), severe deterioration can be expected, and refractory materials such as high alumina may be needed.

Where possible, blast shields or diverters or increased slope of pavements should be used to allow the maximum dissipation of the exhaust plumes temperature before it impinges on the concrete. Use of continuously reinforced concrete for areas such as power check pads removes the need for joints and joint sealants. In one installation, refractory brick was used to surface a test facility where high temperature engines were tested and evaluated. Conventional concrete has a limited capability to withstand high temperatures for an extended period of time, and facilities must be designed to accommodate its limitations.

## BIBLIOGRAPHY

- American Concrete Pavement Association. 1989. "Guidelines for Full-Depth Repair," Technical Bulletin TB-002.0 CPR, Arlington Heights, Illinois.
- American Concrete Pavement Association. 1989. "Guide lines for Partial-Depth Repair," Technical Bulletin TB-003.0 CPR, Arlington Heights, Illinois.
- Baladi, G. Y. and Snyder, M. B. May 1990. "Highway Pavements Training Course," "Vol III," Publication No. FHWA-HI-90-028, ERES Inc., Champaign, Illinois.
- ChemGrout. 1985. "Pavement Undersealing Principles and Techniques," LaGrange Park, Illinois.
- Darter, M. I., Barenberg, E. J., and Yrjonson, W. A. February 1985. "Joint Repair Methods for Portland Cement Concrete Pavements Research Report, Design and Construction Guidelines and Guide Specifications," Final Report, Transportation Research Board, Washington, D.C.
- Darter, M. I., Barenberg, E. J., and Yrjonson, W. A. December 1985. "Joint Repair Methods for Portland Cement Concrete Pavements," National Cooperative Highway Research Program Report 281, Transportation Research Board, Washington, D.C.
- Dow Corning Corporation. 1987. "Dow Corning 888 Silicone Joint Sealant," Pocket Guide, Midland, Michigan.
- Dow Corning Corporation. 1988. "Dow Corning 888-SL Self-Leveling Silicone Joint Sealant," New Product Information, Midland, Michigan.
- Dow Corning Corporation. 1987. "Guide Specifications 888 Silicone Joint Sealant," Midland, Michigan.
- Kosmatka, S. H. 1990. "Cementitious Grouts and Grouting," EB111.01T, Portland Cement Association, Skokie, Illinois.
- Portland Cement Association. 1976. "Maintenance of Joints and Cracks in Concrete Pavement," IS188.01P, Skokie, Illinois.
- Portland Cement Association. 1982. "Cement-Grout Subsealing and Slabjacking of Concrete Pavements," IS212.01P, Skokie, Illinois.
- Portland Cement Association. 1987. "Patching Concrete Pavement," IS189.01P, Skokie, Illinois.
- Portland Cement Association. 1988. "Utility Cuts and Full-Depth Repairs in Concrete Streets," IS235.01P, Skokie, Illinois.
- Ruscoe Highway Products. Undated. "Ruscoe 983 Highway Joint Sealant," Product Bulletin HP-1, Akron, Ohio.

## REFERENCES

NOTE: THE FOLLOWING REFERENCED DOCUMENTS FORM A PART OF THIS HANDBOOK TO THE EXTENT SPECIFIED HEREIN. USERS OF THIS HANDBOOK SHOULD REFER TO THE LATEST REVISIONS OF CITED DOCUMENTS UNLESS OTHERWISE DIRECTED.

FEDERAL/MILITARY SPECIFICATIONS, STANDARDS, BULLETINS, HANDBOOKS, AND NAVFAC GUIDE SPECIFICATIONS:

Guide Specifications

NFGS-02563                      Pavement, Portland Cement Concrete, [MINOR][AND]  
[REPAIRS].

NFGS-02564                      Patching of Rigid Pavement Partial Depth.

(Unless otherwise indicated, copies are available from the U.S. Naval Publications and Forms Center, 5801 Tabor Avenue, Philadelphia, PA 19120.)

NAVY MANUALS, P-PUBLICATIONS, AND MAINTENANCE OPERATING MANUALS:

DM-21                              Airfield Pavements.

NAVFAC MO-102                    Maintenance and Repair of Surfaced Areas.

NAVFAC MO-102.2                Jointed Concrete Roads and Parking Lots.

NAVFAC MO-102.4                Jointed Concrete Airfields.

NAVFAC MO-102.5                Pavement Maintenance Management.

OTHER GOVERNMENT DOCUMENTS AND PUBLICATIONS:

TM 5 623                            Pavement Maintenance Management.

TM 5 624/AFR 85-8                Maintenance and Repair of Surfaced Areas.

TM 5 820-1/AFM 88-5,          Subsurface Drainage Facilities for Airfields and  
Chapter 2                            Heliports.

TM 5 820-2/AFM 88-5,          Subsurface Drainage Facilities for Airfield  
Chapter 2                            Pavements.

TM 5 822-6/AFM 88-7,          Rigid Pavements for Roads, Streets,  
Chapter 1                            Walks and Open Storage Areas.

TM 5 822-9/AFM 88-6,          Repair of Rigid Pavements Using  
Chapter 10                            Epoxy Resin Grouts, Mortars, and Concrete.

TM 5 825-3/AFM 88-6,          Rigid Pavements For Airfields.  
Chapter 3

TM 5 826-6/AFR 93-5          Airfield Pavement Evaluation Program.



TM 5 827-3/AFM 88-24, Evaluation of Airfield Pavements Other  
Chapter 3 Than Army: Rigid Airfield Pavement Evaluation.

(Unless otherwise indicated, copies of Army Technical Manuals are available from the U.S. Army AG Publications Center, 1655 Woodson Road, St. Louis, MO 63114 and Air Force Manuals are available from the U.S. Air Force Publications Distribution Center, 2800 Eastern Boulevard, Baltimore, MD 21220.)

#### NON-GOVERNMENT PUBLICATIONS

##### AMERICAN CONCRETE INSTITUTE (ACI)

ACI 304.2R	Placing Concrete by Pumping Methods.
ACI 305R	Hot Weather Concreting.
ACI 306R	Cold Weather Concreting.
ACI 318	Building Code Requirements for Reinforced Concrete.
ACI 544.1R	State-of-the-Art Report on Fiber Reinforced Concrete.
ACI 548.1R	Guide for the Use of Polymers in Concrete.

(Unless otherwise indicated, copies are available from the American Concrete Institute, P.O. Box 19150, Redford Station, Detroit, MI 48219.)

##### AMERICAN SOCIETY FOR TESTING AND MATERIALS (ASTM)

ASTM C-33	Standard Specification for Concrete Aggregates.
ASTM C-39	Standard Test Method for Compressive Strength of Cylindrical Concrete Specimens.
ASTM C-109	Standard Test Method for Compressive Strength of Hydraulic Cement Mortars (Using 2-in. Cube Specimens).
ASTM C-939	Standard Test Method for Flow of Grout For Preplaced-Aggregate Concrete.
ASTM D-4221	Standard Test Method for Dispersive Characteristics of Clay Soil By Double Hydrometer.
ASTM E-119	Standard Test Method for Fire Tests of Building Construction and Materials.

(Unless otherwise indicated, copies are available from the American Society for Testing and Materials, 1916 Race Street, Philadelphia, PA 19103.)

## GLOSSARY

Admixture. A material other than water, aggregates, hydraulic cement and fiber reinforcement used as an ingredient of concrete or mortar, and added immediately before or during its mixing.

Aggregate Interlock. Aggregate particles from one side of a joint or crack in concrete protruding into recesses in the other side of the joint or crack so as to transfer load in shear and maintain alignment.

Air Compressor. A machine used for compressing air from an initial intake pressure to a higher exhaust pressure through reduction in volume. It consists of a driving unit, a compressor unit, and their accessories.

Air Content. The volume of air voids in cement paste, mortar, or concrete, exclusive of pore space in aggregate particles, usually expressed as a percentage of total volume of the paste, mortar, or concrete.

Air Entrainment. The occlusion of air in the form of minute bubbles (generally smaller than 1 mm) during the mixing of concrete or mortar.

Air Meter. A device for measuring the air content of concrete and mortar.

Air-Entraining. The capability of a material or process to develop a system of minute bubbles of air in cement paste, mortar, or concrete during mixing.

Air-Entraining Agent. An addition for hydraulic cement or an admixture for concrete or mortar which causes air to be incorporated in the concrete or mortar during mixing, usually to increase its workability and frost resistance.

Air-Entraining Hydraulic Cement. Hydraulic cement containing an air-entraining addition in such amount to cause the product to entrain air in mortar within specified limits.

Airfield. A group of facilities designed for the takeoff, landing, servicing, fueling, and parking of fixed-wing and rotary-wing aircraft.

Alkali. Salts of alkali metals, principally sodium and potassium occurring in constituents of concrete and mortar, usually expressed in chemical analyses as the oxides  $\text{Na}_2\text{O}$  and  $\text{K}_2\text{O}$ .

Alkali Reactivity (of aggregate). Susceptibility of aggregate to alkali-aggregate reaction.

Alkali-Aggregate Reaction. Chemical reaction in either mortar or concrete between alkalies (sodium and potassium) from portland cement or other sources and certain constituents of some aggregates; under certain conditions, deleterious expansion of the concrete or mortar may result.

Alkali-Carbonate Rock Reaction. The reaction between the alkalis (sodium and potassium) in portland cement and certain carbonate rocks, particularly calcitic dolomite and dolomitic limestones, present in some aggregates; the products of the reaction may cause abnormal expansion and cracking of concrete in service.

Alkali-Silica Reaction. The reaction between the alkalies (sodium and potassium) in portland cement and certain silicious rocks or minerals, such as abalone chert, strained quartz, and acidic volcanic glass, present in some aggregates; the products of the reaction may cause abnormal expansion and cracking of concrete in service.

Apparent Opening Size (AOS). A property which indicates the approximate largest particle that would effectively pass through the geotextile. The AOS is the "retained on" sieve size of narrowly sized, rounded sand, or glass beads of which 5 percent or less by weight passes through the fabric when particles are shaken on the fabric in a prescribed manner. The AOS is usually expressed as the US Standard Sieve Number but may also be expressed in millimeters.

Axle Load. The portion of the gross weight of a vehicle transmitted to a structure or a roadway through wheels supporting a given axle.

Backer Material. Also may be called backup material, backer rod, backing material, or bond breaking tape. A material applied prior to applying joint sealant to limit the amount and depth of sealant applied to prevent backside adhesion (bondbreaker) and to assist the sealant in developing a shape factor.

Backhoe. A machine normally used for heavy excavation or material handling. It is usually self-propelled or truck-mounted and comes in various sizes depending on the size of the job to be performed.

Bag (of Cement; also Sack). A quantity of portland cement; 94 lb (42.6 kg) in the United States, and 50 kg in most other countries; for other types of cement a quantity indicated on the bag.

Bar. A member used to reinforce concrete.

Bar Chair. An individual supporting device used to support or hold reinforcing bars in proper position to prevent displacement before or during concreting.

Bar Mat. An assembly of steel reinforcement composed of two or more layers of bars placed at angles to each other and secured together by welding or ties.

Bar Spacing. The distance between parallel reinforcing bars, measured center to center of the bars perpendicular to their longitudinal axis.

Barrel of Cement. A quantity of cement: 376 lb (170.6 kg) (4 bags) in the United States (obsolete); also wood or metal container formerly used for shipping cement.

Base Course. A layer of specified select material of planned thickness constructed on the subgrade or subbase of a pavement to serve one or more functions such as distributing loads, providing drainage, or minimizing frost action. It may be composed of crushed stone, crushed slag, crushed or uncrushed gravel and sand, or a combination of these materials. It may also be bound with cementing agent such as asphalt, lime, or portland cement concrete.

Base Pavement. The existing pavement over which the overlay is to be placed.

Bearing Capacity. The maximum unit pressure which a soil or other material will withstand without failure or without excessive settlement in an amount detrimental to the integrity or function of the structure.

Blistering. The irregular raising of a thin layer at the surface of placed mortar or concrete during or soon after completion of the finishing operation.

Bond. Adhesion and grip of concrete or mortar to reinforcement or to other surfaces against which it is placed, including friction due to shrinkage and longitudinal shear in the concrete engaged by the bar deformations; the adhesion of cement paste to aggregate.

Bond Area. The area of interface between two elements across which adhesion develops or may develop, as between concrete and reinforcing steel.

Bond Breaker. A material used to prevent adhesion of newly placed concrete and the substrata.

Broom Finish. The surface texture obtained by stroking a broom over freshly placed concrete.

Brushed Surface. A sandy texture obtained by brushing the surface of freshly placed or slightly hardened concrete with a stiff brush for architectural effect or, in pavements, to increase skid resistance.

Bulk Cement. Cement which is transported and delivered in bulk (usually in special constructed vehicles) instead of bags.

Burlap. A course fabric of jute, hemp, or less commonly, flax, for use as a water-retaining covering in curing concrete surfaces.

Butt Joint. A plain square joint between two members.

Calcium Chloride. A crystalline solid.  $\text{CaCl}_2$ ; in various technical grades, used as a drying agent, as an accelerator of concrete, a deicing chemical, and for other purposes.

California Bearing Ratio. The ratio of force per unit area required to penetrate a soil mass with a 3-square inch (193.5 square mm) circular piston at the rate of 0.05 inches (1.27 mm) per minute to the force required for corresponding penetration of a standard crushed-rock base material; the ratio is usually determined at 0.1 inch (2.5 mm) penetration.

Capillary Moisture. Water may be drawn into the voids of certain soils just as it may be drawn into a capillary tube. This movement may take place in any direction in soil, but most commonly is associated with an upward movement of water from the water table. The moisture which is present at any point in a soil because of such movement is called capillary moisture.

Cast-In-Place. Mortar or concrete which is deposited in the place where it is required to harden as part of the structure, as opposed to precast concrete.

Cement Content. Quantity of cement contained in a unit volume of concrete or mortar, preferably expressed as weight.

Cement Paste. Constituent of concrete consisting of cement and water.

Cement High-Early-Strength. Cement characterized by producing earlier strength in mortar or concrete than regular cement, referred to in the United States as "Type III."

Cement, Normal. General purpose portland cement, referred to in the United States as "Type I."

Cement, Portland. A hydraulic cement produced by pulverizing clinker consisting essentially of hydraulic calcium silicates, and usually containing one or more of the forms of calcium sulfate as an interground addition.

Clogging. The plugging of a fabric by deposition of particles within the fabric pores (other than blinding).

Cohesive Failure. The tearing apart of the sealant as the joint expands and the adhesive (bond) capabilities of a sealant exceed its cohesive capabilities.

Compacted Subgrade. Upper part of the subgrade which is compacted to a density greater than the soil below.

Compaction (PCC). The process whereby the volume of freshly placed mortar or concrete is reduced to the minimum practical space usually by vibration, centrifugation, tamping, or some combination of these; to mold it within forms or molds and around embedded parts and reinforcement, and to eliminate voids other than entrained air.

Compatibility (Materials). The ability of two or more substances to mix or blend without separation or reaction.

Compressive Strength. The measured maximum resistance of a concrete or mortar specimen to axial loading; expressed as force per unit cross sectional area; or the specified resistance used in design calculations. Normally, compressive strength is measured at specific ages (7, 28, and/or 90 days).

Concrete. A homogeneous mixture portland cement, aggregates, and water and which may contain admixtures.

Concrete, Fibrous. Concrete containing dispersed, randomly oriented fibers which may be either steel or plastic.

Concrete Finishing Machine. A machine mounted on flanged wheels which rides on the forms or on specially set tracks, used to finish surfaces such as those of pavements; or a portable power-driven machine for floating and finishing of floors and other slabs.

Concrete Mixer. A machine equipped with a large rotating drum in which measured quantities of cement, sand, gravel, and water are mixed and subsequently dumped into a haul vehicle for transporting to a construction site.

Concrete Paver. A machine which spreads, finishes, floats and cures concrete in one continuous operation (can be either slipform or form riding).

Concrete Spreader. A machine, usually carried on side forms or on rails parallel thereto, designed to spread concrete from heaps already dumped in front of it, or to receive and spread concrete in a uniform layer.

Concrete Vibrating Machine. A machine which compacts a layer of freshly mixed concrete by vibration.

Condition Survey. A visual inspection of airfield pavements to determine their existing condition in terms of apparent structural integrity and surface defects. Information from a condition survey is used in planning and maintaining the pavements to fulfill mission requirements.

Consistency. The relative mobility or ability of freshly mixed concrete or mortar to flow; the usual measurements are slump for concrete, flow for mortar or grout, and penetration resistance for neat cement paste.

Consolidation (PCC). The process of inducing a closer arrangement of the solid particles in freshly mixed concrete or mortar during placement by the reduction of voids; usually by vibration, centrifugation, tamping, or some combination of these actions.

Contraction Joint (Construction). Formed, sawed, or tooled groove in a concrete structure to create a weakened plane and regulate the location of cracking resulting from the dimensional change of different parts of the structure.

Contraction Joint (Design). Contraction joints are provided to control contraction cracking from temperature changes and from the initial shrinkage of the concrete. Some relief from expansion forces also is afforded by this type of joint since the initial shrinkage of the concrete opens the joint slightly and thereby provides for subsequent expansion.

Construction Joint (Construction). The surface where two successive placements of concrete meet, across which it is desirable to develop and maintain bond between the two concrete placements, and through which any reinforcement which may be present is not interrupted.

Construction Joint (Design). Construction joints are provided to separate the areas of concrete placed at different times, and may be either longitudinal or transverse.

Continuously Reinforced Portland Cement Concrete Pavement. A nonjointed pavement that has been strengthened with reinforcing steel. This pavement will be referred to as continuously reinforced concrete (CRC) pavement.

Core Test. Compression test on a concrete sample cut from hardened concrete by means of a core drill.

Curing. Maintenance of humidity and temperature of freshly placed concrete during some definite period following placing, casting, or finishing to assure satisfactory hydration of the cementitious materials and proper hardening of the concrete.

Curing Blanket. A built-up covering of sacks, matting, Hessian, straw, waterproof paper, or other suitable material placed over freshly finished concrete.

Curing Compound. A liquid that can be applied as a coating to the surface of newly placed concrete to retard the loss of water or, in the case of pigmented compounds, also to reflect heat so as to provide an opportunity for the concrete to develop its properties in a favorable temperature and moisture environment.

Curling (Warping). The distortion of an originally essentially linear or planar member into a curved shape such as the warping of a slab due to creep or to differences in temperature or moisture content in the zones adjacent to its opposite faces.

Darby. A hand-manipulated straightedge, usually 3 to 8 feet (0.91 to 2.44 m) long, used in the early stage leveling operations of concrete or plaster, preceding supplemental floating and finishing.

Deformed Bar. A reinforcing bar with a manufactured pattern of surface ridges which provide a locking anchorage with surrounding concrete.

Deformed Reinforcement. Metal bars, wire, or fabric with a manufactured pattern of surface ridges which provide a locking anchorage with surrounding concrete.

Deterioration. The undesired change in properties of a material caused by aging, weathering, or exposure to other agents and conditions.

Disintegration. Deterioration into small fragments or particles due to any cause.

Dowel. A steel pin, commonly a plain round steel bar, which extends into adjoining portions of concrete construction, as at a joint in a pavement slab, so as to connect the two portions and transfer shear loads.

Dowel Deflection. Deflection caused by the transverse load imposed on a dowel.

Drainage. The interception and removal of water from, on, or under an area or roadway; the process of removing surplus ground or surface water artificially; a general term for gravity flow of liquids in conduits.

Durability (PCC). The ability of concrete to resist weathering action, chemical attack, abrasion, and other conditions of service.

Dusting. The development of a powdered material at the surface of hardened concrete.

Early Strength. Strength of concrete or mortar usually developed at various times during the first 72 hours after placement.

Edge Form. Formwork used to limit the horizontal spread of fresh concrete on flat surfaces such as pavements or floors.

Edger. A finishing tool used on the edges of fresh concrete to provide a rounded corner.

Entrained Air. Microscopic air bubbles intentionally incorporated in mortar or concrete during mixing, usually by use of a surface-active agent.

Entrapped Air. Air voids in concrete which are not purposely entrained and which are significantly larger and less useful than those of entrained air, 1 mm or larger in size.

Epoxy Concrete. A mixture of epoxy resin, catalyst, fine aggregate, and coarse aggregate.

Epoxy Resins. A class of organic chemical bonding systems used in the preparation of special coatings or adhesives for concrete or as binders in epoxy resin mortars and concretes.

Expansion Joint (Design). Expansion joints are provided for the relief of forces resulting from thermal expansion of the pavement, and to permit unrestrained differential horizontal movement of adjoining pavements and/or structures.

Expansion Joint (Construction). (1) A separation provided between adjoining parts of a structure to allow movement where expansion is likely to exceed contraction; (2) A separation between pavement slabs on grade, filled with a compressible filler material; (3) An isolation joint to allow independent movement between adjoining parts.

Exterior Pavement (usually an Army airfield designation). The first 1,000 feet (304.8 m) of runway ends, taxiways and parking aprons on which the pavement receives the full design weight of operating aircraft. It is designated by the letter "E" in labeling features. For example, in a feature labeled RIE, the "E" is an exterior description.

Fabric. A planar textile structure produced by interlacing yarns, fibers, or filaments.

Fabric, Bonded. A textile structure wherein the fibers are bonded together with an adhesive or by welding with heat pressure.

Fabric, Knitted. Textile made up of loops of fibers connected by straight segments.

Fabric, Nonwoven. A textile structure produced by bonding or interlocking of fibers, or both, accomplished by mechanical, chemical, or solvent means, and combinations thereof, excluding woven and knitted fabrics.

Fabric, Woven. A textile structure comprising two or more sets of filaments or yarns interlaced in such a way that the elements pass each other essentially at right angles and one set of elements is parallel to the fabric axis.

Failure. Exceeding the maximum strength of material or exceeding the stress strain requirement of a specific design. Exceeding the failure criteria of a pavement.



Fibrous Reinforced Portland Cement Concrete Pavement. A jointed concrete pavement that has been strengthened by the introduction of randomly mixed, short, small-diameter steel fibers. This pavement is referred to as jointed fibrous concrete (JFC) pavement.

Filter Cloth. Deprecated term for geotextile.

Filtration. The process of allowing water to easily escape from soil while retaining soil in place.

Finish. The texture of a surface after compacting and finishing operations have been performed.

Finishing Machine. A self-propelled machine, and can be either a slip form or a form riding unit. It has a mechanically vibrating screed and oscillating float to place the desired surface texture on concrete.

Flexural Strength. A property of a material or structural member that indicates its ability to resist failure in bending.

Float. A tool (usually made of wood, aluminum or magnesium) used in concrete finishing operations to impart a relatively even but still open texture to a fresh concrete surface.

Float Finish. A rather rough concrete surface texture obtained by finishing with a float.

Fly Ash. The finely divided particles of ash entrained in flue gasses arising from the combustion of fuel. The particles of ash may contain incompletely burned fuel. The term has been applied predominantly to the gas-born ash from boilers with spreader stoker, underfeed stoker, and pulverized fuel (coal) firing. Fly ash is generally high in silica and alumina which causes it to be valuable as pozzolan, i.e., causes a long term reaction with soil increasing the overall strength of the soil-fly-ash (soil-lime-fly-ash or soil-cement-fly-ash) mixture.

Form. A temporary structure or mold for the support of concrete while it is setting and gaining sufficient strength to be self supporting.

Form Work. Total system of support for freshly placed concrete including the mold or sheeting which contacts the concrete as well as all supporting members, hardware, and necessary bracing.

Free Drainage Base. A term used for pavement base courses where the fine content is limited to no more than 2 percent. The permeability of this material is generally between 10 and 1,000 feet/day (3.05 and 304.8 m/day).

Geotextile. A textile, almost invariably synthetic, used in geotechnical engineering. Also referred to as "filter cloth," "filter fabric," "geotechnical fabric," "engineering fabric," and "geofabric."

Green Concrete. Portland cement concrete that has just been placed and is still workable.

Groove Joint. A joint created by forming a groove in the surface of a pavement, floor slab, or wall to control cracking.

Groover. A tool used to form grooves or weakened plane joints in a concrete slab before hardening to control crack location or provide pattern.

Grout. A mixture of cementitious material and water, with or without aggregate, proportioned to produce a pourable consistency without segregation of the constituents; also a mixture of other composition but of similar consistency.

Grouting. The process of filling with grout.

Hairline Cracking. Small cracks of random pattern in an exposed concrete surface.

Heat-Resistant Concrete. Any concrete which will not disintegrate when exposed to constant or cyclic heating at any temperature below which a ceramic bond is formed.

High-Early-Strength Concrete. Concrete which, through the use of high-early-strength cement or admixtures, is capable of attaining specified strength at an earlier age than normal concrete.

Honeycomb. Voids left in concrete due to failure of the mortar to effectively fill the spaces among coarse aggregate particles.

Hydration. Formation of a compound by the combining of water with some other substance; in concrete, the chemical reaction between hydraulic cement and water.

Initial Set. A degree of stiffening of a mixture of cement and water less than final set, generally stated as an empirical value indicating the time in hours and minutes required for cement paste to stiffen sufficiently to resist to an established degree, the penetration of a weighed test needle.

Initial Setting Time. The time required for a freshly mixed cement paste, mortar, or concrete to achieve initial set.

Inlay Pavement. Rigid pavement used to replace the interior width of existing runways and as a method of rehabilitation or upgrading of existing pavement.

Joint Filler. Compressible material used to fill a joint to prevent the infiltration of debris and to provide support for sealants.

Joint Residue. An accumulation of foreign matter, laitance, and protrusions that must be removed from joint side walls prior to sealing; an accumulation of old sealant material on the joint walls that must be removed prior to resealing of joints.

Joint Sealant. Compressible material used to exclude water and solid foreign materials from joints.

Joint Sealers. Materials placed in pavement joints to prevent entrance of water or debris into the joint cavity; most joint sealers are pourable with either one component or two components, and applied hot or cold. Also in use are

compression seals, preformed strips of elastomeric materials, that are compressed and inserted into the joint and maintain a seal by continuously exerting pressure against the joint walls rather than relying entirely on bond to the concrete as do the pourable sealers.

Joint, Contraction. See Contraction Joint.

Joint, Construction. See Construction Joint.

Joint, Dummy. A plane of weakness troweled into concrete pavement to eliminate intermediate cracking.

Joint, Expansion. See Expansion Joint.

Joint Insert. Generally, a metal or plastic insert that is depressed in plastic or green concrete to create desired plane or weakness.

Joint Longitudinal. A joint either construction or dummy, parallel to a paving lane.

Joint Skewed. A nonsymmetrical joint or joint oblique to the longitudinal axis of the pavement.

Joint, Transverse. A joint perpendicular to traffic, generally spaced 15 to 60 feet (4.57 to 18.29 m) on center, to control cracking as concrete cures.

Jointer. A metal tool about 6 inches (152 mm) long and from 2 to 4-1/2 inches (50 to 114 mm) wide and having shallow, medium, or deep bits (cutting edges) ranging from 3/16 inch to 3/4 inch (5 to 19 mm) or deeper used to cut a joint partly through fresh concrete.

Keyway. A recess or groove in one lift or placement of concrete which is filled with concrete of the next lift, giving shear strength to the joint.

Lap (PCC). The length by which one bar or sheet of fabric reinforcement overlaps another.

Lap Splice. A connection of reinforcing steel made by lapping the ends of bars, rods, or wire.

Lapping. The overlapping of reinforcing bars, welded wire fabric, or expanded metal so that there may be continuity of stress in the reinforcing when the concrete member is subjected to flexural or torsional loading.

Lean Concrete. Concrete of low cement content.

Load Transfer Device. Any mechanical device embedded in the concrete on both sides of a joint, the purpose of which is to prevent vertical movement of the joint under load.

Load Transfer Assembly. Most commonly, the unit (basket or plate) designed to support or link dowel bars during concreting operations so as to hold them in place, in the desired alignment.

Longitudinal Joint. A joint parallel to the long axis of a concrete member or pavement.

Longitudinal Reinforcement. Reinforcement essentially parallel to the long axis of a concrete member or pavement.

Man-Made Fiber. A class name for various genera of fibers (including filaments) produced from fiber forming substances which may be: (1) polymers synthesized from chemical compounds, e.g., acrylic, nylon, polyester, polyethylene, polyurethane, and polyvinyl fibers; (2) modified or transformed natural polymers, e.g., alginic and cellulose-based fibers such as acetates and rayons; or (3) mineral, e.g., glass. The term man-made usually refers to all chemically produced fibers to distinguish them from the truly natural fibers such as cotton, wool, silk, flax, etc.

Membrane Curing. A process that involves either liquid sealing compound (e.g., bituminous and paraffinic emulsions, coal tar cutbacks, pigmented and nonpigmented resin suspensions, or suspensions of wax and drying oil) or nonliquid protective coating (e.g., sheet plastics or "waterproof" paper), both of which types function as films to restrict evaporation of mixing water from the fresh concrete surface.

Mill Scale. The oxide layer formed during the hot rolling of metals, such as that formed on hot-rolled reinforcing bars.

Mixer. A machine used for blending the constituents of concrete, grout, mortar, cement paste, or other mixture.

Mixing Water. The water in freshly mixed sand-cement grout, mortar, concrete, exclusive of any previously absorbed by the aggregate.

Mixture. The blended ingredients of mortar or concrete, or the proportions for their blending and mixing.

Moving Forms. Large prefabricated units of formwork incorporating supports, and designed to be moved horizontally on rollers or similar devices, with a minimum amount of dismantling between successive uses.

Natural Pozzolans. Materials that in the natural state, exhibit pozzolanic properties, such as some volcanic ash and lava deposits.

Nitrile Rubber. A family of copolymers of butadiene and acrylonitrile that can be vulcanized into tough oil-resistant compounds. Blends with PVC are used for ozone, oil, and fuel resistance.

No-Slump Concrete (Zero-Slump Concrete). Concrete with a slump of 1/4 inch (6 mm) or less.

Non-Air-Entrained Concrete. Concrete in which neither an air-entraining admixture nor air-entraining cement has been used.

Nondestructive Testing (NDT). A rapid test procedure for evaluation of the load-carrying capacity of pavements which does not require excavation of test pits and field in-place tests on the various pavement layers. Normally the test involves using some adaptation of a falling weight in which deflections

are measured at varying distances after a weight has been dropped on a pavement.

Nonwoven Fabric. A textile structure produced by bonding or interlocking of fibers, or both, accomplished by mechanical, chemical, or solvent means.

Open Graded Base. A general term used for pavement drainage layer. Also, a drainage layer meeting the gradation given in TM 5-820-2 and usually having a permeability exceeding 5,000 feet/day (1,524 m/day).

Overlay Pavement. The additional layer of pavement placed over the base pavement.

Overlay (PCC). A layer of concrete or mortar, seldom thinner than 1-inch (25 mm), placed on and usually bonded onto the worn or cracked surface of a concrete slab to either restore or improve the function of the previous surface.

Oversanded. Containing more sand than would be necessary to produce adequate workability and a satisfactory condition for finishing.

Overvibration. Excessive use of vibrators during placement of freshly mixed concrete, causing segregation and excessive bleeding.

Pavement. Pavement in military construction is defined as a surfaced area designed to carry loads from vehicles, aircraft, pedestrian traffic, open and covered storage areas, or to be used as an outside athletic court or as a playground. Pavement includes the entire pavement structure above the subgrade. Pavement does not include enclosed floor slabs, except that, all slabs on grade to support aircraft loadings, whether interior or exterior, are to be considered pavements.

Pavement Condition Index (PCI). A numerical rating on a scale of 0 to 100 indicating the type and severity of inspected pavement surface distress.

Pavement Facility. Part of an airfield or heliport used by aircraft, i.e., runway, taxiway, apron, etc.

Paving Train. An assemblage of equipment designed to place and finish a concrete pavement.

Percent Open Area (POA). The net area of a fabric that is not occupied by fabric filaments, normally determinable only for woven and nonwoven fabrics having distinct visible and measurable openings that continue through the fabric.

Placement. The process of placing and consolidating concrete; a quantity of concrete placed and finished during a continuous operation; also inappropriately referred to as Pouring.

Plain Bar. A reinforcing bar without surface deformations, or one having deformations that do not conform to the applicable requirements.

Plain Concrete. Concrete without reinforcement; reinforced concrete that does not conform to the definition of reinforced concrete; also used loosely to designate concrete containing no admixture and prepared without special treatment.

Plain Rigid Pavement. A single thickness of rigid pavement resting directly on a granular base course or subgrade material, and containing no reinforcement.

Plasticizer. A material that increases the plasticity and workability of a fresh cement paste, mortar, or concrete.

Plowing Out. A process utilizing a farm-type tractor with special hook-shape plow to remove deteriorated sealing material prior to resealing.

Plugging. The partial or total closure of fabric pores as a result of particle or chemical deposition or biological growth within or on a fabric. Plugging can consist of clogging, blinding, or both.

Polymer (PCC). The product of polymerization; more commonly a rubber or resin consisting of large molecules formed by polymerization.

Polymer Concrete. Concrete in which an organic polymer serves as the binder; also known as resin concrete; sometimes erroneously employed to designate hydraulic cement mortars or concretes in which part or all of the mixing water is replaced by an aqueous dispersion of thermoplastic copolymer (latex).

Pore Size. The size of an opening between fabric fibers. Because of the variability of opening sizes for different fabrics, the equivalent opening size (EOS) is used to determine the approximate size of the largest pores of fabric.

Portland Cement Concrete Pavement. A single thickness of nonreinforced jointed concrete constructed on a base course and/or subgrade. This pavement is referred to as jointed concrete (JC) pavement.

Pozzolan. A siliceous, or siliceous and aluminous material, which in itself possesses little or no cementitious value but will, in finely divided form and in the presence of moisture, chemically react with calcium hydroxide at ordinary temperatures to form compounds possessing cementitious properties.

Prefabricated Composite Structures. Any combinations of geotextiles (i.e., Knitted, Woven, Nonwoven, and Composite), and geotextile related products (i.e., Webs, Mats, Nets, Grids, and Formed Plastic Sheets). Typical examples are mats, nets, or formed plastic sheets combined with one or two geotextiles acting as filters to form prefabricated drainage structures.

Prestressed Portland Cement Concrete Pavement. A concrete pavement that has been strengthened by the use of a significant horizontally applied compressive stress prior to use. This pavement will be referred to as prestressed concrete (PC) pavement.

Primary-Use Pavement (usually a Navy airfield designation). Those airfield pavements which require a higher strength due to the channelized traffic characteristics in combination with higher operation weights. Included as

primary-use pavements are the 1,000 feet (304.8 m) ends of runways, primary taxiways, aprons, and holding areas.

Proportioning. Selections of proportions of ingredients for mortar or concrete to make the most economical use of available materials to produce mortar or concrete of the required properties.

Rapid Drainage Base. A term used for drainage layer in pavement systems which have a permeability generally between 1,000 and 5,000 ft/day (304.8 and 1,524 m/day) and a gradation meeting the requirements of TM 5-820-2.

Reactive Aggregates. Aggregate containing substances capable of reacting chemically with the products of solution or hydration of the portland cement in concrete or mortar under ordinary conditions of exposure, resulting in some cases in harmful expansion, cracking, or staining.

Ready-Mixed Concrete. Concrete mixed at a remote plant for delivery to a purchaser in a plastic and unhardened state.

Rebar. Abbreviation for "reinforcing bar."

Reinforcement (PCC). Bars, wires, strands, and other slender members which are embedded in concrete in such a manner that the reinforcement and the concrete act together in resisting forces.

Rehabilitated Pavement. Rehabilitated pavement consists of flexible overlaid pavements, rigid overlaid pavements, composite pavements, recycled flexible pavements, and recycled rigid pavements. Composite pavement is a pavement constructed of both flexible pavement and rigid pavement, a rigid pavement constructed over a bound base, or a pavement constructed out of multiple independent rigid pavement layers.

Reinforced Portland Cement Concrete Pavement. A concrete pavement that has been strengthened with deformed bars or welded wire fabric.

Rigid Overlay. Overlay pavement constructed of portland cement concrete.

Rigid Overlay on Flexible Pavement. A rigid overlay that has been placed on an existing flexible pavement.

Rigid Overlay on Rigid Base Pavement. A rigid overlay pavement that has been placed on an existing rigid base pavement. A partially bonded rigid overlay is one that is cast directly on the existing base pavement without any bond-breaking medium between the pavements. A no-bond rigid overlay is one in which a bond-breaking medium less than 4 inches (102 mm) thick (bituminous tack coat, sand asphalt, bituminous concrete, etc.) was used between the two pavements.

Rigid Pavement. Rigid pavements generally consist of a mixture of hydraulic cementitious material, aggregates, and water laid as a single course (slab) over a subgrade or base course. Rigid pavement transfers the load to the subgrade by bending or slab action through tensile forces as opposed to shear forces. Portland cement concrete pavement, roller compacted concrete pavement, and reinforced concrete pavement are considered rigid pavements. Fully bonded rigid pavement overlays placed directly over a rigid pavement are considered a

rigid pavement since the original pavement and the full bonded overlay course act together as a single course (slab) and do not act independently.

Retardation. Reduction in the rate of hardening or setting, i.e., an increase in the time required to reach initial and final set or to develop early strength of fresh concrete, mortar, or grout.

Retarder. An admixture which delays the setting of cement paste, and hence of mixtures such as mortar or concrete containing cement.

Retempering. Addition of water and remixing of concrete or mortar which has lost enough workability to become unplaceable or unusable. This action is undesirable because it can reduce the strength of the concrete or mortar.

Revibration. One or more applications of vibration to concrete after completion of placing and initial compaction but preceding initial setting of the concrete.

Rheology. The science dealing with flow of materials, including studies of deformation of hardened concrete, the handling and placing of freshly mixed concrete, and the behavior of slurries, pastes, and the like.

Rich Concrete. Concrete of high cement content.

Rock Pocket. A porous, mortar deficient portion of hardened concrete consisting primarily of coarse aggregate and open voids, caused by leakage of mortar from form, separation (segregation) during placement, or insufficient consolidation.

Rotary Float (also called Power Float). A motor-driven revolving disc that smooths, flattens, and compacts the surface of concrete floors or floor toppings.

Rout. To deepen and widen a crack to prepare it for patching or sealing.

Sandblast. To thoroughly clean by means of abrasives blown by compressed air onto the surface to be cleaned.

Saw Cut. A cut in hardened concrete utilizing diamond or silicone-carbide blades or discs.

Sawed Joint. A joint cut in hardened concrete, generally not to the full depth of the member, by means of special equipment.

Screed. (1) To strike off concrete lying above the desired plane or shape. (2) A tool for striking off the concrete surface, sometimes referred to as strikeoff.

Screed Guide. Firmly established grade strips or side forms for unformed concrete which will guide the strikeoff in producing the desired plane or shape.

Screeding. The operation of forming a surface by the use of screed guides and a strikeoff.



Secondary-Use Pavement (usually a Navy airfield designation). Those airfield pavements normally not subjected to the full weight of the aircraft and traffic distributed over a wider width of pavement. Included as secondary-use pavements are runway interiors (excluding the 1,000 feet (304.8 m) at each end) and intermediate taxiway turnoffs.

Seepage. The movement of free water through a soil mass is frequently termed seepage.

Segregation. The differential concentration of the components of mixed concrete, aggregate, or the like, resulting in nonuniform proportions in the mass.

Shear Strength. The maximum shearing stress which a material or structural member is capable of developing based on the original area of cross section.

Shear Stress. The stress component tangential to the plane on which the forces act.

Sieve (Screen). A plate, sheet or woven wire cloth, or other device, with regularly spaced square apertures of uniform size, mounted in a suitable frame or holder, for use in separating material according to size. The term sieve or screen can be used interchangeably throughout.

Sieve Number. A number used to designate the size of a sieve, usually the approximate number of openings per linear inch; applied to sieves with openings smaller than 1/4 inch (6.3 mm).

Sieve-Mesh Number. Number of wires (filaments) per inch (running in each direction). It is recommended that the size of the openings be given in micrometers and that the mesh number be given in parentheses.

Skid Resistance. A measure of the frictional characteristics of a surface.

Slab. A flat, horizontal or nearly so, molded layer of plain or reinforced concrete, usually of uniform but sometimes variable thickness.

Slipform. A form which is pulled or raised as concrete is placed; may move in a generally horizontal direction to lay concrete evenly for highway paving or on slopes and inverts of canals; or vertically to form walls, bins, or silos.

Slump. A measure of consistency of freshly mixed concrete, mortar, or stucco equal to the subsidence measured to the nearest 1/4 inch (6.3 mm) of the molded specimen immediately after removal of the slump cone.

Slump Cone. A mold in the form of the lateral surface of the frustum of a cone with a base diameter of 8 inches (203 mm), top diameter of 4 inches (102 mm), and a height of 12 inches (305 mm), used to fabricate a specimen of freshly mixed concrete for the slump test; a cone 6 inches (152 mm) high is used for tests of freshly mixed mortar and stucco.

Slump Loss. The amount by which the slump of freshly mixed concrete changes during a period of time after an initial slump test was made on a sample of samples thereof.

Slump Test. The procedure for measuring slump.

Splice. Connection of one reinforcing bar to another by lapping, welding, mechanical couplers, or other means; connection of welded wire fabric by lapping.

Spreader. A self-propelled machine that can either be a slip form or a form riding unit. It consists of reciprocating paddles, a revolving screw, or other mechanism for distributing concrete to required uniform thickness across the slab. It receives the fresh concrete, spreads and strikes it off, and can also vibrate the concrete in a single operation.

Spud Vibrator. A vibrator used for consolidating concrete, having a vibrating casing or head that is used by insertion into freshly placed concrete.

Straightedge. A rigid straight piece of wood or metal used to strike off or screed a concrete surface to the proper grade, or to check the planeness of a finished grade.

Strikeoff. To remove concrete in excess of that which is required to fill the form evenly or bring the surface to grade; performed with a straight-edged piece of wood or metal by means of a forward sawing movement or by a power-operated tool appropriate for this purpose; also the name applied to the tool.

Subgrade. The soil prepared to support a structure or pavement system. It is the foundation of the pavement structure. The subgrade soil sometimes is called "basement soil," "foundation soil," or "natural subgrade."

Subgrade, Improved. Subgrade, improved as a working platform by the incorporation of granular materials or stabilizers such as asphalt, lime, or portland cement, prepared to support a structure of a pavement system.

Subsoil. Soil below the subgrade or fill.

Surfaced Area. Surfaced areas are designed to support and sustain traffic loading, or static loading, or recreational functions, or environmental conditions. These areas may consist of subgrade, subbase, base course, flexible pavement, rigid pavement, composite pavement, improved turfed areas, or stone protection. Surfaced areas do not include unimproved turfed areas, graded areas, heavy duty slabs on grade, or road tracks established by the passage of vehicles. Surfaced areas may be categorized as "improved turfed areas," "pavements," "slope protection," or "stabilized areas."

Surface Preparation. The preparation of a foundation surface so that the materials to be adhered will promote optimum performance of an adhesive, coating, or sealer.

Surface Texture. Degree of roughness or irregularity of the exterior surfaces of aggregate particles or hardened concrete.

Surface Vibrator. A vibrator used for consolidating concrete by application to the top surface of a mass of freshly placed concrete; four principal types exist: vibrating screeds, pan vibrators, plate or grid vibratory tampers, and vibratory roller screeds.

Surface Voids. Cavities visible on the surface of a solid.

Tackiness. The stickiness of the film while in the stage of drying, as a paint or varnish that usually retains a sticky or tacky feeling for some time until it is practically dry.

Tamper. (1) An implement used to consolidate concrete or mortar in molds or forms. (2) A hand-operated device for compacting floor topping or other unformed concrete by impact from the dropped device in preparation for strikeoff and finishing; contact surface often consists of a screen or a grid of bars to force coarse aggregates below the surface to prevent interference with floating or trowelling.

Tamping. The operation of compacting fresh concrete by repeated blows or penetrations with a tamper or other tamping device.

Tempering. The addition of water and mixing of concrete or mortar as necessary to bring it to the desired consistency during the prescribed mixing period; for truck-mixed concrete this will include any addition of water as may be necessary to bring the load to the desired slump on arrival at the work site but not after a period of waiting to discharge the concrete.

Texture. The pattern or configuration apparent in an exposed surface, as in concrete or mortar, including roughness, streaking, striation, or departure from flatness.

Texturing. The process of producing a special texture on unhardened concrete or hardened concrete.

Tie Bar. Bar extending across a construction joint; bar at right angles to and tied to reinforcement to keep it in place.

Transit-Mixed Concrete. Concrete, the mixing of which is wholly or principally accomplished in a truck mixer.

Transverse Reinforcement. Reinforcement at right angles to the principal axis of a member.

Trowel. A flat, broad-blade steel hand tool used in the final stages of finishing operations to impart a relatively smooth surface to concrete floors and other unformed surfaces; also a flat triangular blade tool used for applying mortar to masonry.

Troweling. Smoothing and compacting the unformed surface of fresh concrete by strokes of a trowel.

Trowel Finish. The smooth or textured finish of an unformed concrete surface obtained by troweling.

Troweling Machine. A motor-driven device which operates orbiting steel trowels on radial arms from a vertical shaft.

Truck Mixer. A concrete mixer suitable for mounting on a truck chassis and capable of mixing concrete in transit.

Uniformity Coefficient. The uniformity coefficient (Cu) is the ratio between the grain diameter corresponding to 60 percent passing on the curve (that is D60) and 10 percent passing (D10). Hence,  $Cu = D60/D10$ .

Vibrated Concrete. Concrete compacted by vibration during and after placing.

Vibration. Energetic agitation of freshly mixed concrete during placement by mechanical devices, either pneumatic or electric, that create vibratory impulses of moderately high frequency that assist in consolidating the concrete in the form or mold.

Vibration, Internal. Employs one or more vibration elements that can be inserted into the concrete at selected locations, and is more generally applicable to in-place construction.

Vibration, Surface. Employs a portable horizontal form on which a vibrating element is mounted.

Water-Cement Ratio. The ratio of the amount of water, exclusive only of that absorbed by the aggregates, to the amount of cement in a concrete or mortar mixture; preferably stated as a decimal by weight.

Welded-Wire Fabric. A series of longitudinal and transverse wires arranged substantially at right angles to each other and welded together at all points of intersection.

Welded-Wire Fabric Reinforcement. Welded-wire fabric in either sheets or rolls, used to reinforce concrete.

Workability. That property of freshly mixed concrete or mortar which determines the ease and homogeneity with which it can be mixed, placed, compacted, and finished.

Zero-Slump Concrete. Concrete of stiff or extremely dry consistency showing no measurable slump after removal of the slump cone.

Custodian:  
Navy - YD1

Preparing Activity  
Navy - YD1

(Project FACR-1106)

# STANDARDIZATION DOCUMENT IMPROVEMENT PROPOSAL

## INSTRUCTIONS

1. The preparing activity must complete blocks 1, 2, 3, and 8. In block 1, both the document number and revision letter should be given.
2. The submitter of this form must complete blocks 4, 5, 6, and 7.
3. The preparing activity must provide a reply within 30 days from receipt of the form.

NOTE: This form may not be used to request copies of documents, nor to request waivers, or clarification of requirements on current contracts. Comments submitted on this form do not constitute or imply authorization to waive any portion of the referenced document(s) or to amend contractual requirements.

### I RECOMMEND A CHANGE:

1. DOCUMENT NUMBER  
MIL-HDBK-1102/7

2. DOCUMENT DATE (YYMMDD)  
941110

### 3. DOCUMENT TITLE

HANDBOOK FOR CONCRETE PAVEMENT REPAIR

### 4. NATURE OF CHANGE (Identify paragraph number and include proposed rewrite, if possible. Attach extra sheets as needed.)

### 5. REASON FOR RECOMMENDATION

### 6. SUBMITTER

a. NAME (Last, First, Middle Initial)

b. ORGANIZATION

c. ADDRESS (Include Zip Code)

d. TELEPHONE (Include Area Code)  
(1) Commercial  
(2) AUTOVON  
(If applicable)

7. DATE SUBMITTED  
(YYMMDD)

### 8. PREPARING ACTIVITY

a. NAME  
COMMANDER, NORTHERN DIVISION  
NAVAL FACILITIES ENGINEERING COMMAND  
CODE PWCS

b. TELEPHONE (Include Area Code)  
(1) Commercial (2) AUTOVON  
(610)595-0663 443-0663

c. ADDRESS (Include Zip Code)  
10 INDUSTRIAL HWY (MSC82)  
LESTER, PA 19113-2090

IF YOU DO NOT RECEIVE A REPLY WITHIN 45 DAYS, CONTACT:  
Defense Quality and Standardization Office  
5203 Leesburg Pike, Suite 1403, Falls Church, VA 22041-3466  
Telephone (703) 756-2340 AUTOVON 289-2340