

AMC PAMPHLET

AMCP 706-361

240110

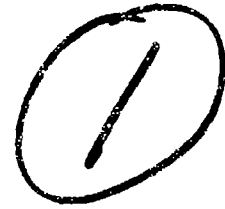

AD A 013769

ENGINEERING DESIGN HANDBOOK

MILITARY VEHICLE

POWER PLANT COOLING

DDC
RECEIVED
AUG 22 1975
MILITARY VEHICLE

Reproduced by
NATIONAL TECHNICAL
INFORMATION SERVICE
US Department of Commerce
Springfield, VA. 22151

HEADQUARTERS, US ARMY MATERIEL COMMAND

JUNE 1975

DISTRIBUTION STATEMENT A

Approved for public release;
Distribution Unlimited

341

DEPARTMENT OF THE ARMY
HEADQUARTERS UNITED STATES ARMY MATERIEL COMMAND
5001 Eisenhower Ave., Alexandria, VA 22333

AMC PAMPHLET
NO. 706-361

30 June 1975

ENGINEERING DESIGN HANDBOOK

MILITARY VEHICLE POWER
PLANT COOLING

TABLE OF CONTENTS

<i>Paragraph</i>		<i>Page</i>
	LIST OF ILLUSTRATIONS	xvii
	LIST OF TABLES	xxxiii
	PREFACE	xxxv
 CHAPTER 1. INTRODUCTION TO THE MILITARY COOLING SYSTEM 		
1-1	Scope	1-1
1-1.1	Conventional Cooling Systems for Reciprocating Internal Combustion Engines	1-4
1-1.2	Conventional Cooling Systems for Rotating Engines	1-6
1-1.2.1	Gas Turbine Engine	1-6
1-1.2.2	Rotating Combustion Engine	1-6
1-2	Cooling Requirements	1-7
1-3	Typical Cooling Systems	1-11
1-3.1	Conventional Trucks	1-11
1-3.1.1	Liquid-cooled	1-11
1-3.1.2	Air-cooled	1-11
1-3.2	Special Purpose Vehicles	1-15
1-3.2.1	Liquid-cooled	1-15
1-3.2.1.1	Carrier, Command and Reconnaissance, Armored, M114A1	1-15
1-3.2.1.2	Carrier, Assault Amphibian, Personnel, LVTPX12	1-15
1-3.2.1.3	Crane, 20-ton, Rough Terrain	1-18
1-3.2.2	Air-cooled	1-20
1-3.2.3	Family of Military Engineer Construction Equipment (FAMECE)	1-20
1-3.3	Combat Vehicles	1-22
1-3.3.1	Tanks	1-22
1-3.3.1.1	MBT70 Prototype/XM803 Experimental Tanks	1-22
1-3.3.1.1.1	Air-cooled Tank Engines	1-22

DISTRIBUTION STATEMENT A
Approved for public release;
Distribution Unlimited

DDC
RECEIVED
AUG 27 1975
RECEIVED
D

TABLE OF CONTENTS (Con't.)

<i>Paragraph</i>	<i>Page</i>
1-3.3.1.1.1 Diesel Engine (Compression Ignition)	1-22
1-3.3.1.1.2 Gas Turbine Engine	1-25
1-3.3.1.2 Tank, M60/M48A3	1-25
1-3.3.2 Liquid-cooled Combat Vehicles	1-29
1-3.3.2.1 Armored Reconnaissance Airborne/Assault Vehicle, Full-tracked, M551 (SHERIDAN)	1-29
1-3.3.2.2 Howitzer, Medium, Self-propelled, 155 mm M109	1-30
1-4 Special Military Considerations	1-31
1-4.1 Severity of Military Usage	1-31
1-4.1.1 Cross-country Operation	1-34
1-4.1.1.1 High Impact Loadings	1-34
1-4.1.1.2 Terrain Characteristics	1-36
1-4.1.2 Environmental Extremes for Worldwide Usage	1-36
1-4.1.3 Heavy Armament Firing Impact Loads	1-38
1-4.1.4 Lack of Maintenance	1-39
1-4.1.5 Operation by Military Personnel	1-39
1-4.1.6 Air-drop/Transportability Capabilities	1-41
1-4.1.7 Design for Shock and Vibration	1-44
1-4.2 Ballistic Protection	1-46
1-4.2.1 Necessity for Ballistic Protection	1-46
1-4.2.2 Ballistic Grilles and Their Impact on Cooling Airflow	1-46
1-4.2.3 Impact of Ballistic Requirements on Cooling System Design	1-49
1-4.3 Tactical Employment of Combat Vehicles	1-50
1-4.3.1 Tank-Infantry Teams	1-50
1-4.3.2 Use of Top Deck for Carrying Personnel	1-50
1-4.4 Reliability and Durability	1-50
1-4.4.1 Importance of Reliability and Durability in Military Operations	1-50
1-4.4.2 Importance of Cooling System in Overall Reliability	1-51
1-4.4.3 Methods of Achieving Cooling System Reliability	1-51
1-4.4.3.1 Use of Proven Components	1-51
1-4.4.3.2 Minimizing the Number of Components	1-54
1-4.4.3.3 Redundant Design	1-54
1-4.5 Maintenance Requirements	1-54
1-4.5.1 Accessibility	1-54
1-4.5.2 Module Replacement	1-55
1-4.5.3 Simplicity	1-55
1-4.5.4 Coolants, Fuels, and Lubricants	1-55
1-4.5.4.1 Coolants	1-55

TABLE OF CONTENTS (Con't.)

<i>Paragraph</i>	<i>Page</i>
1-4.5.4.2 Fuel and Lubricants	1-57
1-4.5.5 Complete Power Package Removal	1-58
1-4.6 Infrared (IR) Signature	1-59
1-4.6.1 Description of IR Phenomena	1-59
1-4.6.2 IR Suppression for Combat Vehicles	1-59
1-4.6.3 The IR Radiation Problem	1-59
1-4.6.3.1 Necessity for Suppression	1-59
1-4.6.3.2 Degree of Suppression Required	1-59
1-4.6.3.3 Military Importance of IR Signature	1-59
1-4.6.3.4 Reducing IR Radiation to a Minimum	1-59
1-4.6.4 Techniques Used for IR Radiation Minimiza- tion	1-61
1-4.6.4.1 Recommended Procedures for IR Suppres- sion	1-61
1-4.6.4.1.1 Concealing Mufflers and Exhaust Pipes	1-61
1-4.6.4.1.2 Insulated Shield for Exit Grilles	1-61
1-4.6.4.1.3 Minimize Exit Grille Areas	1-62
1-4.6.4.1.4 Location of Hot Surfaces	1-62
1-4.6.4.1.5 Mixing Exhaust With Cooling Air	1-62
1-4.6.4.1.6 Shielding and Insulating	1-62
1-4.6.4.1.7 Location of Exhaust	1-62
1-4.6.5 Suppression Methods To Meet Future Require- ments	1-62
1-4.6.6 Camouflage in IR Suppression	1-64
1-4.6.7 Example of IR Suppression Test Data	1-64
1-4.7 Depot Storage	1-64
1-4.8 Special Kits	1-64
1-4.8.1 Winterization Kits	1-64
1-4.8.1.1 Heating of Power Package Components	1-65
1-4.8.1.2 Restriction of Cooling Air	1-65
1-4.8.2 Fording Kits	1-68
1-4.8.3 Fording Requirement Effects on Cooling System Design	1-68
1-4.8.3.1 Electric and Hydraulic Motors	1-69
1-4.8.3.2 Sealing of Power Transmission Components	1-69
1-4.8.3.3 Fan Fording Cut-off Switches	1-69
1-4.8.3.4 Mechanically Driven Fans	1-69
1-4.8.3.5 Turbine Shielding	1-69
1-4.8.4 Effects of Kits an Vehicle Cooling Systems	1-69
1-4.8.4.1 Winches	1-70
1-4.8.4.2 On-vehicle Equipment	1-70
1-4.8.4.3 High Demand Electrical Equipment	1-70
References	1-71
Bibliography	1-73

TABLE OF CONTENTS (Con't.)

<i>Paragraph</i>		<i>Page</i>
CHAPTER 2. MILITARY VEHICLE POWER PLANT—SOURCES OF HEAT		
2-0	List of Symbols	2-1
2-1	Basic Engine Heat Transfer	2-3
2-1.1	Military Vehicle Power Plants	2-3
2-1.2	Basic Air Standard Cycles	2-4
2-1.3	Variations of Standard Thermodynamic Cycles	2-4
2-1.4	Conventional Reciprocating Engine Heat Rejection	2-6
2-1.5	Methods Used To Estimate Engine Heat Rejection	2-9
2-1.6	Coolants	2-18
2-1.6.1	Lubricating Oil	2-18
2-1.6.2	Air	2-18
2-1.6.3	Liquids	2-19
2-1.7	Cylinder Cooling Fins	2-19
2-1.8	Exhaust Manifolds	2-19
2-1.9	Gas Turbine Engine Heat Rejection	2-20
2-1.9.1	Lubricating Oil	2-20
2-1.9.2	Exhaust System	2-20
2-1.10	Other Types of Vehicle Engines	2-22
2-1.10.1	Stirling Engine	2-22
2-1.10.2	Rotating Combustion Engine (Wankel)	2-23
2-1.10.3	Rankine Cycle Engine	2-24
2-1.11	Other Types of Engine Power Sources	2-24
2-1.11.1	Fuel Cells	2-24
2-1.11.2	Stored Electrical Energy	2-25
2-1.11.3	Nuclear Energy	2-26
2-1.11.4	Combination Power Plants	2-26
2-2	Transmission and Drive Components	2-26
2-2.1	Multiple Ratio Gear Transmissions	2-26
2-2.1.1	Clutches	2-29
2-2.1.2	Power Losses and Efficiency	2-29
2-2.2	Cross Drive Transmissions	2-30
2-2.2.1	Internal Brakes	2-31
2-2.2.2	Steering Clutches	2-31
2-2.3	Hydraulic Drives	2-32
2-2.3.1	Hydrostatic	2-32
2-2.3.2	Hydrokinetic	2-38
2-2.3.3	Hydromechanical	2-41
2-2.4	Electric Drives	2-42
2-2.4.1	Cooling Requirements	2-42
2-2.4.2	Power Losses and Efficiency	2-46
2-2.5	Transfer Cases and Final Drives	2-46
2-2.6	Hydraulic Retarders	2-47
2-3	Miscellaneous Heat Sources	2-47

TABLE OF CONTENTS (Con't.)

<i>Paragraph</i>		<i>Page</i>
2-3.1	Hydraulic Systems	2-47
2-3.1.1	Motors	2-48
2-3.1.2	Pumps	2-48
2-3.2	Electric Motors and Generators	2-50
2-3.3	Fuel Injection Pumps	2-50
2-3.4	Air Compressors	2-51
2-3.5	Environmental Control Units	2-51
2-3.6	Solar and Ground Radiation	2-55
2-3.7	Auxiliary Engines	2-55
2-3.8	Engine Compartment Ventilation Heat Loads ...	2-55
	References	2-59
	Bibliography	2-61

CHAPTER 3. HEAT TRANSFER DEVICES

3-0	List of Symbols	3-1
3-1	Introduction	3-5
3-2	Modes of Heat Transfer	3-5
3-2.1	Radiation	3-5
3-2.2	Conduction	3-6
3-2.3	Convection	3-6
3-3	Heat Transfer Fins	3-7
3-4	Heat Exchangers	3-8
3-4.1	Types of Heat Exchangers	3-8
3-4.1.1	Steady Flow Heat Exchanger	3-8
3-4.1.2	Transient Flow Heat Exchanger	3-8
3-4.2	Heat Exchanger Classification by Flow Arrange- ment	3-9
3-4.2.1	Parallel Flow	3-9
3-4.2.2	Counterflow	3-9
3-4.2.3	Crossflow	3-9
3-4.2.4	Cross-counterflow	3-9
3-4.2.5	Cross-parallel Flow	3-9
3-4.2.6	Comparison of Heat Exchangers Based on Flow Arrangements	3-9
3-4.3	Heat Exchanger Classification by Heat Transfer Surface Geometries	3-12
3-4.3.1	Plate-fin Surfaces	3-12
3-4.3.1.1	Plain-fin Surfaces	3-13
3-4.3.1.2	Interrupted Fin Surfaces	3-13
3-4.3.2	Tubular Surfaces	3-13
3-4.3.3	Fin and Tube Configurations	3-14
3-4.4	Heat Exchanger Classification by Fluids Involved	3-14
3-5	Heat Exchanger Design and Selection	3-14

TABLE OF CONTENTS (Con't.)

<i>Paragraph</i>		<i>Page</i>
3-5.1	Thermal Design Principles of Two-fluid Heat Exchanger Cores	3-18
3-5.1.1	Basic Thermal Design Equations	3-18
3-5.1.1.1	Energy Balance Equation	3-18
3-5.1.1.2	Heat Transfer Rate Equations	3-18
3-5.1.1.2.1	Thermal Resistance Equation	3-19
3-5.1.1.2.2	Basic Heat Exchanger Core Design	3-20
3-5.1.1.2.3	Unit Core Heat Transfer Capability Method ..	3-20
3-5.2	Fluid Pressure Drop in Heat Exchangers	3-23
3-6	Vehicle Cooling	3-24
3-6.1	Direct Cooling	3-24
3-6.2	Indirect Cooling	3-25
3-6.2.1	Radiators	3-25
3-6.2.1.1	Design Parameters for Military Environment ..	3-27
3-6.2.1.2	Component Installation Considerations	3-29
3-6.2.1.3	Radiator Core Design Variables	3-30
3-6.2.1.3.1	Design Variables of Radiator Core	3-30
3-6.2.1.3.2	Heat Transfer Capability	3-30
3-6.2.1.3.3	Air Side Efficiency	3-31
3-6.2.1.3.4	Deaeration	3-32
3-6.2.1.4	Coolant Reserve	3-34
3-6.2.1.5	Radiator Selection	3-34
3-6.3	Engine Oil Coolers	3-40
3-6.3.1	Radiator Tank Oil Cooler	3-41
3-6.3.2	Liquid-cooled Plate-type Oil Coolers	3-42
3-6.3.3	Shell-and-tube Type or Tube-bundle Type Oil Cooler	3-43
3-6.4	Transmission Oil Coolers	3-43
3-6.5	Oil-cooler Selection and Optimization Examples ..	3-47
3-6.6	Oil-cooler Optimization	3-49
3-6.7	Aftercoolers	3-55
3-6.8	Keel Coolers	3-59
3-6.9	Arrangements of Cooling System Components ..	3-68
3-7	Thermal Insulation	3-69
3-7.1	Purpose and Application	3-69
3-7.2	Thermo Physical Properties Affecting Heat Transfer	3-70
	References	3-78
	Bibliography	3-79

CHAPTER 4. AIR MOVING DEVICES

4-0	List of Symbols	4-1
4-1	Introduction	4-3
4-2	Fans	4-3

TABLE OF CONTENTS (Con't.)

<i>Paragraph</i>		<i>Page</i>
4-2.1	Centrifugal Fans	4-3
4-2.1.1	Forward Curved Blade Fans	4-4
4-2.1.2	Backward Curved Blade Fans	4-4
4-2.1.3	Radial Blade Fans	4-6
4-2.1.4	Off-design Characteristics	4-6
4-2.2	Axial Flow Fans	4-6
4-2.2.1	Propeller Fans	4-6
4-2.2.2	Tube-axial Fans	4-7
4-2.2.3	Vane-axial Fans	4-7
4-2.3	Centrifugal and Axial Flow Fan Comparison	4-8
4-2.4	Mixed Flow Fans	4-9
4-2.5	Flexible Blade Fans	4-9
4-3	Cooling Fans for Military Vehicles	4-9
4-4	Total Pressure Differential Developed by a Fan	4-9
4-5	Fan Air Horsepower	4-13
4-6	Fan Efficiencies	4-13
4-7	Fan Performance	4-14
4-7.1	Tip Speed	4-14
4-7.2	Outlet Velocity	4-15
4-7.3	Standard Fan Components	4-15
4-8	Fan Laws	4-15
4-8.1	Performance Variables	4-15
4-8.2	Fan Noise	4-17
4-8.3	Fan Law Restrictions	4-18
4-8.4	Examples of Fan Law Use	4-18
4-9	Specific Speed	4-20
4-10	Effect of System Resistance on Fan Performance	4-21
4-10.1	System Resistance	4-22
4-10.2	Fan and System Matching	4-22
4-11	Multiple Fan System	4-23
4-11.1	Parallel Operation	4-23
4-11.2	Series Operation	4-24
4-12	Fan Selection	4-24
4-12.1	Standard Designs	4-24
4-12.2	Fan Selection Procedure	4-25
4-12.3	Fan Selection Examples	4-29
4-12.4	Fan Overspecification	4-30
4-13	Fan Installation	4-30
4-14	Fan Shrouding	4-36
4-15	Fan Drives and Speed Controls	4-36
4-15.1	Mechanical Drives	4-36
4-15.1.1	Belt Drives	4-37
4-15.2.2	Shaft Drives	4-37
4-15.1.3	Gearbox Drives	4-37
4-15.1.3.1	Single Speed	4-37

TABLE OF CONTENTS (Con't.)

<i>Paragraph</i>	<i>Page</i>
4-15.1.3.2 Multispeed	4-37
4-15.2 Electric Drives	4-37
4-15.3 Hydraulic Drives	4-38
4-15.4 Viscous Fan Drive	4-40
4-15.5 Variable Blade-pitch Fan	4-40
4-16 Fan Drive Noise	4-40
4-17 Exhaust Ejectors	4-41
References	4-46
Bibliography	4-46

**CHAPTER 5. CONTROL AND INSTRUMENTATION
 OF THE COOLING SYSTEM**

5-1 Functions of the Cooling System	5-1
5-2 Pressurized Liquid-coolant Systems	5-1
5-2.1 Coolant Operating Temperature	5-1
5-2.2 Coolant Pump Cavitation	5-1
5-2.3 After Boil	5-2
5-2.4 Altitude Operation	5-2
5-3 Methods of Cooling Control	5-3
5-3.1 Throttling of the Cooling Air	5-4
5-3.1.1 Radiator Shutters	5-4
5-3.1.1.1 Application	5-4
5-3.1.1.2 Operation	5-4
5-3.1.2 Winterization Shutters	5-4
5-3.1.2.1 Purpose	5-4
5-3.1.2.2 Operation	5-5
5-3.2 Heating of the Cooling Air	5-6
5-3.3 Heating of the Lubricating Oil and Coolant	5-6
5-3.4 Modulation of Cooling Fan Speed	5-7
5-3.5 Liquid-coolant Flow Rate Control	5-7
5-3.6 Control of Oil Flow Rate to Oil-coolers	5-7
5-4 Controls and Instruments	5-9
5-4.1 Radiator Caps	5-12
5-4.1.1 General	5-12
5-4.1.2 Types of Radiator Caps	5-12
5-4.1.2.1 Plain (Solid) Caps	5-12
5-4.1.2.2 Pressure Caps	5-12
5-4.1.2.2.1 Purpose and Application	5-12
5-4.1.2.2.2 Types of Pressure Caps	5-14
5-4.1.2.2.3 Operation	5-14
5-4.2 Surge Tanks	5-14
5-4.2.1 Purpose	5-14
5-4.2.2 Application and Operation	5-16
5-4.2.3 Surge Tank Installation	5-18

TABLE OF CONTENTS (Con't.)

<i>Paragraph</i>		<i>Page</i>
5-4.2.3.1	Pressurized Type Surge Tank	5-18
5-4.2.3.2	Nonpressurized Type Surge Tank (Coolant Recovery)	5-18
5-4.3	Thermostats	5-18
5-4.3.1	Purpose	5-18
5-4.3.2	Operation	5-19
5-4.3.3	General Construction	5-20
5-4.3.4	Classification	5-21
5-4.3.5	Types of Actuating Elements	5-22
5-4.3.5.1	Bellows Type	5-22
5-4.3.5.2	Pellet Type	5-23
5-4.3.6	Thermostat Control Modes	5-24
5-4.3.6.1	Choke Type	5-25
5-4.3.6.2	Top or Bottom Bypass Type	5-25
5-4.3.7	Thermostat Coolant Flow Systems	5-26
5-5	Temperature Sending Units	5-26
5-5.1	Purpose	5-26
5-5.2	Application	5-26
5-5.3	Operation	5-26
5-6	Warning Units	5-29
5-7	Coolant Level Indicators	5-29
5-8	Coolant Level and Aeration Warning System	5-30
	References	5-32
	Bibliography	5-32

CHAPTER 6. GRILLES

6-0	List of Symbols	6-1
6-1	Nonballistic Grilles and Screens	6-3
6-1.1	Purpose	6-3
6-1.2	Types and Construction	6-3
6-2	Ballistic Grilles	6-3
6-2.1	Purpose	6-3
6-2.2	Grille Design	6-5
6-2.3	Types and Construction	6-7
6-2.3.1	Venturi Type	6-7
6-2.3.2	Bar Type	6-7
6-2.3.3	Fish-hook Type	6-8
6-2.3.4	Table-top Type	6-8
6-2.3.5	Chevron Type	6-8
6-3	Airflow Resistance Characteristics	6-8
6-4	Ballistic Protection Characteristics	6-12
6-5	Noise	6-12
6-6	Test and Evaluation	6-15

AMCP 706-361

TABLE OF CONTENTS (Con't.)

<i>Paragraph</i>		<i>Page</i>
6 7	Grille Installation Design Considerations	6 15
	References	6- 18
	Bibliography	6 18

CHAPTER 7. SYSTEM FLOW RESISTANCE ANALYSIS

7--0	List of Symbols	7 1
7--1	Fluid Flow Conditions	7--3
7- 2	Flow Resistance	7-3
7- 2.1	Flow Resistance of Incompressible Fluid Flow	7-3
7--2.2	Pressure Drop Classifications	7--4
7--2.2.1	Friction Pressure Drop	7--4
7--2.2.1.1	Reynolds Number	7- 6
7--2.2.1.2	Relative Roughness	7 6
7--2.2.2	Dynamic Pressure Drops	7--6
7--2.2.2.1	Fluid Pressure Drops in a Bend or Elbow	7-6
7--2.2.2.2	Loss Coefficient for Bends and Elbows	7 6
7--2.2.2.3	Dynamic Losses for Area Changes	7 11
7--2.2.2.4	Diffusers	7 11
7--2.2.3	Screens and Grids	7-11
7--2.2.4	Air Pressure Loss Over Immersed Bodies	7 13
7--2.2.5	Air Pressure Drop Through a Heat Transfer Matrix	7--16
7--2.2.6	Grille Friction Losses	7--16
7--2.2.6.1	Intake Grille	7--16
7--2.2.6.2	Exhaust Grille	7- 19
7-2.3	Fluid Pressure Loss Minimization Techniques	7-19
7--2.3.1	Grille Areas	7 19
7--2.3.2	Provisions for Uniform or Gradually Changing Grille Areas	7--20
7--2.3.3	Duct Design	7--20
7--2.3.3.1	Duct Shape	7--20
7--2.3.3.2	Flow Pressure Losses	7--20
7--2.3.4	Reduction of Pressure Loss in Turns	7-20
7--2.3.5	Cooling Airflow Test of the M551 SHERIDAN Vehicle	7--21
7--2.4	System Total Air Resistance Example. XM803 Experimental Tank	7--21
7--2.4.1	System Resistance Characteristics	7--21
7--2.4.2	Example of Determination of the Air Resistance for the XM803 Experimental Tank Engine Cooling Airflow System.	7--22
7--2.4.2.1	Intake Grille	7--23

TABLE OF CONTENTS (Con't.)

<i>Paragraph</i>		<i>Page</i>
7-2.4.2.2	Power Package Compartment	7-23
7-2.4.2.3	Engine	7-25
7-2.4.2.4	Fan	7-25
7-2.4.2.5	Outlet Duct	7-25
7-2.4.2.6	Exhaust Grille	7-29
7-2.4.2.7	Total System Resistance	7-30
7-3	System Liquid Flow Analysis	7-31
7-3.1	Engine Coolant Pump	7-31
7-3.2	Oil Pumps	7-32
7-3.3	Liquid Flow Resistance	7-34
7-3.3.1	Oil Flow Resistance	7-34
7-3.3.2	Engine Coolant Flow Resistance	7-38
7-3.3.3	Fluid Flow Resistance in Piping Systems	7-39
	References	7-41
	Bibliography	7-42

**CHAPTER 8. SYSTEM INTEGRATION AND
 INSTALLATION DESIGN**

8-0	List of Symbols	8-1
8-1	Design Criteria	8-5
8-1.1	Cooling System Analysis	8-7
8-1.1.1	Power Plant Compartment Analysis	8-9
8-1.1.2	Engine Heat Rejection	8-9
8-1.1.3	Engine Accessories and Auxiliary Equipment ..	8-9
8-1.1.4	Engine Oil Cooler	8-9
8-1.1.5	Engine Exhaust	8-10
8-1.1.6	Transmission	8-10
8-1.1.7	Clutch	8-10
8-1.1.8	Retarder	8-10
8-1.1.9	Fuel Tank	8-10
8-1.1.10	Power Plant Heat Transfer	8-10
8-1.1.11	Airflow	8-10
8-1.1.12	Winterization	8-12
8-1.1.13	Cooling System Variables	8-12
8-1.2	Vehicle Performance Specifications	8-14
8-2	Cooling System Integration	8-14
8-3	Cooling System Optimization	8-14
8-4	Cooling Subsystem Trade-off Analysis	8-14
8-5	Cooling System Design Examples	8-15
8-5.1	Preliminary Cooling System Design	8-15
8-5.1.1	Engine Cooling	8-15
8-5.1.2	Transmission Cooling	8-20
8-5.1.3	Design of the Experimental Power Plant Cooling System Installation for the M114 Product Im- provement Program (PIP) Vehicle	8-23

TABLE OF CONTENTS (Con't.)

<i>Paragraph</i>		<i>Page</i>
8-5.1.3.1	Cooling System Description for the Repowered Vehicle.....	8-23
8-5.1.3.2	Cooling System Design Procedure	8-23
8-5.1.3.3	Determination of Radiator Size	8-27
8-5.1.3.4	Determination of Engine Oil Cooler Size	8-33
8-5.1.3.5	Determination of Transmission Oil Cooler Size	8-33
8-5.1.3.6	Cooling System Mock-up Tests	8-35
8-5.1.3.7	M114 Product Improvement Program Hydrostatic Fan Drive	8-35
8-5.2	XM803 Experimental Tank With Air-cooled Diesel Engine	8-42
8-5.2.1	Engine Cooling	8-43
8-5.2.1.1	Engine Cylinder Heat Rejection	8-43
8-5.2.1.2	Engine Oil Heat Rejection	8-46
8-5.2.1.3	Engine Induction Air Heat Rejection in Aftercooler	8-50
8-5.2.1.4	Engine Cooling Fan Selection	8-60
8-5.2.2	Transmission Heat Rejection	8-60
8-5.3	Liquid-cooled Engine Installation	8-66
	References	8-78
	Bibliography.....	8-79

CHAPTER 9. TEST AND EVALUATION

9-1	Importance of Vehicle Tests.....	9-1
9-2	Requirements for Component Tests.....	9-1
9-2.1	Heat Exchangers	9-1
9-2.1.1	Radiators	9-1
9-2.1.2	Engine/Transmission Oil Coolers	9-2
9-2.1.3	Miscellaneous Coolers	9-2
9-2.2	Fans	9-3
9-2.3	Coolant Pumps	9-3
9-2.4	Grilles.....	9-3
9-3	Cooling System	9-3
9-3.1	Cooling System Vehicle Simulation Tests	9-5
9-3.1.1	Cold Mock-up Tests	9-5
9-3.1.2	Hot Mock-up Tests	9-6
9-3.1.3	Cooling System Deaeration Requirements	9-10
9-3.1.4	Test Rig	9-10
9-3.2	Total Vehicle Tests	9-10
9-4	Examples of Vehicle Cooling Program Tests	9-11
9-4.1	Test Facilities, Methods, and Procedures	9-11
9-4.2	M113/M113A1 Cooling Verification and Product Improvement Program Tests.....	9-14

TABLE OF CONTENTS (Con't.)

<i>Paragraph</i>		<i>Page</i>
9-4.2.1	General	9-14
9-4.2.2	Cooling Test Objectives	9-14
9-4.2.3	As-received Vehicle Cooling Test Results	9-14
9-4.2.4	Modified Vehicle Cooling Tests	9-15
9-4.3	M110 Cooling Verification and Product Improvement Program Tests	9-15
9-4.3.1	General	9-15
9-4.3.2	Cooling Test Objectives	9-15
9-4.3.3	As-received Vehicle Cooling Test Results	9-15
9-4.3.4	Modified Vehicle Cooling Tests	9-15
9-4.3.5	Surge Tank Tests	9-17
9-4.4	M551 Cooling Verification and Product Improvement Program	9-17
9-4.4.1	General	9-17
9-4.4.2	Cooling Test Objectives	9-19
9-4.4.3	As-received Vehicle Cooling Tests Results (Nominal 300-hp Engine)	9-20
9-4.4.4	Modified Vehicle Cooling Tests	9-20
9-4.5	M561 Cooling Verification and Product Improvement Program	9-22
9-4.5.1	General	9-22
9-4.5.2	Cooling Test Objectives	9-24
9-4.5.3	As-received Vehicle Cooling Test Results	9-24
9-4.5.4	Modified Vehicle Cooling Tests	9-24
9-4.5.5	Observations and Conclusions	9-24
9-4.5.6	Evaluation of Vehicle Coolant Solutions	9-24
9-5	US Army Tank-Automotive Command Cooling System Responsibilities	9-26
9-5.1	Developmental Tests II and III	9-27
9-5.2	Environmental Tests	9-27
9-6	Military System Development Descriptions	9-32
9-6.1	Conduct of Development Testing (DT) and Operational Testing (OT)	9-32
9-6.2	Development Testing	9-34
9-6.3	Operational Testing	9-35
9-7	Test Agencies	9-37
	References	9-38
APPENDIX A		
A-1	Oil-cooler Performance	A-1
A-2	Typical Radiator Core Performance	A-34
APPENDIX B		
B-i	Cooling Fan Details and Performance Characteristics	B-1
B-2	Mixed Flow Fans	B-21

AMCP 706-361

TABLE OF CONTENTS (Con't.)

<i>Paragraph</i>		<i>Page</i>
B-2.1	Optimized System Engineering Approach to the Solution of Engine Cooling Problems in Military Vehicles	B-21
B-2.2	Mixed Flow Fans for Engine Cooling Systems ...	B-21
B-2.3	Installation of Mixed Flow Cooling Fans in Military Vehicles	B-23
B-2.4	System Engineering	B-24
B-2.5	Cooling System Optimization	B-27
B-2.6	Definitions of Units	B-29
B-3	Detroit Diesel Engine Cooling Fans	B-34

APPENDIX C

C-1	Ballistic Grille Performance Data	C-1
-----	---	-----

APPENDIX D

D-1	Radiator Test and Evaluation Procedures	D-1
D-1.1	Test Procedures	D-1
D-1.1.1	Conditions	D-1
D-1.1.2	Support	D-1
D-1.1.3	Equipment	D-1
D-1.1.4	Instrumentation	D-1
D-1.1.5	Control Limits and Data Observations	D-1
D-1.1.6	Coolant	D-1
D-1.1.7	Coolant Temperatures	D-1
D-1.1.8	Heat Rejection	D-1
D-1.1.9	Airflow	D-2
D-1.1.10	Air-pressure-drop Corrections	D-3
D-1.1.11	Vibration	D-3
D-1.2	Tests	D-3
D-1.2.1	Heat Rejection and Core Resistance	D-3
D-1.2.2	Pressure Cycling	D-3
D-1.2.3	Resonance Survey	D-3
D-1.2.4	Vibration	D-3
D-1.3	Definitions	D-4
D-2	Engine/Transmission Oil Cooler Test Specification and Procedure	D-5
D-2.1	Oil-to-Air Cooler	D-5
D-2.1.1	Specifications	D-5
D-2.1.2	Test Procedure	D-5
D-2.1.2.1	Heat Rejection	D-5
D-2.1.2.2	Air Side Measurements	D-5
D-2.1.2.3	Heat Balance	D-5
D-2.1.2.4	Pressure Test	D-6

TABLE OF CONTENTS (Con't.)

<i>Paragraph</i>	<i>Page</i>
D-2.1.2.5 Cyclic Test	D-6
D-2.2 Oil-to-Water Cooler	D-6
D-2.2.1 Specifications	D-6
D-2.2.2 Test Procedure	D-8
D-2.2.2.1 Heat Rejection	D-8
D-2.2.2.2 Heat Balance	D-8
D-2.2.3 Pressure Test	D-8
D-2.2.4 Cyclic Test	D-8
D-3 Fan Performance Test Procedure	D-8
D-3.1 Test Set-up and Equipment	D-8
D-3.1.1 General	D-8
D-3.1.2 Test Instruments	D-8
D-3.1.2.1 Pressure Measuring Instruments	D-8
D-3.1.2.2 Power Measuring Instruments	D-11
D-3.1.2.3 Speed Measuring Instruments	D-11
D-3.1.2.4 Temperature Measuring Instruments	D-11
D-3.1.2.5 Barometric Pressure Measuring Instruments	D-11
D-3.1.2.6 Pitot Tube	D-12
D-3.2 Observations	D-12
D-3.3 Test Method	D-12
D-3.4 Results	D-12
D-4 Coolant Pump Test	D-12
D-4.1 Objective	D-15
D-4.2 Test Equipment	D-15
D-4.3 Test Material	D-15
D-4.4 Test Procedures	D-15
D-4.5 Results	D-15
D-4.6 Conclusion	D-16
D-5 XM803 Experimental Tank Hot Mock-up Instru- mentation List and Schematic Diagrams	D-16
D-5.1 Induction Air	D-16
D-5.1.1 Air Temperatures and Pressures	D-16
D-5.1.2 Miscellaneous	D-16
D-5.2 Lubrication System	D-16
D-5.2.1 Oil Temperatures	D-16
D-5.2.2 Oil Pressures	D-16
D-5.2.3 Oil Temperatures and Pressures	D-16
D-5.3 Cooling Air System	D-16
D-5.3.1 Temperatures	D-16
D-5.3.2 Pressures	D-17
D-5.4 Engine Fuel System	D-17
D-5.4.1 Fuel Temperatures	D-17
D-5.4.2 Fuel Pressures	D-17
D-5.4.3 Miscellaneous	D-18
D-5.5 Engine Temperatures	D-18

TABLE OF CONTENTS (Con't.)

<i>Paragraph</i>	<i>Page</i>
D-5.6 Exhaust Gas	D-18
D-5.6.1 Temperatures	D-18
D-5.6.2 Turbine Inlet Pressures	D-18
D-5.6.3 Instrumentation/Schematic Diagrams	D-18
D-6 Cooling System Deaeration Tests	D-18
D-6.1 Deaeration Capacity Test	D-18
D-6.2 Low Capacity Test	D-22
D-6.3 Surge Test	D-22
D-6.4 Typical Vehicle Cooling System Investigation Tests	D-22
D-6.4.1 M110 Deaeration Test With/Without Surge Tank	D-22
D-6.4.2 Tractor Truck Coolant Removal Test, 2-1/2-ton, M275A2	D-22
D-6.4.3 Vehicle Hot Shutdown Tests	D-22
D-6.4.3.1 Tractor Truck, 2-1/2-ton, M275A2	D-24
D-6.4.3.2 Dump Truck, 5-ton, XM817	D-24
D-7 M110 Product Improvement Test Plan (USTACOM)	D-26
D-7.1 TITLE: Cooling and Performance Test of M110 Vehicle-8V71T Engine	D-26
D-7.2 Object	D-26
D-7.3 Outline of Problem	D-26
D-7.4 Test Material	D-26
D-7.5 Test Equipment	D-26
D-7.6 Test Procedure	D-26
D-7.6.1 Instrumentation	D-26
D-7.6.2 Preliminary Operation	D-29
D-7.6.3 Tests	D-29
D-7.6.3.1 Stall Check-Gear Setting High Range	D-29
D-7.6.3.2 Cooling Tests	D-30
D-7.6.3.3 Surge Tank Investigation (Phase II)	D-30
D-7.6.3.4 Radiator Restriction	D-31
D-7.6.3.5 Fam Belt Investigation	D-31
D-7.6.3.6 Other Tests	D-31
D-7.7 Test Results	D-31
Index	I-1

LIST OF ILLUSTRATIONS

<i>Fig. No.</i>	<i>Title</i>	<i>Page</i>
1-1	Rotary Engine Cooling System Diagram	1-7
1-2	NSU KKM 502 Wankel Engine Cooling System . . .	1-8
1-3	NSU Spider Car Wankel Engine, Installed View . . .	1-9
1-4	Typical Cooling System Components	1-12
1-5	Coolant Flow With Coolant Bypass and Bleed Hole in Thermostat	1-13
1-6	Circulation of Coolant in Engine Coolant Jacket . . .	1-14
1-7	Engine Lubricating Oil Cooling Schematic Diagram	1-14
1-8	Power Plant Installed in Carrier, Command and Reconnaissance, Armored, M114/M114A1	1-16
1-9	Carrier, Command and Reconnaissance, Armored, M114A1, Cooling Grilles	1-17
1-10	LVTPX12 Integrated Vehicle Cooling System	1-18
1-11	Crane, 20-ton, Rough Terrain	1-19
1-12	Cooling System Schematic Diagram, Crane, 20-ton, Rough Terrain	1-20
1-13	Rear View of Truck, Platform Utility, M274A5 . . .	1-21
1-14	Air-cooled Engine Used in Truck, Platform Utility, M274A5	1-22
1-15	FAMECE Power Module	1-23
1-16	FAMECE Construction Modules	1-24
1-17	MBT70 Prototype Tank Air-cooled Diesel Engine Power Package Installation	1-25
1-18	Tank, Experimental Model, XM803, Diesel Engine Power Package	1-26
1-19	AVCR-1100 Engine Cooling Airflow in the XM803 Experimental Tank	1-26
1-20	AVCR-1100 Power Package Installation in the XM803 Experimental Tank	1-27
1-21	Gas Turbine Engine Installation in MBT70 Prototype Tank	1-27
1-22	MBT70 Prototype Tank, Gas Turbine Engine Air- flow Schematic Diagram	1-28
1-23	MBT70 Prototype Tank Gas Turbine Engine Power Plant Removed from Vehicle	1-28
1-24	Tank, M60 Series, Cooling Air Inlet and Exhaust Grilles	1-29
1-25	AVDS-1790 Engine Cooling Airflow as Installed in M60 Tank	1-30
1-26	Mechanical Cooling Fan Drive Clutch	1-31
1-27	AVDS-1790 Engine for the M60 Tank	1-32
1-28	AVDS-1790 Engine Cylinder Cross Section	1-33
1-29	Armored Reconnaissance/Airborne Assault Vehicle, M551, Full-tracked (SHERIDAN)	1-34

AMCP 736-381

LIST OF ILLUSTRATIONS (Con't.)

<i>Fig. No.</i>	<i>Title</i>	<i>Page</i>
1-30	SHERIDAN, M551, Power Plant--Complete	1-35
1-31	SHERIDAN, M551, Power Package Airflow	1-36
1-32	SHERIDAN, M551, Cooling System Grilles	1-37
1-33	SHERIDAN, M551, Coolant System	1-38
1-34	Howitzer, M109, Cooling System Schematic Diagram	1-39
1-35	Typical Contour of Perryman Cross-country Course No. 4 at 1-ft Intervals	1-42
1-36	Typical Dust Conditions Encountered During Off-highway Operation	1-43
1-37	Deep Mud Encountered in Off-highway Operations	1-44
1-38	SHERIDAN, M551, Debris Deflector	1-45
1-39	Air Inlet Grille Battle Damage, Tank, M48	1-47
1-40	Debris Found in Tank, M48, Engine Compartment	1-48
1-41	Engine Oil Cooler Plugging on Tank, M48	1-49
1-42	Cross Section of Various Ballistic Grille Configurations	1-50
1-43	Service and Access Locations for MBT70 Prototype Tank Air-cooled Power Package and Related Systems	1-56
1-44	XM803 Experimental Tank Power Plant Test Run and Stall Check--Power Plant Removed	1-58
1-45	Vehicle IR Radiation Signature	1-60
1-46	Typical Projected IR Radiation Patterns for Wheeled Vehicles	1-60
1-47	Typical Projected IR Radiation Patterns for Tracked Vehicles	1-61
1-48	Exhaust Cooler	1-62
1-49	Reduction of IR Radiation	1-63
1-50	SHERIDAN, M551, Standby Winterization Kit	1-66
1-51	Combustion Heater, Winterization, XM803 and MBT70 Tanks	1-67
1-52	Truck, Cargo, 2-1/2-ton, 6 X 6, M35 During Deep-water Forging Tests	1-68
1-53	Radiator Restriction Caused by Winch Installation	1-70
1-54	SHERIDAN, M551, Cooling Air Recirculation Deflector Directly Beneath the Bustle Rack	1-71
2-1	Thermodynamic Cycles - Carnot, Otto, Diesel, and Dual	2-6
2-2	Thermodynamic Cycles - Brayton, Stirling, and Rankine	2-7
2-3	Elementary Compound Thermodynamic Cycle	2-8
2-4	Heat Flow Characteristics of LDS-465-1B Truck Diesel Engine	2-10

LIST OF ILLUSTRATIONS (Con't.)

<i>Fig. No.</i>	<i>Title</i>	<i>Page</i>
2-5	Heat Flow Characteristics of 3-53N Gamma Goat Diesel Engine	2-11
2-6	Heat Flow Characteristics of 6V-53N Diesel Engine Used in the M113A1 Vehicle	2-12
2-7	Heat Flow Characteristics of 6V-53T Diesel Engine Used in the Scout and M551 Vehicles ...	2-13
2-8	Heat Flow Characteristics of 8V-71T Diesel Engine Used in the M107, M108, M109, M110, and M578 Vehicles	2-14
2-9	Heat Flow Characteristics of 12V-71T Diesel Engine Used in the M746 Vehicle	2-15
2-10	AVDS-1790 Tank Diesel Engine-to-Oil Heat Rejection Characteristics	2-16
2-11	AVCR-1100-3B Cylinder Head Temperatures and Heat Rejection	2-17
2-12	Integral Engine Oil Cooler	2-19
2-13	AVCR-1100-3B Tank Engine Oil Cooler Mounting	2-20
2-14	Effect of Coolant Temperature and Coolant Composition on Heat Transfer for a 12-cylinder Liquid-cooled, 980 IHP, Aircraft Engine	2-21
2-15	Basic Shapes of Cylinder Fins	2-22
2-16	Gas Turbine Engine Oil Cooler Installation Schematic Diagram	2-22
2-17	Cut-away View of the Stirling Engine	2-23
2-18	Typical Configuration of a Vee-type Double-acting Stirling Engine	2-23
2-19	Stirling Engine Cooling System	2-24
2-20	Single Cylinder Stirling Engine Performance Characteristics	2-25
2-21	Air-cooled and Liquid-cooled Rotary Combustion Engines	2-27
2-22	Exhaust Temperature Heat Rejection Relationship for NSIJ Model KKM 250-7 and KKM 2 X 500 cm ³ Engines	2-28
2-23	Schematic Diagram of Housing Cooling System for Curtiss-Wright Wankel Engine RC2-60-U5 ...	2-29
2-24	Curtiss-Wright Model RC2-60-U5 Engine Oil Heat Rejection	2-30
2-25	Curtiss-Wright Model RC2-60-U5 Engine Coolant Heat Rejection, Water Coolant	2-31
2-26	Curtiss-Wright Model RC2-60-U5 Engine Coolant Heat Rejection, Water-Ethylene Glycol Coolant ...	2-32
2-27	Engine Transmission Matching	2-35
2-28	Merritt-Brown Cross Drive Transmission	2-41

LIST OF ILLUSTRATIONS (Con't.)

<i>Fig. No.</i>	<i>Title</i>	<i>Page</i>
2-29	Transmission, XT-500	2-42
2-30	Hydromechanical and Hydrostatic Transmissions. . .	2-43
2-31	Typical Efficiencies of Tracked Vehicle Power Trains Designed for Equal Torque and Speed for Two Range Hydromechanical and Single Range Hydrostatic Type Transmissions	2-44
2-32	Hydrokinetic Torque Converter Transmission	2-45
2-33	Computed Vehicle Tractive Effort vs Speed Curve for a 17,000 lb Gross Vehicle Weight With a Hydrokinetic TX-200 Transmission	2-46
2-34	Predicted Performance With Hydrokinetic Torque Converter Transmission	2-47
2-35	Predicted Vehicle Efficiency Characteristics, Hydrokinetic Transmission and 200 bhp Diesel Engine	2-48
2-36	HMT-250 Transmission Schematic Diagram	2-49
2-37	Predicted Vehicle Power Train Characteristics, HMT-250 Transmission	2-50
2-38	Calculated Vehicle Performance With the HMPT-500 Hydrostatic Transmission	2-51
2-39	Electric Drive System for M113 Vehicle	2-52
2-40	Electric Vehicle Cooling Installation	2-52
2-41	Electric Vehicle Performance and System Efficiency	2-53
2-42	AVCR-1100-3 Tank Engine Fuel System Schematic Diagram	2-54
2-43	MBT70 Prototype Tank Environmental Control Unit	2-56
2-44	MBT70 Prototype Tank Auxiliary Power Unit Winterization Kit	2-56
2-45	Typical Engine Compartment Ventilation Heat Loads	2-58
2-46	MBT70 Prototype Tank Cooling System Baffles ...	2-58
2-47	MBT70 Prototype Tank Exhaust Shields and Insulation	2-59
3-1	Fin Efficiency of Straight and Circular Fins	3-8
3-2	Parallel and Counterflow Heat Exchanger Flow Arrangements and Temperature Variations	3-10
3-3	Crossflow Heat Exchanger Fluid Flow Arrangement and Temperature Distributions	3-11
3-4	Cross-parallel Flow and Cross-counterflow Heat Exchanger Flow Arrangement	3-12
3-5	Required Relative Heat Transfer Area as a Function of the Ratio of the Temperature	3-13
	Change in the Fluid Stream	

LIST OF ILLUSTRATIONS (Con't.)

<i>Fig. No.</i>	<i>Title</i>	<i>Page</i>
3-6	Heat Exchanger Core Construction With Plate-fin Shapes	3-14
3-7	Heat Exchanger Core Construction Variation	3-15
3-8	Heat Exchanger Core With Interrupted Fin Surfaces	3-16
3-9	Nomograph of Thermal Resistance Eq. 3-14	3-21
3-10	Radiator Heat Transfer and Flow Characteristics	3-22
3-11	Typical Heat Rejection vs Coolant Flow for Plate-fin and Serpentine-fin Cores	3-24
3-12	Radiator Heat Transfer Correction Factor for Various Tube Lengths	3-25
3-13	Downflow and Crossflow Radiators	3-26
3-14	Typical Radiator Core (Flattened Tubes)	3-27
3-15	Plate-fin and Serpentine-fin Core Construction	3-28
3-16	Two-pass Radiator (Coolant Side-Back to Front) ..	3-29
3-17	Two-pass Radiator (Coolant Side-Top to Bottom) ..	3-29
3-18	Radiator Core-cooling vs Weight	3-32
3-19	Radiator Deaeration System With Partial Baffle ...	3-33
3-20	Radiator Deaeration System With Full Baffle	3-33
3-21	Radiator Core Performance Characteristics, 11 Fins/in.	3-41
3-22	Radiator Core Performance Characteristics, 14 Fins/in.	3-42
3-23	Oil-to-Air Cooler for AVDS-1790 Air-cooled M60 Tank Engine	3-43
3-24	Typical Oil-to-Water Plate Type Core Assembly and Performance Curves	3-44
3-25	Tube-bundle and Radiator Tank Type Oil Coolers	3-45
3-26	Transmission, Torque Converter, or Brake Cooler Location, Integral	3-46
3-27	Transmission, Torque Converter, or Brake Cooler Location, Remote	3-47
3-28	Air-cooled Transmission Oil Cooler for AVDS-1790-2 M60 Tank Engine	3-48
3-29	Approximate Relative Heat Transfer Capacity vs Temperature for Oil Coolers	3-50
3-30	Oil-cooler Design Variables With 6.0-in. Tube Height	3-51
3-31	Oil-cooler Design Variables With 4.0-in. Tube Width	3-52
3-32	Oil-cooler Design Variables With 7.75-in. Tube Height	3-53
3-33	AVCR-1100 Air-cooled Tank for the M60 Tank ...	3-56

LIST OF ILLUSTRATIONS (Con't.)

<i>Fig. No.</i>	<i>Title</i>	<i>Page</i>
3-34	MB873-Ka-500 Liquid-cooled Power Package as Installed in the MBT Leopard II Tank	3-57
3-35	Aftercooler Performance Curves	3-58
3-36	LARC-XV-49 Self-propelled Amphibious Lighter, Showing Relative Location of Radiators and Keel Coolers	3-60
3-37	LARC-XV-49 Self-propelled Amphibious Lighter, Showing Close-up of Keel Cooler	3-61
3-38	LARC-XV-49 Self-propelled Amphibious Lighter, Cooling System Schematic Drawing	3-62
3-39	Keel Cooler Example Temperature Distribution Through the Tube Wall	3-67
3-40	Thermal Conductivity of Fiberfrax Ceramic Fiber Insulating Material	3-70
3-41	Conductivity of Metals	3-71
3-42	Properties of Air	3-72
3-43	Properties of Water	3-73
3-44	Properties of Hydraulic Fluid	3-73
3-45	Properties of Aircraft Engine Oil	3-74
3-46	Thermo Physical Properties of Ethylene Glycol- water Solutions (Percent by Weight)	3-75
3-47	Properties of Air at Standard Conditions	3-77
4-1	Characteristics of Centrifugal and Axial Flow Fans	4-5
4-2	Automotive Propeller Type Fan	4-7
4-3	Types of Axial Flow Fans	4-8
4-4	Approximate Specific Speed Ranges of Various Types of Air Moving Devices	4-10
4-5	Fan Specific Speed vs Static Efficiency	4-11
4-6	Operating Characteristics of a Fan and Cooling System	4-22
4-7	Change in Operating Characteristics of a Fan and Cooling System	4-23
4-8	Performance of Fans in Parallel	4-24
4-9	Vane-axial Fans in Series	4-25
4-10	Fan Performance/System Resistance Matching	4-27
4-11	Cooling Fan Selection Curves	4-30
4-12	Fan Overspecification Curve	4-31
4-13	Dual Cooling Fan Installation	4-32
4-14	Fan Shroud Types and Relative Fan Blade Positions	4-33
4-15	Optional Cooling Fan Locations	4-34
4-16	Hydraulic Fan Drive Performance Characteristics	4-35
4-17	Viscous Fan Drive	4-42
4-18	Viscous Fan Drive Performance Characteristics	4-43

LIST OF ILLUSTRATIONS (Con't.)

<i>Fig. No.</i>	<i>Title</i>	<i>Page</i>
4-19	Exhaust Ejector	4-44
4-20	Exhaust Gas Ejector Performance	4-45
5-1	Effect of Increased Cooling System Pressure on Boiling Points of Water and Antifreeze Compound Solutions	5-2
5-2	Effect of Altitude on Boiling Points of Water and Antifreeze Compound Solutions	5-3
5-3	Thermal Actuated Radiator Shutters	5-4
5-4	Hydraulic or Thermally Controlled Shutter Systems	5-5
5-5	Temperature Settings for Radiator Shutters.....	5-6
5-6	Manual Shutter Control	5-7
5-7	AOS-895-3 Air-cooled Engine Winterization Shutter Assembly	5-8
5-8	Air-cooled Engine Warm-up Rate With Thermo- statically Controlled Fan Shutters	5-9
5-9	APU/Heater Installation in the XM803 Experimental Tank	5-10
5-10	MBT70 Prototype Tank Engine/Transmission Power Package Cranking Load at Low Ambient Temperature With the Daimler-Benz Engine	5-11
5-11	Oil Cooler With Thermostatic Bypass Valve.....	5-12
5-12	AVDS-1790 Engine Oil Cooler Thermostatic Bypass Valve	5-12
5-13	Plain (Solid) Radiator Cap	5-13
5-14	Pressure System Using Both Plain (Solid) and Pressure Caps	5-13
5-15	Radiator Pressure Caps.....	5-15
5-16	Radiator Cap Operation	5-16
5-17	Percent Increase in Volume for Water and Antifreeze Solution	5-17
5-18	M107 Surge Tank Installation Schematic Diagram ..	5-19
5-19	Typical Nonpressurized Surge Tank Installation Schematic Diagram	5-19
5-20	Thermostat Installation and Operation Schematic Diagram	5-20
5-21	External Type Thermostat Bypass Arrangement (M113A1)	5-21
5-22	Pellet Type Thermostat With Sleeve Valve (Top Bypass)	5-22
5-23	Bottom Bypass Type Thermostat Control Mode ...	5-23
5-24	Top Bypass Type Thermostat Control Mode	5-23
5-25	Thermostat With Jiggle Pin	5-24
5-26	Pellet Type Thermal Actuating Element	5-24

LIST OF ILLUSTRATIONS (Con't.)

<i>Fig. No.</i>	<i>Title</i>	<i>Page</i>
5-27	Operating Characteristics of Pellet Type Thermo- static Element	5-25
5-28	Typical Thermostatic Valve Flow Schematic Diagram	5-26
5-29	Representative Flow Rate and Pressure Drop Characteristics of Choke Type and Bypass Type Thermostats	5-27
5-30	Thermostat Coolant Flow Systems	5-28
5-31	Military Standard Temperature Transmitter.	5-29
5-32	M48 Tank Thermostatic Switch and Instrument Panel With Warning Lights	5-30
5-33	Radiator Coolant Level Sensor Installation	5-31
5-34	Maintenance Indicator Panel	5-31
5-35	Coolant Level and Aeration Warning System Installation.	5-32
6-1	Brush Guard and Expanded Metal Screen Grille . . .	6-4
6-2	Nonballistic Screen (Large Mesh) Attached to Ballistic Grille	6-4
6-3	Nonballistic Grille and Screen for Construction Equipment	6-5
6-4	Radiator Rock Deflector	6-6
6-5	Nonballistic Grille Screen Installation	6-7
6-6	Venturi Type Louver Bar Grille Assembly	6-8
6-7	Bar Type Louver Bar Grille Assembly	6-9
6-8	Airflow Resistance Characteristics of Venturi and Bar Type Grilles	6-10
6-9	Airflow Resistance Characteristics of No. 4 Fish-hook Type Grilles	6-11
6-10	Table-top Grille Cross Section	6-12
6-11	Chevron Type Grille Design Characteristics, MBT70 Prototype Tank	6-12
6-12	Grille Pressure Drop Comparison, M60 and MBT70 Prototype Tanks	6-13
6-13	Grille Assembly Ready for Test on Flow Chamber. .	6-15
6-14	Grille Assembly Test Equipment	6-16
6-15	Grille Airflow Test Set-up and Instrumentation Diagram	6-17
6-16	Inlet and Exhaust Grille Locations	6-17
7-1	Airflow Separation Caused by a Tube in the Cooling System Airflow	7-5
7-2	Friction Factor vs Reynolds Number	7-7
7-3	Relative Roughness of Circular Ducts	7-8
7-4	Friction of Air in Straight Ducts for Volumes of 10 to 100,000 cfm	7-9
7-5	Equivalent Diameter of Rectangular Ducts	7-10

LIST OF ILLUSTRATIONS (Con't.)

<i>Fig. No.</i>	<i>Title</i>	<i>Page</i>
7-6	Loss Coefficients for 90-deg Constant Area Bends With Following Ducts	7-12
7-7	Duct Loss Coefficient Correction Factor for 90-deg Bends Without Exit Duct	7-13
7-8	Loss Correction Factors for Bend Angles Other than 90-deg	7-14
7-9	Correction Factors for Transitional Elbows	7-15
7-10	Fluid Pressure Loss vs Radius Ratio for Circular Ducts	7-16
7-11	Loss Coefficients for Screens and Grids	7-18
7-12	Effect of Angle on Heat Exchangers	7-19
7-13	Typical Turning Vanes in a 90-deg Bend	7-21
7-14	XM803 Experimental Tank Cooling System Analysis Diagram	7-22
7-15	XM803 Experimental Tank Inlet and Exhaust Grille Configuration	7-24
7-16	XM803 Experimental Tank Power Package Airflow Diagram	7-25
7-17	XM803 Experimental Tank Engine Cooling System Duct Area Profile	7-26
7-18	XM803 Experimental Tank Cooling System Diagram and Static Pressure Profile	7-31
7-19	Typical Centrifugal Coolant Pump	7-32
7-20	Engine Coolant Flow Through Radiator or Heat Exchanger With 180°F Blocking Type Thermostat	7-33
7-21	Typical Coolant Pump Capacity vs Engine Speed for Models 8V-71 and 71N	7-34
7-22	Coolant Pump Performance With Variations in Inlet Pressure	7-35
7-23	Engine Oil Flow Rates vs Speed	7-36
7-24	Gear Type Pump Performance Characteristics	7-37
7-25	Viscosity-Temperature Variation of Lubricants	7-37
7-26	Chart for Pipe-size Approximation	7-38
7-27	Pipe Friction Losses	7-39
8-1	Cummins Model VT-903 Engine Data Sheet	8-6
8-2	Cooling System Diagram for a Liquid-cooled System	8-8
8-3	Vehicle Cooling System Component Expansion for System Analysis	8-8
8-4	Power Package Composite Heat Rejection	8-11
8-5	Cooling Air Static Pressure Profile	8-13
8-6	Trade-off Study Work Sheet	8-16

LIST OF ILLUSTRATIONS (Con't.)

<i>Fig. No.</i>	<i>Title</i>	<i>Page</i>
8-7	Effects of Transmission Gear Ratio Selection and Required Tractive Effort on Transmission Cooling Fan Horsepower Requirements	8-22
8-8	Axial Flow Fan Performance for the M114 Product Improvement Program Vehicle	8-24
8-9	Cooling System for the M114 Product Improve- ment Program Vehicle	8-25
8-10	Power Package for M114 Product Improvement Program Vehicle	8-26
8-11	Tractive Effort/Vehicle Speed Prediction for the M114 Product Improvement Program Vehicle . . .	8-28
8-12	Horsepower/Transmission Output Speed Prediction for the M114 Product Improvement Program Vehicle	8-29
8-13	Radiator Core Performance Characteristics	8-31
8-14	Guide Vane Assembly for M114 Product Improvement Program Vehicle	8-32
8-15	Oil-cooler Heat Transfer Characteristics and Correction Factors for Various Tube Lengths	8-34
8-16	Transmission Oil Cooler Performance Characteristics	8-36
8-17	M114 Product Improvement Program Vehicle Full Load Cooling Test Results - Transmission Speed vs Temperature	8-37
8-18	M114 Product Improvement Program Vehicle Full Load Cooling Test Results - Transmission Speed vs Horsepower and Specific Fuel Consumption	8-38
8-19	M114 Product Improvement Program Vehicle Full Load Cooling Test Results - Transmission Speed vs Heat Rejection Rate	8-39
8-20	M114 Product Improvement Program Vehicle Full Load Cooling Test Results - Transmission Speed vs Coolant Flow	8-40
8-21	AVCR-1100-3B Cylinder Cooling Airflow	8-44
8-22	AVCR-1100-3B Cylinder Head Temperature and Cooling Air Temperature Rise v Fuel Flow at 2600 rpm	8-47
8-23	AVCR-1100-3B Cylinder Head Temperatures and Heat Rejection at 2600 rpm Full Load	8-49
8-24	Engine Oil Heat Rejection Rate Characteristics . . .	8-51
8-25	AVCR-1100-3B Engine Oil Heat Rejection vs Fuel Flow	8-52
8-26	AVCR-1100-3B Engine Oil Heat Rejection vs Oil Temperature	8-53

LIST OF ILLUSTRATIONS (Con't.)

<i>Fig. No.</i>	<i>Title</i>	<i>Page</i>
8-27	Engine Oil Cooler Characteristics	8-54
8-28	AVCR-1100-3B Engine Full Load Cooling Characteristics	8-55
8-29	AVCR-1100-3B Induction Air Heat Rejection and Intake Manifold Temperature	8-56
8-30	Schematic Diagram of AVCR-1100-3B Induction System	8-57
8-31	AVCR-1100-3B Engine Induction Airflow Characteristics	8-58
8-32	Aftercooler Characteristics	8-59
8-33	AVCR-1100-3B Cooling Airflow Characteristics from Hot Mock-up Tests	8-62
8-34	AVCR-1100-3B Cooling Fan Performance Measured for One Fan During Hot Mock-up Test	8-63
8-35	XM803 Experimental Tank Cooling System Performance Diagram	8-65
8-36	Typical Radiator Core Performance Characteristics .	8-67
8-37	Parametric Cooling Study vs Cooler Frontal Face Area	8-70
8-38	Parametric Cooling Study vs Cooling Airflow	8-71
8-39	Parametric Cooling Study vs Coolant Temperature . .	8-72
8-40	Parametric Cooling Study vs water Temperatures and Engine Power	8-74
8-41	Cooling System Performance vs Gross Engine Power	8-75
8-42	Engine Net Performance vs Gross BHP and Coolant Temperature	8-76
8-43	Engine and Cooling System Performance vs Ambient Temperature	8-77
8-44	Effect of Ambient Temperature on Required Fan Power	8-78
9-1	Test Laboratory Cooling Component Test Equipment Set-up	9-2
9-2	LDS-465-1A Diesel Engine Coolant Pump Performance With Varying Inlet Pressure	9-4
9-3	MBT70 Prototype Tank Cold Mock-up for the AVCR-1100 Engine With Turret Bustle in Gun Forward Position	9-6
9-4	XM571 Vehicle Hot Mock-up With Simulated Solar Radiation	9-7
9-5	Hot Mock-up of the MBT70 Prototype Tank Power Package and Cooling System	9-8
9-6	USATACOM Propulsion Division Vehicular Test Cell	9-11

LIST OF ILLUSTRATIONS (Con't.)

<i>Fig. No.</i>	<i>Title</i>	<i>Page</i>
9-7	M113A1 Vehicle Cooling Test Installation	9-12
9-8	M110 Vehicle Cooling Test Installation	9-12
9-9	M551 Vehicle Cooling Test Installation	9-13
9-10	M561 Vehicle Cooling Test Installation	9-13
9-11	Temperature Characteristics of Power System in M113A1 Vehicle	9-16
9-12	M110 Baseline Stabilization Cooling Results	9-18
9-13	M551 Vehicle Sprocket Horsepower vs Vehicle Speed Curve Showing 4th Gear Critical Operating Conditions	9-21
9-14	M551 Vehicle Cooling Airflow Path	9-23
9-15	M551 Vehicle Power Package With Oil-to-Air Transmission Oil Cooler Installed	9-23
9-16	Mobile Field Dynamometer With M88 Recovery Vehicle Under Test	9-28
A-1	11 Fins/in., Core Depth 1.5 in., Oil Cooler Performance, I	A-2
A-2	12.5 Fins/in., Core Depth 1.5 in., Oil Cooler Performance, I	A-3
A-3	14 Fins/in., Core Depth 1.5 in., Oil Cooler Performance, I	A-4
A-4	18 Fins/in., Core Depth 1.5 in., Oil Cooler Performance, I	A-5
A-5	11 Fins/in., Core Depth 3 in., Oil Cooler Performance, I	A-6
A-6	12.5 Fins/in., Core Depth 3 in., Oil Cooler Performance, I	A-7
A-7	14 Fins/in., Core Depth 3 in., Oil Cooler Performance, I	A-8
A-8	18 Fins/in., Core Depth 3 in., Oil Cooler Performance, I	A-9
A-9	11 Fins/in., Core Depth 4.5 in., Oil Cooler Performance, I	A-10
A-10	12.5 Fins/in., Core Depth 4.5 in., Oil Cooler Performance, I	A-11
A-11	14 Fins/in., Core Depth 4.5 in., Oil Cooler Performance, I	A-12
A-12	18 Fins/in., Core Depth 4.5 in., Oil Cooler Performance, I	A-13
A-13	11 Fins/in., Core Depth 6 in., Oil Cooler Performance, I	A-14
A-14	12.5 Fins/in., Core Depth 6 in., Oil Cooler Performance, I	A-15
A-15	14 Fins/in., Core Depth 6 in., Oil Cooler Performance, I	A-16

LIST OF ILLUSTRATIONS (Con't.)

<i>Fig. No.</i>	<i>Title</i>	<i>Page</i>
A-16	18 Fins/in., Core Depth 6 in., Oil Cooler Performance, I	A-17
A-17	11 Fins/in., Core Depth 1.5 in., Oil Cooler Performance, II	A-18
A-18	12.5 Fins/in., Core Depth 1.5 in., Oil Cooler Performance, II	A-19
A-19	14 Fins/in., Core Depth 1.5 in., Oil Cooler Performance, II	A-20
A-20	18 Fins/in., Core Depth 1.5 in., Oil Cooler Performance, II	A-21
A-21	11 Fins/in., Core Depth 3 in., Oil Cooler Performance, II	A-22
A-22	12.5 Fins/in., Core Depth 3 in., Oil Cooler Performance, II	A-23
A-23	14 Fins/in., Core Depth 3 in., Oil Cooler Performance, II	A-24
A-24	18 Fins/in., Core Depth 3 in., Oil Cooler Performance, II	A-25
A-25	11 Fins/in., Core Depth 4.5 in., Oil Cooler Performance, II	A-26
A-26	12.5 Fins/in., Core Depth 4.5 in., Oil Cooler Performance, II	A-27
A-27	14 Fins/in., Core Depth 4.5 in., Oil Cooler Performance, II	A-28
A-28	18 Fins/in., Core Depth 4.5 in., Oil Cooler Performance, II	A-29
A-29	11 Fins/in., Core Depth 6 in., Oil Cooler Performance, II	A-30
A-30	12.5 Fins/in., Core Depth 6 in., Oil Cooler Performance, II	A-31
A-31	14 Fins/in., Core Depth 6 in., Oil Cooler Performance, II	A-32
A-32	18 Fins/in., Core Depth 6 in., Oil Cooler Performance, II	A-33
A-33	Typical Radiator Core Tube Arrangements	A-34
A-34	Type 1 Radiator Core Performance	A-35
A-35	Type 4 Radiator Core Performance	A-36
A-36	Type 5 Radiator Core Performance	A-37
A-37	Type 6 Radiator Core Performance	A-38
A-38	Variation in Heat Transfer Capacity Due to Water Flow	A-39
A-39	11 Fins/in. Radiator Core Performance Characteristics	A-40
A-40	10 Fins/in. Radiator Core Performance Characteristics	A-41

AMCP 706-361

LIST OF ILLUSTRATIONS (Con't.)

<i>Fig. No.</i>	<i>Title</i>	<i>Page</i>
A-41	8 Fins/in. Radiator Core Performance Characteristics	A-42
B-1	Gear Box Drive Fan Drawing, 4000 cfm	B-2
B-2	Gear Box Drive Fan Performance Curve, 4000 cfm ..	B-3
B-3	Vane-axial Fan Drawing, 9200 cfm	B-4
B-4	Vane-axial Fan Performance Curve, 9200 cfm	B-5
B-5	Vane-axial Fan Drawing, 200 cfm, Electric Drive	B-6
B-6	Vane-axial Fan Performance Curve, 200 cfm, Electric Drive	B-7
B-7	Vane-axial Fan Drawing, 9000 cfm	B-8
B-8	Vane-axial Fan Performance Curve, 9000 cfm	B-9
B-9	Vane-axial Fan Drawing, 14,000 cfm	B-10
B-10	Vane-axial Fan Performance Curve, 14,000 cfm ...	B-11
B-11	Vane-axial Fan Drawing, 900 cfm, Electric Drive...	B-12
B-12	Vane-axial Fan Performance Curve, 900 cfm, Electric Drive	B-13
B-13	Vane-axial Fan Drawing, 325 cfm, Electric Drive...	B-14
B-14	Vane-axial Fan Performance Curve, 325 cfm, Electric Drive	B-15
B-15	Vane-axial Fan Drawing, 425 cfm, Electric Drive...	B-16
B-16	Vane-axial Fan Performance Curve, 425 cfm, Electric Drive	B-17
B-17	Vane-axial Fan Drawing, 19,000 cfm	B-18
B-18	Vane-axial Fan Performance Curve, 19,000 cfm ...	B-19
B-19	Fan, Truck, Cargo, M44	B-20
B-20	Basic Fan Types	B-21
B-21	Fan Sound Level Comparison	B-22
B-22	Fan Power Requirement Comparison	B-22
B-23	Fan Stability Comparisons	B-22
B-24	12 in. Diameter Mixed Flow Fan Used in the Scorpion Tank	B-24
B-25	Partition Mounted Open Running Mixed Flow Fan	B-25
B-26	Mixed Flow Fan Diffuser With Ballistic Louvers ...	B-25
B-27	Mixed Flow Fan With Volute Casing	B-26
B-28	Cooling System Optimization Charts	B-28
B-29	M47 Tank Power Package Cooled With Two Mixed Flow Fans	B-29
B-30	Mixed Flow Fan Performance, Model 305 MP3 311	B-30
B-31	Mixed Flow Fan Performance, Model 380 MP3 311	B-31
B-32	Mixed Flow Fan Performance, Model 475 MP3 311	B-32

LIST OF ILLUSTRATIONS (Con't.)

<i>Fig. No.</i>	<i>Title</i>	<i>Page</i>
B-33	Mixed Flow Fan Performance, Model 680 MP3 311	B-33
B-34	Cooling Fan Performance Curve No. F1-0000-00-52	B-35
B-35	Cooling Fan Performance Curve No. F1-0000-00-54	B-36
B-36	Cooling Fan Performance Curve No. F1-0000-00-58	B-37
B-37	Cooling Fan Performance Curve No. F1-0000-00-73	B-38
B-38	Cooling Fan Performance Curve No. F1-0000-00-61	B-39
B-39	Cooling Fan Performance Curve No. F1-0000-00-64	B-40
B-40	Cooling Fan Performance Curve No. F1-0000-00-67	B-41
B-41	Cooling Fan Performance Curve No. F1-0000-00-68	B-42
B-42	Cooling Fan Performance Curve No. F1-0000-00-84	B-43
B-43	Cooling Fan Performance Curve No. F1-0000-00-85	B-44
B-44	Cooling Fan Performance Curve No. F1-0000-00-69	B-45
B-45	Cooling Fan Performance Curve No. F1-0000-00-70	B-46
B-46	Cooling Fan Performance Curve No. F1-0000-00-71	B-47
C-1	Airflow Characteristics of No. 4 Louver Bar Grille, Full Size, Designed in WW II and Used on the M26 Tank	C-2
C-2	Airflow Characteristics of No. 4 Louver Bar Grille, 3/4 Size, Used on the M103 Vehicle	C-3
C-3	Airflow Characteristics of No. 4 Louver Bar Grille, 2/3 Size, Used on M48 and M60 Tanks	C-4
C-4	Airflow Characteristics of No. 4 Louver Bar Grille, 1/2 Size, Used on the M41 Vehicle	C-5
C-5	Airflow Characteristics of Chevron Type Grille (MBT70 Prototype Tank)	C-6
C-6	Airflow Characteristics of M114 Grille Assembly	C-7
C-7	Airflow Characteristics of M113 Grille Assembly	C-8
D-1	Heat Exchanger Test Schematic Diagram	D-2
D-2	Typical Pressure Cycle for Oil Cooler Test	D-7
D-3	Tolerances for Locations of Pitot Tubes	D-9

AMCP 706-361

LIST OF ILLUSTRATIONS (Con't.)

<i>Fig. No.</i>	<i>Title</i>	<i>Page</i>
D-4	Multiple Airflow Nozzles for Airflow Test Measurement	D-10
D-5	Cooling Fan Performance Test Schematic Diagram	D-11
D-6	Typical AMD Performance Curve	D-14
D-7	AMCA Standard Nozzle and Flow Straightener ...	D-19
D-8	XM803 Experimental Tank Hot Mock-up Schematic Diagram of Instrumentation Positions..	D-20
D-9	XM803 Experimental Tank Hot Mock-up Schematic Diagram of Cell Exhaust System	D-21
D-10	M275A2 Vehicle Cooling System Performance- Coolant Removal Test at 2600 rpm Full Load and 110°F Ambient Temperature	D-23

LIST OF TABLES

<i>Table No.</i>		<i>Page</i>
1-1	Summary of Cooling Performance on Military Vehicles Maximum Temperatures Recorded During Full-load Cooling Tests	1-5
1-2	Summary of Temperature, Solar Radiation and Relative Humidity Daily Extremes	1-10
1-3	Shock and Vibration Data	1-40
1-4	Summary of Mobility Operation of the Carrier. Command and Reconnaissance, Armored, M114A1, Vehicle at Yuma Proving Ground, Yuma, Arizona	1-41
1-5	Temperature vs Altitude	1-46
1-6	Mileage Cycle for Tracked Vehicles	1-52
1-7	Mileage Cycle for Wheeled Vehicles	1-53
1-8	Lubricating Oils, Hydraulic Fluids, and Greases Used in Military Automotive Equipment	1-57
2-1	Characteristics of Thermodynamic Cycles	2-5
2-2	Cooling System Summary of Military Vehicle Installations	2-18
2-3	Stirling Engine Heat Balance, GPU-3, 15 Horsepower	2-26
2-4	A Glossary of Power Train Terms	2-33
2-5	Vehicle Performance Equations	2-36
2-6	Summary of Vehicle Driveline System Efficiencies During Full-throttle Operation	2-37
2-7	Power Train Combinations	2-38
2-8	Typical Engine Compartment Temperatures	2-57
3-1	Radiator Size vs Vehicle Application	3-35
3-2	Radiator Use vs Vehicles and Engines	3-36
3-3	Cooling Temperature Limits for Various Vehicles	3-37
3-4	Radiator vs Pressure Cap Use	3-38
3-5	Oil-cooler Design Parameters at Near Minimum Core Volume	3-54
3-6	Properties of Aqueous Ethylene Glycol (50/50% By Volume)	3-76
4-1	Military Vehicle Cooling Fans	4-11
4-2	Detroit Diesel Engine Cooling Fans	4-12
4-3	Fan Laws	4-16
4-4	Air Density at Various Temperatures at Sea Level and Barometric Pressures at Various Elevations (Dry Air)	4-28
4-5	Belt Driven Fan Characteristics	4-38
4-6	Electrically Driven Cooling Fan Characteristics	4-39
4-7	Hydraulic Cooling Fan Drive Characteristics	4-41
6-1	Ballistic Grilles Used in Contemporary Military Vehicles	6-14
7-1	Loss Coefficient for Area Changes	7-17
7-2	Resistance of Standard Pipe Fittings to Flow of Liquids	7-40

LIST OF TABLES (Con't.)

<i>Paragraph</i>		<i>Page</i>
8-1	Transmission Cooling Requirement Predicted for Vehicle Designed for 44 mph Top Speed	8-21
8-2	Transmission Cooling Requirement Predicted for Vehicle Designed for 36 mph Top Speed	8-21
8-3	Design of Experimental Power Plant Installation and Cooling System for the M114 Vehicle	8-41
8-4	Cylinder Head Temperature Survey Summary of Cooling Data for AVCR-1100-3	8-45
8-5	AVCR-1100-3B Cylinder Cooling Characteristics ..	8-48
8-6	AVCR-1100-3B Aftercooler Cooling Characteristics	8-61
8-7	Summary of Cooling System Operation of AVCR-1100-3B in XM803 Experimental Tank	8-64
8-8	Cooling System Parametric Study	8-68
9-1	Effect of Vehicle Modification on Coolant and Transmission Oil Temperature of M113A1	9-17
9-2	Effects of Vehicle Modification on Coolant and Engine Oil Sump Temperatures of the M110	9-19
9-3	Effect of Vehicle Modification on Coolant and Transmission Oil Temperature of the M551	9-22
9-4	Effects of Vehicle Modifications on Engine Coolant and Oil Sump Temperatures of the M561	9-25
9-5	US Army Test and Evaluation Command Test Types	9-29
9-6	Army Regulations (AR) Applicable to Life Cycle Testing of Materiel	9-33
D-1	Table Displacements	D-4
D-2	Density of Saturated and Partially Saturated Air for Various Barometric Conditions	D-13
D-3	Surge Tank Hot Shutdown Capability	D-25

PREFACE

The Engineering Design Handbook Series of the US Army Materiel Command is a coordinated series of handbooks containing basic information and fundamental data useful in the design and development of Army materiel and systems. The handbooks are authoritative reference books of practical information and quantitative facts presented to be helpful in the design and development of materiel that will meet the technical needs of the Armed Forces.

The *Military Vehicle Power Plant Cooling Handbook* is intended to serve as a basic reference for the vehicle cooling system designer. The material presented was compiled from reports, publications, interviews, and data provided by various agencies.

A brief introduction has been included before each chapter to describe the basic material that is presented. In most instances, the reader will select only the information of immediate interest and not try to read the complete handbook. It is the intent that these introductions will assist the reader in locating the desired data.

Titles and identifying numbers of specifications, regulations, and other official publications are given for the purpose of informing the user of the existence of these documents, however, care should be taken to ensure that the current edition is obtained.

This handbook will be of particular value to the users and program managers in their role in the development of new vehicles. It will serve as a guide to (a) the generation of realistic vehicle specifications, (b) total system integration in cooling system design, and (c) a complete cooling system development and corrective action program in the vehicle development cycle. There are numerous incidents in the histories of military vehicle development where inadequate cooling capabilities have contributed to the inability of a vehicle to perform its mission in the extremes of the military environments. These failures stem from (a) inadequate specifications and requirements from which the designer must establish his detailed requirements, (b) incomplete analysis of the total vehicle system impacts on the cooling system performance, (c) incomplete development cycle provisions in the overall development project planning which cuts short the proper evaluation of the cooling system performance and corrective action prior to issue of production vehicles to the user. This chain of events too frequently results in cooling system induced failures and/or limited mission capability along with expensive retrofit modification programs. Proper cooling system designs will further aid in the conservation of energy by efficiently utilizing the power necessary to provide for effective vehicle cooling. The proper use of this handbook by the user, program managers, and designers will aid in assuring that inadequately cooled vehicles do not find their way into the hands of the fighting troops.

AMCP 708-361

DEFINITIONS FOR MASS, WEIGHT, and FORCE¹. Terms used concerning mass, weight, and force are often confused and therefore require clarification. The mass of a body is constant, whereas the weight varies from place to place proportionately to the force of gravity.

The concept of mass involves the quantity or amount of material under consideration. In the various English systems the unit for mass is the pound mass, designated lbm, which was originally specified as the mass of a certain platinum cylinder in the Tower of London.

In the English Engineering system of units the concept of force is established as an independent quantity and the unit for force is defined in terms of an experimental procedure as follows. Let the standard pound mass be suspended in the earth's gravitational field at a location where the acceleration due to gravity is 32.1740 ft/sec.² The force with which the standard pound mass is attracted to the earth (the buoyant effects of the atmosphere on the standard pound mass must also be standardized) is defined as the unit for force and is termed a pound force (lbf). Note that we now have arbitrary and independent definitions for force, mass, length, and time. Since these are related by Newton's second law we can write

$$F = \frac{ma}{g_c}, \text{ lbf}$$

where

m = mass in lbm

a = rate of acceleration, ft/sec²

Note that g_c is a constant that relates the units of force, mass, length, and time.

For the system of units defined above, namely, the English Engineering System, we have

$$1 \text{ lbf} = \frac{1 \text{ lbm} \times 32.174 \text{ ft/sec}^2}{g_c}$$

therefore

$$g_c = 32.174 \frac{\text{lbm-ft}}{\text{lbf-sec}^2}$$

Note that g_c has both a numerical value and dimensions in this system and is referred to as the gravitational conversion constant. Since it would not be evident whether pound mass or pound force is being referred to, it should be emphasized that the term "pound" and the symbol "lb" should never be used by itself.

¹ Based on definitions from *Fundamentals of Classical Thermodynamics*, by G.J. Von Wylene and R.E. Sonntag, used by permission of John Wiley and Sons, New York, N.Y.

Engineers have commonly used the pound (lb) both as a unit of mass and as a unit of force. When they speak of the volume of ten pounds of water, they mean ten pounds mass (lbm). A pressure of ten pounds per square inch refers to a force of ten pounds (lbf). Weight is the force of gravity. The ten pounds (mass) of water referred to above would not weigh exactly ten pounds in a given locality unless the acceleration of gravity were 32.174 ft/sec².

Therefore, in this Handbook, the term "lb" will be specifically defined. The term "lbm" will be used when defining a quantity or amount of material, and the term "lbf" or "lb" will be used when referring to a force.

This handbook was prepared by Teledyne Continental Motors, General Products Division, for the Engineering Handbook Office of Research Triangle Institute, prime contractor to the US Army Materiel Command. Technical supervision and guidance in this work were supplied by an ad hoc working group with membership from the major commands of the US Army Materiel Command. The final selection and approval of the data included in this handbook were made by the Chairman of the group, Mr. Edward J. Rambie of the US Army Tank-Automotive Command.

Appreciation is expressed to the following for assistance provided during the preparation of the handbook: Airscrew Howden Ltd.; Aud-NSU Auto Union; Buffalo Forge Co.; Carborundum Company; Cummins Engine Co., Inc.; Curtiss-Wright Corp.; Detroit Diesel, Allison Div., General Motors Corp.; Harrison Radiator Div., General Motors Corp.; Joy Manufacturing Co.; Dr. Jiunn P. Chiou, Consultant; Kysor of Cadillac; Lau Industries, Modine Manufacturing Co.; McCord Corp., Heat Transfer Div.; Motoren-Und Turbinen-Union Friedrichshafen GMBH; Phillips Research Laboratories; Schwitzer Div., Wallace-Murray Corp.; Standard Thompson Corp., Control Products Division; Standard Controls, Inc.; Scoville Mfg. Co.; and Young Radiator Company.

The Engineering Design Handbooks fall into two basic categories, those approved for release and sale, and those classified for security reasons. The US Army Materiel Command policy is to release these Engineering Design Handbooks in accordance with current DOD Directive 7230.7, dated 18 September 1973. All unclassified Handbooks can be obtained from the National Technical Information Service (NTIS). Procedures for acquiring these Handbooks follow:

a. All Department of Army activities having need for the Handbooks must submit their request on an official requisition form (DA Form 17, dated Jan 70) directly to:

Commander
Letterkenny Army Depot
ATTN: AMXLE-ATD
Chambersburg, PA 17201

AMCP 706-361

(Requests for classified documents must be submitted, with appropriate "Need to Know" justification, to Letterkenny Army Depot.) DA activities will not requisition Handbooks for further free distribution.

b. All other requestors, DOD, Navy, Air Force, Marine Corps, nonmilitary Government agencies, contractors, private industry, individuals, universities, and others must purchase these Handbooks from:

National Technical Information Service
Department of Commerce
Springfield, VA 22151

Classified documents may be released on a "Need to Know" basis verified by an official Department of Army representative and processed from Defense Documentation Center (DDC), ATTN: DDC-TSR, Cameron Station, Alexandria, VA 22314.

Comments and suggestions on this Handbook are welcome and should be addressed to:

Commander
US Army Materiel Command
ATTN: AMCRD-TV
Alexandria, VA 22333

(DA Forms 2028, Recommended Changes to Publications, which are available through normal publications supply channels, may be used for comments/suggestions.)

CHAPTER 1

INTRODUCTION TO THE MILITARY COOLING SYSTEM

This chapter describes the unique military environment with emphasis on the effects on vehicle cooling systems. Various military vehicle cooling systems are described and related to the severity of use in the extremes of the military environment. Special kits to adapt the vehicle to special conditions are discussed. Reliability, maintenance, and general cooling system design requirements are presented.

1-1 SCOPE

The overall purpose of this handbook is to define systematic procedures for the design and development of cooling systems for military ground vehicles.

This document applies to all facilities and personnel engaged in the design and development of cooling systems for military ground vehicles.

In too many instances, military vehicle cooling systems have failed to perform satisfactorily under the severe environmental extremes in which they must operate. Thus, one purpose of this handbook is to convey to engineers, who may have a limited knowledge of the military environment, the difficult and rigorous conditions that are considered normal military operating conditions. Two further purposes are:

1. To present records of previous design experience to forestall duplication of past efforts
2. To preserve unique technical knowledge which might otherwise be lost.

A successful cooling system design is not determined by the selection of individual parts and components. Rather it is the result of careful analysis of the operational require-

ments, peculiar system installation problems, and the integration of the cooling system into the complete vehicle. Only when the effects of all related vehicle systems are considered can a successful cooling system design be created.

The military vehicle fleet, which may be the largest vehicle fleet in the world, represents an unusual mix of vehicles developed to an unusual set of design requirements.

Designers of military equipment always will be faced with multiple choices of hardware — choices that range from complete vehicles to small individual components. The designer must choose an innovative military design, off-the-shelf commercial design, or a militarized version of a commercial design. In some areas the choice is clear. There are no commercial equivalents of such heavy armored vehicles as tanks, assault vehicles, and gun-motor carriages. However, these vehicles represent only a small percentage of the total military fleet. By necessity then, these types of vehicles always will require a purely military design and development approach (See Ref. 4).

The majority of the military fleet is composed of wheeled vehicles — primarily trucks, sedans, and utility vehicles. In almost every instance there are commercial counter-

ANCP 706-361

parts of these vehicles, and many commercial vehicles are used by the military. These vehicles may be either the standard commercial configuration, or a militarized version of a commercial configuration.

For many reasons, the current trend in military procurement is to buy commercial off-the-shelf components and end items whenever possible. In many cases this can be done with satisfactory results. The sedans used as command cars and for general use in areas duplicating a civilian environment have been reasonably successful. In other instances, commercial tractor-trailer combinations have been used successfully in convoy operations – when the convoy route was carefully selected.

For most military vehicle applications, the use of commercial components or end items must be diligently weighed, judiciously selected, and carefully applied.

To provide some basis of comparison for selection of military materiel, it is desirable to review the differences among methods of operation, maintenance, and environment in commercial and military vehicle operations. Sufficient times are available for adequate maintenance of commercial truck and industrial vehicles during the vehicle life cycle, and the vehicles are operated within the limits of design durability. Most trucks, except for those specifically designed for off-road use, generally operate in a clean environment. The roads are surfaced, grades have been reduced to reasonable slopes, and with today's network of highways, vehicles can be designed around nearly optimum operating conditions.

The military environment is one that has no commercial counterpart. The area of operations may be anywhere in the world, the vehicles may travel on highways or cross-country, the vehicles may or may not be maintained on schedule, and they may or may not be used for the purpose for which they were designed, particularly during combat situations.

A military vehicle is the hardware result of an extensive and lengthy system development cycle. The need for a vehicle to fulfill a specific role may be specified by using forces or the US Army Training and Doctrine Command (TRADOC), by a development agency such as the US Army Tank-Automotive Command (USATACOM), or by a commercial contractor. Generally, a written description is prepared which will describe the vehicle and its performance requirements, weapon systems, if any, and will describe the role or mission it is to perform. This description usually is circulated among the various Army commands for their comments prior to finalization.

When general approval of the vehicle, vehicle configuration, and mission has been received, a more detailed document is prepared which cites detailed specifics of design, performance, and the intended mission requirements. A development group is selected, a development schedule prepared, and funding is provided – and the system concept is on the way to hardware. Before the vehicle is released for field use, an extensive series of tests is performed to verify the suitability of the vehicle for Army use and to determine compliance with the system specification (See Ref. 5).

One of the purposes of the system development and test cycle is to surface and resolve hardware and logistic problems. Based on the initial design approach, the problems encountered may or may not have been anticipated. The intent in all cases is to resolve all difficulties before the vehicle is fielded. Historically, however, this reduction of theory to practice has not been foolproof since most vehicles have suffered “growing pains” after issue. One of the most significant problems affecting vehicles has been inadequate cooling. This has been so, even when commercial vehicles with no history of cooling problems in commercial operation have been used for military application.

One of the factors contributing to inadequate cooling has been the terrain where the vehicles are required to operate. Military vehicles are generally required to operate in all types of different terrain. Most military vehicles must have the capability of leaving a paved road and driving cross country. In military practice there are no terrain limitations except for those which, by trial, cannot be traversed. These conditions, if not considered in the initial cooling system design, can impose additional power requirements with more severe vehicle cooling requirements.

Military vehicles may operate in an overloaded condition. This overloaded condition may be compounded further by operation of a vehicle in the wrong gear range. The weight of the load often is determined by the size limitations of the vehicle body which may sometimes result in overloading the vehicle particularly under combat conditions.

Maintenance of military vehicles, generally in combat zones, may be inadequate. To fulfill its many missions, the military fleet must be diverse, and in its diversity it becomes extremely complex, which makes an effective maintenance program more difficult.

It is apparent that there are significant differences between the commercial and the military use of vehicles. In most areas these differences will have an impact on cooling requirements.

One of the major problems confronting the military vehicle cooling system designer, particularly in combat vehicles, is the extremely limited space in which to install the power package. As a result, the cooling airflow path seldom can be ideal and it is necessary to use baffles, seals, grilles, and ducts to provide or direct the air for satisfactory cooling.

Ballistic grilles, brush screens, guards, and vehicle-mounted accessories contribute to air

side pressure drops that are not present in commercial vehicles. These requirements are peculiar to the military environment and must be considered in the initial cooling system design.

Severe vehicle vibrations, unpredictable degradation factors such as radiator or heat exchanger fin damage, scaling, plugging, and similar effects directly related to the military operating environment produce cooling system failures. Adequate consideration of these factors in an initial cooling design should result in a vehicle fully capable of satisfactory operation under all environmental conditions experienced during military operations. It must be noted that vehicles used in commercial operation may have serious cooling problems when used directly for military operations without suitable modifications.

The causes of vehicle cooling system failures can be classified as follows:

1. Inadequate vehicle analysis and specifications including:
 - a. Inadequate vehicle and component cooling specifications
 - b. Inadequate sizing of fans, pumps, and heat exchangers
 - c. Improper fan/pump speed and fluid flow rates
 - d. Unsuitable component and fluid operating temperature limits
 - e. Insufficient reserve or safety factor
 - f. Inadequate technical information
2. System difficulties such as:
 - a. Coolant loss due to after boil, aeration, and leakage

AMCP 706-361

b. Deterioration and degradation

c. Defects causing restrictions, aeration, cavitation, etc.

3. Incomplete and/or inadequate testing (which may allow a system to be fielded and thus be a failure when it should have failed during test)

4. Inadequate maintenance and operating procedures

5. Failure of a pressurized system

6. Defective components

7. Inadequate armor protection.

Table 1-1 presents a summary of cooling performance for a number of military vehicles. It is apparent that the performance of the cooling system for some of these vehicles is unsatisfactory. It is the goal of this handbook to assist the designer in providing adequate cooling systems for military vehicles.

1-1.1 CONVENTIONAL COOLING SYSTEMS FOR RECIPROCATING INTERNAL COMBUSTION ENGINES

The internal combustion engine parts exposed to the burning gases absorb heat during the combustion process, and this heat must be dissipated to the atmosphere at the same rate at which it is absorbed. This heat transfer rate establishes thermal equilibrium conditions under given operating conditions.

Both liquid-cooled or air-cooled engines can be used. For liquid-cooled engines an ethylene glycol and water mixture generally is used as a cooling media when high jacket temperatures are desired and for protection against freezing in low temperature operation.

The boiling point of ethylene glycol is 387°F and when mixed with water in the

correct proportions will lower the freezing point of the solution to below -65°F for arctic operations. The range of engine operating temperatures is bounded by the thermostat setting and coolant boiling point. Since a mixture of ethylene glycol and water has a higher boiling point than pure water, the mixture allows a higher operating temperature. Since the specific heat of the mixture is lower than water, a larger volume of coolant will be required for the same heat transfer surface.

Air-cooling eliminates the necessity of water or other water-antifreeze cooling media, coolant jackets, pumps, radiators, and related coolant connections, but necessitates individual cylinder head construction, finning, baffles, and fans or blowers for vehicle installations. Lubricating oil-cooling is usually mandatory. Fins of various lengths and shapes adequately spaced are used as cooling surfaces for air-cooled engines. Either air-cooled or liquid-cooled engines are successful if the vehicle cooling system is designed properly.

Engine temperature depends on the particular engine and operating condition. This temperature must fall within an acceptable range between maximum and minimum cooling conditions. Both overheating and overcooling should be avoided. For liquid-cooled engines the temperature limits are expressed as oil temperature and engine outlet coolant temperatures. The coolant limits are usually 160°F minimum and 212°F (plus approximately 3 deg F per psi of radiator cap setting) maximum. Oil temperature specifications for liquid-cooled engines are the same as those for air-cooled engines. For air-cooled engines the temperature limits are expressed in terms of lubricating oil temperature range and maximum cylinder head temperatures. The temperature limits usually range from 130°F minimum to 250°F maximum desired for steady state operation for lubricating oil temperature, and 500°F for the maximum cylinder head temperature. These temperature limits must be maintained over a wide range

TABLE 1-1
SUMMARY OF COOLING PERFORMANCE ON MILITARY VEHICLES MAXIMUM TEMPERATURES
RECORDED DURING FULL-LOAD COOLING TESTS (YUMA PROVING GROUND)

VEHICLE MODEL	VEHICLE SIZE OR TYPE	ROAD SPEED, MPH	OPERATING GEAR RANGE	COOLANT TEMP, °F	ENGINE OIL TEMP, °F	TRANS OIL TEMP, °F	AMBIENT TEMP, °F	DATA EXTRAPOLATED TO, °F	YPC REPORT NO.
M50A2	2-1/2 T	3.7	1-L	224	244	335 *	115	120	8007
M151A2	1/4 T	2.9	1	254	259	273	96	120	0049
M809	5 T	2.5	1-L	220	254	301 *	70	120	0030
M5462	5 T	3.6	2-L	219	268	340	89	120	8015
M121	10 T	2.2	1-L	213	270	---	---	120	6013
M151A1	1/4 T	9.6	1	232	288	413	80	120	9012
M715E1	1-1/4 T	4.0	1-H	240 *	258 *	315 *	105	120	8002
M410E1	2-1/2 T	3.5	1-L	229	251	262	98	115	6001
M656	5 T	5.6	3-C	247	285	293	71	115	5023
M656	5 T	2.8	1-C	217	97	249	97	115	5023
M656	5 T	2.8	1-C	225	272	261	98	115	7005
M54E3	5 T	4.1	2-L	209	232	---	93	115	07A-202
M51A2	5 T	5.3	2-L	257 *	299 *	212 *	94	115	7028
M35A2C	2-1/2 T	5.2	2-L	238	259	287 *	67	120	9077
M113	APC	2.0	1-C	221	251	269	85	115	07A-200
M551	Sheridan	3.0	1-C	241	274	327	104	120	7027
M551	Sheridan	4.5	2-C	246	282	351	100	120	9029
M60E1	Tank	9.0	Hi	X	250	281	95	115	07A-185
M60	Tank	9.9	Low	X	300	309	90	115	None
M60	Tank	14	Hi	X	256	195	101	115	4026
M50A1	Tank	10	Low	X	238	181	64	115	5016
M688E1	Lance	2.2	1-C	254	293	276	79	120	7016
M727	Lance	2.8	1-C	233	271	253	85	120	7003
M747E2	Lance	3.9	1-C	255	265	266	82	115	3074
M501E3	Hawk Lt.	4.1	Low	237	238	236	96	115	4040
M113E2	1/2 T	2.0	1-C	247	266	258	100	115	3081
M274	1/2 T	4.3	1-L	X	257	220	93	115	3061
M116	Carrier	4.4	GS-1	227	260	262	102	Not Extrapolated	DPS/07A83
LVTX12(P7)	APC	4.7	1-C	224	257	243	100	125	8003
M705	1-1/4 T	7.5	1-H	220	266	353	80	120	0143
M72A1C	10 T	40	5-H	163	231	426 *	87	Not Extrapolated from Road Load Data, Full Load not available.	Letter Report Sept. 22 1972
M520E1 GOER	8 T	1.5	1-C	225	276	264	64	120	2014

*Temperatures not stabilized, still rising.

L = LOW

H = HIGH

C = CONVERTER

X = NOT RECORDED

AMCP 706-361

of operating conditions. Failure to do so will produce engine problems resulting from overheating or overcooling.

Excessively high engine temperatures in gasoline engines not only cause "knock" and loss of power, but also will result in damage to bearings and other moving parts. Cylinder heads and engine blocks often are warped and cracked, especially when coolant is added immediately after overheating without allowing the engine to cool. Overheating causes coolant boiling. If the vehicle is operated with boiling coolant, steam pressure forces large quantities of coolant out of the system through the radiator overflow pipe. More violent boiling then occurs, and still more coolant is lost. Finally, coolant circulation stops, and cooling fails completely. This means that operating an engine with the coolant boiling for even a short length of time actually may be driving that engine to destruction.

Although less sudden in effect than overheating, overcooling may be equally dangerous to the engine. Low engine operating temperature, especially during freezing weather, results in excessive fuel consumption, dilution of engine oil by unburned fuel, and formation of sludge from condensation of water (a product of combustion) in the crankcase. Lubrication failure may follow sludge formation and lead to serious engine damage. Burned fuel vapors also mix with water in the crankcase and form corrosive acids that attack engine parts.

For large liquid-cooled diesel engines, the heat removed from the cylinder heads by the cooling medium varies from 15 to 20 percent of the energy input. The heat removed varies from 20 to 35 percent for gasoline engines, and may be as high as 40 percent at one-third load. These values indicate a heat loss ranging from 40 to 50 percent of the brake horsepower output for large diesel engines and 100 to 150 percent of the brake horsepower output for gasoline engines¹ (Ref. 1).

¹ Courtesy of McGraw-Hill Book Company

Piston cooling in both air- and liquid-cooled engines is accomplished by heat transfer to the cylinder walls and lubricant. In most air-cooled diesel engines, an appreciable quantity of oil is directed against the underside of the piston to maintain acceptable temperatures.

In high output, liquid-cooled engines, the coolant is directed at the hottest spot, usually the exhaust valve seat, to minimize the formation of vapor bubbles that could form and cling to the surface causing overheating. In vertical engines, the coolant usually flows upward, around the cylinder barrels into the cylinder head cooling jacket, and to the outlet.

1-1.2 CONVENTIONAL COOLING SYSTEMS FOR ROTATING ENGINES

1-1.2.1 Gas Turbine Engine

Gas turbine engines normally are air-cooled and require adequate inlet and exhaust ducting for satisfactory operation. The air generally is bled off from the engine compressor. Internal cooling passages sometimes are provided in the turbine blades of high power output engines.

Turbine engine vehicle installations normally require an oil-to-air heat exchanger to provide cooling for the turbine engine lubricating oil. This heat exchanger and the exhaust ducting are the major components of the turbine engine cooling system.

The turbine engine power output is influenced greatly by inlet temperature, and provisions must be made to prevent heated air recirculation and heating of the oil-cooler inlet system by thermal radiation. Any ducting required to the engine air inlet and exhaust outlet should be of sufficient size to minimize the air pressure drops. Intake or "compressor" noise from a turbine engine normally will require silencing.

1-1.2.2 Rotating Combustion Engine

The Wankel and other rotating combustion engine cooling systems basically are the same

as the reciprocating combustion engine cooling systems and may be air-cooled or liquid-cooled. The engine housing may be finned for air-cooling or provided with coolant passages for liquid-cooling. A conventional type coolant pump and radiator are used with the liquid-cooled design. Fig. 1-1 illustrates a typical rotary engine liquid-cooling system. Because of the localized combustion heating of the rotary engine housing, uneven thermal stresses may develop. To minimize stress levels, the cooling jackets or fins normally are located in the areas exposed to combustion gases. In this configuration, induction air/fuel cooling and lubricating oil flow maintain the rotor at acceptable temperature levels. The engine rotor is cooled by circulating the lubricating oil through passages within the rotor. The oil pump draws oil from the sump, pushes it through a filter and then into a heat exchanger. Still under pressure, the oil continues straight into the hub of the rotor,

circulates inside it, and flows out from the hub sides into the sump, where the pump can pick it up again. The NSU engine oil and coolant flow is depicted in Fig. 1-2. Detailed descriptions of the engine cooling and heat rejection characteristics of rotating engines are presented in Chapter 2.

Fig. 1-3 illustrates a typical automotive installation of the NSU Wankel engine.

1-2 COOLING REQUIREMENTS

Military ground vehicle cooling systems usually are designed for climatic conditions as outlined in AR 70-38 and discussed in detail under eight climatic categories (Ref. 2). Each category has been differentiated on the basis of temperature and/or humidity extremes as shown in Table 1-2. Vehicle specifications will define the required operating conditions. The specifications will also state if the use of kits are permitted to meet the environmental

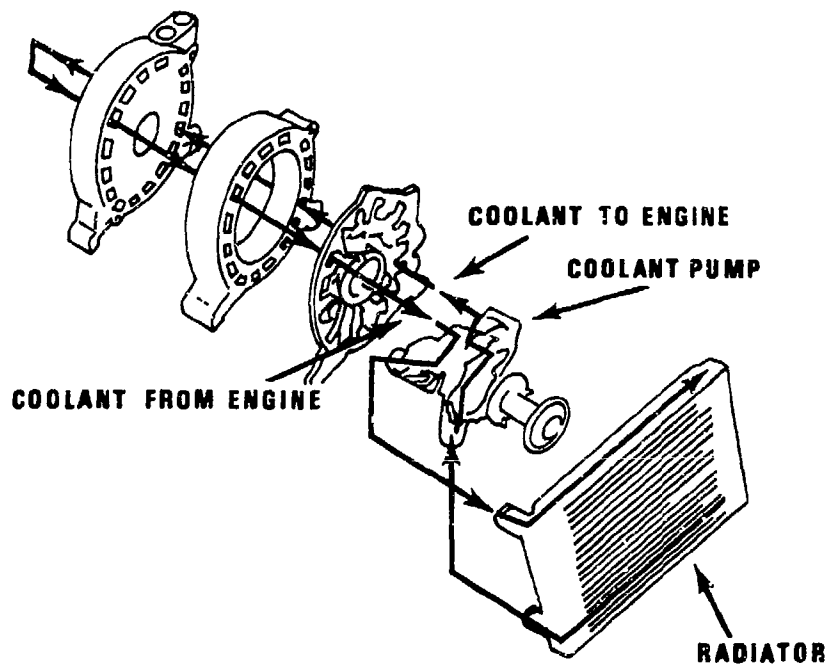

Figure 1-1. Rotary Engine Cooling System Diagram

AMCP 706-361

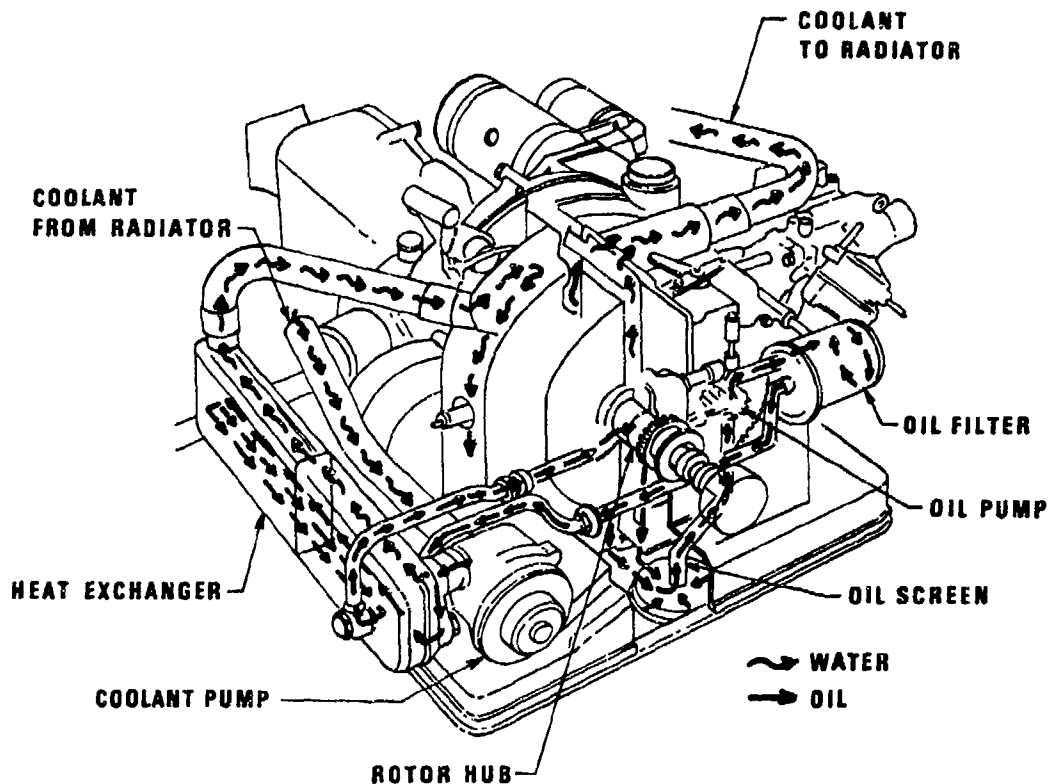

Figure 1-2. NSU KKM 502 Wankel Engine Cooling System
(From THE WANKEL ENGINE, by Jan Norbye. Copyright © 1971
by the author. Reprinted with the permission of the publisher,
Chilton Book Company, Radnor, Pennsylvania.)

requirements. A power plant must be able to operate through its full operating range, without overheating, in the specified ambient temperatures even though housed in an enclosed compartment ventilated through a restrictive type grille. The power plant also must operate equally well at low ambient temperatures, as defined by the system specifications, without degradation of performance.

Lubricating oil temperature limitations based on results of high temperature oxidation tests have been recommended by the U S Army Coating and Chemical Laboratory.

These values have been established at 250°F for sustained engine operation at rated load and speed for MIL-L-2104 lubricant. For short periods, not exceeding 15 min, an allowable temperature of 270°F can be tolerated. These temperature limitations are based upon results of the high temperature oxidation rate that approximately doubles for every 18 deg F increase above 150°F. These higher temperatures also increase the possibility of bearing corrosion that could result in early engine failure.

If MIL-L-2104 oils are used as automatic transmission or gearbox fluids, the maximum

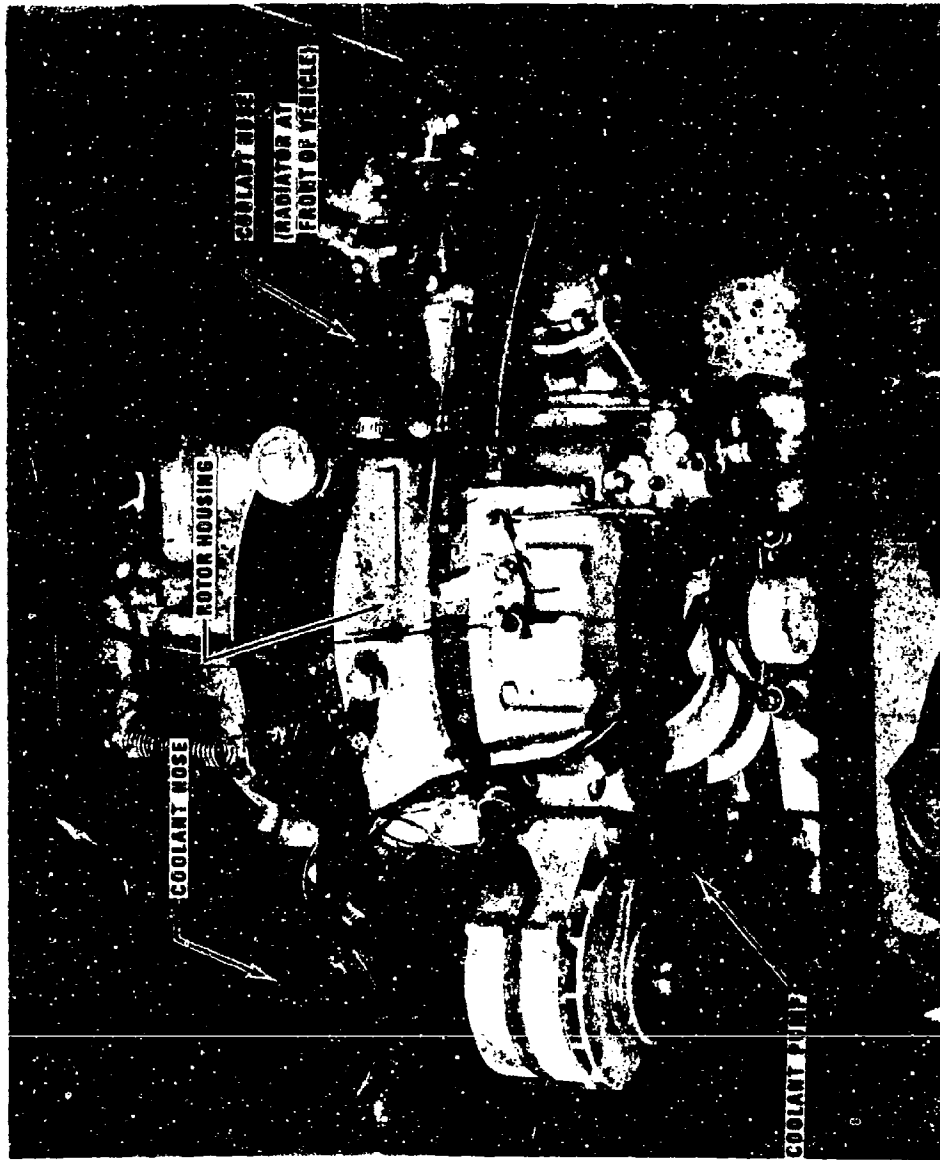

Figure 1-3. NSU Spider Car Wankel Engine, Installed View

AMCP 706-381

TABLE 1-2

SUMMARY OF TEMPERATURE, SOLAR RADIATION, AND RELATIVE HUMIDITY
 DAILY EXTREMES (Ref. 2)

CLIMATIC CATEGORY	OPERATIONAL CONDITIONS			STORAGE AND TRANSIT CONDITIONS	
	AMBIENT AIR TEMPERATURE, °F	SOLAR RADIATION, Btu/ft ² -hr	AMBIENT RELATIVE HUMIDITY, %	INDUCED AIR TEMPERATURE, °F	INDUCED RELATIVE HUMIDITY, %
1 WET-WARM	Nearly constant 75	Negligible	95 to 100	Nearly constant 80	95 to 100
2 WET-HOT	78 to 95	0 to 360	74 to 100	90 to 160	10 to 85
3 HUMID-HOT COASTAL DESERT	85 to 100	0 to 360	63 to 90	90 to 160	10 to 85
4 HOT-DRY	90 to 125	0 to 360	5 to 20	90 to 160	2 to 50
5 INTER- MEDIATE HOT-DRY	70 to 110	0 to 360	20 to 85	70 to 145	5 to 50
6 INTER- MEDIATE COLD	-5 to -25	Negligible	Tending toward saturation	-10 to -30	Tending toward saturation
7 COLD	-35 to -50	Negligible	Tending toward saturation	-35 to -50	Tending toward saturation
8 EXTREME COLD	-60 to -70	Negligible	Tending toward saturation	-60 to -70	Tending toward saturation

NOTE: Kits may be allowable to meet Category 7 and 8 Conditions

allowable temperature is 300°F (Ref. 3) because localized hot spots in transmissions and gearboxes are not as severe as in an engine.

Wheeled vehicle power train components, located downstream from the engine heat and subjected to conducted heat from the transmission and radiated heat from the exhaust system, often are found to exceed the maximum oil temperature limits and premature failure can occur.

1-3 TYPICAL COOLING SYSTEMS

1-3.1 CONVENTIONAL TRUCKS

1-3.1.1 Liquid-cooled

A conventional liquid-cooling system, illustrated in Fig. 1-4, is typical of the system used in the Truck, Cargo, 2-1/2-ton, 6 X 6, M44.

This type cooling system consists of the engine radiator, radiator hoses, coolant thermostat, coolant pump, cooling fan, and fan belts. Coolant is circulated by the belt-driven coolant pump through the oil-cooler, and through the crankcase block coolant jacket where it flows around the cylinder walls and then into the cylinder heads. After circulating through the cylinder heads, the coolant flows into the coolant header/manifold. Then it flows to the intake manifold jacket and finally to the bypass thermostat housing where the thermostat controls the coolant flow to the radiator. A fan mounted on the coolant pump shaft provides airflow through the radiator.

The purpose of the thermostat is to maintain a constant engine coolant temperature regardless of engine speed, load, coolant flow, ambient temperature and pressure, and the system operating pressure. However, when the engine heat rejection equals or exceeds the radiator heat transfer capacity the coolant will boil regardless of the thermostat action.

During the warm-up period when the thermostat is closed, provisions must be made to circulate coolant through the engine to prevent hot spots from developing. A coolant bypass or bleed hole in the thermostat permits this circulation through the engine (see Fig. 1-5). When the thermostat fully opens, the bypass is closed to prevent coolant flow through the bypass circuit which would cause a loss in radiator cooling efficiency. Circulation of coolant in the engine coolant jacket is shown in Fig. 1-6.

A schematic diagram indicating a vehicle engine oil cooling system is shown in Fig. 1-7. This cooler assembly system is an integral engine component. For cooling system design considerations, engine heat rejection to the lubricating oil is included in the total engine heat rejection rate.

In addition to the engine heat rejection, other factors such as airflow restriction caused by accessory installations, additional loads such as the alternator, air compressor, recirculation of hot air and exhaust gases, and the effects of restriction of airflow through the entire system must be considered.

1-3.1.2 Air-cooled

Currently there are no air-cooled conventional trucks used in the US military fleet. However, the air-cooled engine has been adopted for use in many special and combat vehicles.

The direct air-cooled engine offers advantages in simplicity since the radiator, coolant pump, hoses and connections, thermostat, and coolants, are dispensed with. In light of recent advances in manufacturing techniques, materials, and lubricants, the use of air-cooled engines for truck powering is becoming more common, particularly in foreign countries.

AMCP 706-381

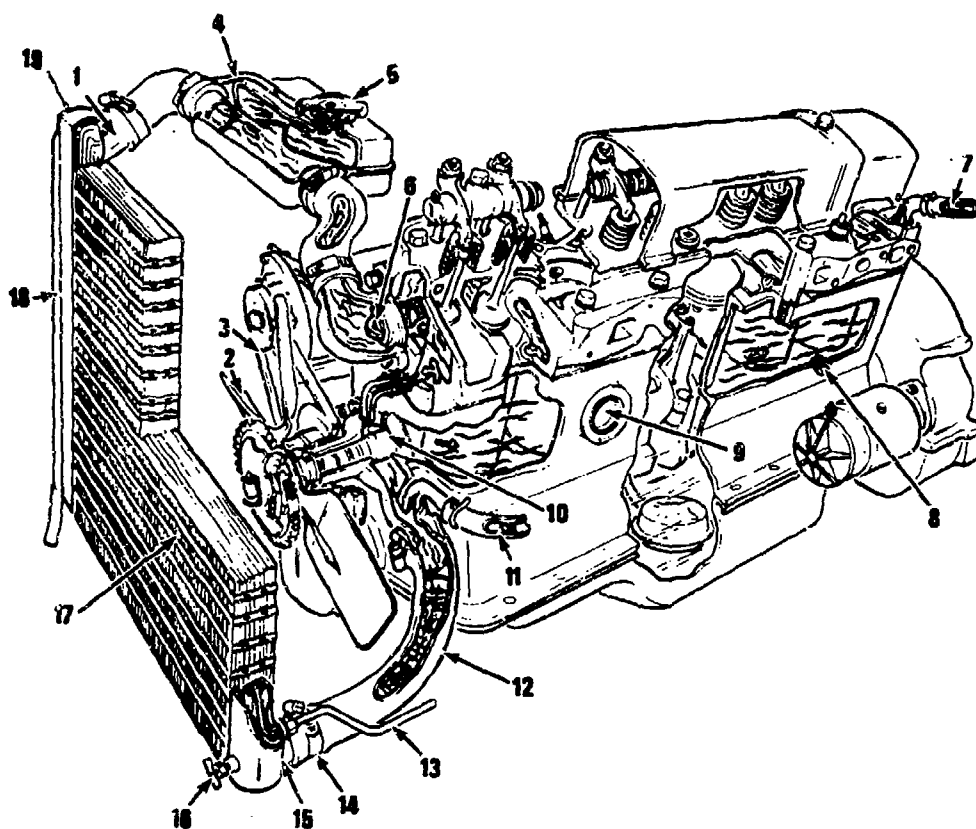

- | | |
|-------------------------------|-------------------------|
| 1. INLET | 11. HEATER LINE |
| 2. FAN | 12. RADIATOR HOSE |
| 3. DRIVE BELT | 13. OIL COOLER LINE |
| 4. RADIATOR OVERFLOW TANK | 14. HOSE CLAMP |
| 5. OVERFLOW TANK PRESSURE CAP | 15. OUTLET |
| 6. THERMOSTAT | 16. RADIATOR DRAIN COCK |
| 7. HEATER LINE | 17. RADIATOR CORE |
| 8. ENGINE BLOCK DRAIN PLUG | 18. OVERFLOW TUBE |
| 9. CORE HOLE PLUG | 19. RADIATOR TANK |
| 10. COOLANT PUMP | |

Figure 1-4. Typical Cooling System Components (Ref. 12)

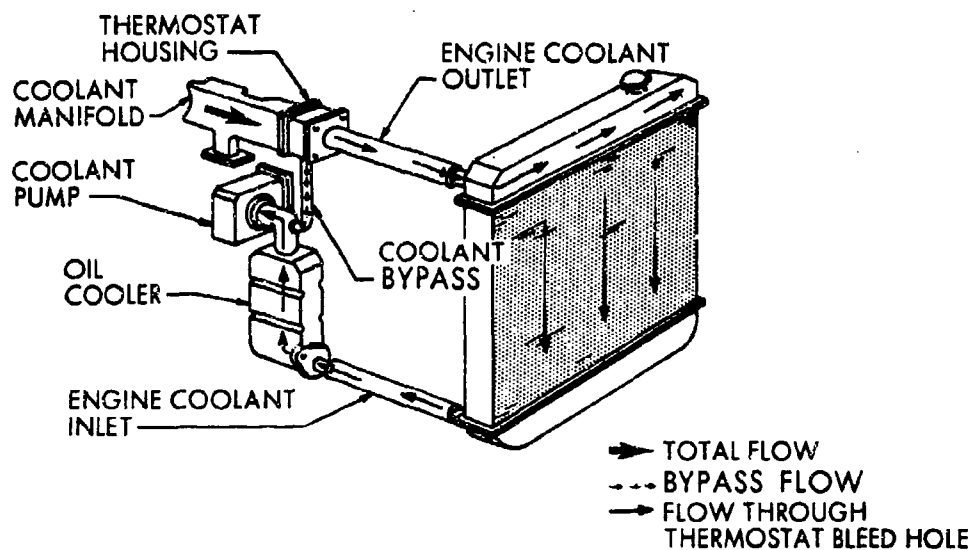

(A) CONVENTIONAL COOLING SYSTEM
CLOSED (cold) THERMOSTAT COOLANT FLOW
(nonblocking type)

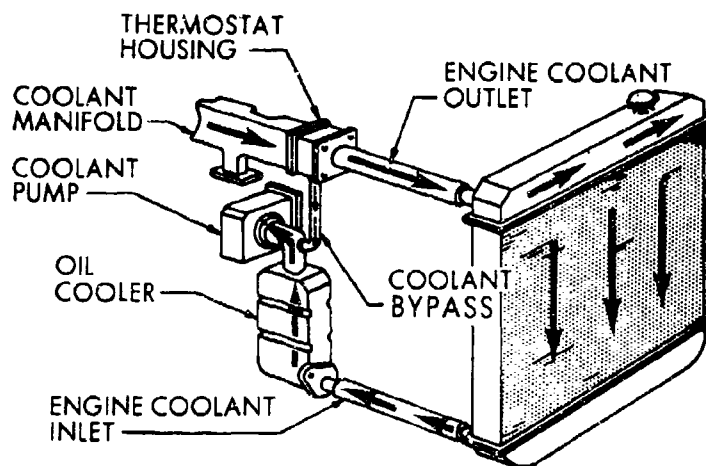

(B) CONVENTIONAL COOLING SYSTEM
OPEN (hot) THERMOSTAT COOLANT FLOW
(nonblocking type)

Figure 1-5. Coolant Flow With Coolant Bypass and Bleed Hole in Thermostat (Ref. 8)
(Courtesy of Detroit Diesel Allison Division, General Motors Corporation)

AMCP 706-361

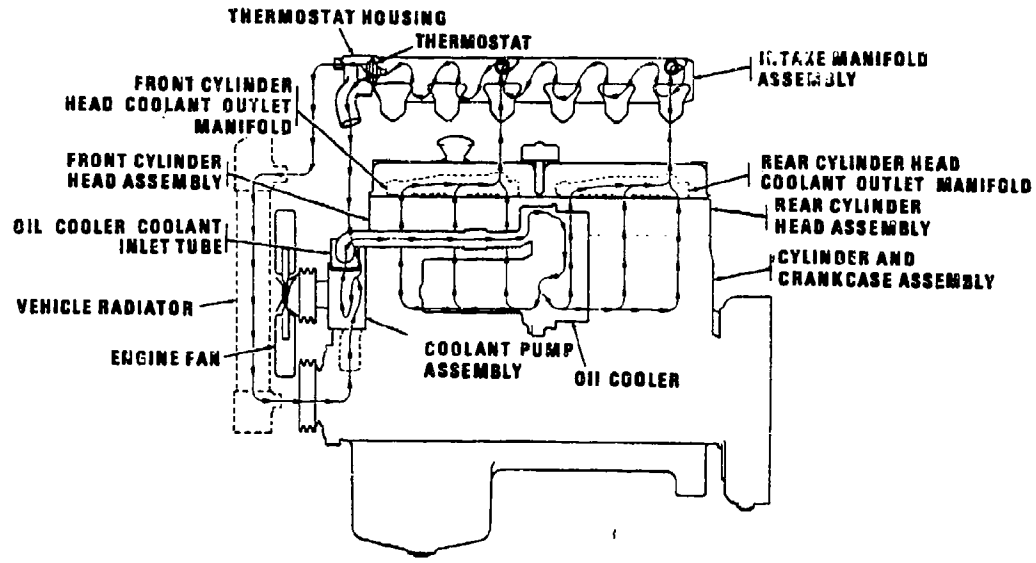

Figure 1-6. Circulation of Coolant in Engine Coolant Jacket (Ref. 12)

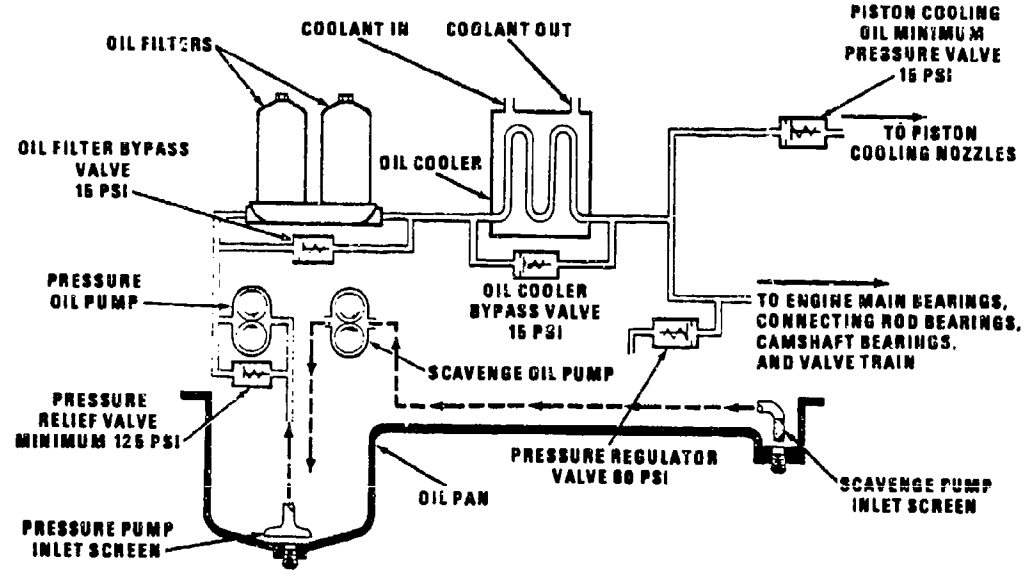

Figure 1-7. Engine Lubricating Oil Cooling Schematic Diagram (Ref. 9)

1-3.2 SPECIAL PURPOSE VEHICLES

1-3.2.1 Liquid-cooled

1-3.2.1.1 Carrier, Command and Reconnaissance, Armored, M114A1

The M114A1 Carrier power package installation, shown in Fig. 1-8, typically illustrates the limited space available for cooling system components in military vehicles. The vehicle power package is a Chevrolet 283 CID gasoline engine and Allison model 305 transmission. Careful design attention to cooling component selections and placement, compartment restriction to airflow, inlet and exhaust grille restrictions, and compartment sealing to prevent recirculation of heated air was necessary to arrive at a satisfactory vehicle cooling system.

Fig. 1-9 illustrates the inlet and exhaust grilles for the M114A1 Carrier. The cooling air is drawn into the engine compartment through the inlet grille and is forced through the radiator by the cooling fan. The air then circulates through the transmission compartment and exits through the exhaust grilles.

1-3.2.1.2 Carrier, Assault Amphibian, Personnel, LVTPX12 (Ref. 24)¹

An example of the integration of a vehicle cooling system is the LVTPX12 shown in Fig. 1-10. This vehicle has a three man crew and can transport 25 troops or 10,000 lb of cargo. The speed on land is 40 mph with a minimum water speed of at least 8 mph. The power package consists of a turbocharged, liquid-cooled, eight cylinder, 2-cycle diesel engine developing 400 bhp at 2800 rpm, and a Model HS400 crossdrive transmission.

The cooling system design requirements were to cool adequately while the vehicle

operates at full power with a 0.4 torque converter speed ratio in an ambient air temperature of 125°F. The power plant cooling system consists of a fan, radiator, keel cooler, two heat exchangers, ducting, hoses, tubes, and fittings. Coolant circulation through the engine, radiator, and keel cooler is the same for land and water operation; however, the method of reducing coolant temperature is different for the two modes.

During land operation, cooling air is drawn through the forward grille in the top deck, forced through the radiator by the cooling fan, and exhausted through the rear deck grille. Fig. 1-10 shows the LVTPX12 cooling and ventilating air systems. During water operation, the fan drive clutch is disengaged, both grille doors are closed, and cooling is accomplished by the integral keel cooler in the hull. Engine and transmission oil is cooled by individual heat exchangers attached to the right side of the engine. An interesting feature during operation in waves or surf is the ability of the vehicle to draw air momentarily from the crew compartment.

Cooling system ducting is rigidly suspended from the hull structure, with flexible seals between the fan inlet and hinged inlet grille plenum and between the radiator and the hinged exhaust grille plenum. Flexible supports are provided between the fan-radiator assembly and the power pack to make possible the removal of the entire unit. Since the land cooling system is maintained integral with the power pack at removal, the entire unit can be operated on a stand outside the vehicle. This is a very desirable feature for any military vehicle.

A full scale mock-up of the cooling air system was built and tested to provide design information for selection of the size of the intake grille area and cooling fan. The cooling fan is sized to provide 19,500 cfm of air at 8 in. of water static pressure. Coolant flow rate is 150 gpm with a 3 psi maximum pressure drop.

¹ Reprinted with permission, "Copyright © Society of Automotive Engineers, Inc., 1968, all rights reserved."

AMCP 706-361

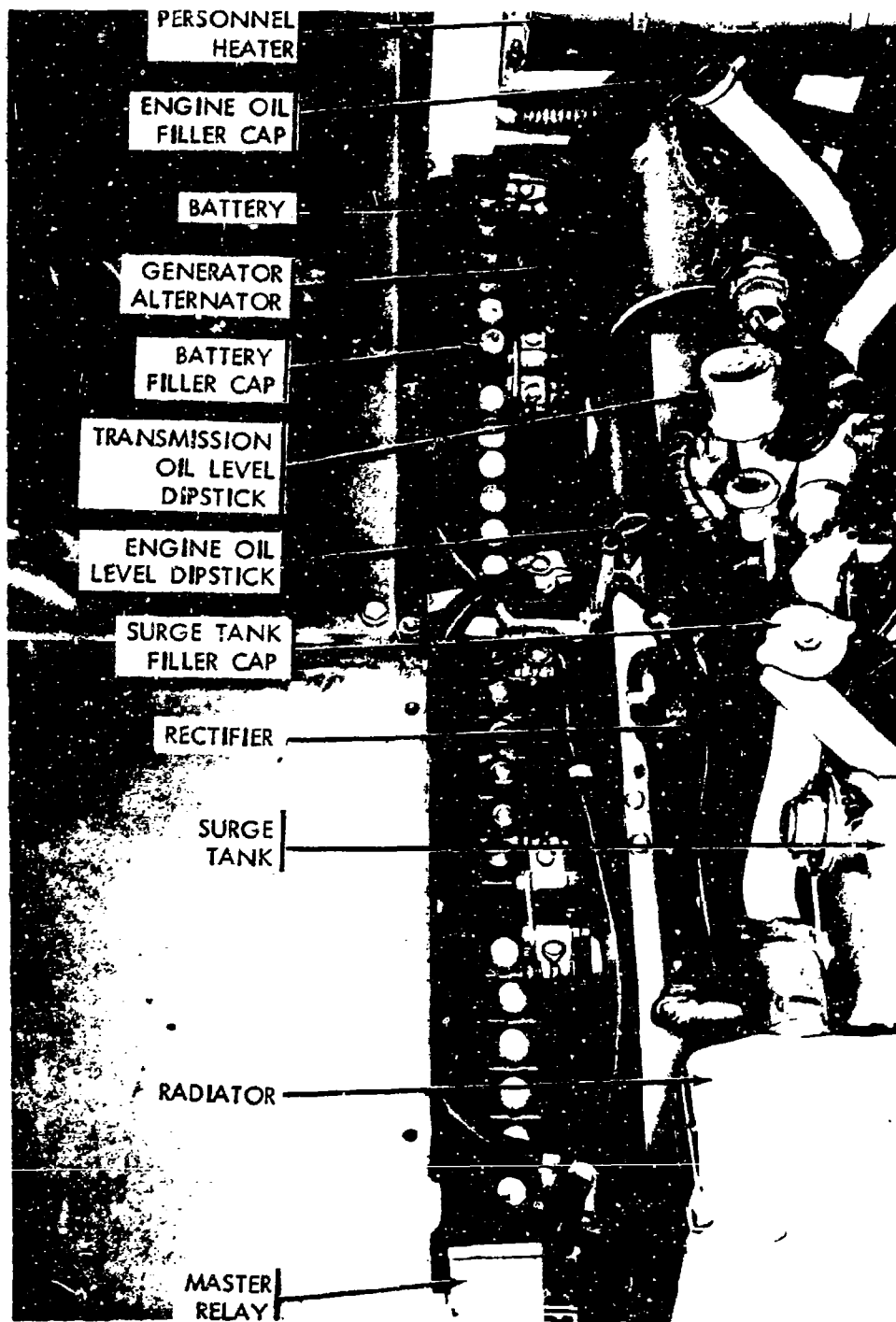
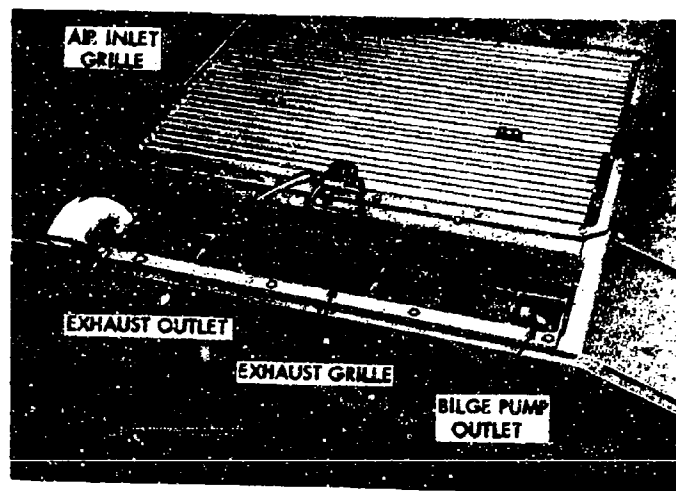
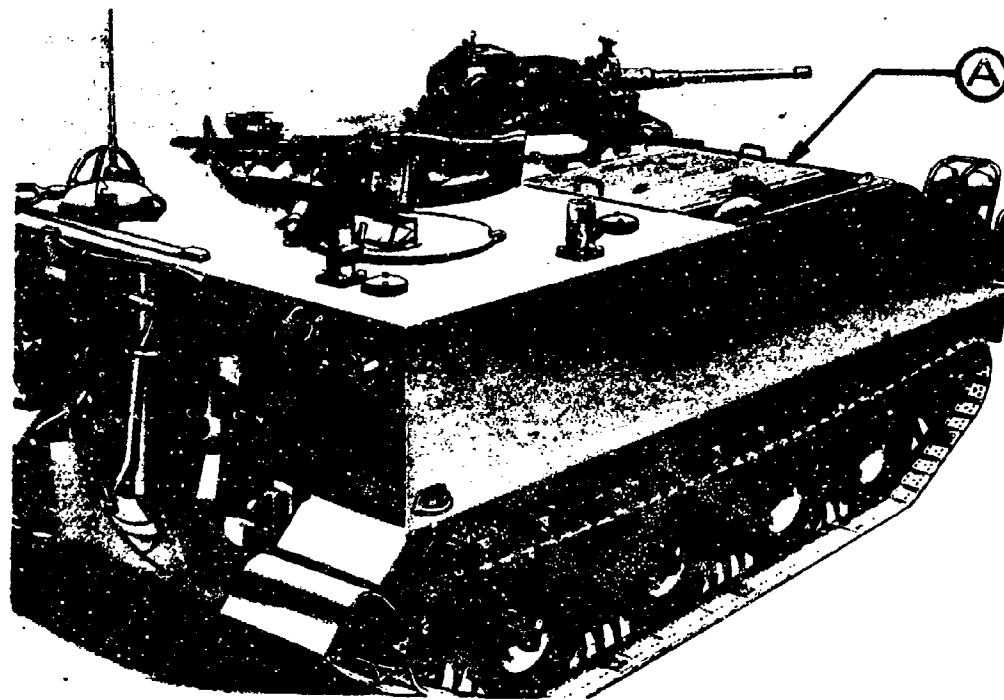

Figure 1-8. Power Plant Installed in Carrier, Command and Reconnaissance, Armored, M114/M114A1 (Refs. 11 and 45)

AMCP 706-361



VIEW A

*Figure 1-9. Carrier, Command and Reconnaissance, Armored, M114A1,
Cooling Grilles (Ref. 11)*

AMCP 706-361

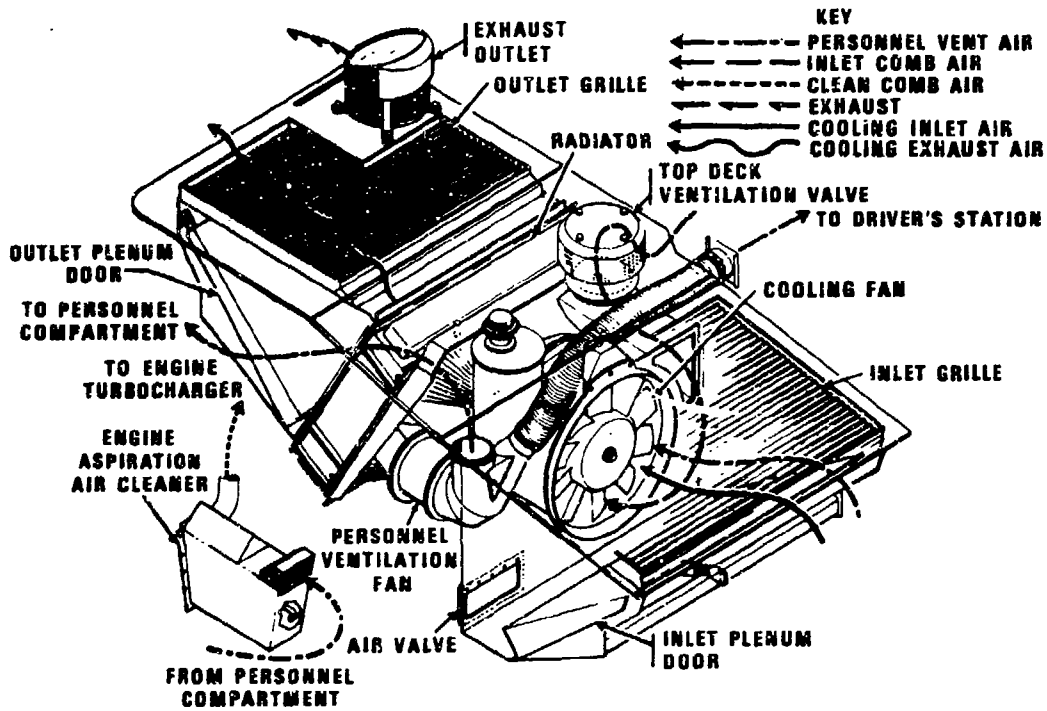

Figure 1-10. LVTPX12 Integrated Vehicle Cooling System (Ref. 24)
 (Reprinted with permission, Copyright © Society of Automotive Engineers, Inc., 1968, all rights reserved.)

1-3.2.1.3 Crane, 20-ton, Rough Terrain

Special vehicles and construction equipment have cooling requirements equally severe as the combat and tactical vehicles. A typical example of this is the Crane, 20-ton, Rough Terrain, as shown in Fig. 1-11.

The vehicle performance requirements specify:

1. Air temperature range from 125°F minimum exposure of 4 hr with full impact of solar radiation of 350 Btu/ft²-hr to -25°F exposure of 3 days without benefit of solar radiation.

2. Capability of safe storage and transportation without permanent impairment of its

capabilities from the effects of temperatures from -65°F, duration 72 hr, to 155°F for periods as long as 4 hr per day.

3. Shallow water fording capability to a depth of 36 in. minimum, and 48 in. if practical.

4. The unit is required to be air transportable.

5. The unit shall have a gradeability of 40 percent on a road having a rolling resistance of 40 lb/ton.

6. The unit shall be capable of speeds up to 30 mph.

7. The unit shall be suitable for beach and

AMCP 708-361

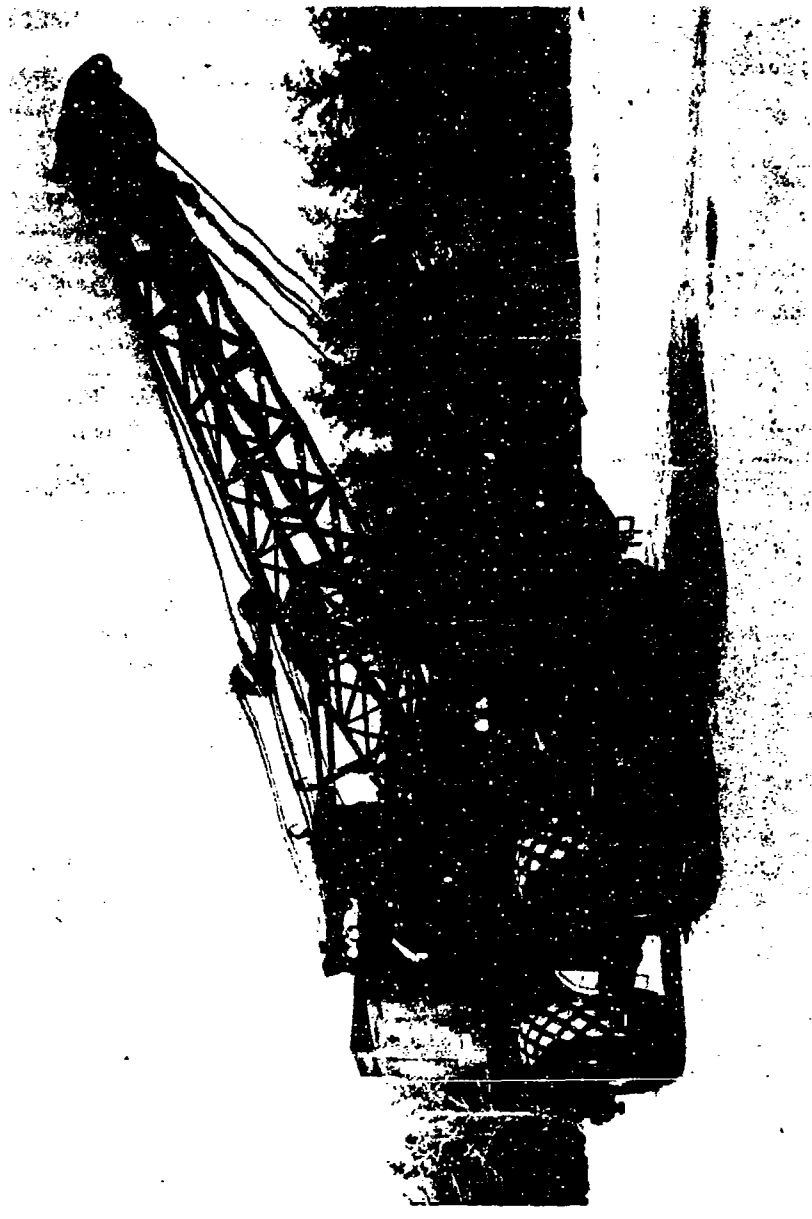

Figure 1-11. Crane, 20-ton, Rough Terrain (USAMERDC)

AMCP 706-381

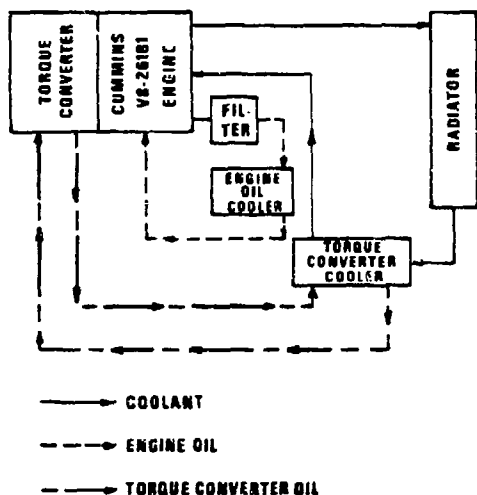

Figure 1-12. Cooling System Schematic Diagram, Crane, 20-ton Rough Terrain (USAMERDC)

shore operations, in forward areas, and over rough terrain.

A schematic diagram of the vehicle cooling system is shown in Fig. 1-12.

1-3.2.2 Air-cooled

The Truck, Platform Utility, 1/2-ton, 4 X 4 M274A5, shown in Fig. 1-13 uses a Military Standard Model A042 air-cooled, spark ignition engine. This engine has a self-contained cooling system consisting of a belt-driven axial flow fan, contoured sheet metal to direct airflow around the cylinder, and cylinder head fins. The prime considerations for a satisfactory cooling installation with this engine/vehicle basically were limited to the provisions for unobstructed air entry into the fan and unobstructed air discharge from the cylinders and cylinder heads. The completely open installation of this engine relieved the vehicle cooling system designer of the necessity to evaluate such items as grille restrictions and pressure drops normally

found in an engine compartment. The M274A5 Engine cooling system is shown in Fig. 1-14.

1-3.2.3 Family of Military Engineer Construction Equipment (FAMECE)

FAMECE (Ref. 44) is a sectionalized, articulated, or hinge steering pneumatic-tired earthmoving system. It is intended for use by US Army airborne, airmobile, and other combat engineering organizations as a replacement for current, comparable wheeled equipment to accomplish construction tasks under varying climatic conditions from arctic to tropic, over typical terrain in all theaters of operation, and during daylight or at night.

The system will consist of a standard power module and several different types of construction work modules. Each initial FAMECE vehicle will consist of a standard power module and one of the following construction work modules: dozer, loader, grader, scraper, dumper, water distributor, compactor (pneumatic tire and vibrating steel drum combination), and compactor (pneumatic tire and vibrating tamping foot combination). Future construction work modules planned include: crane, stabilizer-mixer, backhoe, and grader side-sloper. Each of these vehicles will be so designed that only one operator will be required.

The standard power module will be compatible with and adaptable to all construction work modules. The standard power module also will be capable of moving independently over uneven terrain to permit coupling/uncoupling in not more than 30 min without the need for special tools or equipment.

The FAMECE vehicle will be capable of cross-country movement, of maintaining a 25 mph convoy speed, and of being transported and airdropped from aircraft. Individual modules will be capable of being airlifted as a

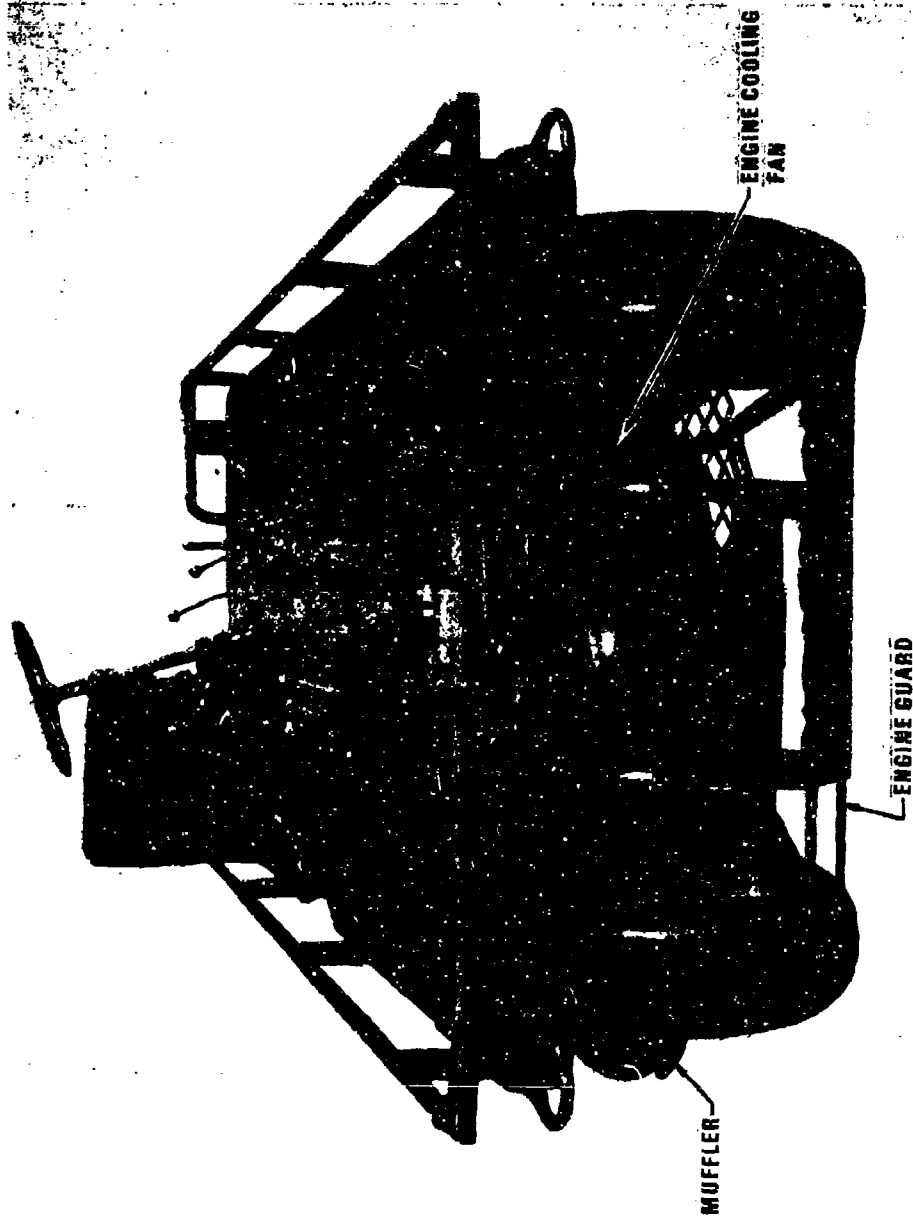

Figure 1-13. Rear View of Truck, Platform Utility, M274A5 (Ref. 10)

AMCP 708-361

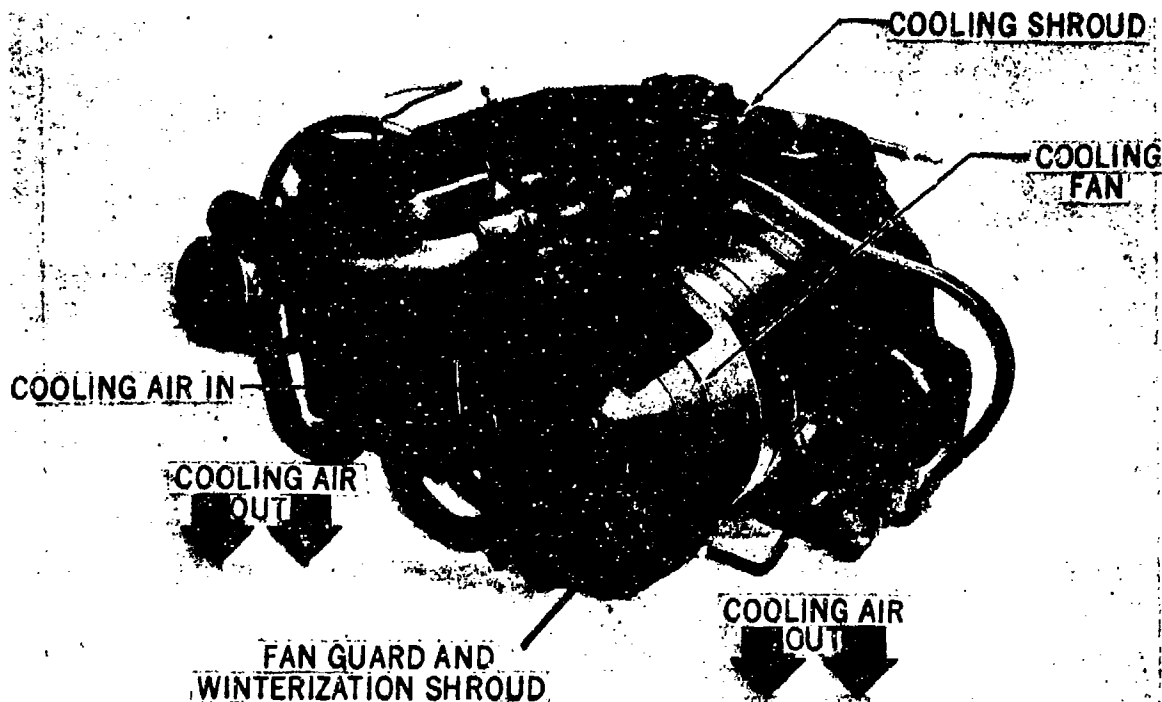

Figure 1-14. Air-cooled Engine Used in Truck, Platform Utility, M274A5

separate load by helicopter. Further, modules will be provided with lifting and tie-down devices to permit their worldwide movement by highway, rail, ocean, amphibious, and inland waterway carriers with a minimum of disassembly.

The power module will use standard Army fuels and will be powered by a 250-hp, military standard or qualified products list (QPL), compression ignition or turbine engine. This power module will be designated for a transmission speed range which will efficiently provide low speed, high torque working speeds, and a high speed transport capability (with work unit) of at least 30 mph on level, hard road surfaces. This module is shown in Fig. 1-15. The work construction modules to be used with the power module are shown in Fig. 1-16.

1-3.3 COMBAT VEHICLES

1-3.3.1 Tanks

1-3.3.1.1 MBT70 Prototype/XM803 Experimental Tanks

1-3.3.1.1.1 Air-cooled Tank Engines

1-3.3.1.1.1.1 Diesel Engine (Compression Ignition)

A typical air-cooled diesel engine power package installation of the MBT70 Prototype Tank is shown in Fig. 1-17. The power package consists of an AVCR-1100 air-cooled diesel engine and a XHM 1500 hydromechanical transmission. The engine and transmission oil coolers and engine aftercooler are shown in Fig. 1-18.

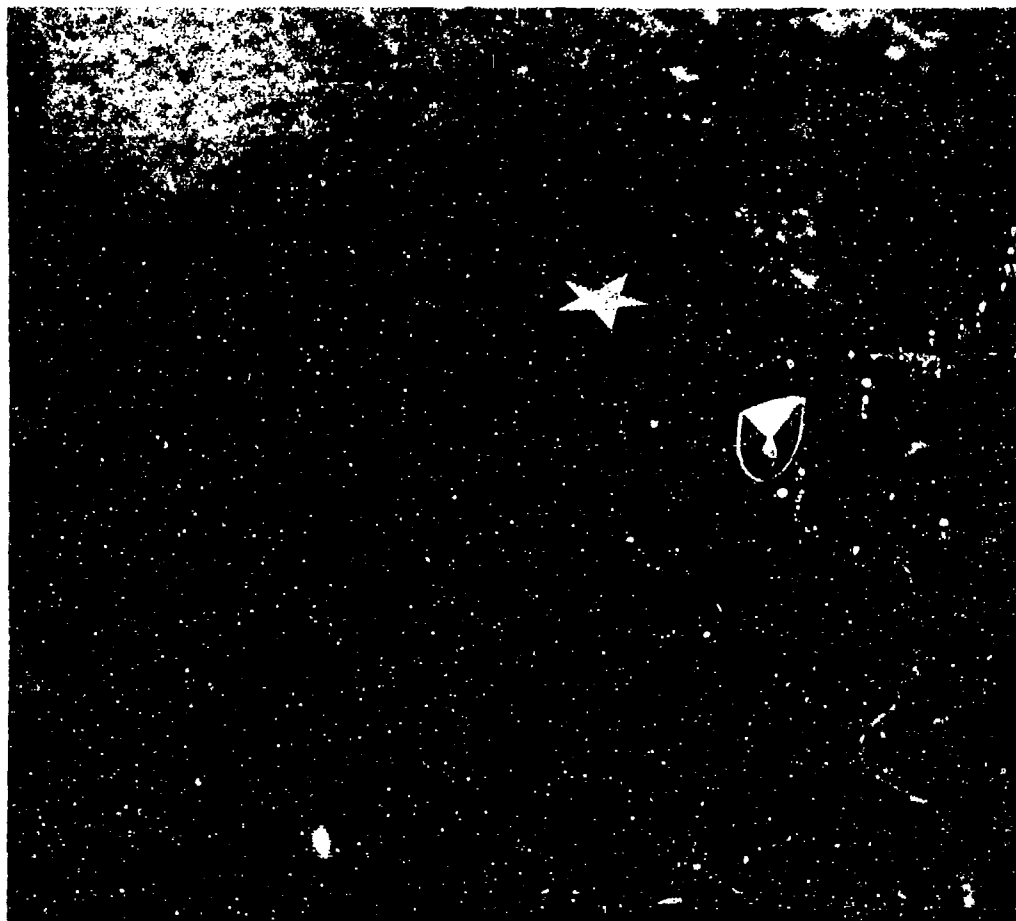

Figure 1-15. FAMECE Power Module (USAMERDC)

The AVCR-1100 (XM803 Experimental Tank) engine is a complete air-cooled system providing adequate engine cooling at ambient temperatures up to 120°F. The aftercoolers, oil-coolers, and sheet metal engine shrouding are used to form a plenum chamber around the engine. Two cast aluminum cooling fans are mounted at the top of this chamber and are driven from the gear train at each end of the engine. These cooling fans provide a rapid flow of air through the plenum chamber. Cooling air passes through the aftercoolers and oil-coolers, and in parallel paths through the cylinder cooling fins. It is then exhausted

by the fans out to the atmosphere. The AVCR-1100 engine is a highly supercharged engine and requires cooling of the induction air by aftercoolers after compression by the supercharger. Cooling air is directed around the cylinders by sheet metal baffles. The engine airflow is shown in Fig. 1-19.

The fans are driven through a wet-type clutch that allows slippage when the vehicle is forded and during rapid acceleration. The engine and transmission oil coolers use internal temperature compensating bypass valves to maintain oil temperatures (see Fig. 5-11).

AMCP 706-361

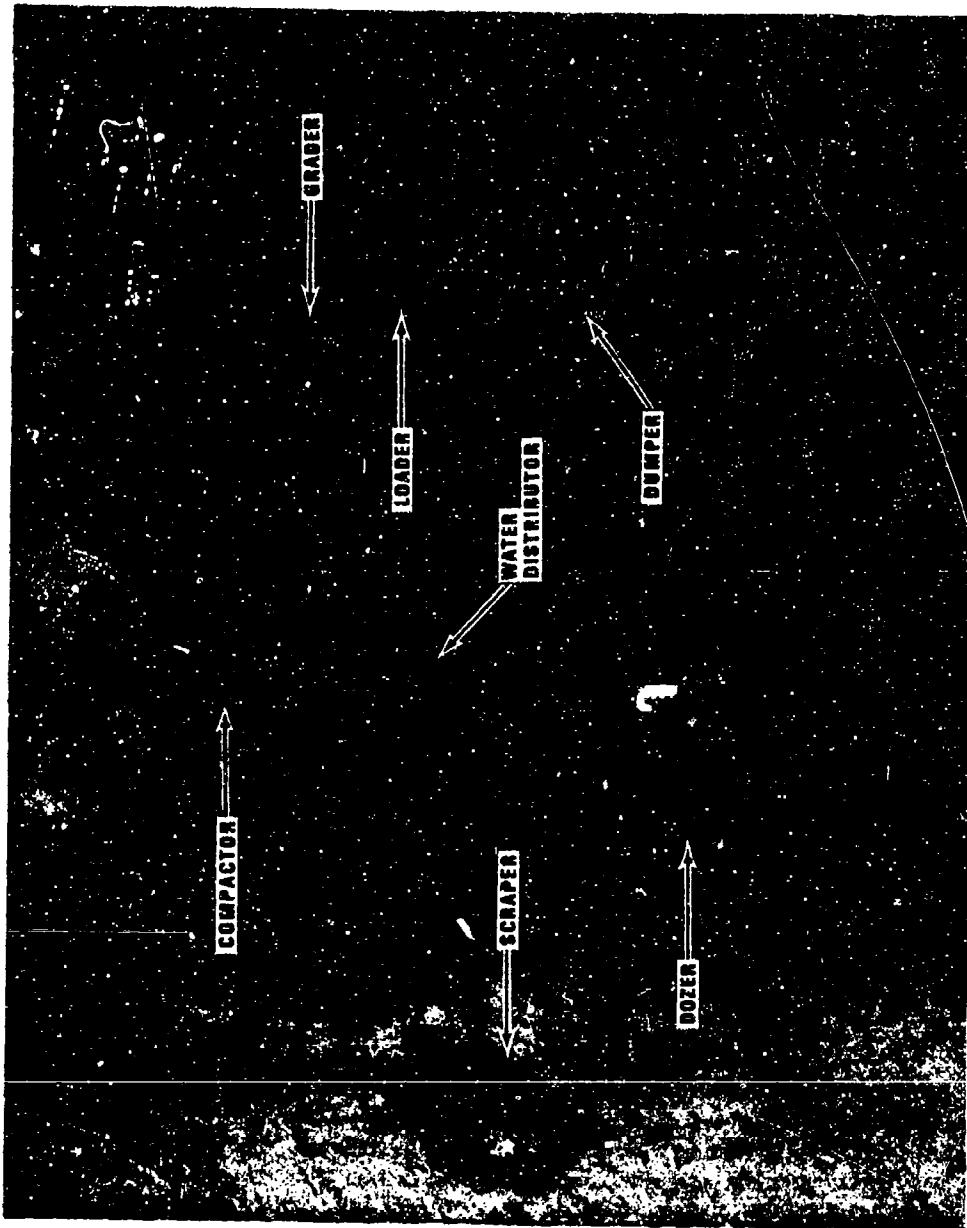

Figure 1-16. FAMECE Construction Modules (USAMERDC)

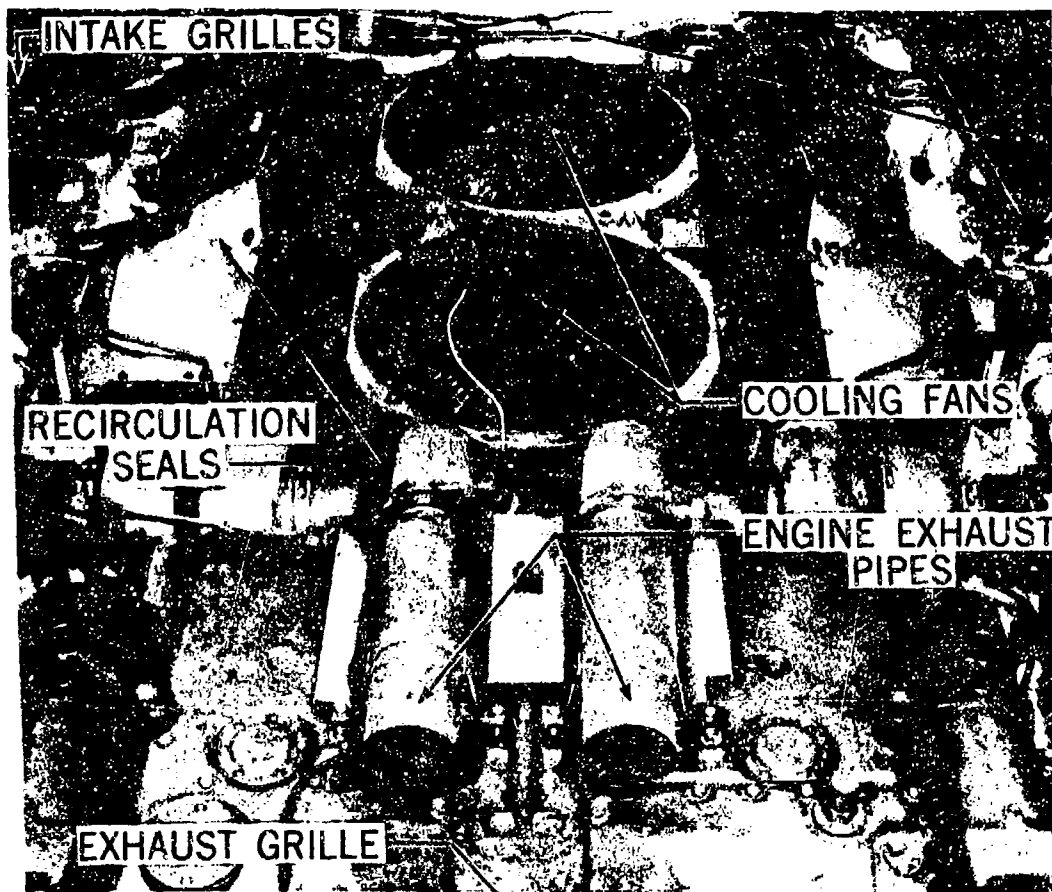

Figure 1-17. MBT70 Prototype Tank, Air-cooled Diesel Engine Power Package Installation

The location of the transmission and engine oil and fuel/hydraulic oil coolers of the AVCR-1100 power package installation are shown in Fig. 1-20. Separate cooling fans driven from the transmission are used for these coolers.

1-3.3.1.1.2 Gas Turbine Engine

A gas turbine engine installation in the MBT70 Prototype Tank is shown in Fig. 1-21. Fig. 1-22 shows the airflow through the engine. The first stage turbine nozzle and wheel (high pressure spool) are air-cooled.

Compressor air is bled through passages in the blades and discharged through holes drilled in the trailing edge. Fig. 1-23 shows the MBT70 Prototype Tank gas turbine engine power package removed from the vehicle.

1-3.3.1.1.2 Tank, M60/M48A3

The M60 and M48A3 Tanks are similar from a cooling system standpoint which will enable the ensuing discussion to apply to both vehicles. Air for cooling enters the engine compartment from the vehicle rear deck and exits through the rear exit grille doors as shown in Fig. 1-24. The top of the engine is shrouded and encloses two gear-driven, axial

AMCP 708-361

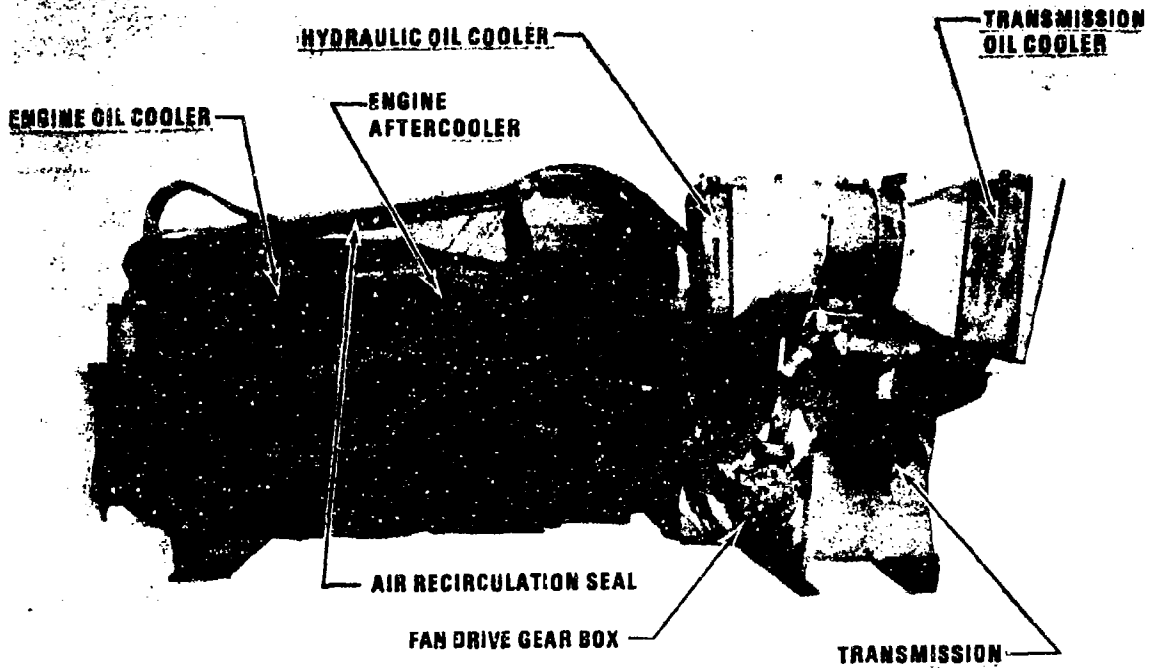

Figure 1-18. Tank, Experimental Model, XM803, Diesel Engine Power Package

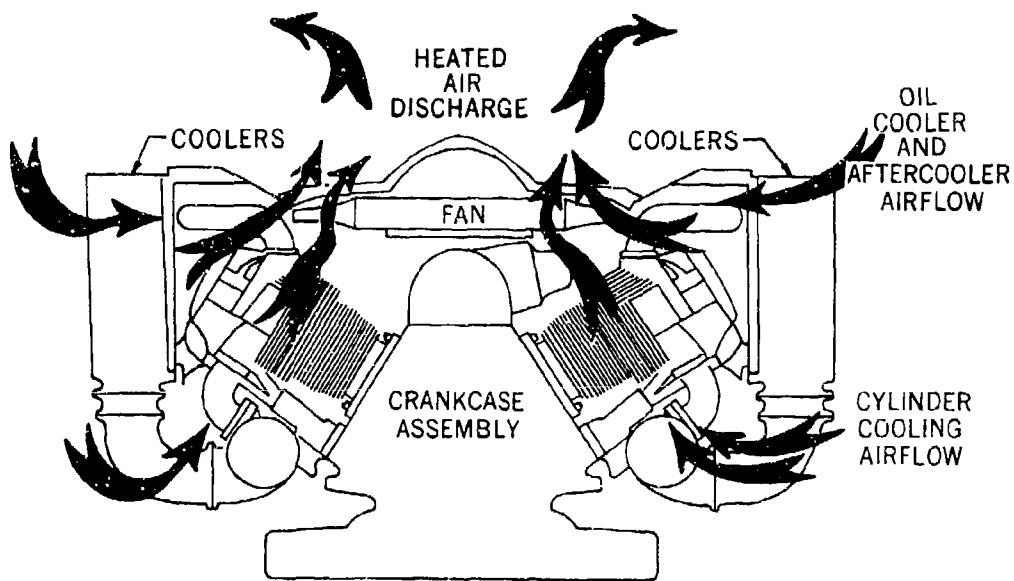

Figure 1-19. AVCR-1100 Engine Cooling Airflow in the XM803 Experimental Tank

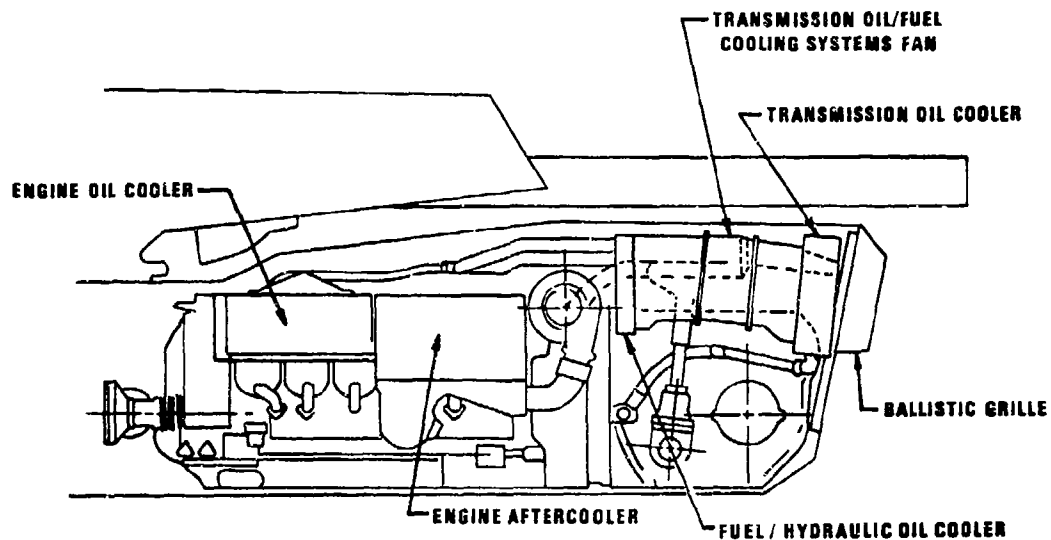

Figure 1-20. AVCR-1100 Power Package Installation in the XM803 Experimental Tank

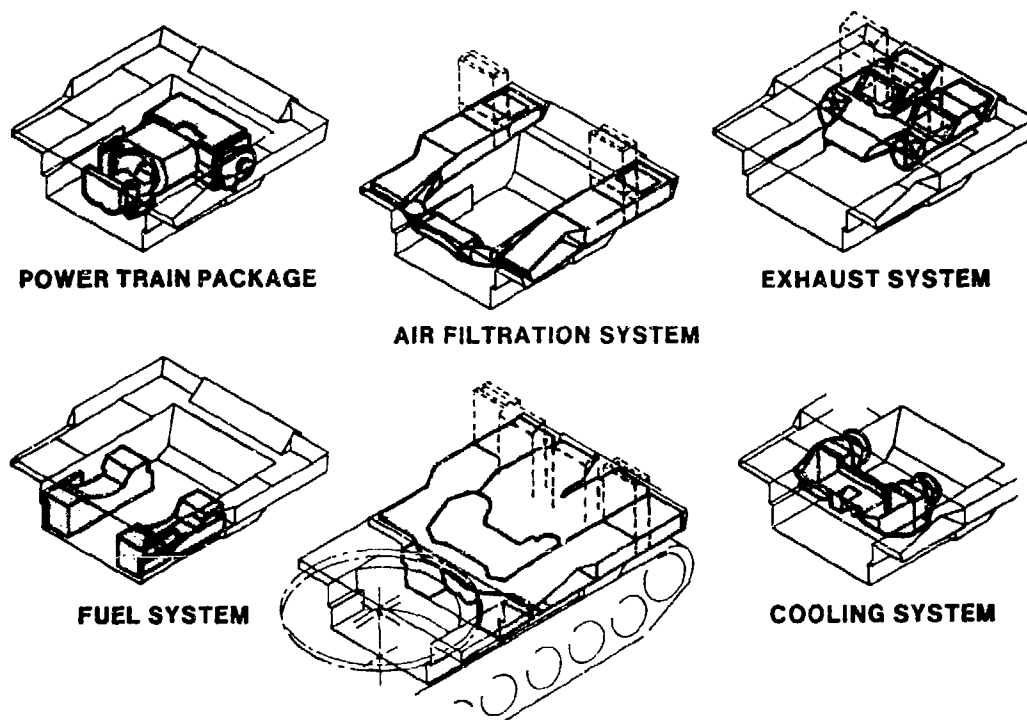

Figure 1-21. Gas Turbine Engine Installation in the MBT70 Prototype Tank (USATACOM)

AMCP 706-361

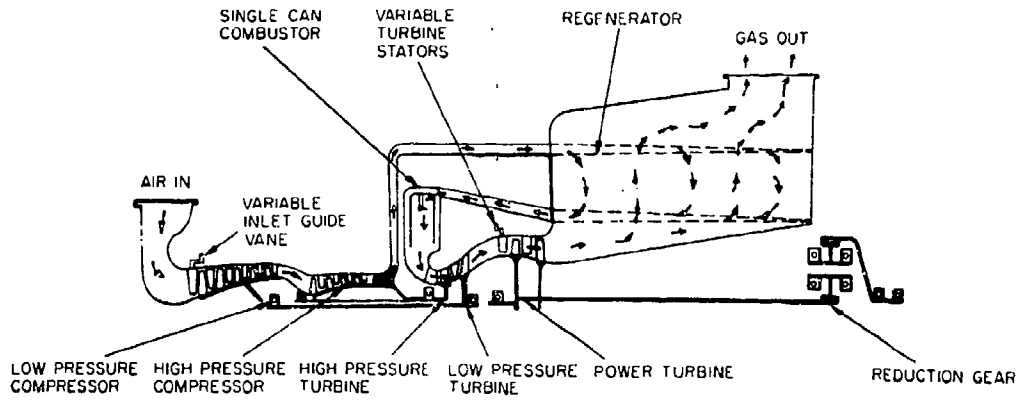

Figure 1-22. MBT70 Prototype Tank, Gas Turbine Engine Airflow Schematic Diagram (Ref. 6) (From Automotive Engineering, Release Granted by Society of Automotive Engineers, Inc.)

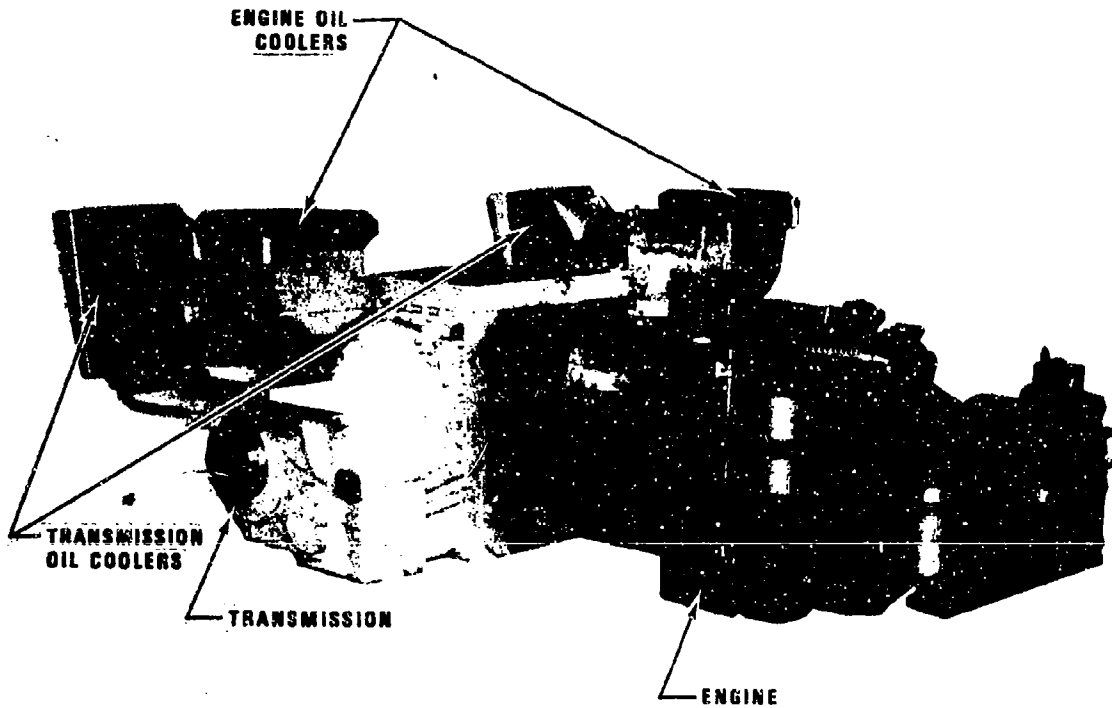

Figure 1-23. MBT70 Prototype Tank Gas Turbine Engine Power Plant Removed from Vehicle (USATACOM)

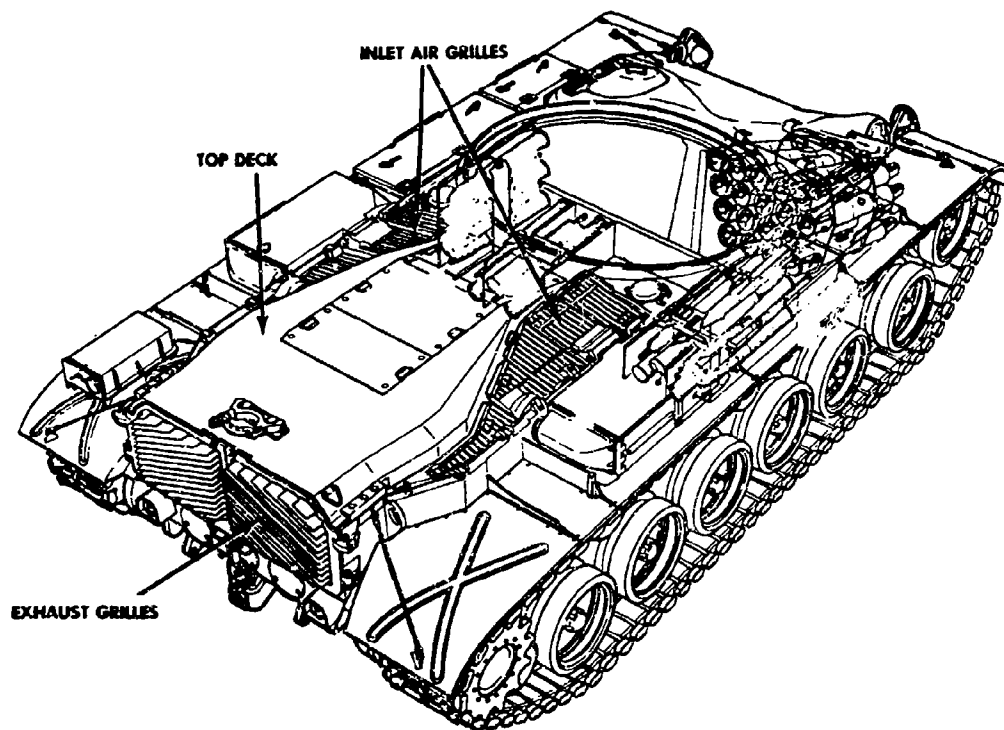

Figure 1-24. Tank, M60 Series, Cooling Air Inlet and Exhaust Grilles

flow fans that draw air through the cylinder fins and oil-coolers and discharge the hot air vertically from the shroud. Sheet metal baffles and deflectors direct the flow of cooling air across the cylinders as shown in Fig. 1-25. The engine and transmission are separated by shroud plates attached at the rear of the engine. The cooling fans are attached to hubs and mounted on shafts that are driven by the engine through a mechanical clutch assembly (see Fig. 1-26). The fan clutch is oil-cooled and is designed to slip under deep-water fording conditions where the resistance of the water exceeds the friction of the centrifugally loaded clutch drive members.

The power package is a unit cooled system where two engine oil coolers and two

transmission oil coolers are mounted on the sides of the engine above the cylinders. The two engine cooling fans draw air through the oil-cooler cores to cool the oil being circulated within the coolers (see Fig. 1-25).

Fig. 1-27 shows the AVDS-1790 Engine removed from the vehicle and Fig. 1-28 shows a cross-sectional view of the engine cylinder with cooling fins.

1-3.3.2 Liquid-cooled Combat Vehicles

1-3.3.2.1 Armored Reconnaissance Airborne/ Assault Vehicle, Full-tracked, M551 (SHERIDAN)

The M551, Fig. 1-29, represents a typical liquid-cooled power package installation in a

AMCP 706-361

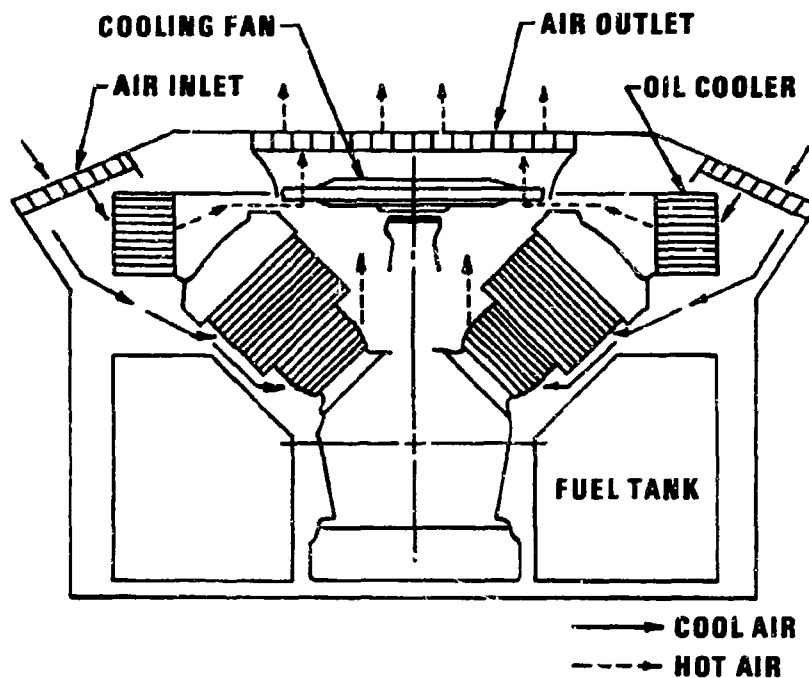

NOTE: Unit cooled system. System airflow is balanced to provide cylinder, engine oil, and transmission oil cooling. (Transmission oil coolers are located to the rear of the engine oil coolers.)

Figure 1-25. AVDS-1790 Engine Cooling Airflow as Installed in M60 Tank

tracked vehicle. Fig. 1-30 illustrates the complete Model 6V53T engine power package assembly.

The power package installation draws cooling air through the inlet grilles and radiator into the engine compartment. The air exits through the exhaust grilles as shown in Fig. 1-31. The recirculation baffle shown in Fig. 1-31 is not part of the standard vehicle. This modification was evaluated but never released for the vehicle. The installation of the baffle resulted in a 3 deg F coolant temperature reduction. The engine exhaust is directed vertically upward from the rear of the engine compartment. The radiator shrouding incorporates seals to separate the air inlet

and air discharge sides of the engine compartment. The inlet and exhaust grille arrangement is shown in Fig. 1-32. The engine coolant system is shown in Fig. 1-33.

1-3.3.2.2 Howitzer, Medium, Self-propelled, 155 mm, M109

The M109 is a full-tracked aluminum-armored vehicle mounting a 155 mm Howitzer. The vehicle is powered by a Model 8V71T, eight cylinder, turbocharged, compression ignition engine. A schematic diagram of the vehicle cooling system is shown in Fig. 1-34.

The engine is mounted transversely adja-

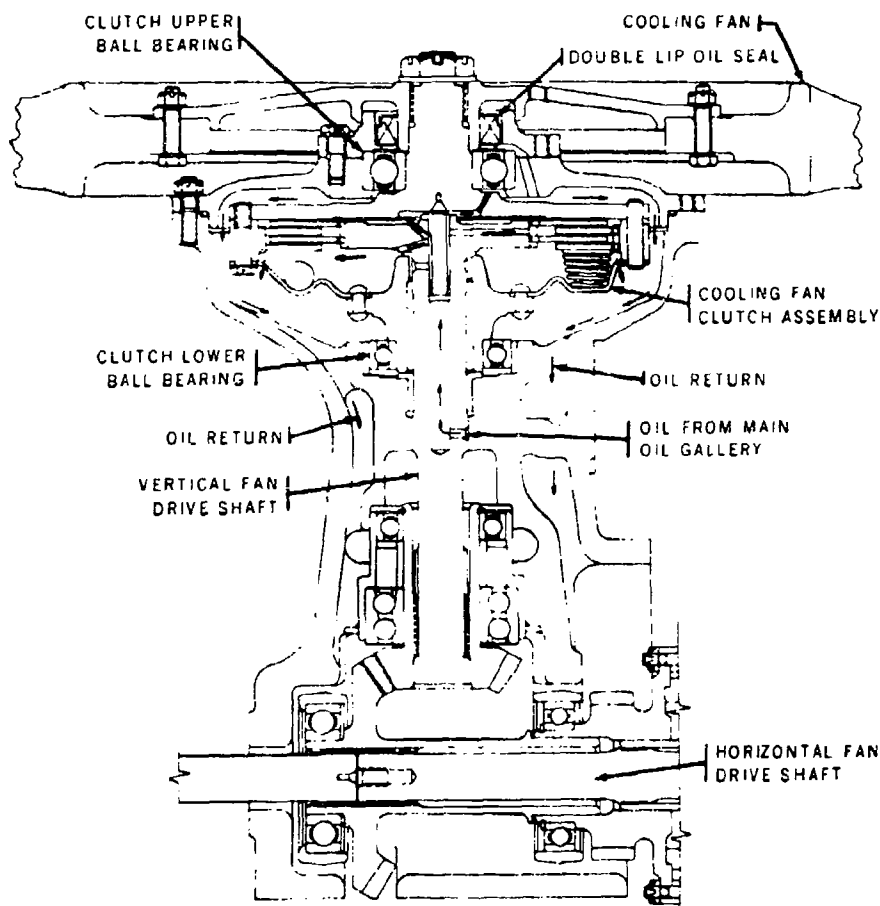

Figure 1-26. Mechanical Cooling Fan Drive Clutch

cent to the transmission. Cooling air is drawn through the intake grilles by two gear driven fans. The fans draw the air through the radiator across the engine and out the exhaust grilles.

The thermostat housing assembly for this cooling system is mounted externally from the engine, requiring additional piping and coolant connections.

1-4 SPECIAL MILITARY CONSIDERATIONS

1-4.1 SEVERITY OF MILITARY USAGE

Military vehicles are exposed to extreme environmental conditions and are required to survive with no severe impairment of their operation. The military vehicle and its components must be designed to perform

AMCP 706-361

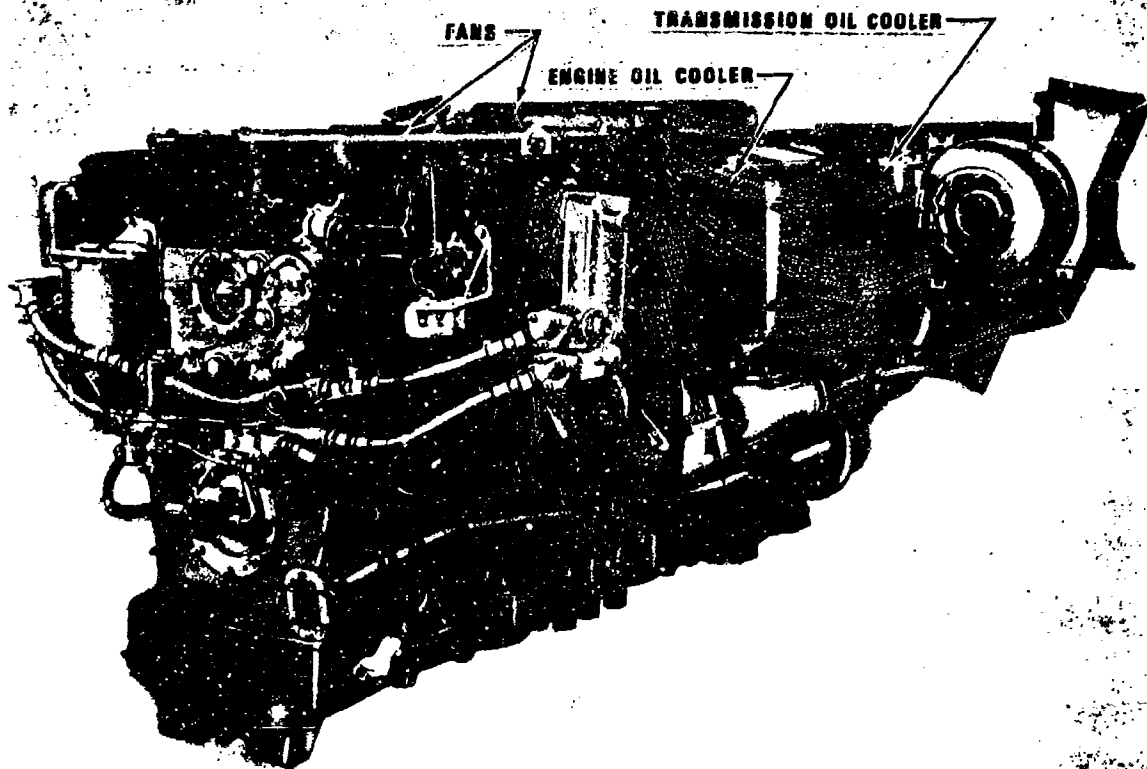

Figure 1-27. AVDS-1790 Engine for the M60 Tank

satisfactorily under all conditions of combat operation. They are required to have the full design capacity of operation in all types of weather and climatic conditions, and must possess a high degree of off-the-road mobility on all types of unfavorable terrain. Many vehicles also have fording or amphibious requirements specified. They must be capable of withstanding extreme vibrations, shocks, and violent twisting experienced during cross-country travel over difficult terrain. They must be able to operate for long periods with very little or no maintenance. Additional military requirements necessitate that the vehicles be of minimum size and weight to facilitate airborne operations. They must be designed to withstand human abuse caused by such factors as overload, misuse, improper maintenance, lack of maintenance, and neglect which make the design task extremely difficult.

Additionally, all military materiel must be capable of safe storage and transportation without permanent impairment of its capabilities from the effects caused by these conditions. All materials specified must be examined for shelf life, preservation requirements, surface treatment required, and suitability for the expected environmental extremes.

A compilation of quantitative data on shocks and vibrations normally experienced by military vehicles during various operating conditions is shown in Table 1-3. The values given are presented only as a guide to give the designer general information regarding vehicle shock characteristics. The latest applicable AR's should be referred to for latest available information.

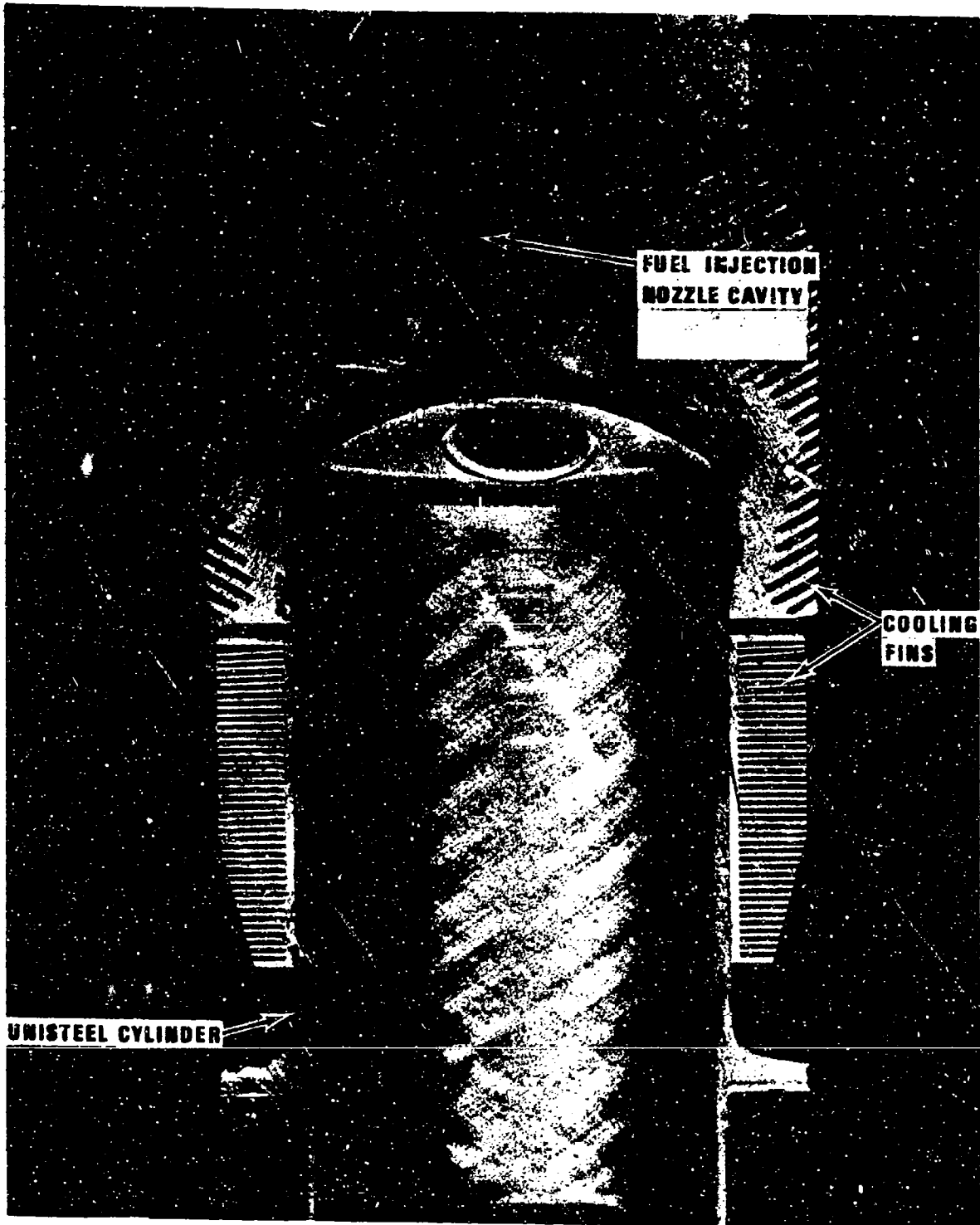

Figure 1-28. AVDS-1790 Engine Cylinder Cross Section

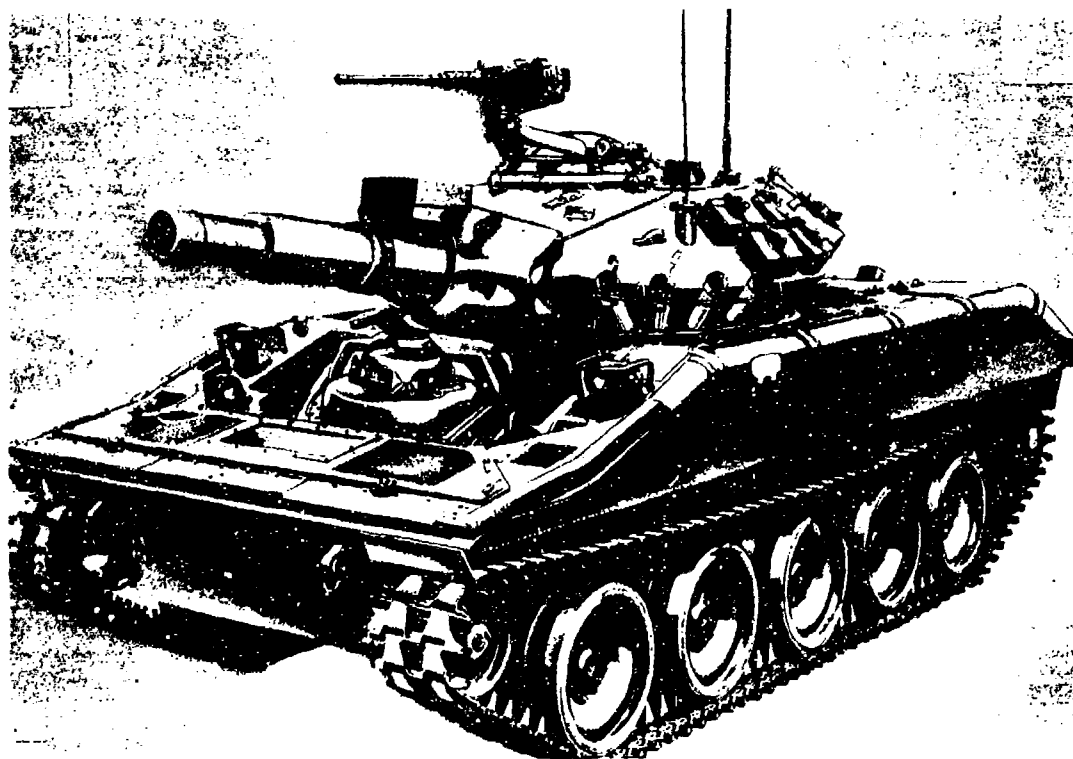

Figure 1-29. Armored Reconnaissance/Airborne Assault Vehicle, M551, Full-tracked (SHERIDAN) (Ref. 13)

1-4.1.1 Cross-country Operation

Cross-country operation requires that military vehicles traverse terrain having equivalents of obstacles such as vertical walls, trenches, and ditches; soil compositions ranging from hard-packed soil to sand, mud, swamp, and marsh; and fore and aft grades of up to 60 percent with side slopes to 40 percent. Vehicle cooling system designs must be compatible with the cooling loads required under these conditions. The power necessary under these conditions requires the maximum engine power output at minimum speeds. These characteristics impose maximum cooling system loads.

1-4.1.1.1 High Impact Loadings

et loads such as those imposed

during rail shipment, air-drop, or ballistic impact of vehicles should be considered in the design of the cooling system. The test procedures established the MIL-STD-810 specify impact tests with railroad car speeds of 8, 9, and 10 mph. The equipment is impacted twice in each direction of equipment orientation at each of the specified speeds.

The off-road/cross-country operation of military vehicles results in high stress and load conditions on all vehicle components. The vehicle speeds under these operating conditions normally are limited only to the maximum speed that can be tolerated by the operator.

Table 1-4 indicates typical mobility limiting characteristics determined from Carrier, Command and Reconnaissance, Armored.

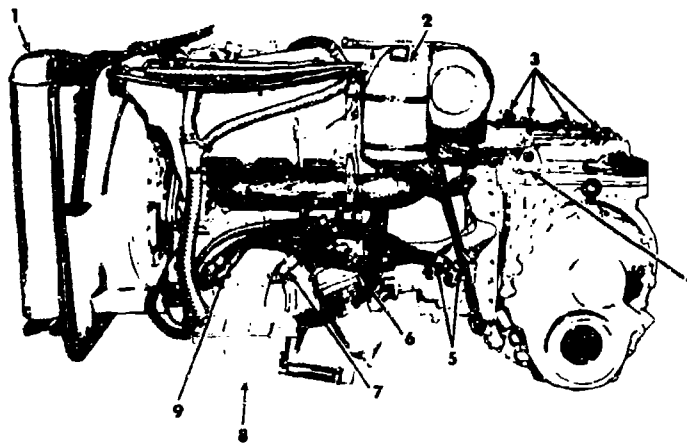

LEFT SIDE - REFERENCE

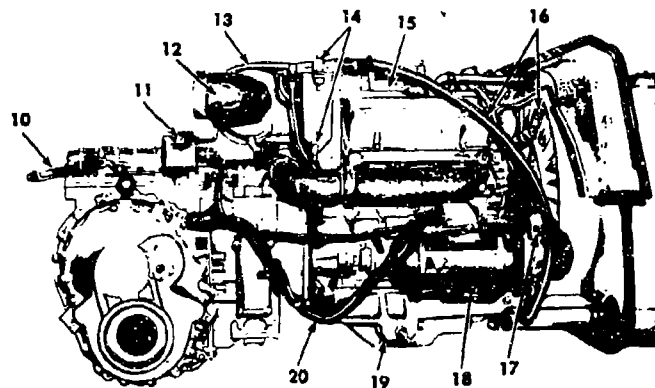

RIGHT SIDE - REFERENCE

LEGEND

- | | |
|---|---|
| 1. COOLANT SYSTEM | 12. EXHAUST ELBOW, CROSSOVER, AND MANIFOLD INSULATION |
| 2. TACHOMETER GENERATOR (HIDDEN) | 13. THROTTLE ROD |
| 3. TRANSMISSION THROTTLE, SHIFT, LAND, AND WATER STEER LEVERS | 14. FUEL DISCONNECT, ELBOWS, AND DRAINCOCK |
| 4. POWER PLANT HARNESS AND BRACKET | 15. FUEL SHUTOFF CONTROLS |
| 5. TRANSMISSION OIL PRESSURE AND TEMPERATURE SWITCHES | 16. WINTERIZATION HOSES AND FITTINGS (IF INSTALLED) |
| 6. ENGINE OIL PRESSURE SWITCH | 17. "V" BELT TENSIONER |
| 7. OIL COOLER ELBOWS | 18. GENERATOR AND BRACKET |
| 8. AIR BOX DRAIN COLLECTOR | 19. ENGINE MOUNTS |
| 9. FUEL RETURN HOSE AND FITTINGS | 20. GENERATOR AND STARTER HARNESS |
| 10. BRAKE CONTROLS | |
| 11. STARTER RELAY AND BRACKET | |

Figure 1-30. SHERIDAN, M551, Power Plant - Complete (Ref. 13)

AMCP 708-361

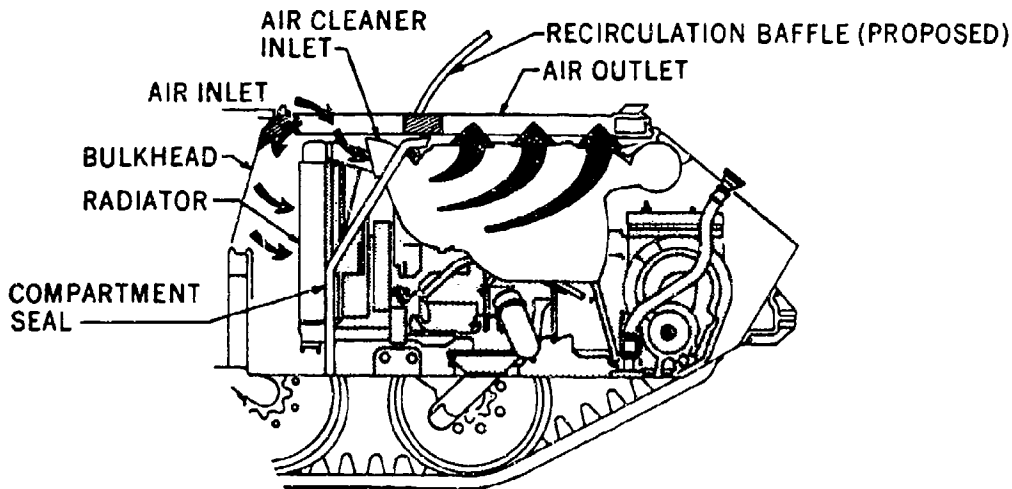

Figure 1-31. SHERIDAN, M551, Power Package Airflow (Yuma Proving Ground)

M114, tests at Yuma Proving Ground, Yuma, Arizona. Under these conditions, high impact loads are encountered which are dependent on the terrain characteristics. Fig. 1-35 is a representative terrain profile used to evaluate durability and reliability of vehicles under cross-country operation. The figure is representative of the Perryman Cross-country Course No. 4 at Aberdeen Proving Ground, Maryland.

1-4.1.1.2 Terrain Characteristics

Off-highway terrain characteristics impose additional design constraints for the vehicle and cooling system components. The more severe areas of travel will include longitudinal slopes with grades to 60 percent, and side slopes to 40 percent, hogbacks, ditches, racks, embankments, random log obstacles, brush, tree stumps, dust, and mud. Most vehicles have requirements for towing trailers, weapons, and for off-highway recovery operations that impose extremely high cooling system loads. Vulnerable cooling system components must be protected by splash pans, brush guards, and rock shields as required. Location

of air inlet and outlet grilles must be considered carefully to prevent debris from blocking the grilles, radiators, fins, or heat exchangers. Figs. 1-36 and 1-37 illustrate typical conditions encountered during off-highway operations. During a vehicle test and evaluation program, problem areas are defined and design modifications are incorporated to minimize these difficulties. A typical modification evaluated on the SHERIDAN M551 Vehicle is the debris deflector (Fig. 1-38). This device was tested but not released for field use.

1-4.1.2 Environmental Extremes for Worldwide Usage

The vehicle—configured with all its equipment—must be capable of performing all appropriate and intended missions, tasks, and functions under the conditions specified in climatic Categories 1 through 6 of Table 1-2 without the use of aids in kit form. The power plant cooling system should be designed to provide cooling for normal vehicle operation in ambient air temperatures up to and including 125°F. With the use of aids in

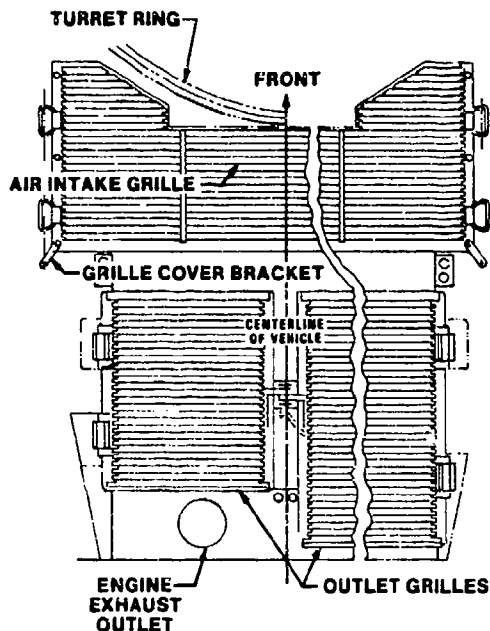

Figure 1-32. SHERIDAN, M551,
 Cooling System Grilles (Ref. 13)

kit form, the vehicle must perform all appropriate and intended missions, tasks, and functions under the climatic conditions specified in Categories 7 and 8 of Table 1-2.

It should perhaps be noted that AR 70-38 allows for meeting the "hot-dry" climate (125°F) by use of modification kits. This generally has not been the practice for cooling system design. Past experience with efforts to correct cooling system overheating problems would indicate that such an approach would have many pitfalls. Changing one part of the system, such as a larger radiator for example, will not be successful if the most critical heat transfer point is elsewhere in the system. It is believed that in general the kit approach would not be economical because of the many cooling system components that would be affected.

Environmental extremes produce various temperature effects on components. High

temperature effects are permanent set of packings, hardening of seals and gaskets, and binding of parts due to differential expansion of dissimilar metals. Rubber and plastics may tend to discolor, crack, bulge, check, or craze. Closure and sealing strips may partially melt and adhere to contacting parts. Low temperature effects similarly cause differential contraction of metal parts, loss of resiliency of packing and gaskets, and congealing of lubricants.

High altitude ground operation specifications vary. Altitudes up to 14,000 ft have been specified for certain vehicles. There is the need for the vehicle to be able to perform its function at the specified altitude although at a reduced level of performance. At high altitude, the cooling system power requirements remain nearly the same while the lower temperature (ambient) reduces the cooling capacity required.

A temperature vs altitude chart is contained in Table 1-5. It should be noted that there is a decrease in temperature as the altitude increases within the atmosphere.

A warm water environment for amphibious vehicles could be of significance for vehicles with keel coolers. MIL-STD-210 (Ref. 14) calls for 95°F maximum water surface temperature. Cooling system designs should consider this requirement.

Solar radiation will contribute additional heat loads to the vehicle cooling and air conditioning systems. Solar radiation also causes heating of equipment and photodegradation such as fading of colors, checking of paints, and deterioration of natural rubber and plastics.

Humidity produces corrosion of metals which will increase the fouling factor on heat transfer surfaces. Absorption of moisture by insulating materials may result in degradation of their electrical and thermal properties.

AMCP 708-381

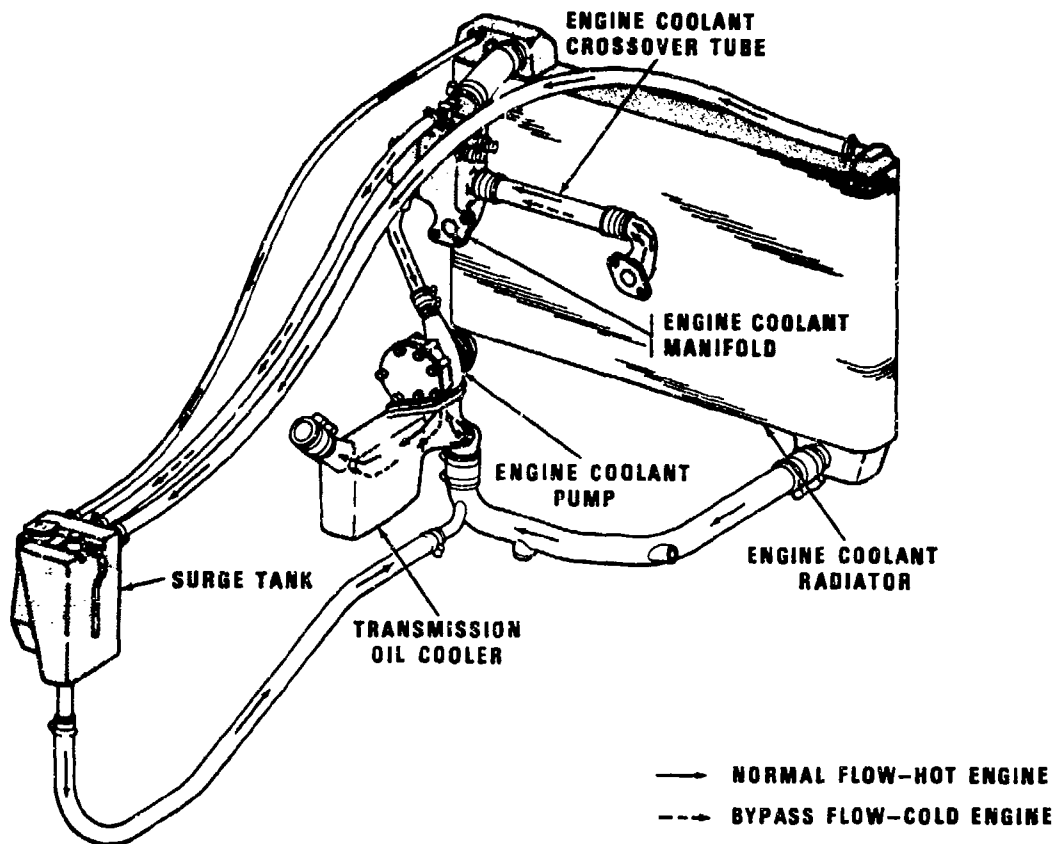

Figure 1-33. SHERIDAN, M551, Coolant System (Ref. 13)

1-4.1.3 Heavy Armament Firing Impact Loads

The effects of heavy armament firing impact loads on the power package/cooling system assembly cannot be calculated readily. It often requires elaborate measurement procedures for complete evaluation. The power package/cooling system is a contributor to the complex vibrations of the vehicle. It is also acted upon by shocks and vibrations experienced and/or generated by the vehicle, the vehicle armament, and the powered equipment within the vehicle. In addition to the structural design characteristics of the cooling system components, attention must be given to the deflections caused by heavy

armament firing. Adequate fan-to-radiator and/or shrouding clearance must be provided along with secure support for coolant lines, hoses, and related components.

Representative shock and vibration data recorded in actual firing tests are shown in Table 1-3. The values given are presented only as a guide to give the designer general information regarding vehicle shock characteristics. They should not be interpreted as being maximum values nor the only values that can occur.

Gun recoil loads transmitted externally to the vehicle can be obtained by calculations made according to procedures outlined in

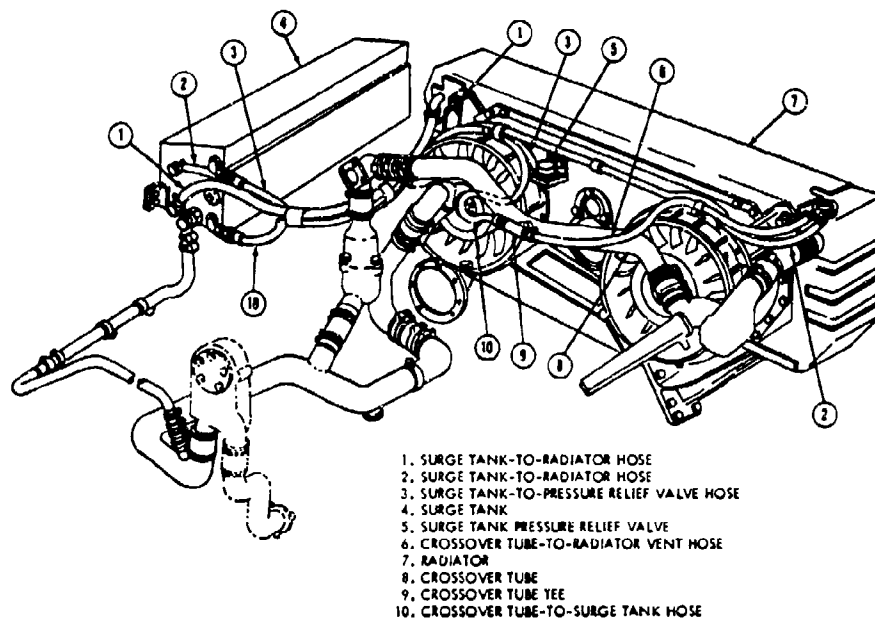

Figure 1-34. Howitzer, M109, Cooling System Schematic Diagram (Ref. 7)

AMCP 706-342, *Recoil Systems* or AMCP 706-356, *Automotive Suspensions* (Refs. 15 and 16).

1-4.1.4 Lack of Maintenance

Lack of maintenance is one of the detrimental characteristics leading to early failure of equipment. Lack of maintenance usually occurs for reasons such as:

1. Repair parts not available
2. Unscheduled maintenance requirements
3. The inability to determine that an impending problem exists
4. When mission requirements preclude maintenance actions (battle conditions).

In order to decrease the maintenance time required for component/assemblies, careful consideration should be given to maintainabil-

ity. Ease of maintenance and modular replacement component/assemblies are prime considerations in cooling system designs. General information on maintenance can be obtained from AMCP 706-134 (Ref. 26).

1-4.1.5 Operation by Military Personnel

It is vitally important for the design engineer to consider the skills required and the personnel available to operate and maintain the equipment he designs. Equipment cannot be successfully maintained if it requires skill levels higher than those available. If the maintenance skill level required or time needed for a specific task is in excess of that available, the equipment becomes a liability instead of an asset because it is no longer available to perform its intended mission. Since it is difficult to obtain and retain skilled military maintenance personnel, every effort must be expended by the designer to build-in maintenance features that minimize the requirements for highly skilled

AMCP 706-361

TABLE 1-3
SHOCK AND VIBRATION DATA (Ref. 45)

Type of Operation	Part of Vehicle Considered	Shock (Accel, g)	VIBRATION					
			Vertical		Longitudinal		Transverse	
			g	Hz	g	Hz	g	Hz
High Speed on Hard Pavement	Hull		4	500	3.8	500	2.3	520
	Instr. Panel		2.6	300	1.8	400	2	350
	Eng. Mount.		12.5	450	15	900	14.1	650
	Generator		10.3	650	18.7	700	18	800
Medium Speed Off-the-road	Hull		2.3	540	2	520	0.6	430
	Instr. Panel		1.2	120	1.3	120	0.9	120
	Eng. Mount.		11.4	500	18.7	900	11.3	850
	Generator		8	650	10	700	25.4	900
Low Speed Rough Terrain	Hull	8	5	500	10.8	850	13	700
	Instr. Panel		11	550	10	750	14	900
	Eng. Mount.		9.4	300	3.6	350		
	Generator				5.4	10	2.5	400
	Axle (Semitrailer)		36.4	150	21.9	400	12.2	100
	Fifth Wheel Plate		14.5	100	4.8	250	2.8	30
	Cargo Bed Above Fifth Wheel Cargo Bed Above Axle (Semitrailer)		3	3			0.8 0.4	16 90
Side Wall of Van Semitrailer		2.4	20			3.3	400	
Shipment by Truck	Vehicle Assembly	8	2	300	2	300	2	300
Shipment by Rail	Vehicle Assembly	20	2	70	2	70	2	70
Shipment by Fixed- wing Aircraft	Vehicle Assembly							
	Fwd	9			5	300	5	300
	Side	1.5					0.25	10
Shipment by Rotary- wing Aircraft	Vert (up)	3	5	300				
	Aft	1.5	0.5	10				
Shipment by Parachute	Vehicle Assembly							
	Fwd	4						
	Side	1.5						
	Vert (up)	2						
Ballistic Impact	Aft	2						
	Vehicle Assembly	16						
Ballistic Impact	Turret	20(0.75in. amp)	50	1000			140	600
HE Blast	Turret and Hull	25(1.0in. amp)						

NOTE: The values given are presented as a guide only.
 Check applicable AR's for latest available information.

TABLE 1-4

**SUMMARY OF MOBILITY OPERATION OF THE CARRIER, COMMAND AND RECONNAISSANCE,
 ARMORED, M114A1, VEHICLE AT YUMA PROVING GROUND, YUMA, ARIZONA**

<u>Course Terrain</u>	<u>Speed Limiting Factor</u>	<u>Average Speed, mph</u>
Dry wash (with)	Power	18.0
Dry wash (across)	Ride quality	8.3
Desert pavement	Ride quality	20.9
Stony desert	Ride quality	8.3
Hilly cross-country	Power	12.9
Level cross-country	Ride quality	13.1
Gravel (Winding)	Course (Roadability)	26.2
Paved	Power	35.3
Level sand	Power	12.9
Hummocky sand	Ride quality	15.3

technicians to perform maintenance. It follows that as the complexity of equipment increases, the time required to train the operator and maintenance specialist also increases.

1-4.1.6 Air-drop/Transportability Capabilities

In the past, air-drop and/or air-transportation requirements usually were given consideration after completion of a design and fabrication of test prototypes. The item was adapted to the air-drop environment by utilizing available provisions and structural members. Occasionally, the basic design was such that suitable modifications could not be accomplished, and the item was determined incapable of being air-dropped. Only a limited number of vehicle types are now required to have an air-drop capability, however, most

have the air-transportability requirement. Due to the large quantities of supplies and equipment requiring delivery by aircraft, the old method of adapting an item to air-transport and/or air-drop after the design was completed is no longer adequate. It is necessary that the capability for air-transport and/or air-drop be incorporated into the basic design of materiel having these requirements.

Material developed for transport in Air Force aircraft must meet all limitations imposed by the individual characteristics of the aircraft. MIL-A-8421 (USAF), *Air Transportability Requirements*, defines the aerial specifications for air-transportability of materiel (Ref. 17). These requirements must be considered in the overall cooling system design. The cooling system and its components must be able to withstand the

AMCP 706-381

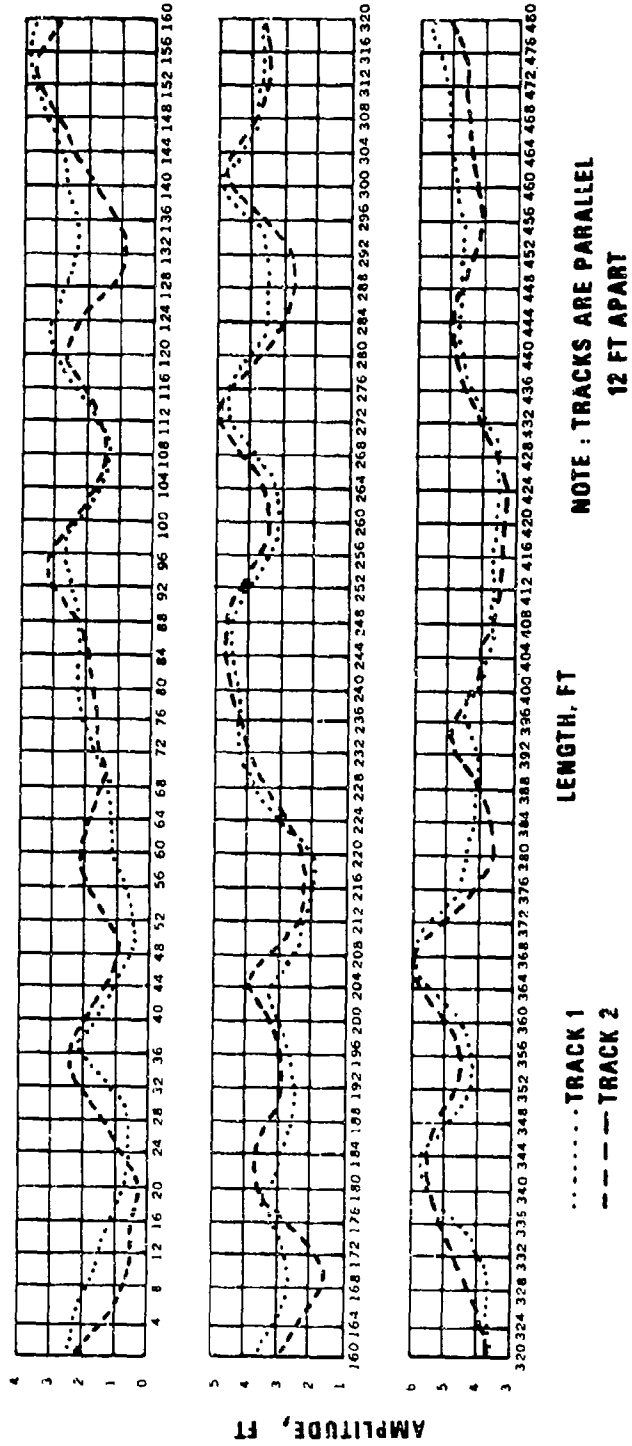

Figure 1-35. Typical Contour of Perryman Cross-country Course No. 4 at 1-ft Intervals
 (Amplitude Plotted to Nearest 0.1 ft.) (Ref. 41)



Figure 1-35. Typical Dust Conditions Encountered During Off-highway Operation

environments of the air-drop and/or transport and still be capable of immediate, effective deployment.

Factors to be considered in designing for air-drop and/or air-transport are altitude, low temperature, temperature extremes, vibration, shock, and combined factors of temperature, humidity, and altitude. The aircraft to be used dictates the overall vehicle dimension limitations. Provisions for slings and tie-downs must be located in a manner to prevent radiation cooling system component damage.

Design considerations for the reduced atmospheric pressure at altitude should include effects such as leakage of fluids from

gasket-sealed enclosures and rupture of pressurized containers. Under low pressure conditions, low density materials change their physical and chemical properties. Damage due to low pressure may be augmented or accelerated by contraction or embrittlement of the cooling system components, and fluid congealing induced by low temperature.

Low temperatures at high altitudes cause differential contraction of metal parts, loss of resiliency of packing and gaskets, and congealing of lubricants. In addition, a temperature shock may occur during air shipments and air-drops caused by the extreme changes in temperature of the surrounding atmosphere. Cracking and rupture of materials due to dimensional changes

AMCP 706-361



Figure 1-37. Deep Mud Encountered in Off-highway Operations

by expansion or contraction are the primary difficulties to be anticipated.

Additional information is available from MIL-STD-669 (Ref. 18) and AMCP 706-130, *Design for Air Transport and Airdrop of Materiel* (Ref. 19).

1 4.1.7 Design for Shock and Vibration

Automotive assemblies are subjected constantly to a complex system of forces whose magnitude and orientation vary with time. This complex force system is comprised of forces that fall into one of two general categories:

1. *Determinate Forces.* Those forces that can be readily determined by computation and simple measurement

2. *Indeterminate Forces.* Those forces that cannot be calculated readily and require elaborate measuring procedures, complex equipment, and sophisticated mathematical

techniques for their evaluation.

Typical determinate forces are those imposed by the weight of the various components and contents of the vehicle, those forces due to acceleration of the vehicle, and those due to characteristics such as engine torque.

Examples of indeterminate forces are those resulting from shock and vibration. These are encountered when the vehicle is traveling over rough terrain, air-dropped, during rail shipment, or when subjected to high energy blast or ballistic impact. A rigorous method for evaluating the indeterminate forces during the design phase, and correctly relating them to the stresses experienced by the vehicle, is not known at present. The method generally employed by designers is to determine the acceleration produced by the shock force, and express this as a multiple of g , the acceleration due to gravity. This number is then applied as a multiplying factor to the mass under consideration to determine the

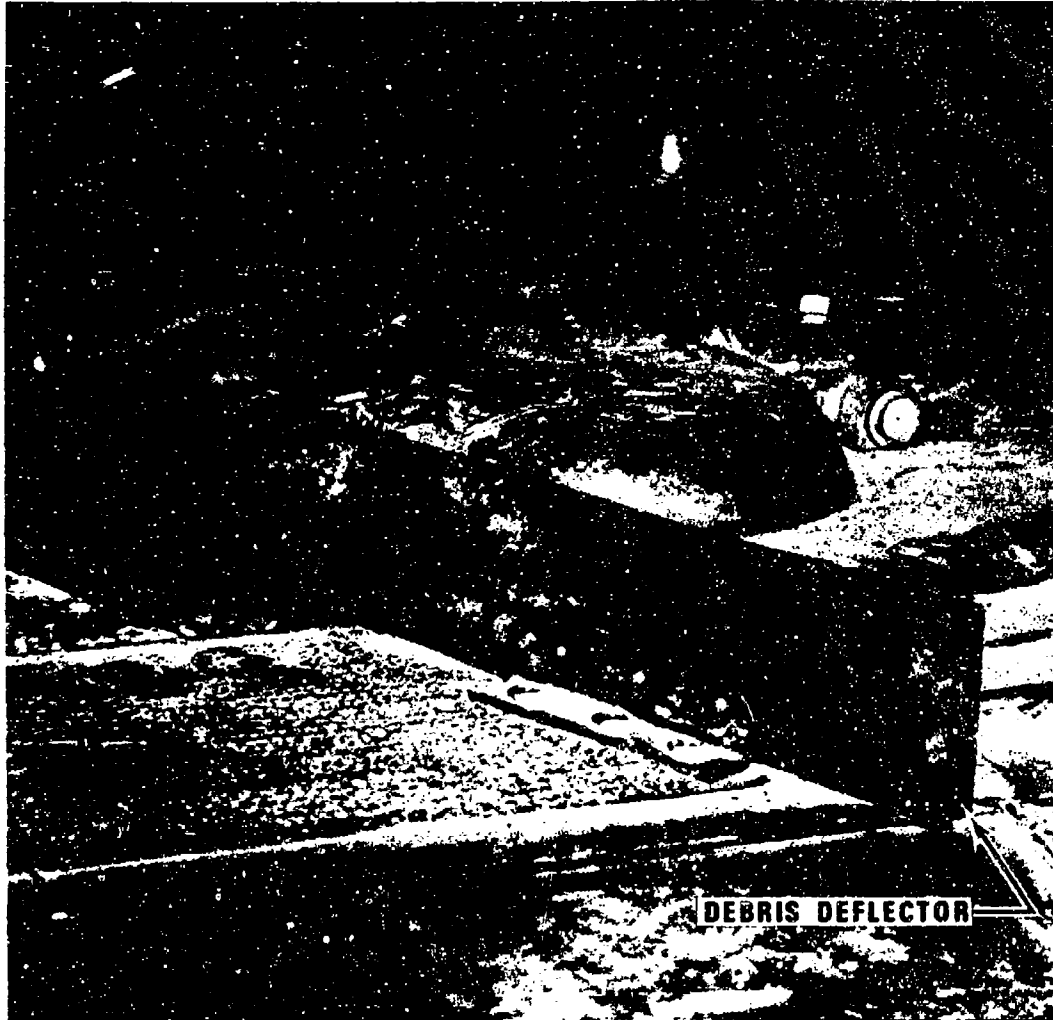

Figure 1-38. SHERIDAN, M551, Debris Deflector (Yuma Proving Ground)

magnitude of the shock force experienced by the member. The procedure of using the g -multiple of the peak acceleration in determining the magnitude of the shock forces is a popular, but technically unsound, method. It results in vehicles capable of safely withstanding sustained loads many times greater than those normally experienced by the vehicle. This practice tends to produce overdesigned vehicles with their attendant excess weight and cost.

An automotive vehicle experiences certain effects as a result of shocks and vibrations which usually are overlooked by the designer. It is only after field trials reveal deficiencies in the design that corrective modifications are made. Even then it is often not apparent, therefore not realized, that the failure or malfunction is directly attributable to vibration or shock loading and could have been prevented had the designer been cognizant of the effects of vibration upon the vehicle

AMCP 706-381

TABLE 1-5
TEMPERATURE vs ALTITUDE

Altitude, ft	Temperature, °F
0	59.0
1000	55.4
2000	51.9
3000	48.3
4000	44.7
5000	41.2
6000	37.6
7000	34.0
8000	30.5
9000	26.9
10000	23.3
11000	19.8
12000	16.2
13000	12.6
14000	9.1
15000	5.5

components. The most familiar effects of shock and vibration loadings are in their ability to produce structural failures, occasioned by the actual rupture or breaking of the structural material, or by producing such severe deflections in members as to strain them beyond their elastic limits and cause them to malfunction or to become otherwise unsatisfactory due to permanent structural deformation.

The design of radiators must consider the effects of shock and vibration encountered in

actual operating conditions. See MIL-STD-810, *Environmental Test Methods*, (Ref. 21), and MIL-R-45306 (Ref. 20).

1-4.2 BALLISTIC PROTECTION

1-4.2.1 Necessity for Ballistic Protection

Ballistic protection is provided for power plant assemblies on all combat vehicles. The requirement for this protection is mandatory to permit the vehicles to fulfill their intended missions.

Combat vehicle power package installations normally are shielded by the vehicle armor, however, the cooling air inlet, engine exhaust, and cooling air exit areas must be provided with ballistic grilles. These grilles must be capable of providing the required level of protection while offering minimum restriction to the air flow. The location of these grilles also must provide for minimum entry of debris.

Fig. 1-39 shows the effects of battle damage on the air inlet grilles of the Tank, Combat, Full Tracked, 90 mm Gun, M48. Although badly damaged, the grilles still provided adequate protection of the power package to permit the vehicle to complete its mission.

Fig. 1-40 illustrates debris that accumulated in the engine compartment of an M48 Tank during the performance of a typical mission. This debris, plus ingested dust and dirt, caused the plugging of the engine oil cooler as shown in Fig. 1-41. These illustrations serve to emphasize the importance of careful considerations of the hostile environment in which the combat vehicle power plant cooling system operates.

1-4.2.2 Ballistic Grilles and Their Impact on Cooling Airflow

Ballistic grilles serve to promote protection for the vehicle power package and related

AMCP 706-361



Figure 1-39. Air Inlet Grille Battle Damage, Tank, M48

AMCP 706-361



Figure 1-40. Debris Found in Tank, M48, Engine Compartment

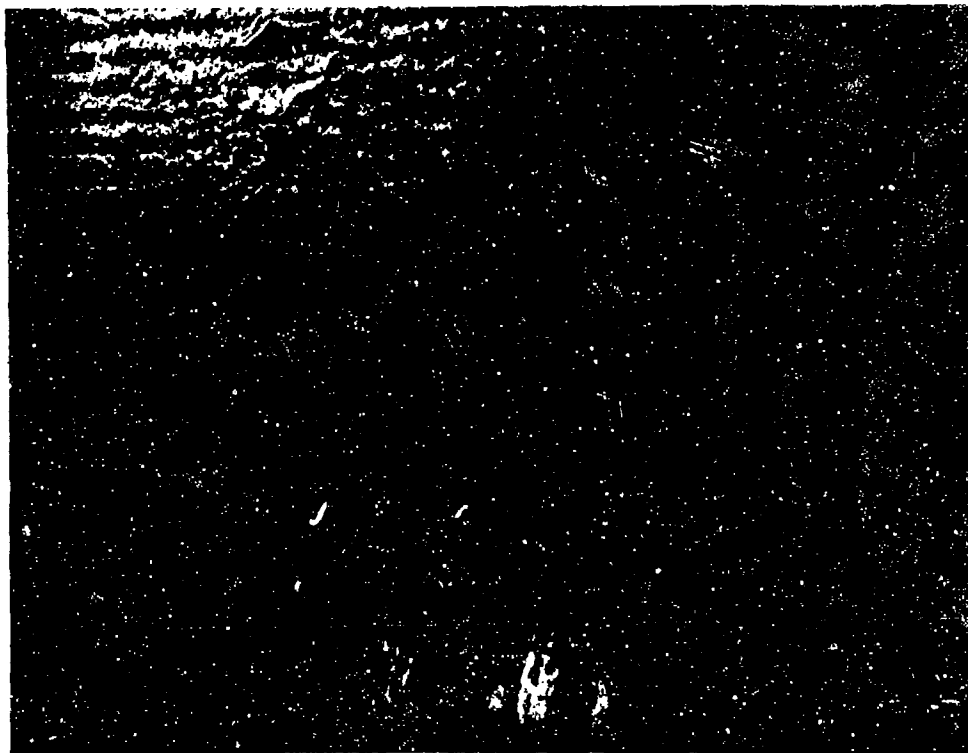

Figure 1-41. Engine Oil Cooler Plugging on Tank, M48

components—such as hoses, lines, radiators or heat exchangers, and accessories—against projectiles, bullet splash, and fragments. The grilles also provide inlet air passages for power package cooling air and engine induction air. Passages for cooling air and the engine exhaust products also are covered by ballistic grilles. The grille functions of protection and minimum restriction to airflow are not compatible, since the larger the passages for air entrance, the easier it becomes for fragments to enter the engine compartment. As a consequence, many grille designs have been developed in an attempt to satisfy the requirements for maximum protection against attack and minimum airflow restriction. Fig. 1-42 illustrates typical grille configurations that have been evaluated. From the vehicle

design viewpoint, both the weight of the grilles and the area required for airflow become important. For information on the design of grilles refer to AMCP 706-357 (Ref. 22).

1-4.2.3 Impact of Ballistic Requirements on Cooling System Design

The restriction to airflow caused by ballistic grilles imposes additional power requirements on the cooling fan. The grilles impose resistance to airflow, and a pressure drop occurs that results in a reduction of airflow. To overcome the air pressure drop and decreased flow, sufficient cooling fan capacity with the accompanying increased power requirement is necessary. Pressure

AMCP 706-361

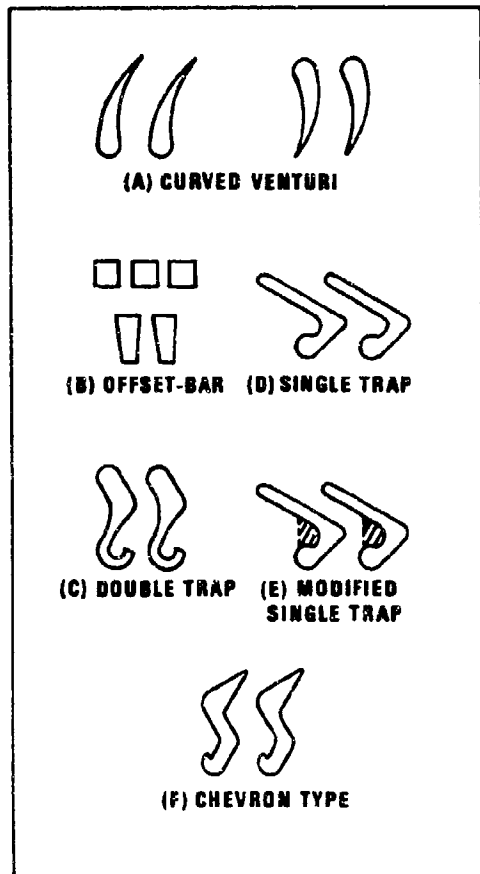

Figure 1-42. Cross Section of Various Ballistic Grille Configurations

drops incurred in both the inlet and discharge air grilles must be considered in cooling system designs. Chapter 6 discusses grille design and airflow characteristics.

1-4.3 TACTICAL EMPLOYMENT OF COMBAT VEHICLES

1-4.3.1 Tank-Infantry Teams

Some military operations require tanks and dismounted infantry to work together as a team (Ref. 23) and operate sufficiently close

together to provide mutual support. The infantry may move between tanks, or immediately in the rear of them. As the advance progresses, the relative positions of tanks and infantry are adjusted according to the enemy resistance and the terrain. This permits close coordination and maximum mutual support, but sacrifices speed. This low speed operation may create problems in the vehicle cooling system and the location where the cooling air exhausts may be an important consideration. The designer should be aware of this type of operation and take into consideration the effects of prolonged operation at very low speeds when designing the cooling system, as well as design considerations for operations requiring heavy duty cycles.

1-4.3.2 Use of Top Deck for Carrying Personnel

The use to which military vehicles are subjected under combat conditions is limited only by the situation at hand and, as a result, initial design considerations should include a review of as many of these situations as possible. It is common for infantry personnel to ride on vehicle top decks, in addition to carrying miscellaneous gear, especially during troop maneuvering in a combat zone. This should be considered when designing for the placement and airflow direction of grilles.

1-4.4 RELIABILITY AND DURABILITY

1-4.4.1 Importance of Reliability and Durability in Military Operations

Reliability, a fundamental characteristic of materiel and equipment, is of major consequence in military usage. It is expressed as the probability that materiel and equipment will perform their intended functions for a specified period under stated operating conditions. Just a few years ago, reliability requirements seldom were included in design specifications. Today, this quantitative prop-

erty of machines and systems increasingly is included in Military Specifications along with explicitly stated acceptance criteria, test conditions, and evaluation data. Progress also has been made in reliability improvement, particularly in component parts where failure rate reduction, in the early hours of part life, has been reduced in many cases by factors of 10 to 20. These reliability gains, however, have not always kept pace with the increase in system complexity. If current trends continue, a substantial design breakthrough will be required merely to keep pace with the increase in system complexity. It appears that the trend in system complexity is still increasing, and no product can be assumed to be 100 percent reliable.

Reliability for a system, made up of a number of independent components, is the product of the individual reliabilities. For example, an assembly consisting of three components, each having a reliability of 90 percent, will have an overall reliability of only 72.9 percent (0.90^3). Similarly, 100 components, each with a 99 percent reliability, will have an overall reliability of 36.6 percent, i.e., 0.99^{100} . From this relationship, the difficulty of obtaining a high degree of reliability with highly complex systems is apparent.

Durability is defined as the ability of a component, subsystem, or system, to render satisfactory performance over an extended period of continuous operation under the service conditions for which it was designed.

Test requirements have been established to evaluate the reliability and durability of military vehicles and are shown in Tables 1-6 and 1-7.

1-4.4.2 Importance of Cooling System in Overall Reliability

The design of the cooling system for a military vehicle is governed by restrictions that limit and control features of the complete power package assembly. These

limits affect dimensional as well as functional characteristics. However, the reliability of the cooling system/power package assembly must not be compromised if the vehicle is to perform its intended missions. Reliability requirements must be considered to permit the cooling system to function under the following applicable characteristics of the military environment:

1. High shock and vibration
2. Extreme temperature ranges
3. Operation in:
 - a. Extreme dust
 - b. Deep mud
 - c. Snow and ice.
4. Amphibious operations (sea and fresh water)
5. Operation under conditions conducive to corrosion and fungus growth
6. Operation on grades and side slopes
7. Extended operation at low and high speed
8. Operator abuse in the form of overload, misuse, neglect, and improper maintenance
9. Air drop operations.

Many requirements are not compatible, thus it becomes the designers' difficult task to design, select, and arrange the components to meet all functional and reliability goals.

1-4.4.3 Methods of Achieving Cooling System Reliability

1-4.4.3.1 Use of Proven Components

Most commercial vehicles and components

AMCP 706-381

TABLE 1-6
MILEAGE CYCLE FOR TRACKED VEHICLES (Ref. 41)

^g Group	Cycles	Miles per Cycle				Total	
		Roads		Cross-Country			
		Paved	Secondary	Level	Hilly	Miles 1000 Mi/Op	hr
I	4	225	225	400	400	5000
II	4	350	350	400	400	^a 6000	^b 10 (Water) ^c 50
III	4	225	225	400	400	^a 5000
IV A	4	2000
B	4	350	350	400	400	6000	^d 2000
V	4	225	225	400	400	5000	100 (Water)
VI	1	200	500	700	(e)
VII	1	100	400	500	400
VIII	^f 50
IX	1	100 (Mud)	8
X	50	50	10 (Water)

^aOne-half of mileage is run with applicable towed load (except for cargo tractors that have towed load 100 percent of operation), but towed load operation may be omitted if basic vehicle has proved satisfactory.

^bApproximately 2 hr of water operation per cycle to total 10 hr.

^cTime includes all functions of wrecker equipment. Care will have to be used to avoid excessive temperatures in hydraulic systems. Operation should be temporarily stopped for cooldown if fluid temperatures exceed specified limits of the output of the motor, usually 215°F.

^dVehicles are operated the required mileage followed by performance of work, the total operation and work to be 2000 hr.

^eAccessories are operated for the time specified by the applicable documents.

^fExcept when unspooling, winches are tested at rated capacity, but care should be used to avoid damage to worm-driven winches. Normal cycling should include time for one spooling and unspooling with subsequent rest periods of equal time. Overall test time will have to be sufficient to provide 8 hr of actual winching time.

^gSee MTP 2-2-507 for vehicle types in each group.

TABLE 1-7
MILEAGE CYCLE FOR WHEELED VEHICLES (Ref. 42)

Group	Type	Secondary Road			Cross-Country ^a					Miles per Cycle	No. of Cycles	Total Miles	
		Highway	Munson	Perryman	Belgian Block	Level	Hilly	Swamp	Sand				Water
I	Tactical Trucks ^b	750	250	425	75	450	450	25	75	1 hr	2500	10	25,000
II	Truck Bodies Equipment B, c	2500	250	250	50	250	250	250	3800	3	11,400
III	Lt. Wt., Low Mileage Trucks: ^b A-Sprung Types B-Unsprung Types	1250 350	150 150	100 400	50 50	125 600	125 600	75 250	125 100	2000 2500	2 2	4,000 5,000
IV	High Flotation Vehicle	d1000	100	400	250	500	1250	250	250	4000	1	4,000
V	Amphibious ^b	e1650	e300	e650	e100	500	500	f500	9175	4200	2	8,400
VI	Fire Trucks: A - Aircraft, Crash, Rescue B - Brush C - Structural	11325 11125 11225 11025 1000	500 500 300 300 1000	50 50 25 25	375 375 300 300	250 250 200 200	200 100	2700 2300 2150 1850 2000	1 1 1 1 2	5,000 4,000 4,000 4,000
VII	Commercial Trucks, Buses, Passenger Cars	4200	500	250	50	5000	7	35,000
VIII	Armored Cars	750	250	425	75	450	450	25	75	1 hr.	2500	10	25,000

^aRun 25 percent of all cross-country mileage under muddy conditions

^bRun last cycle without payload

^cRun each tanker pump 1 hr for every 50 miles

^dMay be reduced when highway operation is considered impractical

^eRun a loop of paved, gravel, and Belgian Block with 15 min in water for each loop until 125 hr of water operation are accumulated

^fOcean beach sand with 50 hr operation in salt water

^gTotal hr

ANICP 708331

have been proven unsatisfactory in combat operations simply because the military environment is far more severe than the operating conditions for which commercial components are designed. This leads us to the conclusion that the reliability of the vehicle cooling system must be based on components specifically designed for military applications. Wherever possible, proven Military Standard parts should be used in the cooling system design. New component designs should be based on similar Military Standard parts, and all Military Specifications relating to the original part should be cited as applicable to the new design also.

1-4.4.3.2 Minimizing the Number of Components

Design for maximum simplicity with a minimum number of components is required since reliability has a direct relationship to the complexity of the design. This point should be self-evident; however, it is often overlooked by the designer. This happens when too much attention is given to the functional requirements of a system while excluding considerations for design simplification. After the designer has developed a concept that fulfills the functional requirements, a complete analysis should be made to determine if the design can be amplified. Reliability and durability generally are improved where components can be made simple, sturdy, and similar to previously proven designs.

1-4.4.3.3 Redundant Design

For maximum reliability of military vehicle cooling systems, redundant design of components is mandatory. A redundant design permits continued operation after failure of the primary item so that performance will not be degraded to the extent of unacceptable levels.

Application of a redundant design requires careful consideration of the effects and consequences of component failures and

system complexity. For complex component functions—where there is a greater probability of marginal failures or performance degradation—the provision of redundant design could be so complex that the total reliability of the system would be reduced. The designer is cautioned to apply redundancy in design with discretion because of the impact on system complexity and cost.

The vehicle cooling system also should be designed with a reserve factor for degradation caused by heat exchanger plugging, scaling, and related field operation factors. This reserve factor also provides a margin for vehicle weight growth that normally occurs during a vehicle life cycle.

1-4.5 MAINTENANCE REQUIREMENTS (Refs. 26, 27, and 28)

1-4.5.1 Accessibility

Accessibility can be defined as the relative ease with which an assembly or component can be approached for repair, replacement, or service. A component is accessible if the steps required are few and simple; inaccessible if the steps are many and difficult to perform. Inaccessibility cannot be tolerated in US Army equipment to be used in combat. Access must be provided to all points, subassemblies, and components that require or may require testing, servicing, adjusting, removal, replacement, or repair. The type, size, shape, and location of access should be based upon a thorough understanding of the following:

1. Special operational requirements (if any) and environment of the unit
2. Frequency with which the access must be entered
3. Maintenance functions to be performed through the access
4. Time requirements for the performance

of these functions

5. Types of tools and accessories required to perform these functions

6. Work clearances required for performance of these functions

7. Distance the technician must reach within the access

8. Visual requirements of the technician in performing the task

9. Mounting of modules, subassemblies, and elements behind the access

10. Hazards involved in or related to the use of the access, e.g., heat, sharp edges, etc.

11. Size, shape, weight, and clearance requirements of logical combinations of human appendages, tools, winter gloves and clothes, modules, etc., that must enter the access.

Typical service and access requirements for the MBT70 Prototype Tank air-cooled power package and related system are shown in Fig. 1-43.

Most actions to replace components (coolant pumps, radiators, etc.) are allocated to the Organization level; repair of these type components is allocated to the Direct Support level. Only major repairs such as an engine overhaul might be allocated to the General Support level. Instructions for army maintenance personnel at the Organizational and Direct Support levels are contained in TM 38-750 (Ref. 28). Maintenance requirements in general should be consistent with these instructions.

1-4.5.2 Module Replacement

There is an increasing trend toward partially repairable and nonrepairable designs in industrial and military equipment. This

trend is reflected in the increasing use of unitized or modular construction. Unitization refers to the separation of equipment into physical and functionally distinct units to facilitate removal and replacement. The concept of unitization and modularization creates a divisible configuration more easily maintained. Troubleshooting and repair of unitized assemblies, therefore, can be performed more rapidly. Utilization of these techniques to the fullest extent improves accessibility, makes possible a higher degree of standardization, provides a workable base for simplification, and provides the best approach to maintainability at all maintenance levels. Another important advantage of unitized or modular construction, from a maintenance viewpoint, is the division of maintenance responsibility. Modular replacement can be accomplished in the field with relatively low skill levels and few tools.

1-4.5.3 Simplicity

There is a general tendency on the part of many present-day designers of equipment to produce an overly complex product. In many cases the equipment uses too many parts, has too close operating tolerances, is expensive to build, and is difficult to maintain. Equipment design should represent the simplest configuration possible consistent with functional requirements, expected service, and performance conditions.

Simplification, although the most difficult maintainability factor to achieve, is the most productive. By simplification of otherwise complex equipment, a monstrosity can be transformed into a working piece of equipment. Simplification should be the constant goal of every design engineer.

1-4.5.4 Coolants, Fuels, and Lubricants

1-4.5.4.1 Coolants

Formation of scale and rust in the cooling system occurs more rapidly during operation

AMCP 706-361

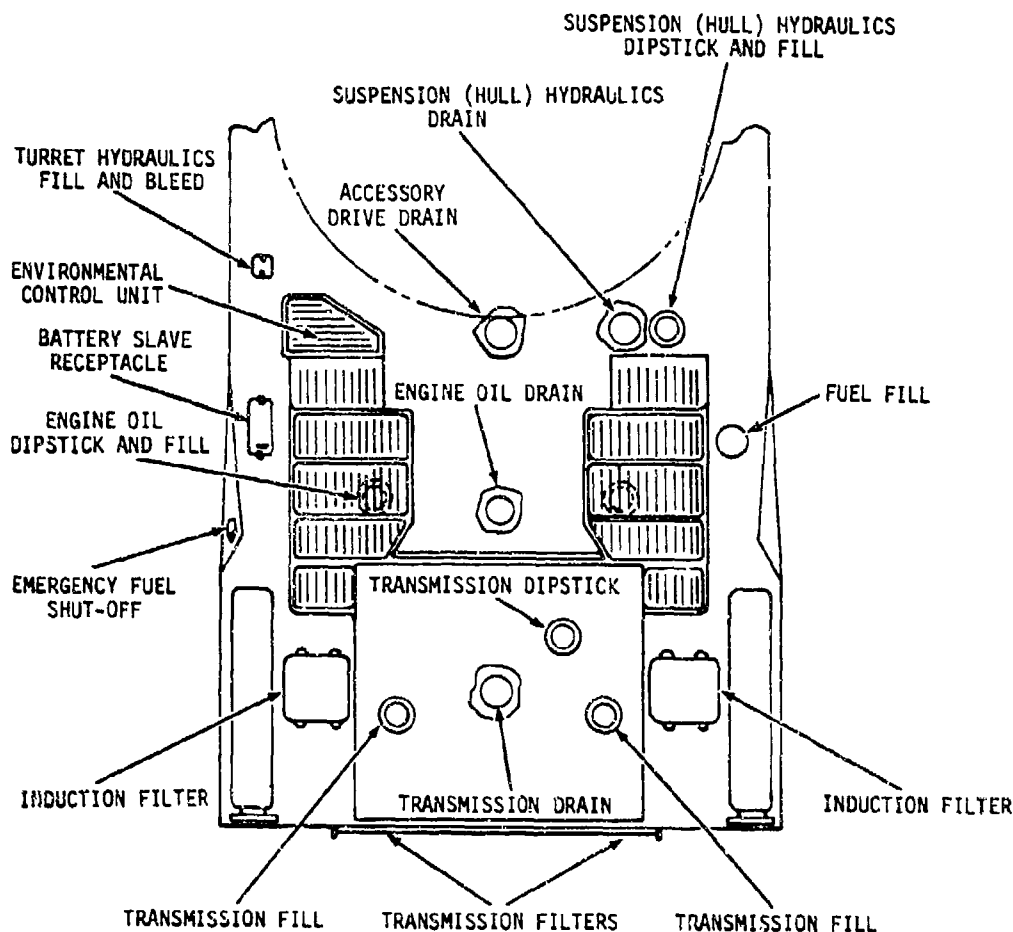

Figure 1-43. Service and Access Location for MBT70 Prototype Tank
 Air-cooled Power Package and Related Systems (Ref. 25)

in extremely high temperatures. Therefore, corrosion inhibitor compounds are added to the cooling liquid. Approved inhibitors are specified in MIL-I-19528 (Ref. 29) and Federal Specification O-I-490. *Inhibitor, Corroston, Liquid Cooling System* (Ref. 30).

Water containing alkali or other impurities causing cooling-system scaling and rust formations often cannot be avoided. Provision of adequate reserve cooling capacity in the

system is desirable to minimize the cooling degradation effects of these formations. There is a requirement that whenever possible the equipment use only those supplies in the Army supply system. The current instructions are contained in TB 750-6:51 (Ref. 33). It should be noted that this bulletin provides for leaving the coolant in the system for up to 2 yr under certain conditions and for emergency use of water without inhibitor. Exceptions to the use of inhibitor in plain water have

TABLE 1-8

LUBRICATING OILS, HYDRAULIC FLUIDS, AND GREASES USED IN MILITARY
 AUTOMOTIVE EQUIPMENT

	MILITARY SPECIFICATIONS
MIL-L-15019	Lubricating Oil, Compounded
MIL-L-2104	Lubricating Oil, Internal Combustion Engine, Heavy Duty
MIL-L-10324	Lubricating Oil, Gear, Subzero
MIL-O-10295	Oil, Engine, Subzero
MIL-O-6083	Oil, Preservative, Hydraulic Equipment
MIL-H-5606	Hydraulic Fluid, Petroleum Base, Aircraft and Ordnance
MIL-H-13919	Hydraulic Fluid, Petroleum Base, Fire Control
MIL-H-13910	Hydraulic Fluid, Nonpetroleum Base, Automotive Brake, Arctic
MIL-G-23827	Grease, Aircraft and Instrument, Sealed Bearings
MIL-G-10924	Grease, Automotive and Artillery
VV-G-632	Grease, Lubricating, Automotive and Industrial

been made for certain engines with aluminum components to avoid corrosion due to incompatibility with the inhibitor.

Chemical chromate type inhibitors have a negligible effect on engine heat rejection characteristics.

Antifreeze compounds in accordance with MIL-A-11755, *Antifreeze, Arctic Type*, and Federal Specification O-A-00548, *Ethylene Glycol, Inhibited*, should be specified for use in low temperature environments (Refs. 31 and 32). Ethylene glycol usually has a corrosion inhibitor present and no additional additives are required.

1-4.5.4.2 Fuels and Lubricants

A vehicle cooling system may use fuels, lubricating oils, hydraulic fluids, and other liquids as heat transfer mediums. These liquids absorb heat from the vehicle components and transfer this heat to the air through the use of heat exchangers.

Fuels for military vehicles are classified into two general groups: gasoline and diesel fuels. Gasoline is defined as fuel used in spark ignition internal combustion engines. Detailed

requirements for gasoline for use in military vehicles are given in MIL-G-3056, *Gasoline, Automotive, Combat* (Ref. 34). Similarly, diesel fuel is defined as fuel used in compression ignition internal combustion engines. Detailed specifications for diesel fuels for use in military vehicles are given in Federal Specifications VV-F-800, *Fuel, Oil, Diesel*, (Ref. 35). Turbine engine fuel (JP4) specifications are in accordance with MIL-T-5624 (Ref. 39). For guidance on fuels planned for use in various classes of equipment see AMCP 700-28 (Ref. 36).

Lubricants used in military automotive vehicles include the engine oils, gear oils, preservative oils, hydraulic fluids, and greases. These are supplied in various grades and types to cover the wide range of climatic conditions in which military equipment is expected to function. Detailed requirements for these items are given in the Military Specifications listed in Table 1-8.

The reader is referred to AMCP 706-123, *Hydraulic Fluids*, for additional information (Ref. 37). Physical properties for lubricants are given also in par. 3-7.2.

AMCP 706-361

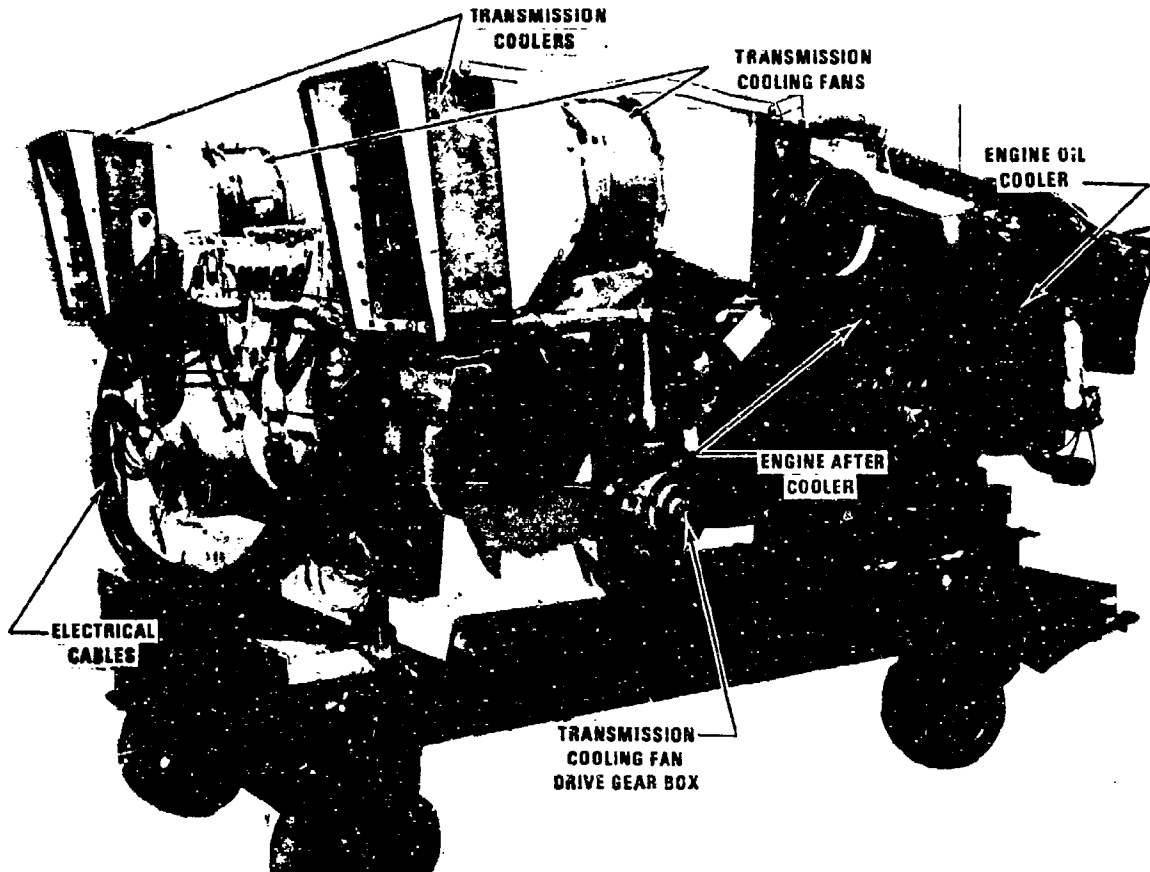

Figure 1-44. XM803 Experimental Tank Power Plant Test Run and Stall Check—Power Plant Removed (USATACOM)

1-4.5.5 Complete Power Package Removal

Combat vehicles, with their inherent confined engine compartments, present an access problem for repair, maintenance, service, and inspection of the power package assembly. This lack of accessibility makes it almost mandatory that the power package (engine, transmission, and cooling system) be removable as a complete unit. It also is a normal requirement that the power package be capable of being operated outside of the vehicle using vehicle power, controls, instruments, and fuel. This permits a full evaluation and check-out of power package condition

prior to installation in the vehicle. Oil, coolant and fuel leaks, improper adjustments, and similar failures can be found prior to installation in the vehicle. Space limitations often would prevent correction of these types of problems with the power package installed.

Fig. 1-44 illustrates the XM803 Experimental Tank, air-cooled power package assembly as it is removed from the vehicle. This assembly can be operated as shown.

Fig. 1-30 illustrates the SHF M551, liquid-cooled power package assembly as it is removed from the vehicle. This power

package also can be operated as shown.

1-4.6 INFRARED (IR) SIGNATURE

1-4.6.1 Description of IR Phenomena

The term "infrared" is applied to radiation that lies just beyond the limit of the red portion of the visible spectrum with wavelengths between 760 μ and 1 mm. IR radiation is emitted naturally by all materials at all temperatures above absolute zero. Materials emit radiation at varying intensities depending on their temperature and surface characteristics.

1-4.6.2 IR Suppression for Combat Vehicles

Infrared radiation originating in the engine compartment of combat vehicles exposes the vehicle to detection. The infrared problem and some of the methods necessary to control or adequately suppress infrared radiation are presented.

1-4.6.3 The IR Radiation Problem

The problem confronting the vehicle designer is to lower the intensity of the radiation from the combat vehicle to a level where the range of detection will neutralize the effectiveness of various devices employing IR detectors. The IR device generally can be classified into three types whose operation is based on the sensitivity of substances to small changes in infrared radiation:

1. Heat homing missiles
2. IR detectors
3. Mines or booby traps.

1-4.6.3.1 Necessity for Suppression

The necessity for IR suppression has been confirmed by radiation tests that show the combat vehicle extremely vulnerable to infrared sensitive devices. Therefore, unless IR

suppression measures are adopted the tactical use of combat vehicles will be hampered seriously.

1-4.6.3.2 Degree of Suppression Required

The degree of suppression practical at this point is that which is required to neutralize the effectiveness of the ground-to-ground and the air-to-ground heat homing missiles using a line of sight trajectory. In general, the greater the degree of suppression the less chance of detection. Additional suppression should be provided when it can be obtained without appreciable cost or compromise in design.

1-4.6.3.3 Military Importance of IR Signature

A vehicle signature is defined as a descriptive set of qualitative and quantitative measurements characterizing the salient features of the vehicle as a target. Infrared emission from a vehicle can be collected optically, filtered, detected, and amplified by optical and radiation-type pyrometers such as the bolometer. Temperature variations as small as 0.01 deg F can be detected. Thus, it becomes evident that IR radiometry plays a key role in detection systems for military applications. Fig. 1-45 illustrates vehicle signature data.

1-4.6.3.4 Reducing IR Radiation to a Minimum

It might appear that little could be accomplished by the reduction of IR radiation to minimize vehicle signature; however, this is not the case. The IR detector compares the vehicle radiation against background radiation which can be significant. Therefore, any reduction in vehicle IR radiation will reduce the possibility of the vehicle being detected. Typical projected IR radiation patterns for wheeled and tracked vehicles are shown in Figs. 1-46 and 1-47, respectively.

AMCP 706-361

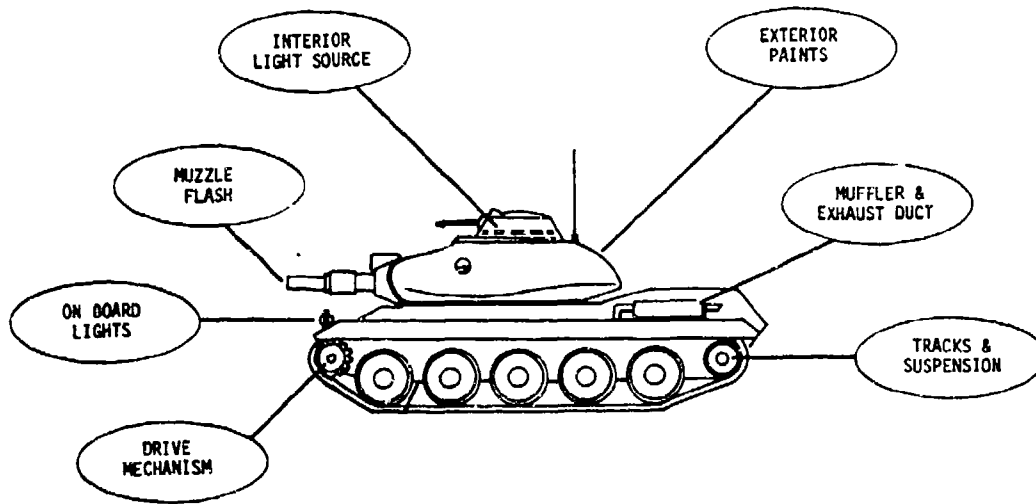

Figure 1-45. Vehicle IR Radiation Signature (USATACOM)

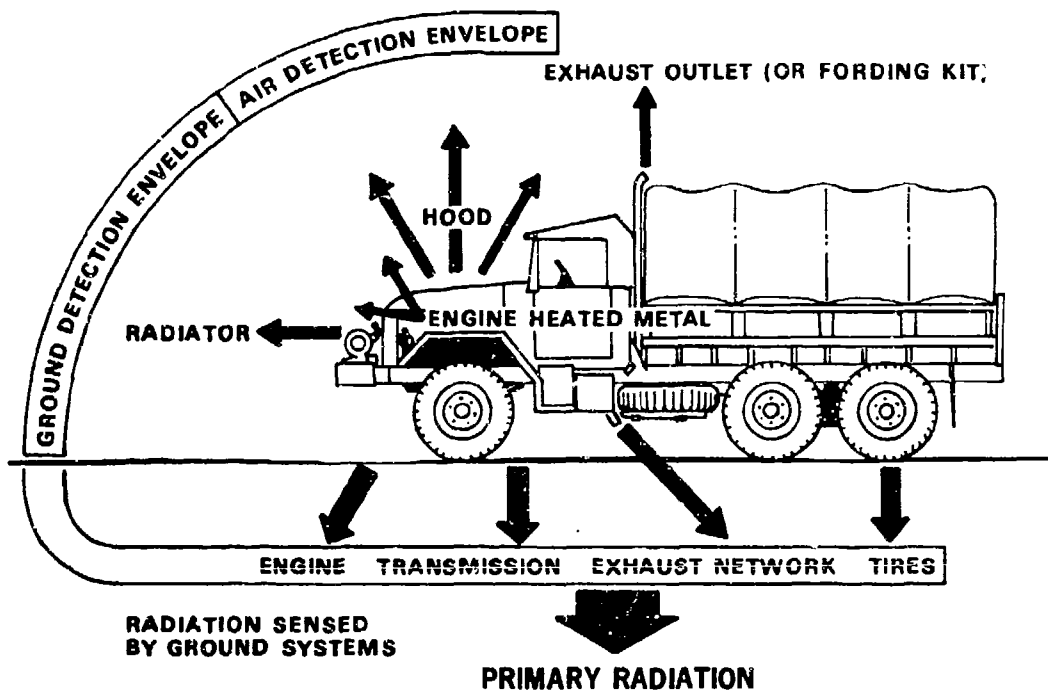

Figure 1-46. Typical Projected IR Radiation Patterns for Wheeled Vehicles (USATACOM)

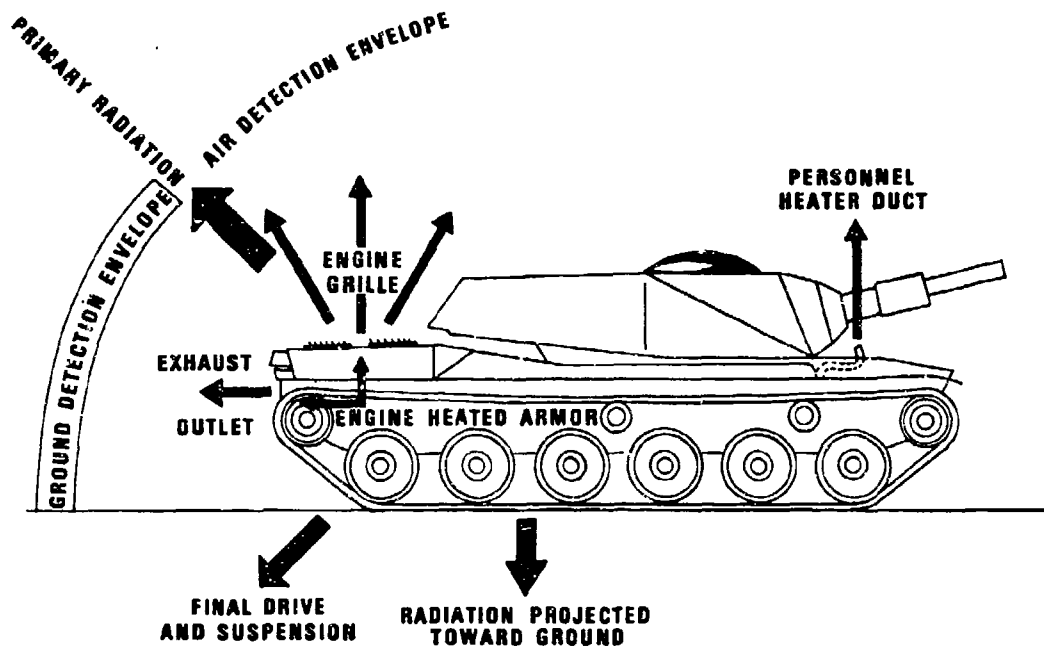

Figure 1-47. Typical Projected IR Radiation Patterns for Tracked Vehicles (USATACOM)

1-4.6.4 Techniques Used for IR Radiation Minimization

1-4.6.4.1 Recommended Procedures for IR Suppression

Through an extensive IR suppression program, IR suppression methods have been developed and design parameters determined. This determination has enabled a procedure to be established for the design of vehicles or IR modification kits which, based on test results, will provide effective IR suppression.

Directional exhaust louvers can effectively lower the air and ground IR detection envelope. Designs similar to the XM803 Experimental Tank exhaust directional vanes can be used to direct the exhaust gases and/or cooling air discharge toward the ground. The visual acceleration smoke characteristics of

diesel engines also is dispersed effectively with this design.

1-4.6.4.1.1 Concealing Mufflers and Exhaust Pipes

To further simplify the insulation problem and to facilitate mixing of the cooling air and exhaust gas, while at the same time not adversely affecting cooling, it is recommended that the muffler and exhaust pipes be concealed within the vehicle and located in the waste cooling air stream (preferably in an exit duct).

1-4.6.4.1.2 Insulated Shield for Exit Grilles

Since an air-to-ground attack is liable to come from any direction, it is recommended that an insulated shield or flap be provided which can be temporarily lowered in front of

AMCP 706-361

the exit grilles when being attacked. It is recommended only as a temporary measure, since it may restrict the airflow and cause vehicle cooling problems.

1-4.6.4.1.3 Minimize Exit Grille Areas

Since radiation varies directly as the surface area, the exit area should be held as small as possible. In other words, an exit grille or armored outlet that produces minimum restriction to airflow should be used to permit a maximum of airflow with a minimum grille surface area. In addition, a small exit area simplifies the problem of temporarily shielding the grille.

1-4.6.4.1.4 Location of Hot Surfaces

Exit grilles and surfaces that cannot be maintained at the specified temperature should be located at the rear of the tank. This is recommended so that in case of attack by a ground-to-ground missile the only vulnerable direction would be the rear. This situation seldom occurs during combat operation.

1-4.6.4.1.5 Mixing Exhaust With Cooling Air

A device designed to reduce the temperature of combustion gases from the vehicle and to minimize the effectiveness of IR detecting devices is an exhaust cooler. The most common exhaust coolers use the principles of air bleed cooling as shown in Fig. 1-48. The exhaust gases are diluted and cooled by mixing them with atmospheric air before discharge.

1-4.6.4.1.6 Shielding and Insulating

Shielding and insulating hot cooling system components effectively reduce their IR radiation. Insulating pads should be applied to the inner surfaces of the power package compartment as shown in Fig. 1-49, and shielding of exhaust pipes and mufflers can be accomplished by constructing a shielding structure or IR deck over the external

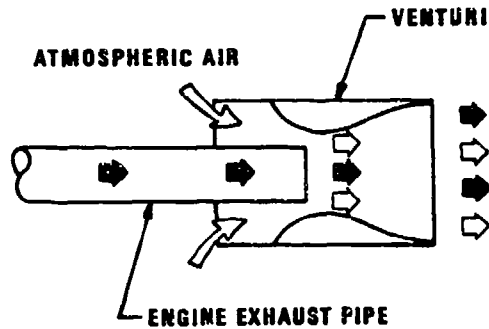

Figure 1-48. Exhaust Cooler

exposed portion of these components. The designer's attention to these areas during the integration of the power package/vehicle systems can reduce greatly the vehicle IR signature.

1-4.6.4.1.7 Location of Exhaust

The power package exhaust system must be located to minimize heat transfer and/or hot air recirculation to the cooling system while still retaining effective suppression of IR radiation. The vehicle exhaust outlet should be directed horizontally, or lower, to reduce the air and ground IR detection envelope as defined in Figs. 1-46 and 1-47.

1-4.6.5 Suppression Methods To Meet Future Requirements

With the continued development of IR detectors and heat homing missiles, it is very possible in the future that in order to provide adequate suppression the design point conditions will have to be revised. Should this be the case, it may be necessary to take measures to reduce the radiation from such components as the final drives, shock absorbers, wheels, track, as well as decrease the effect of heating by the sun and changing ambient temperatures. Further lowering of exhaust gas temperatures also may be necessary. The following methods are envisioned to effect some of these reductions:

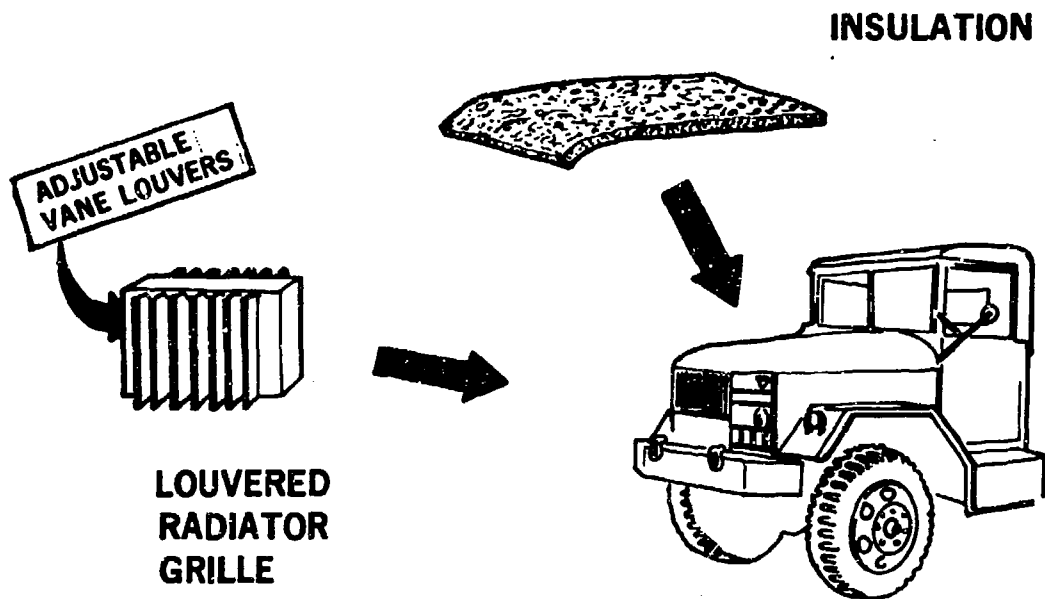

Figure 1-49. Reduction of IR Radiation (USATACOM)

1. Final Drives:

a. Cover the final drives with a:

(1) Shield that provides a small air space between the shield and final drive

(2) Layer of plastic foam insulation and force the heat from the final drive to be dissipated from the inside of the hull

b. Locate the final drives within the hull of the vehicle.

2. Exhaust Gas:

a. Use a muffler in the waste cooling air stream to cool the exhaust gas below its ignition point before it is mixed with the cooling air and thereby prevent the burning of unburned fuel in the exhaust gas.

b. Use an exhaust ejector to pump air to cool the exhaust gases.

3. Effect of heating by the sun and changing ambient temperatures. The effect of heating by the sun and changing ambient temperatures on the temperature differential between the vehicle and its background can be decreased by:

a. Coating the vehicle with a layer of plastic foam insulation to minimize the quantity of heat conducted away from the surface and absorbed by the hull and, thereby, allow the vehicle surfaces to cool rapidly and eliminate the temperature differential due to changing ambient

b. Painting the vehicle with a paint that has a low emissivity to reduce the quantity of heat absorbed by the surface, preventing high surface temperatures and minimizing the temperature differential due to heating by the sun.

Applying insulation and painting can be accomplished with almost equal ease either

during production of a vehicle or at any time thereafter.

1-4.6.6 Camouflage in IR Suppression

It is believed that the design procedures discussed represent the practical limits in IR suppression which can be accomplished through vehicle design. It appears that further improvement will have to come through camouflage techniques. The measures discussed for minimizing the effect of the sun and changing temperatures, if adopted, actually could be camouflage technique. It should be noted that the use of low emissivity paint probably can be refined further to provide paints whose emissivity will be matched as far as possible with that of the background whether it be sand, snow, or vegetation.

The plastic foam insulation mentioned in par. 1-4.6.5 is being adapted by MERDC for application to vehicle surfaces by spraying. While it has actually not been applied to a tank, it promises to have all the characteristics necessary for such application, namely, ease of application, resistance to abrasion and wear, bonds to most surfaces, and is not affected by water, gasoline, or oil.

1-4.6.7 Example of IR Suppression Test Data

Skin temperature readings of the top deck were taken during a recent M60 Vehicle cooling test at the TACOM Propulsion Systems Division test facility. Tests were conducted with and without simulated solar radiation and with and without an IR shield installed to the top deck.

With solar radiation and without IR shielding the average skin temperature was 194°F. Without solar radiation and without IR shielding the average skin temperature was 174°F. Without solar radiation and with IR shielding the average skin temperature was 119°F.

1-4.7 DEPOT STORAGE

Comprehensive storage capabilities are required for all military materiel to permit rapid replacement of vehicle casualties during hostilities. The materiel must be capable of safe storage (and transportation) without permanent impairment of its capabilities from the effects of extreme climatic conditions. It further must be capable of being returned to operating status in a minimum time span. These capabilities contribute to minimum deployment time to threatened theatres.

Various levels of protection have been defined to meet specific technical requirements up to Level A, which is defined as preservation and packaging that will afford adequate protection against corrosion, deterioration, and physical damage during shipment, handling, indeterminate storage, and worldwide redistribution. The vehicles are prepared in a mobile condition, i.e., vehicles capable of being moved on their wheels/tracks (Ref. 38). All cooling system components must meet these requirements under environmental conditions given for storage in Table 1-2.

1-4.8 SPECIAL KITS

1-4.8.1 Winterization Kits

The function of a cooling system is not only to remove unwanted heat from the system; it also provides heat to the system, when it is required, to assure safe and efficient operation of the vehicle power plant.

Experience in World War II emphasized the need for vehicles capable of sustained fighting ability within any geographical area during any season of the year. In recognition of this need, AR 70-38 states that automotive materiel developed by the Army should be capable of acceptable performance throughout the ambient temperature range of -25° to 125°F with no aids or assistance other than

standard accessories, and to -65°F with employment of specialized aids in kit form (Ref. 2).

Winterization kits are those appliances that are necessary to assure dependable vehicle starting and operation in the temperature range of -65° to -25°F . The basic equipment and materials for extreme cold-weather operation of vehicles are arctic-type fuels, lubricants, coolants, and engine primers. High-capacity heating equipment provides sufficient heat for starting power plants and maintaining batteries at the proper temperature for continuous charging with the standard electrical generating system.

1-4.8.1.1 Heating of Power Package Components

The techniques of applying heat to military vehicles for starting in cold environments are the results of extensive testing and developmental efforts. Two methods have been developed — the standby-heat method and the quick-heat method.

The standby-heat method uses a comparatively small heater that operates continuously when the vehicle is idle. It must produce sufficient heat to compensate for losses while keeping the power plant at a temperature high enough to ensure starting. For vehicles having engine displacements of 100 to 300 CID, 20,000 Btu/hr, properly distributed, will maintain satisfactory temperatures at all desired points. When standby-heat is used, the vehicle is always warm and ready to start. Heat usually is supplied to liquid-cooled plants by a thermosyphon system, thus avoiding pumps and fans that drain batteries. Heat can be supplied by hot water coils and, thereby, minimize the danger of overheating. Since space is usually at a premium, the relatively small size of the standby heater is a distinct advantage. Fig. 1-50 illustrates the standby-heat winterization kit used on the SHERIDAN, M551. The SHERIDAN, M551 winterization assembly is an integrated

winterization and cooling system that permits vehicle operation in all required climatic extremes.

The quick-heat method, which is well adapted to the present air-cooled engines, provides a combustion heater having sufficient capacity to start a cold engine in a short period of time. For current engines, starts in less than an hour can be achieved at low ambients by using quick-heat units producing from 30,000 to 100,000 Btu/hr. Several design problems are presented by the quick-heat method. Among these are prevention of damage to electrical and nonmetallic components and the avoidance of heating the batteries too rapidly. Conventional rubber-cased batteries cannot be heated faster than about 1 deg F per min; supplying heat at a faster rate may cause damage.

Quick-heating eliminates the need for continuously heating equipment while not in service. The life of the combustion heater is greater, and maintenance is less than in standby-heaters designed for constant operation. Both standby and combustion heaters have desirable characteristics, and both are currently in use. There is a trend towards a combination of the two systems. This combination heater is capable of bringing a thoroughly cold-soaked power plant from -65°F to starting temperature in 45 to 60 min. The heater is thermostatically controlled so that it can be used as a standby or a quick-heater as desired.

Fig. 1-51 illustrates the combustion heater used in the XM803 and MBT70 Tanks. This heater is used for crew compartment and battery heating only, since the air-cooled engine has self-contained cold starting aids in the form of intake air and lubricating oil heaters.

1-4.8.1.2 Restriction of Cooling Air

In extreme cold environments, the result of winds (or air movement produced by fans)

AMCP 708-361

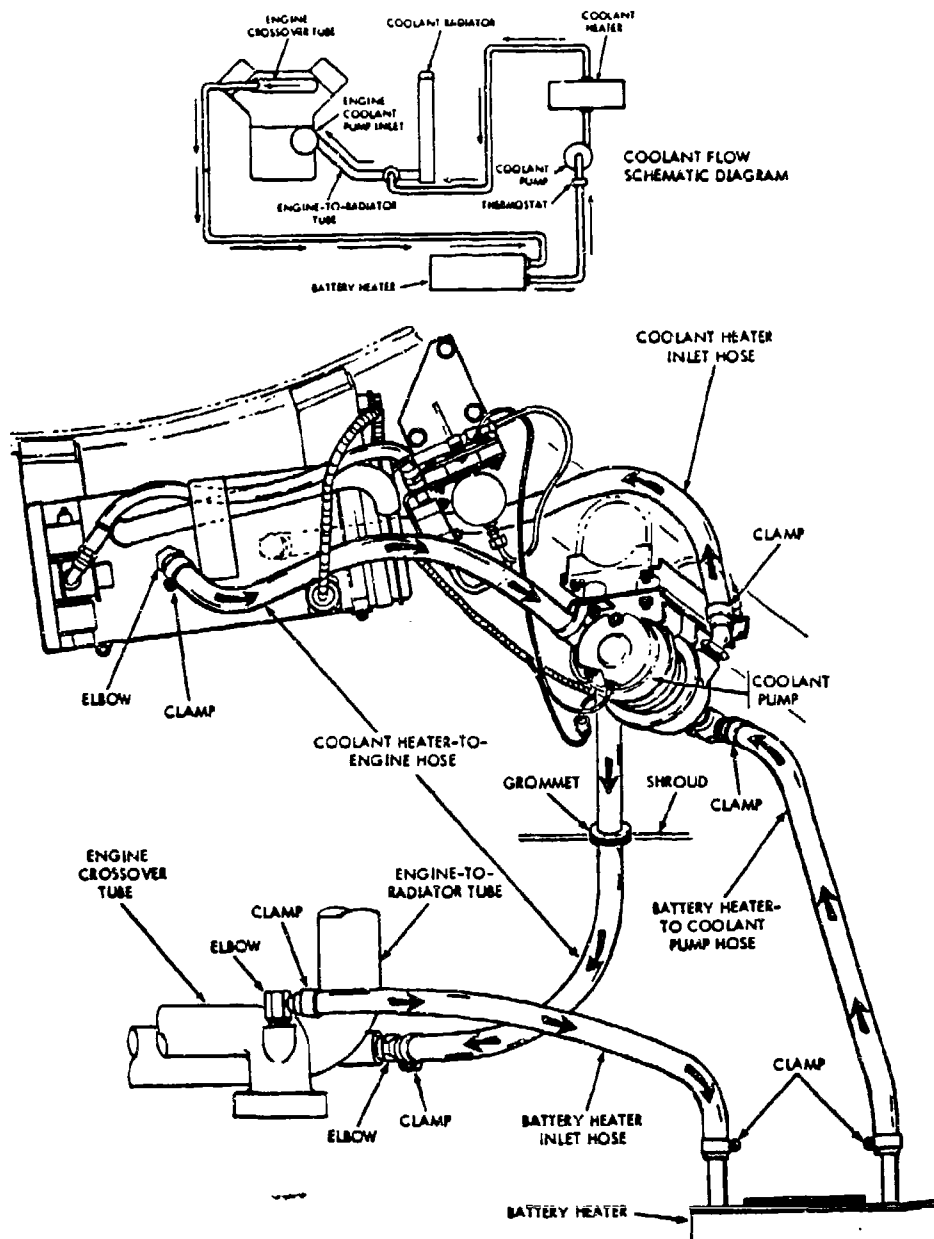

Figure 1-50. SHERIDAN, M551, Standby Winterization Kit (Ref. 13)

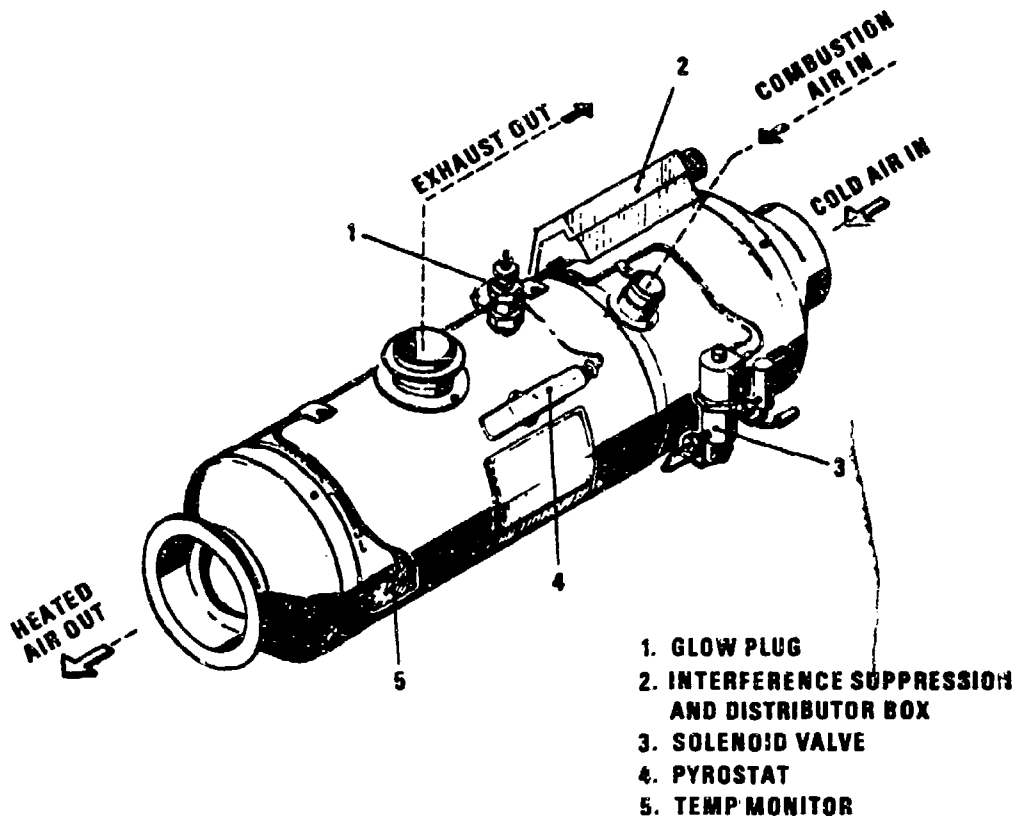

Figure 1-51. Combustion Heater, Winterization, XM803 and MBT70 Tanks (Ref. 25)

produces a tremendous cooling effect, and for rapid warm-up and satisfactory engine operation these effects must be minimized by restriction or obstruction of the air movement.

Thermostatically controlled fans (see Chapter 4), winterization baffles, or shutters—either manually or thermostatically controlled—provide an effective means of reducing the wind chill effect of cooling air movement at extremely low ambients. Fail-safe automatic thermostatic controls are preferred since they eliminate the element of human error.

The Truck, Platform Utility, M274A5, air-cooled engine uses a manually operated winterization shutter to restrict the air inlet to the fan. (Fig. 1-14).

Thermostatically controlled shutters mounted ahead of the radiator, (see Fig. 5-3), are controlled automatically by a thermostatic element installed in the upper or lower reservoir of the cooling system radiator. The normal settings of these shutters are fully open with engine coolant temperature above 180°F and fully closed when the coolant temperature is 160°F and below. A manual override is provided to operate the vanes and

AMCP 706-361



Figure 1-52. Truck, Cargo, 2-1/2-ton, 6 x 6, M35 During Deep-water Fording Tests

to hold them in the open position.

1-4.8.2 Fording Kits

The ability to operate in reasonable depths of water greatly enhances the mobility of military equipment; hence, if specified, vehicles must meet defined fording requirements.

Current requirements make a distinction between shallow- and deep-water fording. The shallow-water fording is applied to standard tactical vehicles operating without the addition of special kits (although they may have factory-installed items, such as intake and exhaust extensions and waterproof ignition systems). The basic vehicle must be capable of fording a specified depth of water without any special preparation. Deep-water fording on the other hand, implies the usage of special equipment, usually installed in the field by the vehicle crew prior to the fording operation. The deep-water fording kit may interfere, to some extent, with the normal functioning of the vehicle on land, but is easily and quickly removable immediately

after use. Important considerations in the design of fording kits are ease of installation, jettisonability, and a high degree of reliability.

The vehicle cooling system must not be affected adversely during or after completion of the fording operations. Fig. 1-52 illustrates the Truck, Cargo, 2-1/2-ton, 6 x 6, M35, during deep-water fording tests.

1-4.8.3 Fording Requirement Effects on Cooling System Design

The following vehicle requirements apply to fording operations and must be considered for their impact on the cooling system performance:

1. Cooling fans must automatically disengage when the fan blades are submerged.
2. Water must not be allowed to enter any of the various transmissions, differentials, gearboxes, or final drive assemblies, normally vented to the atmosphere.
3. One or more exhaust stacks must be

provided to allow exhaust gases to escape above the water level.

4. The main, and any auxiliary engine, air intake must be above the water level or in the crew compartment and must be adequately sealed.

5. All sealing must be accomplished in a most simple manner so that it is jettisonable immediately upon completion of the fording operation to permit the vehicle to regain immediately its original firepower, mobility, and cooling capacity.

1-4.8.3.1 Electric and Hydraulic Motors

Electric and hydraulic motors must undergo submersion without damage. Although not all components of a vehicle are required to operate while submerged, none of them must be damaged as a result of submersion. Critical parts must be enclosed in watertight housings to permit submersion, and provisions must be made for the removal of excess heat within the housing. The watertight enclosures should be ventilated to prevent undesirable condensation of moisture resulting from the sudden temperature change normally associated with immersion. This moisture condensation can cause short circuits, can jam contacts if the moisture freezes, and cause equipment to deteriorate generally.

1-4.8.3.2 Sealing of Power Transmission Components

Power transmission components must be adequately sealed, and water must not be allowed to enter any of the various transmissions, differentials, gearboxes, or final drive assemblies, normally vented to the atmosphere. These vents cannot be sealed prior to fording. If they are sealed, the sudden cooling of the unit upon submerging creates a temporary partial vacuum within the housing. The resultant pressure difference would cause serious water leakage into the housing through the shaft seals. Provisions must be

made to vent the various housings to the atmosphere while the vehicle is fording.

1-4.8.3.3 Fan Fording Cut-off Switches

Vehicles using a magnetic fan drive clutch assembly require a provision for declutching the fan drive during deep-water fording operations. A single-pole, single-throw switch such as the MS39061-1 is used for this purpose. This type of fan drive control introduces "human error" into the fording operation and, where possible, designs normally use automatic declutching devices.

If the electrical system should fail, the fan should be able to be locked mechanically by hand.

1-4.8.3.4 Mechanically Driven Fans

The most common type of mechanically driven fan is the axial flow, belt driven assembly. No special provisions for fording are necessary because the drive belts will slip when the fan is submerged.

1-4.8.3.5 Turbine Shielding

Turbine engines present a unique problem when fording because of the high temperature of engine components. The turbine engine must be shielded adequately from water to prevent damage that would result from sudden cooling if the unit were immersed.

1-4.8.4 Effects of Kits on Vehicle Cooling Systems

1-4.8.4.1 Winches

Installation of a front mounted winch on the Truck, Cargo, 2-1/2-ton, M35, partially restricts airflow to the cooling system radiator. Fig. 1-53 illustrates the radiator area obstructed by installation of the winch. The vehicle cooling system design must provide sufficient additional capacity to correct for this type of restriction. Conversely, winch

AMCP 708-361

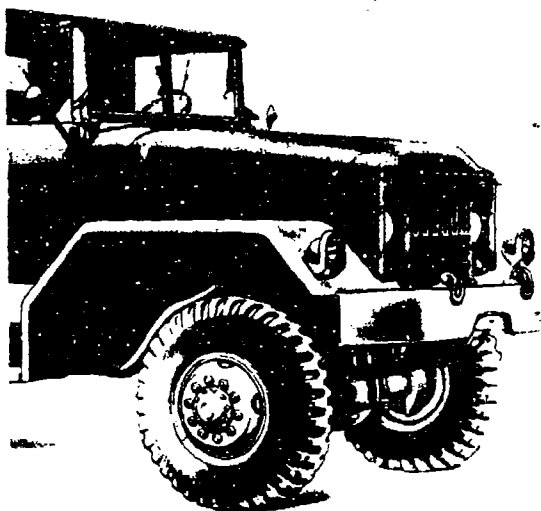

(A) WITHOUT WINCH

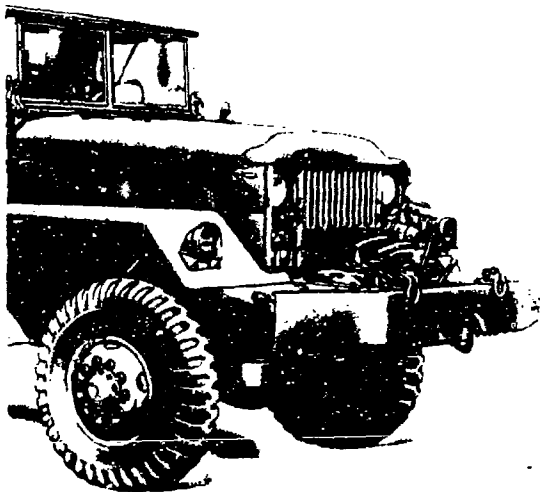

(B) WITH WINCH

installations have been made to serve as an air recirculation baffle by closing the space between the winch and the radiator with the winch mounting platform.

1-4.8.4.2 On-vehicle Equipment

The requirements to stow on-vehicle equipment (OVE) can result in degradation of the vehicle cooling system by restriction and/or recirculation of cooling air. Fig. 1-54 illustrates modifications made to the M551 SHERIDAN Weapon System for improvement of the cooling system. This modification consisted of a deflector to minimize recirculation of the exhausting cooling air.

1-4.8.4.3 High Demand Electrical Equipment

Radios, bilge pumps, battery charging, ventilation blowers, lights, heaters, vision devices, and similar equipment can require high electrical loads while the vehicle engine is running at idle speeds. These loads can contribute to cooling system problems if not considered in the initial design. Normal vehicle requirements for electrical power specify sufficient generator output at engine idle speeds to operate all applicable electrical equipment in the vehicle.

Figure 1-53. Radiator Restriction Caused by Winch Installation (Ref. 40)

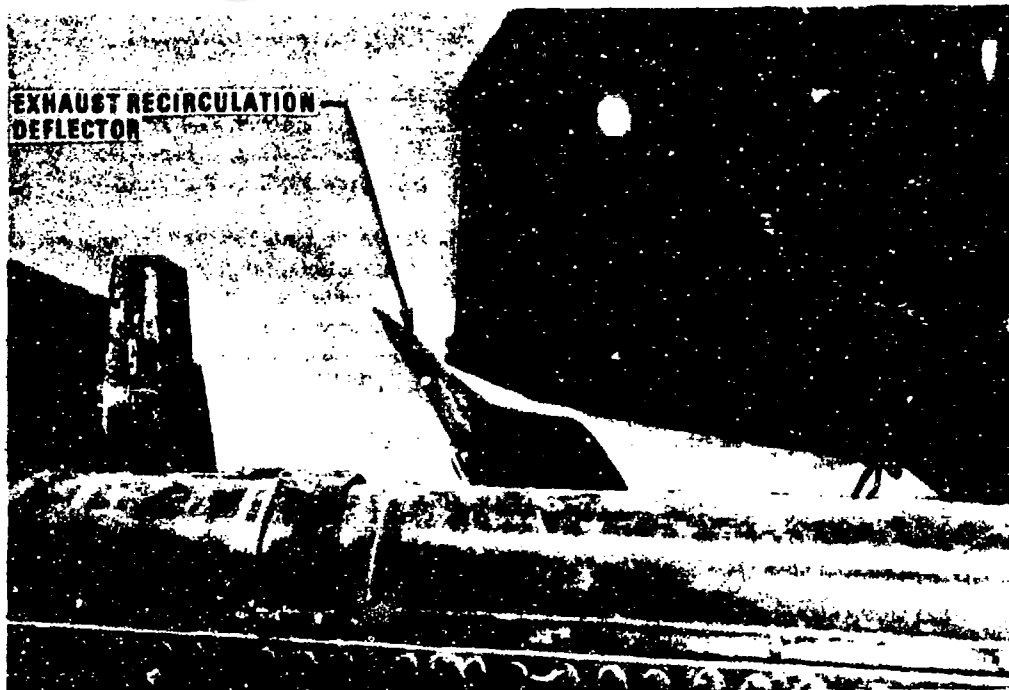

Figure 1-54. SHERIDAN, M551, Cooling Air Recirculation Deflector Directly Beneath the Bustle Rack (Yuma Proving Ground)

REFERENCES

1. Theodore Baumeister, Editor-in-Chief, *Marks' Standard Handbook for Mechanical Engineers*, Seventh Edition, McGraw-Hill Book Co., New York, N.Y., 1967.
2. AR 70-38, *Research, Development, Test, and Evaluation of Materiel for Extreme Climatic Conditions*.
3. MIL-L-2104, *Lubricating Oil, Internal Combustion Engine (Heavy Duty)*.
4. AR 705-5, *Research and Development of Materiel*.
5. AR 70-10, *Research, Development, Test and Evaluation During Development and Acquisition of Materiel*.
6. Gene Engel and Wayne S. Anderson, *Automotive Engineering*, 79, August 1971.
7. TM 9-2350-217-10, *Operators Manual for Howitzer, Light, Self-propelled, 105-mm, M109*, December 1969.
8. *Cooling of Detroit Diesel Engines*, Engineering Bulletin No. 28, Detroit Diesel Allison Division of General Motors Corp., Indianapolis, Indiana, May 1967.
9. *LDS-465-2 Multifuel Engine Operating Instructions*, Continental Aviation and Engineering Corp., Detroit, Michigan, May 1967.

AMCP 706-381

10. TM 9-2320-246-34, *Direct Support and General Support Maintenance Manual for Truck, Platform Utility, 1/2-Ton 4 X 4, M274A2*, December 1967.
11. TM 9-2320-224-10, *Operators Manual For Carrier, Command and Reconnaissance, Armored, M114, M114A1 and M114AE1*, November 1964.
12. TM 750-254, *Tactical Vehicle Cooling Systems*, March 1972.
13. TM 2350-230-35/1, *Maintenance Manual, Hull Suspension, and Miscellaneous Components for Armored Reconnaissance - Airborne Assault Vehicle, FT, 152 MM, XM551*, July 1966.
14. MIL-STD-210, *Climatic Extremes for Military Equipment*.
15. AMCP 706-342, *Engineering Design Handbook, Recoil Systems*.
16. AMCP 706-356, *Engineering Design Handbook, Automotive Suspensions*.
17. MIL-A-8421, *Air Transportability Requirements*.
18. MIL-STD-669, *Loading Environment and Related Requirements for Platform Rigged Airdrop Material*.
19. AMCP 706-130, *Engineering Design Handbook, Design for Air Transport and Airdrop of Materiel*.
20. MIL-R-45306, *Radiators, Engine Cooling, Industrial*.
21. MIL-STD-810, *Environmental Test Methods*.
22. AMCP 706-357, *Engineering Design Handbook, Automotive Bodies and Hulls*.
23. EM 1701, *Armor Operations*.
24. David Wray Jr., *New Assault Amphibian Personnel Carrier, (LVTPX12) For The U S Marine Corps*, Paper No. 680533, SAE, New York, N.Y., 1968.
25. PDTM 9-2350-235-20, *Preliminary Organizational Maintenance Manual Hull, Suspension, and Miscellaneous Components For Main Battle Tank Armored Full-tracked, 152 mm, MBT70*, December 1969.
26. AMCP 706-134, *Engineering Design Handbook, Maintainability Guide for Design*.
27. W.E. Woodson and D.W. Conover, *Human Engineering Guide For Equipment Designers*, University of California Press, Los Angeles, California, 1970.
28. TM 38-750, *Maintenance Management Systems, Army, Equipment, Operation, Maintenance*, December 1969.
29. MIL-I-19528, *Approved Inhibitors, Corrosion, Compounds*.
30. Federal Specification O-I-490, *Inhibitor, Corrosion, Liquid Cooling System*, April 1965.
31. MIL-A-11755, *Antifreeze, Arctic Type*.
32. Federal Specification O-A-00548, *Ethylene Glycol, Inhibited*.
33. TB 750-651, *Use of Antifreeze Solutions and Cleaning Compounds on Engine Cooling Systems*, January 1971.
34. MIL-G-3056, *Gasoline, Automotive, Combat*.
35. VV-F-800, *Fuel, Oil, Diesel*, May 1968.

36. AMCP 700-28, *Logistics, Fuel Policy*.
Ground, Aberdeen, Maryland, January 1968.
37. AMCP 706-123, *Engineering Design Handbook, Hydraulic Fluids*.
38. TM 750-142, *Procedures for Rapid Deployment and Retrograde, Combat Vehicles (Gasoline and Diesel Powered)*, May 1969.
39. MIL-T-5624, *Turbine Engine Fuel (JP-4)*.
40. TM 9-2320-235-20, *Organizational Maintenance Manual For Truck, Cargo, 2-1/2 Ton, 6 X 6, M35A1*, January 1962.
41. MTP 2-2-507, *Durability Testing of Tracked Vehicles*, Aberdeen Proving Ground, Aberdeen, Maryland, January 1968.
42. MTP 2-2-506, *Durability Testing of Wheeled Vehicles*, Aberdeen Proving Ground, Aberdeen, Maryland, May 1966.
43. Allen O. Elkins, et al., *Family of Military Engineer Construction Equipment (FAMECE)*, Paper No. 690579, SAE, New York, N.Y., 1969.
44. TM 9-2320-224-34, *Direct Support and General Support Maintenance Manual for Carrier, Command and Reconnaissance, Armored, M114/M114A1*, November 1964.
45. AMCP 706-355, *Engineering Design Handbook, The Automotive Assembly*.

BIBLIOGRAPHY

R. R. Adler, *Second Partial and Final Report on Engineer Design Test of Vehicle, Landing, Tracked, Personnel, Experimental, LVTPX12 (Assault Personnel Carrier)*, Report No. APG-MT-3146, Aberdeen Proving Ground, Maryland, April 1969.

Lt. Joseph P. Durso, Jr., *Check Test of Winterization Kit For Recovery Vehicle, Full-tracked, Light, Armored, M578, Under Arctic Conditions*, US Army Arctic Test Center, APO Seattle, Washington, May 1969.

MTP2-3-035, *Commodity Service Test Procedure, Landing Vehicles Wheeled and Tracked*, US Army Test and Evaluation Command, Aberdeen Proving Ground, Maryland, May 1970.

MIL-STD-281, *Preservation and Packaging of Automobiles, Trucks, Truck Tractors, Trailers, and Trailer Dollies*.

D. W. Smith, *Product Improvement Test of Truck, Cargo, M35A2C*, Report No. YPG-9077, Yuma Proving Ground, Yuma, Arizona, November 1969.

Wm. L. Snider, *Desert Testing of Military Vehicles*, Yuma Proving Ground, Yuma, Arizona, December 1968.

S. E. Wood, *Product Improvement Test (Desert) of SHERIDAN Weapon System, M551*, Report No. 002G, Yuma Proving Ground, Yuma, Arizona, March 1970.

2-0 LIST OF SYMBOLS

- A* = area, ft²
a = acceleration, ft/sec²
BHP = brake horsepower, bhp
f = coefficient of friction, dimensionless
g = acceleration due to gravity, 32.2 ft/sec²
Hz = frequency, cycles/sec
h = enthalpy, Btu/lbm
K = loss coefficient, dimensionless
k = ratio of specific heats, dimensionless
Q = heat flow, Btu/sec, Btu/min
RPM = speed, revolutions/min
T = temperature, °F
TE = tractive effort, lb
U = overall heat transfer coefficient, Btu/sec-ft²-°F
V = speed relative to air, mph
W = weight, lb
η = efficiency, percent
θ = grade angle, deg

Subscripts:

- a* = axle, addition, ambient, inlet
c = crankshaft, clutch, coolant, cylinder head
d = driving axle
e = equivalent
f = equivalent, engine

AMCP 706-381

LIST OF SYMBOLS (Cont'd.)

Subscripts (cont'd)

- g = generator, gas, gear
- m = motor
- p = pressure, piston
- r = ratio, rejection, rear, outlet, radius
- t = transmission, thermal
- v = volume
- 1 = air resistance, admitted
- 2 = rolling resistance, exhausted

CHAPTER 2

MILITARY VEHICLE POWER PLANT—SOURCES OF HEAT

Basic vehicle and transmission system construction and characteristics are discussed along with their heat rejection contributions. Miscellaneous components and their heat rejection characteristics also are discussed with respect to their relationship to the total vehicle heat rejection that must be dissipated to ensure operation at safe design levels.

2-1 BASIC ENGINE HEAT TRANSFER (Ref. 1)

The engine cooling process involves the flow of heat, originating from the engine combustion gases and friction, through the engine walls into the cooling media. In both liquid- and air-cooled engines, the final heat transfer is into the cooling air.

Forced convection is the term used to describe the heat transfer mechanism between a solid surface and a fluid in relative motion when the motion is induced. Most engine heat transfer is by forced convection. A reasonably accurate prediction of engine heat losses, based on fuel-air ratio and gas flow, can be obtained by the procedure outlined in Ref. 1. This analysis assumes an average heat transfer coefficient for the cylinder walls. The primary interest in this analysis is in the total heat transferred from the gases and not the local values of heat flow and wall temperatures.

2-1.1 MILITARY VEHICLE POWER PLANTS

The engine is the primary source of heat in a vehicle. Part of the engine heat is transferred directly to the coolant for rejection to the atmosphere. Part of the remaining heat is used as work. A small amount is radiated to the surroundings and the remainder is exhausted directly to the atmosphere. Classification of engines may be based on the utilization of the working fluid of the engine. An external combustion engine has the working fluid separated from the heat source, and an internal combustion engine has the working fluid included in the products of combustion

of the fuel-air mixture within the engine. These may be classified as reciprocating, rotary, compound, or thrust engines—depending on the use and movement of the working fluid.

An additional classification of engines is determined by the method of cooling:

1. An air-cooled engine rejects the heat of the engine directly to the atmosphere via the cylinder fins, oil heat exchanger, and other engine surfaces.

2. For a liquid-cooled engine, the coolant absorbs the heat of the engine as it passes through the engine coolant jacket and oil-cooler. The coolant heat then is transferred to the atmosphere through a radiator. Liquid cooling systems may be classified further in the following manner:

- a. The thermo-syphon type system is a liquid cooling system where the coolant circulation is induced by the weight differential of the hot water in the engine and the lower temperature of the water in the radiator. This system seldom is used in current high output engines because of the low coolant flow velocities.

- b. The atmosphere cooling system is vented directly to atmospheric pressure. This type of cooling system is limited by the 212°F sea level boiling point of water, since the system capacity is reached at this point.

- c. The pressure cooling system uses a pressure type radiator cap. This allows a build-up of pressure in the system above

atmospheric, increasing the temperature at which the coolant boils. Most liquid coolant systems are of this type.

d. The steam or vapor-phase cooling system is basically a liquid system that operates at the boiling temperature of the coolant. The radiator in this system acts as a condenser that removes heat from the steam before it is returned to the engine. This system offers the advantages of a constant operating temperature; however, no vapor-phase systems currently are used for military vehicles.

e. Special cooling systems have been provided for specific applications such as the use of diesel fuel as a coolant to overcome cold weather fuel icing. This system would not be applicable to high output engines because of the low specific heat of diesel fuel.

2-1.2 BASIC AIR STANDARD CYCLES (Refs. 2, 3, and 35)

An air standard cycle assumes air to be the working medium in place of the actual media which usually includes other gases and products of combustion. The air standard cycle may be used to study engine conditions such as operating temperatures, pressures, volumes, and efficiencies. They also may be used in estimating comparative heat rejection for the various types of engines. Actual engine performance will vary from the theoretical air standard cycle results, because of the differences in the actual engine working media. Actual efficiencies are always much lower than the air standard efficiencies.

Basic air cycles used for analysis include the:

1. Carnot
2. Otto
3. Diesel

4. Brayton
5. Rankine
6. Dual
7. Compound
8. Stirling.

A tabulation of the characteristics of these cycles is shown in Table 2-1. Pressure-volume diagrams for these cycles also are shown in Figs. 2-1, 2-2, and 2-3.

The reader is also referred to Refs. 1, 2, 3, 19, and 35 for additional information on the thermodynamics of engines.

2-1.3 VARIATIONS OF STANDARD THERMODYNAMIC CYCLES

Many engine design variations exist that use combined and/or modified thermodynamic cycles. These variations are incorporated to alter specific characteristics such as:

1. Improvement of the cycle efficiency by utilization of exhaust heat
2. Improvement in fuel economy
3. Increased brake specific power output
4. Reduced weight and size of the power plant for a given output
5. Use of low-ignition quality fuels.

Design methods used to accomplish these characteristics include:

1. Otto or diesel engines using superchargers, turbochargers, and aftercoolers in various combinations
2. Gas turbine engines using intercoolers, regenerators, and aftercoolers in various combinations

TABLE 2-1

CHARACTERISTICS OF THERMODYNAMIC CYCLES

CYCLE	PV DIAGRAM	THERMAL EFFICIENCY	CHARACTERISTICS
Carnot	Fig. 2-1, (A)	$\eta_t = 1 - \frac{460 + T_r}{460 + T_A}$	ab isothermal heat rejection bc isentropic compression cd isothermal heat addition da isentropic expansion
Otto	Fig. 2-1, (B)	$\eta_t = 1 - \frac{1}{r_v^{k-1}}$	ab isentropic compression bc constant-volume heat addition cd isentropic expansion da constant-volume heat rejection
Diesel	Fig. 2-1, (C)	$\eta_t = 1 - \frac{1}{r_v^{k-1}} \left[\frac{L^k - 1}{k(L-1)} \right]$	ab isentropic compression bc constant-pressure heat addition cd isentropic expansion da constant volume heat rejection
Dual Cycle	Fig. 2-1, (D)	$\eta_t = 1 - \frac{1}{r_v^{k-1}} \left[\frac{r_p L^k - 1}{r_p - 1 + k r_p (L-1)} \right]$	ab isentropic compression bb' constant-volume heat addition b'c constant-pressure heat addition cd isentropic expansion da constant-volume heat rejection
Brayton	Fig. 2-2, (A)	$\eta_t = 1 - \frac{1}{r_p^{(k-1)/k}}$	ab isentropic compression bc constant-pressure heat addition cd isentropic expansion da constant-pressure heat rejection
Stirling	Fig. 2-2, (B)	$\eta_t = 1 - \frac{460 + T_r}{460 + T_A}$	ab isothermal compression bc constant-volume heat addition cd isothermal expansion da constant-volume heat rejection
Rankine	Fig. 2-2, (C)	$\eta_t = 1 - \frac{h_b - h_c}{h_b - h_d}$	ab = constant pressure admission bc = isentropic expansion cd = constant pressure exhaust

Legend:

η_t = thermal efficiency, percent expressed as decimal

h_b = enthalpy of the steam admitted, Btu/lbm

h_c = enthalpy of the steam exhausted, Btu/lbm

h_d = enthalpy of liquid in steam exhaust, Btu/lbm

k = specific heat ratio at constant pressure and constant volume, dimensionless

T_A = temperature of heat source, °F

T_r = temperature of heat sink, °F

L = cutoff or load ratio, V_b/V_c (V_c is determined by the termination of the fuel injection process)

r_p = constant-volume pressure ratio (P_b/P_a)

r_v = compression ratio V_b/V_a , dimensionless

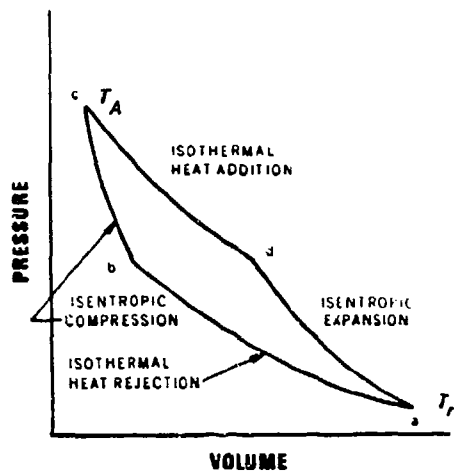

(A) CARNOT CYCLE

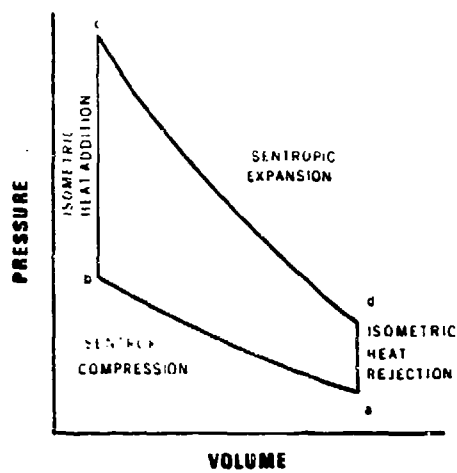

(B) OTTO CYCLE

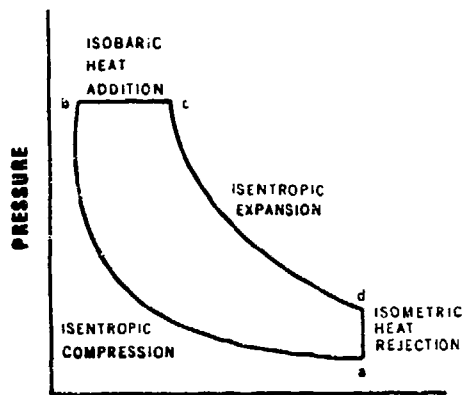

(C) DIESEL CYCLE

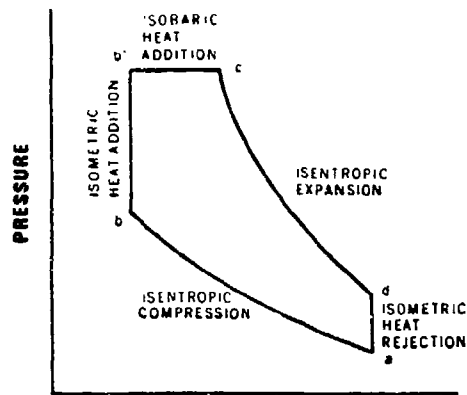

(D) DUAL CYCLE

Figure 2-1. Thermodynamic Cycles—Carnot, Otto, Diesel, and Dual (Ref. 3)

3. Free piston engines to act as a gas producer for a Brayton cycle engine

4. Variable compression ratio engines

5. Hybrid engines such as the differential compound engine.

With the exception of the hybrid engines, all of these designs have been used in contemporary military applications.

2-1.4 CONVENTIONAL RECIPROCATING ENGINE HEAT REJECTION

The two methods of transferring heat from the engine to the atmosphere are direct or air-cooling, and indirect or liquid-cooling. In the direct air-cooling system, air is blown directly onto finned engine cylinders and cylinder heads. In the indirect or liquid-cooled system, coolant is circulated through the engine. Heat from the engine

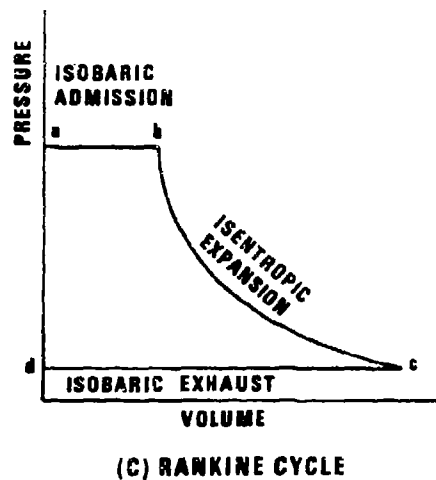
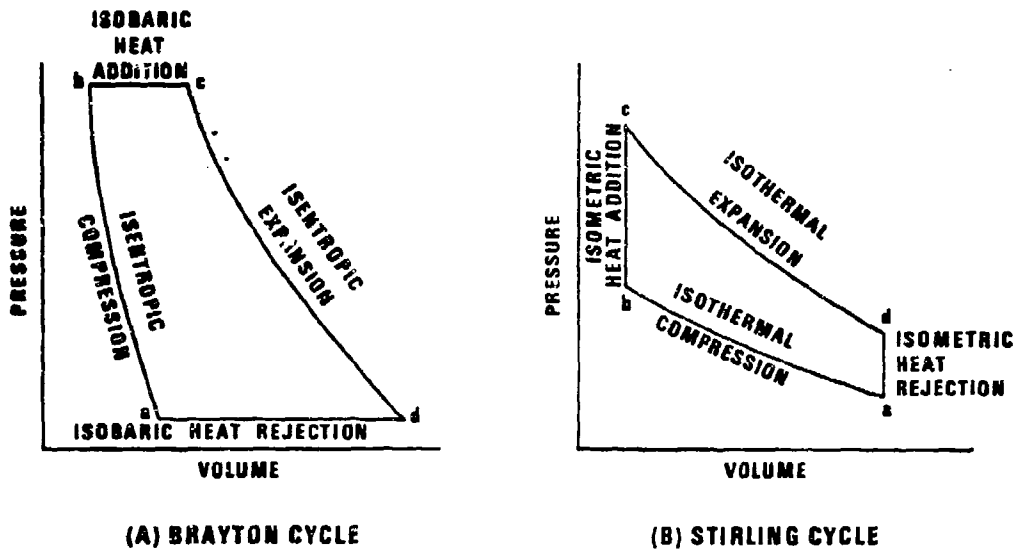

Figure 2-2. Thermodynamic Cycles—Brayton, Stirling, and Rankine (Refs. 3 and 19)

cylinders and cylinder heads is transferred to the coolant. The hot coolant then passes through a radiator where the heat is transferred to the air (see Ref. 27).

In any type of combat vehicle, and particularly in tanks, the difficulties of

cooling are tremendous, because the engine is virtually enclosed. Either air-cooling or liquid-cooling systems, properly designed, is acceptable. The choice of either an air-cooled or liquid-cooled engine for a particular vehicle usually is based on a trade-off study that evaluates all vehicle system specifications (see

AMCP 706-361

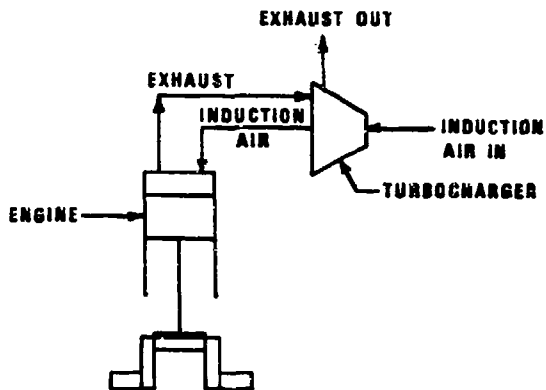

(A) ELEMENTARY COMPOUND ENGINE

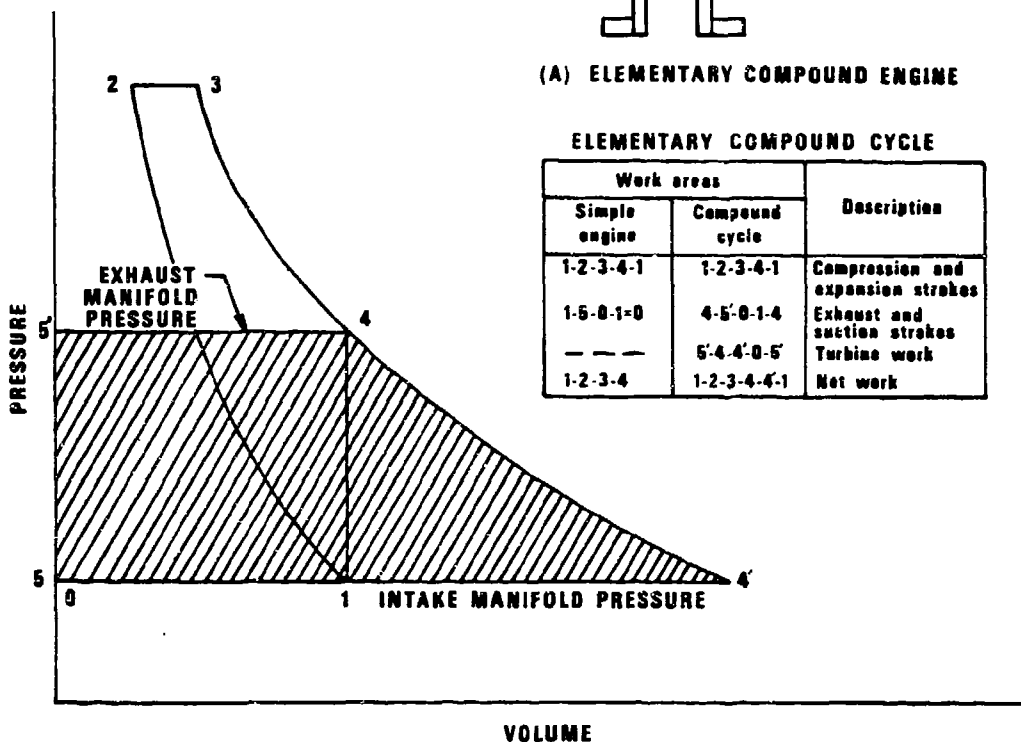

ELEMENTARY COMPOUND CYCLE

Work areas		Description
Simple engine	Compound cycle	
1-2-3-4-1	1-2-3-4-1	Compression and expansion strokes
1-5-0-1-0	4-5-0-1-4	Exhaust and suction strokes
---	5-4-4'-0-5'	Turbine work
1-2-3-4	1-2-3-4-4'-1	Net work

(B) COMPOUND AIR CYCLE (Ref. 34)

(From *Fundamentals of Classical Thermodynamics* By G. VonHulst and P. Sonntag, 1968, Reprinted by permission of John Wiley & Sons, Inc.)

Figure 2-3. Elementary Compound Thermodynamic Cycle

par. 8-4). The cooling system designer then must determine the optimum design required to provide an adequate cooling system.

If the cooling system designer is using a fully developed engine, the heat rejection rate will be available readily from actual testing. If a new engine is being developed an estimate of the heat rejection rate must be made.

2-1.5 METHODS USED TO ESTIMATE ENGINE HEAT REJECTION

It is frequently necessary to estimate the heat rejection rate for engines that are still in the design stage. The starting point in estimating the heat rejection rate is a comparison with existing engines with known heat rejection rates and design characteristics. An understanding of the relationship of various engine operating principles also is necessary to arrive at an accurate heat rejection rate estimate. The following principles must be considered:

1. Heat rejection rate will vary ± 5 percent between engines of the same model.
2. Heat rejection rate at no load is a linear function with speed.
3. Heat rejection rate increases in proportion to increased horsepower output.
4. Heat loss to the combustion chamber walls varies inversely with the bore/stroke ratio.
5. Ignition timing of spark ignition engines strongly influences low speed part-throttle heat rejection rate.
6. Increasing the fuel-air ratio decreases the heat loss by using the fuel as a coolant (heat of vaporization); however, this reduces the engine efficiency.
7. Increasing the compression ratio will increase engine thermal efficiency and de-

crease the heat loss per brake horsepower developed.

The given characteristics can be summarized to the effect that engine heat rejection rate is changed by a change in the:

1. Mean temperature of the combustion gases
2. Engine heat transfer characteristics
3. Area exposed to the combustion gases.

In general the engine heat rejection to the coolant, exhaust gases, and by radiation is slightly higher in a spark ignition than a compression ignition engine. However, the engine heat generated due to friction is slightly higher in a compression ignition engine.

A discussion of internal combustion engine heat rejection and cooling requirements that may be of interest to the reader is found in Ref. 28.

Figs. 2-4 through 2-9 show the heat rejection characteristics of diesel engines used to power contemporary military vehicles.

Fig. 2-10 illustrates the heat rejection to the lubricating oil for the AVDS-1790 air-cooled engine used to power the M60 Tank. Figs. 2-4 to 2-10 indicate that the heat rejection to the engine oil increases at a nearly constant rate proportional with increased engine speed. The rate of heat rejection to the engine oil also is proportionally higher for the engines with higher horsepower.

Fig. 2-11 shows the heat rejection rate per cylinder for the 1250 hp AVCR-1100-3R air-cooled, 12-cylinder engine as a function of the cooling air pressure drop across the cylinders and the cooling air temperature. Note the decrease in heat rejection with increased ambient temperatures. Table 2-2 summarizes the cooling system characteristics of a number of military vehicles.

AMCP 706-361

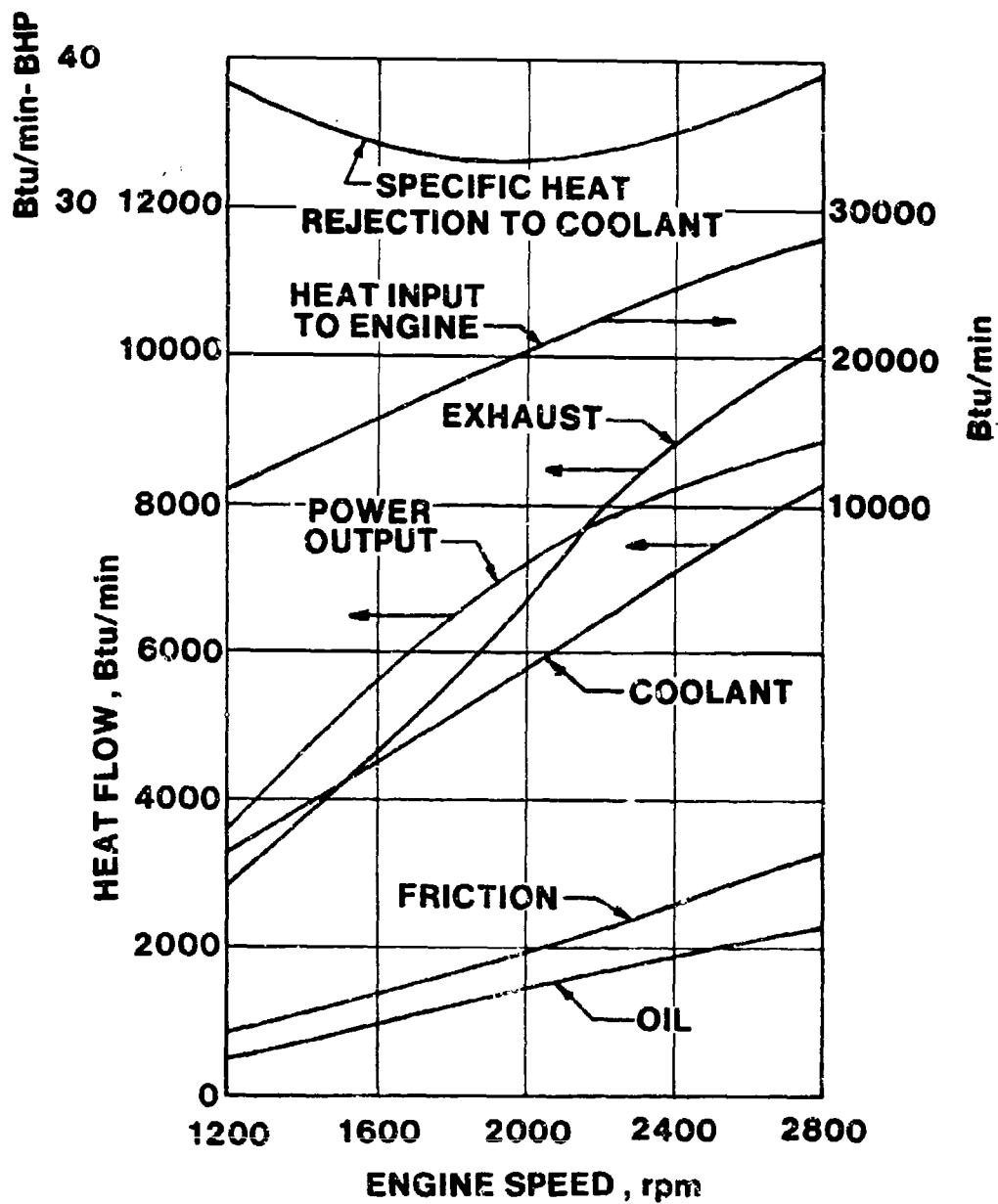
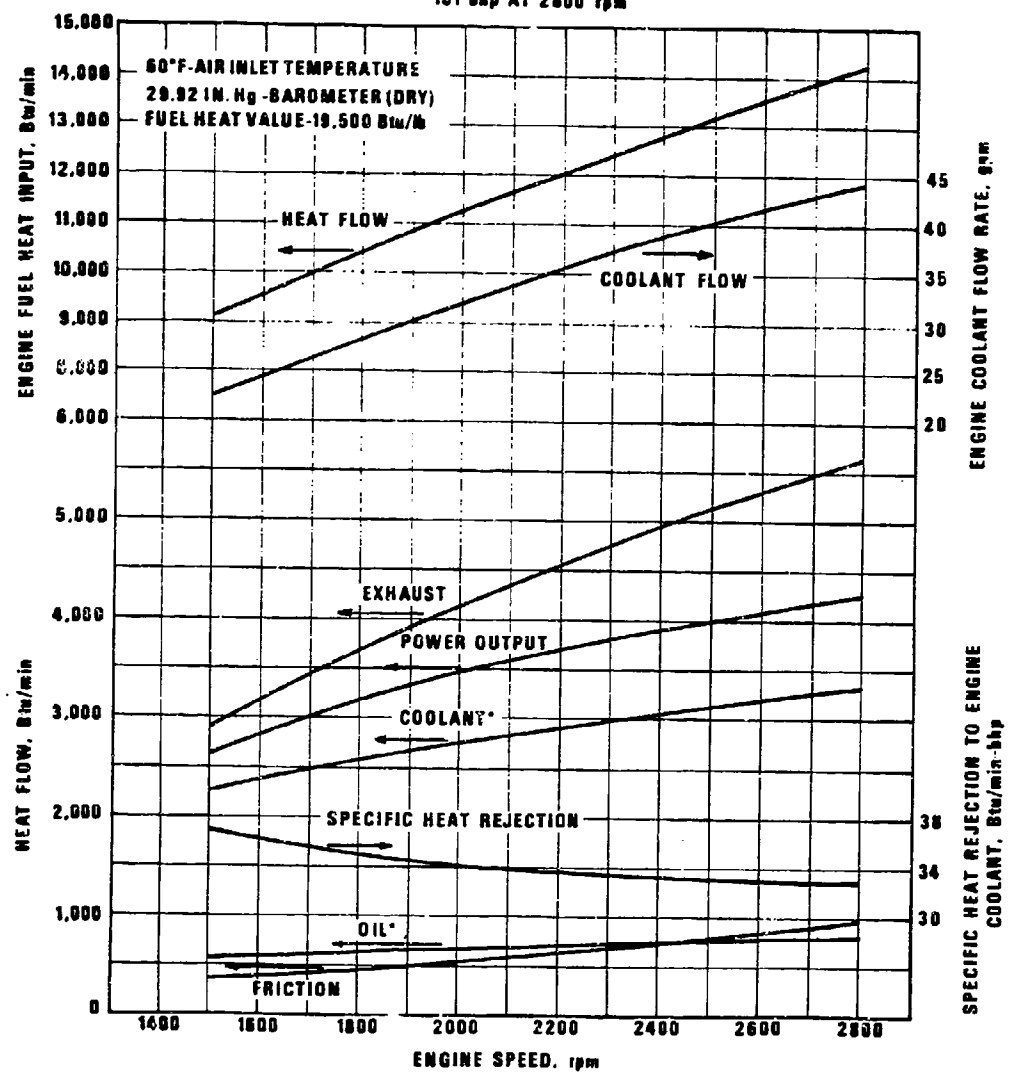

Figure 2- . Heat Flow Characteristics of LDS-465-1B Truck Diesel Engine (Ref. 17)

**DETROIT DIESEL ALLISON DIVISION
 HEAT FLOW CHARACTERISTICS
 3-53N ENGINE
 N50 INJECTORS
 101 bhp AT 2800 rpm**



*HEAT REJECTION TO OIL IS INCLUDED
 IN THE HEAT REJECTION TO COOLANT

Figure 2-5. Heat Flow Characteristics of 3-53N Gamma Goat Diesel Engine

AMCP 706-361

**DETROIT DIESEL ALLISON DIVISION
 6V-53N ENGINE
 HEAT FLOW CHARACTERISTICS
 216 bhp AT 2800 rpm
 N50 INJECTORS**

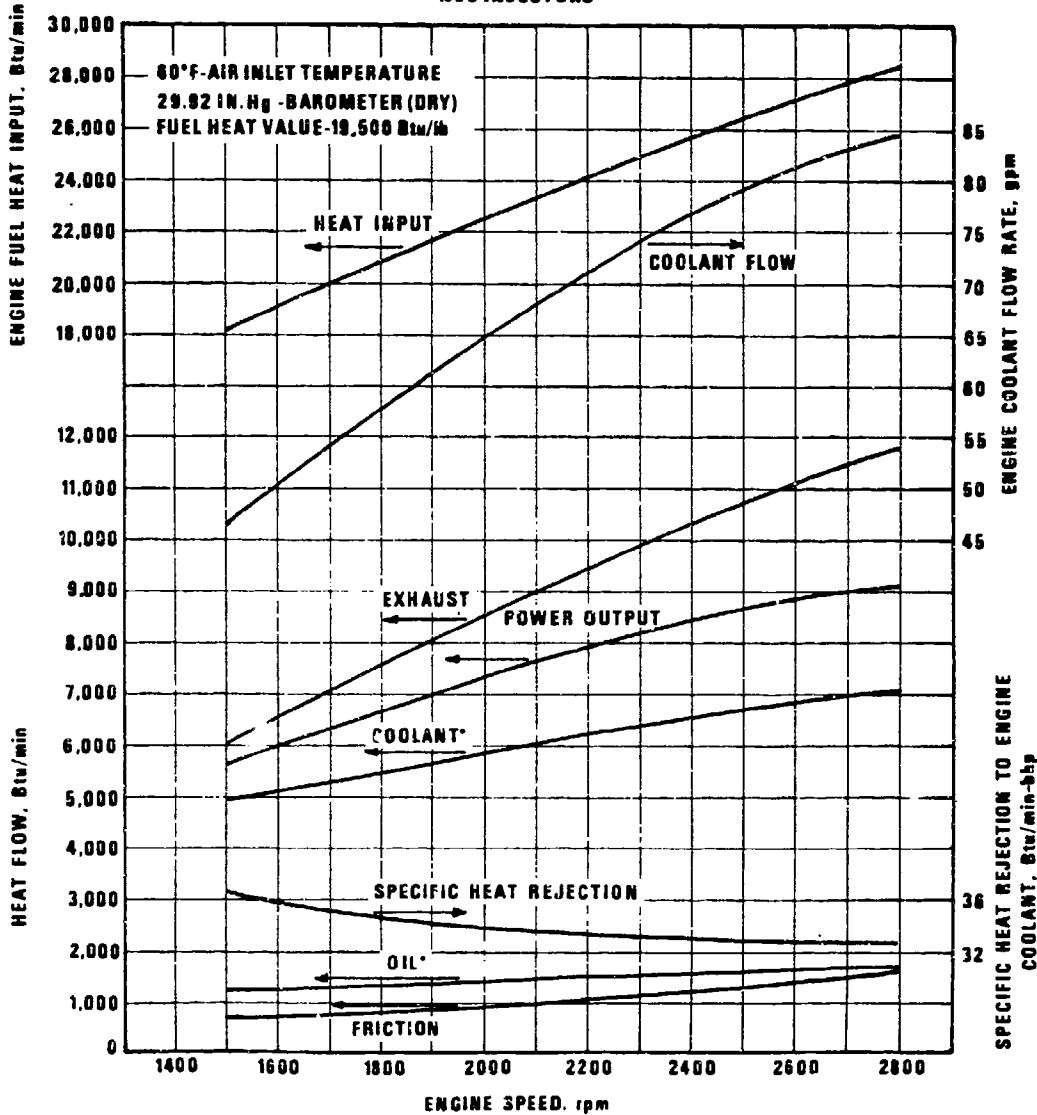

*HEAT REJECTION TO OIL IS INCLUDED
 IN THE HEAT REJECTION TO COOLANT

Figure 2-6. Heat Flow Characteristics of 6V-53N Diesel Engine Used in the M113A1 Vehicle

**DETROIT DIESEL ALLISON DIVISION
 6V-53T ENGINE
 HEAT FLOW CHARACTERISTICS
 T1899 TURBOCHARGER-N70 INJECTORS
 300 bhp AT 2800 rpm**

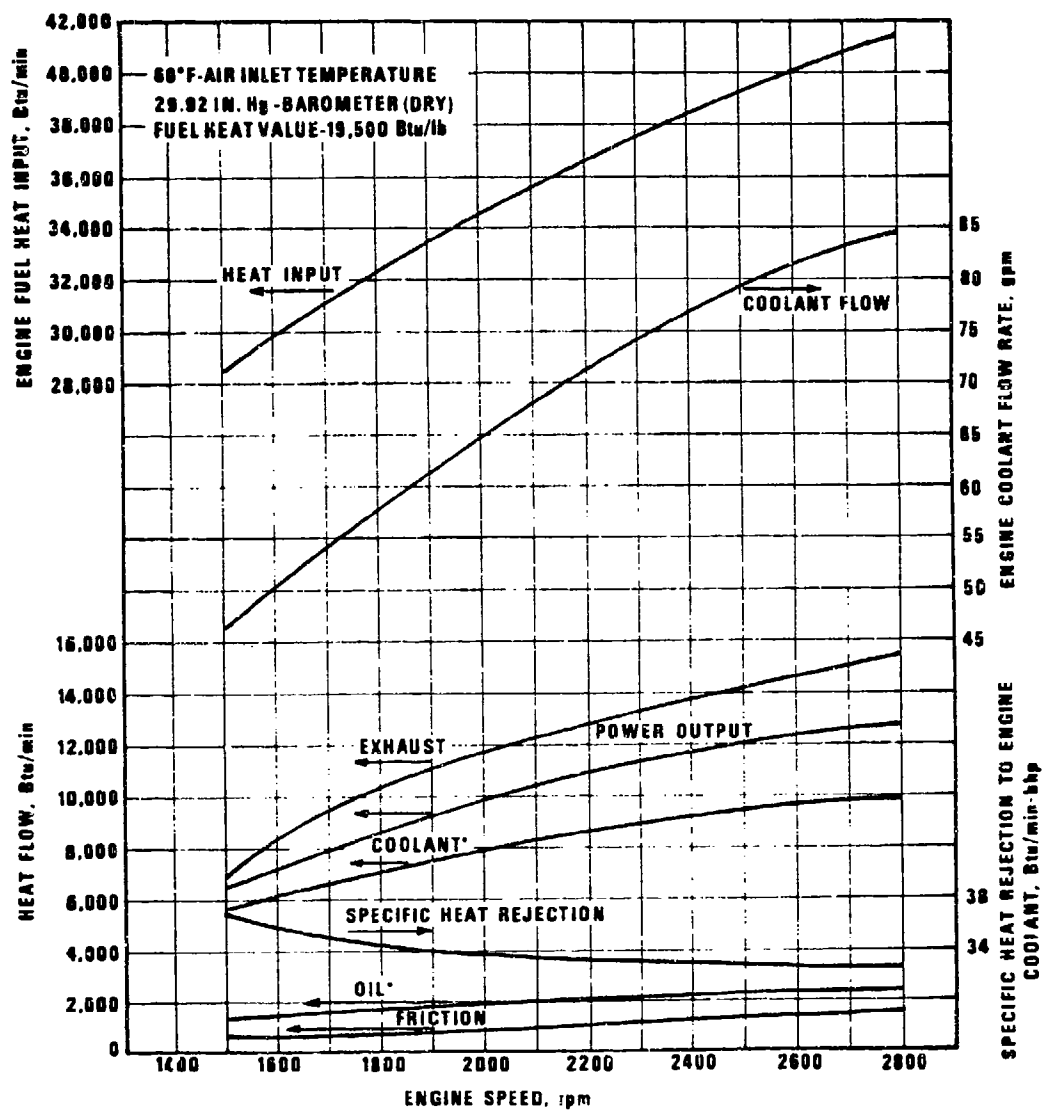

*HEAT REJECTION TO OIL IS INCLUDED
 IN THE HEAT REJECTION TO COOLANT

Figure 2-7. Heat Flow Characteristics of 6V-53T Diesel Engine Used in the Scout and M551 Vehicles

**RV-71T ENGINE
 HEAT FLOW CHARACTERISTICS
 T-3030 TURBOCHARGER, NO. 4 NOZZLE (4.01 IN²)
 N80 INJECTORS WITH PRESSURE RATIO CONTROLLED
 405 bhp AT 2300 rpm**

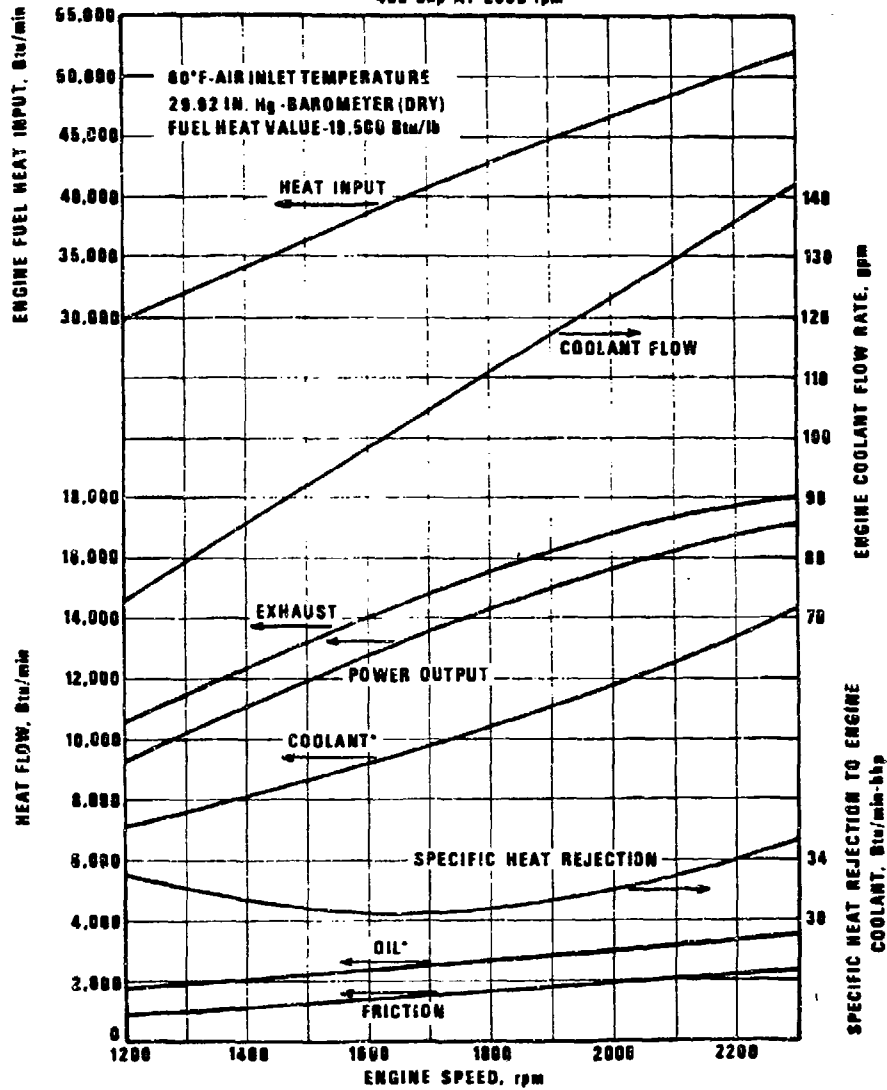

*HEAT REJECTION TO OIL IS INCLUDED
 IN THE HEAT REJECTION TO COOLANT

Figure 2-8. Heat Flow Characteristics of RV-71T Diesel Engine Used in the M107, M108, M109, M110, and M578 Vehicles
 (Courtesy of Detroit Diesel Allison Division, General Motors Corporation)

DETROIT DIESEL ALLISON DIVISION
 HEAT FLOW CHARACTERISTICS
 12V-71T ENGINE
 NBB INJECTORS, T18A48 TURBOCHARGER
 600 bhp AT 2500 rpm

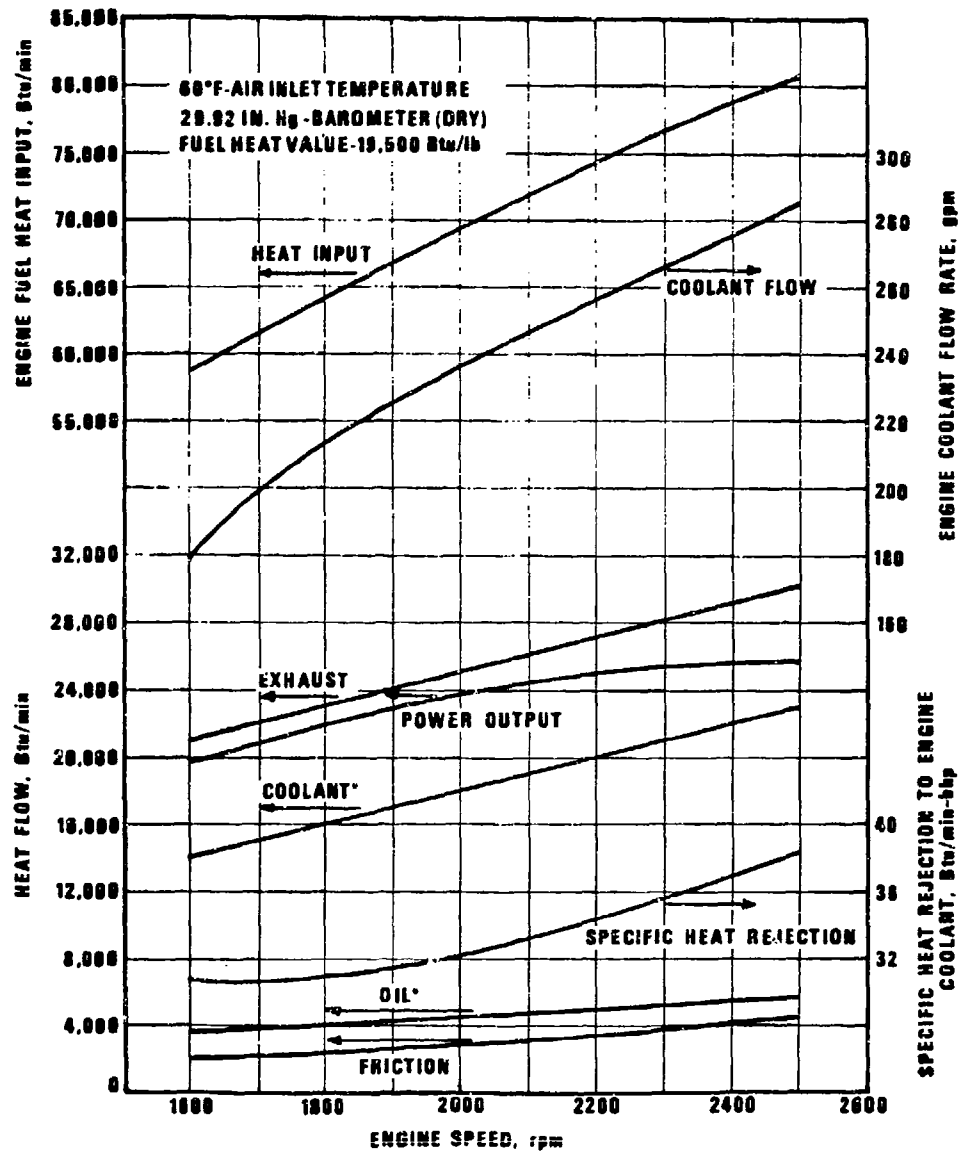

*HEAT REJECTION TO OIL IS INCLUDED
 IN THE HEAT REJECTION TO COOLANT

Figure 2-9. Heat Flow Characteristics of 12V-71T Diesel Engine Used in the M746 Vehicle

AMCP 708-381

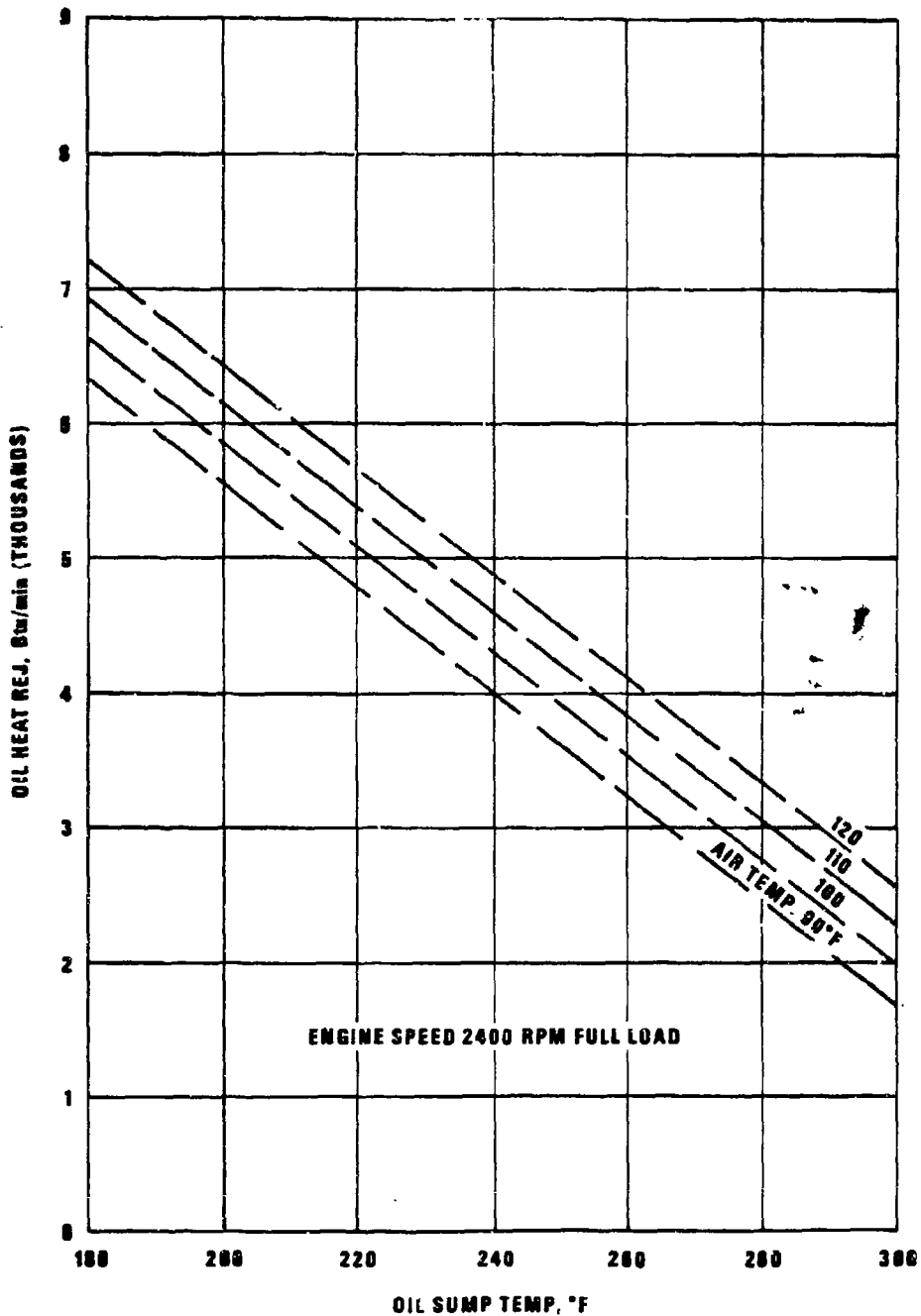

Figure 2-10. AVDS-1790 Tank Diesel Engine-to-Oil Heat Rejection Characteristics

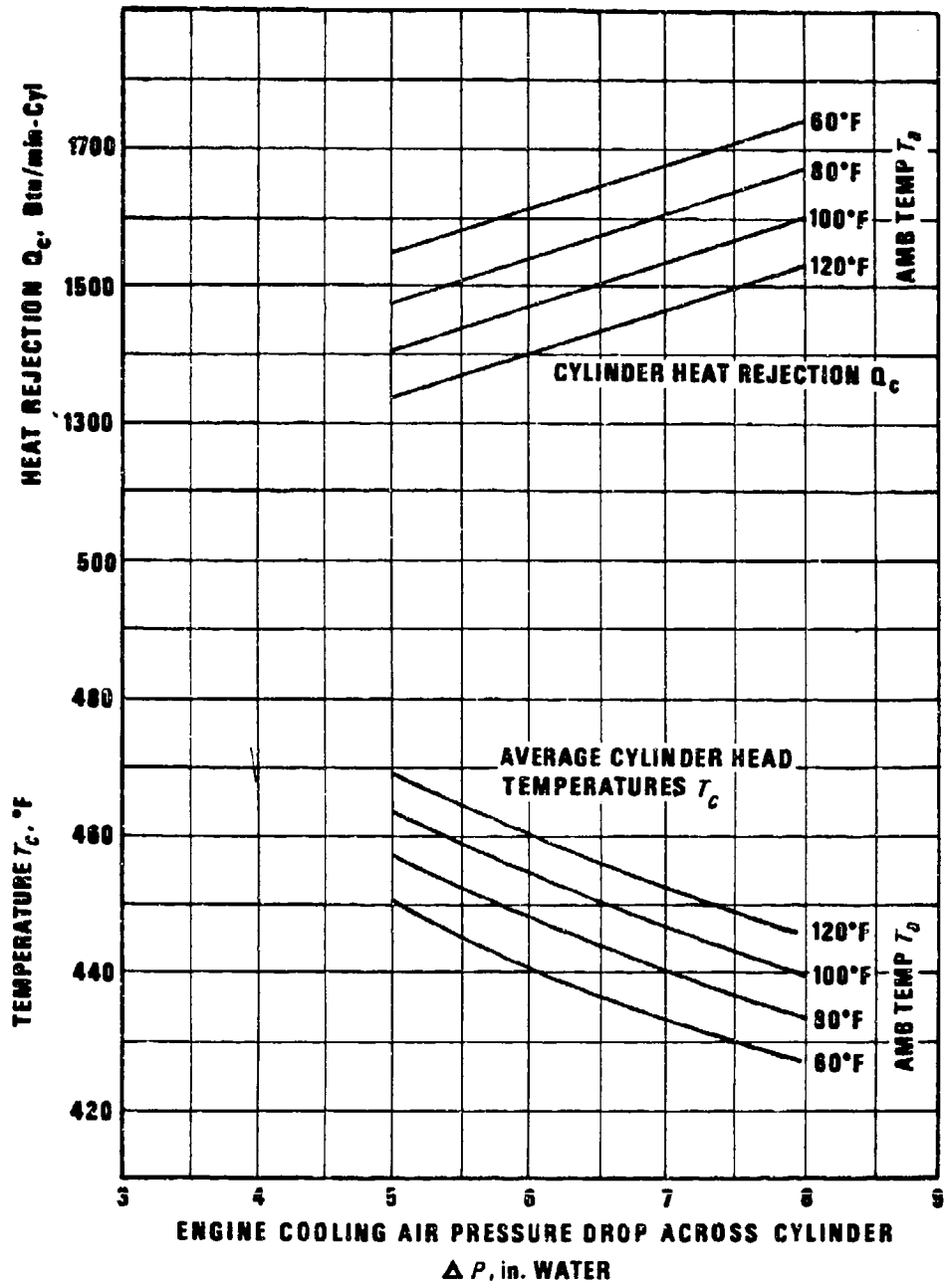

Figure 2-11. AVCR-1100-3B Cylinder Head Temperatures and Heat Rejection

TABLE 2-2

COOLING SYSTEM SUMMARY OF MILITARY VEHICLE INSTALLATIONS

Engine	Vehicle Model	HP			AP, in. water		Flow			
		Gross	Fan	Percent in Fan	Cyl.	System	Coolant, gpm	Cooling Air, cfm	Engine Oil, gpm	Engine Type
AVSI-1790-6	M51	1000	172	17.2	11	15	na	28,000 H	45	SI
AVI-1790-8	M48	825	136	16.5	7	11	na	26,000 H	45	SI
AV-1790-7	M47	810	120	14.8	7	11	na	26,000 H	45	SI
AOSI-895-5	M41	525	75	14.3	11	14	na	14,400 H	35	SI
AO-895-4	M75	375	56	14.9	7	11	na	13,000 H	29.7	SI
AOI-1195-5	T95	560	50	8.9	6	9	na	17,500 H	40	SI
AOI-628-3	T92	365	36	9.9	5	9	na	11,000 C	15	SI
AOI-470-1	M561E1	260	23	8.8	5	7	na	8,300 C	15	SI
AOSI-314-2	T113	208	25	12.0	9	12	na	5,500 C	13	SI
AVDS-1790-2	M60	750	107	14.3	6	12	na	23,000 H	70	CI
AVDS-1100-1	T95	550	80	14.5	7	10	na	19,500 H	50	CI
AVCP-1100-3	M8T70	1475	172	11.7	10	16	na	39,600 H	80	CI
AVDS-750-1	T236	425	66	15.5	7	10	na	14,500 H	50	CI
LDS-427-2	M35	140	8	5.7	na	na	70	6,600 H	20	CI
LDS-465-2	M35A2	210	21	10.0	na	na	100	7,300 H	22	CI
GM 8V-71	T236	392	52	13.3	na	na	115	X	39	CI
GM 8V-71T	M109	405	55	13.6	na	na	142	17,000 H	39	CI
Chrysler 361	M113	215	21	9.8	na	na	80	9,600 C	X	SI
GM 6V-53	M113A1	215	24	11.2	na	na	85	9,600 C	30	CI
GM 6V-53T	M551	215	X	X	na	na	84	14,000 H*	30	CI
GM 8V-71T	M110	405	55	13.6	na	na	142	X	39	CI
GM 8V-71T	M107	405	55	13.6	na	na	142	X	39	CI
M151-2	M151	71	X	X	na	na	28	X	6.3	SI
VT903	MICV	320	X	X	na	na	127	X	36	CI
12V-71T	HET	600	75	12.5	na	na	260	20,000 C	62	CI
12V-71T	M746	600	75	12.5	na	na	260	20,000 C	62	CI
12V-71T	M551	300	45	15.0	na	na	89	14,500 C	62	CI
12V-71T	M110	405	61	15.1	na	na	150	18,000 C	62	CI
Chevy 283	M114	143	38	25.7	na	na	68	X	X	SI
355	M561	101	7	7.0	na	na	44	X	X	CI
AMC-OHC-6-230	M715	133	8	6.0	na	na	36	X	X	SI
Ford 151	M151	71	6	8.5	na	na	28	X	6.3	SI

Legend: C = volume flow rate of cold air, H = volume flow rate of heated air, na = not applicable
 SI = spark ignition engine, CI = compression ignition engine
 X = not available, * = design value

2-1.6 COOLANTS

typical air-cooled tank engine oil cooler.

2-1.6.1 Lubricating Oil

Engine lubricating oil absorbs heat from combustion gases and also absorbs heat generated by mechanical friction. Adequate oil cooling must be provided to keep the lubricating oil temperature within an acceptable level. Either an air-cooled or liquid-cooled system may be used. Fig. 2-12 illustrates a typical integral liquid-cooled engine oil cooler and Fig. 2-13 illustrates a

The distribution of the total heat flow among radiation, jacket cooling, and engine oil cooling varies with the engine design and cooling system arrangement. High output diesel engines with oil-cooled pistons reject approximately 5 to 10 percent of the total input heat into the engine oil.

2-1.6.2 Air

The thermodynamic properties of air are

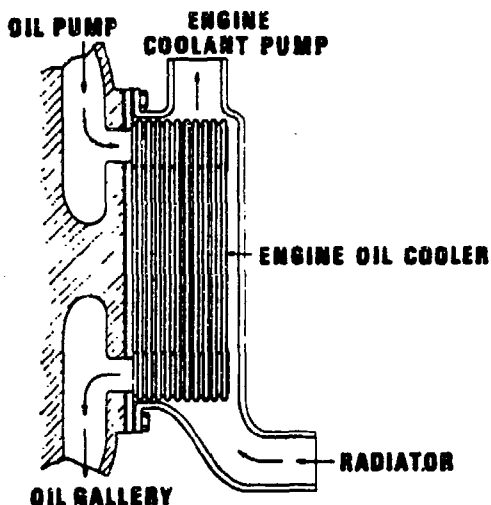

Figure 2-12. Integral Engine Oil Cooler
 (Ref. 27)

(Release Granted by Society of Automotive Engineers, Inc., Paper No. SP-284.)

presented in Figs. 3-42, 3-47, and Ref. 1. Selected properties of air at 70°F and 14.7 psia are presented for convenience.

1. Thermal conductivity = 0.015 Btu/hr-ft²-(°F/ft)

2. Density = 0.075 lbm/ft³*

3. Specific heat = 0.24 Btu/lbm-°F*

2-1.8.3 Liquids

Liquid coolants generally have a water base with varying amounts of ethylene glycol added as necessary to provide protection against freezing. Fig. 2-14 illustrates the effect of varying the concentration of ethylene glycol and the heat transfer characteristics for 30 and 70 percent solutions. An increase in the concentration of ethylene glycol reduces

*Refer to Preface for a discussion of units.

the heat transfer rate to the coolant for the same mean temperature difference between fluids. This effect is accounted for mainly by the difference in specific heat values for water (1.0 Btu/lbm-°F) and ethylene glycol (0.602 Btu/lbm-°F). Physical properties of water are shown in Fig. 3-43. See par. 9-4.5.6 for comparative M551 vehicle cooling tests using water and ethylene glycol/water solutions.

2-1.7 CYLINDER COOLING FINS (Refs. 2 and 13)

Three basic shapes of cylinder cooling fins are shown in Fig. 2-15. The top fin is in the form of a rectangular cross section with constant thickness along the length. A fin could be machined in this manner, but attempting to cast a fin to this shape would be difficult because of the lack of draft. This shape also results in waste of material. The second fin is triangular in cross section and although it fulfills all thermal requirements, has the disadvantage of having a sharp edge, making difficult handling, and low strength near the outside diameter. The third fin is trapezoidal in cross section. The removal of heat from the cylinder wall to the outer diameter results in the heat flow diminishing as the outside diameter is approached and fin thickness gradually is reduced for better utilization of material. This fin can be cast with comparative ease and has good strength characteristics. Generally, it is advantageous to have a large number of thin fins, provided the ability to manufacture is maintained and they are not spaced so close that the airflow between them is reduced. The problem of fin plugging with foreign material also must be given consideration in deciding on the spacing of fins. An air-cooled engine will require a fin area that is from 5 to 20 times the internal hot gas area.

2-1.8 EXHAUST MANIFOLDS

Piston engine heat rejected into the exhaust system represents a large percentage of the energy contained in the fuel (see Fig. 2-4).

AMCP 708-381

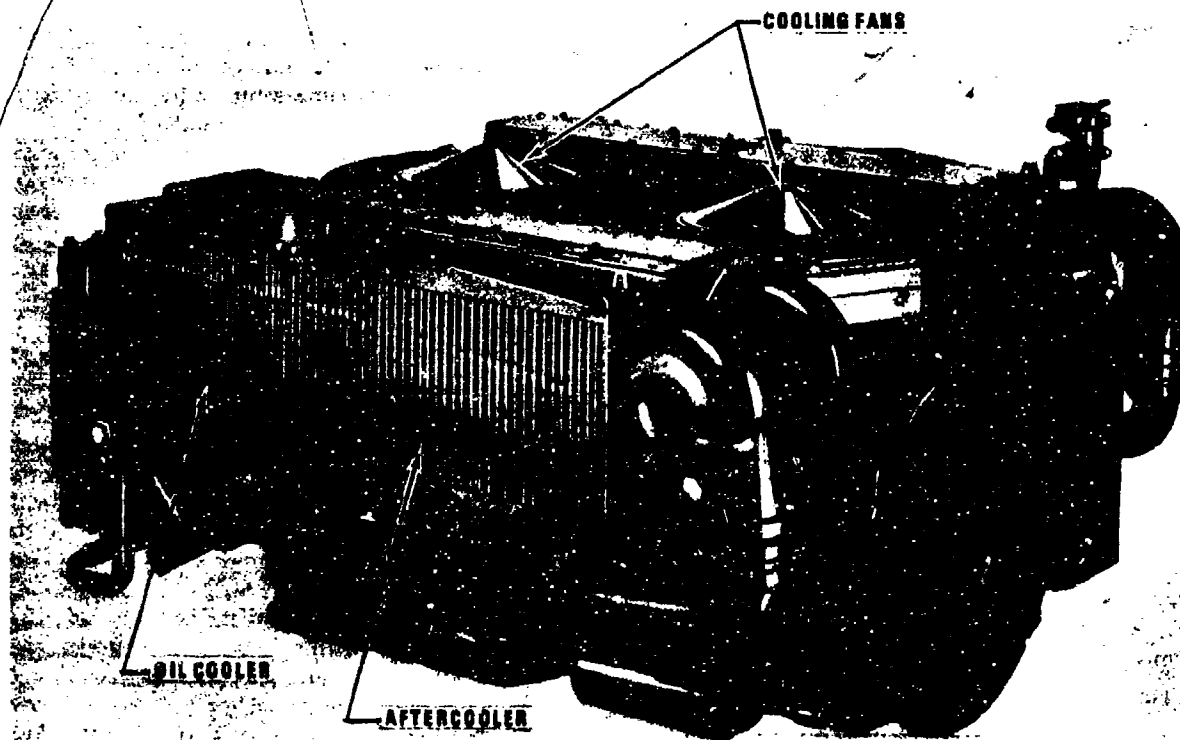

Figure 2-13. AVCR-1100-3B Tank Engine Oil Cooler Mounting

The recovery of a portion of this energy can be accomplished by the use of a turbocharger or air exhaust gas ejector (see par. 4-17).

In combat vehicles, the exhaust system usually is insulated and shielded to prevent damage to accessories installed in the engine compartment, to minimize radiated heat transfer into the compartment, and to decrease the IR signal emission.

2-1.9 GAS TURBINE ENGINE HEAT REJECTION

2-1.9.1 Lubricating Oil

Vehicle installations of gas turbine engines normally require a provision for a oil-to-air heat exchanger. The heat rejection to the lubricating oil varies with engine design but normally ranges from 6 to 10 percent of the

rated power output. Fig. 2-16 illustrates the turbine engine oil cooler installation for the Allison GT-404 engine.

2-1.9.2 Exhaust System

The turbine exhaust system performs the function of removing the exhaust gas from the engine and discharging it to the atmosphere. Heat rejected in the turbine engine exhaust is not a major concern for the vehicle cooling system designer, however, the installation must consider insulation of the exhaust system from other components, compartment ventilation, IR shielding, and provisions for thermal expansion of the exhaust system in addition to ballistic protection in combat vehicles.

A regenerative heat cycle often is used to improve turbine engine thermal efficiency by

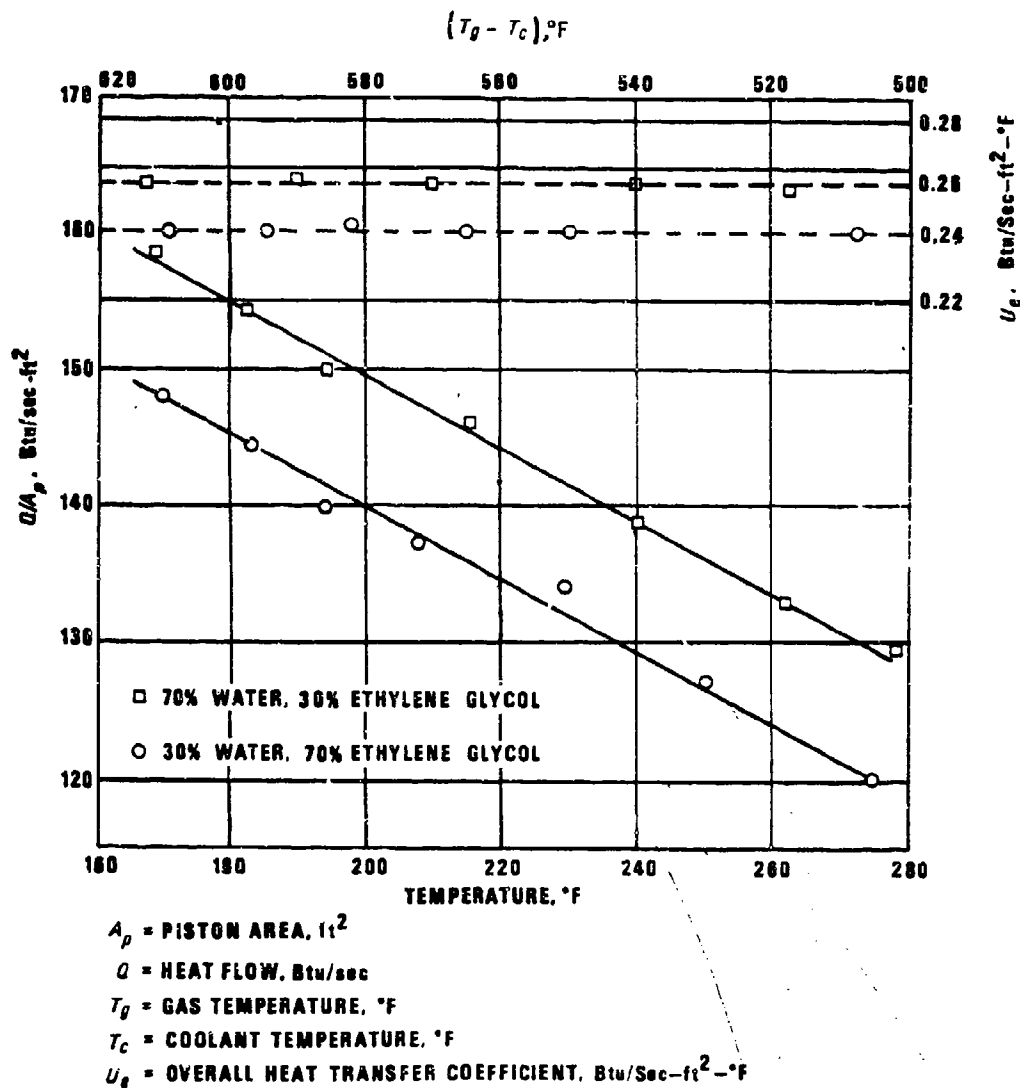

Figure 2-14. Effect of Coolant Temperature and Coolant Composition on Heat Transfer for a 12-cylinder, Liquid-cooled, 980 IHP, Aircraft Engine (Ref. 1)
 (Reprinted from the Internal Combustion Engine in Theory and Practice, the MIT Press.)

AMCP 708-381

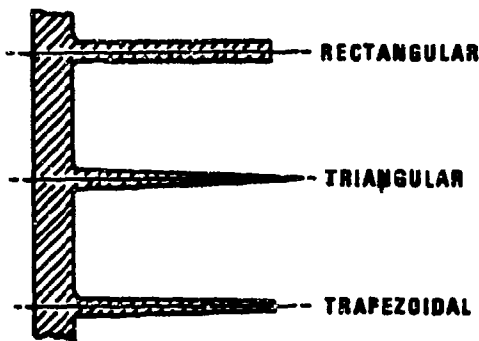

Figure 2-15. Basic Shapes of Cylinder Fins

extracting heat from the exhaust and using it to preheat the cold combustion intake air. A gas-to-air heat exchanger is used for this purpose.

2-1.10 OTHER TYPES OF VEHICLE ENGINES

2-1.10.1 Stirling Engine

The Stirling-cycle engine is a potential power source for future military vehicles. This engine operates by igniting the fuel in a combustion chamber to provide the heat to expand a gas within an external cylinder. Fuel burning is continuous, and the cylinder is separate from the combustion chamber. The engine operates relatively free from noise and vibration. Both liquid-cooled and air-cooled engines currently are being evaluated for military applications (see Ref. 4). Cutaway views of typical Stirling engines are shown in Figs. 2-17 and 2-18.

The Stirling engine is an external combustion engine using a combustion circuit external to the engine working cylinder that is in a closed circuit and uses a working fluid such as hydrogen or helium. The cooling system can be either a circulating liquid system or air-cooled system similar to conventional internal combustion engine cooling systems. A typical liquid-cooled

system schematic is shown in Fig. 2-19. Cooling is provided for the engine and individual components such as the fuel nozzle and the hydrogen compressor. The coolant flows through the engine cooler and to the top tank of the radiator. Two additional parallel flow paths to the radiator are provided at the engine cooler inlet: the fuel nozzle circuit and the buffer space circuit. At the engine cooler outlet, a portion of this flow is directed through the exhaust gas heat exchanger and the passenger compartment heater core.

Fig. 2-20 illustrates the engine performance for a single cylinder Stirling engine. Heat rejection characteristics of a small Stirling engine are shown in Table 2-3.

Stirling engine vehicle installations have been made by Philips Research Laboratories, Eindhoven, Netherlands. They project a heat rejection rate of 2 hp per output horsepower for automotive applications and 1.4 hp of heat rejected per output horsepower for their

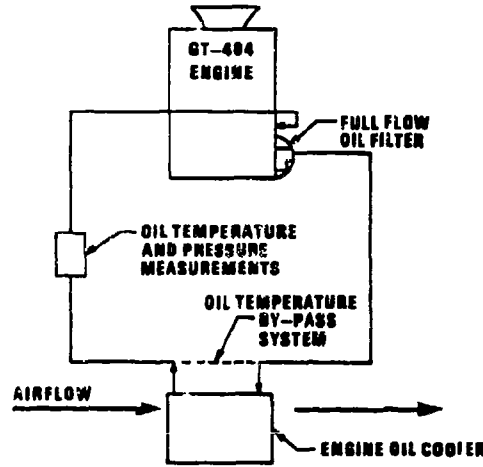

Figure 2-16. Gas Turbine Engine Oil Cooler Installation Schematic Diagram (Ref. 22)

(Release Granted by Society of Automotive Engineers, Inc., Paper No. 720695.)

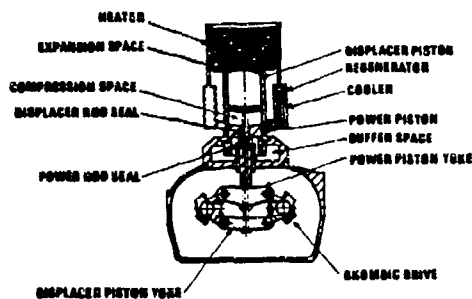

Figure 2-17. Cut-away View of the Stirling Engine (Ref. 5)

(Release Granted by Society of Automotive Engineers, Inc., Paper No. 690731.)

industrial engines. This represents an efficiency of 33 and 42 percent, respectively, which is good in comparison with contemporary automotive engines. The heat rejected to the engine oil system is about 10 percent of the heat input for automotive applications and 7 percent for industrial engines.

The vee configuration engine shown in Fig. 2-18 is presently in the prototype stage for vehicle application and uses hydrogen as the working fluid. The engine has a specific weight and volume comparable with current gasoline engines. With further development, engines of 3 lb/BHP and 0.05 ft³/BHP are expected.

For vehicle applications, the coolant for the Stirling engine must dissipate approximately two and one-half times the heat dissipated by a diesel engine of comparable power, at the lowest possible coolant temperature, to obtain high engine efficiency. Trade-offs in Stirling engine efficiency could be made to reduce the radiator size required for a specific application.

2-1.10.2 Rotating Combustion Engine (Wankel)

The Wankel engine is a positive displace-

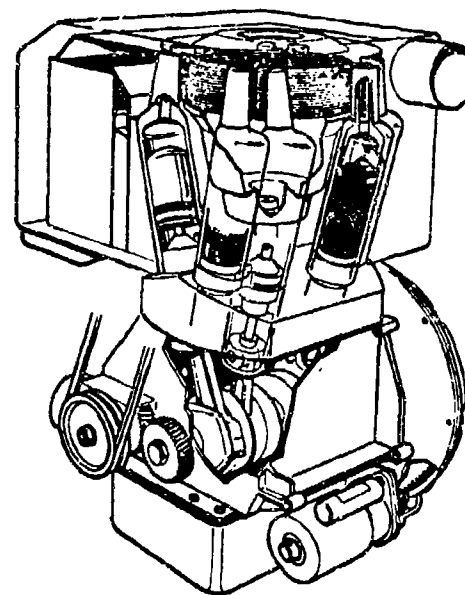

Figure 2-18. Typical Configuration of a Vee-type Double-acting Stirling Engine (Ref. 30)

(Courtesy of Railway Gazette International, From "Combustion Engine Progress", 1973)

ment engine which uses a three-lobe rotor rotating in a trochoidal housing and produces one working stroke for each revolution of the shaft. The engine can be either air-cooled or liquid-cooled. Typical engine cooling arrangements are shown in Fig. 2-21.

The cooling characteristics of the Wankel engine are comparable with the conventional piston engine, and the vehicle cooling system requirements are similar also. Fig. 2-22 illustrates the exhaust gas temperatures and related heat rejection to the coolant and lubricating oil for the NSU engine Model KKM 250-7 (Ref. 7) and the Model KKM 2 X 500 cm³. A schematic diagram of the Curtiss-Wright Model, RC2-60-U5, cooling system is shown in Fig. 2-23. Figs. 2-24, 2-25, and 2-26 illustrate the cooling system heat rejection characteristics of this engine.

AMCP 706-361

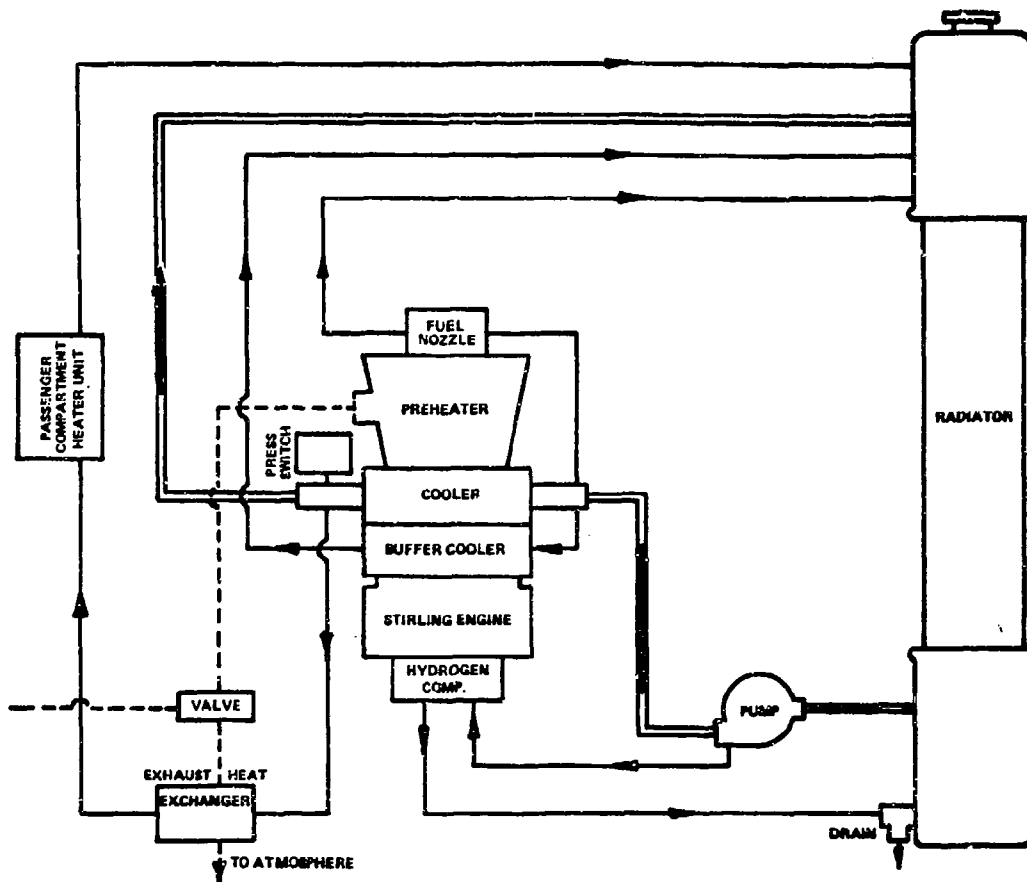

Figure 2-19. Stirling Engine Cooling System (Ref. 6)
 (Release Granted by Society of Automotive Engineers, Inc., Paper No. 690074.)

2-1.10.3 Rankine Cycle Engine

A number of Rankine cycle engines are being developed for automotive application. Development work is being done on both positive displacement expanders as well as turbine expanders using inorganic working fluids. (Ref. 26 describes typical program.)

The present state of the art does not lend itself to light, compact, engine installation designs suitable for military usage.

2-1.11 OTHER TYPES OF ENGINE POWER SOURCES

2-1.11.1 Fuel Cells (Refs. 31 and 32)

Fuel cells for vehicle power systems have been evaluated and currently are eliminated from serious considerations based on the present state of the art.

A fuel cell powered M37 Army Truck (3/4-ton) was built and tested at the US Army

**MODEL GPU-2.5 (SINGLE CYLINDER-RHOMBIC)
 3000 RPM, 1300°F HEATER, 100°F WATER**

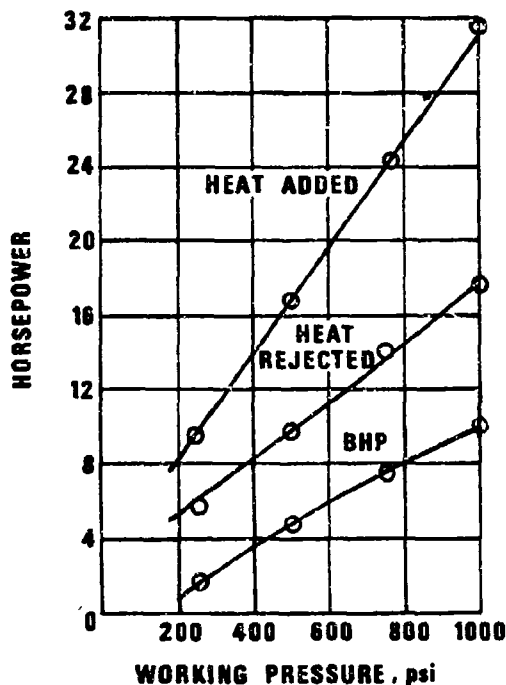

**NOTE : HEAT REJECTION SHOWN
 IS TO COOLANT ONLY**

*Figure 2-20. Single Cylinder Stirling Engine Performance Characteristics (Ref. 5)
 (Release Granted by Society of Automotive Engineers, Inc., Paper No. 690731.)*

Engineer Research and Development Laboratory, Fort Belvoir, Va. This vehicle used a hydrazine-air fuel system for evaluation. This fuel cell employed exotic catalysts, was large, heavy, expensive, and the fuels were not compatible with military logistics. However, the data obtained from this system proved the feasibility of fuel cell power for vehicle applications when the state of the art is advanced further.

Fuel cell systems may require heat exchangers, cooling fans, blowers, pumps,

condensers, and tanks to remove heat from the electrolyte and recover water from the anode and cathode exhaust streams.

2-1.11.2 Stored Electrical Energy

Batteries presently do not appear to be feasible as a single power source for military vehicles from basically a size and weight standpoint. Improvements in size, weight, and energy density could make battery systems attractive for special purpose applications.

AMCP 706-361

TABLE 2-3

STIRLING ENGINE HEAT BALANCE GPU 3, 15 HORSEPOWER (Ref. 5)

	Btu/hr	%
Heat in		
Fuel	109,617.6	68.5
Preheated air	50,515.4	31.5
Total	160,133.0	100.0
Heat out		
Engine power	24,050.7	15.0
Cooler water	43,431.6	27.1
Buffer water	2,572.4	1.6
Engine oil	1,994.7	1.2
Losses		
Nozzle water	1,707.9	1.1
Exhaust gas	78,577.1	49.1
Radiation loss, calculated	721.5	0.5
Convection loss, calculated	526.1	0.3
Unaccounted for	6,551.0	4.1

Release Granted by Society of Automotive Engineers, Inc., Paper No. 690731

storage of electrical energy have been evaluated (Ref. 20), however, the practicality of this system to vehicle propulsion systems has not yet been established.

2-1.11.3 Nuclear Energy

It is very doubtful if a nuclear reactor system will be feasible for vehicle application in the very near future. The cost of such a system would be high, and the required shielding has been found to be excessively heavy.

2-1.11.4 Combination Power Plants

A combination power plant such as that in the Swedish STV 103 Tank appears to combine the good qualities of the diesel engine and gas turbine. The economical diesel with its good part-load characteristics is used for normal cruise power, and the gas turbine with its useful torque characteristics can be switched in for high loads, difficult terrain, etc., or can insure that the tank is quickly operational in cold weather conditions.

This combination presents space and weight problems that result in limited stowage space for fuel. In addition to increased gearing costs to accommodate the turbine, there are

also many control problems and higher bearing loads.

This combination drive probably will not be introduced on a wider basis because of its higher cost, more complex operating principle, and increased logistic problems.

2-2 TRANSMISSION AND DRIVE COMPONENTS

2-2.1 MULTIPLE RATIO GEAR TRANSMISSIONS

Multiple ratio gear transmissions are defined as transmissions capable of producing step gear ratio change. For nonautomatic transmissions, these changes are selected manually by the vehicle operator, and a clutch mechanism is required to disconnect the power transfer to the transmission during gear ratio change. Table 2-4 is a glossary of commonly used power train terms.

It is usually desirable that the engine be operated only at speeds between the maximum torque point and maximum rated speed. To accomplish this, transmission ratios must be selected so that the available engine range in rpm can be converted to the required vehicle speed range, while still providing the

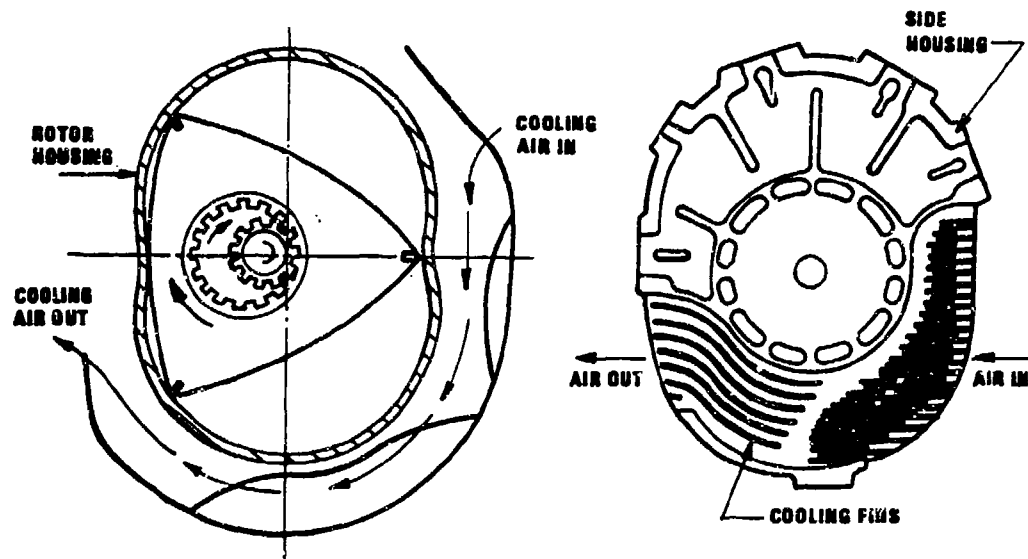

(A) AIR-COOLED

(Release Granted by Society of Automotive Engineers, Inc., Paper No. 288A) (Ref. 7)

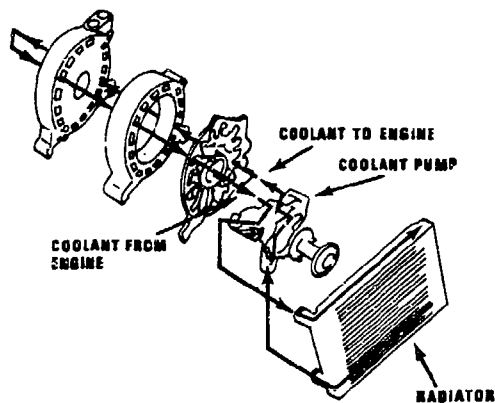

(B) LIQUID-COOLED

Figure 2-21. Air-cooled and Liquid-cooled Rotary Combustion Engines

AMCP 708-381

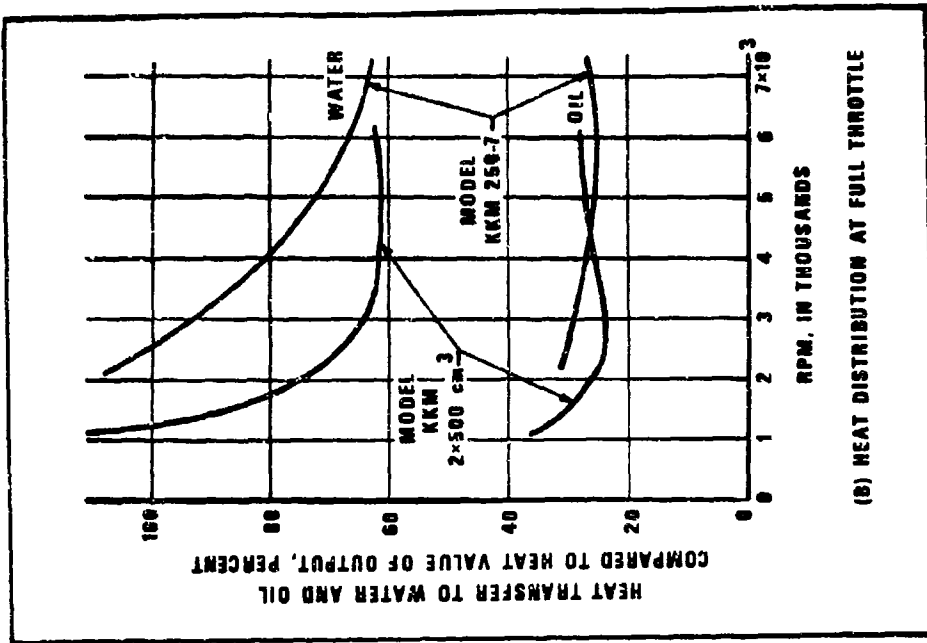

(B) HEAT DISTRIBUTION AT FULL THROTTLE

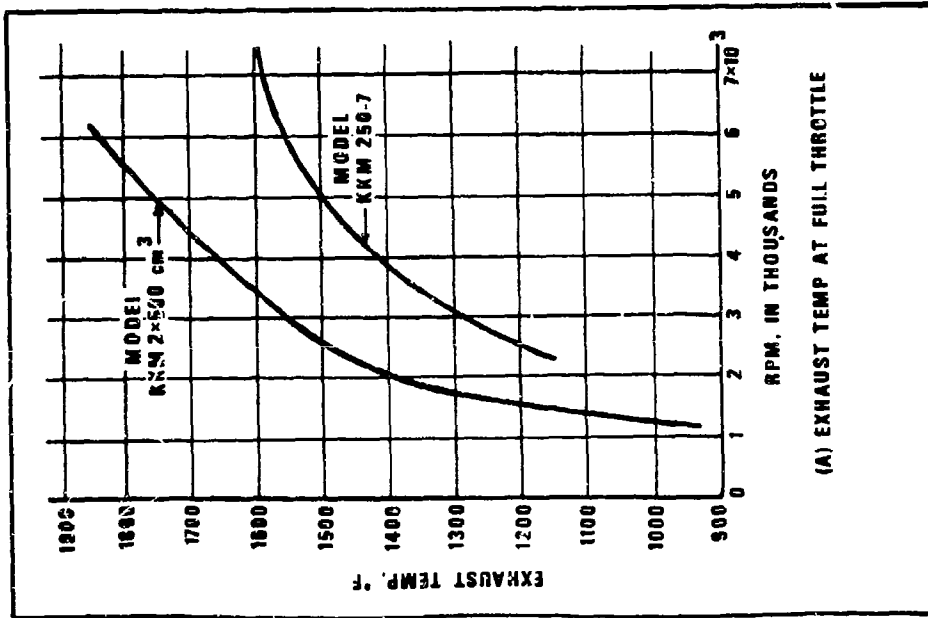

(A) EXHAUST TEMP AT FULL THROTTLE

Figure 2-22. Exhaust Temperature Heat Rejection Relationship for NSU Model KKM 250-7 and KKM 2 x 500 cm³ Engines (Courtesy of Audi NSU Auto Union AG)

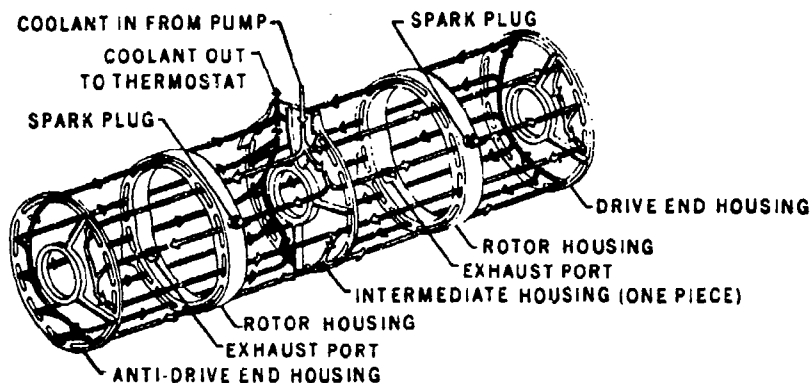

Figure 2-23. Schematic Diagram of Housing Cooling System for Curtiss-Wright Wankel Engine RC2-60-U5 (Ref. 36)
 (Release Granted by Society of Automotive Engineers, Inc., Paper No. 720468.)

necessary power at the wheels/sprockets to satisfy vehicle performance. The selection of the number of ratio steps and the amount of the ratio reduction per step is called "engine matching". This defines the purpose of a transmission, which is to make the available engine performance match the required vehicle performance as closely as practical. Fig. 2-27 shows transmission performance where 8 ratios prevent dangerous engine overspeed and where 5 ratios do not. The 5-ratio transmission requires engine operation below the peak torque speed at several points as well as requiring over maximum rated safe speeds.

2-2.1.1 Clutches

Friction clutches are couplings that permit a pair of shafts with unequal angular velocities to be smoothly engaged and disengaged when desired. They are required for vehicles using sliding gear mechanical transmissions. Since few US Army combat vehicles use this type of transmission, the application for single and multiple disc clutches are limited, in most cases, to noncombat vehicles.

The conventional clutch normally has no impact on the vehicle cooling system design

since the heat generated is dissipated into the flywheel and clutch assembly. The quantity of heat generated is negligible and can be disregarded. Oil-cooled friction clutches often are used in construction equipment and special vehicles. These installations require heat exchangers to cool the oil. A complete discussion of friction clutches is found in AMCP 706-355 (Ref. 3).

2-2.1.2 Power Losses and Efficiency

Power losses are experienced in:

1. Engine accessories
2. Transmissions (bearing preload and other mechanical problems can cause excessive heat)
3. Transfer cases
4. Final drives or axles
5. Sprockets
6. Tracks.

The amount of loss varies with:

AMCP 708-361

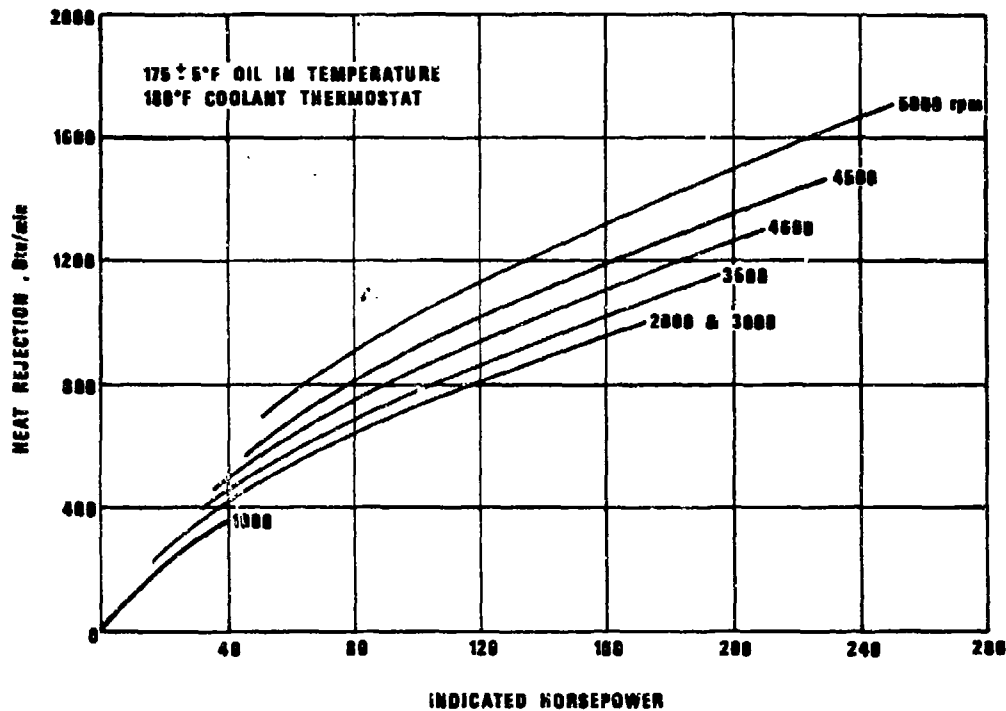

Figure 2-24. Curtiss-Wright Model RC2-60-U5 Engine Oil Heat Rejection
 (Courtesy of Curtiss-Wright Corporation)

1. Load
2. Gear ratio
3. Converter or lock-up
4. Amount of steer.

Table 2-5 can show typical efficiencies if a very gross estimate must be made. Emphasis on cooling system analysis must be to specify data on each significant component. Table 2-5 shows driveline efficiencies with grade and speed conditions combined. This table shows the effect of operating at various speed and slope conditions.

2-2.2 CROSS DRIVE TRANSMISSIONS

A cross drive transmission is a single item that combines the transmission and steer function for a tracked vehicle, and that may or may not contain steering brakes. A number of different power train combinations are possible as shown in Table 2-7. The cross drive transmission is used in track-laying vehicles and normally contains a hydraulic torque converter, gear train with forward and reverse speeds, and controlled planetary gear sets for steering. A simple clutch-brake or a more complicated regenerative steering system may be incorporated (Ref. 8). Fig. 2-28 shows a cross drive transmission schematic

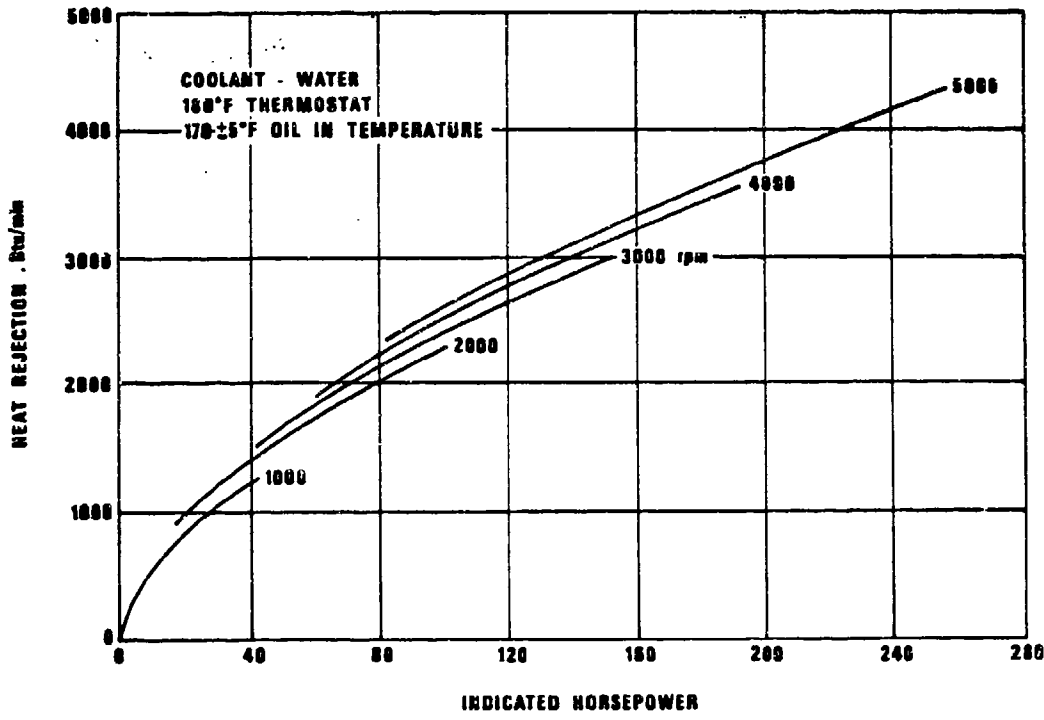

Figure 2-25. Curtiss-Wright Model RC2-60-U5 Engine Coolant Heat Rejection, Water Coolant (Courtesy of Curtiss-Wright Corporation)

using steering brakes with a steering differential to produce regenerative steering. Transmission efficiencies vary with the particular design, however, the torque converter and internal brakes require cooling. This cooling requirement becomes a part of the vehicle cooling system heat load. The cooling requirements are determined by transmission efficiency and range from 10 to 30 percent, or more, of the horsepower input to the transmission.

2-2.2.1 Internal Brakes

The cross drive transmission often incorporates a built-in braking system for the vehicle. The heat generated by the brake system is

absorbed by the transmission cooling oil. This heat is a part of the total transmission cooling load and is not considered separately for the cooling system design.

A cross drive transmission without an internal braking system usually is installed in the same compartment with the external brakes. The brakes normally are mounted between the transmission output shaft and the vehicle final drives. This type of installation requires air circulation through the transmission/brake compartment.

2-2.2.2 Steering Clutches

Steering clutches are incorporated in cross

AMCP 708-361

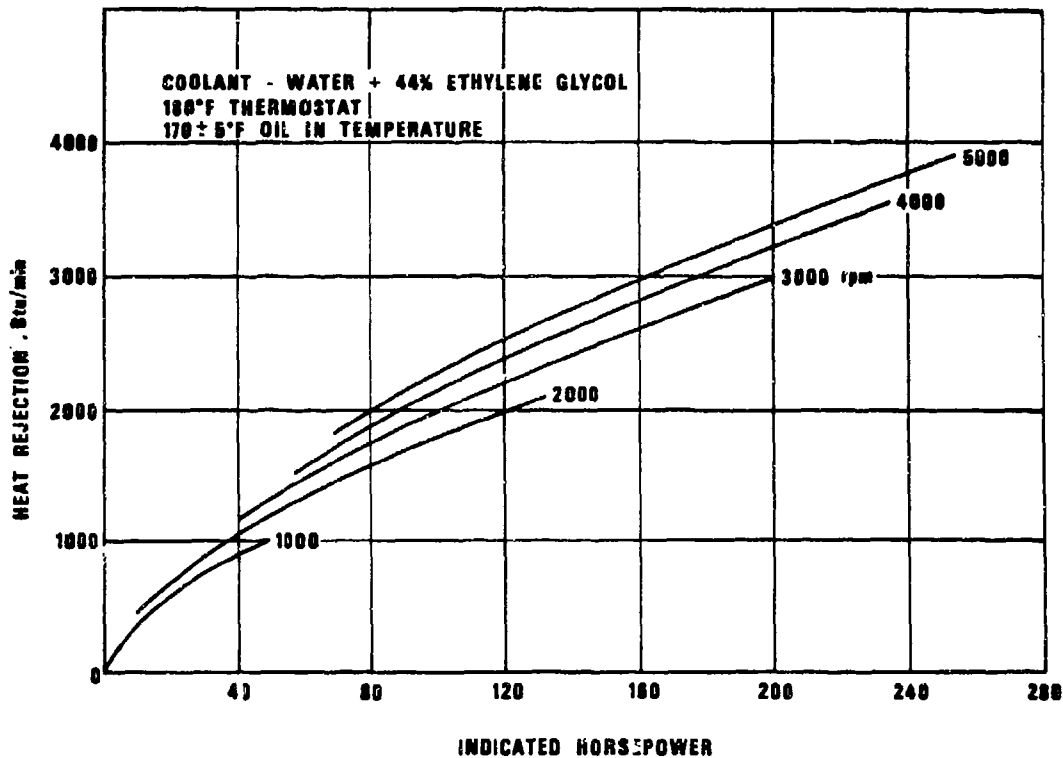

Figure 2-26. Curtiss-Wright Model RC2-60-U5 Engine Coolant Heat Rejection, Water-Ethylene Glycol Coolant (Courtesy of Curtiss-Wright Corporation)

drive transmission designs. These clutches can be either the dry (friction) type or wet type where oil is supplied to the friction surfaces for cooling purposes. Heat absorbed by the oil is dissipated by passing the oil through an oil-to-air cooler. This heat load is part of the total transmission heat rejection as defined in par. 2-2.2. The cooling discussion in par. 2-2.2.1 for internal brakes also applies to the internal wet-type steering clutches or steering brakes. Fig. 2-29 illustrates the application of wet-type steering clutches to the XT-500 transmission (Ref. 3).

Simple clutch-brake steering systems are used in few US military vehicles because of performance limitations. This system is

satisfactory only for length/tread ratios of less than 1.3:1 and cannot provide pivot steering (see Ref. 23, par. 2-3.4).

2-2.3 HYDRAULIC DRIVES

2-2.3.1 Hydrostatic

A hydrostatic transmission basically consists of a variable displacement hydraulic pump that is capable of reversing the direction of the output flow without a change in the direction of pump rotation, and one or more hydraulic motors. The hydrostatic transmission offers an infinitely variable, stepless, output speed independent of input speed between the extremes of the operating ratios.

TABLE 2-4

A GLOSSARY OF POWER TRAIN TERMS (USATACOM)



TERM & SYMBOL	DESCRIPTION	REMARKS
<p>1. Fluid Coupling:</p> 	<p>a centrifugal oil pump mounted face-to-face with a centrifugal motor where engine power is transmitted wholly by the fluid. There is no mechanical connection between input and output. Input torque always equals output torque.</p>	<p>Not used in present day power trains due to poor efficiency and no torque multiplication.</p>
<p>2. Torque Converter:</p> 	<p>a component similar to a fluid coupling. In it, torque multiplication is achieved by redirecting the oil flow within the converter. There is no mechanical connection between input and output. The term hydrodynamic is often used to describe this item, because power is transmitted by the change in velocity of the fluid.</p>	<p>-Popular when used in conjunction with a power shift transmission. Efficiency is usually 83% or less. -May have a direct drive "lock-up" clutch: gives 99+% efficiency at no torque multiplication.</p>
<p>3. Transmission:</p> 	<p>a component with one input and one output, having the ability to change ratios. Gears, hydraulic devices, etc., are used internally to accomplish the ratio change.</p>	
<p>3a. Manual Transmission:</p> 	<p>a stepped gear transmission which requires the operator to declutch and shift from one gear (ratio) to the next.</p>	<p>-Requires a manual disconnect clutch. -Not presently used in track laying vehicles.</p>
<p>3b. Power Shift Transmission:</p> 	<p>a stepped gear transmission with internal clutches, one for each ratio. Operator works a valve to select desired gear. Shift can be made under power.</p>	<p>Popular when used with a torque converter.</p>

TABLE 2-4 (Continued)

3b1. Automatic Transmission:

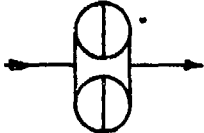
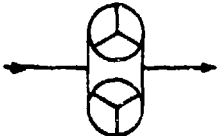
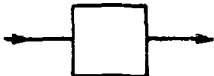

a power shift transmission, that shifts automatically.

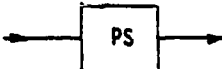
3c. Hydrostatic Transmission:



a type of transmission where power is transmitted wholly by fluid under pressure. A variable positive displacement pump (driven by the engine) circulates oil to a fixed (usually) positive displacement motor. There is no mechanical connection between input and output.

Provides infinitely variable ratio changing. Provides design versatility since pump can be remote from the motor. Poor efficiency.

3d. Hydromechanical Transmission:



a combination of a hydrostatic transmission and a mechanical transmission where a percentage of the power is carried hydraulically and the remainder mechanically. Provides infinitely variable ratios.

Provides more ratio coverage than hydrostatic. Has superior efficiency and volume.

4. Steering Unit:

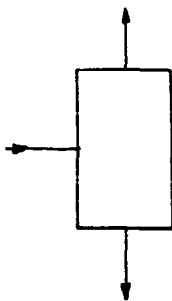

a component having one input and two outputs (one for each vehicle track) where a speed difference between the two outputs can be obtained to achieve vehicle steering.

Brakes for a track laying vehicle are normally included in a steer unit.

A wide variety of gear train schemes and components are used by manufacturers for various types of steer units. (Ref. AMCP 706-355). Clutches, brakes, hydrostatic units, hydromechanical units, and other means are used to control the speed difference between outputs for vehicle steering.

5. Power Train or Steering Transmission

By assembling a combination of the above listed components, a vehicle power train is obtained. This may be several individual components, or it may be one unit, with the various components internal.

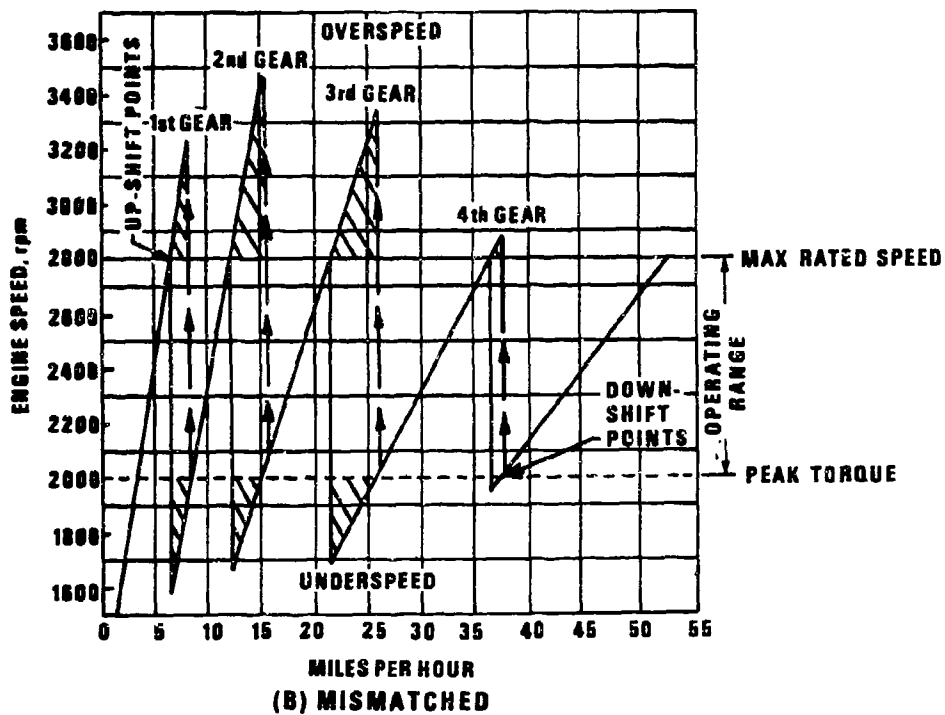
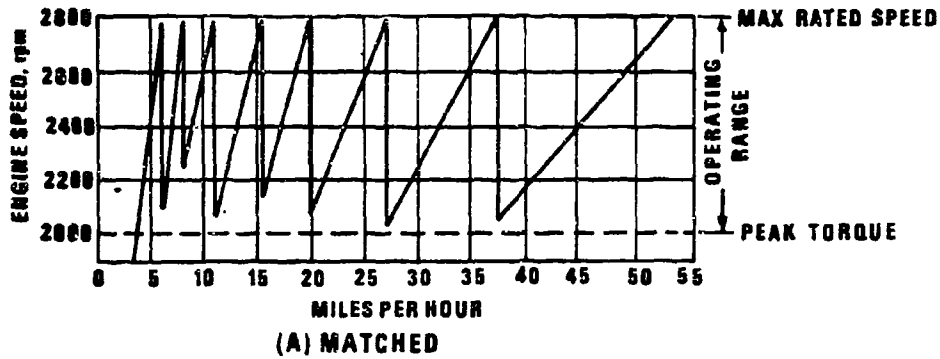

NOTE: 8 SPEEDS PREVENT OVERSPEED AND MAINTAIN PEAK TORQUE.
5 SPEEDS CAUSE OVERSPEED AND UNDERSPEED OR LUGGING
CONDITIONS.

Figure 2-27. Engine Transmission Matching

TABLE 2-5
VEHICLE PERFORMANCE EQUATIONS (Ref. 3)

Forces, Torques and Horsepower necessary to:	At The Wheel		At The Clutch			
	Force, lb	Torque, lb-ft	Horsepower, lb-ft/min	Force, lb	Torque, lb-ft	Horsepower, lb-ft/min
1. Overcome air resistance	$K_1 A V^2$	$K_1 A V^2 r$	$\frac{K_1 A V^2}{375}$	$\frac{K_1 A V^2 r}{A_r A_c \eta}$	$\frac{K_1 A V^2 r}{A_r A_c \eta}$	$\frac{K_1 A V^2}{375 \eta}$
2. Overcome rolling resistance	$K_2 W$	$K_2 W r$	$\frac{K_2 W V}{375}$	$\frac{K_2 W r}{A_r A_c \tau_c \eta}$	$\frac{K_2 W r}{A_r A_c \eta}$	$\frac{K_2 W V}{375 \eta}$
3. Ascend grade	$W \sin \theta$	$W r \sin \theta$	$\frac{W r \sin \theta}{375}$	$\frac{W r \sin \theta}{A_r A_c \tau_c \eta}$	$\frac{W r \sin \theta}{A_r A_c \eta}$	$\frac{W r \sin \theta}{375 \eta}$
4. Accelerate vehicle	$\left(\frac{W+W_c}{g} \right) a$	$\left(\frac{W+W_c}{g} \right) ar$	$\frac{(W+W_c) a V}{375 g}$	$\frac{(W+W_c) ar}{A_r A_c \tau_c \eta g}$	$\frac{(W+W_c) ar}{A_r A_c \eta g}$	$\frac{(W+W_c) a V}{375 \eta g}$

FIG. 11

1 Frontal area, ft²
 2 Transmission ratio in a given gear (drawn/drawing)
 3 Rear axle ratio (drawn/drawing)
 4 Approximate draughtline efficiency

Wheeled Vehicles

(General)
 = 0.90 for direct drive
 = 0.85 for overall ratio of 1:2
 = 0.80 for overall ratio of 2:1
 (Manual Transmission)
 = 0.95 for high speed, full load
 = 0.90 for high speed, road load
 = 0.87 for mid speed, full load
 = 0.80 for mid speed, road load
 = 0.85 for low speed, full load
 = 0.85 for low speed, road load
 (Automatic Transmission)
 = 0.90 for high speed, full load

Tracked Vehicle

(General)
 = 0.76 for high range, full load
 = 0.72 for low range, full load
 (Automatic Transmission)
 = 0.85 for high speed, full load
 = 0.85 for high speed, road load
 = 0.80 for mid speed, full load
 = 0.85 for mid speed, road load
 = 0.50 for cooling point, full load
 = 0.80 for low speed, road load
 = 32.2 ft/sec²

K₁ Air resistance coefficient
 = 0.00156 for extremely streamlined shape
 = 0.00054 to 0.0009 for standard sedans automobiles
 = 0.00102 to 0.00114 for open convertible automobiles
 = with flat windshields
 = 0.00055 to 0.00103 for trailers, van type (various shapes)
 = 0.00054 to 0.00112 for buses
 = 0.00095 to 0.00252 for trucks
 = 0.00156 to 0.00252 for tractor-trailer combinations

K₂ Rolling resistance coefficient
 r Effective radius of wheel, ft
 r₂ Effective radius of clutch, ft
 W Gross vehicle weight, lb
 W_c Equivalent weight of rotating parts of driveline.
 V Speed relative to air, mph
 θ Angle of grade, deg.
 g acceleration, ft/sec²

† K₁ values based on publications of M. G. Balber, W. Kama, and S. F. Horner.

TABLE 2-6

SUMMARY OF VEHICLE DRIVELINE SYSTEM EFFICIENCIES DURING FULL-THROTTLE OPERATION (Ref. 3)

Vehicle	Slope, %	Road Speed, mph	Engine Speed, rpm	Driveline Efficiency, %
M41A1 No. 806	0	6.6	76.0
	20	5.9	2320	64.0
	30	4.9	2240	65.0
	40	3.3	2180	57.0
	50	2.6	2150	53.5
	60	1.7	2170	38.5
M48A1 No. 117	0	5.0	76.0
	20	5.8	2275	72.1
	30	4.7	2220	76.0
	40	3.2	2180	66.7
	50	2.3	2150	57.1
	60	1.7	2165	48.3

NOTE: THIS TABLE IS FOR REFERENCE ONLY. THE EFFICIENCY OF ANY POWER TRANSMITTING SYSTEM WILL VARY WITH THE MECHANICAL SYSTEM DESIGN.

There are few current military automotive or tactical vehicle applications of a pure hydrostatic transmission, however, construction equipment and mobile equipment applications are numerous. Between the pure hydrostatic and pure mechanical transmission are hybrid assemblies. They retain the desirable characteristics of both mechanical and hydrostatic transmissions. These hydro-mechanical units are being evaluated for both wheeled and tracked military vehicles. A schematic diagram comparison of typical hydrostatic and hydromechanical transmissions using the same size hydraulic units is shown in Figs. 2-30(A) and (B). Figs. 2-30(A) and (B) also show how a hydromechanical set-up using the same size hydraulic units can provide better efficiency and greater torque

but at the expense of some speed range. Note that the speed range is -4000 to +4000 rpm in hydrostatic and is -1600 to +4000 rpm in hydromechanical.

Fig. 2-30(C) illustrates a typical hydrostatic transmission efficiency curve for a tracked vehicle compared with a single range hydro-mechanical. The efficiency values at low speeds are very low and, as a result, the transmission heat rejection rate at full engine load and vehicle speeds below 10 mph can be from 35 to 90 percent of the net engine output. This heat load must be dissipated by the vehicle cooling system. Fig. 2-31 shows a comparison of the efficiency of hydrostatic and hydromechanical transmissions as a function of vehicle speed.

AMCP 706-381

For discussions of vehicle performance predictions refer to SAE J688 *Truck Ability Prediction Procedure* (Ref. 9), *Commercial Vehicle Performance and Fuel Economy* (Ref. 10), AMCP 706-355 (Ref. 3), and AMCP 706-356 (Ref. 23). Computer simulations are available that expand the basic prediction

techniques to include dynamic performance simulation.

2-2.3.2 Hydrokinetic

The hydrokinetic torque converter type transmissions have been used successfully for

TABLE 2-7
POWER TRAIN COMBINATIONS (USATACOM)

COMBINATION	DESCRIPTION	REMARKS
<p>1. Torque converter, power shift trans., & mech. steer unit</p> 	<p>This configuration is typical of many units presently in production. The variety of combinations of steering gear trains is too numerous to discuss each in detail.</p>	<ul style="list-style-type: none"> -Fixed ratio steer at any vehicle speed. -Slip a clutch to steer. -Will not steer at converter stall.
<p>1a.</p> 	<p>One common variant of this scheme has the drive for the steer input taken off between the torque converter and the transmission input.</p>	<ul style="list-style-type: none"> -Steer ratio changes with each gear range. -Will not steer at converter stall.
<p>2. Torque converter, power shift trans., & hydrostatic steer.</p> 	<p>This configuration has a hydrostatic pump driven from the transmission input. No power is carried through the steer circuit when vehicle is driven straight.</p>	<ul style="list-style-type: none"> -Provides infinite steer ratios. -Steer changes with gear ratio. -May not give adequate steer near converter stall. -Probably has limited track speed differential for water steer. -Heavy steer loads stall the vehicle.

TABLE 2-7 (Continued)

2a. Torque converter, power shift trans., & engine driven hydrostatic steer

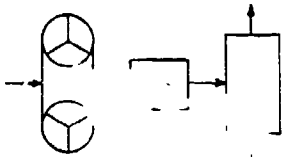
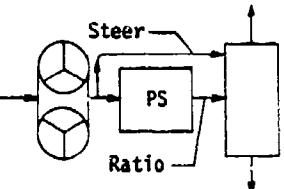
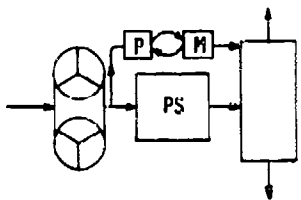
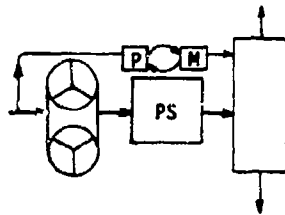

This is same as Item 2, except steer circuit is driven by the engine to improve steer when torque converter is near stall.

- Steer ratio changes with vehicle speed.
- Poor steer with engine at idle, i.e., coasting at high speed at closed throttle.

3. Hydromechanical Power Train

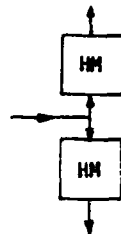

This is a system with two hydromechanical transmissions back to back. Get ratio by varying both together; get steer by biasing one versus the other.

- Infinitely variable ratio and steer.
- Double utilization of components (use same unit for ratio and steer).
- Limited ratio coverage.
- Very compact.

3a. Hydromechanical power train with added mechanical ratio.

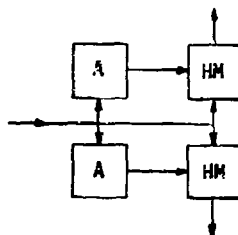

This is same as Item 3, except an additional mechanical power path is provided.

- Good ratio coverage.
- Very difficult to synchronize shifting of the mechanical transmissions; steering is erratic unless shifts are exact.
- Good efficiency.
- Steer ratio varies with vehicle speed.

AMCP 706-361

TABLE 2-7 (Continued)

3b. Hydromechanical power train with added hydro-mechanical ratio

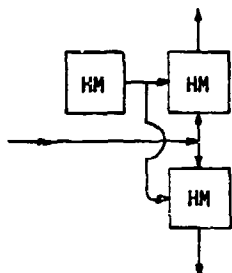

This is same as 3, except an additional hydro-mechanical power path is provided.

The "upper" trans. is used for added ratio. The "lowers" are used for both ratio and steer.

- Infinitely variable ratio and steer.
- Good efficiency.
- No step changes in added ratio path.
- Steer ratio varies with vehicle speed.
- Good ratio coverage.
- Requires three hydraulic units.
- Good interchangeability of components.

tracked and wheeled military vehicles. These transmissions consist basically of a torque converter with a lock-up clutch and multi-speed planetary gear sets (see Fig. 2-32). Fig. 2-33 illustrates an example of the predicted vehicle performance of a four speed torque converter type Allison Model TX-200 transmission with a 2.5:1 torque ratio installed in a 17,000 lb GVW vehicle.

The heat rejection characteristics for this transmission can be determined from Fig. 2-34. Cooling specifications for military vehicles often require that the vehicle cooling system be adequate to permit the vehicle to perform continuously at the point where the wheels or tracks would slip. This point occurs when the vehicle track or wheel to the ground coefficient of friction is maximum and is often assumed that the tractive effort TE equals approximately 75 percent of the weight on the drive axles. This value will vary with the different types of soil or ground surface conditions and can exceed this value.

$$TE = fW_d, \text{ lb (tractive effort)} \quad (2-1)$$

where

f = coefficient of friction, dimensionless

W_d = weight on driving axles, lb

The maximum tractive effort for a 17,000-lb vehicle as shown in Fig. 2-33 is assumed to occur at

$$TE = 0.75 \times 17,000 = 12,250 \text{ lb}$$

This corresponds to a vehicle speed of 4.8 mph for first gear converter operation. At this point the heat rejection is

$$Q_r = (\text{Input HP}) - (\text{Sprocket HP}), \quad (2-2)$$

Btu/min

therefore

$$Q_r = 238 - 160 = 78 \text{ hp (from Fig. 2-34)}$$

or

$$42.4 \times 78 = 3307 \text{ Btu/min}$$

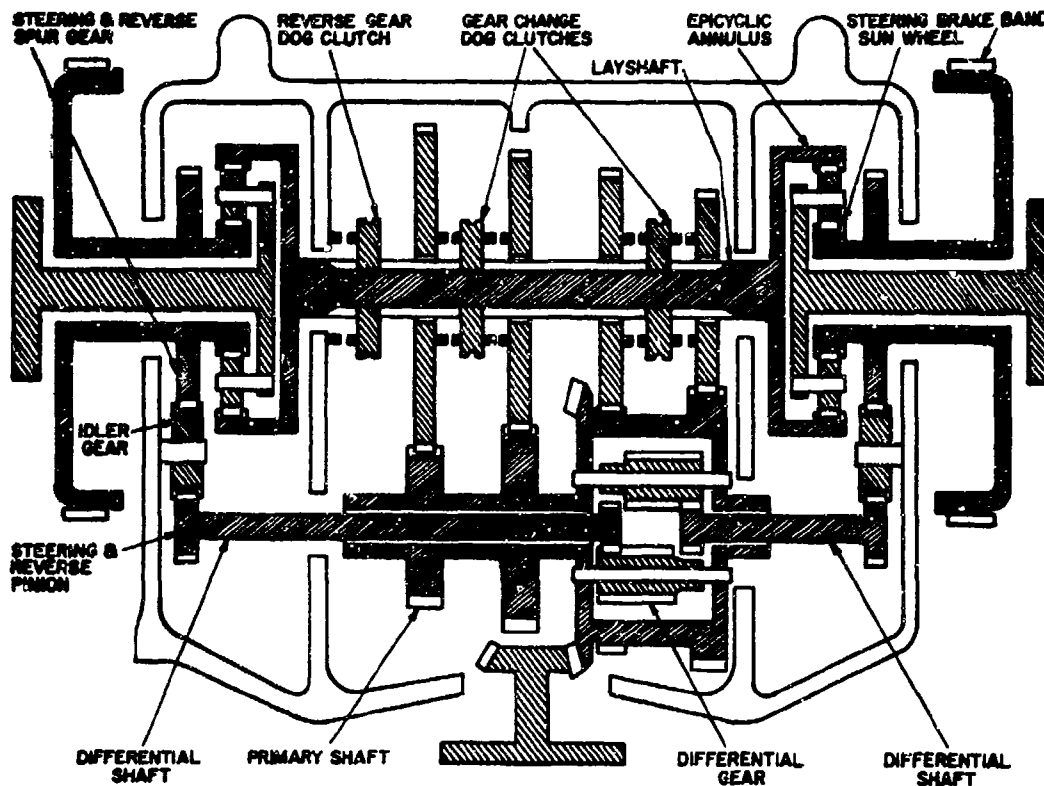

Figure 2-28. Merritt-Brown Cross Drive Transmission (Ref. 3)

The predicted vehicle performance curve represents a specific vehicle installation and is not necessarily the same characteristic that would be obtained with this transmission and different system components such as another engine, a different torque converter, a different vehicle gear ratio, or other variations.

In practice, a hydrokinetic torque converter type transmission is matched to a particular engine to permit the engine to operate at the best conditions and produce the best engine/transmission package to meet the vehicle performance specifications.

Vehicle powertrain efficiency characteristics for a vehicle powertrain consisting of a

hydrokinetic transmission and a 200 bhp diesel engine are shown in Fig. 2-35.

2-2.3.3 Hydromechanical

The hydromechanical type transmission consists of combined mechanical and hydraulic power paths to retain the infinitely variable characteristics of the hydrostatic transmission while attaining the higher efficiencies of a mechanical drive transmission. Fig. 2-36 is a schematic diagram of a Model HMT-250 transmission installation (Ref. 11).

The comparative performance of the hydrostatic and the hydromechanical transmissions is shown in Fig. 2-30(C). The heat rejection requirements for a hydromechanical

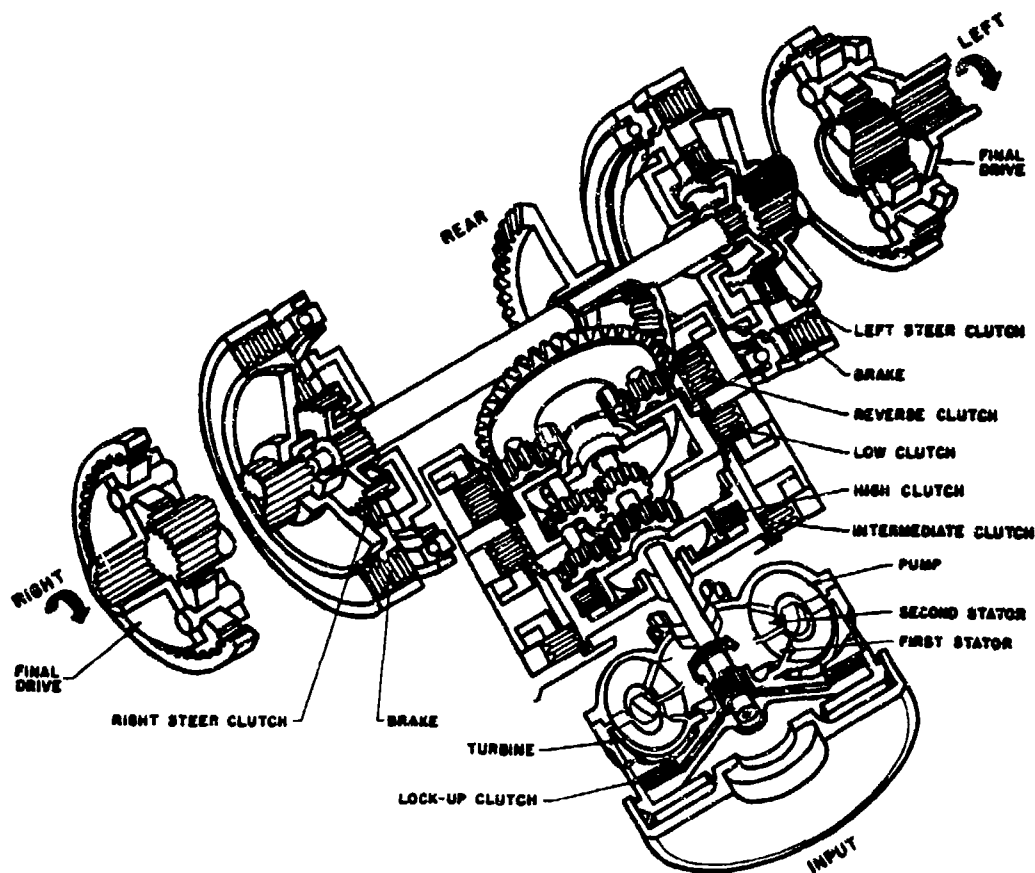

Figure 2-29. Transmission XT-500 (Ref. 3)

transmission can be obtained from the vehicle performance curves as discussed in par. 2-2.3.2. A typical vehicle powertrain performance curve for the HMT-250 transmission is shown in Fig. 2-37 and a HMPT-500 performance curve is shown in Fig. 2-38. This transmission is proposed for use in the Mechanized Infantry Carrier Vehicle (MICV) Engineering Development Vehicle.

2-2.4 ELECTRIC DRIVES

Electric drive systems for military vehicles have been evaluated for improved performance and design flexibility. The electric

drive system applied to the Armored Personnel Carrier, M113, can be considered as representative of the state of the art in this area (Ref. 12). Fig. 2-39 illustrates the basic components for the electric drive system.

2-2.4.1 Cooling Requirements

Oil-cooling was selected for the inverters and motors because significant size reduction was possible in the motors by using oil-cooled rotors and in the inverters by using oil-cooled plates functioning as heat sinks for the power semiconductors. Environmental protection from dust, humidity, and salt spray—which

OUTPUT:
FORWARD
 593 lb-ft MAX TORQUE
 4000 rpm MAX SPEED
REVERSE
 593 lb-ft MAX TORQUE
 1800 rpm MAX SPEED

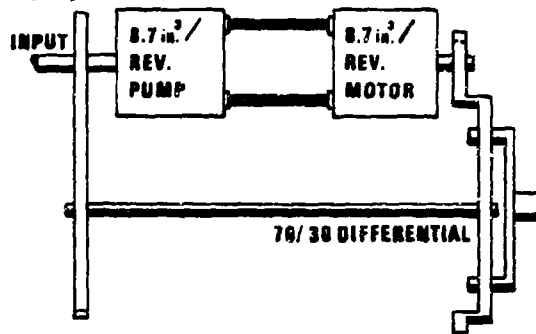

(A) HYDROMECHANICAL TRANSMISSION

OUTPUT:
 415 lb-ft MAX TORQUE
 4000 rpm MAX SPEED
 FORWARD & REVERSE



(B) HYDROSTATIC TRANSMISSION

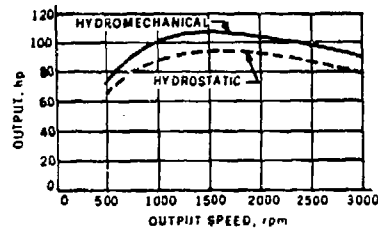

(C) COMPARATIVE PERFORMANCE OF SINGLE RANGE HYDROSTATIC AND HYDROMECHANICAL TRANSMISSION

(Release Granted by Society of Automotive Engineers, Inc., Paper No. 670972)(Ref. 11)

Figure 2-30. Hydromechanical and Hydrostatic Transmissions

AMCP 706-361

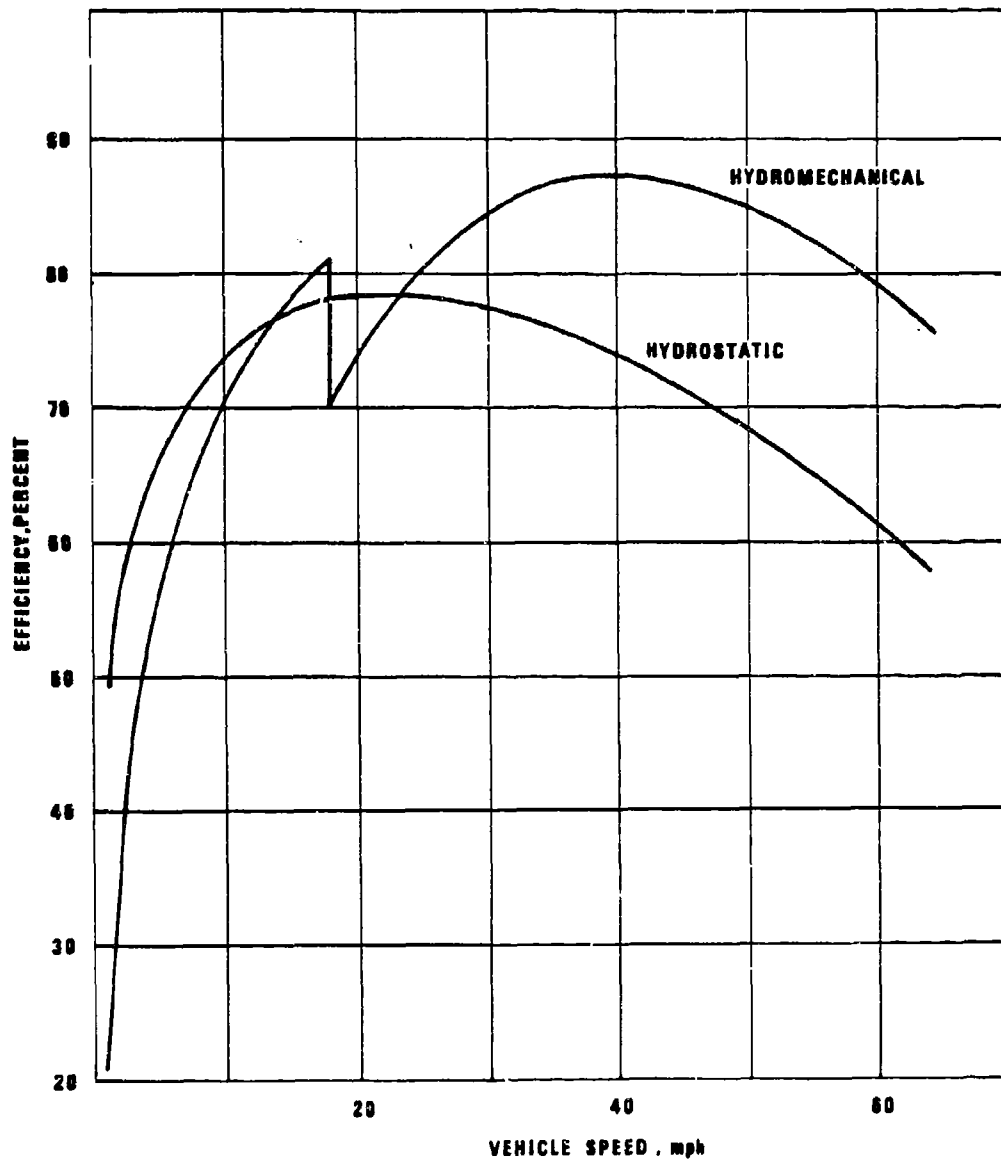
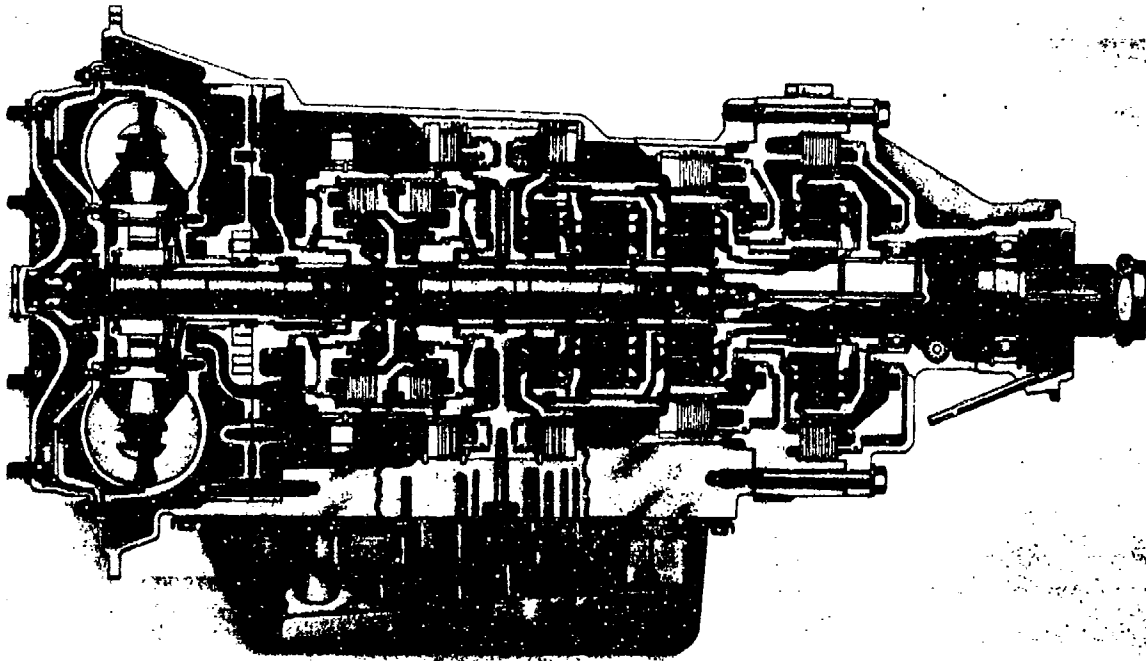

Figure 2-31. Typical Efficiencies of Tracked Vehicle Power Trains Designed for Equal Torque and Speed for Two Range Hydromechanical and Single Range Hydrostatic Type Transmissions (USATACOM)



*Figure 2-32. Hydrokinetic Torque Converter Transmission
 (Courtesy of Detroit Diesel Allison Division, General Motors Corporation)*

are common to a military tracked vehicle—also was accomplished more easily with oil-cooling. An attempt to duct cooling air, within the confines of the vehicle, to the components requiring it would have been a very difficult if not impossible task because of space limitations. An outline of this oil-cooling system is shown in Fig. 2-40. The semiconductors in the inverter require heat extraction at a lower temperature than that of the engine (150°F as compared to an engine coolant temperature of 220°F). This requires an additional heat exchanger installed on the suction side of the normal vehicle engine-cooling fan, assuring minimum air temperature for cooling the oil. The cooler has a large cross section to minimize inlet losses between the heat exchanger and the fan.

Oil is pumped from a reservoir, by an engine-driven pump, to a thermostatic valve.

Then it is directed through the cooler or a by-pass, depending on the oil temperature.

A flow divider downstream from the heat exchanger directs flow to the inverters and a DC power supply. Flow from these units is directed under pressure back to the reservoir. Scavenging is not required. The other main branch of the flow divider carries cooling and lubricating oil to the main propulsion motors. A fraction of the oil lubricates the main alternator bearings. Two engine-driven scavenging pumps are employed; one to evacuate the oil from the propulsion motor, and the other to remove the oil from the main alternator.

Pressure relief valves are used to protect the main system and to by-pass the cooler if the oil viscosity is high.

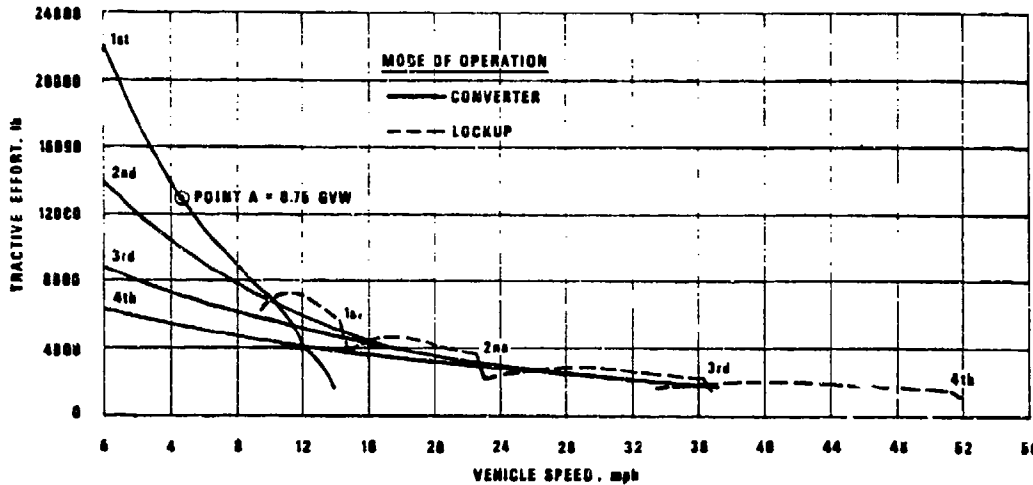

Figure 2-33. Computed Vehicle Tractive Effort vs Speed Curve for a 17,000 lb Gross Vehicle Weight With a Hydrokinetic TX-200 Transmission

2-2.4.2 Power Losses and Efficiency

Calculated component efficiencies and the resultant total system efficiency are shown in Fig. 2-41. It can be seen from Fig. 2-41 that the peak performance of the electric and mechanical vehicles are similar, with each surpassing the other at selected points throughout the speed range. At certain points the mechanical power train has better efficiency. The total power of the engine is not available throughout the speed range, as in the case with the electric drive system. The particular gear ratios affect the engine speed, and when the transmission is in torque converter range at very low speeds, the engine speed is lowered to its maximum torque point. With the electric drive, the engine may operate continuously at its maximum horsepower point.

2-2.5 TRANSFER CASES AND FINAL DRIVES

The transfer case and final drives are gear trains that transfer the engine power to the

driving axles. The transfer case normally is used in wheeled vehicles and final drives in tracked vehicles. Controlled differentials and combination controlled differential transfer gear boxes also are in general use.

The transfer unit usually is provided with a two-speed shift for extending the performance capabilities of the vehicle and also may contain one or more overriding sprag clutches for the front wheel drive. The overrunning feature of the sprag clutch permits power to be supplied to the front wheels, in one direction only, when the rear wheels slip. A second sprag clutch unit is provided to transmit power to the front wheels during reverse operation.

An average efficiency value for a conventional transfer case or final drive assembly is 98 percent. In the case of a wheeled vehicle, the heat generated in the transfer case is not considered a part of the required cooling system capacity because no special provisions are made to cool the assembly, but usually should be. In the case of the final drive units,

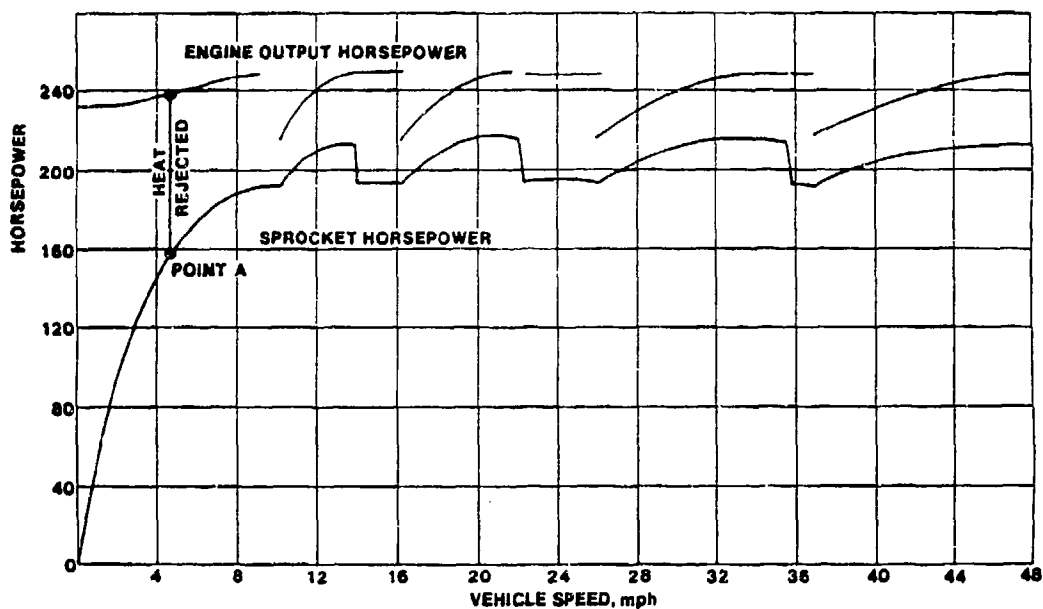

Figure 2-34. Predicted Performance With Hydrokinetic Torque Converter Transmission (USATACOM)

the heat generated is within the confines of the engine-transmission compartment and must be considered as a part of the cooling system load. This would have an average magnitude of 2 percent of the BHP input. Wheeled vehicle transfer cases usually are located in a very severe environment (downstream from the engine heat and subjected to conducted heat transmission). As a result, they are often found to exceed the desired oil temperature limits. Damaged and leaking seals, coking of lubricants, and subsequent bearing failures are not uncommon.

2-2.6 HYDRAULIC RETARDERS

Hydraulic retarders often are provided in the transmission or attached to the transfer case. The cooling requirements for these devices vary with gross vehicle weight, percent grade, grade speed, and other vehicle design characteristics. The retarder heat load is added to the cooling system during braking

while the engine heat load is minimum. For this reason, it may be possible to obtain satisfactory retarder heat rejection without additional cooling system capacity, however, desert testing at Yuma Proving Ground has indicated that the retarder oil temperatures may exceed the maximum recommended temperatures for the oils used (Ref. 14). It is not unusual for retarder heat loads to equal or exceed the engine BHP rating.

2-3 MISCELLANEOUS HEAT SOURCES

2-3.1 HYDRAULIC SYSTEMS

Many military vehicles use hydraulic systems for operation of the vehicle subsystems. These subsystems include power steering for automotive applications, turret and suspension hydraulics for combat vehicles, and complete vehicle control and work functions for construction equipment such as graders, dozers, and loaders. With the

AMCP 708-381

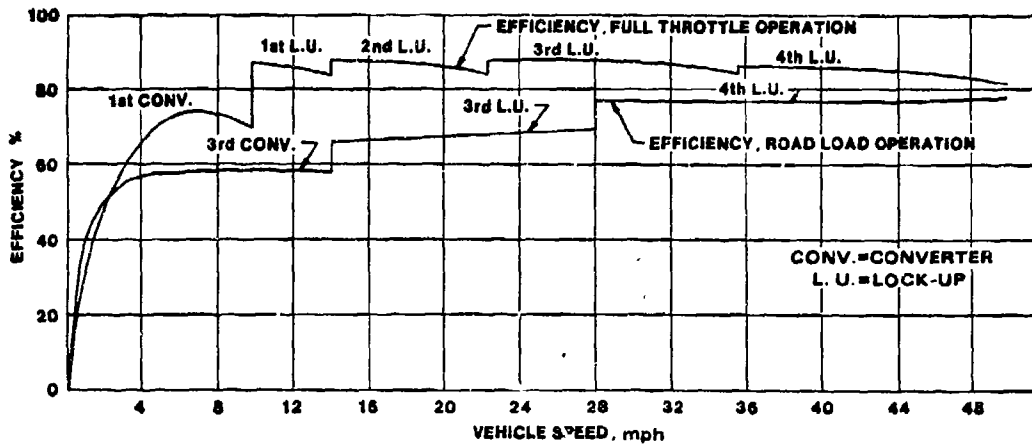

Figure 2-35. Predicted Vehicle Efficiency Characteristics, Hydrokinetic Transmission and 200 bhp Diesel Engine (USATACOM)

exception of high energy systems such as the hydraulic suspension used on the XM803 experimental vehicle and the MBT70 prototype tank, and some power steering hydraulic systems, special provisions for cooling normally are not required.

2-3.1.1 Motors

Hydraulic motors are heat sources with the amount of heat generated being dependent on the motor design, size, and efficiency. The heat rejected normally is not a major consideration in the vehicle cooling system design because of the large area for heat dissipation in the complete hydraulic system; however, if the cooling system fan is driven by a hydraulic motor, the heat rejection may be significant for consideration in the overall cooling system design.

2-3.1.2 Pumps

A hydraulic pump supplies fluid under pressure into a system. The heat generated by the pump is transferred into the fluid and

normally is dissipated throughout the system reservoir, lines, valves, and components. The heat generated is dependent on pump design, size, and efficiency. The heat generated by hydraulic pumps usually is not considered in the vehicle cooling system design.

Recommended temperature limits for MIL-H-6083 and MIL-H-5606 Hydraulic Oils (Refs. 24 and 25), based on thermal oxidation stability and susceptibility to water contamination are:

Type of System	Limits for Sustained Operation	Limits for Short periods (not exceeding 15 min)
Open System (Open reservoir)	160°F	-
Closed System (Enclosed reservoir)	275°F	-
Sealed System (Pressurized reservoir)	-	500°F

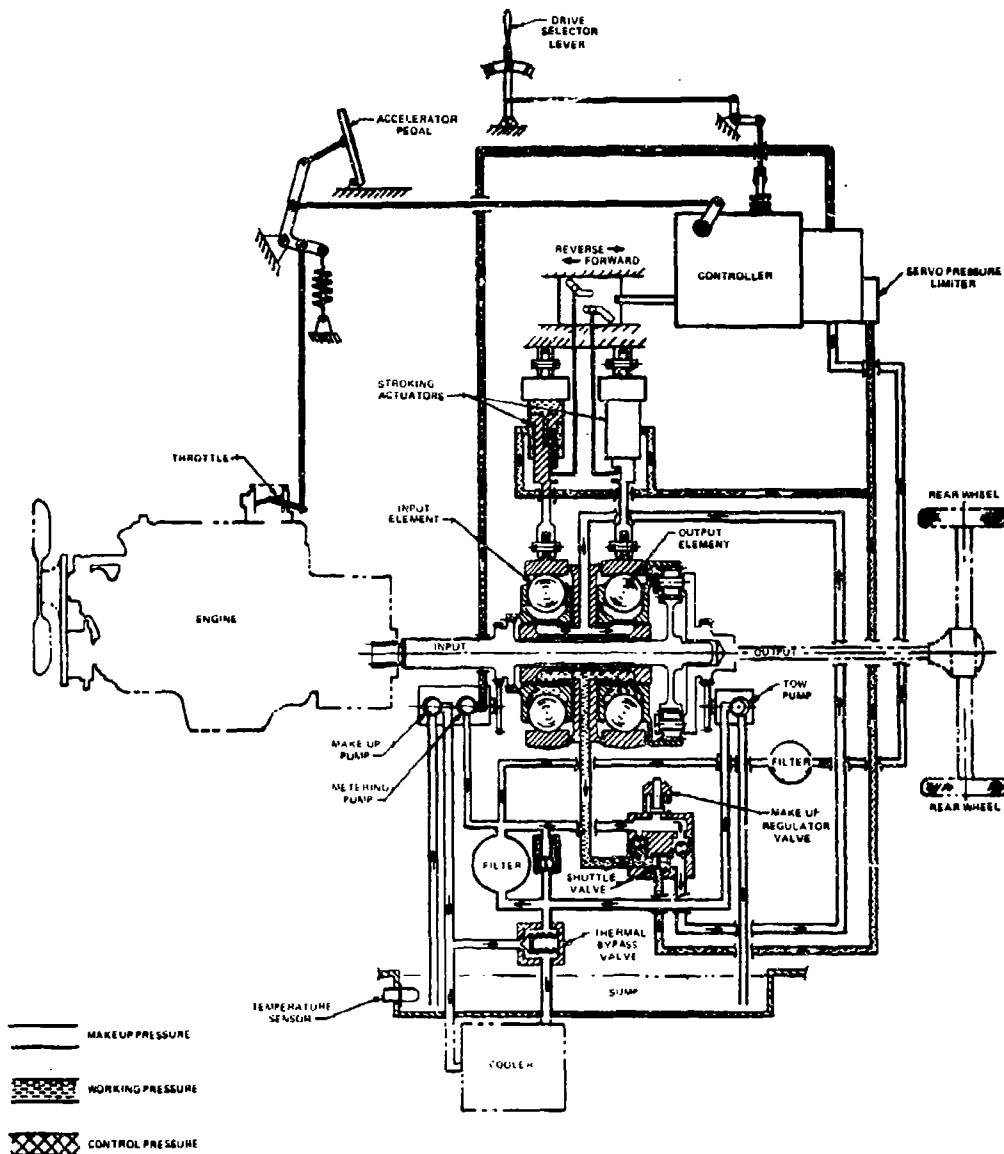

Figure 2-36. HMT-250 Transmission Schematic Diagram (Ref. 11)
(Release Granted by Society of Automotive Engineers, Inc., Paper No. 670932.)

AMCP 706-361

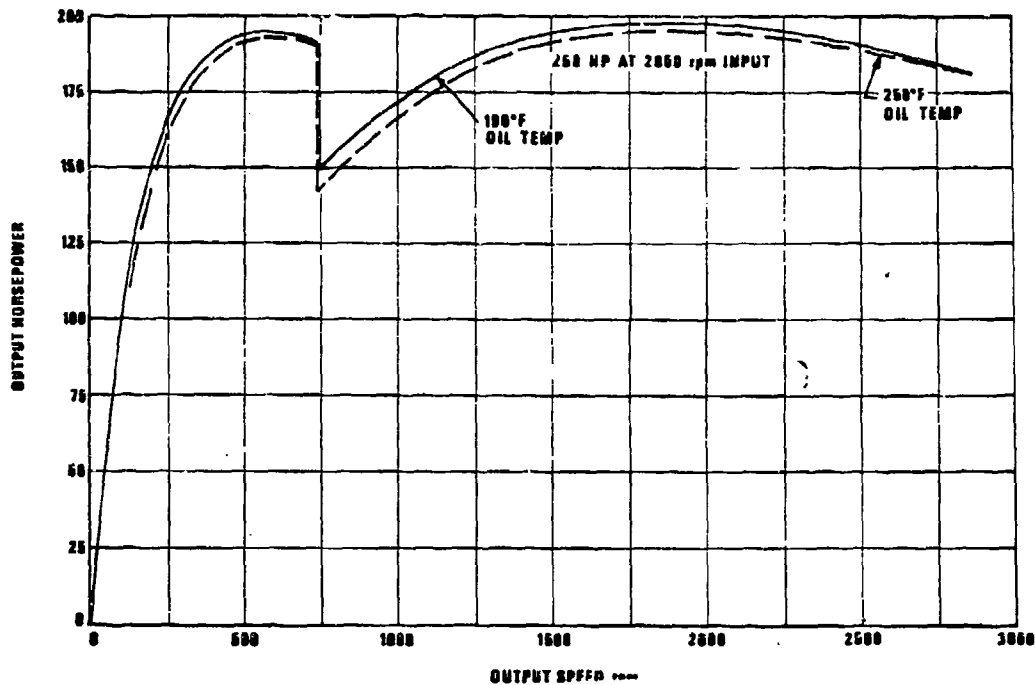

Figure 2-37. Predicted Vehicle Power Train Characteristics, HMT-250 Transmission (USATACOM)

The hydraulic systems may be installed in vehicle engine compartments, which can reach temperatures of 200°F at ambient temperatures of 125°F. This type of installation would have little or no cooling margin for other than a sealed system.

2-3.2 ELECTRIC MOTORS AND GENERATORS

Electric motors and generators are heat sources in any vehicle installation, and the heat rejection is a function of their efficiency. The η_m of an electric motor is:

$$\eta_m = (\text{input} - \text{losses}) / \text{input}, \text{ percent} \quad (2-3)$$

and the efficiency η_g of a generator is

$$\eta_g = (\text{output}) / (\text{output} + \text{losses}), \text{ percent} \quad (2-4)$$

Electrical apparatus ratings are based on the maximum temperature at which the material (usually the insulation) in the apparatus may be operated continuously. Air cooling usually is provided by built-in fans or, in the case of high output units, oil cooling is required.

Vehicle cooling system requirements should consider the heat load of electric motors and generators particularly if they are installed in a confined compartment.

2-3.3 FUEL INJECTION PUMPS

Engine fuel injection pumps and injectors require a surplus of fuel to provide for cooling. Normally the fuel supplied to the injection pump is about 300 percent of the quantity of fuel burned in the engine.

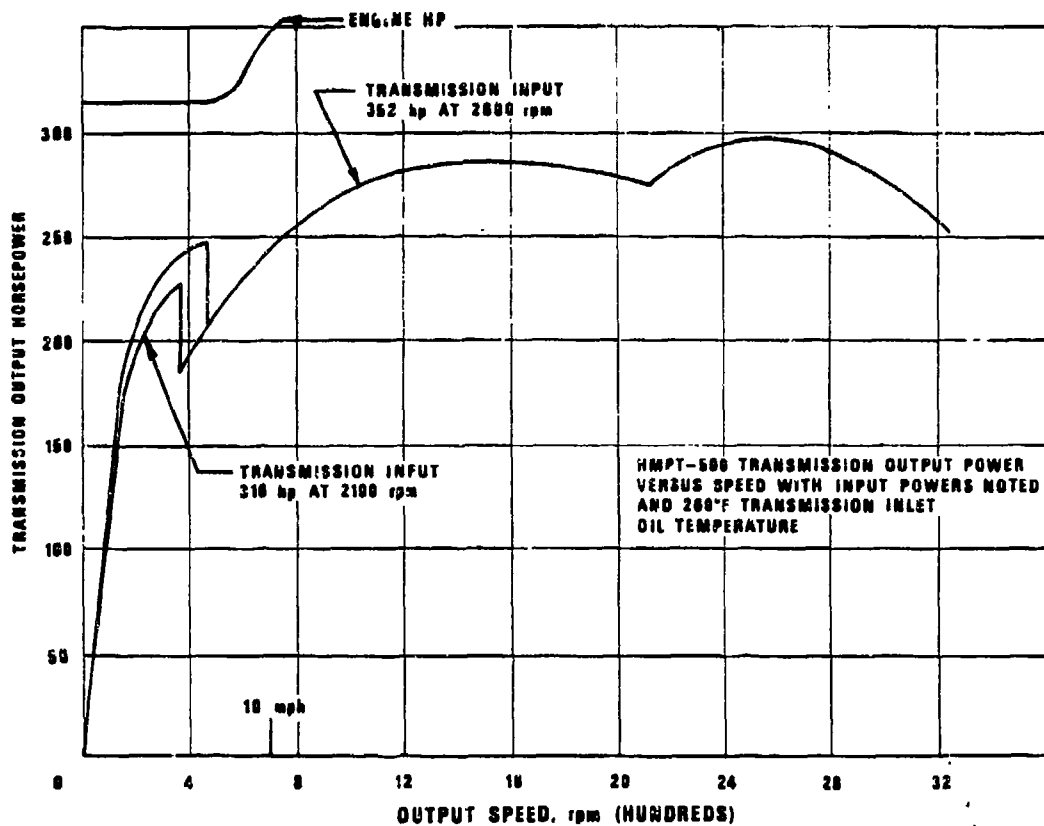

Figure 2-38. Calculated Vehicle Performance With the HMPT-500 Hydrostatic Transmission (USATACOM)

Roughly one-third of the fuel is injected and the remaining two-thirds cools and lubricates the injection pump and injectors and is returned to the vehicle fuel tank (see Fig. 2-42). The return of heated fuel to the tank often results in a gradual temperature increase of the fuel in the tank causing vapor handling problems and/or fuel oxidation. Fuel coolers may be required to eliminate this condition.

2-3.4 AIR COMPRESSORS

Air compressors for brake systems often are supplied for tactical and construction vehicles, and normally are liquid-cooled from

the engine coolant. The compressor is equipped with an air governor that unloads the compressor cylinder when a preset air pressure is reached. The compressor normally is loaded only when the vehicle brakes are in use or when initially charging the system at which time the engine heat load is minimum. The small air compressor heat load can be ignored in cooling system design considerations.

2.3-5 ENVIRONMENTAL CONTROL UNITS (Ref. 29)

Air conditioning components with capaci-

AMCP 706-361

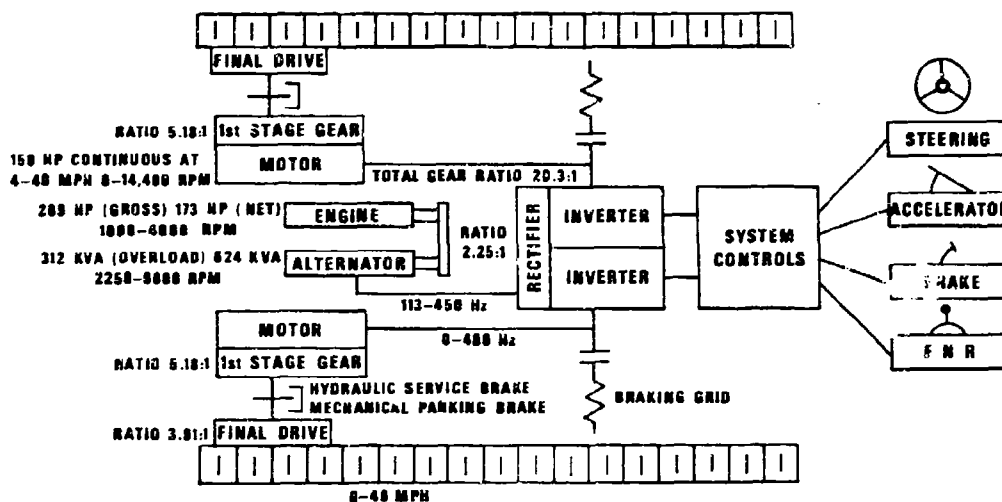

(Figure 2-39. Electric Drive System for M113 Vehicle (Ref. 12)
 (Release Granted by Society of Automotive Engineers, Inc., Paper No. 690442.)

ties from 20,000 to 40,000 Btu/hr are available for military vehicles, and the cooling requirements for these units must be considered as part of the integrated vehicle cooling system design.

The air conditioning system heat exchanger

can be mounted ahead of the cooling system radiator on automotive and tactical vehicles, and cab roof mountings are used for other type vehicles.

The MBT70 Prototype Tank was provided with an air-conditioning kit providing 32,000

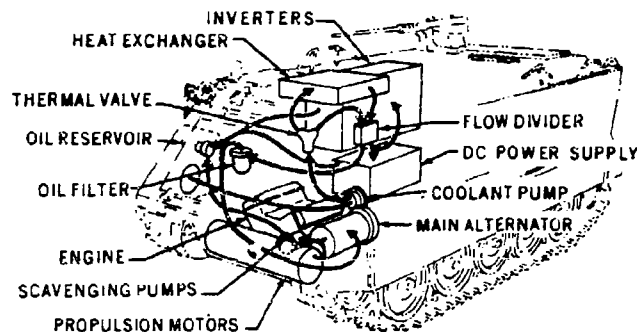
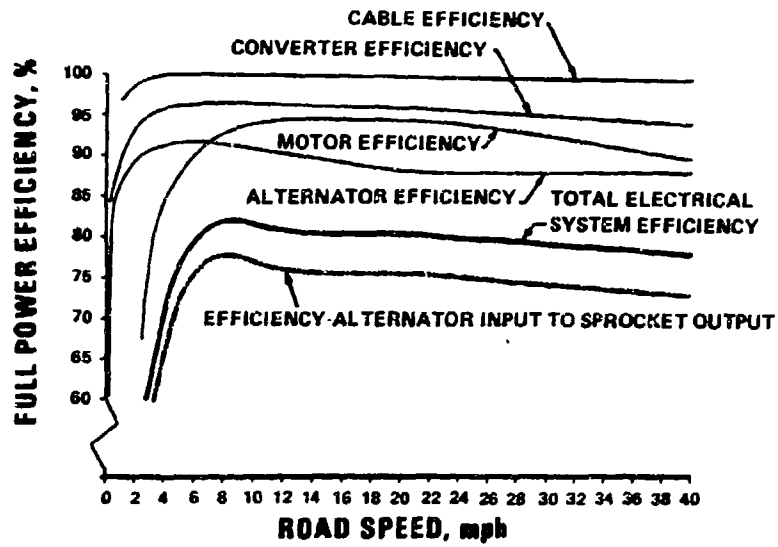
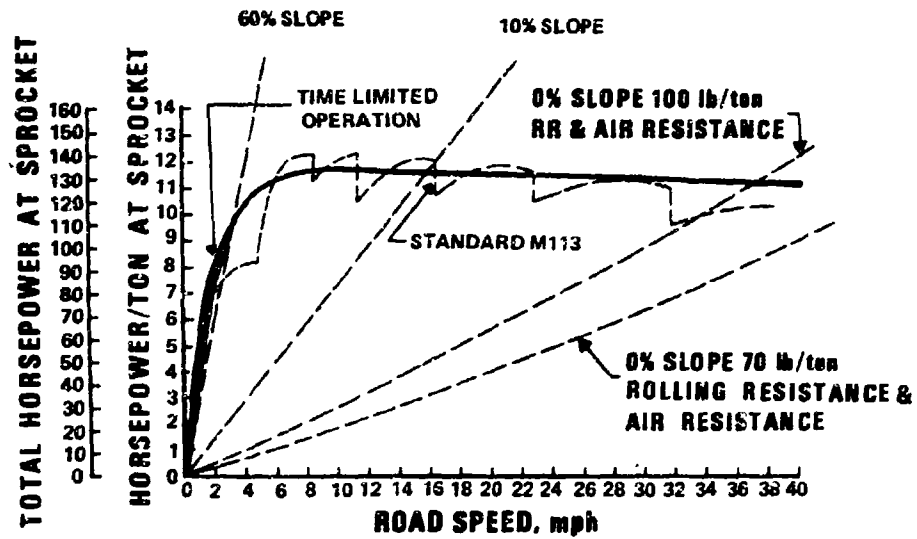

Figure 2-40. Electric Vehicle Cooling Installation (Ref. 12)
 (Release Granted by Society of Automotive Engineers, Inc., Paper No. 690442.)



(A) EFFICIENCY



(B) SPROCKET HORSEPOWER

Figure 2-41. Electric Vehicle Performance and System Efficiency (Ref. 12)
 (Release Granted by Society of Automotive Engineers, Inc., Paper No. 690442.)

AMCP 706-361

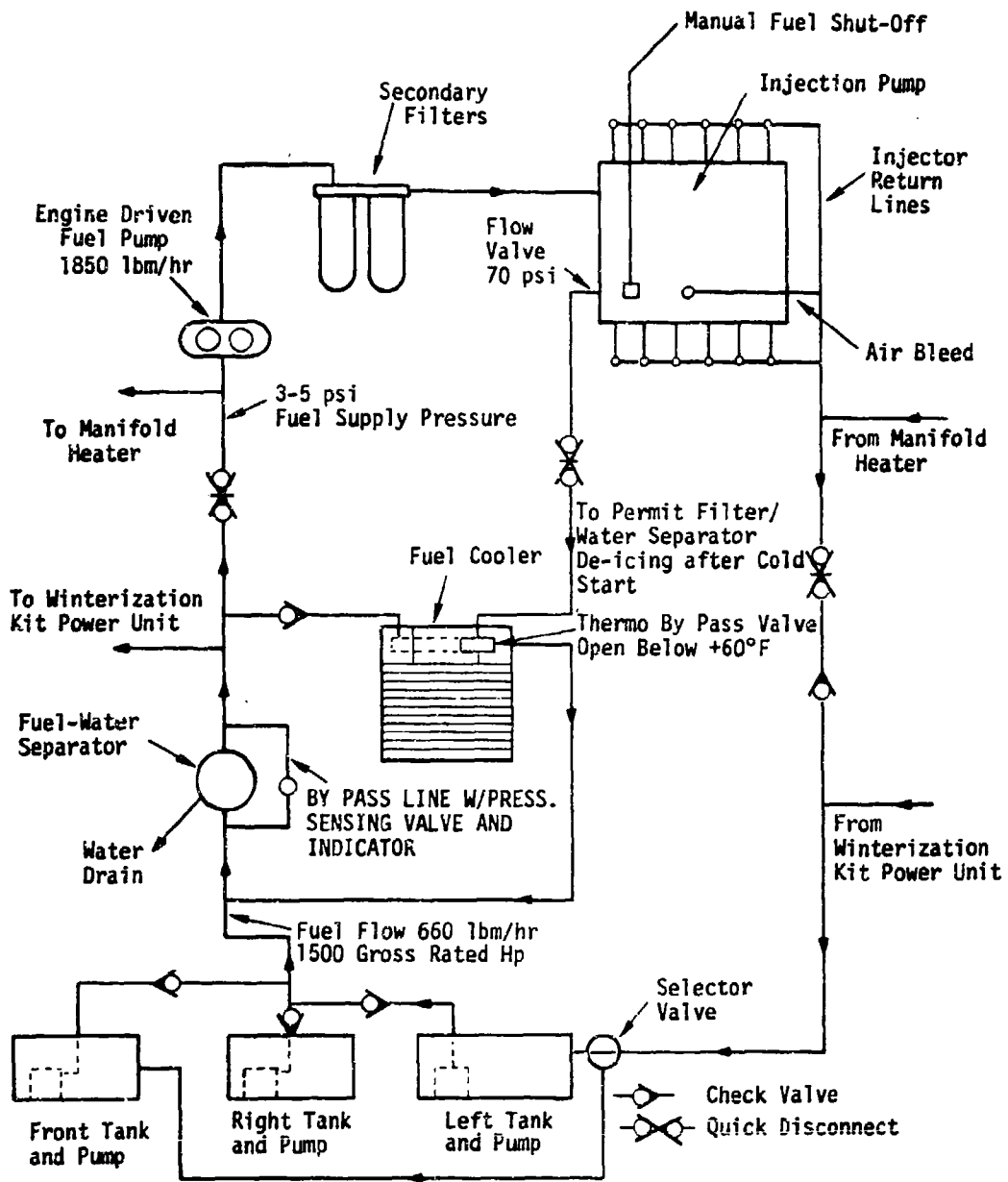

Figure 2-42. AVCR-1100-3 Tank Engine Fuel System Schematic Diagram

Btu/hr net cooling. The unit was installed in the engine compartment forward of the right fuel tank (see Fig. 2-43). An air inlet grille was provided as part of the kit replacing a removable plate in the sponson roof. Cooling for the condenser was provided by a hydraulically driven fan that discharged air through the engine/exhaust grilles via an exhaust duct. Efficiencies and heat rejection data are available from the air-conditioner manufacturers.

2-3.6 SOLAR AND GROUND RADIATION

Additional heat loads are added to a vehicle from solar and ground radiations. Typical compartment temperatures are shown in Table 2-8 for various vehicles. These temperatures were measured at Yuma Proving Ground, Arizona (Ref. 14).

Not only must the cooling system design consider the effect of solar radiation, the influence of the cooling system on the crew compartment temperatures also must be considered. *Human Engineering Guide for Equipment Designers* and MIL-STD-1472 (Refs. 15 and 16) specify a maximum effective temperature (ET) of 80°F for continuous crew exposure. AMCP 706-120, Ref. 29, provides information on the method of calculating heat loads due to solar radiation, crew, and equipment.

Values for solar radiation are given in Table 1-2 for all climate categories specified by AR 70-38 (Ref. 21).

2-3.7 AUXILIARY ENGINES

Auxiliary engines often are provided for combat vehicles for battery charging, operation of auxiliary vehicle equipment when the main engine is not running, to provide additional electrical capacity when the main engine generator or alternator is inadequate

for the imposed load, or to provide heat for the main engine to aid in extreme cold weather starting. Fig. 2-44 illustrates the installation of the auxiliary power unit (APU) in the MBT70 Prototype Tank. This unit was designed as a winterization kit for installation on selected vehicles only.

The cooling systems for the auxiliary power units usually are self-contained and do not interface with the main engine system except for winterization preheating. APU's are a heat source usually not shielded from the main engine and, as such, may add to the cooling problem. The heat from the main engine also have an appreciable effect on the cooling and fuel vapor handling problems of the auxiliary engine.

2-3.8 ENGINE COMPARTMENT VENTILATION HEAT LOADS

Provisions must be made for ventilation of enclosed engine compartments to maintain power package accessories and associated vehicle equipment at safe operating temperatures. Fig. 2-45 illustrates typical sources of heat in the engine compartment that must be considered in the vehicle cooling system design. A test method of determining the crew compartment cooling load for a tracked vehicle is described in Ref. 33.

Engine compartments normally are divided into hot and cold sections with sufficient sealing incorporated to minimize recirculation of the cooling air from the hot exhaust side to the cold inlet side. In addition, insulation often is applied to the exhaust pipes and shields to prevent damage to adjacent components due to radiated heat. Fig. 2-46 illustrates the MBT70 Prototype Tank cooling system baffles, and Fig. 2-47 illustrates the insulated and shielded exhaust system. A discussion of insulating materials and applications is found in par. 3-7.

AMCP 706-381

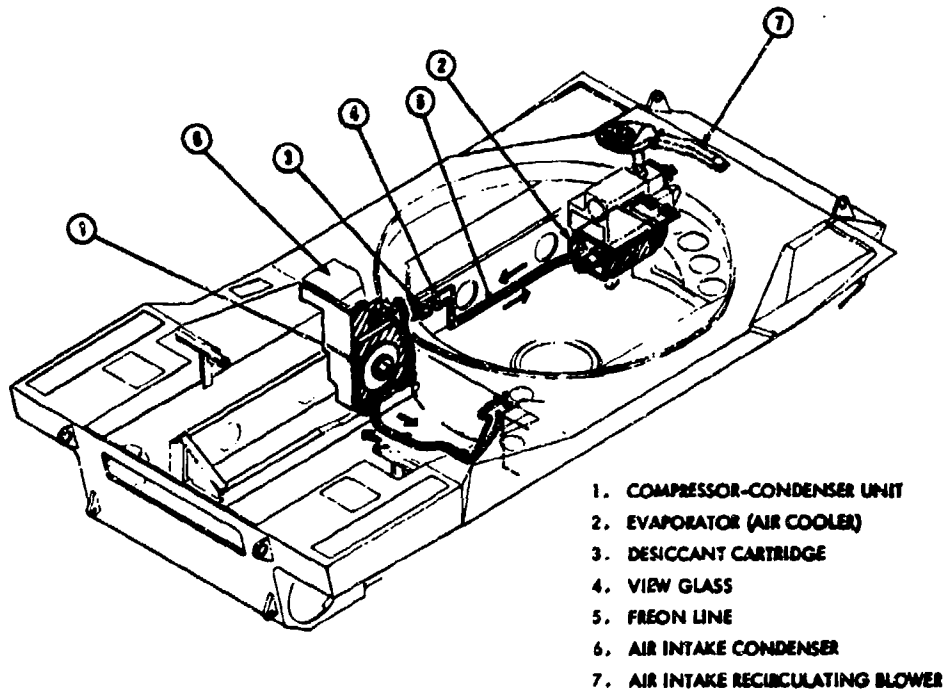

Figure 2-43. MBT70 Prototype Tank Environmental Control Unit (Ref. 18)

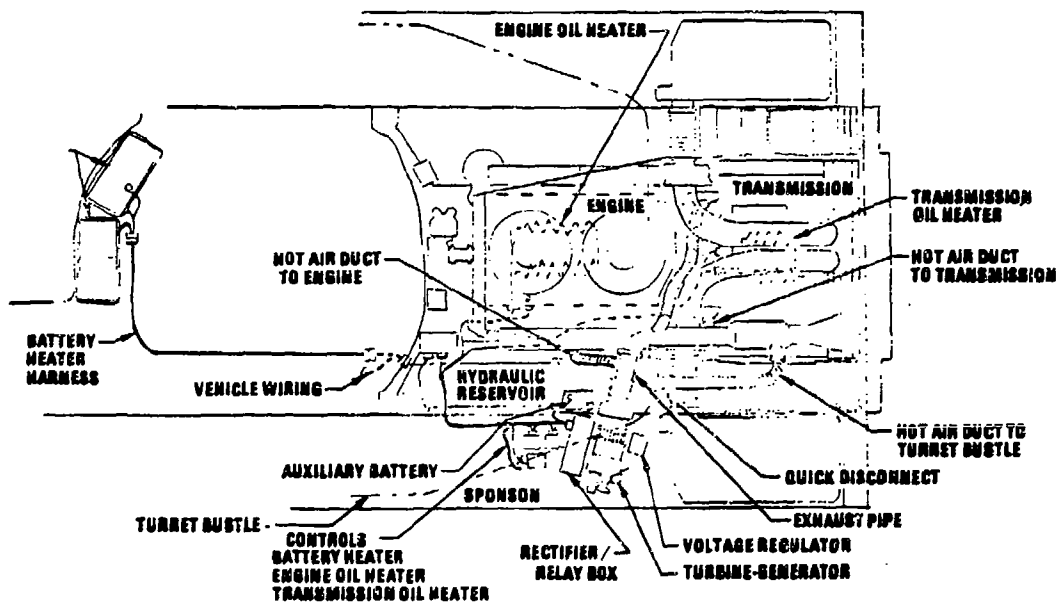

Figure 2-44. MBT70 Prototype Tank Auxiliary Power Unit Winterization Kit (Ref. 18)

TABLE 2-8

TYPICAL ENGINE COMPARTMENT TEMPERATURES
(Yuma Proving Ground)

<u>VEHICLE</u>	<u>TEMPERATURE LOCATION</u>	<u>AMBIENT TEMPERATURE, °F</u>	<u>COMPONENT TEMP RANGE, °F</u>	<u>YPG REPORT NO.</u>
M113E2 APC (A1)	Engine Comp. (before radiator)	115	119 - 157	3081
M113E2 APC (A1)	Engine Comp. (before radiator)	115	117 - 163	3081
XM571 Carrier	Air into Alternator	115	161 - 195	6005
M551 AARAV Engine	Comp. at rear over trans over regu- lator near fire exiting	125	201 - 232 227 - 254 196 - 218 198 - 223	9029
M50A1 Tank	Air between cylinders (air in bottom of Eng. Comp.)	115	122 - 158	not assigned
	Alternator skin		151 - 165	
XM561 Truck	Eng. Comp. (to radiator)	125	131 - 165	6007
M50A2 Truck	Eng. Comp. (after rad) Behind Regulator	115	172 - 225 130 - 175	8007
M715E1	Eng. Comp. (after rad) To carb.	120	170 - 208 174 - 176	0069
XM656	Eng. Comp. (after rad)	115	156 - 202	5023

AMCP 706-381

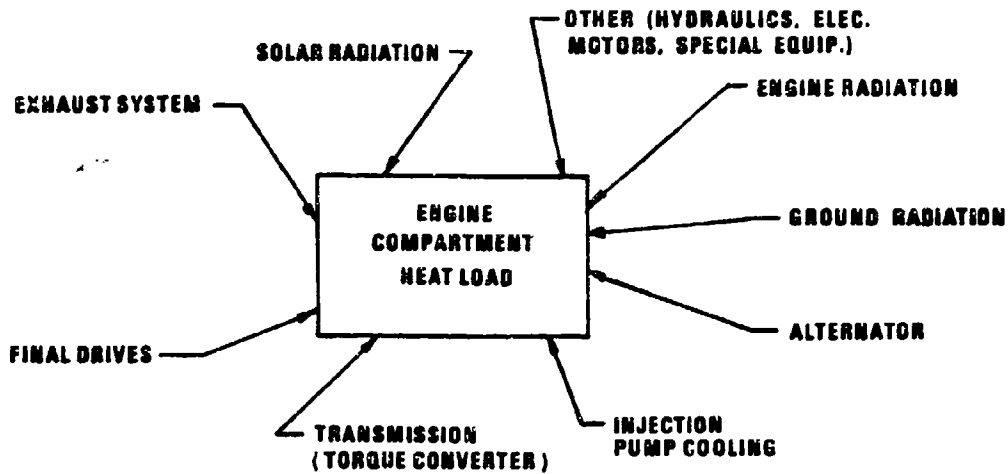
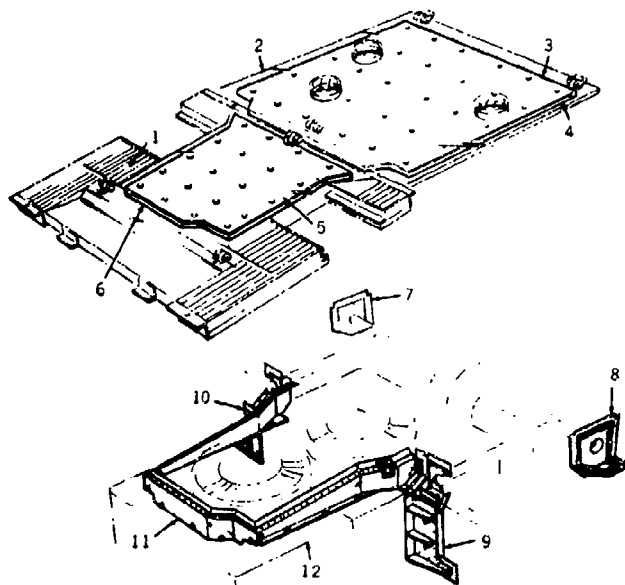

Figure 2-45. Typical Engine Compartment Ventilation Heat Loads



LEGEND

- | | |
|-----------------------------------|---------------------------------------|
| 1. ENGINE ROOF AND INTAKE GRILLES | 7. RIGHT REAR SHROUD ASSEMBLY |
| 2. ENGINE DOOR ACCESS PLATE | 8. LEFT REAR SHROUD ASSEMBLY |
| 3. REAR PLATE INSULATION | 9. LEFT AIR CLEANER SHROUD ASSEMBLY |
| 4. REAR PLATE | 10. RIGHT AIR CLEANER SHROUD ASSEMBLY |
| 5. FRONT PLATE INSULATION | 11. ENGINE SHROUD ASSEMBLY |
| 6. FRONT PLATE | 12. POWER PLANT |

NOTE. ENGINE DOOR ACCESS PLATE, ROOF, AND INTAKE GRILLES ARE SHOWN ELEVATED TO PROVIDE CLARITY IN ILLUSTRATION.

Figure 2-46. MBT70 Prototype Tank Cooling System Baffles (Ref. 18)

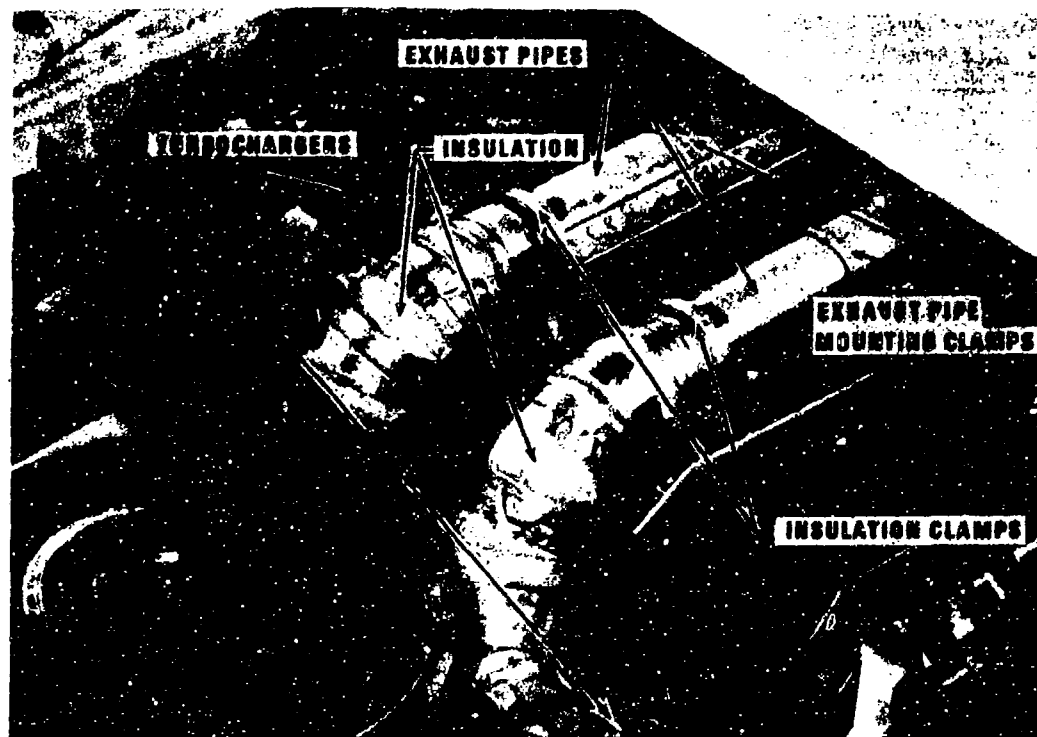

Figure 2-47. MBT70 Prototype Tank Exhaust Shields and Insulation

REFERENCES

1. Charles Fayette Taylor, *The Internal Combustion Engine in Theory and Practice*, Volume I, The MIT Press, Cambridge, Massachusetts, 1966.
2. Theodore Baumeister, *Standard Handbook for Mechanical Engineers*, Seventh Edition, McGraw-Hill Book Company, New York, N.Y., 1967.
3. AMCP 706-355, Engineering Design Handbook, *The Automotive Assembly*.
4. "Mobility Engineers Test Stirling Cycle Engine", *Automotive Industries*, Volume 35, August 1963.
5. Mattani, Heffner, and Miklos, *The Stirling Engine For Underwater Applications*, Paper No. 690731, SAE, New York, N.Y., 1969.
6. Agawal, Mooney, and Toepel, *Stir-Lec I, A Stirling Electric Hybrid Car*, Paper No. 690074, SAE, New York, N.Y., 1969.
7. Dr. W. G. Froede, *The NSU-Wankel Rotating Combustion Engine*, Paper No. 288A, SAE, New York, N.Y., 1961.
8. Herman Friedlander, *The HS400 Power Shift Transmission with Hydrostatic Steer for High Speed Military Track Laying Vehicles*, Paper No. 680540, SAE, New York, N.Y., 1968.

9. SAE Handbook, *Truck Ability Prediction Procedure* - SAE J688, SAE, New York, N.Y., 1973.
10. Gary Smith, *Commercial Vehicle Performance and Fuel Economy*, Paper No. SP-355, SAE, New York, N.Y., 1968.
11. David M. Latson, et al, *A Hydromechanical Transmission Development*, Paper No. 670932, SAE, New York, N.Y., 1967.
12. Kirtland, Andrus and Slobiak, *An AC Electric Drive System as Applied to A Tracked Vehicle*, Paper No. 690442, SAE, New York, N.Y., 1969.
13. Julius Mackerle, *Air Cooled Motor Engines*, Cleaver-Hume Press Ltd., London, England, 1958.
14. William L. Snider, *Desert Testing of Military Vehicles*, Paper No. 690354, SAE, New York, N.Y., 1968.
15. W.E. Woodson and D.W. Conover, *Human Engineering Guide For Equipment Designers*, University of California Press, Los Angeles, California, 1970.
16. MIL-STD-1472, *Human Engineering Design Criteria for Military Systems, Equipment and Facilities*.
17. C. Gasaway, *Heat Flow Characteristics of LDS 465-1B and -2 Engines*, Technical Note No. LDS 465-2 1642, Teledyne Continental Motors, Muskegon, Mich., 1969.
18. PDTM 9-2350-235-20, Volume No. 3, *Preliminary Organizational Maintenance Manual, CAE Engine and Accessories for Main Battle Tank Armored, Full-Tracked, 152 MM, MBT70*, December 1969.
19. Gordon J. Van Wylen and Richard E. Sonntag, *Fundamentals of Classical Thermodynamics*, 2nd Ed., John Wiley & Sons, New York, N.Y., 1973.
20. Carl J. Heise, *Dual Turbine - Battery Electric Vehicle Drive System*, Paper No. 729164, SAE, New York, N.Y., 1972.
21. AR 70-38, *Research, Development, Test and Evaluation of Materiel for Extreme Climatic Conditions*, May 1969.
22. J.F. Boyle and D.N. Nigro, *Applying the Allison GT-404 "The VIP in Action"*, Paper No. 720695, SAE, New York, N.Y., 1972.
23. AMCP 706-356, *Engineering Design Handbook, Automotive Suspensions*.
24. MIL-H-6083, *Hydraulic Fluid, Petroleum Base, For Preserving and Testing*.
25. MIL-H5606, *Hydraulic Fluid, Petroleum Base, Aircraft, Missile and Ordnance*.
26. J.A. Hoess and Ralph C. Stahman, *Unconventional Thermal, Mechanical, and Nuclear Low-Pollution-Potential Power Sources for Urban Vehicles*, Paper No. 69023, SAE, New York, N.Y., 1969.
27. P.K. Beatenbough, *Engine Cooling Systems for Motor Trucks*, Paper No. SP 284, SAE, New York, N.Y., 1966.
28. Robert Cramer, Jr., *Heat Rejection and Cooling Requirements of Internal Combustion Engines*, Paper No. 670524, SAE, New York, N.Y., 1967.
29. AMCP 706-120, *Engineering Design Handbook, Criteria for Environmental Control of Mobile Systems*.
30. Torbjorn Lia, *The Sterling Engine*, "Combustion Engine Progress", Transport Press Division of ITC Business Press, London, England, 1973.
31. M.J. Schlatter, *Evaluation of Fuel Cell Systems for Vehicle Propulsion*, Paper No. 670453, SAE, New York, N.Y., 1967.

32. Harry K. Ihrig, *The Fuel Cell Powerplant For Electrically Propelled Earthmoving Machinery*, Paper No. S-253, SAE, New York, N.Y., 1960.
33. Edward J. Rambie, *Crew Compartment Air Leakage, Pressure Drop, and Cooling Load Test of T-95 Tank*, Report No. 7460, Detroit Arsenal, Centerline, Michigan, October, 1962.
34. J. Kenneth Salisbury, Editor, *Kents' Mechanical Engineers' Handbook*, John Wiley and Sons, Inc., New York, N.Y., 1953.
35. Obert, E. F., *Internal Combustion Engines and Air Pollution*, Intext Educational Publishers, New York, N.Y., 1973.
36. Charles Jones, *A Survey of Curtiss-Wright's 1958-1971 Rotating Combustion Engine Technological Developments*, Paper No. 720468, SAE, New York, N.Y., 1972.

BIBLIOGRAPHY

- H.T. Adamo, *Elements of Internal Combustion Turbine Theory*, The Cambridge University Press, London, England, 1960.
- Burtz and Burton, *The Demonstration of an External Combustion Engine in a City Bus*, Paper No. 720682, SAE, New York, N.Y., 1972.
- F. Feller, *The 2-Stage Rotary Engine - A New Concept in Diesel Power*, The Institution of Mechanical Engineers Proceedings, Volume 195, 13/71, 1970-71.
- Gay, et al, *Power Plants for Industrial and Commercial Vehicles - A Look at Tomorrow*, Paper No. SP-270, SAE, New York, N.Y., 1965.
- Arthur W. Judge, *Modern Gas Turbines*, Chapman and Hall Ltd., London, England, 1968.
- Kirkland and Hopkins, *U.S. Army Research in Electric Propulsion*, Paper No. 670454, SAE, New York, N.Y., 1967.
- James H. Kress, *Hydrostatic Power-Splitting Transmission for Wheeled Vehicles-Classification and Theory of Operation*, Paper No. 690358, SAE, New York, N.Y., 1969.
- Lienesch and Wade, *Stirling Engine Progress Report: Smoke, Odor, Noise, and Exhaust Emissions*, Paper No. 680081, SAE, New York, N.Y., 1968.
- John G. MacDonald, *Hydromechanical Transmission as Applied to Mobile Equipment*, Paper No. 690358, SAE, New York, N.Y., 1969.
- R.T. Sawyer, *Gas Turbine Construction*, Chapman and Hall Ltd., London, England, 1958.
- C.O. Weisenbach, *Hydrostatic Transmission Applications*, Paper No. 680259, SAE, New York, N.Y., 1968.
- J.V.D. Wilson, et al, *A Laboratory Engine Test Method and Its Application to Evaluation of High Temperature Oil Thickening Problems in Gasoline Engines*, Paper No. 720688, SAE, New York, N.Y., 1972.
- Francis C. Younger, *Characteristics of the Brobeck Steam Bus Engines*, Paper No. 720684, SAE, New York, N.Y., 1972.
- K. Yamamoto, et al, *Combustion Characteristics of Rotary Engines*, Paper No. 720357, SAE, New York, N.Y., 1972.

3-0 LIST OF SYMBOLS

<i>A</i>	= area, ft ²
<i>ATB</i>	= air-to-boil, °F
<i>CFM</i>	= flow rate, ft ³ /min
<i>C_p</i>	= specific heat at constant pressure, Btu/lbm-°F
<i>D</i>	= diameter, ft
<i>e</i>	= heat exchanger effectiveness, dimensionless
<i>f</i>	= fouling factor, hr-ft ² -°F/Btu; fluid friction factor, dimensionless
<i>F</i>	= correction factor, dimensionless
<i>G</i>	= water flow rate, gpm/ft core width
<i>GPM</i>	= flow rate, gal/min
<i>HP</i>	= horsepower, hp
<i>h</i>	= convection heat transfer coefficient, Btu/hr-ft ² -°F
<i>ITD</i>	= initial temperature difference, °F
<i>k</i>	= thermal conductivity, Btu/hr-ft ² (°F/ft)
<i>K</i>	= unit core heat transfer capability, Btu/min-ft ² -°F
<i>L</i>	= length, ft
<i>LMTD</i>	= log-mean temperature difference, °F
<i>m</i>	= fin parameter as defined by Eq. 3-6a
<i>M</i>	= molecular weight of gas, lbm/lbm-mole
<i>P</i>	= gas pressure lbf/ft ²
<i>p</i>	= wetted perimeter, ft
<i>N</i>	= number, dimensionless
<i>Pr</i>	= Prandtl number, dimensionless
<i>Q</i>	= heat flow rate, Btu/min, Btu/hr

AMCP 706-361

LIST OF SYMBOLS (Cont'd.)

- \hat{q} = heat flux, Btu/hr-ft²
- r = radius, ft
- R = universal gas constant, 1544 ft-lbf/lbm-mole-°R;
temperature, ° Rankine
- Re = Reynolds number, dimensionless
- Res = resistance to heat transfer, hr-°F/Btu
- T = temperature, °F or °R
- U = overall heat transfer coefficient or conductance,
Btu/hr-ft²-°F
- V = fluid velocity, ft/hr
- w = flow rate, lbm/hr
- ΔP = pressure drop, in. water
- ΔT = temperature difference, deg F
- δ = thickness, ft
- μ = absolute viscosity, lbm/hr-ft
- ν = kinematic viscosity, ft²/sec
- η = efficiency, dimensionless
- ρ = density, lbm/ft³
- σ = Stefan-Boltzmann constant, 1.713×10^{-9}
Btu/hr-ft²-°R⁴
- ϵ = surface emissivity, dimensionless

Subscripts:

- a = air, actual
- am = ambient
- aw = air to water
- wa = water and air

LIST OF SYMBOLS (Cont'd.)

<i>c</i>	= cold
<i>c1</i>	= cooling air in
<i>c2</i>	= cooling air out
<i>cond</i>	= conduction
<i>conv</i>	= convection
<i>ca</i>	= coolant to air
<i>co</i>	= coolant
<i>f</i>	= fin, frontal, face
<i>fl</i>	= fluid
<i>fcs</i>	= fin conduction cross section
<i>fr</i>	= heat exchanger front
<i>g</i>	= gas
<i>h</i>	= hot, hydraulic
<i>h1</i>	= inlet of hot fluid
<i>h2</i>	= hot air out
<i>i</i>	= insulation material, inside, inlet
<i>la</i>	= liquid and air
<i>m</i>	= mean
<i>max</i>	= maximum
<i>min</i>	= minimum, smaller
<i>o</i>	= overall, outside
<i>oc</i>	= overall cold
<i>oh</i>	= overall hot
<i>r</i>	= reference for <i>U</i> , required, rejected

AMCP 708-361

LIST OF SYMBOLS (Cont'd.)

<i>rad</i>	= radiation
<i>s</i>	= surface
<i>t</i>	= total
<i>tu</i>	= transfer units
<i>w</i>	= wall, water
1	= inlet, flow rate, inner
2	= exit, tube length
3	= nonuniform airflow distribution, outer
4	= wall

Definition of Terms (See Preface)

Mass	lbm, pounds mass
Force	lbf, pounds force
Length	ft, in., feet, inches
Time	sec, min hr; seconds, minutes, hours
Thermal energy	Btu, British Thermal Unit

CHAPTER 3

HEAT TRANSFER DEVICES

Basic principles of heat transfer theory are presented in this chapter. Construction characteristics and design conditions of various heat transfer surfaces and heat exchangers are discussed. Various heat exchanger core design selection methods are presented and the unit core heat transfer capability method is discussed with illustrated examples. Methods of controlling engine compartment temperatures are discussed. Tables of military cooling system characteristics and radiator specifications are included for reference, and typical charts of various heat exchanger cores are presented. Additional charts are included in Appendix A.

3-1 INTRODUCTION

Approximately one-third of the energy produced by the combustion of fuel in an engine is converted to useful mechanical energy. Roughly another third of this energy is transferred to the atmosphere in the form of thermal energy in high temperature exhaust gases. The remainder must be removed from the system at its rate of generation and transferred to the surrounding atmosphere by forced convection, if the power train components are to be kept within the temperature limits specified for safe operation. Two methods of heat transfer by forced convection are in general use: direct and indirect. In the direct method, the air is blown over the engine which is especially designed to have a greatly extended heat transfer surface. In the indirect method, a liquid coolant is pumped through interior passageways in the engine and absorbs heat dissipated from various surfaces. Forced air will absorb this heat from the coolant as they both pass through a liquid-to-air heat exchanger. This heat exchanger is called a radiator. Both direct and indirect cooling systems frequently incorporate heat exchangers to transfer heat from the oil in the engine and power transmission assemblies.

3-2 MODES OF HEAT TRANSFER

Heat is transferred from one body to another by virtue of a temperature difference between them. There are three types of heat transfer: radiation, conduction, and convection. All are similar in that a temperature difference must exist and the heat is always transferred in the direction of the lower temperature; however, laws governing the heat transfer and the physical mechanisms of each transfer mode are different.

3-2.1 RADIATION

Heat may travel through space to another body. This may occur without necessarily warming the medium within the space. Heat radiation may take place through a vacuum and through some gases and liquids. The rate of heat radiated per unit surface area $(Q/A)_{rad}$ to the hemispherical space over it is in accordance with the general form of Stefan-Boitzmann's law

$$(Q/A)_{rad} = \epsilon \sigma T^4, \text{Btu/hr-ft}^2 \quad (3-1)$$

where

$$A = \text{surface area, ft}^2$$

AMCP 706-361

Q = total rate of heat flow, Btu/hr

T = temperature, °R

ϵ = surface emissivity, dimensionless

σ = Stefan-Boltzmann constant, 1.713×10^{-9} , Btu/hr-ft²-°R⁴

At the relatively low temperatures of the surfaces of the engine components, radiation is relatively insignificant and can be neglected in most calculations of engine cooling.

3-2.2 CONDUCTION

Heat may flow between two points within a body or between bodies in physical contact due to the difference in temperature. The rate of heat transfer per unit area $(Q/A)_{cond}$ depends on the thermal conductivity of the substance and the local temperature gradient:

$$(Q/A)_{cond} = k \frac{(T_h - T_c)}{L}, \text{ Btu/hr-ft}^2 \quad (3-2)$$

where

A = conduction cross-sectional area, ft²

k = thermal conductivity, Btu/hr-ft²-°F/ft

L = length of conduction path, ft

Q = total rate of heat flow, Btu/hr

T_h = temperature of hot surface, °F

T_c = temperature of cold surface, °F

Values of thermal conductivities for several common metals are shown in Fig. 3-41. Additional information may be found in numerous handbooks (e.g., Ref. 14).

The thermal resistance of heat transfer by conduction Res_{cond} is the temperature

difference required per unit heat transfer rate which is given by

$$Res_{cond} = \frac{L}{kA}, \text{ hr-°F/Btu} \quad (3-3)$$

3-2.3 CONVECTION

The combined effect of conduction in fluid and the motion of the fluid on heat transfer is called convection. Convection is heat transfer between a solid surface and a fluid in motion. Heated air moves upward because its density is lower than that of the cooler air above it. This process is called natural convection. If circulation is caused by fans, blowers, pumps, etc., the process is called forced convection.

Heat transfer by convection depends upon the motion of the fluids. The convection heat transfer phenomenon depends on the flow characteristics, surface characteristics, and thermal properties of the fluid. The usual way of expressing the rate of convection heat transfer per unit area $(Q/A)_{conv}$ between a solid and a fluid, is by means of the equation

$$(Q/A)_{conv} = h (T_s - T_{fl}), \text{ Btu/hr-ft}^2 \quad (3-4)$$

where

A = convection heat transfer area, ft²

h = convection heat transfer coefficient, Btu/hr-ft²-°F

Q = total rate of heat flow, Btu/hr

T_{fl} = fluid temperature, °F

T_s = surface temperature, °F

The value of h can be calculated analytically only in a few relatively simple flows. In general it is evaluated empirically for similar flow configurations.

The resistance to heat transfer by convec-

tion Res_{conv} is given by

$$Res_{conv} = \frac{1}{hA}, \text{ hr}^\circ\text{F/Btu} \quad (3-5)$$

3-3 HEAT TRANSFER FINS

Fins are extensions of a surface and are for the purpose of increasing the heat transfer surface and/or increasing the degree of flow turbulence which in turn will increase the convection heat transfer coefficient. The usefulness of fins increases with the ratio k/h of the surface material thermal conductivity to the convection heat transfer coefficient.

The temperature of a heat dissipating fin gradually decreases from fin base to tip. The effectiveness of fins as heat transfer surfaces is measured by the fin efficiency. This is the ratio of the actual heat dissipated from the fin surface to the heat which would be dissipated if the entire fin area were at its base temperature.

The fin efficiency η_f of a straight fin with constant cross-sectional area and dissipating heat to the surroundings by convection only is

$$\eta_f = \frac{\tanh(mL_f)}{mL_f}, \text{ dimensionless} \quad (3-6)$$

where

L_f = effective fin length, ft (fin length plus one half its thickness)

$\tanh(mL_f)$ = hyperbolic tangent of value mL_f , dimensionless

$$m = \sqrt{\frac{hp_f}{kA_{fs}}} ; \text{ or }^* \sqrt{\frac{2h}{k\delta_f}}, \text{ 1/ft} \quad (3-6a)$$

and

A_{fs} = fin conduction cross-sectional area, ft^2

h = convection heat transfer coefficient, $\text{Btu/hr-ft}^2\text{-}^\circ\text{F}$

p_f = wetted perimeter of fin, ft

δ_f = fin thickness, ft

*for a rectangular cross-section with a thickness small in comparison to the width.

The factor mL_f is important in designing fins because the smaller the product of mL_f the higher the fin efficiency. However, the fin efficiency is not the only important parameter for fin surface design. This is shown in Eq. 3-8 because the higher the product $\eta_o h A_t$, the higher the heat transfer rate.

The overall surface efficiency η_o of a heat transfer surface with fins can be determined by the combination of finned and nonfinned portions of the surface. It is found to be

$$\eta_o = 1 - \frac{A_f}{A_t} (1 - \eta_f), \text{ dimensionless} \quad (3-7)$$

where

A_f = fin heat transfer area, ft^2

A_t = total heat transfer area, ft^2

η_f = fin efficiency, dimensionless

The heat transfer rate Q from a surface to the ambient fluid is

$$Q = \eta_o h A_t (T_s - T_{am}), \text{ hr} \quad (3-8)$$

where

h = convection heat transfer coefficient, $\text{Btu/hr-ft}^2\text{-}^\circ\text{F}$

AMCP 706-331

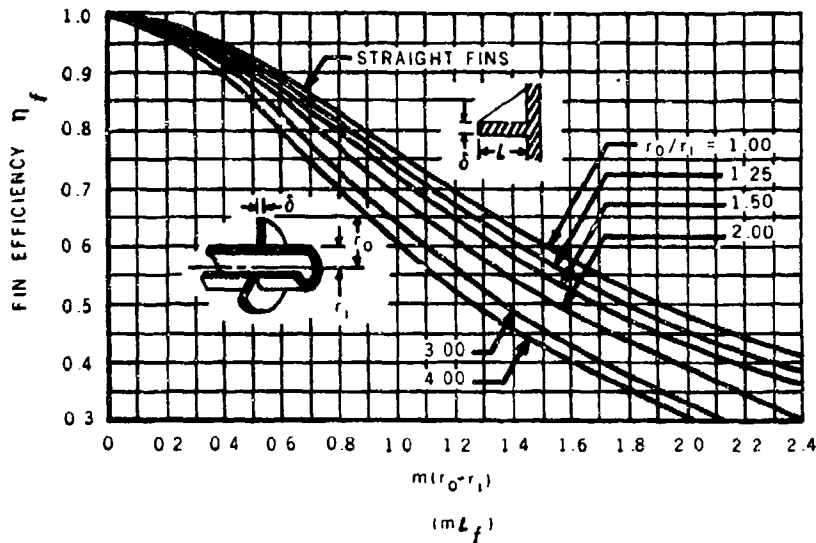

Figure 3-1. Fin Efficiency of Straight and Circular Fins (Ref. 2)
 (Courtesy of McGraw-Hill Book Company)

T_{am} = ambient temperature, °F

T_s = surface temperature, °F

η_o = overall surface efficiency, dimensionless (the value for a nonfinned surface is 1)

Fig. 3-1 shows the fin efficiency of straight and circular fins. Fin efficiency curves for various other fin configurations can be found in Ref. 4 and the heat transfer texts listed in the Bibliography.

The convection heat transfer coefficient h for liquid flow is usually high, and, few if any, fins are required. It is not practical to use fins under these conditions because of low fin efficiencies. Conversely, the convection heat transfer coefficient for gas flow is usually low, therefore, fins may be needed to increase the rate of heat transfer. This shows that the surface geometry required in heat exchangers depends on the type of fluid. The liquid side usually will have very few fins and the air side will have a substantial number of fins.

3-4 HEAT EXCHANGERS

Heat exchangers are devices for transferring heat from a heat source to a heat sink. In most cases, both the heat source and heat sink are fluids.

3-4.1 TYPES OF HEAT EXCHANGERS

Various types of heat exchangers are used in vehicle cooling. Generally they can be classified into two major types – steady flow and transient flow.

3-4.1.1 Steady Flow Heat Exchanger

The steady flow heat exchanger also is called a transfer type heat exchanger. Fluids pass through separate flow passages and heat is transferred from the hot-fluid passages to the cold-fluid passages through the separating walls.

3-4.1.2 Transient Flow Heat Exchanger

The transient flow heat exchanger also is

called a storage type or periodic flow type of heat exchanger. The hot and cold fluid's flow through the same passages and over the same surfaces at different times. The matrix structure serves as a thermal energy capacitor and stores heat while the hot fluid is flowing through. At periodic intervals, either by rotating the matrix or by switching the fluids, the process is reversed and the hot matrix transfers heat to the colder fluid. The regenerator of a gas turbine engine is this type of heat exchanger.

3-4.2 HEAT EXCHANGER CLASSIFICATION BY FLOW ARRANGEMENT

Most heat exchangers used in vehicles are steady flow types. Further classifications of this type of heat exchanger are presented in the paragraphs that follow. It must be noted that it is not practical to include and classify all heat exchanger types. The classifications that follow are presented for general information only.

3-4.2.1 Parallel Flow

The hot and cold fluids have the same flow direction in the parallel flow heat exchanger. A sketch of this flow arrangement and temperature distributions is shown in Fig. 3-2(A).

3-4.2.2 Counterflow

The hot and cold fluids flow in opposite directions in the counterflow heat exchanger. A sketch of this flow arrangement and temperature distributions is shown in Fig. 3-2(B). With this type of heat exchanger, it is possible to have a higher exit temperature for the entering "cold" fluid than the exit temperature of the entering "hot" fluid.

3-4.2.3 Crossflow

In a crossflow heat exchanger, the flow directions of hot and cold fluids are perpendicular to each other. There are three

variations of this type of heat exchanger:

1. Both fluids are unmixed in the heat exchanger core. The term unmixed indicates that a fluid particle remains in one flow passage as it passes through the core.

2. One fluid is unmixed, the other is mixed in the heat exchanger core.

3. Both fluids are mixed in the heat exchanger core. (It must be noted that this does not mean that both fluids have direct contact. It just implies that each fluid mixes with its own kind throughout the heat exchanger core.)

These classifications depend on the flow conditions inside the core. Moreover, the flow inside the turning panels between passes (multipass heat exchangers) can be either mixed or unmixed. A sketch of the flow arrangement and temperature distributions is shown in Fig. 3-3.

3-4.2.4 Cross-counterflow

The cross-counterflow heat exchanger is a multipass type unit that is a combination of the crossflow and counterflow arrangements. A diagram of this type heat exchanger is shown in Fig. 3-4(A).

3-4.2.5 Cross-parallel Flow

The cross-parallel flow heat exchanger is a multipass type unit that is a combination of crossflow and parallel flow arrangements. A diagram of this type heat exchanger is shown in Fig. 3-4(B).

3-4.2.6 Comparison of Heat Exchangers Based on Flow Arrangements

Typical heat transfer characteristics – as a function of fluid temperature change for parallel flow, crossflow, and counterflow heat exchangers – are shown in Fig. 3-5. Combination flow type heat exchangers have inter-

AMCP 703-361

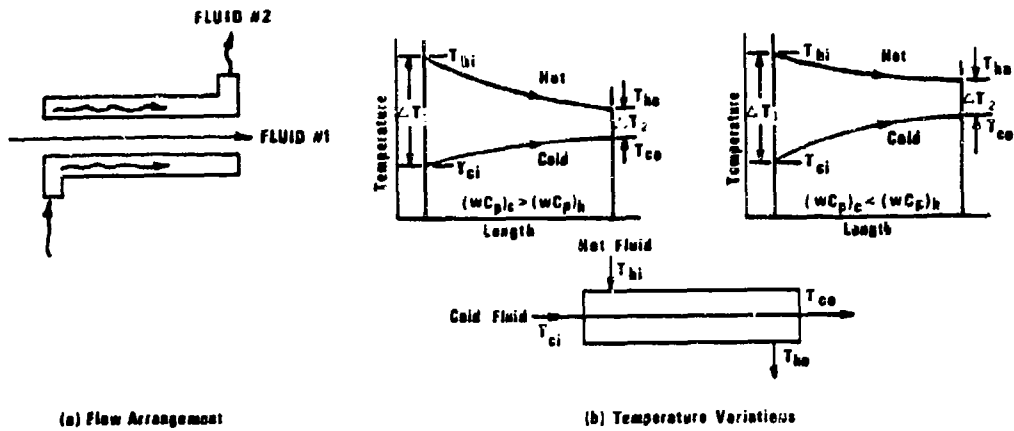

(A) PARALLEL FLOW

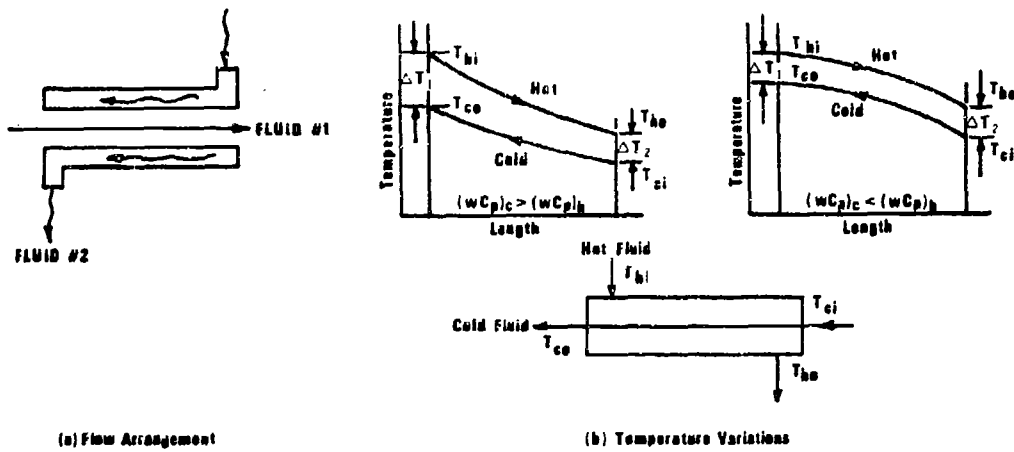

(B) COUNTERFLOW

Figure 3-2. Parallel and Counterflow Heat Exchanger Flow Arrangements and Temperature Variations (Ref. 22)
 (Reprinted With Permission of Macmillan Publishing Company, Inc. From Heat Transfer, 3rd Edition, Copyright 1974, by Alan Chapman)

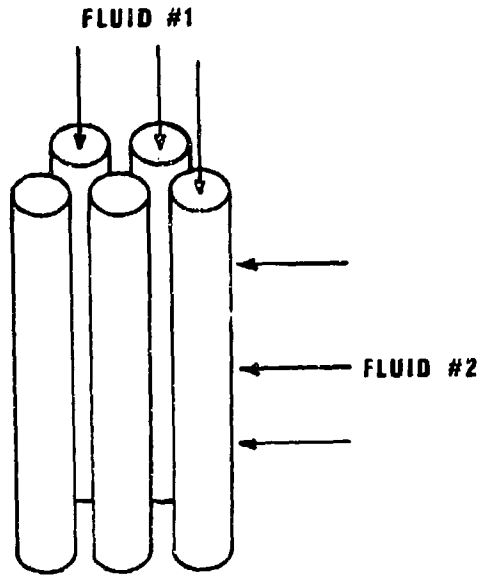

(A) FLOW ARRANGEMENT

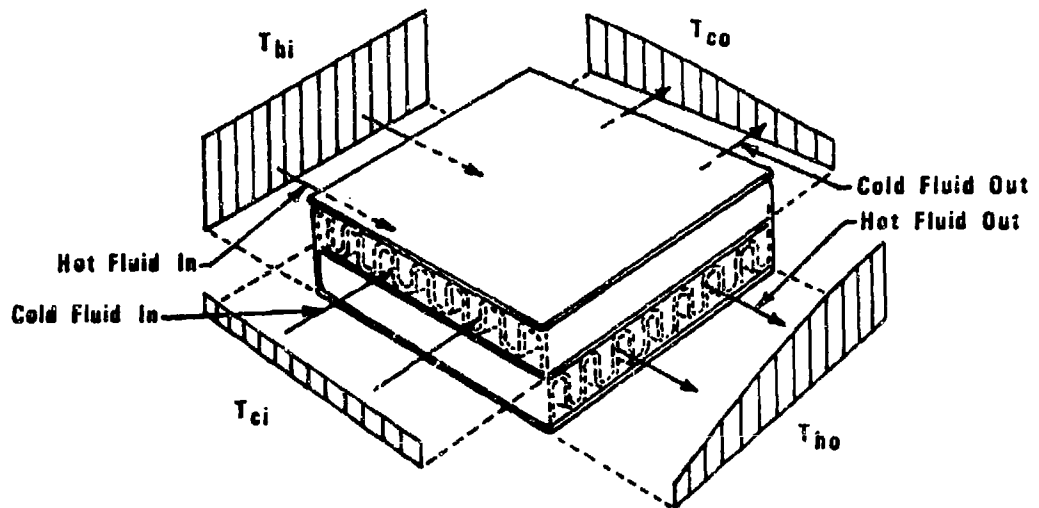

(B) TEMPERATURE DISTRIBUTIONS

(Ref. 23 - Courtesy of Prentice-Hall, Inc.)

Figure 3-3. Crossflow Heat Exchanger Fluid Flow Arrangement and Temperature Distributions

AMCP 706-361

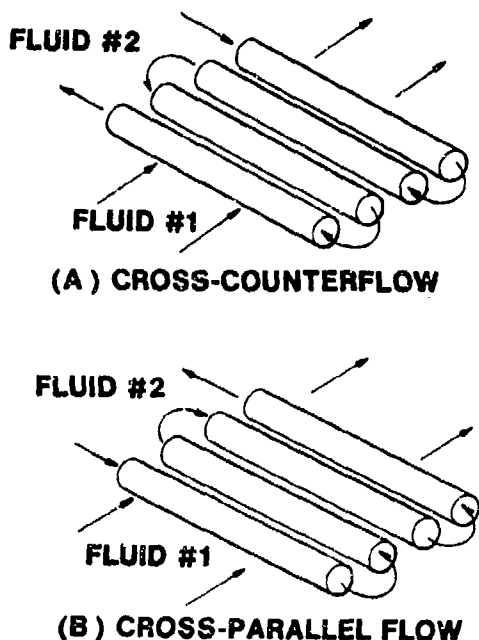

Figure 3-4. Cross-parallel Flow and Cross-counterflow Heat Exchanger Flow Arrangement (Ref. 3)

mediate heat transfer characteristics.

In the region where the fluid temperature change is a small percentage of the inlet fluids temperature difference, all types of heat exchangers require approximately the same heat transfer surface area.

The counterflow heat exchange requires the least area throughout the range. It is the only type that can be used when the fluid temperature change in one or both of the fluids is required to approach the temperature difference between the entering fluid streams. The use of the counterflow heat exchanger is desirable, when feasible, for performance reasons. However, other considerations often dictate the use of different heat exchanger types. As shown in Fig. 3-2(B), the fluid flow in a tubular counterflow heat exchanger is such that one fluid is flowing inside the tubes

and the other fluid is flowing outside the tubes in the opposite direction. This arrangement presents problems in fabrication and assembly of the header and ducts. The crossflow arrangement, Fig. 3-3, presents a more convenient header configuration. The crossflow heat exchanger also tends to have higher convection heat transfer coefficients on the outside surface of the tubes because of increased fluid flow turbulence. Staggered rows of tubes will give higher convection heat transfer coefficients than in-line rows of tubes. Because of the ease of fabrication and better performance, the crossflow heat exchanger is used widely in industry.

For multipass heat exchangers, as the number of passes increases, the performance approaches that of a counterflow unit. Practical considerations of design and fluid pressure drop, however, limit the number of passes. Typical two-pass configurations are shown in Figs. 3-16 and 3-17.

3-4.3 HEAT EXCHANGER CLASSIFICATION BY HEAT TRANSFER SURFACE GEOMETRIES

There are a great variety of surface geometries used for the cores of heat exchangers. Each geometry has its own characteristics with regard to heat transfer and resistance to flow. The heat transfer surface geometries may be divided into general groups as discussed in the paragraphs that follow.

3-4.3.1 Plate-fin Surfaces

The fluids are separated by layers of plates. The fluids flow in alternate spaces between the plates. The space between the plates contains fins of thin sheet metal folded into various geometries. There are many possible geometries of this fin arrangement such as: continuous plain, interrupted, etc.

In plate-fin heat exchangers, either or both sides of the core plate flow passage can be

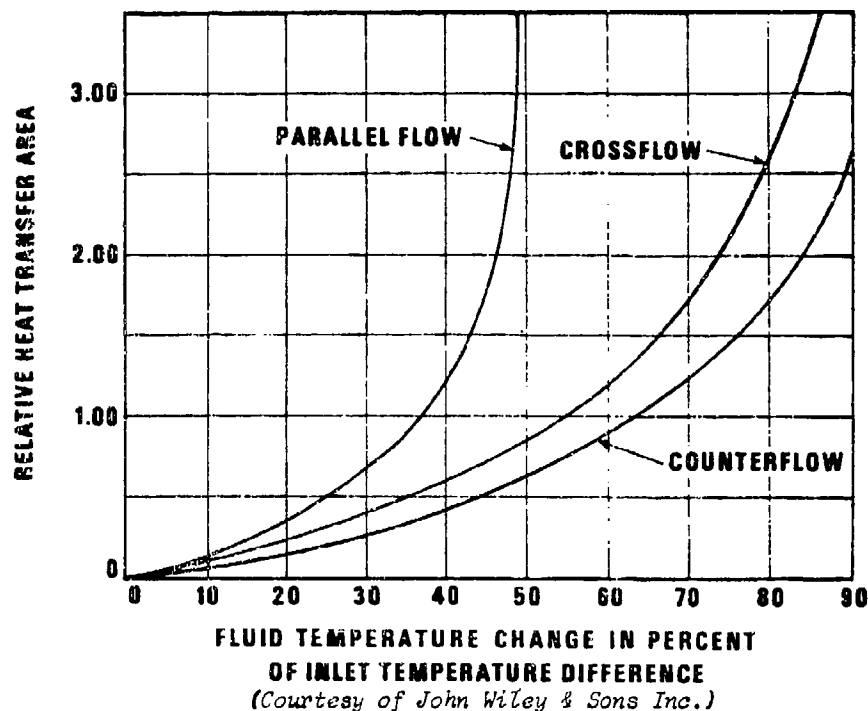

Figure 3-5. Required Relative Heat Transfer Surface Area As a Function of the Ratio of the Temperature Change in the Fluid Stream (Ref. 3)
 (Courtesy of John Wiley & Sons Inc.)

made of single sandwich or multisandwich construction. Various construction and fin shapes are shown in Figs. 3-6 and 3-7.

3-4.3.1.1 Plain-fin Surfaces

Plain-fin surface refers to fin passages in a continuous uninterrupted pattern. The flow passage shape may be rectangular, triangular, or other configurations.

3-4.3.1.2 Interrupted Fin Surfaces

Interruptions in the flow passages increase heat transfer capability by preventing the development of a thick boundary layer during forced convection. Some of the commonly used interrupted fin surfaces are shown in Fig. 3-8.

Combinations of several interrupted fins are also used. Although the heat transfer performance can be improved by interrupted fin surfaces, the fluid friction also is increased.

3-4.3.2 Tubular Surfaces

A heat exchanger core or matrix may consist of a bank of tubes. There are various geometric configurations of matrices. Common tube configurations include:

1. Circular or noncircular tubes
2. Plain or dimpled tubes
3. Finned or nonfinned tubes

AMCP 706-381

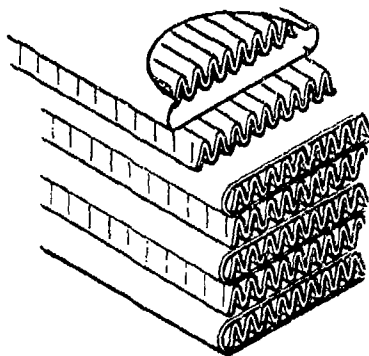

(A) TRIANGULAR FIN PASSAGE

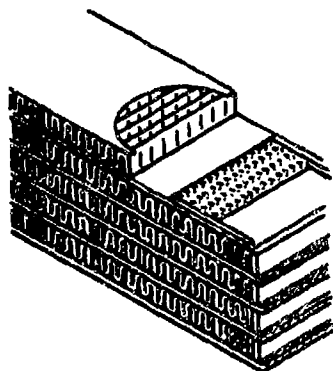

(B) RECTANGULAR FIN PASSAGE

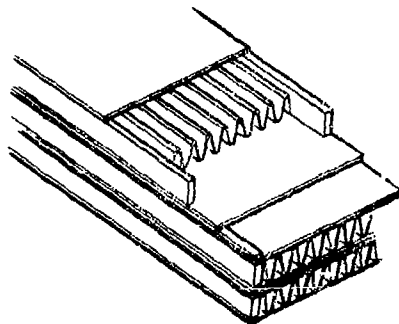

(C) TRAPEZOIDAL FIN PASSAGE

*Figure 3-6. Heat Exchanger Core Construction With Plate-fin Shapes
 (Harrison Radiator Division-GMC)*

4. Concentric type

5. Tube bundle type

6. Tubes with or without turbulators inside the tube to increase fluid flow turbulence.

3-4.3.3 Fin and Tube Configurations

Tubular heat exchangers also may be classified by fin tube configurations with many variations existing as:

1. Longitudinal fin type (internal or external)
2. Circular fin type
3. Continuous or interrupted plate-fin type.

3-4.4 HEAT EXCHANGER CLASSIFICATION BY FLUIDS INVOLVED

Heat exchangers may be classified in terms of the fluids involved as:

1. Liquid-to-liquid
2. Gas-to-liquid
3. Gas-to-gas.

3-5 HEAT EXCHANGER DESIGN AND SELECTION

Factors that must be considered in the design or selection of heat exchangers are

1. Heat transfer requirement
2. Fluid pressure drop limitations
3. Stress and mounting considerations
4. Material requirements and fabrication techniques

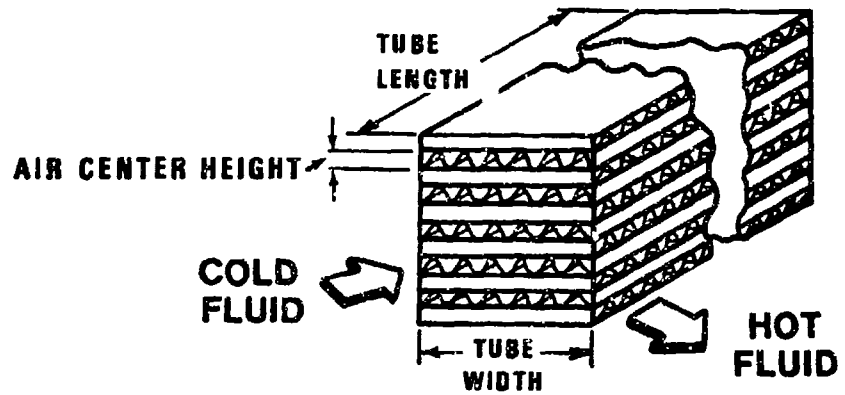

(A) SINGLE SANDWICH EACH SIDE

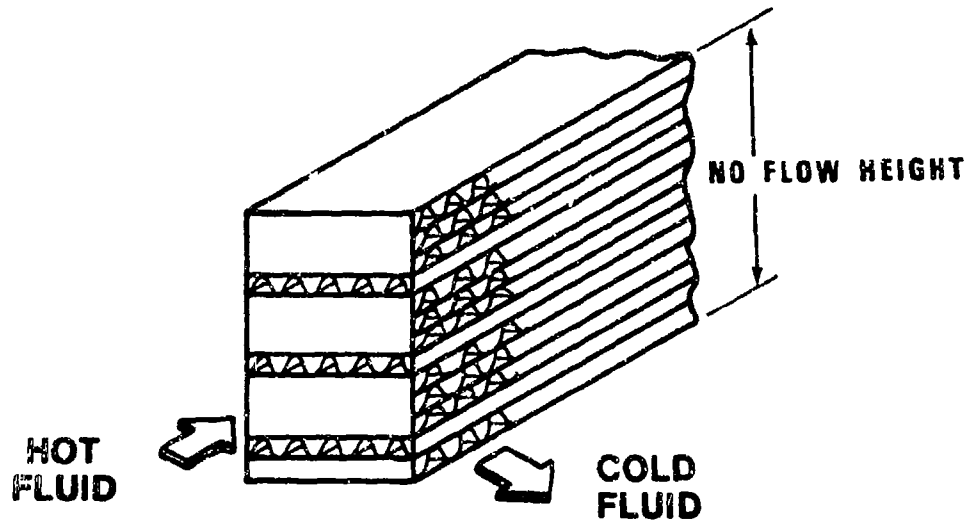

(B) SINGLE SANDWICH HOT SIDE, TRIPLE SANDWICH COLD SIDE

Figure 3-7. Heat Exchanger Core Construction Variation

5. Cost considerations
6. Operating, servicing, repair, and maintenance considerations.

The majority of heat exchangers in vehicle cooling systems are two-fluid transfer types in

which the two fluids exchanging heat are separated by the heat transfer surface. Only this type heat exchanger is discussed in this handbook.

It is not always possible to follow a definite procedure in selecting a heat exchanger for a

AMCP 706-361

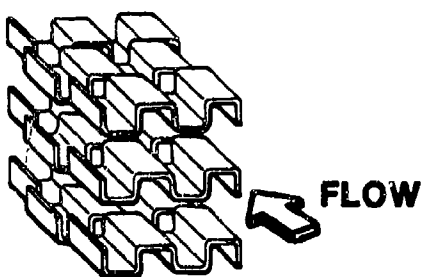

(A) OFFSET FIN (sometimes called segmented fin, serrated fin, or strip fin)

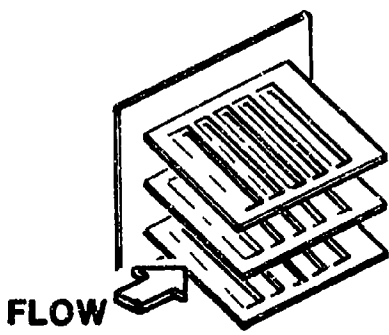

(B) LOUVERED FIN

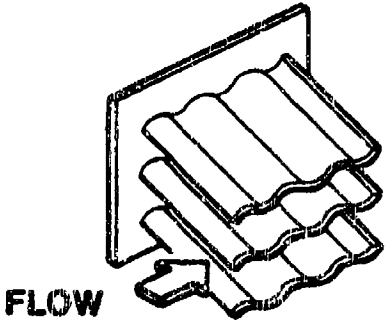

(C) CORRUGATED FIN

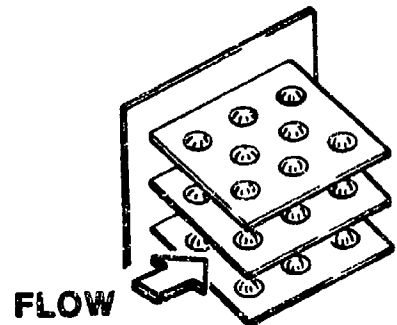

(D) DIMPLED FIN

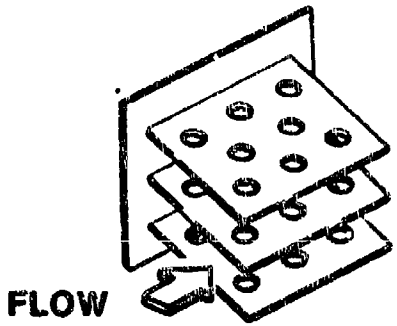

(E) PERFORATED FIN

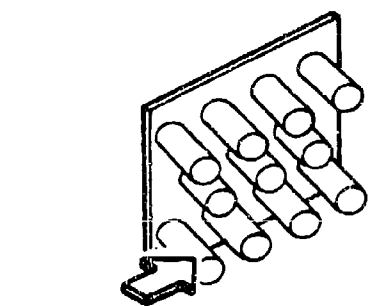

(F) PIN FIN

Figure 3-2. Heat Exchanger Core With Interrupted Fin Surfaces

specific application because of the many design constraints imposed by both vehicle design and heat exchanger design characteristics. A general procedure may be defined as follows:

1. Define inputs from analysis of the system specifications. These would include:

- a. Required heat rejection rate Q_r (engine, transmission, etc.)
- b. Maximum operating and maximum allowable fluid pressure drops
- c. Size limitations of heat exchanger (frontal area and thickness)
- d. Maximum operating terminal temperatures of the fluids
- e. Fluid flow rates
- f. General fluid flow arrangement and location of the heat exchanger in the system.

These data often can be given to the heat exchanger manufacturer and a standard "off the shelf" unit may be available that will fulfill all requirements.

2. Calculate the temperature difference ΔT_m between the fluids. This may be done by the following methods:

a. Initial temperature difference *ITD* or temperature of the coolant minus temperature of the cooling medium ($T_{h1} - T_{c1}$)

b. Average coolant temperature minus the temperature of the cooling medium

$$\frac{(T_{h1} + T_{h2})}{2} - T_{c1}$$

c. Log mean temperature difference (see Eq. 3-11)

3. Calculate the unit core heat transfer

capability (see Eq. 3-13).

4. Review manufacturers' performance charts such as Fig. 3-10, for available cores that will provide adequate cooling capacity.

5. Determine ΔP through the core for the unit selected in step 4.

6. Determine the vehicle cooling system ΔP and cooling fan characteristics. See Chapter 7 for system resistance determination. The system resistance also may be obtained from mock-up testing (see Chapter 9). See Chapter 4 for cooling fan characteristics and system resistance matching

7. At this point, it may be found that the available heat exchanger cores do not provide the required characteristics within the vehicle imposed constraints. The core ΔP may be too great and require excessive fan horsepower, the required size may not fit within the allocated space, and trade-off or optimization studies must be made (See pars. 3-6.2.1.5, 3-6.6, and 8-4)

8. Select a heat exchanger size to be compatible with the vehicle design limitations (See Eq. 3-13).

9. Apply correction factor F_2 for tube length other than 12 in. (See Fig. 3-12).

10. Apply correction factor F_1 for coolant flow rates other than rates given on the manufacturers' charts (See Fig. A-63).

11. Apply correction factor F_3 for nonuniform airflow distribution across the core face area.

12. If the heat transfer rate required Q_r is less than the calculated heat transfer rate Q_a , then it becomes necessary to perform iterations by changing one or more of the following parameters until Q_a is equal to or greater than Q_r :

AMCP 706-361

- a. Core thickness
- b. Core frontal area
- c. Core design
- d. Liquid flow rate
- e. Cooling medium flow rate and flow direction
- f. Location of the heat exchanger in the power package compartment.

13. It is common practice to provide reserve cooling capacity of from 10 to 20 percent to permit degradation of the heat exchanger cooling capacity caused by fin damage, fouling, and plugging.

14. The final design will include the incorporation of all applicable hardware requirements including mounting, drain, access, stone and debris protection, and similar design considerations.

3-5.1 THERMAL DESIGN PRINCIPLES OF TWO-FLUID HEAT EXCHANGER CORES

3-5.1.1 Basic Thermal Design Equations

In most heat exchanger designs, the change of kinetic and potential energies of the fluids and the heat interactions with surroundings are negligible. Under steady-state conditions, the equations presented in the following paragraphs are used.

3-5.1.1.1 Energy Balance Equation

The energy balance equation for a heat exchanger, assuming the specific heat is constant over the temperature range of interest, is

$$\left\{ w_h C_{ph} (T_{h2} - T_{h1}) \right\} - \left\{ w_c C_{pc} (T_{c2} - T_{c1}) \right\} = 0 \quad (3-9)$$

where

C_{pc} = specific heat of cold fluid at constant pressure, Btu/lbm-°F

C_{ph} = specific heat of hot fluid at constant pressure, Btu/lbm-°F

T_{c1} = cold fluid temperature (inlet), °F

T_{h1} = hot fluid temperature (inlet), °F

T_{c2} = cold fluid temperature (exit), °F

T_{h2} = hot fluid temperature (exit), °F

w_c = cold fluid flow rate, lbm/hr

w_h = hot fluid flow rate, lbm/hr

This assumption is satisfactory for gases at low pressure and for liquids, except near the critical point of the fluid.

3-5.1.1.2 Heat Transfer Rate Equations

An equation for the heat transfer rate between two fluids in a heat exchanger can be expressed by the three following methods:

1. Log-mean temperature difference (*LMTD*) method

$$Q = UA_r \Delta T_{\log-m}, \text{ Btu/hr} \quad (3-10)$$

where

A_r = area in reference to U , ft²

U = overall heat transfer coefficient, Btu/hr-ft²-°F

$$\Delta T_{\log-m} = \frac{(T_{h1} - T_{c2}) - (T_{h2} - T_{c1})}{\ln \left(\frac{T_{h1} - T_{c2}}{T_{h2} - T_{c1}} \right)} \quad (3-11)$$

(Eq. 3-11 is the *LMTD* between the two

fluids assuming true counterflow)

where

- T_{c1} = inlet temperature of cold fluid, °F
- T_{c2} = outlet temperature of cold fluid, °F
- T_{h1} = inlet temperature of hot fluid, °F
- T_{h2} = outlet temperature of hot fluid, °F

The reader is referred to Refs. 1, 3, 4, 8, 13 and the Bibliography for details.

2. Heat exchanger effectiveness N_{tu} (number of heat transfer units) method. In the N_{tu} method, an effectiveness e (dimensionless) of a heat exchanger is defined by the ratio of the actual heat transfer rate to the maximum (thermodynamically possible) heat transfer rate for the same heat exchanger.

The heat exchanger effectiveness depends on a parameter N_{tu} that takes into account the type and size of the exchanger core, the flow arrangement, and the flow rates.

Ref. 2 gives the heat exchanger effectiveness dependence on N_{tu} for various flow patterns where

$$Q = e(wC_p)_{min}(T_{h1} - T_{c1}), \text{ Btu/hr} \quad (3-12)$$

where

- C_p = fluid specific heat at constant pressure, Btu/lbm-°F
- w = flow rate, lbm/hr
- $(wC_p)_{min}$ = the smaller of either $(wC_p)_{hot}$ or $(wC_p)_{cold}$ magnitudes, Btu/hr - °F
- e = heat exchanger effectiveness, dimensionless

3. Unit core heat transfer capability (or

unit conductance) method

$$Q = KF_1F_2F_3A_{fr}\Delta T_m, \text{ Btu/min} \quad (3-13)$$

where

- A_{fr} = reference heat exchanger core face area, ft²
- F_1 = correction factor for coolant flow rate, dimensionless (see Fig. A-63)
- F_2 = correction factor for tube length other than 12 in., dimensionless (see Fig. 3-12)
- F_3 = correction factor for nonuniform airflow distribution across the heat exchanger core face area, dimensionless
- K = unit core heat transfer capability, Btu/min-ft²-°F
- ΔT_m = fluid temperature difference, °F (as defined in par. 3-5)

3-5.1.1.2.1 Thermal Resistance Equation

Thermal resistance of scales or film on both sides of the heat transfer surface must also be considered. If they are significant, the overall heat transfer coefficient U can be calculated, provided all the individual resistances are known.

Typical fouling factors for heat transfer equipment may be found in Refs. 1, 3, 4, and 8. For a clean heat transfer surface, the fouling factors usually may be neglected. Under these conditions

$$\frac{1}{UA} = \frac{1}{\eta_o h A_o} + \frac{\delta_w}{A_w k_w} + \frac{1}{\eta_o c h_c A_c}, \quad (3-14)$$

hr-°F/Btu

AMCP 706-361

where

A_h = heat transfer surface area of the hot side, ft²

A_c = heat transfer surface area of the cold side, ft²

A_w = conduction cross-sectional area of the solid wall, ft²

A_r = reference surface area for U , ft²

k_w = thermal conductivity of wall, Btu/hr-ft²-°F/ft

h_h = convection heat transfer coefficient of the hot side, Btu/hr-ft²-°F

h_c = convection heat transfer coefficient of the cold side, Btu/hr-ft²-°F

U = overall conductance or overall heat transfer coefficient, Btu/hr-ft²-°F of A_r

η_{oh} = overall hot side surface efficiency, dimensionless

η_{oc} = overall cold side surface efficiency, dimensionless

δ_w = wall thickness, ft

Most heat exchangers for vehicle applications have very thin walls and $\delta_w/(A_w k_w)$ is small enough to be neglected and Eq. 3-14 becomes

$$\frac{1}{UA_r} = \frac{1}{\eta_{oh} h_h A_h} + \frac{1}{\eta_{oc} h_c A_c}, \text{ hr-°F/Btu (3-14a)}$$

The nomograph presented in Fig. 3-9 is useful for determining UA_r .

3-5.1.1.2.2 Basic Heat Exchanger Core Design

For basic heat exchanger core design, either

the log-mean temperature difference method or the effectiveness N_{tu} method may be used. Many excellent references are available for discussing these two methods (See Refs. 1, 2, 3, 4, 8, 12, 13, 14, and the Bibliography). Both of these methods require the heat transfer factor j fluid friction factor f , and their relations with the Reynolds number Re and Prandtl number Pr . Additionally, heat transfer surface parameters must be known. Most of these characteristics are proprietary information of industry and usually are not available. Designers of military cooling systems are not responsible for actual detailed design of heat exchangers. The designers basically perform preliminary analysis and selection of existing heat exchanger designs. Under these conditions, the unit core heat transfer capability method generally is used.

3-5.1.1.2.3 Unit Core Heat Transfer Capability Method

In the automotive industry, numerous heat exchangers are made from several basic cores. Each manufacturer has his own unique core designs. Usually cores of 12 in. (width) X 12 in. (height) of various thicknesses are tested in a wind tunnel. Heat transfer and flow resistance characteristics are obtained and generally are presented as shown in Fig. 3-10(A) when ΔT is expressed as deg F entering temperature difference.

The unit core heat transfer capability A of air-cooled radiators is represented by the following expression:

$$A = KA_{fr} F_1 F_2 F_3 (T_w - T_a), \text{ Btu/min (3-15)}$$

where

A_{fr} = core frontal area, ft²

F_1 = correction factor for coolant flow rate, dimensionless (see Fig. A-63)

F_2 = correction factor for tube length other than 12 in., dimensionless (see Fig. 3-12). This factor is applied

EXAMPLE

GIVEN $\eta_{oc} h_c A_c = 800$
 $\eta_{oh} h_h A_h = 400$

A LINE IS MADE BETWEEN THESE TWO POINTS.
 THIS LINE INTERSECTS UA_r , AT 240 WHICH IS ITS VALUE.

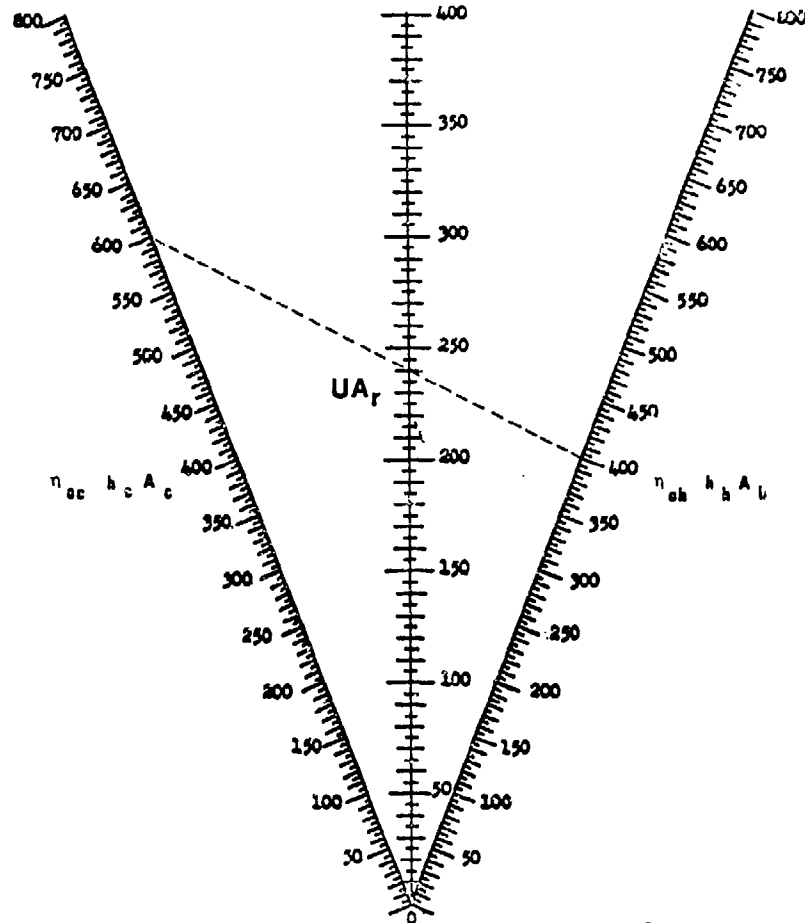

A_c = HEAT TRANSFER AREA OF THE COLD SIDE, ft^2
 A_h = HEAT TRANSFER AREA OF THE HOT SIDE, ft^2
 A_r = REFERENCE AREA FOR U , ft^2
 h_c = CONVECTION HEAT TRANSFER COEFFICIENT OF THE COLD SIDE, $Btu/hr-ft^2-^{\circ}F$
 h_h = CONVECTION HEAT TRANSFER COEFFICIENT OF THE HOT SIDE, $Btu/hr-ft^2-^{\circ}F$
 U = OVERALL CONDUCTANCE FOR HEAT TRANSFER, $Btu/hr-ft^2-^{\circ}F$
 η_{oc} = OVERALL COLD SIDE SURFACE EFFICIENCY, DIMENSIONLESS
 η_{oh} = OVERALL HOT SIDE SURFACE EFFICIENCY, DIMENSIONLESS
 NOTE: THIN WALLS AND CLEAN HEAT TRANSFER SURFACES

Figure 3-9. Nomograph of Thermal Resistance Eq. 3-14 (Ref. 5)

AMCP 708-361

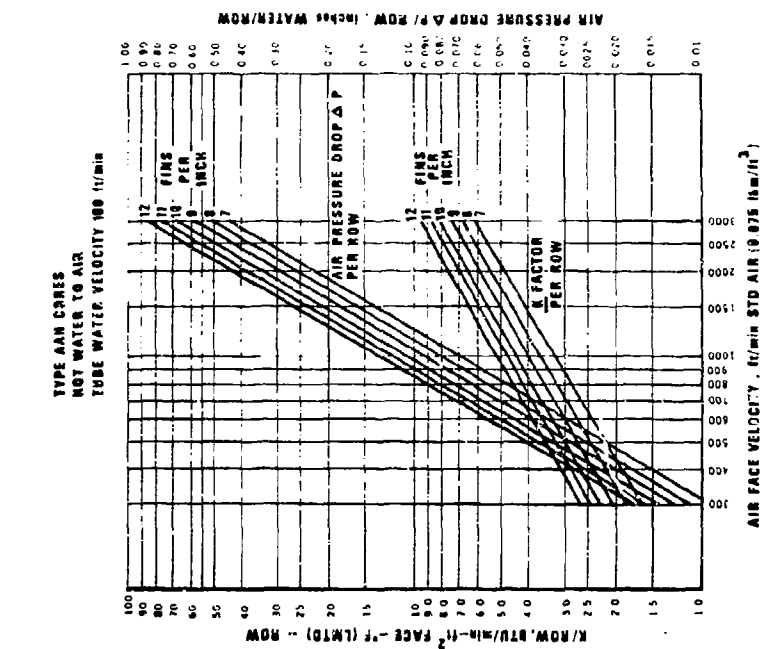

(A) RADIATOR HEAT TRANSFER AND FLOW CHARACTERISTICS
 (Courtesy of McCord Corporation)

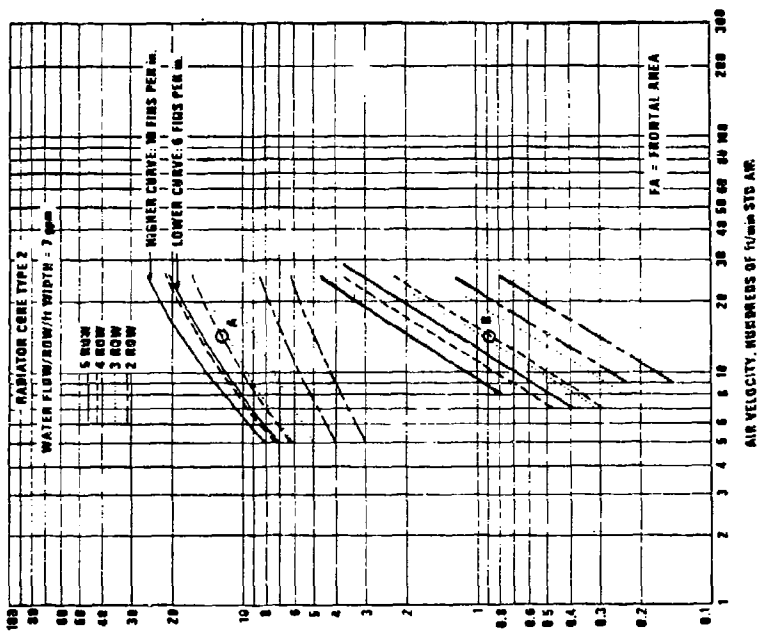

(B) RADIATOR HEAT TRANSFER AND FLOW CHARACTERISTICS
 (Courtesy of Young Radiator Company)

Figure 3-10. Radiator Heat Transfer and Flow Characteristics

when the ITD method is used

F_3 = correction factor for nonuniform air-flow distribution across the core face, dimensionless

T_a = inlet air temperature, °F

T_w = inlet or average water temperature, °F

The unit core selection method presented in Eq. 3-15 uses initial temperature difference *ITD* which is $(T_w - T_a)$. In addition to this, T_{wa} (difference between the average water temperature and inlet temperature) or *LMTD* as defined in par. 3-5 may be used. For the normal temperature range, the difference between *LMTD* and *ITD* (or average ΔT_{wa}) is small. *LMTD* is defined in Eq. 3-11 and a typical core performance chart is shown in Fig. 3-10(B). Additional core performance data are included in Appendix A.

Increasing the coolant flow velocity in a radiator increases the unit core heat transfer capability. However, the air side heat transfer is the predominate control. The rate of increase contributed by increased coolant flow velocity is diminished gradually as shown in Fig. 3-11. Moreover, coolant side pressure drop will increase significantly.

Too low a coolant velocity will decrease the overall radiator heat transfer capability and also will accelerate scale formation on the heat transfer surfaces, resulting in a further deterioration of the heat transfer performance. Generally, a coolant velocity of approximately 2 to 3 ft/sec in the radiator is recommended.

When the unit core heat transfer performance is based on temperature difference between inlet coolant and inlet air to the radiator, a correction should be made when the radiator is not 12 in. long in the direction of coolant flow. As the radiator tube length increases, the mean temperature differences between coolant and air decreases and the

unit heat transfer capability will decrease. Fig. 3-12 shows a typical correction factor F_2 as a function of tube length, unit core heat transfer capability, and coolant flow rate.

3.5.2 FLUID PRESSURE DROP IN HEAT EXCHANGERS

A heat exchanger generally consists of an inlet header, core, and exit header. If a multipass arrangement is used, turning pans or headers also are provided between passes. The total fluid pressure drop of the heat exchanger is the sum of the pressure drops across the following areas:

1. Entrance region
2. Core
3. Exit region.

For a multipass arrangement, the turning losses between passes must be considered. If variation of fluid density through the heat exchanger is significant, the change of fluid pressure due to a change in velocity must be considered. If the fluid is accelerated, a drop in pressure will occur. If the fluid is decelerated, the pressure will rise and counteract other losses.

In the automotive industry, the total fluid pressure drop for a heat exchanger is measured in a wind tunnel. The friction drop information is presented together with the heat transfer capability data as shown in Fig. 3-10. The fluid pressure drop can be determined quite accurately from these data.

For detailed design of a heat exchanger, fluid pressure drops through the manifolds, headers, core, turning pans, and the fluid pressure drops due to changes in fluid density and fluid flow areas are calculated separately. The summation of them is the total fluid pressure drop. The reader is referred to Refs. 2, 3 and 4.

AMCP 706-361

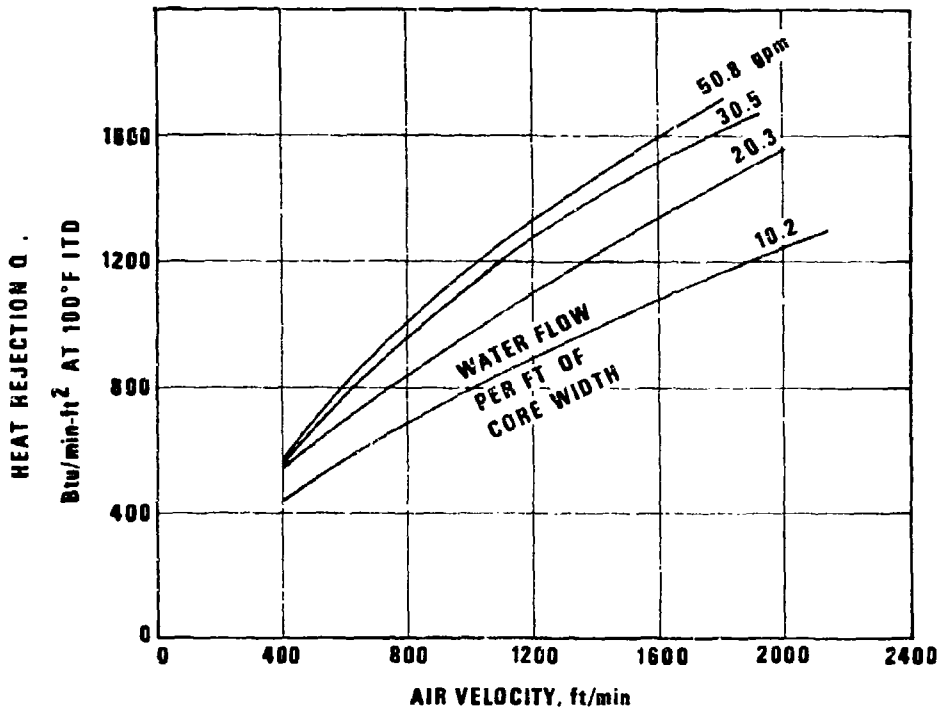

Figure 3-11. Typical Heat Rejection vs Coolant Flow for Plate-fin and Serpentine-fin Cores (Ref. 16)

(Courtesy of Society of Automotive Engineers, Inc., Paper No. 670525 and Madine Manufacturing Co.)

3-6 VEHICLE COOLING

The major source of heat that must be removed by the vehicle cooling system is from the engine. There are two general methods of removing heat from the engine: direct and indirect cooling.

In direct cooling the heat is transferred directly from the cylinder cooling fins to the air that is forced to flow between them.

Indirect cooling is achieved by an intermediary fluid that absorbs heat from the source and transfers it to the cooling air by a liquid-to-air heat exchanger (radiator and oil-to-air cooler).

3-6.1 DIRECT COOLING

The engine is designed specifically for the direct cooling method; namely, the engine cylinders, cylinder heads, and other components have fins and appropriate air passages to direct the cooling air through those fins. The fins may be an integral part of the cylinder body, or may be attached by an appropriate process. The material used for fins is usually aluminum or steel. Aluminum has about 4 times the thermal conductivity of steel and, therefore, has a much higher heat transfer capability. In direct cooling systems, the engine manufacturer designs the entire engine cooling system. Engines built for direct air-cooling include the engine cooling fan as

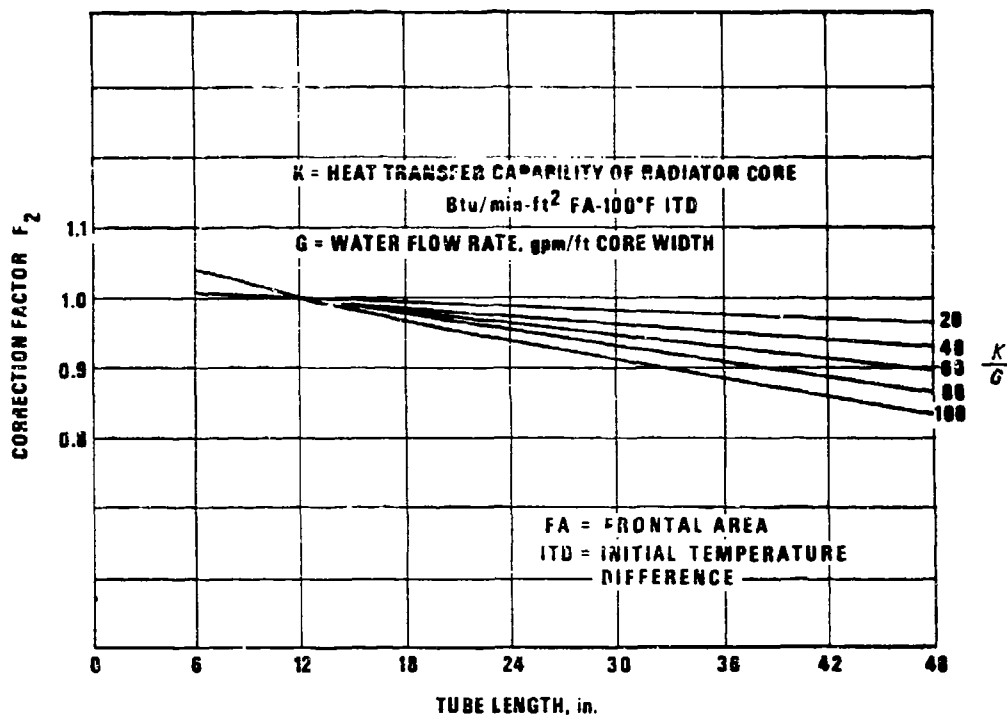

Values shown are for a 12 in. wide x 12 in. long basic core

Figure 3-12. Radiator Heat Transfer Correction Factor for Various Tube Lengths
 (Courtesy of McCord Corporation)

an integral part of the package. It is the responsibility of the vehicle engineer to assure the adequate openings for cooling air supply and discharge exits. Recirculation into the cooling air intake can cause local hot spots in the engine.

3-6.2 INDIRECT COOLING

All indirect cooling systems use a liquid to absorb heat at its source and dissipate it to the ambient air at another location. Liquids used for cooling fall into two categories: (1) those used solely for cooling, and (2) those serving a dual purpose such as oil which is used for reducing friction between parts as well as for cooling purposes. The former will be referred to as a coolant in this chapter. In

most installations a forced-air, liquid-to-air radiator is used to dissipate heat from the coolant to the atmosphere. In indirect cooling systems, oil is cooled in either a liquid-to-liquid or liquid-to-air heat exchanger termed an oil-cooler. In a liquid-to-liquid oil cooler the heat is transferred to the coolant and is dissipated to the atmosphere at the radiator. Radiators and oil coolers are the main heat transfer devices used in indirect cooling systems.

3-6.2.1 Radiators

Radiators are liquid-to-air heat exchangers consisting of a heat transfer core and related headers, tanks, fittings, and mounting provisions. The radiator also may provide for

AMCP 708-361

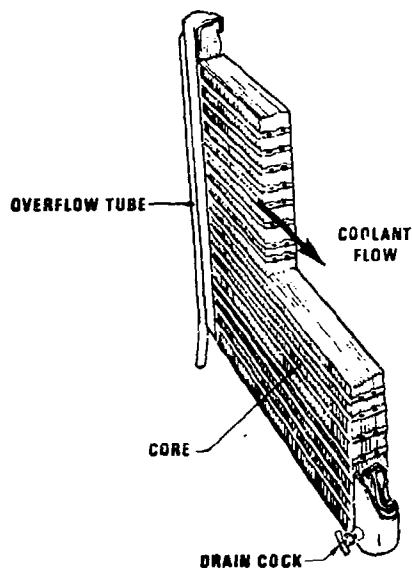
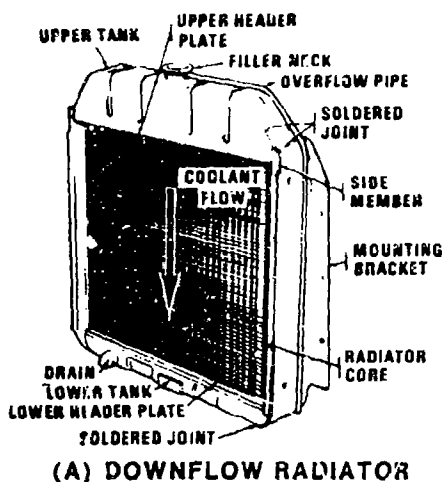

Figure 3-13. Downflow and Crossflow Radiators (Ref. 17)

filling, draining, overflow, air bleeding; and internal baffles may be installed for directing coolant flow or for deaeration.

The radiator also may include provisions for cooling oil or other fluid; mounting thermal sensing devices for fan or shutter

control; and for mounting air baffles or shrouds, shutters, screens, or other devices. Typical crossflow and downflow radiators are shown in Fig. 3-13.

There is no significant difference in heat transfer between the two different coolant flow directions. The crossflow coolant flow direction is popular in commercial vehicles because it can reduce the height of the engine compartment.

The engine is maintained at a permissible temperature level by circulating coolant through various parts of the engine and absorbing heat dissipated from them. The coolant then transfers the heat to the ambient air while flowing through the radiator.

The coolant circulates through the oil-cooler and radiator in systems using liquid-cooled oil coolers. In this arrangement, the radiator is also responsible for dissipating the heat from the oil to the ambient air.

In a situation where selecting a radiator core shape will result in the core being square or approaching a square, it is advantageous to select a square core. It will perform better than a rectangular one because it will more nearly fit the fan and the air distribution through the core will be more uniform. This does not hold true where a rectangular radiator uses two or more fans for the air movement through the core.

For a rectangular shape radiator, it is desirable to have the coolant flow through the smaller dimension because a higher liquid velocity in the core will usually result in a higher heat rejection rate. Fig. 3-11 illustrates the increase in heat rejection vs increased coolant flow for a typical radiator core.

The typical radiator core is made of tubes soldered through thin sheets of metal at the ends. These sheets are called header plates. The header plates form mounting pads for the entrance and exit tanks, and prevent passage

of coolant from the tanks to the core except through the tubes.

Most radiator tanks are cast or stamped in one piece to reduce the possibility of leaks. A baffle plate in the upper tank, below the filler neck, eliminates excessive splashing and distributes the coolant uniformly over the tank.

Round and flattened tubes are used in the radiator cores. Flattened tubes are preferable because they provide a greater air flow passage area per unit of inlet face area. They also have lower eddy losses, and the air side pressure drop may be lower.

Fig. 3-14 illustrates a typical radiator core. Ref. 9 is the Military Standard Specification for engine cooling and radiators.

3-6.2.1.1 Design Parameters for Military Equipment

The convection heat transfer coefficient on the coolant side of the tubes is substantially greater than on the air side, so it is necessary to provide a large heat transfer surface area on the air side. This large area is achieved by attaching fins on the outer surface of the tubes. The two types of tube and fin construction most commonly used are the plate-fin and serpentine-fin cores.

The serpentine-fin core is constructed by soldering a roll formed spacer ribbon between the core tubes (see Fig. 3-15(C)). The plate-fin type core is constructed by inserting the tubes through a row of fins which have openings punched in them (see Fig. 3-15(B)). In commercial applications such as passenger cars and light trucks, the serpentine-fin core is used almost exclusively. In high volume production, it is more economical and has less core weight per unit of cooling as compared with the plate-fin core. As shown in Fig. 3-15(C), the serpentine-fin core assembly is held together by only the bond between the fins and tubes. The plate-fin core has more

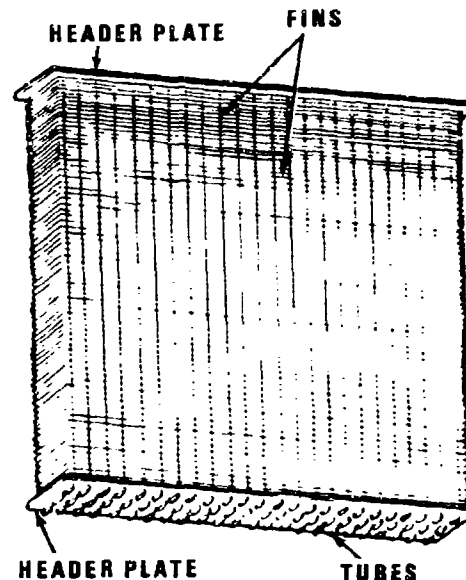

Figure 3-14. Typical Radiator Core (Flattened Tubes) (Ref. 17)

structural strength and is favored for severe duty applications such as found in the off-highway military environment with the attendant vibration and high shock loadings.

Either the serpentine or plate-fin core can be designed in various forms such as flat plate, wavy, dimpled, perforated, or louvered fins, or combinations of these forms. The tube and fin can be made of different materials. The tube material generally is selected for stress considerations, and the fin material is selected for heat transfer considerations.

Airflow usually makes one pass across the radiator while the liquid flow may be a single pass or a multipass arrangement. Fig. 3-16 shows a two-pass (coolant side) radiator flow. The coolant flows from the back side to the front side of the radiator.

Fig. 3-17 shows another type of two-pass radiator with coolant flow moving from the top half of the radiator to the lower half.

AMCP 706-361

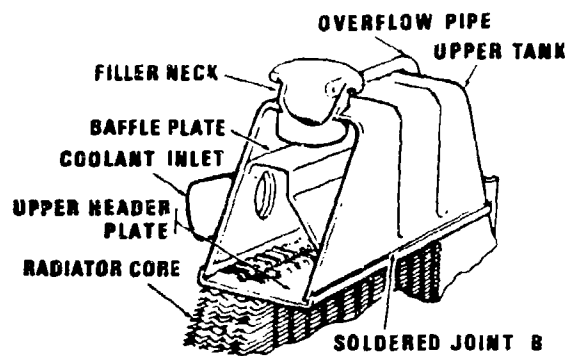

(A) PLATE-FIN CORE HEADER (Ref. 17)

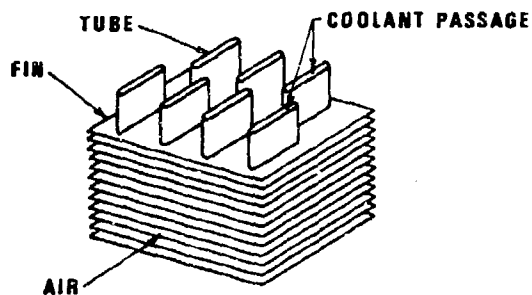

(B) PLATE-FIN CORE (Ref. 20)

(Courtesy of Society of Automotive Engineers, Inc., SAE Handbook, 1974)

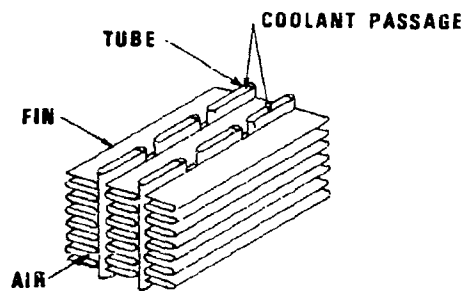

(C) SERPENTINE-FIN CORE (Ref. 20)

(Courtesy of Society of Automotive Engineers, Inc., SAE Handbook, 1974)

Figure 3-15. Plate-fin and Serpentine-fin Core Construction

(Reprinted with permission, copyright ©, Society of Automotive Engineers, Inc., 1974, all rights reserved)

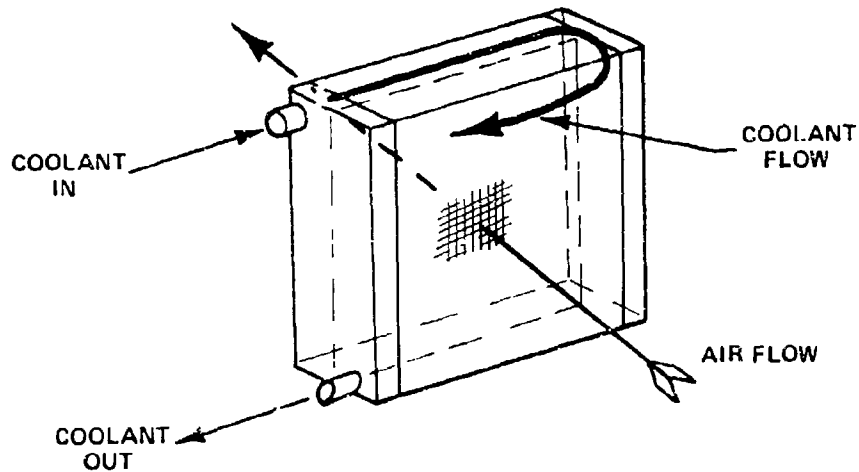

Figure 3-16. Two-pass Radiator (Coolant Side-Back to Front)

When a two-pass (coolant side) radiator is used, it is recommended that the coolant inlet connection be located on the top tank (downflow arrangement). This will provide an effective deaeration condition. It is common practice that no more than two passes (coolant side) are used for vehicle radiators.

3-6.2.1.2 Component Installation Considerations

The location of the radiator in relation to

the coolant pump should be considered in the cooling system design. Typical installation arrangements include the radiator located on either the pressure or suction side of the coolant pump. Where remote mounting of radiators is necessary, adequate controls or warning devices should be provided to ensure that fan(s) are operating when the engine is running.

Most vehicle liquid coolant systems use a centrifugal pump. The pump location often is

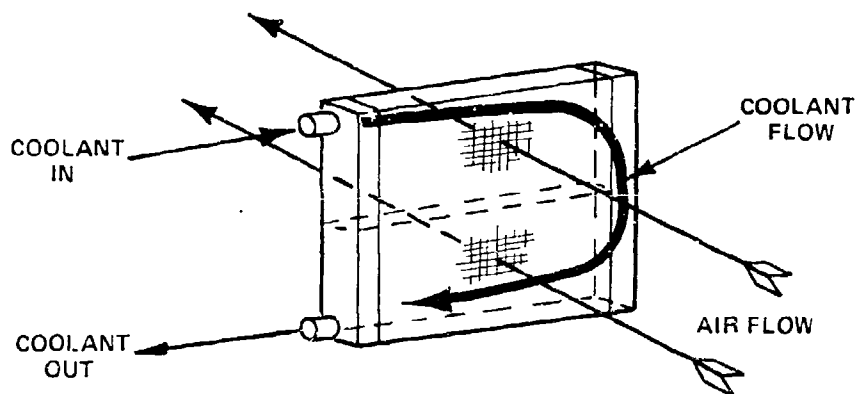

Figure 3-17. Two-pass Radiator (Coolant Side-Top to Bottom)

AMCP 706381

fixed since it is an integral part of the engine assembly. The considerations for coolant pump operation are:

1. The pump must be primed at all times. This requirement would preclude mounting the radiator below the coolant pump unless a priming means were supplied.

2. The centrifugal coolant pump is sensitive to inlet restrictions, therefore, discharge flow can be reduced by poor design of coolant plumbing. High inlet restrictions cause cavitation which, in addition to reducing flow, can cause pump damage. Cavitation may occur if the suction at the pump inlet exceeds approximately 5 psi.

3-6.2.1.3 Radiator Core Design Variables

The critical criterion of radiator design is to transfer heat to the cooling air at a rate that will maintain safe operating engine coolant temperatures. This is accomplished by heat transfer through forced convection, conduction, and a small amount due to radiation. An adequately designed radiator must have minimum size and weight, and acceptable flow resistances on both sides. Ruggedness, resistance to distortions under severe shock loads and vibration, and minimum susceptibility to clogging of the core are of prime importance for radiators intended for use in military vehicles.

3-6.2.1.3.1 Design Variables of Radiator Core

The tube wall thickness of most radiators is approximately 0.005 in., thus $\delta_w/(k_w A_w)$ in Eq. 3-14, as discussed in par. 3-5.1.1.2.1, is usually small and may be neglected.

There are generally no fins on the liquid side of the radiator, therefore, if all heat transfer surfaces are free of scale, the heat rejection rate Q is

$$Q = \frac{\Delta T_{ca}}{\frac{1}{h_{co} A_{f,co}} + \frac{1}{h_a \eta_o A_{f,a}}}, \text{ Btu/hr} \quad (3-16)$$

where

$A_{f,a}$ = total heat transfer area (air side), ft²

$A_{f,co}$ = total heat transfer area (coolant side), ft²

h_a = convection heat transfer coefficient (air side), Btu/hr-ft²-°F

ΔT_{ca} = average temperature differential coolant to air, deg F

h_{co} = convection heat transfer coefficient (coolant side), Btu/hr-ft²-°F

η_o = overall surface efficiency (air side), dimensionless

3-6.2.1.3.2 Heat Transfer Capability

The mean temperature difference between the two fluids is a function of the inlet and exit temperature of both sides. If the inlet temperatures of both sides are fixed, increasing the length of the flow path of either or both sides will lower the exit temperatures and, in turn, decrease the mean temperature between the two fluids.

In both turbulent and laminar flow regions, high coolant flow rates, small flow passages, and interrupted fins or turbulators can generate a large convection heat transfer coefficient on the coolant side. For a specific total coolant flow rate, the coolant side convection heat transfer coefficient can be increased by increasing the coolant flow rate per tube, by decreasing the number of coolant

tubes, or by using a multipass arrangement. Because of higher coolant pressure drop and deaeration problems, radiators with more than two passes generally are not recommended.

Coolant side heat transfer area can be increased by:

1. Increasing the number of coolant tube rows. This will increase the radiator thickness and increase the air side pressure drop. As cooling air passes through each succeeding radiator core row its temperature rises, and the temperature differential between the cooling air and the coolant decreases with a subsequent decrease in heat transfer per row. Extreme care must be exercised in selecting radiators with a large number of tube rows. The average heat transfer capability per additional row of tubes may be too low to justify the weight and airflow pressure drop penalties that additional rows impose.

2. Increase the number of tubes per row.

3. Increase the length of the tubes.

Items 2 and 3 also can increase radiator frontal areas. This will decrease the air side pressure drop. The frontal area should be made in a configuration that allows the airflow to be uniformly distributed over the entire area.

3-6.2.1.3.3 Air Side Efficiency

The air side fin efficiency can be increased by:

1. Decreasing the distance between tubes
2. Increasing the thickness of the fins
3. Using fins made of material with higher thermal conductivity.

For a radiator of fixed face area, decreasing the tube distances or increasing the fin

thickness also will increase the air side pressure drop.

An increase of the convection heat transfer coefficient on the air side can be accomplished by:

1. Increasing airflow rate per unit face area. This can be done by using a higher performance fan or by decreasing the radiator effective face area. However, as shown in Fig. 3-10 the air resistance rises rapidly with increased airflow. Airflow velocities above 2000 ft/min become quite wasteful in fan horsepower and also can create an unacceptable noise level.

2. Using interrupted types of fins such as rippled, offset, dimpled or louvered. Military vehicles are expected to operate in any terrain and environment. Offset or louvered fins are vulnerable to plugging with debris. If this happens, the air side heat transfer performance will deteriorate significantly. Therefore, it is recommended that offset or louvered fins not be used for combat vehicles.

The air side heat transfer area can be increased by increasing:

1. Radiator frontal area which will decrease the air side pressure drop
2. Radiator core thickness which will increase the air pressure drop
3. The number of air side fins per inch.

Items 1 and 2 may increase the number of tubes used in the radiator core.

Increasing the number of fins per inch is an effective method of increasing the heat rejection rate if used carefully. Fig. 3-18 shows cooling vs weight for four typical radiator cores that are identical except for core thickness or depth. It can be seen that a 3-row core with 12 fins per in. has the same heat rejection capability as a 5-row core with

AMCP 706-3G1

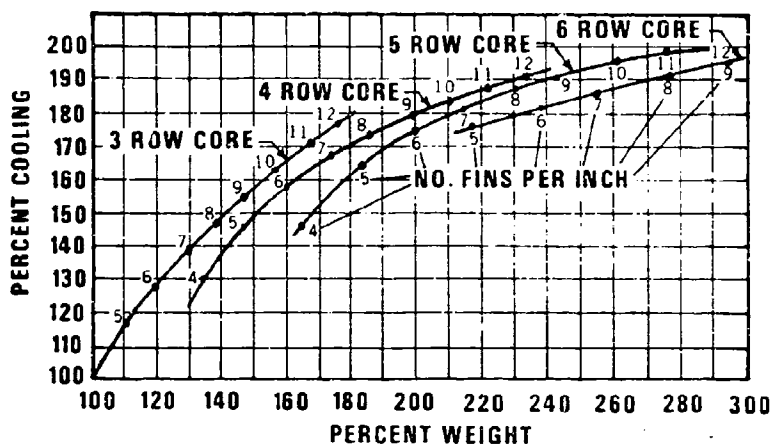

Figure 3-18. Radiator Core-cooling vs Weight (Ref. 16)

(Courtesy of Society of Automotive Engineers, Inc., Paper No. 670525 and Modine Manufacturing Company)

6 fins per in. This capacity is achieved at a substantial savings in weight and material. This approach is limited in practice, however, by the increase in cooling air resistance and vulnerability to clogging by debris resulting from closely spaced fins. It is, therefore, necessary to limit the number of fins per inch to suit the particular design application of the core. In heavy construction equipment, adequate radiators can be designed with fin spacing of 5 to 7 fins per in. The highly compact radiator designs necessary in combat vehicles require compromises that generally do not permit such wide fin spacing. A closer spacing usually is used with the consequent higher susceptibility to core clogging which must be accepted as a penalty in return for face area reductions. Generally, it is not desirable to use fin spacings of more than 14 fins per in. in a military vehicle application.

Air side heat transfer is the controlling factor of radiator cooling capability, therefore, a careful study of the air side heat transfer and the air resistance inter-relationship should be made.

3-6.2.1.3.4 Deaeration

In many cooling systems, it is necessary to

incorporate provisions for coolant deaeration. Deaeration provisions minimize splash and consequent air entrainment, and facilitate the separation of air, steam vapor, and combustion gases from the coolant. Undesirable conditions may arise if these gases are not allowed to escape, namely:

1. Decrease in the heat rejection capability of the radiator:
 - a. The coolant flow rate decreases if severe entrainment of gases occurs. This causes cavitation at the coolant pump and possible damage.
 - b. The convection heat transfer coefficient between a liquid coolant and a gas mixture and heat transfer surface is less than that between the liquid coolant and heat transfer surface.
2. Air, steam, or combustion gases trapped in the coolant may collect in the engine coolant jacket, resulting in a local hot spot.

Deaeration provisions may range from none at all, where the entrainment of gases is insufficient to cause harm, to quite elaborate systems.

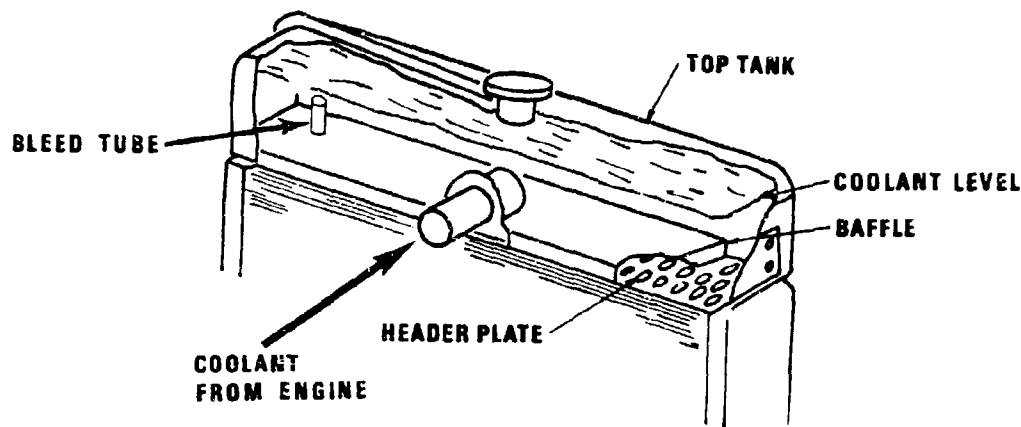
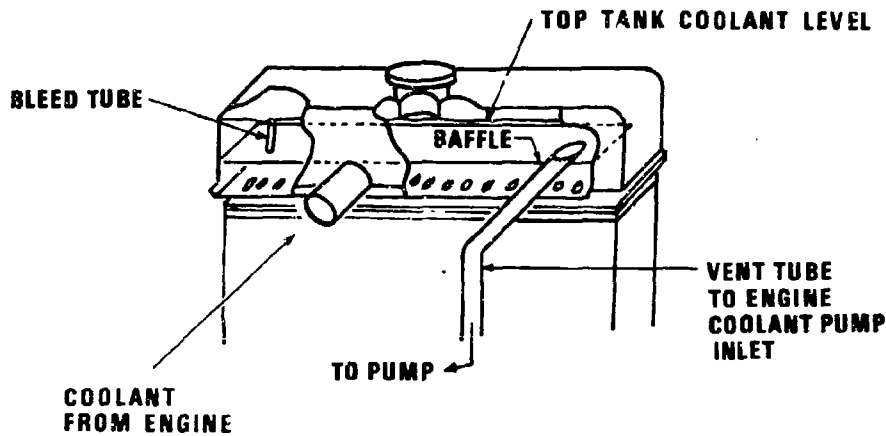

*Figure 3-19. Radiator Deaeration System With Partial Baffle (Ref. 16)
 (Courtesy of Society of Automotive Engineers, Inc., Paper No. 670525 and Modine Manufacturing Company)*

A deaeration system may be incorporated in the radiator as shown in Fig. 3-19. A portion of the coolant flows through the bleed tube into the calm area above the baffle where the gases separate, and the coolant returns to the coolant pump through the core tubes. Fig. 3-20 shows a variation of this system where the baffle extends the length of the header and the return to the system is through a vent tube to the coolant pump inlet. The cooling system may utilize a surge

tank that contains the coolant reserve as the calm area where the gases separate. Par. 5-4.2 discusses the surge tank in detail.

There are many variations of deaeration systems. The design of each depends on the type of engine, the location of the components, and the severity of the problem of entrained gases. Deaeration systems often are developed from actual tests as described in Appendix D-6.



*Figure 3-20. Radiator Deaeration System With Full Baffle (Ref. 16)
 (Courtesy of Society of Automotive Engineers, Inc., Paper No. 670525 and Modine Manufacturing Company)*

AMCP 706-361

3-6.2.1.4 Coolant Reserve

It is necessary to provide an excess supply of coolant in the system. This is done to permit loss of a quantity of coolant and still allow the system to function at full efficiency. The excess supply is generally 15 to 20 percent of the system capacity and is designated the "coolant reserve".

The most common location of the coolant reserve is the radiator. The capacity of the top tank for a downflow radiator and the outlet tank for a crossflow radiator is increased for this purpose. If space limitations do not allow the enlargement of the radiator tank, the coolant reserve may be located in the "surge tank" as described in par. 5-4.2.

3-6.2.1.5 Radiator Selection

The radiator core and size must take into consideration several engine and environmental parameters. A discussion of these parameters and sample calculations follow:

1. *Engine heat rejection characteristics.* The rate of heat rejection per horsepower $\{(\text{Btu}/\text{min})/\text{hp}\}$ usually is obtainable from the engine manufacturer or by actual tests at installed conditions. (Ref. Chapter 2). If the radiator also is used for a heat sink for a liquid-cooled oil cooler, the heat rejection rate for the oil cooler also must be known.

2. *Coolant flow rate.* It is usual practice to incorporate the coolant pump as an integral part of the engine. The flow characteristics of the pump are available from the manufacturer. Thus, the coolant flow rate is a known parameter; however, cooling consideration may require a check of this parameter and the possible selection of a different pump or pump operating speed.

3. *Maximum allowable coolant operating temperature.* The maximum allowable temperature of the coolant at the exit from the engine or inlet to the radiator normally is

specified by the engine manufacturer and is directly related to the operating pressure of the system which generally is controlled by the pressure cap of the radiator. The radiator must have sufficient cooling capacity to maintain a prescribed coolant exit temperature under any operating conditions.

4. *Ambient air temperature.* Military usage requires that the vehicle must be capable of operating in environments with air temperatures to 125°F unless otherwise specified. It must be noted that the air entering the radiator generally is above ambient temperature because of cooling air recirculation and air temperature rise as it flows past various components before reaching the radiator core.

5. *Approximate location and size of the radiator.* In most cases, the vehicle design dictates the location and space available for the radiator. In these cases, it is necessary to make sure that the selection of a suitable radiator is possible, or that appropriate recommendations for changes in vehicle or cooling system component designs can be made.

6. *Airflow rate.* With a higher airflow rate, more heat can be rejected from the same radiator. However, a higher airflow rate also increases the air pressure drop through the radiator and increases the power required by the fan.

Normally a radiator core is not designed by the vehicle designer but is selected from available industrial products. It is necessary to obtain the performance characteristics of these radiator cores from manufacturers or alternatively, to use Military Standard Specifications to define the required performance of the radiator (Ref. 9). Typical manufacturers' radiator core performance curves are included in Appendix A.

Tables 3-1 through 3-4 are included to indicate the size, use, coolant temperature limits, and pressure cap application for

AMCP 706-361

TABLE 3-1
 RADIATOR SIZE vs VEHICLE APPLICATION (USATACOM)

RADIATOR PART NO.	APPLICATION	HEIGHT, in.	WIDTH, in.	THICKNESS, in.	FRONT AREA, ft ²	VOLUME, ft ³	SPEC HP PER ft ² CORE	SPEC HP PER ft ³ CORE
WHEELED VEHICLES								
11657726	M715, M724, M725 Truck 1-1/2 Ton	16.3	24.66	1.95	2.8	0.45	47	292
10876110	2-1/2 ton trk	21.13	22.38	2.63	3.28	0.72	39.2	179
8720584	2-1/2 ton trk	20.81	25.72	3	3.72	0.93	34.5	138
11640319	5 ton trk	27.77	23.75	2.87	4.58	1.1	45	187
8712197	5 ton trk	28.25	23.75	2.33	4.66	0.91	38.6	199
8737820	5 ton trk	27.56	23.82	2.63	4.56	1.0	39.5	180
7375656	M39, 5 ton Truck Series	28.12	23.98	3.0	4.68	1.17	44.9	193
10945095	10 ton trk	38.63	25.29	2.96	6.78	1.67	44.2	180
8332894	10 ton trk	38.39	25.25	3.38	6.7	1.88	44.8	160
10921827	M151	13.62	19.20	2.5	1.82	0.38	39	187
11601346	M561	16.97	28.30	2.7	3.34	0.75	31	137
11601425	M656	28.23	25.78	2.87	5.05	1.21	40	165
11651136	M559, M553, M520	40.72	35.0	4.56	9.9	3.76	21.5	57
AVERAGE							39.9	167.7
TRACKED VEHICLES								
11635585	M109	18	44.12	6.94	5.5	3.19	70.7	122
10941682	M108/109	18	44.22	6.94	5.53	3.17	70.5	123
10917144	M113	24.59	24.38	4.56	4.16	1.58	51.7	136
10900400	M107/110	31.50	22.50	5	4.92	2.05	79.3	190
10941665	M114A1	20.38	27.92	3.97	3.95	1.31	35	197
11589539	M548	26.72	24.38	5.12	4.52	1.93	46.5	109
10913175	XM474E2	13.5	36.0	6.94	3.38	1.95	56.6	98
10946896	M551	27.13	36.0	3.75	6.78	2.1	44.2	143
8328490	XM501E2	16.5	16.5	3.0	1.89	0.47	37.6	150
11589528	M113A1, M577A1, M106A1	24.72	24.38	4.63	4.19	1.61	50.1	135
11662993 and 11662994	M113A1, M106A1, M125A1, M132A1, M577A1, XM741, XM733, M116A1, M116	24.84	24.50	5.56	4.23	1.96	49.6	107
7748708		24	20.28	4.88	3.38	1.37	41.4	102
AVERAGE							52.8	126.8

AMCP 706-361

TABLE 3-2

RADIATOR USE vs VEHICLES AND ENGINES (USATACOM)

	RADIATOR PART NO.	VEH APPLICATION	VEH SPEC	ENG SPEC	ENG MAKE & MODEL	ENG SPEC HP	ACTUAL PROD HP
WHEELED	VEHICLES						
	10876110	2-1/2 Ton Trk	MIL-T-46780C	MIL-E-46778	LDS-427-2	126-131	140-145
	8720584	2-1/2 Ton Trk	MIL-T-46780C	MIL-E-62106	LD-465-11-1C	126-131	126-140
	11640319	5 Ton Trk	MIL-T-740F	DAPD 283, TY1	Mack Endt-673	205	225
	8712197	5 Ton Trk	MIL-T-740F	DAPD-292F	LDS-465-1	175-185	175-190
	8737820	5 Ton Trk	MIL-T-740F	DAPD-292F	LDS-465-1A	175-185	175-190
	10946095	10 Ton Trk	MIL-T-62012A	MIL-E-52396	V8-300 Cummings	300	285-300
	8332894	10 Ton Trk	MIL-T-62012A	MIL-E-52396	TH844 LeRoj	300	285-300
	10921887	M151	MIL-T-45331D	MIL-E-45332	MIL 4cyl-S.I.	71	66
	11601346	M561	MIL-T-62047B	MIL-E-62045	GM 3-53		
					C.I. 3 cyl	103	101
	11601425	M656	Characteristic	ATPD 2024	LDS-465-2	195-205	195-215
	7375656	M39, 5 Ton Truck Series	MIL-T-740	MIL-E-46798	CONT. R6602	225	205
	TRACKED	VEHICLES					
11635585		M109	MIL-H-45374B	MIL-E-46796	DAPD 292B DAPD 283TY1	LDS-465-1 EMDT 673	210 205
10941682		M108/109	MIL-H-45374B	MIL-E-46796	GM 8V-71T	390	285-300
10917144		M113	MIL-C-45355B	MIL-E-45358	75M Chry Gas	390	285-300
10900400		M107/110	MIL-C-45397C	MIL-E-46796	GM 8V-71T	215	215
10941665		M114A1	MIL-C-46753A	MIL-E-46716	8 cyl Chev 283 Gas	390	360
11657726		M715, M724, M725 Truck 1-1/2 Ton	DAPD 1249	None	Willys Jeep OHC G-230	140	150
10946896		M551	MIL-A-4559B(AT)	MIL-E-52395	Det. Diesel 6V53T	132.5	---
8328490		XM501E2	MIL-L-45777	MIL-E-45332	Willys MD	300	282
11589539		M548	MIL-C-62013	DAPD 2966	Det. Diesel 6V53	71	66
10913175		XM474E2	DAPD 280	MIL-E-45358	Chrysler 75M	210	202
11589528	M113A1, M577A1 M106A1	MIL-C-46782 MIL-C-46783		Det Diesel 6V53	210	202	
11662993 and 11662994	M113A1, M106A1, M125A1, M132A1, M77A1, XM741	MIL-C-46785 MIL-C-46782 MIL-C-46785 MIL-C-46784 MIL-F-45545 MIL-C-46783	DAPD-296B				
7748708	XM733, M116A1, M116	MIL-C-46364	MIL-E-46716	Det Diesel 6V53 CHEV 283-V8	210	202	

various military vehicles.

Engine manufacturers may state required engine cooling levels in terms of air-to-boil. Air-to-boil (ATB) is defined as the ambient temperature at which the radiator top tank temperature will be at the boiling point of the coolant. For water in an atmospheric cooling system where the boiling point of water is 212°F at one atmosphere pressure

ATB = 212 -- (Radiator top tank temperature)

+ (ambient temperature), °F (3-17)

Maximum allowable top tank (engine outlet) temperatures often are specified by engine manufacturers in addition to the engine coolant flow rate.

When the cooling system designer has

TABLE 3-3
COOLING TEMPERATURE LIMITS FOR VARIOUS VEHICLES (USATACOM)

PART NO.	VEHICLE APPLICATION	MAX COOLANT		MAX OIL SUMP		MAX OIL SUMP		MAX TRANSMISSION OIL SUMP TEMP, °F
		TEMP BY ENG SPEC, °F	TEMP BY VEH SPEC, °F	TEMP BY ENG SPEC, °F	TEMP BY VEH SPEC, °F	TEMP BY ENG SPEC, °F	TEMP BY VEH SPEC, °F	
WHEELED VEHICLES								
10876110	2-1/2 Ton Trk	210	220	260				NONE
8720584	2-1/2 Ton Trk	210	220	260				NONE
11640319	5 Ton Trk	210	220	260				NONE
8712197	5 Ton Trk	210	220	265				NONE
8737820	5 Ton Trk	210	220	265				NONE
10946095	10 Ton Trk	210	210	250				NONE
8332894	10 Ton Trk	210	210	250				NONE
10921887	M151	210	212	250				NONE
11601346	M561	230	230	275				300
11601425	M656	210	210	265				300
11651136	M559, M553, M520	230	230	250				275
11657726	M715, M724, M725	230	230	250				275
7375656	Truck, 1-1/4 Ton Series	NONE	210	NONE				NONE
	M39, 5 Ton Truck	210	220	250				NONE
		220	220	260				NONE
		210	220	260				NONE
TRACKED VEHICLES								
10946896	M551	210	230	275				325
8328490	XM501E2	210	NONE	250				NONE
11589539	M548	230	230	275				300
10913175	XM474E2	230	230	250				300
11589528	M113A1, M577A1, M106A1	230	230	275				300
11662993	M113A1, M106A1, and M125A1, M132A1,	230	230	174				300
11662994	M577A1, XM741, 7748708	230	230	300				285
	XM733, M116A1, M116	230	230	275				300
11635585	M109	230	230	275				300
10941682	M108/109	230	230	275				300
10917144	M113	210	230	250				300
10900400	M107/110	230	230	275				300
10947665	M114A1	230	230	300				200

AMCP 706-381

TABLE 3-4

RADIATOR vs PRESSURE CAP USE

	<u>RADIATOR PART NO.</u>	<u>VEHICLE APPLICATION</u>	<u>PRESSURE CAP NO.</u>	<u>PRESSURE CAP CAPACITY, psi</u>	<u>PRESSURE CAP VENT VACUUM, psi</u>	
WHEELED VEHICLES	10876110	2-1/2 ton trk	MS-35840-1	6-1/2 to 8	0 to 1/4	
	8720584	2-1/2 ton trk	MS-35840-1	6-1/2 to 8	0 to 1/4	
	11640319	5 ton trk	MS-35840-1	6-1/2 to 8	0 to 1/4	
	8712197	5 ton trk	10900503	3-1/2 to 4-1/2	0 to 1/4	
	8737820	5 ton trk	MS-35840-1	6-1/2 to 8	0 to 1/4	
	10946095	10 ton trk	7066075	3-1/2 to 4-1/2	0 to 1/4	
	8332894	10 ton trk	7066075	3-1/2 to 4-1/2	0 to 1/4	
	10921887	M151	MS-35840-1	6-1/2 to 8	0 to 1/4	
	11601346	M561	MS-35840-1	6-1/2 to 8	0 to 1/4	
	11601425	M656	MS-35840-1	6-1/2 to 8	0 to 1/4	
	11651136	M559, M553, M520	11589341	13 - 18	0-0.6	
	11657726	M715 M724 M725	10946982	14 - 17	None	
	7375656	Truck, 1-1/4 Ton M39, 5 ton truck	7411061	3 1/4 - 4 1/4	0-1/4	
			10900503	3 1/2 - 4 1/2		
	TRACKED VEHICLES	11635585	M109	10882098	13±2	Pressure Release
		10941682	M108/109	10882098	13±2	
10917144		M113	10866042	14 to 17	0 to 0.6	
10900400		M107/110	10866042	14 to 17	0 to 0.6	
10941665		M114A1	10925255	19 to 23	-----	
11589539		M548	11589341	13 - 18	0-0.6	
10913175		XM474E2	10866042	14 - 17	0-0.6	
10946896		M551	10946982	14 - 17	None	
6328490		XM501E2	9097926	Not Specified		
11589528		M113A1, M577A1			Not Specified	
		M106A1	11589341	13 - 18		
11662993		M113A1, M106A1, and M125A1, M132A1,			0 - 0.6	
11662994		M577A1, XM741	11589341	13 - 18		
7748708	XM733, M116A1, M116	10866042	14 - 17	0 - 0.6		

determined the required heat rejection rate and the physical limitations on the core size, the radiator supplier can then provide a family of curves similar to those shown in Fig. 3-10 and those included in Appendix A. The heat dissipation K often is stated in Btu/min-ft²-°F of frontal area and entering temperature difference (e.g., the entering coolant temperature minus the entering air temperature). This also may be stated in Btu/min-ft²-°F ΔT_{aw} where ΔT_{aw} is the average water temperature minus the entrance air temperature or as Btu/min-ft² face area-°F ($LMTD$)-tube row.

Example 1:

Consider a radiator core with the following conditions:

Heat rejection $Q = 7500$ Btu/min

Coolant flow rate $G = 90$ gpm (water)

Air inlet temperature to radiator = 125°F

Maximum top tank temperature $T = 210$ °F

Core frontal area $A_{fr} = 7.5$ ft²

Assume an atmospheric cooling system

Determine:

1. Design ATB
2. Coolant temperature drop ΔT across the radiator core
3. Unit core heat transfer capability K using Fig. 3-10(A)
4. Required airflow, CFM
5. Airflow ΔP through the core.

Solution:

1. To determine the design ATB tempera-

ture for 125°F ambient air for an engine with a maximum top tank temperature of 210°F, using water as the coolant in an atmospheric cooling system, by Eq. 3-17

$$ATB = 212 - 210 + 125 = 127^\circ \text{ F}$$

2. To determine the coolant temperature drop ΔT_{co} across the radiator core if water is used for the coolant

$$\Delta T_{co} = \frac{Q}{0.1337 \text{ GPM } \rho C_p}, \text{ deg F} \quad (3-18)$$

where

C_p = specific heat at the fluid temperature, Btu/lbm-°F

GPM = coolant flow, gal/min

Q = heat rejection, Btu/min

ρ = density, lbm/ft³

0.1337 = conversion factor from gal to ft³

If ethylene glycol-water mixtures are used, refer to Fig. 3-46 or Table 3-6 for the thermo physical properties.

With a heat rejection rate Q of 7500 Btu/min and a coolant flow rate G of 90 gpm, using average water temperature at 210°F ($\rho = 60$, $C_p = 1$) as a first approximation

From Eq. 3-18 and Fig. 3-43

$$\Delta T_{co} = \frac{7500}{0.1337 \times 90 \times 60 \times 1} = 10.4 \text{ deg F}$$

The next step is to calculate the average water temperature. The thermal properties of water are then determined from this calculated average temperature. A new ΔT_{co} and a new average water temperature are then computed. The process is repeated until the assumed average water and calculated water

AMCP 708-361

temperature are identical or within the desired degree of accuracy.

3. The *ITD* used with the radiator suppliers curves (Fig. 3-10(A)) would be 210°F minus 125°F , i.e., 85 deg F. To determine unit core heat transfer capability K , from the radiator performance curves, the radiator core size is needed. With the core frontal area A_{fr} of 7.5 ft², the required unit core heat transfer capability K for 7500 Btu/min engine heat rejection by definition is

$$K = \frac{Q}{A_{fr} \Delta T_{ITD}}, \text{ Btu/min-ft}^2\text{-}^{\circ}\text{F} \quad (3-19)$$

$$K = \frac{7500}{7.5 (85)} = 11.8 \text{ Btu/min-ft}^2\text{-}^{\circ}\text{F}$$

4. From Fig. 3-10(A) the air velocity when $K = 11.8$ and the selected core of 6 fins/in. with 4 tube rows is found to be 1400 sfpm (Point A, Fig. 3-10(A)). The airflow required is $1400 \times 7.5 = 10,500$ scfm.

5. Airflow ΔP through the core is 0.88 in. of water (Point B, Fig. 3-10(A), under standard conditions). Core heat rejection variation due to coolant flow rates, other than the core design flow rate, also is supplied by the radiator supplier (Fig. A-63). This usually is given in percent of heat rejection vs gpm/row- 12 in. width and can be applied as shown in Eq 3-15.

Example 2:

Consider a radiator core with the following conditions

Total heat rejection = $13,000$ Btu/min

Entrance air temperature = 130°F

Coolant flow rate = 100 gpm (water is used)

Maximum inlet water temperature = 232°F

Determine the optimum radiator face area, core thickness or depth, and number of fins per inch.

Solution:

Many different configurations of radiators could be used to satisfy the stated performance characteristics, so it becomes the cooling system designer's task to evaluate several different configurations. This is accomplished by a trade-off study among core thickness or depth, face area, fins per inch, pressure drop, and airflow requirements. The data from radiator performance curves similar to those shown in Fig. 3-10 may be used to plot trade-off charts as shown in Figs. 3-21 and 3-22. These charts specifically apply to the stated design parameters of heat rejection, coolant flow and temperature, and air temperature. These charts also may be obtained from the radiator supplier. Analysis of the charts permits evaluation of the different radiator core designs in terms of the cooling system design limitations or specifications. The final selection will be governed by these constraints. Inspection of the charts (Figs. 3-21 and 3-22) readily discloses the individual performance characteristics of the various core designs, i.e., large core face area minimizes ΔP across the core and requires minimum airflow. Increasing core thickness or depth reduces airflow requirements with an increase in ΔP . Increasing the number of fins rapidly increases ΔP . The optimum core design normally is the one with the minimum size, airflow, ΔP across the core, and will fit into the space available in the vehicle.

3-6.3 ENGINE OIL COOLERS

The engine lubricating oil is used to some extent as a coolant. The oil is used to cool the pistons, cylinder walls, bearings, etc. In order to prevent excessive oil temperatures (Military Specifications define the maximum oil temperature as 250°F in most cases), it often is necessary to provide a separate oil cooler. An

RADIATOR CALCULATION ALUMINUM BAR-PLATE
100 gpm WATER AT 232°F
AIR AT 130°F
12,000 Btu/min HEAT REJECTION

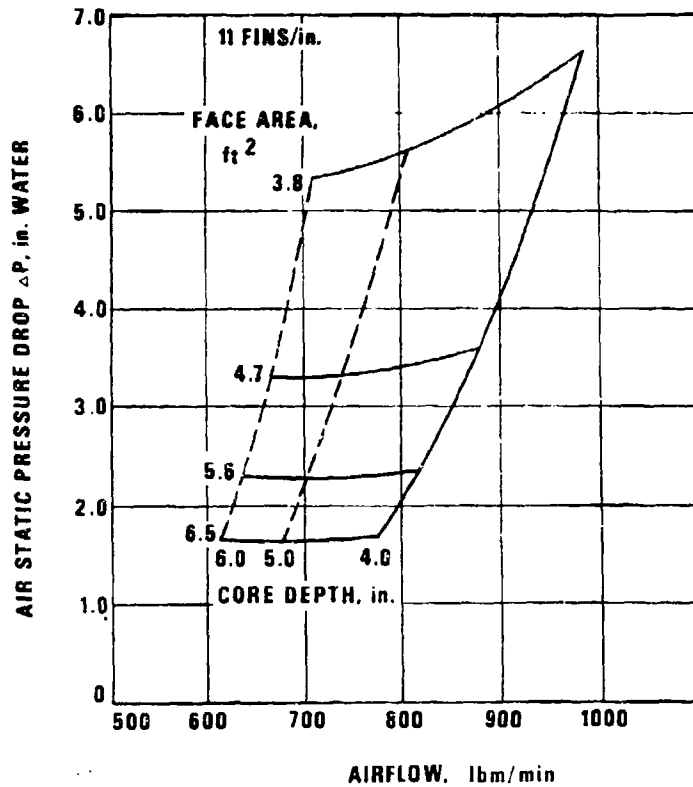

Figure 3-21. Radiator Core Performance Characteristics, 11 Fins/in.
 (Courtesy of Harrison Radiator Division-GMC)

oil-to-air cooler is similar to a radiator. It is usually necessary to provide oil-coolers to prevent excessive oil temperatures in military vehicles. Oil-to-air cooler calculations follow a procedure similar to that for a radiator. Fig. 3-23 shows a typical oil-to-air cooler. This particular design is used for the AVDS-1790 air-cooled M60 Tank engine.

3-6.3.1 Radiator Tank Oil Cooler

Radiator tank oil coolers normally are located in the exit tank of the radiator. The

coolant is at its lowest temperature at this location. The high temperature differential between the two fluids results in a smaller oil cooler. Other advantages are the elimination of a separate casing to house the oil cooler and a consequent saving in space which is always an important consideration in the engine compartment of a military vehicle.

This type of cooler may be double-tube construction. The oil flows in the annular space of two concentric tubes, and the radiator coolant flows over and through the

AMCP 708-361

RADIATOR CALCULATION ALUMINUM BAR-PLATE
100 gpm WATER AT 232°F
AIR AT 130°F
12,000 Btu/min HEAT REJECTION

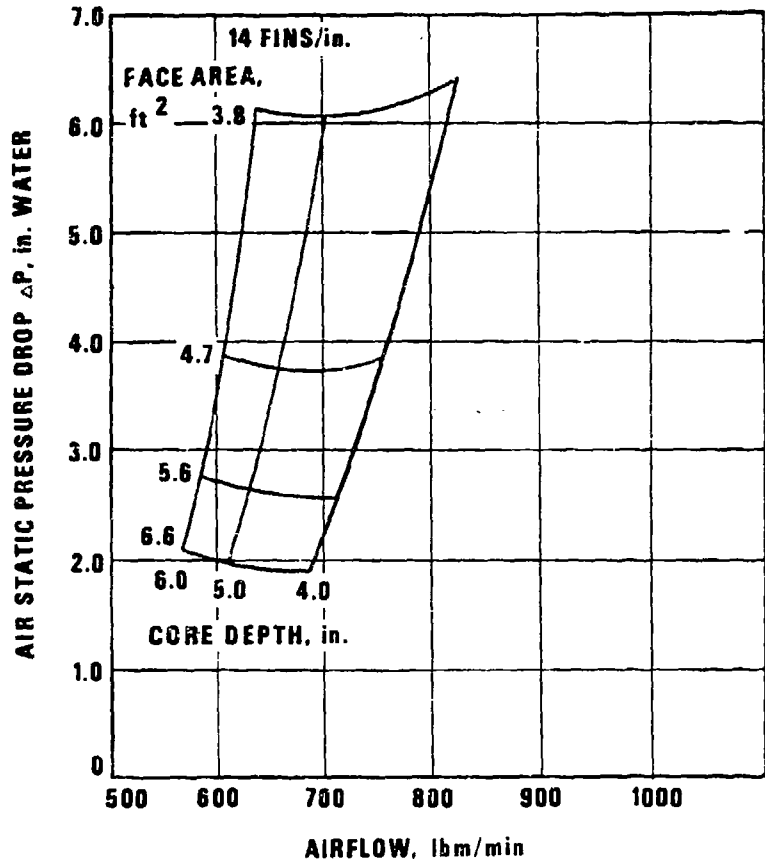

Figure 3-22. Radiator Core Performance Characteristics, 14 Fins/in.
 (Courtesy of Harrison Radiator Division-GMC)

tubes. Interrupted fin surfaces usually are in the oil flow passages to increase the oil side convection heat transfer coefficient. This type of construction functions as shown in Fig. 3-2, the oil being represented by fluid #2 (also see Ref. 11). This type oil-cooler generally is not used in engines with high oil heat rejection rates. A schematic diagram of a radiator tank type oil cooler is shown in Fig. 3-25(B).

3-6.3.2 Liquid-cooled Plate-type Oil Coolers

The plate type oil cooler consists of stacks of plate type tubes connected in parallel. The plates are spaced to permit coolant to circulate freely over the external tube surfaces. A typical plate-type core assembly is shown in Fig. 3-24(A). Performance charts for this type cooler are shown in Fig. 3-24(B).

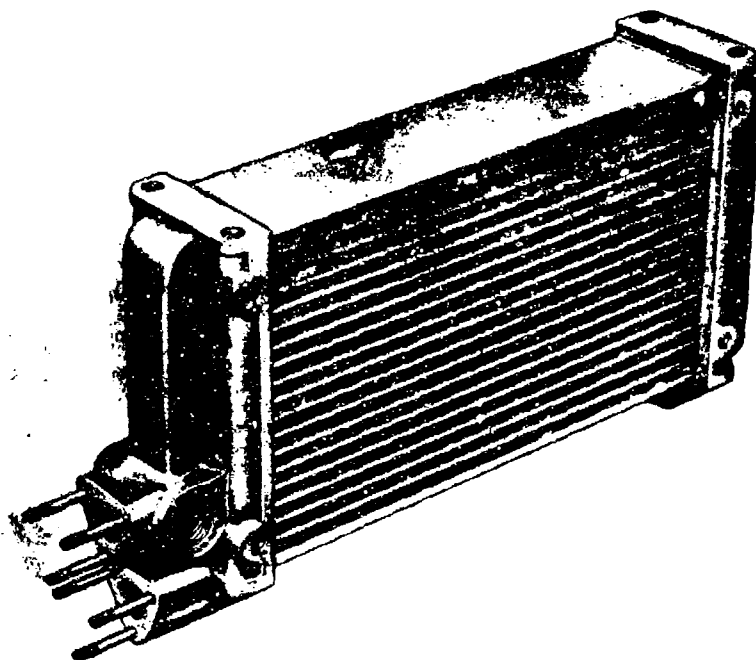

Figure 3-23. Oil-to-Air Cooler for AVDS-1790 Air-cooled M60 Tank Engine

A cooler selection procedure for prepackaged plate-type coolers is presented in Ref. 6.

3-6.3.3 Shell-and-tube Type or Tube-bundle Type Oil Cooler

The heat transfer core of the tube-bundle type oil cooler is a bundle of tubes with or without fins. Baffles are used to support the tubes and to provide nearly crossflow conditions for the shell side flow. The oil flows around the tubes, and the liquid coolant flows inside the tubes. Many different variations of tube arrangements may be used (see Ref. 1). Schematic drawings of this type of construction are shown in Fig. 3-25(A). Performance charts for oil coolers of this type may be obtained from the manufacturers.

3-6.4 TRANSMISSION OIL COOLERS

Transmission oil coolers are similar to engine oil coolers in construction and design. The same design considerations apply to both transmission and engine oil coolers. For oil-to-liquid coolers, engine coolant is used as

the cooling medium. Typical transmission torque converter or retarder brake cooler locations are shown in Figs. 3-26 and 3-27.

The precautions and limitations for coolant flow restrictions discussed in par. 3-6.2.1.2 also apply to the remote mounted cooler installation shown in Fig. 3-27. The relative positions of the coolers are influenced by the temperatures of various units that may influence power output or winterization warm-up rate.

The selection of an air-cooled or liquid-cooled transmission oil cooler is determined by the type of engine used (direct or indirect cooled), the available installation space within the vehicle, and the location of the cooling fan(s) and other radiators or heat exchangers. Liquid coolant is more efficient than air for heat transfer and sometimes results in the selection of an oil-to-coolant heat exchanger for transmission cooling for a liquid-cooled system, however, under this condition a large size radiator should be used. Air-cooled engine cooling systems generally use an

AMCP 706-361

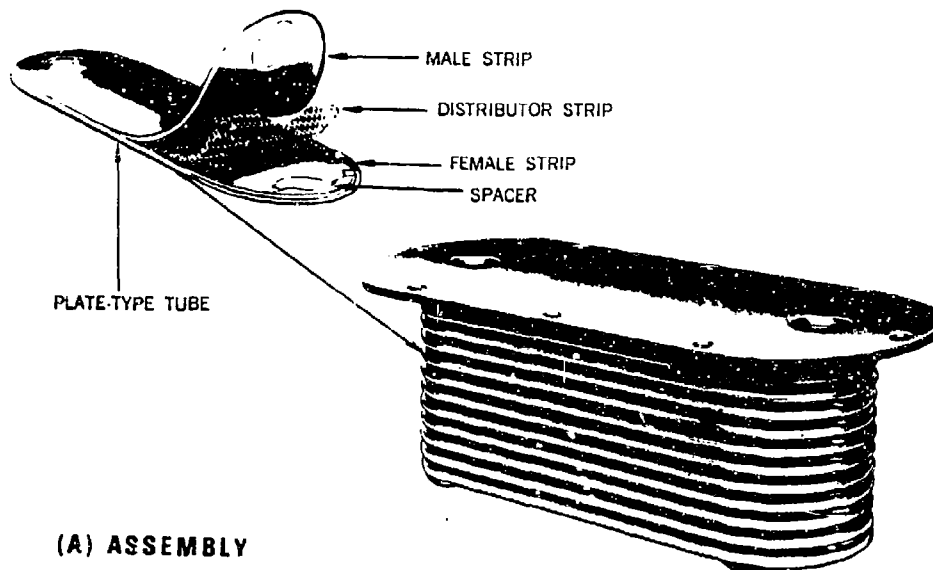

(A) ASSEMBLY

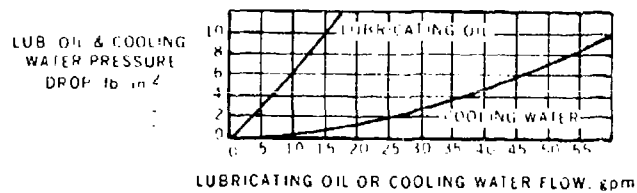
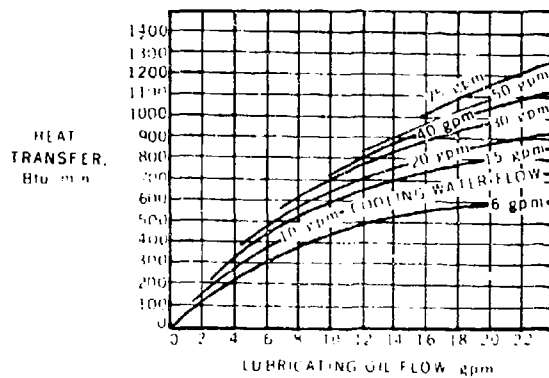

(B) PERFORMANCE CURVES

Figure 3-24. Typical Oil-to-Water Plate Type Core Assembly and Performance Curves (Ref. 6)
 (Courtesy of Harrison Radiator Division-GMC)

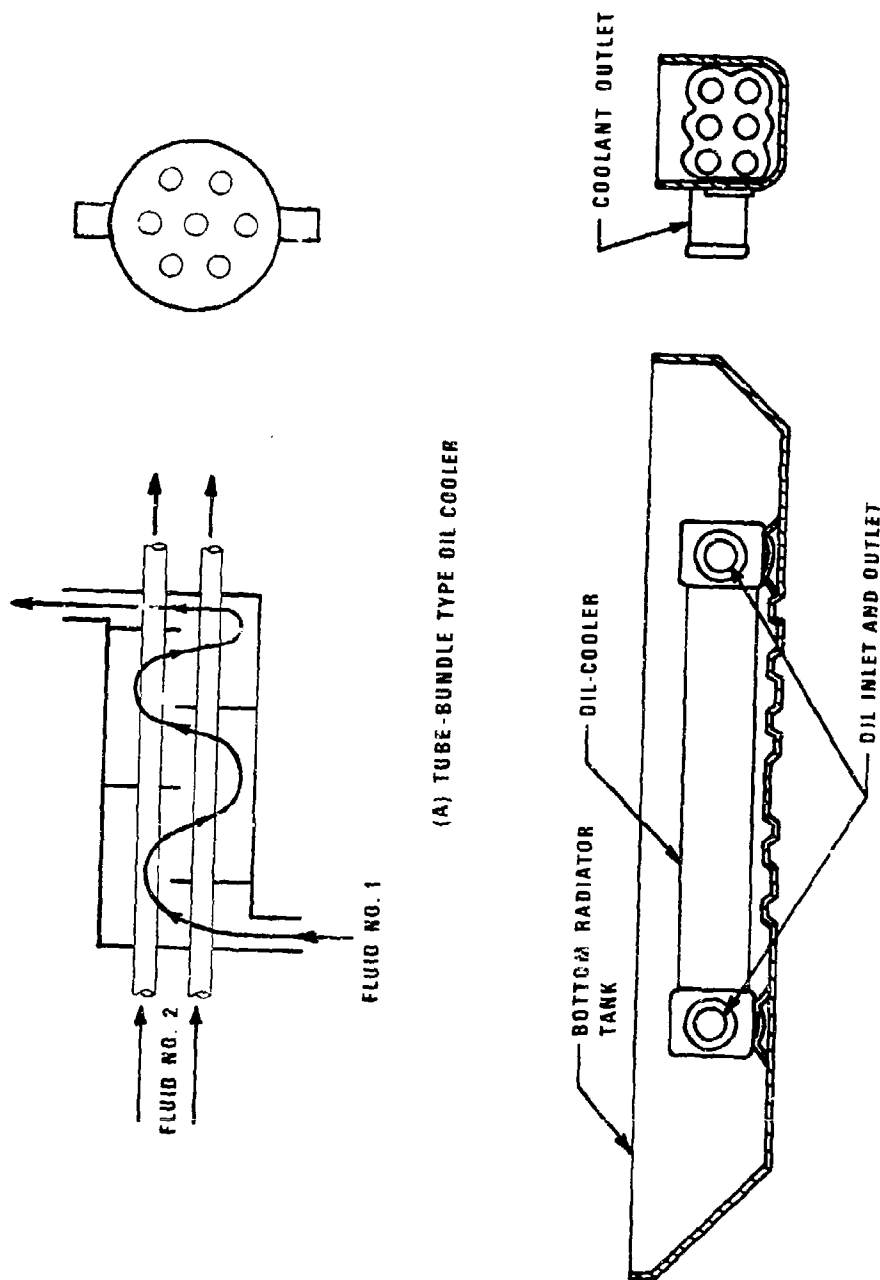

(A) TUBE-BUNDLE TYPE OIL COOLER

(B) RADIATOR TANK TYPE OIL COOLER

Figure 3-25. Tube-bundle and Radiator Tank Type Oil Coolers

AMCP 706-381

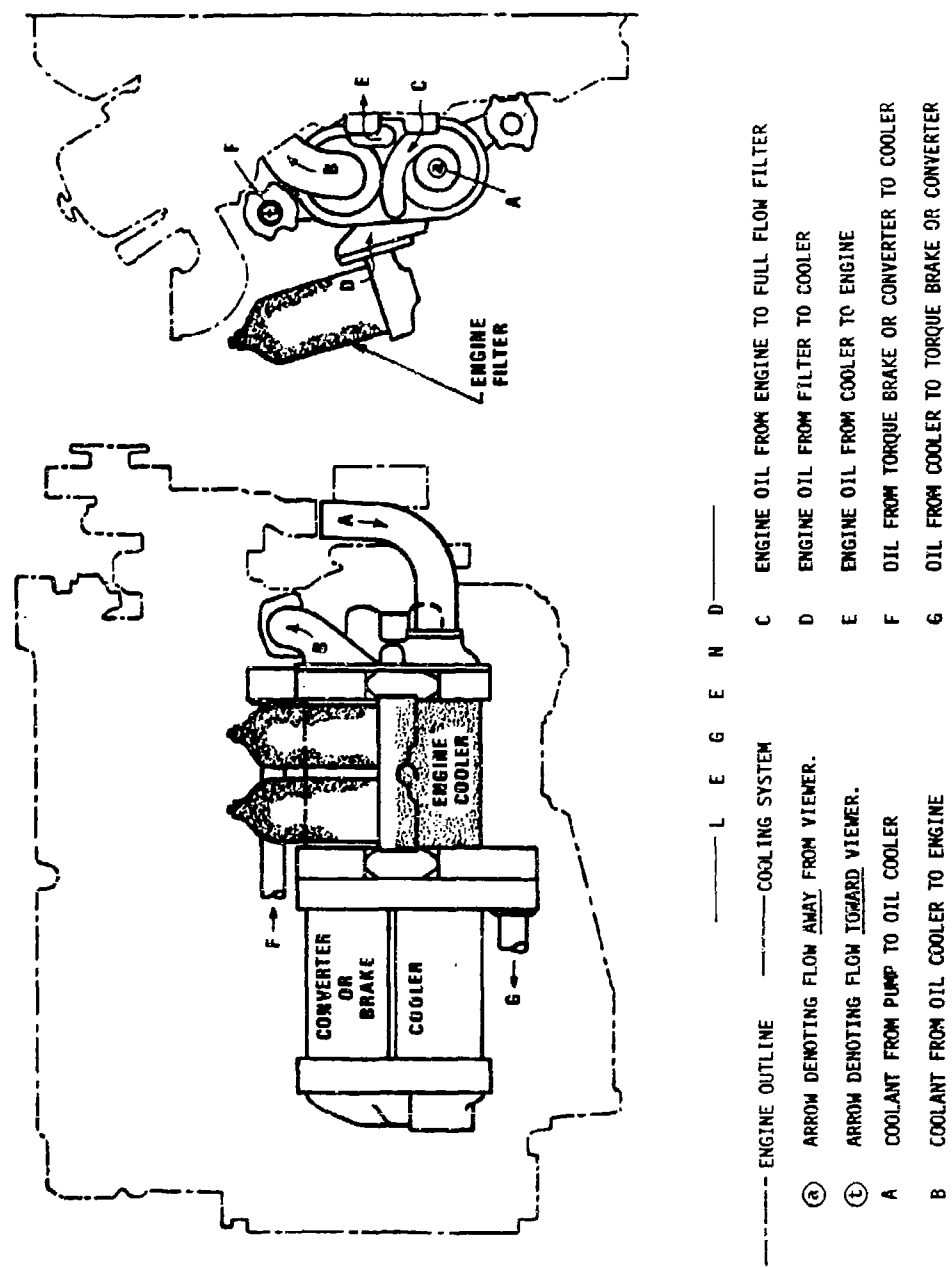
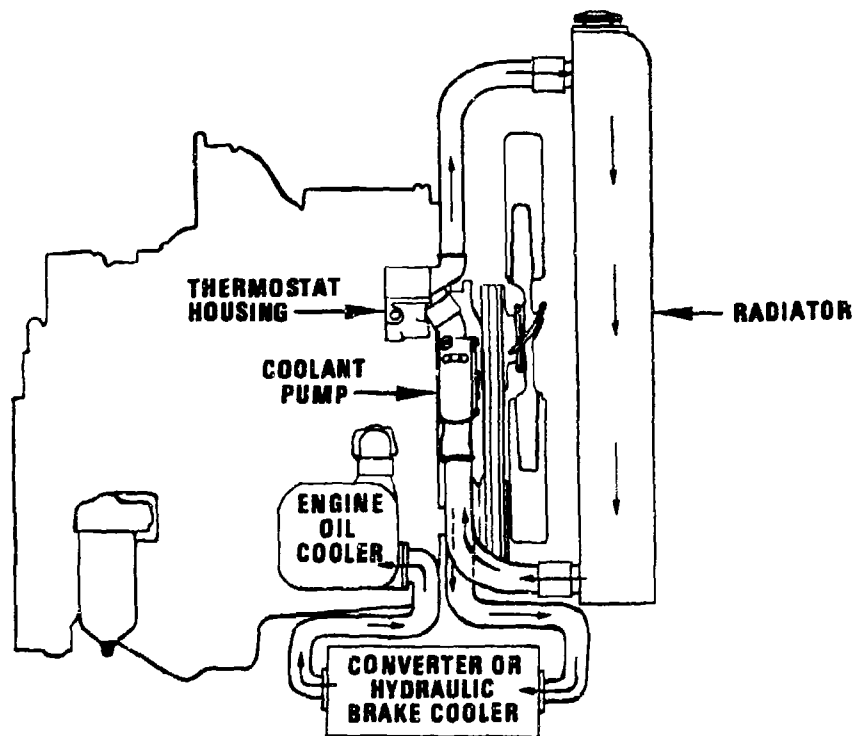

Figure 3-26. Transmission, Torque Converter, or Brake Cooler Location, Integral (Ref. 18)
 (Detroit Diesel Allison Division, General Motors Corporation)



*Figure 3-27. Transmission, Torque Converter, or Brake Cooler Location, Remote (Ref. 18)
 (Detroit Diesel Allison Division, General Motors Corporation)*

oil-to-air heat exchanger because of both cost and design considerations. When an oil-to-air cooler is used, it can share a single fan with the radiator, or it may use a separate cooling fan(s) as shown for the XM803 Experimental Tank power package (see Fig. 1-18).

Fig. 3-28 shows the air-cooled transmission oil cooler for the AVDS-1790-2 M60 Tank engine. Note the construction similarity with the engine oil cooler shown in Fig. 3-23. Refer to par. 8-1 for requirements that influence the relative location of the various heat transfer components.

3-6.5 OIL-COOLER SELECTION AND OPTIMIZATION EXAMPLES

The selection procedure for oil coolers

requires the determination of the required heat rejection rate and the physical limitations on core size. The oil-cooler manufacturer can provide a family of curves similar to those shown in Appendix A.

In using charts to estimate performance for a specific core size, or to estimate a core size for a desired performance condition, the following should be observed:

1. The required airflow rate is proportional to the face area.
2. The oil flow rate is proportional to the no-flow dimension, or to the number of oil passages. The no-flow dimension for all charts given here is approximately 12 in.

AMCP 706-381

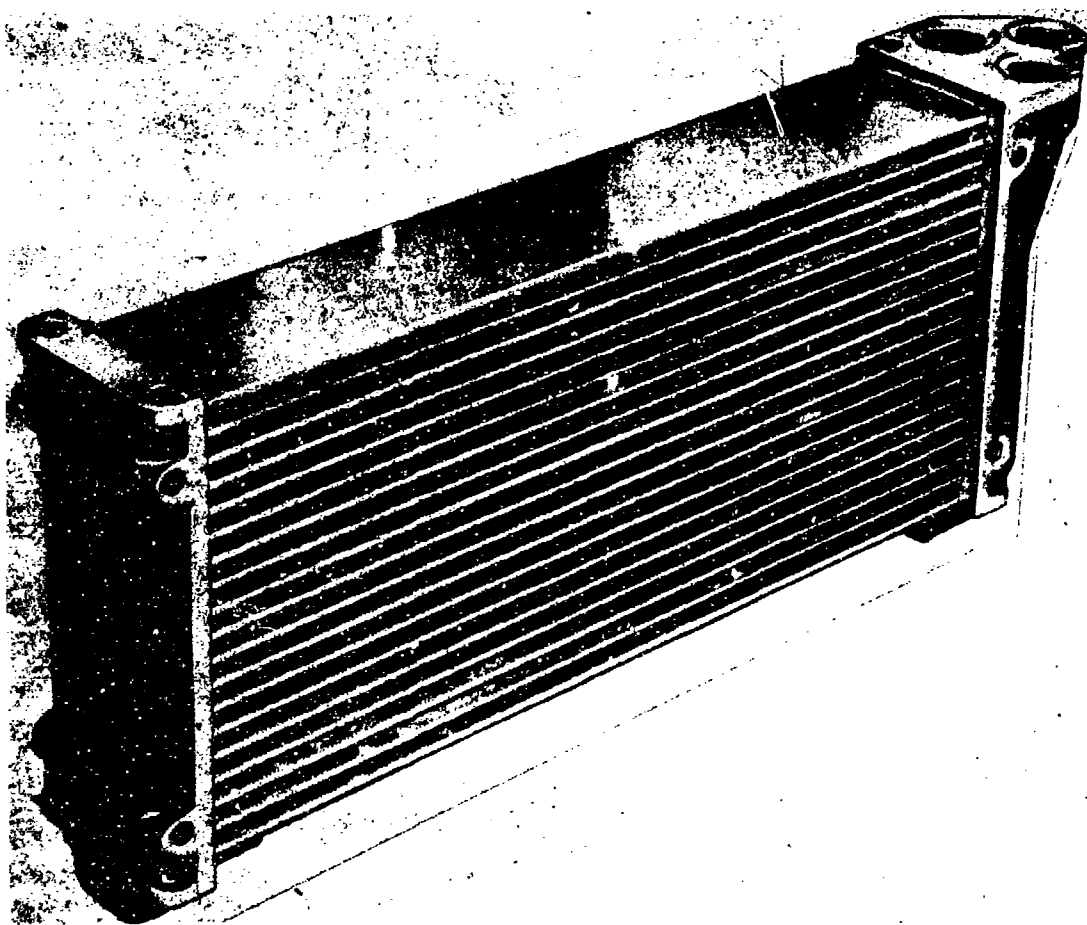

Figure 3-28. Air-cooled Transmission Oil Cooler for AVDS-1790-2 M60 Tank Engine

3. Overall heat transfer rate Q in Btu/min, is proportional to the face area for a given core depth and for the basic oil flow length (approximately 12 in.), with the basic heat transfer rate read from the appropriate chart at equivalent oil and airflow rates as indicated in Items 1 and 2. For cores having oil flow lengths other than 12 in., and with a relatively small oil temperature change, an approximation of the overall heat transfer rate may be made by proportioning directly to the face area.

4. The heat transfer rate for lighter grade petroleum oils, and/or at higher temperature levels, and for synthetic oils, will be slightly greater than indicated by the performance charts although no definitive value is suggested. Conversely, for heavier oils, such as SAE 50, at the same temperature or lower, the heat rejection would be slightly less. Conservative allowances can be made for these factors (see Fig. 3-29).

5. The core oil pressure loss is proportional to

the oil flow length for a given core depth and oil flow rate. The oil flow length for all charts given here is approximately 12 in. Additional oil pressure losses attributable to fittings and manifolds (inlet/outlet, tanks, bypass, etc.), must be estimated separately.

Oil pressure loss can vary widely depending on the type of oil, the oil temperature drop in the heat exchanger, air temperature, flow rate, and types of heat transfer surface. However, engine and transmission manufacturers have specified maximum allowable oil pressure drop to provide adequate inlet oil pressure to assure proper functioning of their equipment.

Example:

Given for oil-to-air cooler:

- Core face area A_f = 2.0 ft²
- Heat rejection Q = 2800 Btu/min
- Air-inlet temperature = 100°F
- Maximum oil temperature = 225°F
- Specific heat of oil C_p at 225°F = 0.53 Btu/lbm-°F (from Fig. 3-45)

Determine:

The required airflow and oil flow rates to maintain a 200°F oil outlet temperature.

Solution

1. The oil ΔT_{co} , is 225 - 200 = 25 deg F
2. The required oil flow, based on C_p at the average oil temperature of 212.5°F, (225 + 200)/2, from Fig. 3-45 is

$$\frac{Q}{C_p \Delta T_{co}} = \frac{2800}{0.53 \times 25} = 211 \text{ lbm/min}$$

3. The heat rejection rate per ft² of core face area = 2800/2 = 1400 Btu/min-ft².

4. The initial temperature difference ITD , is 225 - 100 = 125 deg F

5. The heat rejection rate per ft² per 100 deg F is

$$ITD = \frac{1400}{125/100} = 1120 \text{ Btu/min-ft}^2 \cdot 100^\circ\text{F} / ITD$$

6. If the cooler core is assumed to be 1 ft (tube length) by 2 ft (core width) then the oil flow per ft² of core face area will be 211/2 = 106 lbm/min-ft².

7. If the core selected for this application is shown in Fig. A-1, (Point A) then the required airflow rate can be found to be 311 lbm/min-ft². The total airflow rate is 622 lbm/min

8. The heat rejection rate for a core tube length other than 12 in. can be approximated by proportioning directly to the face area, actual data must be obtained from the manufacturer

9. The core oil and air pressure drops are obtained from Fig. A-1 Point A. The oil flow ΔP is 6.7 lbf/in.² and the airflow ΔP is 3.5 in. water.

The approximate effects on oil-cooler heat transfer, for different SAE oil grades and temperatures for a typical engine lubricating oil, are shown in Fig. 3-29. This figure illustrates that the effect of SAE grades is negligible in comparison with the effects of temperature. The oil-cooler heat rejection rate varies approximately as the ratio of specific heats of the oil.

3-6.6 OIL-COOLER OPTIMIZATION

There are numerous cooler core designs and, for a specific application several different

AMCP 706-381

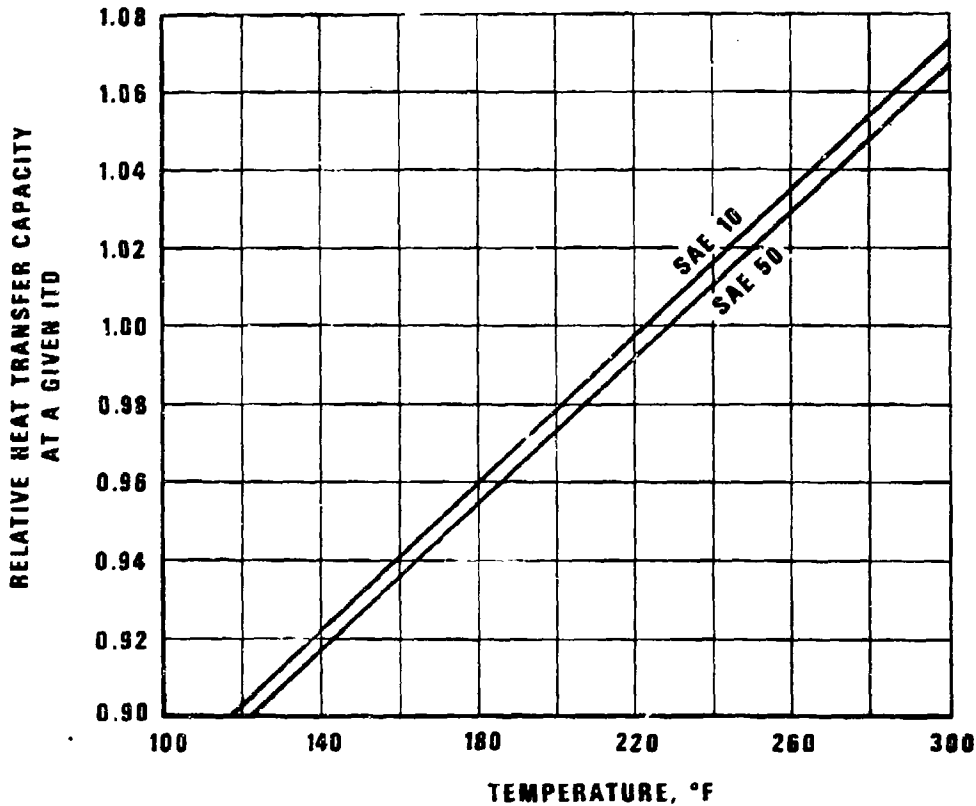

Figure 3-29. Approximate Relative Heat Transfer Capacity vs Temperature for Oil Coolers
 (Prepared from test data from various sources)

types may well meet all performance specifications. An optimum cooler size can be selected for any specific set of requirements.

Figs. 3-30, 3-31, and 3-32 show the variation of core volume and face area with pressure drop and fin spacing for three different core designs. These are related designs in that only the air center height and tube width (see Fig. 3-7) are varied with the number of tubes remaining the same (15 tubes) for all three designs. The envelope dimensions change. It may be noted that all cases near minimum volume and face area with minimum airflow rate are attained by the use of maximum density finning and high

air side pressure differential. Table 3-5 is a list of design parameters for these cooler designs at near minimum core volumes. It may be seen that heat exchanger volume may vary 200 percent, depending on the choice of design variables.

Table 3-5 lists the design parameters for four different optimizing criteria. It may be seen from this table that heat exchanger core volume may vary 250 percent, depending on the choice of design variables. It is also shown that for minimum airflow rate and minimum horsepower, a core type shown in Fig. 3-30 should be used. This, however, results in the largest core volume requirement. For mini-

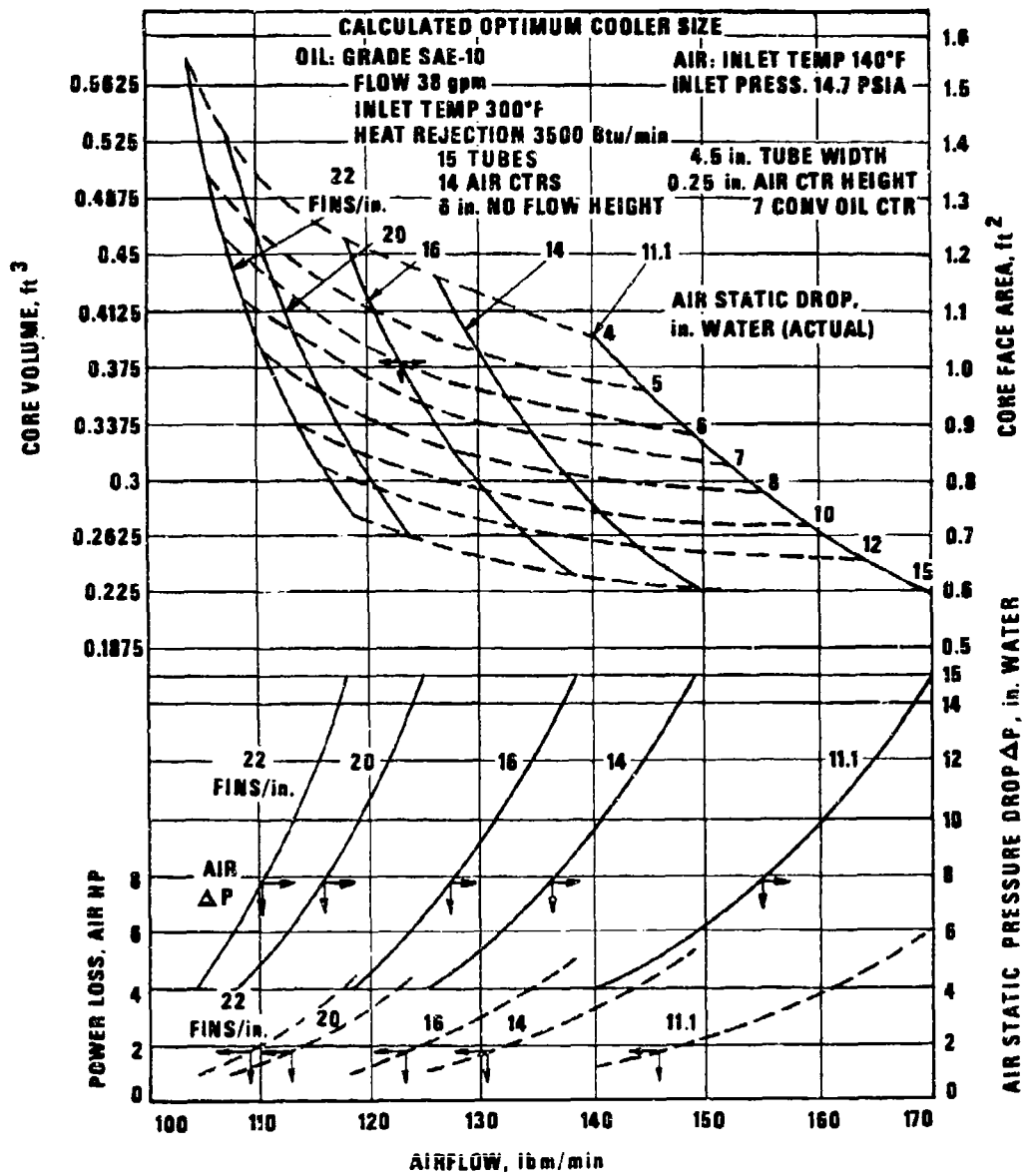

Figure 3-30. Oil-cooler Design Variables With 6.0-in. Tube Height (Ref. 5)

AMCP 706-361

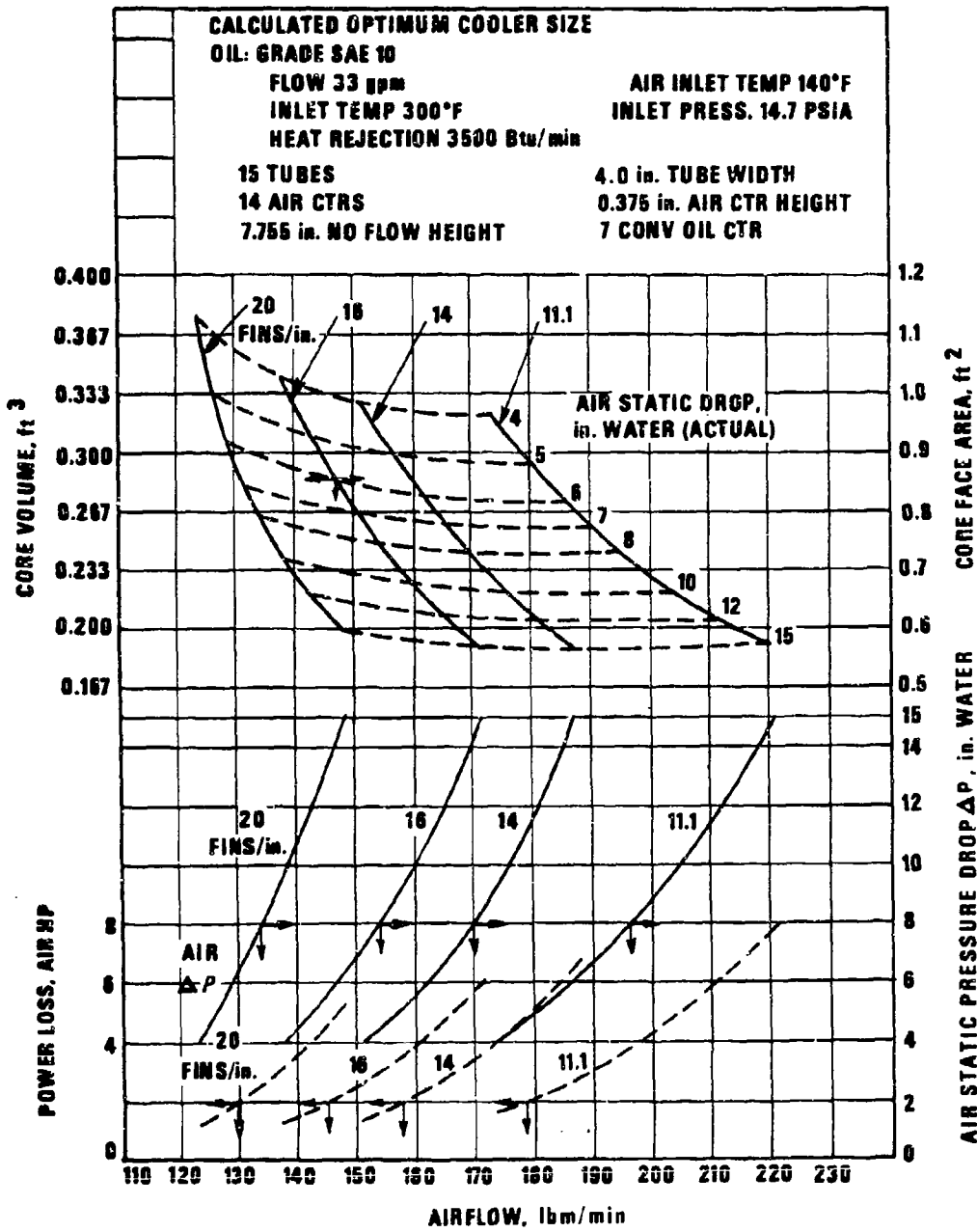

Figure 3-31. Oil-cooler Design Variables With 4.0-in. Tube Width (Ref. 5)

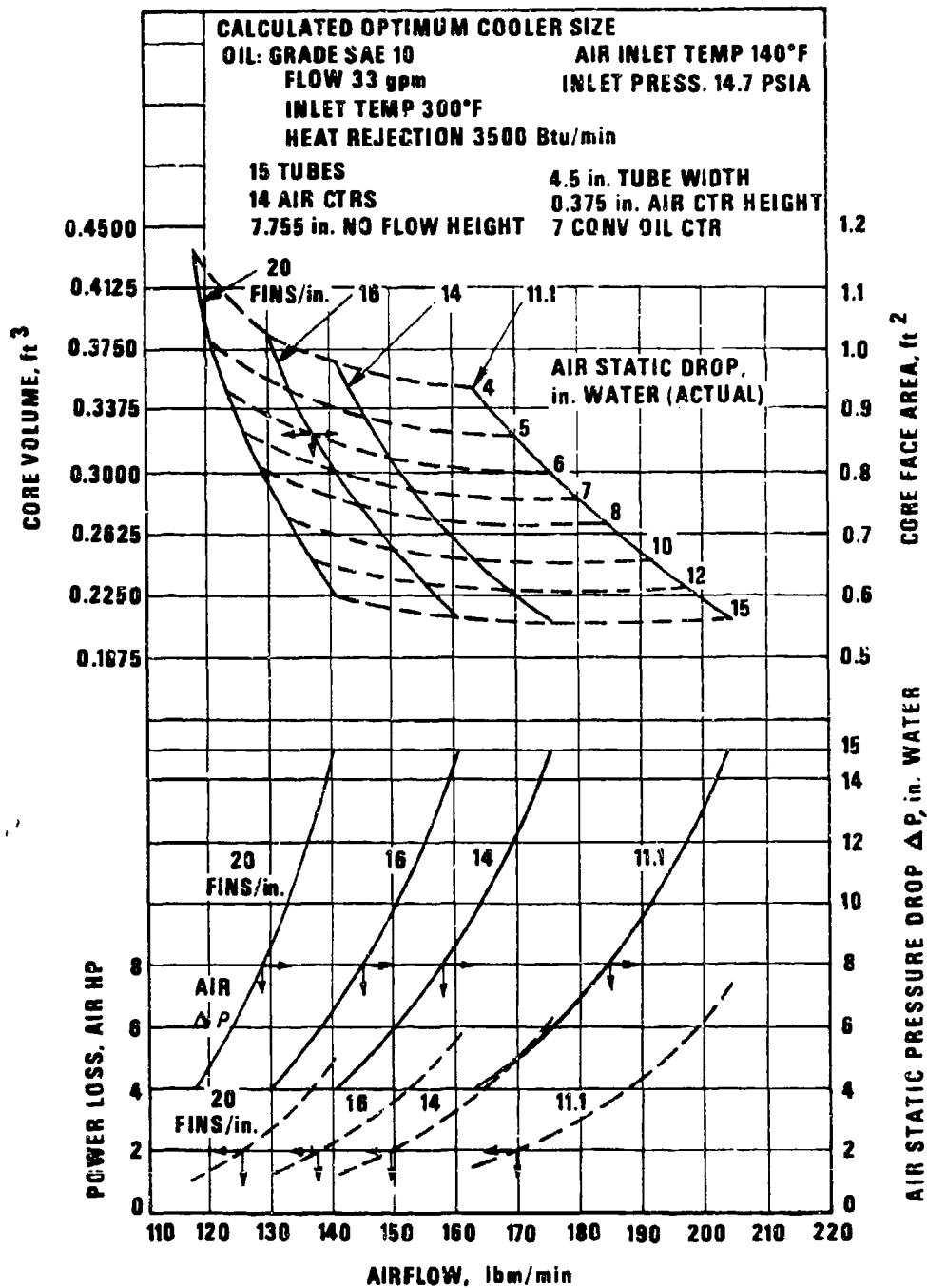

Figure 3-32. Oil-cooler Design Variables With 7.75-in. Tube Height (Ref. 5)

AMCP 706-361

TABLE 3-5

OIL-COOLER DESIGN PARAMETERS AT NEAR MINIMUM CORE VOLUME (Ref. 5)

<u>Constants</u>				
33 gpm oil flow rate				
3500 Btu/min heat rejection				
15 Tubes				
Tube length constant				
<u>Variables</u>				
Figure Number	3-30	3-31	3-32	
No-flow height, in.*	6	7.755	7.755	
Tube width, in.	4.5	4.0	4.5	
Air center height, in.*	0.25	0.375	0.375	
<u>Optimum Criteria</u>	<u>Parameters</u>			
Minimum Core Volume or Minimum Core Face Area	Core volume, ft ³	0.225	0.19**	0.20
	Core face area, ft ²	0.600	0.57	0.56
	Fins/in.	11.1	14	14
	Airflow rate, lbm/min	170	187	175
	Airside ΔP, in. water	15	15	15
	Air HP	6	6.3	6
Minimum Airflow Rate at Smallest Possible Core Volume	Core volume, ft ³	0.28	0.20	0.225
	Core face area, ft ²	0.74	0.595	0.60
	Fins/in.	22	20	20
	Airflow rate, lbm/min	118**	148	140
	Airside ΔP, in. water	15	15	15
	Air HP	4	5.2	4.9
Minimum Airflow Rate	Core volume, ft ³	0.574	0.377	0.42
	Core face area, ft ²	1.53	1.13	1.17
	Fins/in.	22	20	20
	Airflow rate, lbm/min	104**	123	118
	Airside ΔP, in. water	4	4	4
	Air HP	1.0	1.2	1.1
Minimum Air HP at Smallest Possible Core Volume	Core volume, ft ³	0.401	0.32	0.353
	Core face area, ft ²	1.07	0.96	0.94
	Fins/in.	11.1	11.1	11.1
	Airflow rate, lbm/min	140	173.5	163
	Airside ΔP, in. water	4	4	4
	Air HP	1.4**	1.7	1.6

*See Fig. 3-7 for definitions.

**Optimization point based on specific optimum criteria.

mum core volume, the core type shown in Fig. 3-31 should be used. However, this results in the largest air horsepower requirement. A best design can be made that will require minimum horsepower within the space available in an actual vehicle.

This type of unit is suitable for an oil-cooling arrangement in which the heat transfer system is optimized with respect to the space and specified air supply conditions. Extreme variations in size may be visualized. A unit of unlimited size may be cooled by

natural convection alone and, therefore, would require a zero input of cooling horsepower. The converse is not true in the sense that zero size would result from the use of an unlimited air supply since heat transfer functions tend to become asymptotic as fluid flow rate increases without limit. It is, therefore, necessary to evaluate carefully space and airflow conditions so that the installation may be optimized with respect to the desired variable; i.e., length, width, height, volume, airflow rate, pressure drop, or horsepower.

3.6.7 AFTERCOOLERS

Supercharging is used to compress and increase the density of the charge (air in diesel engines and air-fuel mixture in gasoline engines) before it enters the cylinders. Inlet charges of higher density will produce higher output.

The temperature of the charge will increase as it is compressed in the supercharger. For high pressure ratios, the temperature increase may be significant enough to offset the increased density of the charge. A heat exchanger then is used to cool the charge leaving the supercharger. This provides the cylinders with a higher density charge to produce maximum engine power.

A supercharger is a compressor driven by the crankshaft, either through gears or a belt. Turbochargers are exhaust gas driven and usually are centrifugal blowers.

Superchargers may be installed singly, in parallel, or in stages (series), with cooling between stages or at the outlets. The heat exchanger used between stages is called an intercooler. The heat exchanger used at the final outlet of supercharging is called an aftercooler. Most military engines use a single stage supercharger, and the aftercooler is encountered most frequently.

For air-cooled engines, the aftercooler is

air-cooled. For liquid-cooled engines, the aftercooler can be either liquid- or air-cooled. Liquid-cooled aftercoolers can be built into an oversize intake manifold. While this may increase engine cost, it may provide the least expensive heat exchanger arrangement that can be fitted most easily into the vehicle installation.

Liquid-cooled aftercoolers have a distinct limitation in that the engine coolant temperature is close to the compressor discharge temperature at peak engine torque speeds. Under operating conditions, the liquid-cooled aftercooler can provide a warm-up feature that acts as a winterization aid and usually a smaller size unit is required.

Air-cooled aftercoolers do not have this limitation because ambient air is the cooling medium and usually the air temperature is considerably lower than the compressor discharge temperature.

Construction and design procedures of liquid-cooled aftercoolers are similar to those of radiators or air-cooled oil-coolers. Air-cooled after-coolers, however, are gas-to-gas heat exchangers. The requirements and problems differ in many respects from those of liquid-to-liquid and liquid-to-air heat exchangers. For air-cooled aftercoolers, convection heat transfer coefficients on both sides are about the same order of magnitude, thus overall heat transfer capability is controlled by the heat transfer coefficients of both sides. Gas convection heat transfer coefficients are lower than those of liquid flow heat exchangers, thus a much larger volume of heat transfer matrix is required to transmit equal amounts of heat. Allowable gas pressure drops on both sides are usually low, and larger heat exchangers must be used. In most air-cooled aftercoolers, leakage from one fluid side to the other often is not objectionable and a lighter and less rugged construction may be employed.

Figs. 3-33 and 3-34 show the respective

A 1CP 706-361

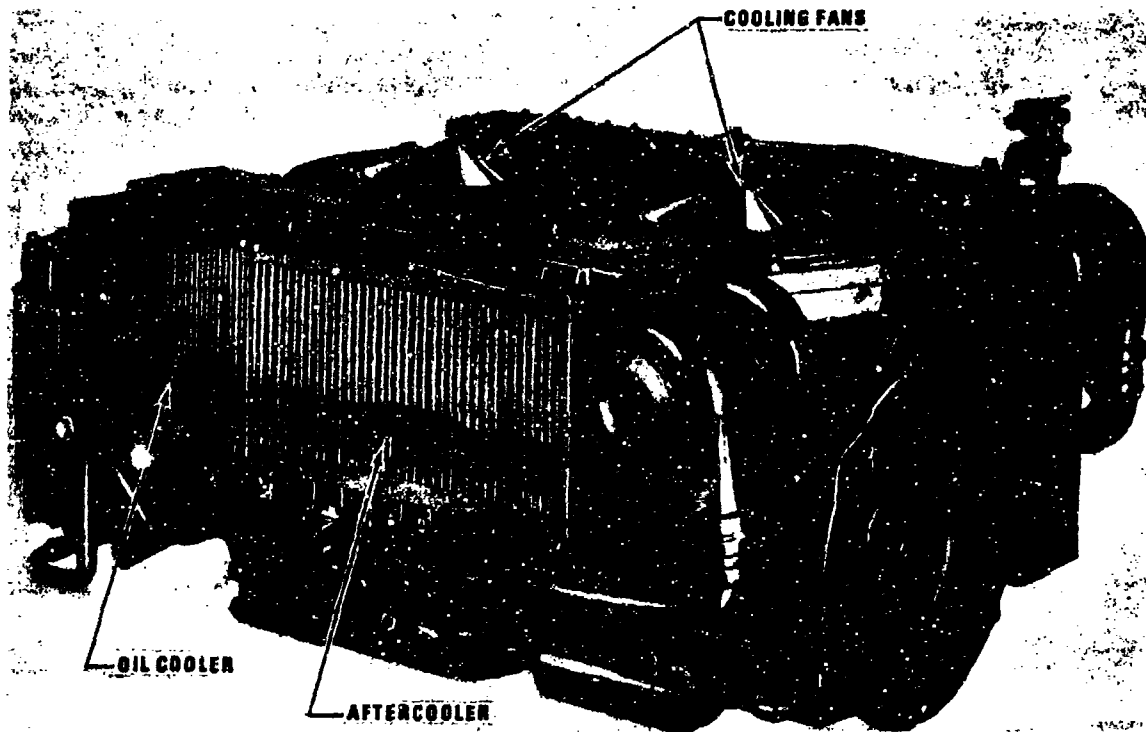

Figure 3-33. AVCR-1100 Air-cooled Tank Engine for the M60 Tank (Ref. 7)

air-cooled and liquid-cooled AVCR-1100 and MB873-Ka-500 Tank engines. Both engines incorporate aftercoolers.

Example: Air-To-Air Aftercooler (Ref. Figs. 3-33 and 3-35).

Given:

Maximum Allowable Core Size = 15 in. high \times 18 in. long \times 5 in. thick

(Determined from design layout)

Induction Airflow Rate $w_h = 130$ lbm/min
(Required by engine)

Induction Air Temperature T_{h1} to Cooler = 603°F

(Calculated from the specified turbo-charger pressure ratio)

Desired Air Temperature T_{h2} to Engine = 250°F (To maintain desired power)

Cooling Air Inlet Temperature $T_{c1} = 120^\circ\text{F}$ (Vehicle specifications)

Determine:

1. Cooling airflow required, lbm/min
2. ΔP across the core, in. water
3. Temperature rise ΔT_c of the cooling air, deg F

Solution:

From the design parameters given, the cooler supplier can provide aftercooler performance curves as shown in Fig. 3-35. Note that the cooling airflow is plotted vs induction air effectiveness.

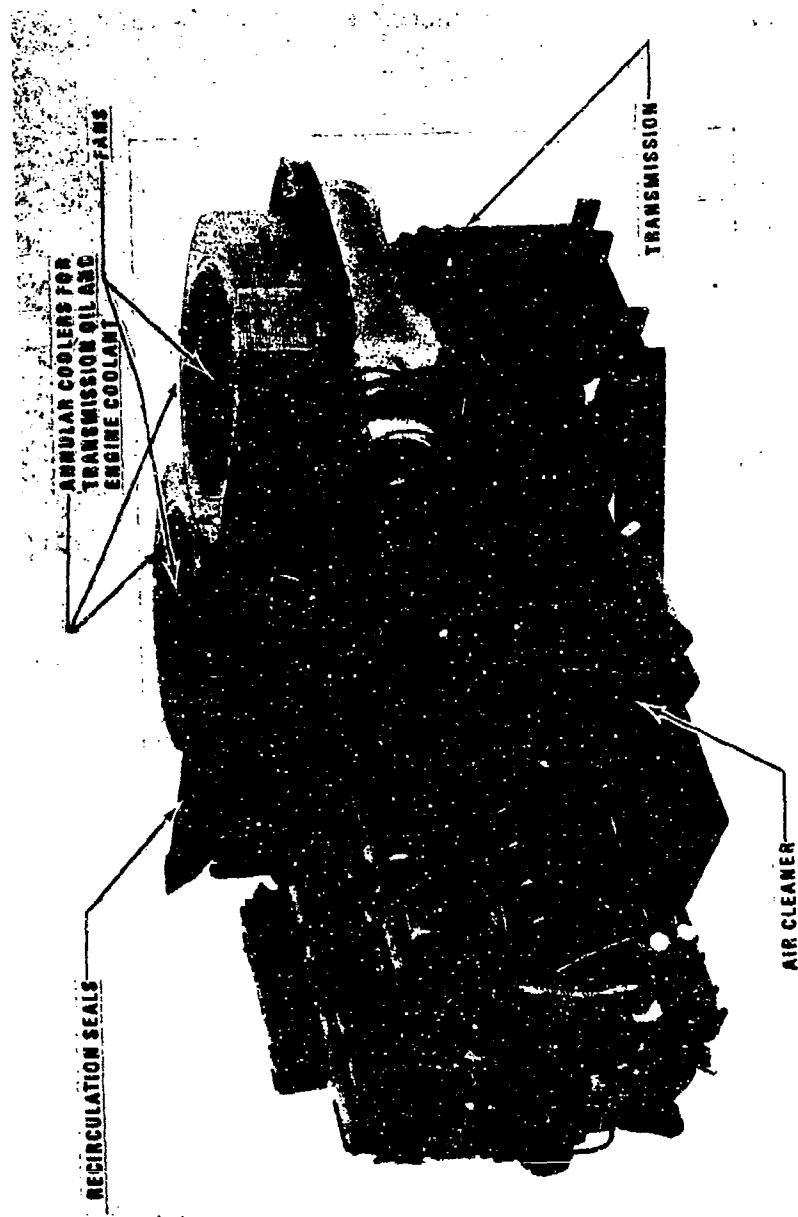

Figure 3-34. MB873-Ka-500 Liquid-cooled Power Package as Installed in the MBT Leopard II Tank
(Courtesy of Motoren-Und Turbinen-Union; Friedrichshagen GMBH)

AMCP 706-361

INLET TEMPERATURES
 INDUCTION AIR: 603°F
 COOLING AIR: 120°F

FLOW RANGE
 INDUCTION AIR: 70-190 lbm/min
 COOLING AIR: 100-300 lbm/min

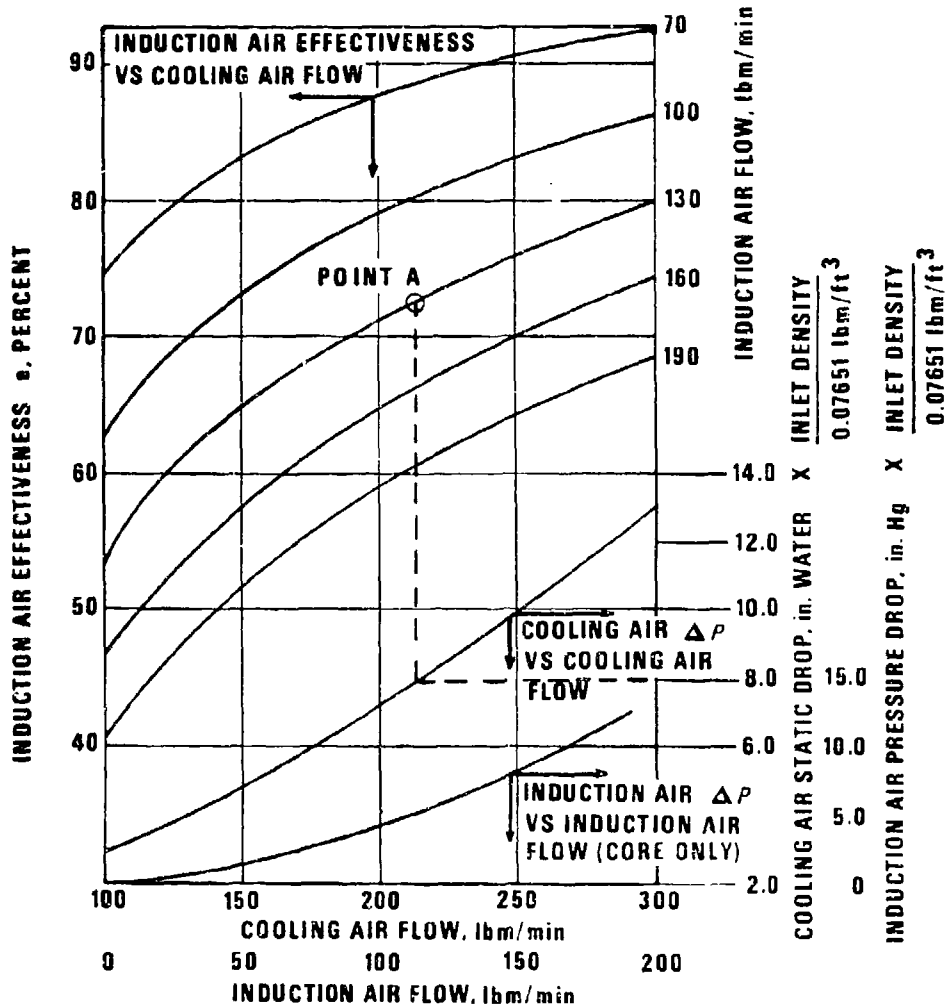

Figure 3-35. Aftercooler Performance Curves (Ref. 7)

The induction air side effectiveness e_h is expressed by

$$e_h = \frac{T_{h1} - T_{h2}}{T_{h1} - T_{c1}}, \text{ dimensionless} \quad (3-20)$$

where

T_{h1} = temperature of hot air in, °F

T_{h2} = temperature of hot air out, °F

T_{c1} = temperature of cooling air in, °F

Therefore the required effectiveness is

$$e_h = \left(\frac{603 - 250}{603 - 120} \right) = 0.73 \text{ or } 73\%$$

From Fig. 3-35 the cooling airflow rate and required cooling airflow static pressure drop ΔP can be read at 73 percent effectiveness for 130 lbm/min airflow as

Cooling airflow rate $w_h = 220$ lbm/min

Cooling airflow static pressure drop $\Delta P = 8.0$ in. water

The specific heats of the two fluids in this case are approximately equal, therefore the effectiveness e_c of the cooling air side can be determined by

$$e_c = e_h \left(\frac{w_h}{w_c} \right), \text{ dimensionless} \quad (3-21)$$

where

w_h = flow rate of induction air (hot), lbm/hr

w_c = flow rate of cooling air (cold), lbm/hr

therefore

$$e_c = 0.73 \left(\frac{130 \times 60}{220 \times 60} \right) = 0.43 \text{ or } 43\%$$

The cooling air side effectiveness can also be expressed by

$$e_c = \frac{T_{c2} - T_{c1}}{T_{h1} - T_{c1}}, \text{ dimensionless} \quad (3-22)$$

and

$\Delta T_c = e_c (T_{h1} - T_{c1})$, temperature rise of cooling air, deg F

where

$$\Delta T_c = 0.43(603 - 120) = 208 \text{ deg F}$$

3-6.3 KEEL COOLERS

A special circumstance exists where indirect cooling incorporates liquid-to-liquid heat exchangers to transfer heat from the system. This occurs in the case of amphibious vehicles that have an anticipated employment requiring a substantial portion of their service in marine operation. These heat exchangers, often called keel coolers, generally consist of cooling coils located so they are submerged when the vehicle is engaged in water operations. They may be designed to assume part or all of the cooling load. When the keel cooler assumes a partial cooling load, conventional coolers also may be needed. Under these conditions, extreme care must be exercised to prevent water from entering the engine compartment through the air intake grilles. When the keel cooler assumes the total cooling load, submerged coils are used to dissipate the entire heat load and conserve the horsepower necessary to operate the cooling fans.

An example of the total cooling load being assumed by submerged coils may be found in the US Army Self-propelled Amphibious Lighter, LARC-XV. See Figs. 3-36, 3-37, and 3-38. The radiator cooling fans of this vehicle automatically shut down when the transmission is shifted into the marine operating mode and all heat rejection is accomplished by

AMCP 706-381

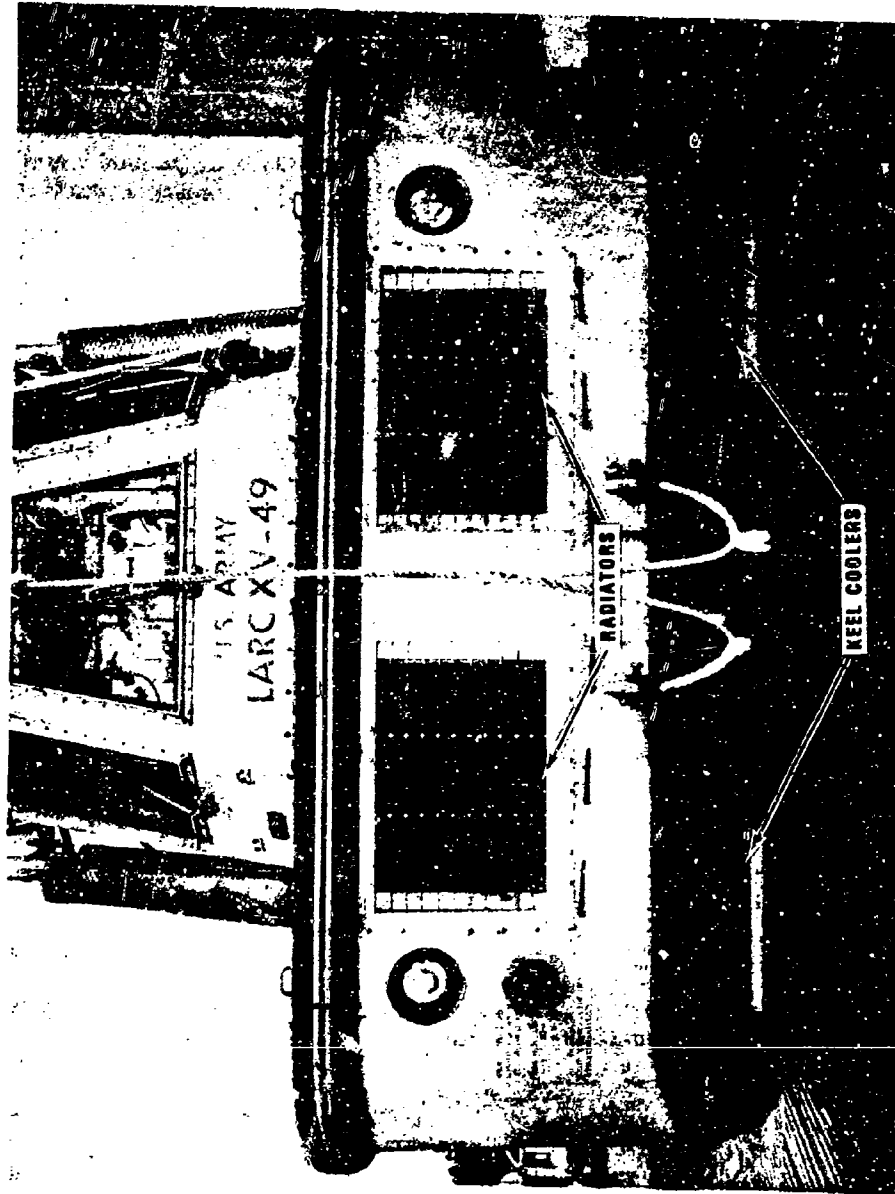

Figure 3-36. LARC-XV-49 Self-propelled Amphibious Lighter, Showing Relative Location of Radiators and Keel Coolers (Ref. 15.)



Figure 3-37. LARC-XV-49 Self-propelled Amphibious Lighter, Showing Close-up of Keel Cooler (Ref. 15)

AMCP 706-381

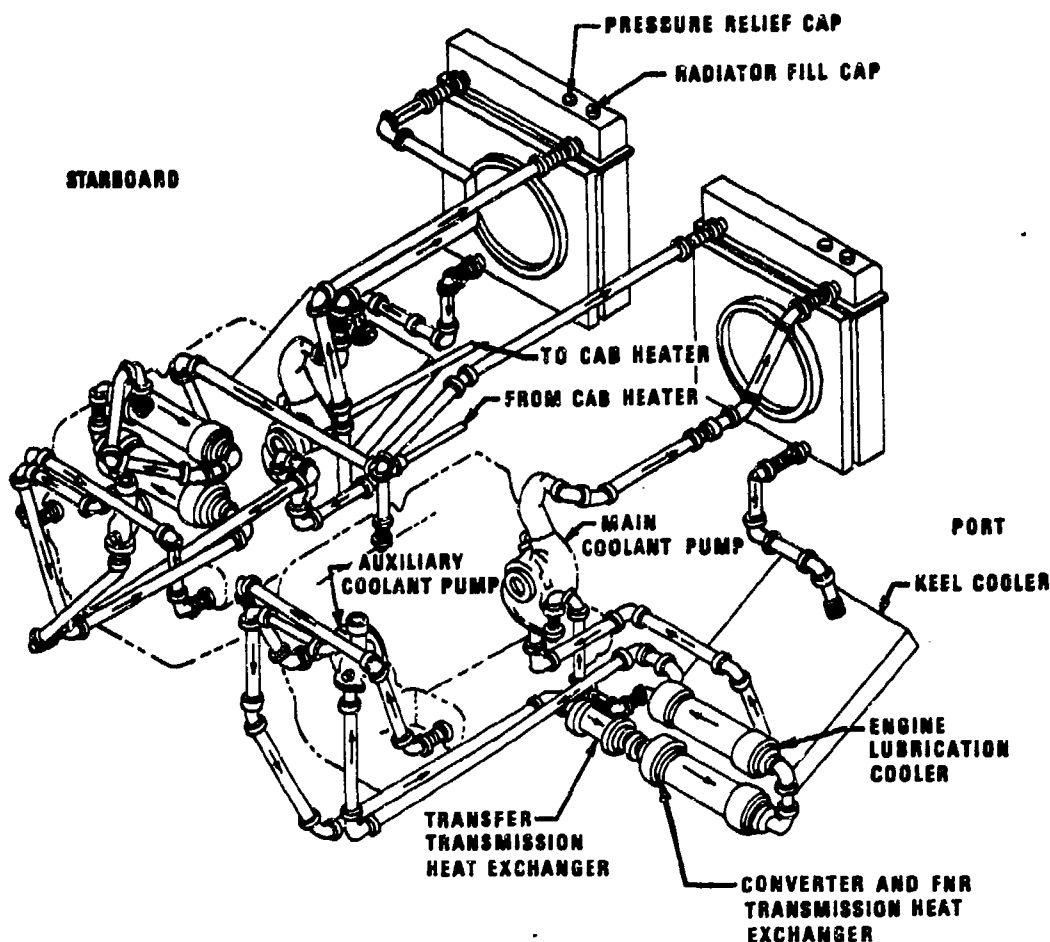

Figure 3-38. LARC-XV-49 Self-propelled Amphibious Lighter, Cooling System Schematic Drawing (Ref. 15)

cooling coils located below the radiators. This vehicle has a cooling system similar to the LVTPX12 described in Chapter 1.

A keel cooler consists of a specific size and length of tubing with no extended surface for heat transfer. Since the heat is transferred into a large heat sink, the temperature change of the cold side is negligible.

Example¹:

Determine the required length of the tubing for a keel cooler design with the following parameters:

1. Engine heat rejection = 6000 Btu/min

¹ Courtesy of Dr. Jiunn P. Chiou, Consultant

2. Engine Coolant flow rate = 50 gal/min
3. Maximum engine coolant temperature at the cooler inlet = 195°F
4. Water is to be used as the engine coolant
5. Design cooling water temperature (per MIL-STD-210) = 95°F (Assumed to be fresh water)
6. Cooler tubing (trial size):
 - a. 70-30 brass
 - b. 14 gage or 0.083 in. tube wall thickness
 - c. 0.500 in. outside diameter
 - d. 0.334 in. inside diameter
7. Fouling factors of internal and external tube surfaces are assumed to be 0.001 and 0.003 hr-ft²-°F/Btu, respectively
8. Vehicle speed = 2 mph.

The actual coolant velocity is 2.95 ft/sec.

2. Determine the average coolant temperature in the heat exchanger. Assume an average coolant temperature of 185°F. From Fig. 3-43, C_p and ρ of water at this temperature are found to be 1 Btu/lbm-°F and 60.4 lbm/ft³, respectively. The coolant temperature drop through the heat exchanger is by Eq. 3-18

$$\Delta T = \frac{6000}{0.1337 \times 50 \times 60.4 \times 1} = 14.9 \text{ deg F}$$

The calculated average coolant temperature through the heat exchanger is

$$195 - \frac{14.9}{2} = 187.6^\circ \text{F}$$

For this case, the calculated average coolant temperature is very close to the assumed value and this step of the computation can be considered complete; otherwise an iteration process should be used until the calculated and assumed values are close enough within the accuracy desired.

3. Determine the average tube wall temperature. This temperature can be estimated as follows: Since the heat is transferred from the keel cooler to a large volume of water, the temperature of the water outside the keel cooler can be considered to be constant and at 95°F all the time.

Generally, the thickness of scales is small in comparison with the tube wall thickness and the following equation can be used

$$UA_r = \frac{1}{\frac{1}{h_i A_i} + \frac{f_i}{A_i} + \frac{\ln\left(\frac{r_2}{r_1}\right)}{2\pi k L} + \frac{f_e}{A_o} + \frac{1}{h_o A_o}},$$

Btu/hr-°F (3-23)

Solution:

1. Determine the number of tubes used. The liquid velocity inside a tube of a heat exchanger should not be too high or too low. If the liquid velocity is too low, scale formation on the tube wall will become a serious problem and the heat transfer performance will deteriorate significantly. If the liquid velocity is too high, the liquid pressure drop will be excessively high. A liquid velocity of 3 ft/sec is recommended. The number of tubes (connected in parallel) required is

$$\frac{50 \times 0.1337}{3 \times 60 \times \frac{\pi}{4} \left(\frac{0.334}{12}\right)^2} = 61.04 \text{ or } 62 \text{ tubes}$$

AMCP 706-361

where

U = overall heat transfer coefficient based on reference area A_r and overall fluid temperature difference, Btu/hr-°F

A_r = reference area, ft²

A_i = internal surface area of tube (approximation), ft²

A_o = external surface area of tube (approximation), ft²

h_i = convection heat transfer coefficient between coolant and scale on internal tube surface, Btu/hr-ft²-°F

h_o = convection heat transfer coefficient between cooling water and scale on external surface of tube, Btu/hr-ft²-°F

f_e = fouling factor of external tube surface, hr-ft²-°F/Btu

f_i = fouling factor of internal tube surface, hr-ft²-°F/Btu

r_2 = inner radius of tube, ft

r_3 = outer radius of tube, ft

k = thermal conductivity of tube wall material, Btu/hr-ft²-(°F/ft)

L = reference tube length, ft

For this problem the following assumptions can be made:

h_i = 1200 Btu/hr-ft²-°F (assumption and will be checked later)

h_o = 1200 Btu/hr-ft²-°F (assumption and will be checked later)

f_i = 0.001 hr-ft²-°F/Btu (See Ref. 3, Table H5.4)

f_e = 0.003 hr-ft²-°F/Btu (See Ref. 3, Table H 5.4)

k = 68 Btu/hr-ft²-(°F/ft) (assume the average tube wall temperature is 150°F from Fig. 3-41, this will be checked later)

For a tube 1 ft long, then

$$UA_r = \frac{1}{\frac{1}{1200 \times 2\pi \times \frac{0.334}{2 \times 12} \times 1} + \frac{0.001}{2\pi \times \frac{0.334}{2 \times 12} \times 1} + \frac{\ln\left(\frac{0.500}{0.334}\right)}{2\pi \times 68 \times 1} + \frac{0.003}{2\pi \times \frac{0.500}{2 \times 12} \times 1} + \frac{1}{1200 \times 2\pi \times \frac{0.500}{2 \times 12} \times 1}}$$

= 19.55 Btu/hr-°F of overall temperature difference per ft long tube

The overall heat transfer rate from coolant to the cooling water per ft of tube length is

$$19.55(187.6 - 95) = 1810.3 \text{ Btu/hr-ft long tube}$$

Under steady-state conditions assuming that the difference between the inner and outer surface area of the scale is negligible

$$\frac{(187.6 - T_1)}{1} = \frac{(T_1 - T_2)}{0.001} = 1810.3$$

$$1200 \times 2\pi \times \frac{0.334}{2 \times 12} \times 1 \quad 2\pi \times \frac{0.334}{2 \times 12} \times 1$$

The solution is

$$T_1 = 170.3^\circ\text{F}$$

$$T_2 = 149.5^\circ\text{F}$$

Similarly

$$1810.3 = \frac{(T_2 - T_3)}{\ln\left(\frac{0.500}{0.334}\right)} \frac{1}{2\pi \times 68 \times 1}$$

So, $T_3 = 147.8^\circ\text{F}$

The average temperature of the tube wall is approximately

$$\frac{149.5 + 147.8}{2} = 148.7^\circ\text{F}$$

The calculated average tube wall temperature (148.7°F) is very close to the one assumed (150°); otherwise an iteration process should be used in order to obtain an accurate average tube wall temperature.

T_4 can be calculated by

$$1810.3 = \frac{(T_3 - T_4)}{\frac{0.003}{2\pi \times \frac{0.500}{2 \times 12}}}$$

$T_4 = 106.3^\circ\text{F}$

4. Determine h_i . The film temperature of fluid on the coolant side is

$$\frac{T_1 + 187.6}{2} = \frac{170.3 + 187.6}{2} = 179^\circ\text{F}$$

From Fig. 3-43, water properties at this film temperature are

$\mu = 0.858 \text{ lbm/hr-ft}$

$C_p = 1.002 \text{ Btu/lbm-}^\circ\text{F}$

$k = 0.39 \text{ Btu/hr-ft-}^\circ\text{F}$

$Pr = 2.2$

$\rho = 60.6 \text{ lbm/ft}^3$

The Reynolds number Re_i is

$$Re_i = \frac{D\rho V}{\mu}, \text{ dimensionless} \quad (3-24)$$

where

D = internal diameter of tube, ft

V = fluid (coolant) velocity inside tube, ft/hr

ρ = fluid density, lbm/ft³

μ = fluid viscosity, lbm/hr-ft

therefore

$$Re_i = \frac{(0.334/12) \times 60.6 \times 2.95 \times 3600}{0.858} = 20877$$

This is turbulent flow. Assume the tube is long enough that the flow is fully developed in most parts of the tube (this will be checked later). The following Colburn's equation is recommended (Ref. 8)

$$\frac{h_i}{C_p V \rho} (Pr)^{2/3} = \frac{0.023}{(Re_i)^{0.2}} \quad (3-25)^1$$

therefore

$$h_i = \frac{0.023}{(20877)^{0.2}} \times \frac{1.002 \times 60.6 \times 2.95 \times 3600}{(2.2)^{2/3}} = 1197 \text{ Btu/hr-ft}^2\text{-}^\circ\text{F}$$

5. Determine h_o . The film temperature on the outside of the tube is

$$\frac{106.3 + 95}{2} = 100.7^\circ\text{F}$$

¹ Used with permission of McGraw-Hill Book Company

AMCP 708-381

From Fig. 3-43, the water properties at this temperature are

$$\mu = 1.649 \text{ lbm/hr-ft}$$

$$C_p = 0.998 \text{ Btu/lbm-}^\circ\text{F}$$

$$k = 0.364 \text{ Btu/hr-ft-}^\circ\text{F}$$

$$Pr = 4.51$$

$$\rho = 62.0 \text{ lbm/ft}^3$$

Convection heat transfer characteristics of tubes in crossflow depends on fluid flow parameters and the tube arrangements—such as number of rows of tubes, geometric patterns of the tube configuration, etc. For a single row of tubes with large transverse pitch and low Reynolds number, the convection heat transfer equation of a single cylinder in crossflow can be used with reasonable accuracy. For a tube bundle with more than one row of tubes, experimental data for heat transfer performance of various tube arrangements are available (Refs. 2, 3, 4, 10, 12, 13, and Bibliography). For the purpose of demonstration, the calculations that follow are based on the assumption that a single row of tubes with large transverse pitch is used. The following single tube heat transfer equation for crossflow in water is recommended (Ref. 21)

$$\frac{h_o D}{k} = [0.35 + 0.56(Re)^{0.52}] (Pr)^{0.3} \text{ for } 10^4 \leq Re \leq 10^5 \quad (3-26)^1$$

All fluid properties should be based on the film temperature. From Eq. 3-24 the Reynolds number Re_o for flow outside the tube is

$$Re_o = \frac{(0.500/12) \times 2 \times 5280 \times 62}{1.649} \text{ where } 2$$

$$\begin{aligned} &\times 5280 \text{ is the vehicle speed in ft/hr,} \\ &= 16543 \end{aligned}$$

¹ Used with permission of McGraw-Hill Book Company

Thus Eq. 3-26 can be applied

$$\begin{aligned} \frac{h_o D}{k} &= [0.35 + 0.56(16543)^{0.52}] (4.51)^{0.3} \\ &= [87.82] (1.57) \\ &= 137.9 \end{aligned}$$

then

$$h_o = \frac{137.9 \times 0.364}{(0.500/12)} = 1205 \text{ Btu/hr-ft}^2\text{-}^\circ\text{F}$$

It should be noted that h_i and h_o calculated are very close to the ones assumed in Step 3; therefore, the average tube wall temperature and inside and outside surface film temperatures previously calculated are acceptable. Otherwise, an iteration process should be carried out from Steps 3 to 5 in order to obtain these temperatures with reasonable accuracy. Fig. 3-39 illustrates the temperature distribution through the tube wall. If a tube-bundle is used, the reader is referred to Refs. 2, 3, 4, 12, 13, and the Bibliography for appropriate heat transfer correlations.

6. Determine the overall heat transfer capability, using the calculated values of h_i and h_o

$$\begin{aligned} UA_r &= \frac{1}{\frac{1}{1197 \times 2\pi \times \frac{0.334}{2 \times 12} \times 1} + \frac{0.001}{2\pi \times \frac{0.334}{2 \times 12} \times 1}} \\ &\quad + \frac{\ln\left(\frac{0.500}{0.334}\right)}{2\pi \times 68 \times 1} + \frac{0.003}{2\pi \times \frac{0.500}{2 \times 12} \times 1} \\ &\quad + \frac{1}{1205 \times 2\pi \times \frac{0.500}{2 \times 12} \times 1} \end{aligned}$$

= 19.56 Btu/hr- $^\circ$ F of overall temperature difference per ft long tube

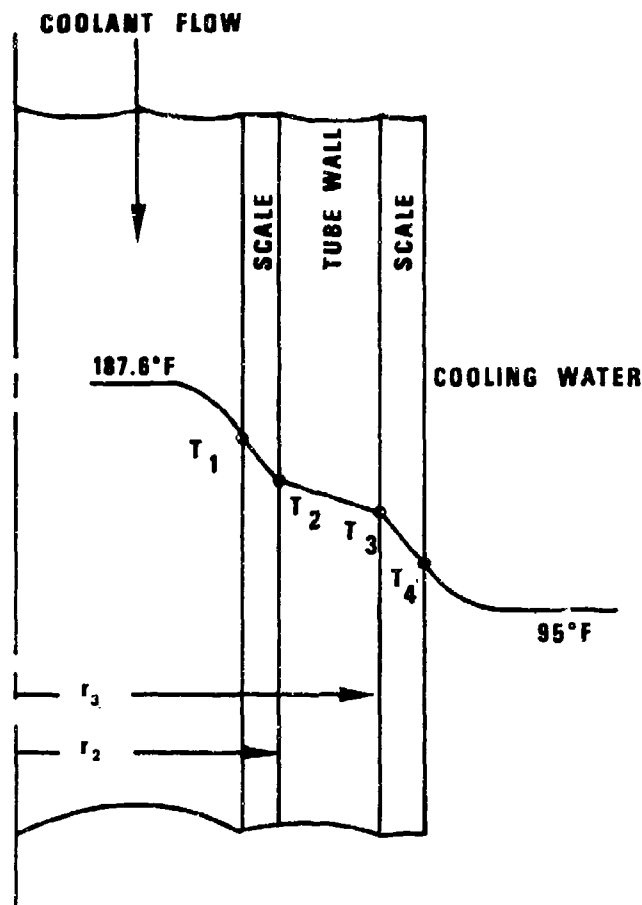

Figure 3-39. Keel Cooler Example Temperature Distribution Through the Tube Wall

7. Determination of tube length per tube:

$$\frac{Q \times 60}{(\text{No. tubes}) \times (\text{ave water temp} - \text{water temp})}$$

$$= \frac{6000 \times 60}{62 \times (187.6 - 95) \times 19.56} = 3.21 \text{ ft}$$

8. The local convection heat transfer coefficient decreases as a function of distance from the entrance edge of the tube. The L/D ratio at which the flow becomes fully developed is related to the Prandtl number Pr

and the Reynolds number Re . Generally, for the flow conditions of this problem, the L/D ratio is approximately 40 when the flow is fully developed (Fig. 6-11 of Ref. 2). Consequently, after the first 40 diameters, or 1.1 ft of the tube, the flow is fully developed. In the entrance region (first 1.1 ft of the tube) the heat transfer coefficient is higher than that predicted by the Colburn equation. Thus, if the entire tube length is considered as fully developed flow region, the heat transfer coefficient obtained is on the conservative side.

9. Determine the flow pressure drop on

AMCP 706-351

the coolant side. Extrapolate from Fig. 7-27, the fluid pressure drop for water flowing through the 3.21 ft long tube is estimated to be 20 ft of water per 100 ft pipe. It should be noted that Fig. 7-27 is for flow through steel or wrought iron pipe only. It can be used only to estimate approximate friction loss for flow through copper tubing. For more accurate analysis, a friction loss chart of copper tubing should be used (Ref. 2 of Chapter 7). Therefore, the water pressure drop through the tubes only is

$$\Delta P = 20/100 \times 3.21 = 0.642 \text{ ft of water}$$

The fluid power *HP* required to push the water through the tubes (62 tubes in parallel) is calculated from

$$HP = \frac{(GPM) \times 0.1337 \times \rho \times \Delta P}{33,000}, \text{ hp (3-27)}$$

where

GPM = fluid flow rate, gal/min

ρ = fluid density, lbm/ft³

ΔP = fluid pressure drop, ft of water

Thus

$$HP = \frac{50 \times 0.1337 \times 60.6 \times 0.642}{33,000} = 0.008 \text{ hp}$$

The total water pressure drop through the system is equal to the water pressure drops through the tubes, manifolds, engine, and connecting ducts.

10. This example illustrates the major steps of keel cooler design. In the actual design process, many parameters might be fixed (such as tube length, maximum space for the cooler, etc.) from other considerations. The designer then must vary other parameters to determine the best possible design.

3-6.9 ARRANGEMENTS OF COOLING SYSTEM COMPONENTS¹

The relative locations of various components in a cooling system depend on the mechanical design, flow resistance, and thermal design constraints.

Design constraints are such that components can be located only at appropriate available space where proper supports and driving mechanisms (if any) can be provided. The coolers should not be located close to hot spots (such as exhaust manifolds and exhaust pipes).

Flow resistance constraints are such that the components should be located so that overall flow resistance is minimum or close to minimum. Sharp turns of flow passages and unnecessary long flow paths should be avoided. Flow distribution over a heat exchanger core should be as uniform as possible. Pressure drop on the suction side of a centrifugal pump should be kept at a low level so that cavitation cannot occur. Therefore, it is not desirable to put too many heat exchangers on the suction side of a coolant pump.

Thermal design constraints also must be considered. Whenever possible, the liquid-to-liquid heat exchanger should be a counterflow configuration to minimize the cooler size. This principle generally does not apply to liquid-to-air coolers (such as radiators and air-to-oil coolers) in vehicle applications.

The following factors determine whether the heat exchangers should be arranged in parallel or series in the cooling medium circuit:

1. For series arrangement. Attention should be directed to the availability of a sufficiently large mean temperature difference

¹ Courtesy of Mr. Edward J. Randle

between the air and each of the two fluids, and the possible high fluid pressure drop.

2. For parallel arrangement. Attention should be directed to the availability of a sufficiently large flow rate for each cooler

3. The designer should consider limitations of space, weight, power, and cost factors to perform an optimization study for any arrangement chosen.

4. For air-cooled engines, the exchangers use air directly as the cooling medium. For liquid-cooled engines, however, various heat exchangers (except the radiator) can use air or coolant as the cooling medium. The designer should determine which type of cooling method, air-cooled or liquid-cooled, should be selected for the coolers.

5. Air-cooled heat exchangers generally are preferred if the penalty of the larger space needed in the airflow path can be tolerated. Another advantage of the air-cooled over the liquid-cooled heat exchanger is the apparent larger mean temperature difference between the hot fluid and the cooling medium. This is particularly true for high capacity transmission oil coolers.

3-7 THERMAL INSULATION

3-7.1 PURPOSE AND APPLICATION

In the engine compartment, surface temperatures of the engine exhaust system are very high. Generally, no cooling is provided to decrease the surface temperatures of exhaust manifolds and exhaust pipes. Heat released by these surfaces either by convection and/or radiation will heat the cooling air and components in the engine compartment. If this unwanted dissipated heat is not reduced or eliminated, overall efficiency of the vehicle cooling system will decrease.

Two methods of reducing exhaust pipe and manifold temperatures are:

1. Insulate the hot surfaces.
2. Fabricate dual concentric pipe exhaust systems.

For surface insulation, high temperature insulation materials are available in powder, blanket, paper, and many other forms. They can be used to cover the surface to be insulated. These materials normally are composed of an asbestos or ceramic fiber base. Because of health hazards from asbestos, the ceramic fiber base insulation material may become the major material used in the future.

Ceramic fiber insulation material has been developed recently that will provide satisfactory performance above 2300°F. It has been used successfully in commercial test vehicles for insulation of emission control devices.

The required thickness δ_i of the insulation material can be determined by

$$\delta_i = \frac{\Delta T_i k_i}{\hat{q}}, \text{ ft} \quad (3-28)$$

where

k_i = thermal conductivity of insulation, Btu/hr-ft²(°F/ft)

\hat{q} = heat flux, Btu/hr-ft²

ΔT_i = temperature drop across insulation, deg F

Thermal conductivity of Fiberfrax ceramic fiber insulation material is shown in Fig. 3-40.

Extreme care should be taken to ensure that surface temperatures of the insulated components are below levels that would cause thermal failure of the material.

In a dual concentric pipe exhaust system, the exhaust pipe is made with double pipe construction. The exhaust gas flows through the inside pipe and cooling air flows in the

AMCP 706-361

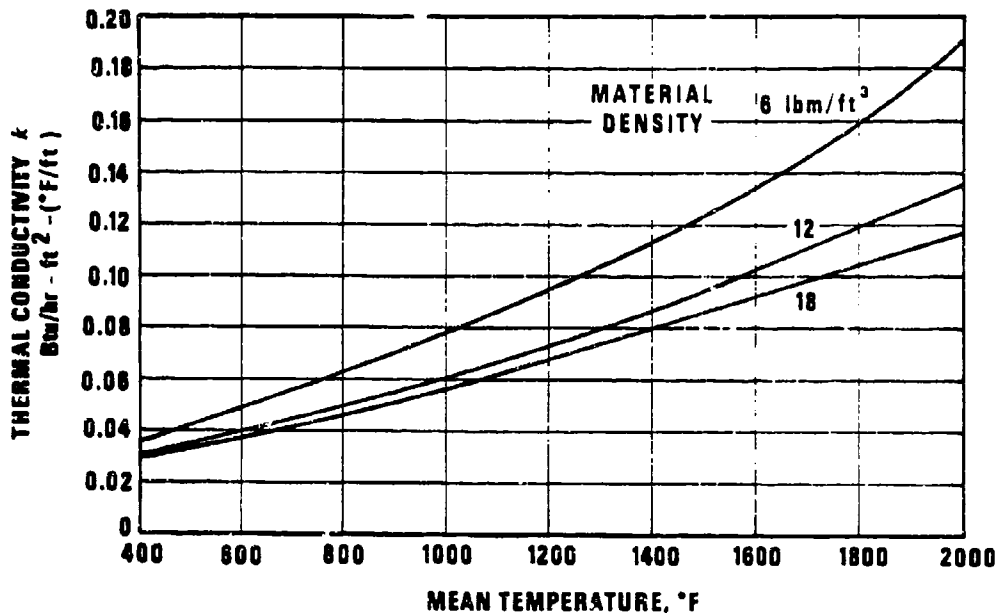

Figure 3-40. Thermal Conductivity of Fiberfrax Ceramic Fiber Insulating Material
 (Courtesy of The Carborundum Company)

annular space surrounding it. An air ejector actuated by the engine exhaust gas is used to provide the cooling airflow.

3-7.2 THERMO PHYSICAL PROPERTIES AFFECTING HEAT TRANSFER

A number of charts showing properties of materials, which are of interest to the designer of vehicle cooling systems, are given. These properties are thermal conductivities, specific heats, viscosities, and densities. Density of gases is not given in a chart because it easily can be calculated to a very good approximation for ground vehicle applications from the following equation:

$$\rho = \frac{PM}{RT_g} \text{ , lbm/ft}^3 \quad (3-29)$$

where

M = molecular weight of gas, lbm/lbm-mole

P = absolute gas pressure, lbf/ft²

R = universal gas constant, 1545 ft-lbf/lbm-mole-°R

T_g = gas temperature, °R

All other properties are given as functions of temperature. Their dependence on pressure may be neglected for most ground vehicle applications. Fig. 3-41 gives thermal conductivities of several metals. Note the difference between copper, iron, and stainless steel. Figs. 3-42 and 3-47 give the properties of air at 1 atm. Fig. 3-43 gives the properties of liquid water. Fig. 3-44 gives the properties of hydraulic fluid, MIL-H-5606. Fig. 3-45 gives the properties of typical engine oil. Note the strong dependence on the viscosity of liquids, especially oil, on temperature. Thermo physical properties of ethylene glycol-water solutions are shown in Fig. 3-46 and Table 3-6.

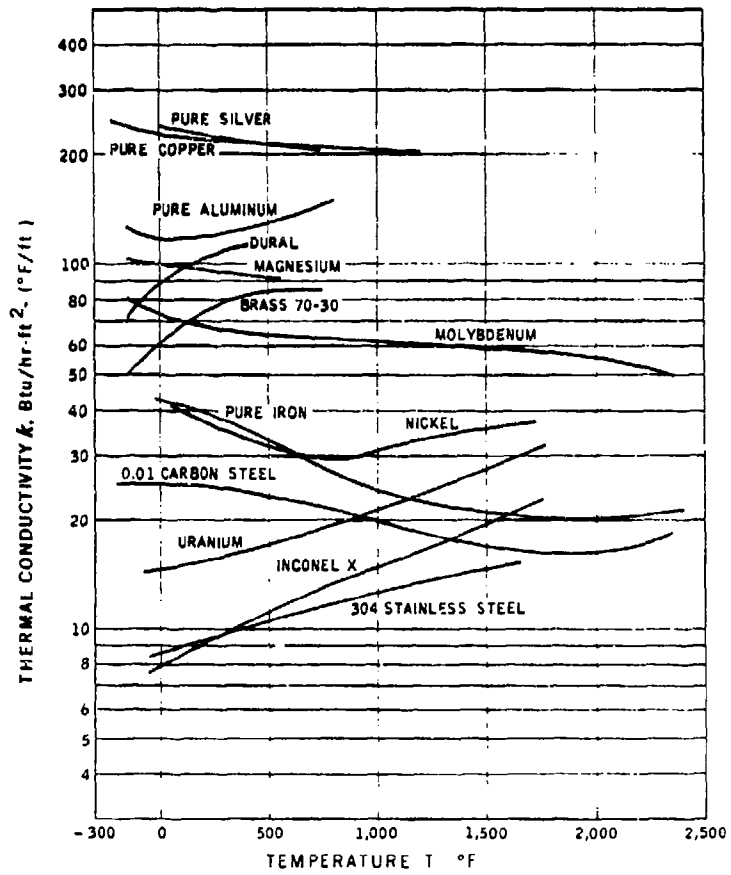
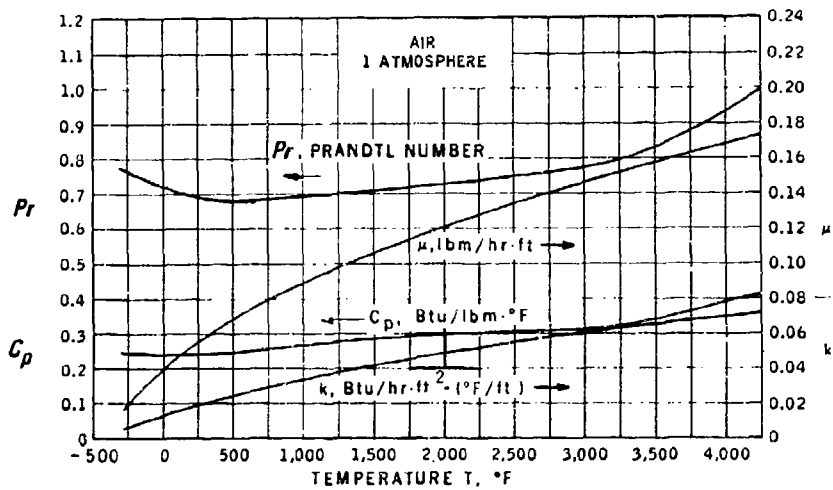

Figure 3-41. Conductivity of Metals (Ref. 2) (From Compact Heat Exchangers by W. Kays and A. London, 1964. Used with permission of McGraw-Hill Book Company.)

AMCP 706-361



(A) PROPERTIES OF AIR

(From Compact Heat Exchangers by W. Kays and A. London, 1964. Used with permission of McGraw-Hill Book Company)

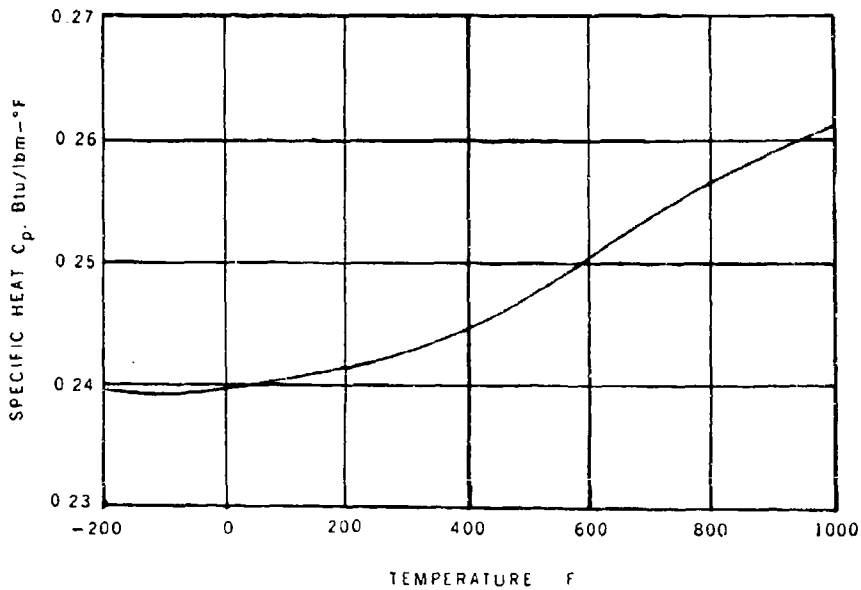

(B) SPECIFIC HEAT OF AIR C_p AT 1 ATMOSPHERE PRESSURE

Figure 3-42. Properties of Air

AMCP 706-361

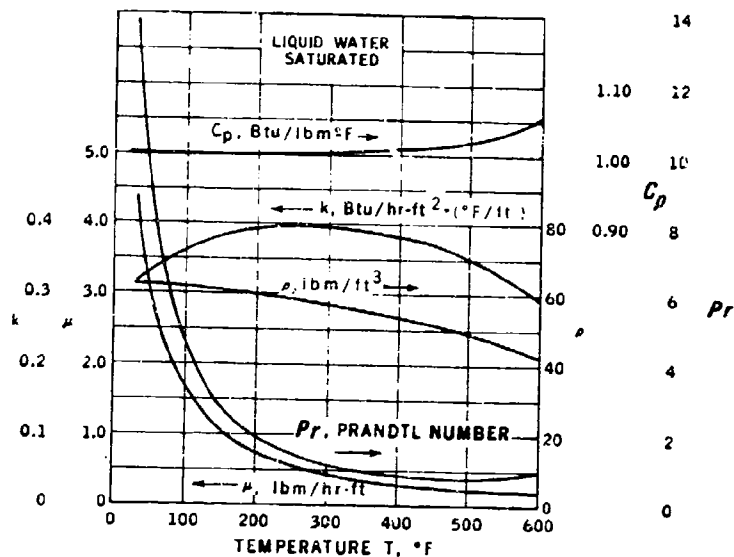

Figure 3-43. Properties of Water (Ref. 2) (From Compact Heat Exchangers by W. Kays and A. London, 1964. Used with permission of McGraw-Hill Book Company.)

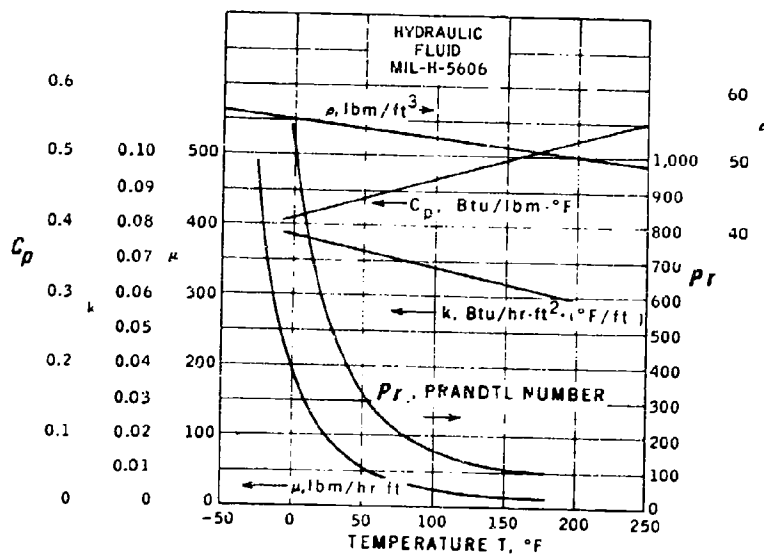

Figure 3-44. Properties of Hydraulic Fluid (Ref. 2) (From Compact Heat Exchangers by W. Kays and A. London, 1964. Used with permission of McGraw-Hill Book Company.)

AMCP 708-361

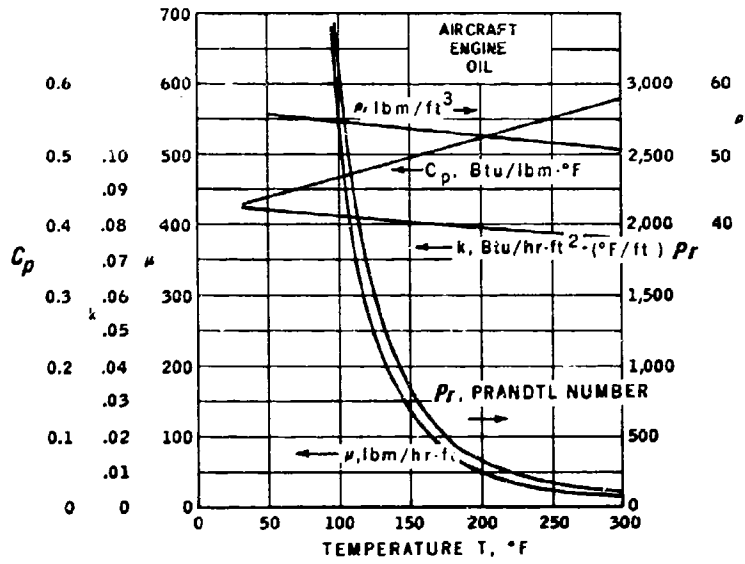
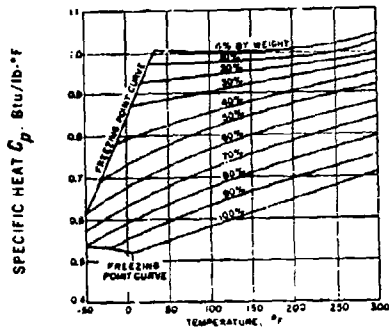
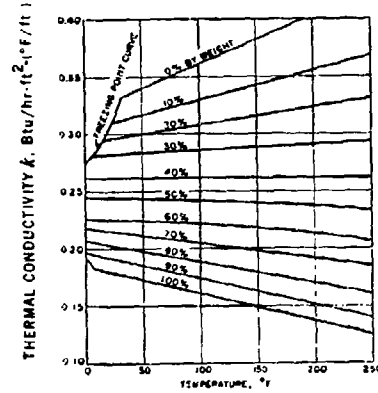

Figure 3-45. Properties of Aircraft Engine Oil (Ref. 2) (From Compact Heat Exchangers by W. Kays and A. London, 1964. Used with permission of McGraw-Hill Book Company.)



(A) SPECIFIC HEAT OF AQUEOUS SOLUTIONS OF ETHYLENE GLYCOL



(B) THERMAL CONDUCTIVITY OF AQUEOUS SOLUTIONS OF ETHYLENE GLYCOL

(A & B - Reprinted By Permission From ASHRAE Handbook of Fundamentals 1972) (Ref. 19)

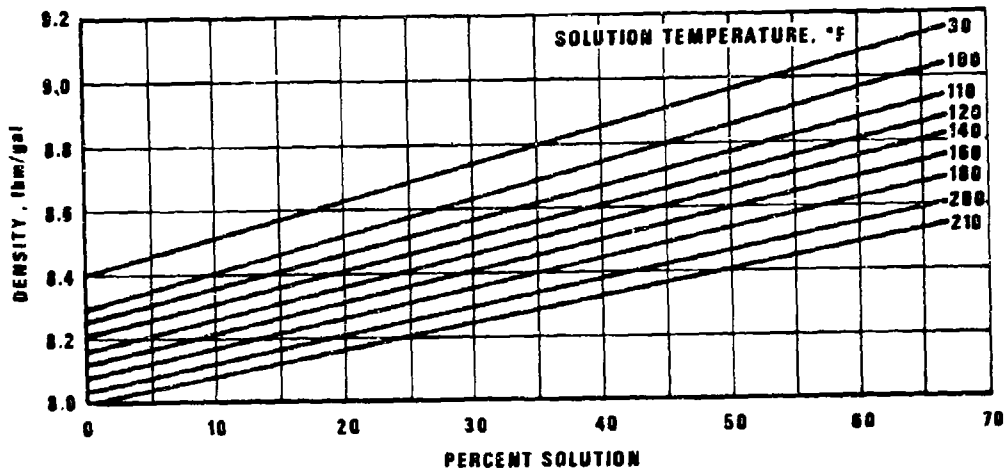

(C) DENSITY OF AQUEOUS SOLUTIONS OF ETHYLENE GLYCOL

Figure 3-46. Thermo Physical Properties of Ethylene Glycol-water Solutions (Percent by Weight)

AMCP 708-361

TABLE 3-6

PROPERTIES OF AQUEOUS ETHYLENE GLYCOL (50/50% BY VOLUME)

TEMPERATURE	DENSITY	SPECIFIC HEAT	VISCOSITY	THERMAL CONDUCTIVITY
T, °F	ρ , lbm/ft ³	C _p , Btu/lbm-°F	μ , lbm/ft-hr	k, Btu/hr-ft ² (°F/ft)
60	66.79	0.774	11.35	0.2383
70	66.58	0.781	9.38	0.2383
80	66.40	0.788	7.86	0.2382
100	65.96	0.803	5.72	0.2377
120	65.51	0.815	4.33	0.2371
140	65.07	0.828	3.39	0.2358
160	64.57	0.838	2.72	0.2346
180	64.06	0.848	2.24	0.2338
200	63.56	0.857	1.88	0.2319
220	63.00	0.867	1.60	0.2295
240	62.43	0.876	1.39	0.2275
260	61.81	0.885	1.21	0.2246
280	61.19	0.895	1.08	0.2211
300	60.56	0.905	0.96	0.2187

Calculated from *Properties of Ethylene Glycol and its Aqueous Solutions*,
 by C. S. Crago, National Bureau of Standards

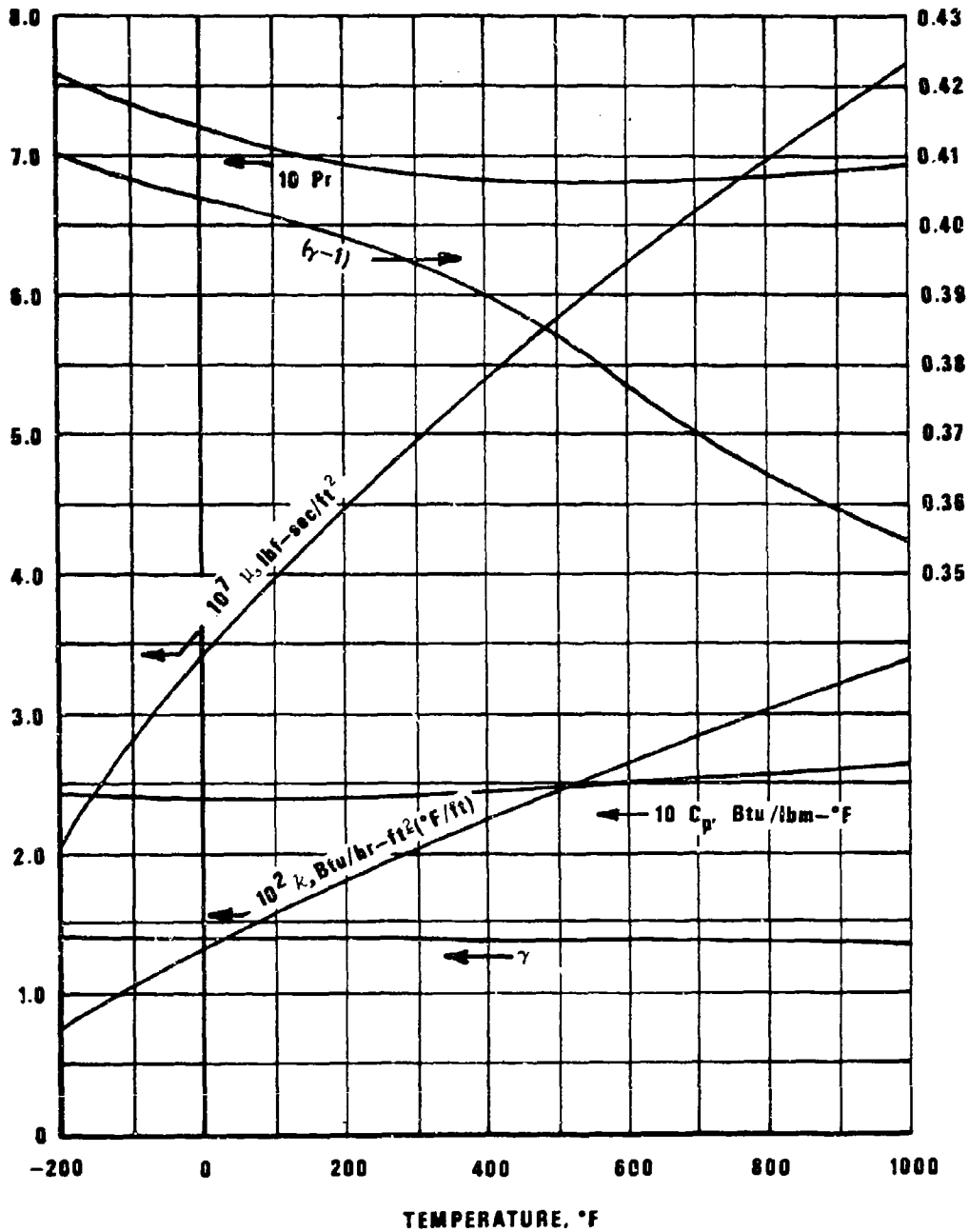

Figure 3-47. Properties of Air at Standard Conditions (Ref. 24)
 (Reprinted with permission, copyright © Society of Automotive Engineers, Inc., 1969, all rights reserved.)

AMCP 708-361

REFERENCES

1. *Standards of the Heat Exchanger Institute, Tubular Exchanger Section*, Tubular Exchanger Manufacturers Assn., New York, N. Y., 1968.
2. W. M. Kays and A. L. London, *Compact Heat Exchangers*, McGraw-Hill Book Co., New York, N. Y., 1964.
3. A. P. Fraas and M. N. Ozisik, *Heat Exchanger Design*, John Wiley and Sons, New York, N. Y., 1965.
4. Donald Q. Kern and Allan D. Krans, *Extended Surface Heat Transfer*, McGraw-Hill Book Company, New York, N. Y., 1972.
5. F. A. Hirsch, *Feasibility of Fan Drive Devices and Cooling System Control*, Report No. 808 Continental Aviation and Engineering Corp., Detroit, Mich., 1959.
6. *Heat Transfer Units*, Catalog HE-500, Harrison Radiator Division, General Motors Corporation, Lockport, N. Y.
7. J. C. Basiletti, *Main Battle Tank Engine Development-AVCR-1100 Engine*, Report No. 1020, Continental Aviation and Engineering Corp., Detroit, Mich., 1966.
8. William H. McAdams, *Heat Transmission*, Second Edition, McGraw-Hill Book Co., New York, N. Y., 1942.
9. MIL-R-45306, *Radiators, Engine Cooling, Industrial*.
10. *Fixed Tube Bundle Heat Exchangers*, Catalog 1272, Young Radiator Company, Racine, Wisconsin.
11. P. K. Beatenbough, *Engine Cooling Systems for Motor Trucks*, Paper No. SP284, SAE, New York, N. Y., 1966.
12. R. A. Greenkorn and D. P. Kessler, *Transfer Operations*, McGraw-Hill Book Co., New York, N. Y., 1972.
13. William H. McAdams, *Heat Transmission*, 3rd Edition, McGraw-Hill Book Co., New York, N. Y., 1954.
14. Theodore Baumeister, Editor, *Marks' Standard Handbook for Mechanical Engineers*, McGraw-Hill Book Co., New York, N. Y., 1967.
15. TM 55-1930-206-10, *Operators Manual: Lighter, Amphibious, Resupply, Cargo (LARCXV) Self-propelled, Diesel, Aluminum, 15 Ton*, November 1969.
16. James D. Morse, *Engine Cooling Radiators*, Paper No. 670525, SAE, New York, N. Y., 1967.
17. TM 750-254, *Tactical Vehicle Cooling Systems*.
18. *Cooling of Detroit Diesel Engines*, Engineering Bulletin No. 28, Detroit Diesel Allison Division, General Motors Corp., Indianapolis, Indiana, May 1967.
19. *Handbook of Fundamentals*, American Society of Heating, Refrigeration, and Air Conditioning Engineers, New York, N. Y., 1972.
20. *SAE Handbook Part 2*, Standard No. J631a, Society of Automotive Engineers Inc., New York, N. Y. 1974.
21. Benjamin Gebbart, *Heat Transfer*, 2nd Edition, McGraw-Hill Book Co., New York, N. Y., 1971.
22. Alan J. Chapman, *Heat Transfer*, 3rd Edition, Macmillan Company, New York, N. Y., 1974.

23. Warren M. Rohsenow and H. Y. Choi, *Heat Mass and Momentum Transfer*, Prentice-Hall, New York, N. Y., 1961.

24. *Aerorpace Applied Thermodynamics Manual*, SAE, New York, N. Y., 1969.

BIBLIOGRAPHY

R. M. Drake, *Introduction to Heat and Mass Transfer*, McGraw-Hill Book Co., New York, N. Y., 1959.

J. P. Holman, *Heat Transfer*, 3rd Edition, McGraw-Hill Book Company, New York, N. Y., 1972.

Hilbert Schenck, *Heat Transfer Engineering*, Prentice-Hall, New York, N. Y., 1959.

Frank Kreith, *Principle of Heat Transfer*, 3rd Edition, International Textbook Company, 3rd Edition, New York, N. Y. 1972.

Warren M. Rohsenow and James P. Harnett, *Handbook of Heat Transfer*, McGraw-Hill Book Company, New York, N. Y., 1973.

J. H. Perry, *Chemical Engineers' Handbook*, 5th Edition, McGraw-Hill Book Company, New York, N. Y., 1973.

E. R. G. Eckert and R. M. Drake, *Analysis of Heat and Mass Transfer*, McGraw-Hill Book Company, New York, N. Y., 1972.

Dale S. Davis, *Nomography and Empirical Equations*, Reinhold Publishing Corporation, New York, N. Y., 1955.

4-0 LIST OF SYMBOLS

<i>A</i>	= area, ft ²
<i>CFM</i>	= flow rate, ft ³ /min
<i>D</i>	= diameter, ft
<i>K_c</i>	= conversion constant, 32.2 lbm-ft/lbf-sec ²
<i>HP</i>	= horsepower, hp
<i>N</i>	= speed; rev/min, rpm
<i>N_s</i>	= specific speed, a numerical rating
<i>p</i>	= pressure, microbar
<i>P</i>	= pressure; ft water, ft air, in. water, psi, in. Hg
<i>PWL</i>	= sound power level, dB
<i>r</i>	= ratio, dimensionless
<i>SPL</i>	= sound pressure level, dB
<i>T</i>	= temperature, °F
<i>V</i>	= fluid velocity; ft/min, ft/sec
<i>w</i>	= flow rate, lbm/min
<i>W</i>	= power, watts
<i>ΔP</i>	= pressure differential; in. water, ft air
<i>η</i>	= efficiency, percent
<i>ρ</i>	= density, lbm/ft ³

Subscripts

<i>a</i>	= air, actual, condition "a"
<i>as</i>	= air static
<i>e</i>	= exhaust
<i>eq</i>	= equivalent

AMCP 706-381

LIST OF SYMBOLS (Cont'd.)

f = fan
out = outlet
s = static, specific
t = tip, total

Definition of Terms (See Preface)

Mass lbm, pounds mass
Force lbf, pounds force
Length ft, in., feet, inches
Time sec, min. hr; seconds minutes hours
Thermal energy Btu, British Thermal Unit

CHAPTER 4

AIR MOVING DEVICES

Basic fan types and characteristics are presented and fan selection principles are discussed with various examples provided. Types of fan drives are discussed and compared, and exhaust ejectors are described. Performance curves of various fans are included in Appendix B.

4-1 INTRODUCTION

Ambient air is the ultimate heat sink for the cooling system of all ground operated vehicles. Heat dissipated by the engine and other components, must be transferred eventually to the atmospheric air (except when operating under water). Ram airflow rate is not sufficient for cooling purposes when the vehicle is operated at low speeds or is idling. For combat military vehicles, the ram airflow rate is too low for cooling purposes even when the vehicle is operating at top speed. Fans are needed to provide the cooling air necessary for the vehicle cooling system and forced-ventilation of the vehicle compartments.

4-2 FANS

Fans used in vehicles consist of a rotating impeller surrounded by a stationary housing. The air moved by the rotating impeller creates a pressure differential to produce flow. Fans are similar, in principle, to blowers, compressors, and pumps. The distinction between them is made on the basis of the type of fluid and the amount of pressure change. Pumps usually are associated with liquids, while the others are associated with gases. Compressors, blowers, and fans are associated with high, medium, and low fluid pressure changes, respectively.

The fluid pressure change from inlet to

outlet of the fans considered here is less than 10 percent, referred to barometric pressure as the datum (equivalent to a density change of less than 7 percent), therefore, the fluid flow may be assumed to be incompressible. Fans are classified according to the flow direction (other than tangential) inside the rotor as:

1. *Centrifugal.* Flow direction in the rotor is mostly radial (directed away from axis of rotation)
2. *Axial.* Flow direction is mostly axial (directed parallel to axis of rotation)
3. *Mixed.* Flow direction is partly radial and partly axial.

4.2.1 CENTRIFUGAL FANS

A centrifugal fan consists of a rotor with blades within a scroll type housing and is driven by either a belt drive or a direct connection. The number of blades depends on various design considerations. These blades form flow channels between the inlet at the smaller diameter and the outlet at the larger diameter.

Centrifugal fans develop static pressure rise principally through the action of centrifugal force as the air is thrown from the inlet to the impeller periphery. Secondary conversion of kinetic energy (air velocity) to static pressure takes place in the housing or scroll. At the

AMCP 708-381

inlet to the rotor, the blades are inclined in the direction of the relative velocity of the incoming flow so as to present a minimum resistance to the flow. At the outlet, the inclination of the blade also is significant. The operating characteristics—such as the flow capacity, pressure generation, power requirement, operating speed, and efficiency, for both normal and off design points—are dependent very strongly on the inclination of the blades at the outlet.

The characteristics of centrifugal fans also depend strongly on the angle between the blade tip and the tangential direction of rotation. It is customary to classify fans according to the inclination of the blade tips as shown in Fig. 4-1. These classifications are:

1. Forward curved blade centrifugal fan, Fig. 4-1(A)
2. Backward curved blade centrifugal fan, Fig. 4-1(B)
3. Radial blade centrifugal fan, Fig. 4-1(C)

The selection of the fan depends on the application for which it is used.

4-2.1.1 Forward Curved Blade Fans.

Forward curved blade fans have tips inclined in the direction of impeller rotation. This type of centrifugal fan has a major portion of the impeller input energy in the form of kinetic energy.

This type of fan gives the highest fluid pressure head for a given rotor size, however, most of the fluid pressure head appears as a dynamic head at the rotor exit. The conversion of the dynamic head to static head has to take place in the scroll housing, and is inherently less efficient. Change of performance due to scroll design is significant.

The ideal fluid pressure head developed by forward curved blades increases as the flow

through the fan increases; however, due to frictional and conversion losses, the actual fluid pressure head may even decrease with the flow. Typical characteristics of the forward curved blade fan are shown in Fig. 4-1(A).

4-2.1.2 Backward Curved Blade Fans

Backward curved blade fans have blade tips inclined away from the direction of rotation. It is capable of higher efficiencies than other centrifugal fans and is, therefore, more suitable where power input is extremely important. Housing design is not as critical as the forward curved blade design, since a greater percentage of static pressure is developed within the rotor.

This type of fan gives the lowest head for equal size rotors at the same speed in the airflow rate region generally used for vehicle applications. Backward curved blades must be operated at a much higher speed of rotation than forward curved ones if the same static pressure rise is to be produced in each case. In some cases, the higher required speed may be an advantage because of a possible direct connection to the fan drive. Fan impellers that have properly designed backward curved blades operate at higher efficiency and have nonoverloading (horsepower curve does not increase near free delivery) power characteristics. They also offer the advantage of wide ranges of capacity at constant speed with small changes in the power requirements. Backward curved blade fans usually have stronger construction to provide for the characteristically high operating speeds. This design is used where stability, heavy duty, operating efficiency, and nonoverloading characteristics are of primary importance, and size is of lesser importance. Typical characteristics of fans with backward curved blade tips are given in Fig. 4-1(B). In this case, the ideal fluid pressure head produced by the rotor decreases with increasing flow capacity.

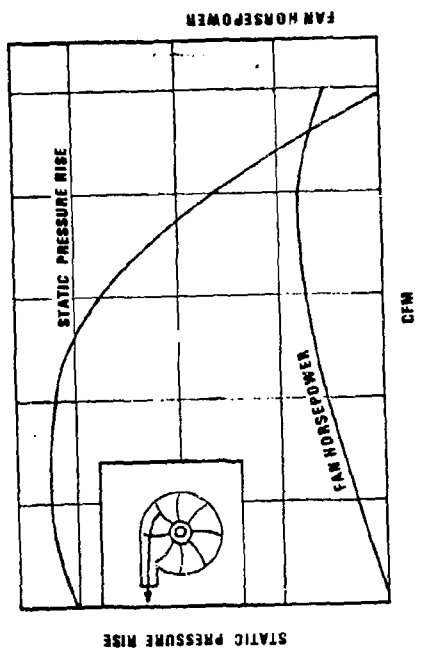

(B) BACKWARD CURVED BLADE CENTRIFUGAL FAN

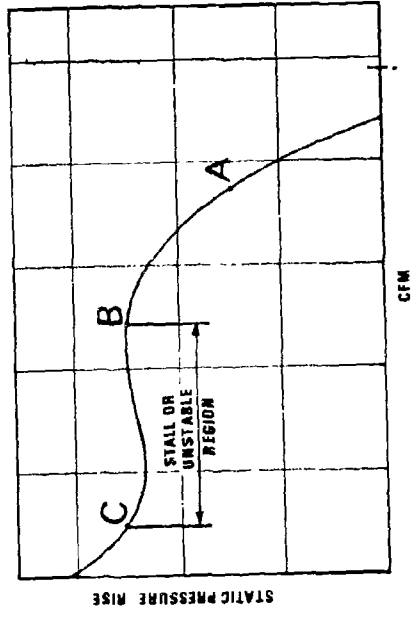

(D) AXIAL FLOW FAN

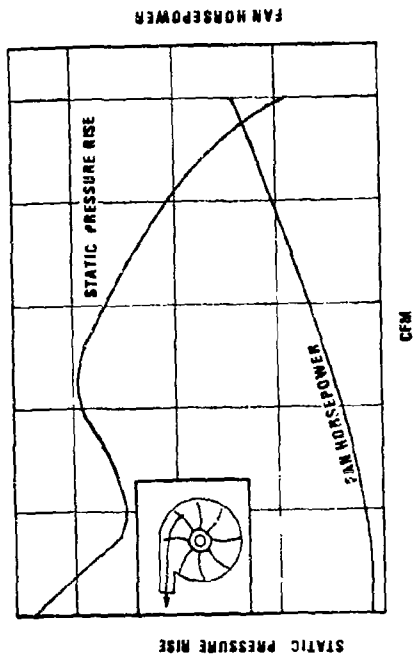

(A) FORWARD CURVED BLADE CENTRIFUGAL FAN

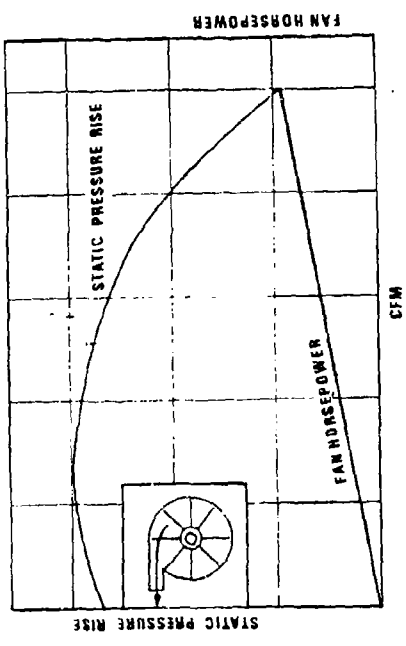

(C) RADIAL BLADE CENTRIFUGAL FAN

Figure 4-1. Characteristics of Centrifugal and Axial Flow Fans

AMCP 708-381

4-2.1.3 Radial Blade Fans

Radial blade fans have straight blades that are to a large extent self-cleaning, making them suitable for material handling or for moving particle-laden air. Radial bladed impellers are of simple construction and have a small width to diameter ratio. They usually have a characteristic whine, but in performance they are stable over the entire operating range. Typical characteristics for radial blade fans are shown in Fig. 4-1(C).

4-2.1.4 Off-design Characteristics

There is only one size fan of each type that will operate at the speed point of maximum efficiency for any given flow capacity. A smaller size fan could produce the same capacity at a higher speed or a larger size fan could produce the same capacity at a slower speed. In either of these cases for a defined capacity, their efficiency would be lower than that of the optimum sized fan. This fact applies to all fan designs and emphasizes the fact that all designs are matched in order to have an optimized air-flow for the particular installation.

Fans operating to the right of the maximum efficiency point are undersized and those operating to the left of the maximum efficiency point are oversized. Generally, fans operating to the right of the maximum efficiency point (undersized fans) are more stable and may be a more economical choice even with the penalty of lower efficiency.

4-2.2 AXIAL FLOW FANS

The general flow direction of an axial flow fan is, as the name suggests, predominantly axial, and is parallel to the axis of rotation of the fan rotor. In axial flow fans, the fluid particles emerge from the rotor at different radii with different velocities. In order to maintain the same theoretical fluid pressure head at different radii of the axial fan, it is necessary to shape the blade in such a manner

that the change in the tangential velocity is inversely proportional to the radius.

Axial flow fans are usually high capacity, low fluid pressure head per stage, turbomachines. The number of rotor blades varies greatly and may be as low as two for high capacity low head fans. When higher heads are required, the number of blades must be increased. A housing may be used to direct the air and convert part of the tangential component velocity head into static pressure head.

Fluid pressure head produced is proportional to lift produced by the rotating blades of the impeller in axial fans. For any blade or airfoil, there is a point below which the impeller stalls and the pressure decreases with decreased flow (see point B, Fig. 4-1(D)). This accounts for the dip in the performance curves for axial flow fans. It is usually undesirable to operate in the region of point B to point C where flow pulsations, increased noise, and a decrease in efficiency occurs. Stable performance and maximum efficiency occur in the range to the right of point B.

There are three types of axial flow fans: propeller, tube-axial, and vane-axial. Impellers for these fans are made up of blades stamped from sheet metal, cast, or fabricated into airfoil sections.

4-2.2.1 Propeller Fans

A propeller fan consists of a propeller or a disc type blade and includes the driving mechanism supports for belt drive or direct connection. A propeller fan, with no housing at all, is called a free fan or an open propeller fan (Fig. 4-2). Due to back flow at the hub and the blade tips, the output of a propeller fan is greatly reduced and its efficiency is low. The advantage of an open propeller fan is its low cost and simple construction. Normally, it is used in automobiles and military vehicles when lower static pressure rise is sufficient.

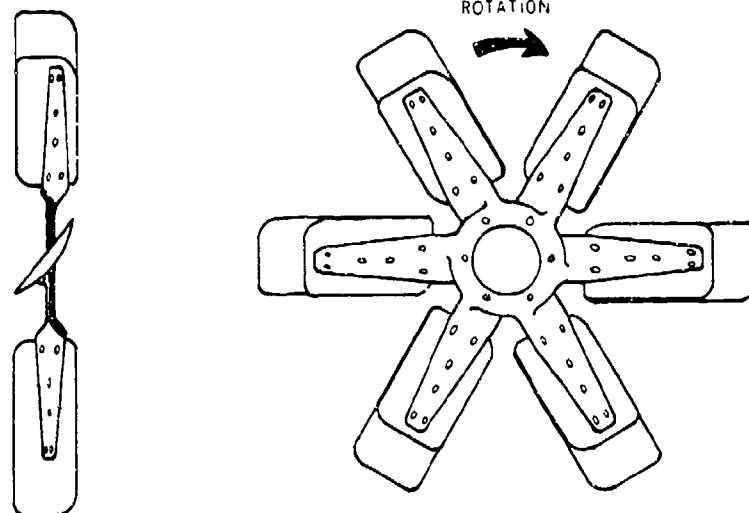

Figure 4-2. Automotive Propeller Type Fan

Propeller fans may have a ring at the tip of the blades (Fig. 4-3(A)), or be set within a ring mounting (Fig. 4-3(B)), or in a plate mounting (Fig. 4-3(C)). Any of these measures may improve substantially the capacity, head, and efficiency of the fan (see Ref. 1).

4-2.2.2 Tube-axial Fans

A tube-axial fan consists of a propeller rotating in a cylindrical housing that provides driving mechanism supports. The tube-axial fan generally implies less turbulent flow patterns, more efficient airfoil blades, and closer tip clearance with resulting high efficiency and greater pressure capabilities.

4-2.2.3 Vane-axial Fans

A vane-axial fan is basically a tube-axial fan with guide vanes located upstream and/or downstream from the impeller. The purpose of the guide vanes is to reduce rotary motion imparted to the air by the impeller, thereby improving the efficiency and pressure characteristics of the fan and reducing the fan noise level. The guide vanes aid in converting the tangential component of the dynamic head of

the fluid flow into a static pressure head.

Inlet guide vanes are installed upstream of the fan rotor and are designed to induce swirl opposite to the direction of rotation. The amount of swirl is established at the fan design point to produce only axial flow of the air leaving the fan. This usually will produce higher overall efficiency because there is no loss of kinetic energy incurred with air swirl at the fan discharge.

The use of outlet guide vanes produces results similar to the inlet guide vanes except that the tangential velocity component of the air leaving the rotor is removed by the outlet vanes to produce axial flow only. Fan noise level also can be reduced by the use of outlet guide vanes. Outlet diffuser guide vanes are shown in Fig. 4-3(D).

When higher fluid pressure head is needed, both inlet and outlet guide vanes are used. Both also are used for staging. A divergent diffuser may be used for higher performance fans to reduce the axial velocity component (Fig. 4-3(D)). The vane-axial fan when incorporated in an appropriate housing, such as an aerodynamically well designed inlet and

AMCP 706-361

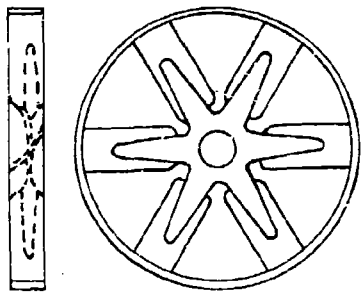

(A) PROPELLER TYPE WITH TIP RING

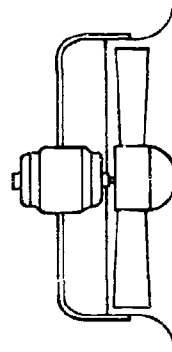

(B) PROPELLER TYPE WITH RING MOUNTING

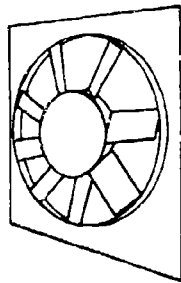

(C) PROPELLER TYPE WITH PLATE MOUNTING

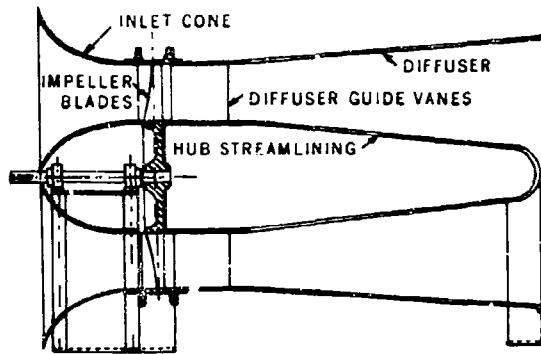

(D) VANE-AXIAL WITH DIFFUSER
(Courtesy of Buffalo Forge Co.)

Figure 4-3. Types of Axial Flow Fans

outlet diffuser, may provide the most efficient operation.

4-2.3 CENTRIFUGAL AND AXIAL FLOW FAN COMPARISON

Centrifugal and axial flow fans possess individual characteristics that must be con-

sidered in selection of the proper fan for a specific application. There is only one value of specific speed for best efficiency regardless of the size for any one fan design. The general desirable characteristics for the two types of fans are:

1. Centrifugal fans:

- a. Stable performance at low flow rates
 - b. 90-deg airflow direction change from inlet to outlet
 - c. Highest fluid static pressure head developed.
2. Axial fans:
- a. Highest efficiency
 - b. In-line airflow
 - c. Compact size
 - d. Drive can be cooled by airstream.

4-2.4 MIXED FLOW FANS

Mixed flow fans have a rotor that has axial and radial components of airflow. The blade configuration is such that the air is turned within the blade and discharged radially. The air may be discharged by a scroll similar to the centrifugal fan or discharged directly. Mixed flow fans are used for specific applications requiring pressure and flow characteristics between the centrifugal and axial flow fans as shown in Figs. 4-4 and 4-5. A detailed description of mixed flow fans is contained in Appendix B.

4-2.5 FLEXIBLE BLADE FANS

A means of reducing cooling fan drive power requirements, in addition to reducing fan noise at high speed, is to use a fan with flexible blades. With this type of fan design, the pitch of the blades decreases as fan speed increases. This pitch change is produced by the twisting action of the blades caused by centrifugal force. The result of this action is that each blade moves less air per revolution thus reducing the power requirement and fan noise at high speeds.

4-3 COOLING FANS FOR MILITARY VEHICLES

Some typical cooling fans used in military vehicles are shown in Table 4-1. Table 4-2 shows some typical cooling fans used in commercial trucks. Drawings and performance curves for these fans are included in Appendix B.

4-4 TOTAL PRESSURE DIFFERENTIAL DEVELOPED BY A FAN

Fluid pressure generally is expressed in three different forms:

1. Static Pressure P_s . This is the pressure sensed by a probe moving with the same velocity as the fluid stream. Practically, it is measured by a pressure probe located normal to the fluid stream

2. Dynamic or Velocity Pressure P_v . This is the static pressure rise that a fluid experiences when it is reversibly brought to rest. This is calculated as $\rho_a V^2 / (2g_c)$

3. Total Pressure P_t . This is the pressure of a moving fluid if it is reversibly brought to rest. It is equal to the sum of the static and dynamic pressures.

The energy equation for incompressible flow is expressed by Bernoulli's equation

$$P_s + \rho_a \left(\frac{V^2}{2g_c} \right) = P_s + P_v = P_t$$

$$= \text{Constant} \quad (4-1)$$

where

g_c = conversion constant, 32.2 lbm-ft/lbf-sec²

P_v = velocity pressure, lbf/ft²

AMCP 706-361

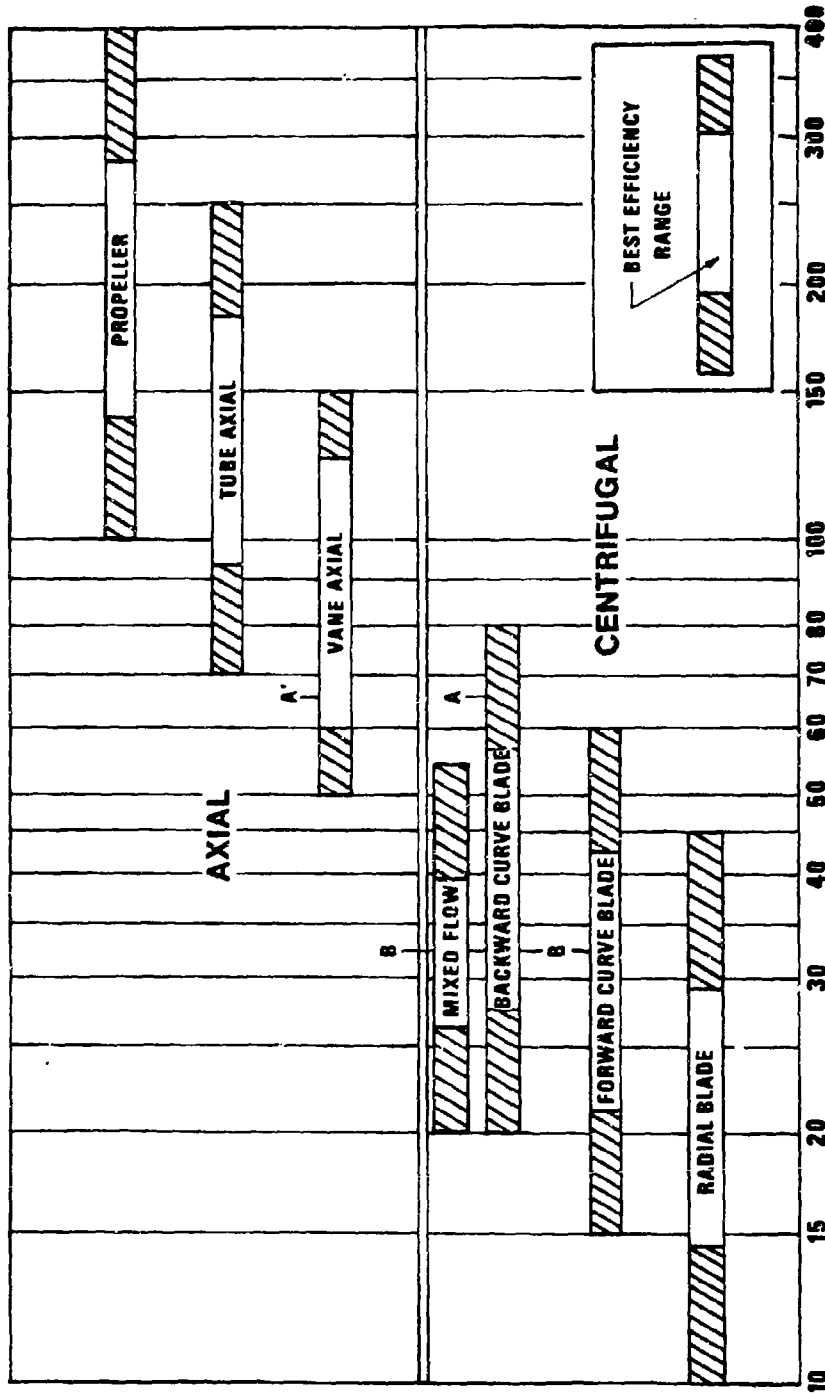

Figure 4-4. Approximate Specific Speed Ranges of Various Types of Air Moving Devices

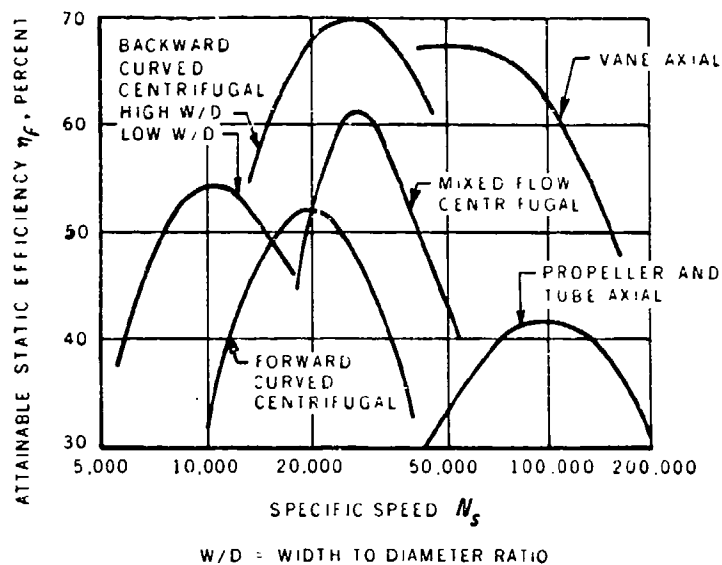

Figure 4-5. Fan Specific Speed vs Static Efficiency (Ref. 11)
 (Courtesy of Machine Design)

TABLE 4-1

MILITARY VEHICLE COOLING FANS

MODEL	VEHICLE	FAN APPLICATION	FAN P/R	PERFORMANCE CURVE (See Appendix B)
M803	Main Battle Tank (Experimental)	Engine/Transmission Oil Cooler	18460-182	
		7.62 mm Gun Purge	500702-3506	
		Turret Cooling	X702-288	
		Turret Cooling	500702-5083	
M109	Self-propelled Howitzer	Engine Cooling Alternate Unit	500706-3324	
		Personnel Ventilation	500702-4881	
M551	Armored Assault	Engine Cooling	500706-4520	
		Personnel Ventilation	500702-5351	
M107	Self-propelled Gun	Engine Cooling	500706-4062	
M110	Self-propelled Howitzer			
M578	Armored Recovery			
M116	Amphibious Cargo Carrier	Engine Cooling	500706-3272	
M44	Truck, Cargo	Engine Cooling	10889866	
Sweden's "S" Tank	Battle Tank	Scavenger Fan	18921-1	

AMCP 706-361

TABLE 4-2

DETROIT DIESEL ENGINE COOLING FANS

Fan Part Number		Fan Blade			B		S		Drive Ratio	HP	Characteristic Performance Curve Number*	Engine Model Usage
		Dia. in.	No.	Proj Width, in.	R	L	R	L				
G.M.	Schwitzer											
5121176	AF-10049	18	5	2 3/16		X	X		1.25	15	F1-0000-00-52	3-53
5120005	BF-06770	18	6	2 3/8	X		X	X	1.25	4	F1-0000-00-54	3-53
5119011	LFO-9810	22	5	2		X	X	X	1.25	17	F1-0000-00-58	3, 4-53
5119014	LFO-9813	22	5	2	X		X	X	1.25	17	F1-0000-00-58	3, 4-53
5119011	LFO-9810	22	5	2		X	X	X	1.00	15	F1-0000-00-58	3, 4-53
5119014	LFO-9813	22	5	2	X		X	X	1.00	15	F1-0000-00-58	3, 4-53
5119012	LFO-9811	22	5	2 3/4	X	X	X	X	1.00	16	F1-0000-00-59	3, 4-53
5119013	LFO-9812	22	5	2 3/4	X	X	X	X	1.00	16	F1-0000-00-59	3, 4-53
5173871	A-F11586	22	6	2 1/4	X		X	X	1.10	17	F1-0000-00-73	6V-53
5173872	F-11585	22	6	2 1/4		X	X	X	1.10	17	F1-0000-00-73	6V-53
5124701	AF-10383	24	6	2 3/8	X	X	X	X	1.00	6	F1-0000-00-61	3, 4-53
5126795	AF-10505	24	6	2 3/8	X	X	X	X	0.85	4	F1-0000-00-61	3-53
5100183	AF-11100	24	6	2 3/8	X		X	X	1.10	7	F1-0000-00-61	6V-53
5140100	A-913372	24	6	2 3/8	X		X	X	1.00	6	F1-0000-00-61	3, 4-53, 3, 4-71
5171228	LF-07992	26	6	2 3/4	X	X	X	X	0.77	5	F1-0000-00-64	8V-53
5171229	LF-07993	26	6	2 3/4	X	X	X	X	0.77	5	F1-0000-00-64	8V-53
5175738	LF-08377	28	6	3 1/4	X		X	X	0.77	18	F1-0000-00-67	8V-53
5177871	LF-08421	28	6	3 1/4	X		X	X	0.77	18	F1-0000-00-67	8V-53
5175738	LF-08377	28	6	3 1/4	X	X	X	X	1.25	20	F1-0000-00-67	6, 6V, 8V-71
5177871	LF-08421	28	6	3 1/4	X	X	X	X	1.25	20	F1-0000-00-67	4, 6, 6V, 8V-71
5137483	A-912960	32	8	2.33		X	X	X	1.00	13	F1-0000-00-85	8V-71
9178064	BF0-9455	32	8	3.59		X	X	X	0.60	8	F1-0000-00-68	8V-71
9178064	BF0-9455	32	8	3.59		X	X	X	0.75	12	F1-0000-00-68	12V-71
9178064	BF0-9455	32	8	3.59		X	X	X	0.85	14	F1-0000-00-68	6V, 8V, 12V-71
5109396	A-911086	32	8	3 5/8	X		X	X	0.80	20	F1-0000-00-84	6V, 8V-71
5122912	BF-10020	34	8	3.17		X	X	X	0.75	12	F1-0000-00-69	8V-71
5122913	BF-09991	34	8	3	X		X	X	0.75	12	F1-0000-00-69	8V-71
5135567	A-912264	34	8	3		X	X	X	0.75	14	F1-0000-00-69	8V-71
5162666	LF-10804	36	8	3 1/16	X		X	X	0.67	11	F1-0000-00-70	8V, 12V-71
5189119	BF-09208	36	8	3 1/16	X	X	X	X	0.67	11	F1-0000-00-70	8V, 12V-71
5162666	LF-10804	36	8	3 1/16	X		X	X	0.75	13	F1-0000-00-70	8V, 12V-71
5189119	BF-09208	36	8	3 1/16	X	X	X	X	0.75	13	F1-0000-00-70	8V, 12V-71
5125148	BF-10376	36	8	3 1/16	X	X	X	X	0.80	20	F1-0000-00-70	12V-71
5162666	LF-10804	36	8	3 1/16	X		X	X	0.85	21	F1-0000-00-70	8V, 12V-71
5189119	BF-09208	36	8	3 1/16	X	X	X	X	0.85	21	F1-0000-00-70	8V, 12V-71
5124147	BF-09922	40	8	3		X	X	X	0.67	13	F1-0000-00-71	12V, 16V-71
5126383	BF-10021	40	8	3	X		X	X	0.67	13	F1-0000-00-71	12V-71
5124147	BF-09922	40	8	3		X	X	X	0.75	21	F1-0000-00-71	12V, 16V-71
5126383	BF-10021	40	8	3	X		X	X	0.75	21	F1-0000-00-71	12V-71

*Air Delivery at Fan RPM
 B = Blowing Fan RH = Right hand rotation
 S = Suction Fan LH = Left hand rotation

Courtesy of Detroit Diesel Allison Division, General Motors Corporation

P_s = static pressure, lbf/ft²

P_t = total pressure, lbf/ft²

V = fluid velocity, ft/sec

ρ_a = air density, lbf/ft³

Increase of the total fluid pressure takes place only in the rotor region of any

turbomachine. All other nonrotating components of the fan such as guide vanes and diffusers do not contribute to the total pressure increases. Due to losses, the total pressure decreases in these elements. These elements change direction of the flow or change the static pressure at the expense of a change in the velocity pressure.

When no inlet duct is used and no

restrictions are present, fans operate with the air handled arriving at the inlet to the housing at atmospheric pressure. When an inlet duct is used or when there are restrictions—such as an inlet grille, heat exchanger, filter, or the engine—inlet air pressure may be less than atmospheric. Fig. D-3 shows how to measure average pressure in a duct or housing. See Appendix D-3 for fan test procedures.

If the fan has no inlet duct, the entry losses to the fan housing are considered as part of the fan losses and are reflected in the total efficiency of the fan. If the fan has no discharge duct from its outlet, the discharge static pressure is zero and the total pressure at this point is equal to the average velocity pressure.

The average total pressure difference (total pressure rise created by a fan) is the average total pressure at the fan outlet minus the average total pressure at the fan inlet. Static pressures less than atmospheric are considered negative. Velocity pressure is always positive. The total pressure at the fan outlet in an actual system is all pressure losses in the path taken by the air to reach its destination, leaving only the velocity pressure at the farthest point of discharge.

The total pressure drop at the fan inlet in a system that includes a suction duct and restrictions—such as a grille, filter, cooler, or the engine compartment within it—is always equal to the sum of the losses in the inlet system. The total pressure in a system of this type is always negative and numerically less than the static pressure at the same location.

In selecting a fan, it is necessary to know the volume of air which it must handle and the static pressure against which it must operate. The static pressure rise used for this purpose is the static pressure at the fan outlet minus the total pressure at the fan inlet. The static pressure rise, for the purpose of fan selection, often is taken as the total system static pressure (inlet and discharge). This procedure,

although sufficiently accurate for many practical purposes, is technically correct only when the discharge system consists of one duct that has the same cross-sectional area as the fan outlet and no side branches (See Ref. 2).

4-5 FAN AIR HORSEPOWER

The theoretical horsepower input required to drive a fan is expressed in terms of air horsepower HP_a and represents work done on the air by the fan.

$$HP_a = \frac{w_a \Delta P_t}{33,000}, \text{ hp} \quad (4-2)$$

where

w_a = airflow rate, lbm/min

ΔP_t = total fluid pressure rise through the fan, ft of air

In terms of the volume of air handled in cubic feet per minute and the total pressure difference created by the fan in inches of water, the expression is

$$HP_a = (CFM) \Delta P_t \times 1.575 \times 10^{-4}, \text{ hp} \quad (4-3)$$

where

CFM = volumetric airflow rate at standard conditions, cfm

ΔP_t = total fluid pressure rise through the fan, in. water

4-6 FAN EFFICIENCIES

The total efficiency η_t of the fan is

$$\eta_t = \frac{HP_a}{HP_f} \times 100, \text{ percent} \quad (4-4)$$

AMCP 708-381

where

HP_a = fan air horsepower, hp

HP_f = fan input horsepower, hp

Air horsepower HP_a is a function of the total pressure difference created by the fan and airflow rate.

Velocity pressure usually is small in comparison with the static pressure developed by a fan and normally is not given in fan performance data. As a result, it becomes generally more convenient to determine the static efficiency of the fan rather than the total efficiency. Static efficiency η_s is expressed as

$$\eta_s = \frac{HP_{as}}{HP_f} \times 100, \text{ percent} \quad (4-4a)$$

where

HP_f = fan input horsepower, hp

HP_{as} = fan air horsepower based on static pressure rise, hp

The air horsepower HP_{as} based on static pressure rise may be computed by using static pressure rise in place of total pressure rise in either Eqs. 4-2 or 4-3.

Static efficiency is not a true performance characteristic, however, it provides a convenient basis for comparing two fans under consideration for a given installation. If the total efficiency is known, the static efficiency η_s can be determined from

$$\eta_s = \eta_t \times \frac{\Delta P_s}{\Delta P_t}, \text{ percent} \quad (4-5)$$

where

ΔP_s = static pressure rise, in. water

ΔP_t = total fluid pressure rise through the fan, in. water

4-7 FAN PERFORMANCE

Fan performance is expressed by the relationship between static pressure rise ΔP_s , volume airflow rate CFM , and input horsepower HP_f —all measured at constant impeller or rotor speed N_f . These characteristics are usually specified at standard air density of 0.075 lbm/ft³. Other calculated or measured data often used are static efficiency η_s , sound power level PWL , total pressure rise FTP , (ΔP_t), outlet velocity V_{out} , and fan tip speed V_t . See Appendix B for fan performance curves.

Fan performance curves specify actual characteristics obtained under controlled laboratory conditions. In an actual installation, the fan performance may be degraded by conditions such as clearance, inlet and outlet restrictions caused by cooling system components, recirculation of heated air, duct leakage, and expansion, contraction, and turning losses caused by ducts and shrouding. It is essential to a good cooling fan selection that these factors be considered in predicting the fan performance. Normal evaluation procedures require that the fans be evaluated in a mock-up or prototype installation simulating actual system operating conditions.

4-7.1 TIP SPEED

The tip speed V_t of a fan is defined as the peripheral speed of the outer diameter of the fan blades and is expressed as

$$V_t = N_f \pi D, \text{ ft/min} \quad (4-6)$$

where

D = outer diameter of blades, ft

N_f = fan rotational speed, rev/min

The tip speed-static pressure relationship may

be used as selection criteria for specific applications of fan types (Ref. 11).

4-7.2 OUTLET VELOCITY

Fluid velocity V_{out} at the fan outlet is obtained by dividing the flow rate by the fan outlet area.

$$V_{out} = \frac{CFM}{A_{out}}, \text{ ft/min} \quad (4-7)$$

where

CFM = fan flow rate, ft^3/min

A_{out} = fan outlet area, ft^2

This relationship is used in determining flow losses in exit ducts as discussed in par. 7-2.4.2.5.

4-7.3 STANDARD FAN COMPONENTS

Fan performance curves for complete assemblies including housings, drives, bearings, shafts, and other components can be obtained from the fan manufacturer. The fan assembly design must be capable of meeting the full military requirements defined by the vehicle system specifications. Adequate cooling system performance is possible only if all components are capable of meeting the vehicle duty requirements.

4-8 FAN LAWS

4-8.1 PERFORMANCE VARIABLES

The fan laws relate the performance variables for any homologous series of fans. The three basic fan laws are:

1. Volume varies directly with the speed.
2. Static pressure varies with the square of the speed and directly as the density.

3. Horsepower varies as the cube of the speed and directly as the density.

The performance variables used in the fan laws in Table 4-3 are:

1. Fan size (size)
2. Fan speed RPM
3. Gas density δ
4. Capacity CFM
5. Fan total pressure rise $FTP (\Delta P_t)$
6. Fan input horsepower HP_f
7. Sound Power Level PWL

The ratios of all the other variables are interrelated. The principal relationships are:

1. Capacity varies as:
 - a. $(\text{Size}_a/\text{Size}_b)^3 \times (\text{Speed}_a/\text{Speed}_b)$
 - b. $(\text{Size}_a/\text{Size}_b)^2 \times (\text{Pressure}_a/\text{Pressure}_b)^{1/2}$
2. Static or total pressure varies as:

$$(\text{Size}_a/\text{Size}_b)^2 \times (\text{Speed}_a/(\text{Speed}_b))^2$$
3. Power varies as
 - a. $(\text{Size}_a/\text{Size}_b)^5 \times (\text{Speed}_a/\text{Speed}_b)^3$
 - b. $(\text{Size}_a/\text{Size}_b)^2 \times (\text{Pressure}_a/\text{Pressure}_b)^{3/2}$
4. Speed varies as:

$$(\text{Size}_b/\text{Size}_a) \times (\text{Pressure}_a/\text{Pressure}_b)^{1/2}$$

Additional rules can be used for predicting performance of fans of similar design. These laws are presented in Table 4-3.

TABLE 4-3
 FAN LAWS (Ref. 3)

For all Fan Laws, $n_1 = n_2$ and $\rho_1 = \rho_2$ - all of fig. 1.		For all Fan Laws, $n_1 = n_2$ and $\rho_1 = \rho_2$ - all of fig. 1.	
Dependent Variables		Independent Variables	
1a	$CFM_1 = CFM_2 \times \left(\frac{SIZE_1}{SIZE_2}\right)^3 \times \left(\frac{RPM_1}{RPM_2}\right)^3 \times (1)$	1a	$CFM_1 = CFM_2 \times \left(\frac{CFM_1}{CFM_2}\right)^3 \times \left(\frac{RPM_1}{RPM_2}\right)^3 \times (1)$
1b	$FTP_1 = FTP_2 \times \left(\frac{SIZE_1}{SIZE_2}\right)^3 \times \left(\frac{RPM_1}{RPM_2}\right)^3 \times \left(\frac{RPM_1}{RPM_2}\right)^3 \times \left(\frac{RPM_1}{RPM_2}\right)^3 \times (1)$	1b	$FTP_1 = FTP_2 \times \left(\frac{CFM_1}{CFM_2}\right)^3 \times \left(\frac{RPM_1}{RPM_2}\right)^3 \times \left(\frac{RPM_1}{RPM_2}\right)^3 \times \left(\frac{RPM_1}{RPM_2}\right)^3 \times (1)$
1c	$HP_1 = HP_2 \times \left(\frac{SIZE_1}{SIZE_2}\right)^3 \times \left(\frac{RPM_1}{RPM_2}\right)^3 \times \left(\frac{RPM_1}{RPM_2}\right)^3 \times \left(\frac{RPM_1}{RPM_2}\right)^3 \times (1)$	1c	$HP_1 = HP_2 \times \left(\frac{CFM_1}{CFM_2}\right)^3 \times \left(\frac{RPM_1}{RPM_2}\right)^3 \times \left(\frac{RPM_1}{RPM_2}\right)^3 \times \left(\frac{RPM_1}{RPM_2}\right)^3 \times (1)$
1d	$PWL_1 = PWL_2 + 10 \log \left(\frac{SIZE_1}{SIZE_2}\right)^3 + 50 \log \left(\frac{RPM_1}{RPM_2}\right)^3 + 20 \log \left(\frac{RPM_1}{RPM_2}\right)^3 \times (1)$	1d	$PWL_1 = PWL_2 + 10 \log \left(\frac{CFM_1}{CFM_2}\right)^3 + 50 \log \left(\frac{RPM_1}{RPM_2}\right)^3 + 20 \log \left(\frac{RPM_1}{RPM_2}\right)^3 \times (1)$
2a	$CFM_1 = CFM_2 \times \left(\frac{SIZE_1}{SIZE_2}\right)^3 \times \left(\frac{FTP_1}{FTP_2}\right)^3 \times \left(\frac{RPM_1}{RPM_2}\right)^3 \times (1)$	2a	$CFM_1 = CFM_2 \times \left(\frac{SIZE_1}{SIZE_2}\right)^3 \times \left(\frac{FTP_1}{FTP_2}\right)^3 \times \left(\frac{RPM_1}{RPM_2}\right)^3 \times (1)$
2b	$FTP_1 = FTP_2 \times \left(\frac{SIZE_1}{SIZE_2}\right)^3 \times \left(\frac{FTP_1}{FTP_2}\right)^3 \times \left(\frac{RPM_1}{RPM_2}\right)^3 \times (1)$	2b	$FTP_1 = FTP_2 \times \left(\frac{SIZE_1}{SIZE_2}\right)^3 \times \left(\frac{FTP_1}{FTP_2}\right)^3 \times \left(\frac{RPM_1}{RPM_2}\right)^3 \times (1)$
2c	$HP_1 = HP_2 \times \left(\frac{SIZE_1}{SIZE_2}\right)^3 \times \left(\frac{FTP_1}{FTP_2}\right)^3 \times \left(\frac{RPM_1}{RPM_2}\right)^3 \times (1)$	2c	$HP_1 = HP_2 \times \left(\frac{SIZE_1}{SIZE_2}\right)^3 \times \left(\frac{FTP_1}{FTP_2}\right)^3 \times \left(\frac{RPM_1}{RPM_2}\right)^3 \times (1)$
2d	$PWL_1 = PWL_2 + 20 \log \left(\frac{SIZE_1}{SIZE_2}\right)^3 + 25 \log \left(\frac{FTP_1}{FTP_2}\right)^3 + 5 \log \left(\frac{RPM_1}{RPM_2}\right)^3 \times (1)$	2d	$PWL_1 = PWL_2 + 20 \log \left(\frac{SIZE_1}{SIZE_2}\right)^3 + 25 \log \left(\frac{FTP_1}{FTP_2}\right)^3 + 5 \log \left(\frac{RPM_1}{RPM_2}\right)^3 \times (1)$
3a	$RPM_1 = RPM_2 \times \left(\frac{SIZE_1}{SIZE_2}\right)^3 \times \left(\frac{CFM_1}{CFM_2}\right)^3 \times (1)$	3a	$RPM_1 = RPM_2 \times \left(\frac{SIZE_1}{SIZE_2}\right)^3 \times \left(\frac{CFM_1}{CFM_2}\right)^3 \times (1)$
3b	$FTP_1 = FTP_2 \times \left(\frac{SIZE_1}{SIZE_2}\right)^3 \times \left(\frac{CFM_1}{CFM_2}\right)^3 \times (1)$	3b	$FTP_1 = FTP_2 \times \left(\frac{SIZE_1}{SIZE_2}\right)^3 \times \left(\frac{CFM_1}{CFM_2}\right)^3 \times (1)$
3c	$HP_1 = HP_2 \times \left(\frac{SIZE_1}{SIZE_2}\right)^3 \times \left(\frac{CFM_1}{CFM_2}\right)^3 \times (1)$	3c	$HP_1 = HP_2 \times \left(\frac{SIZE_1}{SIZE_2}\right)^3 \times \left(\frac{CFM_1}{CFM_2}\right)^3 \times (1)$
3d	$PWL_1 = PWL_2 + 80 \log \left(\frac{SIZE_1}{SIZE_2}\right)^3 + 50 \log \left(\frac{CFM_1}{CFM_2}\right)^3 + 20 \log \left(\frac{CFM_1}{CFM_2}\right)^3 \times (1)$	3d	$PWL_1 = PWL_2 + 80 \log \left(\frac{SIZE_1}{SIZE_2}\right)^3 + 50 \log \left(\frac{CFM_1}{CFM_2}\right)^3 + 20 \log \left(\frac{CFM_1}{CFM_2}\right)^3 \times (1)$
4a	$CFM_1 = CFM_2 \times \left(\frac{SIZE_1}{SIZE_2}\right)^3 \times \left(\frac{HP_1}{HP_2}\right)^3 \times (1)$	4a	$CFM_1 = CFM_2 \times \left(\frac{SIZE_1}{SIZE_2}\right)^3 \times \left(\frac{HP_1}{HP_2}\right)^3 \times (1)$
4b	$FTP_1 = FTP_2 \times \left(\frac{SIZE_1}{SIZE_2}\right)^3 \times \left(\frac{HP_1}{HP_2}\right)^3 \times (1)$	4b	$FTP_1 = FTP_2 \times \left(\frac{SIZE_1}{SIZE_2}\right)^3 \times \left(\frac{HP_1}{HP_2}\right)^3 \times (1)$
4c	$RPM_1 = RPM_2 \times \left(\frac{SIZE_1}{SIZE_2}\right)^3 \times \left(\frac{HP_1}{HP_2}\right)^3 \times (1)$	4c	$RPM_1 = RPM_2 \times \left(\frac{SIZE_1}{SIZE_2}\right)^3 \times \left(\frac{HP_1}{HP_2}\right)^3 \times (1)$
4d	$PWL_1 = PWL_2 + 13.3 \log \left(\frac{SIZE_1}{SIZE_2}\right)^3 + 16.6 \log \left(\frac{HP_1}{HP_2}\right)^3 + 3.3 \log \left(\frac{HP_1}{HP_2}\right)^3 \times (1)$	4d	$PWL_1 = PWL_2 + 13.3 \log \left(\frac{SIZE_1}{SIZE_2}\right)^3 + 16.6 \log \left(\frac{HP_1}{HP_2}\right)^3 + 3.3 \log \left(\frac{HP_1}{HP_2}\right)^3 \times (1)$
5a	$SIZE_1 = SIZE_2 \times \left(\frac{CFM_1}{CFM_2}\right)^3 \times \left(\frac{FTP_1}{FTP_2}\right)^3 \times \left(\frac{RPM_1}{RPM_2}\right)^3 \times (1)$	5a	$SIZE_1 = SIZE_2 \times \left(\frac{CFM_1}{CFM_2}\right)^3 \times \left(\frac{FTP_1}{FTP_2}\right)^3 \times \left(\frac{RPM_1}{RPM_2}\right)^3 \times (1)$
5b	$RPM_1 = RPM_2 \times \left(\frac{CFM_1}{CFM_2}\right)^3 \times \left(\frac{FTP_1}{FTP_2}\right)^3 \times \left(\frac{RPM_1}{RPM_2}\right)^3 \times (1)$	5b	$RPM_1 = RPM_2 \times \left(\frac{CFM_1}{CFM_2}\right)^3 \times \left(\frac{FTP_1}{FTP_2}\right)^3 \times \left(\frac{RPM_1}{RPM_2}\right)^3 \times (1)$
5c	$HP_1 = HP_2 \times \left(\frac{CFM_1}{CFM_2}\right)^3 \times \left(\frac{FTP_1}{FTP_2}\right)^3 \times \left(\frac{RPM_1}{RPM_2}\right)^3 \times (1)$	5c	$HP_1 = HP_2 \times \left(\frac{CFM_1}{CFM_2}\right)^3 \times \left(\frac{FTP_1}{FTP_2}\right)^3 \times \left(\frac{RPM_1}{RPM_2}\right)^3 \times (1)$
5d	$PWL_1 = PWL_2 + 10 \log \left(\frac{CFM_1}{CFM_2}\right)^3 + 20 \log \left(\frac{FTP_1}{FTP_2}\right)^3 + 0 \log \left(\frac{RPM_1}{RPM_2}\right)^3 \times (1)$	5d	$PWL_1 = PWL_2 + 10 \log \left(\frac{CFM_1}{CFM_2}\right)^3 + 20 \log \left(\frac{FTP_1}{FTP_2}\right)^3 + 0 \log \left(\frac{RPM_1}{RPM_2}\right)^3 \times (1)$

(Courtesy of Buffalo Forge Co.)

SYMBOLS: RPM = REVOLUTIONS PER MIN
 CFM = CUBIC FT PER MIN
 * FTP = FAN TOTAL PRESSURE RISE
 HP = HORSEPOWER
 * FAN STATIC PRESSURE OR VELOCITY PRESSURE MAY BE SUBSTITUTED FOR FTP/FTP₀

PWL = SOUND POWER LEVEL
 η = EFFICIENCY
 δ = DENSITY

The fan laws given in Table 4-3 can be used to determine the performance of any fan when test data for a fan of the same series are available. The subscript *a* denotes that the variable is for the fan under consideration. The subscript *b* indicates that the variable is for the tested fan. Total pressure rise ΔP_t or static pressure rise ΔP_s can be used as applicable for *FTP* in Table 4-3.

For example, Fan Law No. 1 defines the effect of changing size, speed, or density on capacity, pressure, power, and sound power level *PWL*. For convenience, gas density (represented by δ in Table 4-3) is always shown as an independent variable and sound power level *PWL* is always shown as a dependent variable. Of the remaining five variables, a different pair is shown as the independent variable in each of the ten laws.

4-8.2 FAN NOISE

Aerodynamic noise from all types of fans can be classified generally into rotational or blade noise, and vortex component noise. The blade noise is created each time the blade passes a given point when the air at that point receives an impulse. The repetition rate of the impulse is defined as the blade passing frequency and is determined by the number of blades and the fan speed. The vortex noise is generated by the air pressure pattern and flow vortices created by the fan blade.

In addition to aerodynamic fan noise, other sources such as drive gears, fan unbalance, motor noise if electrically driven, and structural resonance contribute to the wide range of frequencies present in the fan noise.

The fan manufacturer incorporates the best overall design to minimize fan noise, however, the sound power level *PWL* must be determined by actual testing of the fan in the vehicle or mock-up under actual conditions.

Empirical relationships have been developed between fan noise and its size, speed,

capacity, and static pressure as shown in Table 4-3. These relationships apply only for a fixed point of rating. If one of the variables remains constant, $\log_{10}(1) = 0$ and the other applies as written. Thus, in Fan Law No. 2d (Table 4-3) where tip speed for a given series of fans remains constant, the static pressure P_s will be constant and the sound power level *PWL* will vary as $20 \log_{10} (\text{size}_a/\text{size}_b)$ since $\log_{10}(1) = 0$.

A double-width fan is essentially two fans of the same size, speed, and sound power level *PWL*. Therefore, from Eq. 5d Table 4-3, the sound power level *PWL* of the double width fan will be $10 \log_{10}(2)$ or 3 dB greater than the smaller fan. Likewise, the sound power level of a multistage fan is less than that of a single-stage fan of the same capacity and pressure. Thus, if a single-stage fan is 90 dB, the sound power level *PWL* of a six-stage fan to give the same airflow and pressure rise is from Eq. 5d Table 4-3, $10 \log_{10}(6) + 20 \log_{10}(1/6) = 7.8 - 15.6 = -7.8$ or 7.8 dB less¹ (Ref. 4, p. 25-10).

Decibels are convenient dimensionless units for measuring power, or some other property, which is proportional to power, whenever the range of values is very large. For example sound power may vary from 1×10^{-9} to 100,000 W and sound pressure may vary from 0.0002 to 200 microbar.

By definition, the level of a quantity in decibels is 10 times the logarithm (to the base 10) of the ratio of that quantity (in dimensional units) to some reference quantity (in the same dimensional units). The only other qualification is that the quantity must be proportional to power. The reference power *W* for sound power level *PWL* measurements is 10^{-12} watt so that

$$PWL = 10 \log_{10} \frac{W}{10^{-12} \text{ watt}}, \text{ dB} \quad (4-8)$$

¹ Courtesy of McGraw-Hill Book Company

AMCP 706-361

where

W = power, watts

The reference pressure p for sound pressure level SPL measurements is 0.0002 microbar so that

$$SPL = 20 \log_{10} \frac{p}{0.0002 \text{ microbar}}, \text{ dB} \quad (4-9)$$

where

p = pressure, microbar

For axial flow fans the sound pressure SPL of the rotational noise, opposite the rotor tips, may be estimated from the relation

$$p = 213 \Delta P \left[\left(\frac{r+1}{r-1} \right) \log_{10} r \right]^{1/2}, \quad (4-10)$$

microbar

where

r = ratio of inside fan radius to hub radius, dimensionless

ΔP = pressure rise across the plane of rotation, in. water

Current efforts in anticipation of noise legislation have produced effective results in the development of low noise cooling systems for vehicles (see Ref. 5). Currently the techniques available for reducing fan noise are:

1. Use the largest diameter fan possible driven at the lowest possible speed.
2. Operate the fan(s) at maximum efficiency. A venturi type shroud can increase efficiency and minimize noise and power requirements.
3. Vary the fan speed, blade spacing, number of blades, and/or blade pitch to move

undesirable noise peaks away from the operating speed.

4. Apply acoustical insulation to ducts.

5. Keep the fan discharge area clear of obstructions to minimize pressure pulses or noises.

It is beyond the scope of this handbook to thoroughly cover fan noise and design. The reader is referred to Refs. 3 and 4 for additional information on this subject.

4-8.3 FAN LAW RESTRICTIONS

Before the fan laws can be used to determine the performance of a fan at any point of rating, it is necessary to have test data for a fan of the same series at the same point of rating; i.e., at similarly situated points of operation, efficiencies are equal.

The use of the fan laws is restricted to cases where all linear dimensions of the fan under consideration are proportional to the corresponding dimensions of the fan for which test data are available. The proportionality factor is the size ratio. In the fan laws, any convenient dimension may be used for size. Another restriction is that the fluid velocities in the fan under consideration must be proportional to the corresponding velocities in the tested fan. The proportionality factor is the ratio of peripheral speeds for any pair of similarly situated points on the rotors. Such a condition is established if the two fans have the same point of rating.

4-8.4 EXAMPLES OF FAN LAW USE

Example 1. A fan delivers 1000 cfm at a static pressure rise of 0.8 in. of water and requires 0.3 hp when operated at 1000 rpm. If 1400 cfm are required for an application, at what new speed must the fan be operated; what will the static pressure be; and what is the new power requirement?

Solution: The *same* fan is to be used in the same system so Eqs. of Table 4-3 apply

From Eq. 3a

$$RPM_a = 1000 \left(\frac{1400}{1000} \right) = 1400 \text{ rpm}$$

From Eq. 1b

$$(\Delta P_s)_a = 0.8 \left(\frac{1400}{1000} \right)^2 = 1.57 \text{ in. of water}$$

From Eq. 3c

$$HP_a = 0.3 \left(\frac{1400}{1000} \right)^3 = 0.82 \text{ hp}$$

Example 2. A fan with a 10 in. diameter rotor delivers 1400 cfm at a static pressure rise of 0.9 in. of water at 1000 rpm. The power required is 0.45 hp. What would be the cfm, static pressure, and power required by a geometrically similar fan with a 14 in. rotor?

Solution: For these conditions Eqs. of Table 4-3 apply

From Eq. 1a

$$CFM_a = 1400 \left(\frac{14}{10} \right)^3 = 3842 \text{ cfm}$$

From Eq. 1b

$$(\Delta P_s)_a = 0.9 \left(\frac{14}{10} \right)^2 = 1.76 \text{ in. of water}$$

From Eq. 1c

$$HP_a = 0.45 \left(\frac{14}{10} \right)^5 = 2.42 \text{ hp}$$

Example 3.¹ Density Applications: This

¹ Courtesy LAU INDUSTRIES (Ref. 6)

procedure may be followed for applications requiring density corrections using fan performance data expressed at standard air conditions:

1. Define the actual air volume requirements. Do not correct air volume to standard air conditions.
2. Calculate the fan static pressure as though the system were handling standard air.
3. Select fan from manufacturer's data using actual *CFM* requirements and calculated fan static pressure rise. The *RPM* shown is the actual speed at which the fan must run.
4. Correct the *HP* shown in fan manufacturer's data by multiplying by density factor.

For a fan with the following conditions:

1. 250°F exhaust air
2. 3.0 in. water static pressure rise P_s
3. 2500 cfm is the required airflow rate

Select a fan and determine the *RPM* and *HP* required:

1. The air required is 2500 cfm. (No temperature correction required.)

2. Fan static pressure P_s (air density at 250°F = 0.056 lbm/ft³)

$$P_s = 3.0 \left(\frac{0.075}{0.056} \right) = 4.0 \text{ in. of water for standard air}$$

3. Select a fan for 2500 cfm and 4.0 in. of water static pressure rise P_s .

4. From fan performance data the fan requires 1700 rpm at 2.6 hp

AMCP 706-381

$$HP_s = 2.6 \left(\frac{0.056}{0.075} \right) = 1.94 \text{ hp required at } 250^\circ\text{F.}$$

4-9 SPECIFIC SPEED

Specific speed is defined as the fan rotational speed which will produce a static pressure rise of 1 in. of water at a volume flow rate of 1 cfm in a geometrically similar family of fans. The usefulness of specific speed as a fan selection criterion is that for geometrically similar fans, the value of the expression for specific speed is the same regardless of size or speed. Specific speed N_s usually is determined at the point of rating of CFM and air pressure drop at best static efficiency is expressed as

$$N_s = \frac{N_f (CFM)^{0.5}}{\Delta P_s^{0.75}}, * \quad (4-11)$$

where

$$\Delta P_s = \text{in. water}$$

$$N_f = \text{fan speed, rpm}$$

* N_s is not dimensionless but generally is expressed simply as a number since its practical application is such that units are of no consequence except for their influence on the absolute magnitude of the number itself.

If the fan to be selected is to be operated at an air density other than that for which the fan curve was drawn, then ΔP_s must be corrected to an equivalent static pressure rise $(\Delta P_s)_{eq}$ for use in Eq. 4-11 by

$$(\Delta P_s)_{eq} = \Delta P_s \left(\frac{\rho}{\rho'} \right), \text{ in. water} \quad (4-12)$$

where

$$\rho = \text{air density for which fan curve was drawn, lbm/ft}^3$$

ρ' = air density at which fan is to be selected, lbm/ft³

Fig. 4-4 illustrates specific speed ranges at optimum efficiency for various types of air-moving devices. These ranges are typical and do not apply necessarily to the products of any particular manufacturer.

Because P_s and CFM in a specific application more or less are fixed, specific speed N_s can be varied only if RPM can be varied. The specific speed criterion is therefore most definitive in direct drive applications where RPM is fixed. If RPM can be varied, there is a greater latitude of choice in selecting the fan type.

Example: An air moving device is to deliver 3200 cfm at a static pressure rise of 1 in. water when driven at 1140 rpm. What type of fan is suitable for this application at standard air density?

Solution:

By Eq. 4-11

$$N_s = \frac{1140(3200)^{0.5}}{(1)^{0.75}} = 64,488$$

If direct drive is required, then a backward curved blade centrifugal or vane-axial fan would be most efficient as shown in Fig. 4-4, points A and A'. A forward curved fan might operate at $N_s = 64,488$ but it would not be very efficient unless a twin unit (two fans with the same CFM rating) were used because the maximum design range for this type fan is $N_s = 60,000$ (Fig. 4-4).

With proper speed reduction, a single forward curved, backward curved, or a mixed flow fan could be used. A speed reduction of 2 to 1 would place the application well into the maximum efficiency ranges as shown in Fig. 4-4 line B.

Specific speed is the primary method used

in selecting the best type of fan. Once the type has been determined, other methods must be used to determine the particular fan most suitable for the application.

Fig. 4-5 presents specific speed as a function of static efficiency and shows the range of specific speeds for various types of fans. The static efficiency characteristics under off-design conditions can be estimated from this figure.

The efficiency values shown are an indication of the approximate upper limits that can be obtained with the respective types of fans.

In practice, the efficiencies of most small commercial fans will not be as good as those shown in Fig. 4-5, ranging 5 to 10 percent less, since design refinements are compromised in favor of lower first costs.

Most small centrifugal fans have either radial or forward curved blading since, for a given application where speed is fixed, these fans will be smaller than the inherently more efficient backward curved blade fan. The backward curved blade fan becomes significant only where operating efficiency is important and size is of lesser consequence.

The design refinements necessary to achieve 70 to 80 percent efficiency in a tube or vane-axial fan make it an expensive piece of equipment, limited to applications where input power and size are most important (Ref. 6), such as current combat vehicles.

4-10 EFFECT OF SYSTEM RESISTANCE ON FAN PERFORMANCE

Military vehicle cooling systems often contain components such as grilles, filters, heat exchangers, ducts, accessories, engines, and other items that restrict airflow. In most cooling systems the airflow is turbulent and the static pressure loss varies with the square

of the volume flow rate, i.e.,

$$\frac{(\Delta P_s)_a}{(\Delta P_s)_b} = \left(\frac{CFM_a}{CFM_b} \right)^2 \quad (4-13)$$

When plotted, this relationship gives the system resistance characteristic curve shown with a fan performance curve in Fig. 4-6.

It should be noted that the system characteristics are difficult to estimate accurately and normally are determined by test.

In actual operation, the static pressure rise developed by the fan must equal or exceed the resistance of the entire cooling system. Included in Fig. 4-6 is a representative performance curve for a fan with a specific static pressure rise characteristic. When the fan is operated, the air resistance of the system will increase with the increase in airflow along the system characteristic curve *A* until this curve intersects the fan curve. At this point, the air resistance of the system is equal to the static pressure developed by the fan and the airflow will stabilize at the amount CFM_1 , shown on the volume scale directly below the point of intersection of the curves.

If the cooling system resistance should increase as a result of a plugged component, the system characteristic might be changed to that shown by the System resistance *B* curve in Fig. 4-7, and the volume of air handled would decrease from CFM_1 to CFM_2 if the fan speed does not change. It would be possible to maintain the CFM_1 air volume by increasing the fan speed to change the fan static pressure rise characteristic from fan-speed₁ to fan-speed₂, providing the additional fan power requirement could be met.

If the plugged component were cleaned to return the cooling system resistance to that shown by the System *A* curve, the fan would then handle the original volume indicated by CFM_1 .

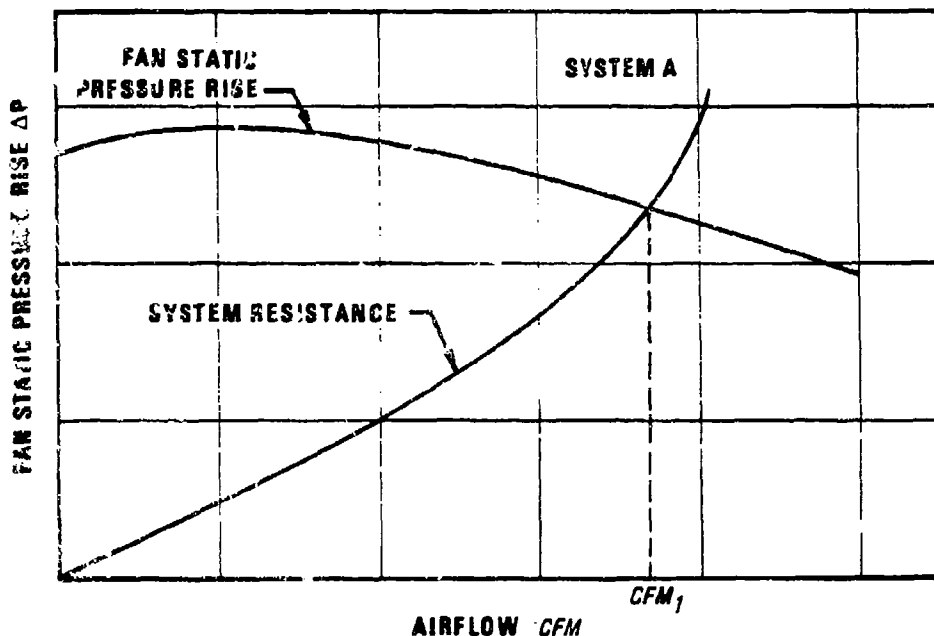

Figure 4-6. Operating Characteristics of a Fan and Cooling System

4-10.1 SYSTEM RESISTANCE

The system resistance of a vehicle cooling system is the sum of the restrictions of the cooling air due to the inlet grille, engine, components, ducting, and exhaust grille. The system resistance is a function of the required airflow. The higher the airflow through the system the higher the system resistance will be. The airflow requirement is determined by the amount of cooling that is required. The greater the amount of cooling required, the greater the airflow requirement will be.

System resistance can be calculated approximately as shown in the example in paragraph 4-10.2 but usually is determined by actual test of typical system resistance (charac-

teristic) curves are shown in Fig. 4-7.

4-10.2 FAN AND SYSTEM MATCHING

Knowing the system resistance and airflow requirements of a cooling system, one must select a fan that will equal or exceed these requirements. Point A of Fig. 4-11 shows a matched system that requires 5000 cfm of cooling air at 2 in. of water restriction. Selection of a fan with a higher flow rate than the required 5000 cfm (Point A') would cause an increase in the static pressure rise through the system and could result in overcooling. Selection of a fan for this system with a flow rate lower than 5000 cfm (Point A'') would result in a decrease in the required static pressure through the system with the possibility of overheating.

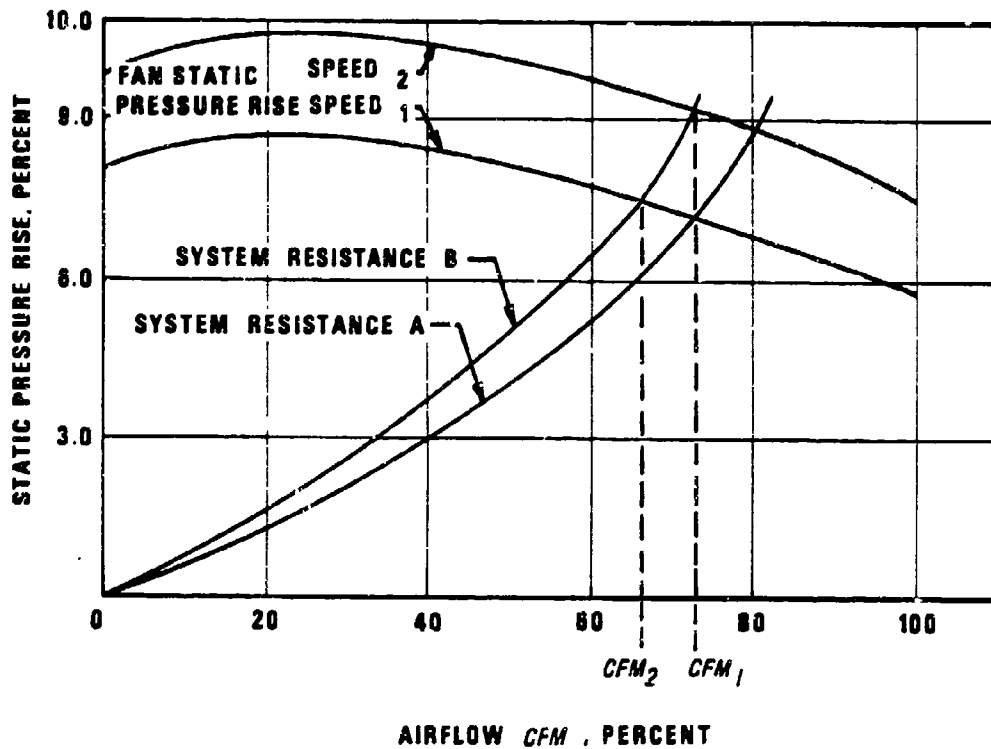

Figure 4-7. Change in Operating Characteristics of a Fan and Cooling System

4-11 MULTIPLE FAN SYSTEM

There are numerous reasons for using more than one fan in a cooling system, and the design options are virtually unlimited. Separate supply and exhaust fans might be used to avoid excessive pressure build-up in the compartment being ventilated, or available space could preclude the installation of one large fan. Capacity control or conservation of power could be justification for a multiple fan installation, and multistage fans might be necessary if system pressure requirements exceed the capabilities of a single unit. Fans operating in parallel may have any combination of the system resistance in common, varying from units with common inlet and

discharge ducts to individual unequal ducts with unequal resistances.

4-11.1 PARALLEL OPERATION

The simplest and most common arrangement for parallel fan operation is the twin assembly in which identical fans are driven at the same speed. Military vehicles using twin fans include the M109, M48, and M60.

The performance of a twin unit is predicted from the single fan performance curve, provided both fans are operating to the right of the peak static pressure point. The CFM delivered and HP required are simply double the CFM and HP of a single fan. Fig. 4-8(A)

AMCP 706-361

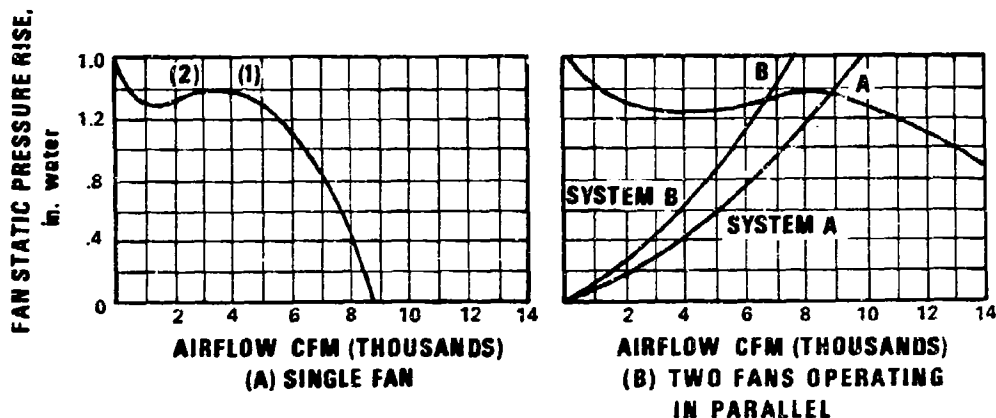

Figure 4-8. Performance of Fans in Parallel

shows that if each fan is operating at point (1), then the twin unit will be operating at Point A on the twin fan performance curve, Fig. 4-8(B). This would occur, for example, if the fans were operating in a System A.

When the system characteristic curve intersects the combined fan performance curve to right of the peak, Fig. 4-8(B), the performance of the twin unit will be stable, and each fan will carry one-half the load.

At and to left of the peak, the load is not equally divided between the two fans. If operating in a System B, for example, the individual fans are not restricted to the same point of rating on the single fan performance curve. In fact, one fan will tend to operate at point (1) and the other at point (2) in fulfilling the ΔP_s -CFM requirement of the system. In seeking equilibrium to meet the system requirement, the fan may actually interchange points of rating. More generally, this will occur when the system curve lies anywhere to left of the peak. Under this condition, a simple obstruction near the inlet or outlet of one of the fans can cause reversal of the points of operation. If the points of operation reverse rapidly, a buffeting condi-

tion results which can cause objectionable noise levels and uneven air delivery (Refs. 3 and 6).

4-11.2 SERIES OPERATION

Two or more fans may be mounted in series on a common shaft and housing as shown in Fig. 4-9(A). The first fan or stage feeds the second stage, and the resulting pressure ratio is basically the product of the ratios of the two stages. Multistage vane-axial fans achieve the highest pressure obtainable with axial flow devices for a given size and speed.

A pressure rise profile graph is presented in Fig. 4-9(B) to illustrate the static pressure characteristics of this arrangement.

4-12 FAN SELECTION

4-12.1 STANDARD DESIGNS

A fan is overspecified if it provides an airflow greatly in excess of that required and/or maintains a system pressure greater than required. This increased capacity or pressure rise is obtained at the expense of

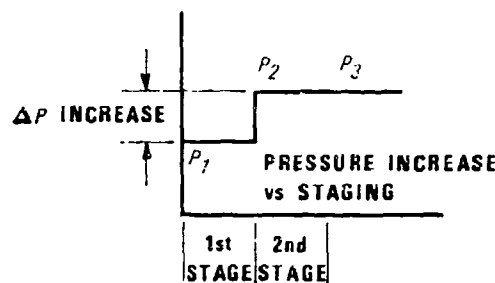
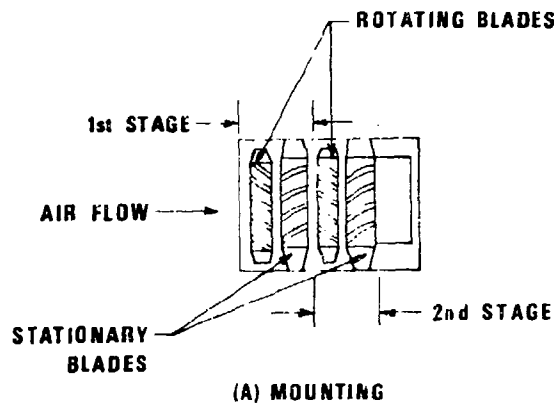

(B) PRESSURE RISE PROFILE GRAPH

Figure 4-9. Vane-axial Fans in Series

excessive power to drive the fan and/or an increase in the size of the fan. Since both power and space in a military vehicle are costly premiums, it is suggested that the fan be selected to match the system resistance adequately and avoid the penalty that would be imposed for doing otherwise.

For most applications it is neither desirable nor necessary to design a new fan for the particular installation. Standard off-the-shelf designs are available from manufacturers in a wide variety of types, sizes, construction, and configuration; accordingly, the process of selection is simply choosing the best size and type for the application. Theoretically, a large number of different fans possess the capability of fulfilling a specific application.

however, vehicle engineering requirements and economic considerations will limit the selection to a few candidates. Fan selection is a procedure that begins with performance specifications, progresses through analysis and trade-off studies, and usually is completed when the unit that most economically meets the engineering requirements is selected and subsequently verified by vehicle testing. The type of fan to be used can be determined by the use of specific speed criteria procedures presented in par. 4-9.

4-12.2 FAN SELECTION PROCEDURE

Almost any size fan type theoretically could be used to satisfy the performance requirements of a particular system, however,

AMCP 706-361

engineering and economic considerations reduce the selection possibilities to a relatively narrow range of fan sizes and types (See Ref. 7). The suitability of a particular type of fan depends more on the relationship between the various performance requirements than on their exact values. This is particularly true if the fan speed is specified. In these cases, the specific speed may be calculated, and the types of fans which exhibit a maximum efficiency at this condition may be determined from Figs. 4-4 or 4-5.

The choice of fan type and size for a particular vehicle cooling system application involves:

1. An aerodynamic selection influenced by the airflow, pressure rise, air density, and fan speed requirements.
2. A functional selection influenced by space availability and installation suitability (fan intake and discharge orientation).

For vehicle applications, airflow rate and flow resistance of the air paths (system static pressure loss) are the most important considerations. Fan speed and maximum available fan drive horsepower also may be given as initial conditions.

A general procedure for selecting a fan may be defined as follows:

1. Determine the heat rejection of the system (see Chapter 3).
2. Determine the airflow necessary to remove the heat.
3. Determine the total system resistance (see Chapter 7). The resistance determination must be made over the entire operating range of the system at intervals sufficiently close enough to plot an accurate system resistance characteristic curve as shown in Fig. 4-10.
4. Determine the power available to drive the fan.

5. A fan must be selected that will meet the airflow rate and total system resistance requirements. The fan selected may be either centrifugal, axial, or mixed flow. The primary determining factors are the fan *CFM* and static pressure rise. Determine the specific speed N_s from Eq. 4-11.

6. Determine the fan type from Fig. 4-4 or 4-5. If more than one type of fan is indicated as being satisfactory for the application, the final selection must be based on other factors such as available installation space, inlet and outlet flow path characteristics, and relative costs.

7. Review fan manufacturers' performance curves for the fan type determined in Step 6 to find a unit that will deliver the required airflow rate at the static pressure determined by the system resistance. The system resistance characteristic curve intersection with the fan performance curve should occur at or near the point of maximum efficiency and within the stable operating region for the type of fan selected. For practical applications, the system resistance curve should be established for the "worst case" conditions with allowances for maximum system resistance caused by cooling system component plugging or degradation.

8. If the air density ρ , in actual operation, varies significantly from the standard 0.075 lbm/ft³, the new values for density ρ may be found by

$$\rho = 0.075 \left(\frac{460 + 70}{460 + T} \right) \left(\frac{P_b}{29.92} \right), \quad (4-14)$$

lbm/ft³

where

T = air temperature, °F

P_b = barometric pressure, in. Hg

Air density values for various temperatures and altitude conditions for dry air are given in

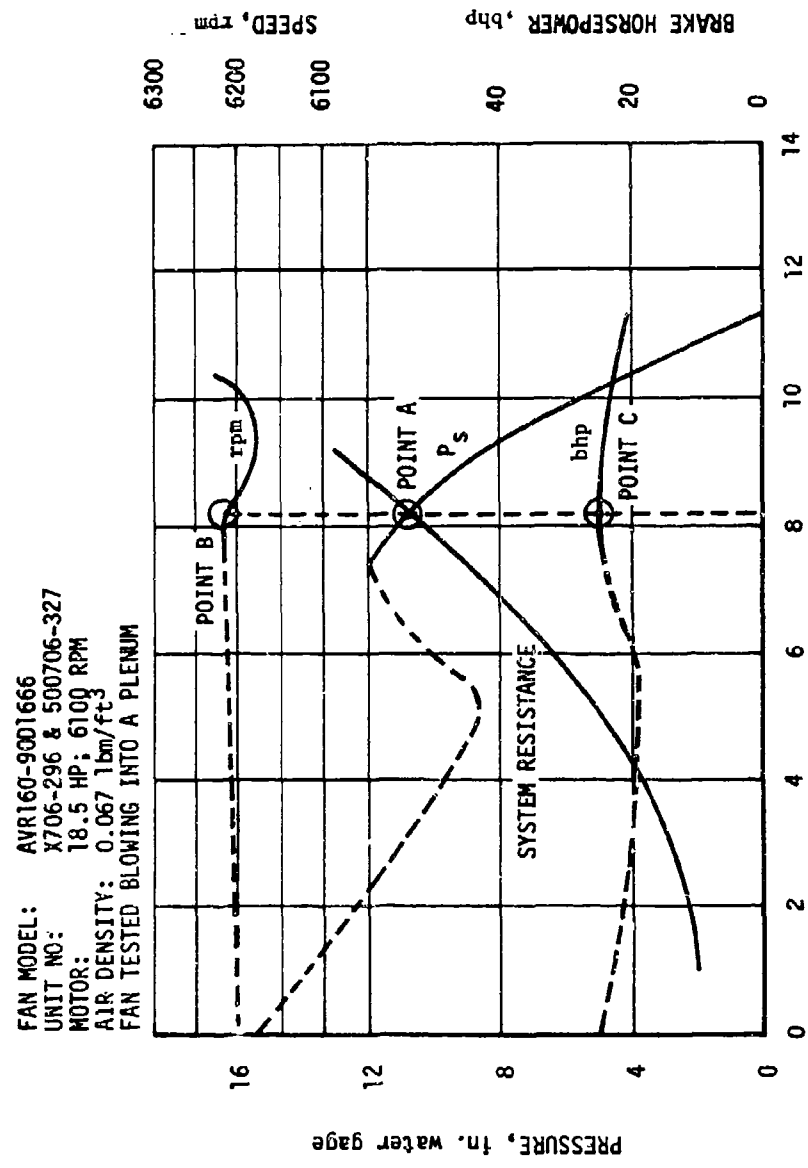

Figure 4-10. Fan Performance/System Resistance Matching
 (Courtesy of Joy Manufacturing Company)

AMCP 706-361

Table 4-4. Air density values for saturated and partially saturated air are given in Appendix D. Fan selection should be based on dry air density because of the lower density of saturated air.

Fan performance curves are made on the basis of ideal air inlet and exit conditions. In actual practice this is seldom the case. It is common practice to select a point about 85 percent of the airflow capacity shown on the

TABLE 4-4
AIR DENSITY AT VARIOUS TEMPERATURES AT SEA LEVEL AND BAROMETRIC PRESSURES AT VARIOUS ELEVATIONS (DRY AIR)

Sea Level				Atmospheric Pressure			
Temperature °F	Density lbm/ft ³	Temperature °F	Density lbm/ft ³	Elevation ft	Barometer in. Hg	Elevation ft	Barometer in. Hg
0	0.0864	310	0.0517	0	29.92	6200	23.80
10	0.0846	320	0.0510	200	29.71	6400	23.62
20	0.0828	330	0.0504	400	29.49	6600	23.44
30	0.0811	340	0.0497	600	29.28	6800	23.26
40	0.0795	350	0.0491	800	29.07	7000	23.09
50	0.0779	360	0.0485	1000	28.86	7200	22.91
60	0.0764	370	0.0479	1200	28.65	7400	22.74
70	0.0750	380	0.0474	1400	28.44	7600	22.56
80	0.0736	390	0.0467	1600	28.23	7800	22.39
90	0.0723	400	0.0462	1800	28.02	8000	22.22
100	0.0710	410	0.0456	2000	27.82	8200	22.05
110	0.0698	420	0.0451	2200	27.62	8400	21.89
120	0.0686	430	0.0446	2400	27.41	8600	21.72
130	0.0674	440	0.0441	2600	27.21	8800	21.55
140	0.0663	450	0.0437	2800	27.01	9000	21.38
150	0.0651	460	0.0432	3000	26.81	9200	21.22
160	0.0641	470	0.0427	3200	26.62	9400	21.06
170	0.0631	480	0.0423	3400	26.42	9600	20.90
180	0.0621	490	0.0418	3600	26.23	9800	20.74
190	0.0611	500	0.0414	3800	26.03	10000	20.58
200	0.0602	510	0.0410	4000	25.84	10200	20.42
210	0.0593	520	0.0405	4200	25.65	10400	20.26
220	0.0584	530	0.0401	4400	25.46	10600	20.10
230	0.0576	540	0.0397	4600	25.27	10800	19.95
240	0.0568	550	0.0394	4800	25.08	11000	19.79
250	0.0560	560	0.0390	5000	24.89	11200	19.64
260	0.0552	570	0.0386	5200	24.71	11400	19.48
270	0.0545	580	0.0382	5400	24.52	11600	19.33
280	0.0537	590	0.0379	5600	24.34	11700	19.25
290	0.0530	600	0.0375	5800	24.16	11800	19.18
300	0.0523	610	0.0372	6000	23.98	11900	19.10

fan performance curve to allow for installation losses.

4-12.3 FAN SELECTION EXAMPLES

Example 1:

Given:

1. Fan speed $N_f = 5000$ to 7000 rpm
2. Cooling airflow CFM required = $8,100$ cfm at 0.067 lbm/ft³ ($130^\circ F$)
3. Static pressure rise $\Delta P_s = 10.8$ in. water

Determine the type of fan required for these conditions.

Solution: Find the specific speed N_s from Eq. 4-11

$$N_s = \frac{5000(8100)^{0.5}}{(10.8)^{0.75}} = 75,534 \text{ at } 500 \text{ rpm}$$

$$N_s = \frac{7000(8100)^{0.5}}{(10.8)^{0.75}} = 105,748 \text{ at } 7000 \text{ rpm}$$

Referring to Fig. 4-4 indicates that, for a specific speed range of 75,534 to 105,748, a vane-axial fan will meet the system requirements with the best efficiency. A fan manufacturer is then consulted to obtain fan performance curves similar to the curves in Appendix B which will satisfy the required conditions of airflow, static pressure, and speed.

Superimposition of the system resistance or characteristic curve on the fan performance curve, as shown in Fig. 4-10, indicates that this particular fan will meet the required airflow and static pressure rise (Point A) at a fan speed of 6220 rpm (Point B); the required fan horsepower is 22.5 bhp (Point C). An increase in fan speed would provide an increase in airflow and static pressure rise if a reserve safety factor is desired. This reserve

can be determined by the use of the applicable fan laws from Table 4-3.

A method of determining the approximate size of fan required is contained in Ref. 12. There is only one size fan of each type that will operate at the point of maximum efficiency for any given rating. This fan must be operated at a certain speed to produce the required rating. A smaller size fan could be selected that would have to operate at a higher speed or a larger size fan could be selected that would have to operate at a lower speed. In either case, efficiency would be lower than that for the optimum size fan.

Example 2:

If the cooling system design requires a single fan operating at fixed speed, and the system resistance characteristics are defined by a single curve, the fan selection is straightforward. The selection resolves into finding the most efficient fan that will deliver the required CFM at the required ΔP_s of the system.

For example, if 5000 cfm is required for a cooling system and the system resistance characteristics result in ΔP_s of 2 in. of water, an overlay of fan performance curves as shown in Fig. 4-11 indicates that the required airflow is obtained, as shown by the intersection of the curves at Point A, if the fan is driven at 2000 rpm. If the system air resistance is 2.6 in. of water and an airflow rate of 5000 cfm, the same fan can meet this requirement if the speed is increased to 2200 rpm as shown by Point C on Fig. 4-11.

Restriction or plugging of the cooling system would raise the system resistance and cause the airflow to decrease and the static pressure rise to increase along the fan curve until it reached a maximum at Point B. Further restriction would cause the operating point to enter the stall region in the dip of the fan performance curve. This situation can be corrected by an increase in fan speed. This increases the CFM , fan static pressure rise, and fan horsepower but the required airflow

AMCP 706-361

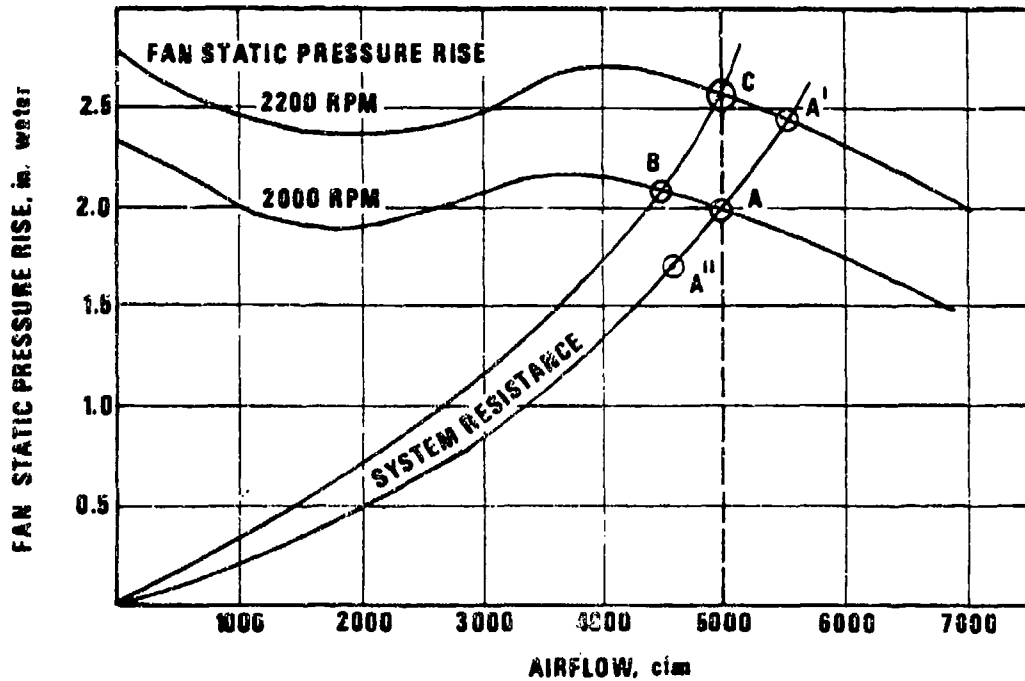

Figure 4-11. Cooling Fan Selection Curves

will be available with the plugged components.

4-12.4 FAN OVERSPECIFICATION

It should be pointed out that the selection of a fan based on (1) a written specification indicating *CFM* and (2) static pressure rise on an overstatement of required *CFM* may be inadequate for the intended application. A specification might be written for a fan to deliver 6000 cfm at a static pressure rise of 6 in. of water when the actual requirement might only be 4000 cfm at 6 in. of water static pressure rise. Fig. 4-12 illustrates a fan performance curve that seems to meet the specification (Point B). However, this point on the performance curve should not be used because it is in the stall region where the airflow may be unstable (see Fig. 4-1(D)) and the efficiency is low. Moreover, in some cases

the actual airflow delivered is less than that required.

If a safety margin is necessary, the safest method is to overstate the static pressure by a reasonable amount. In doing this, the user must pay for the margin in higher fan horsepower requirements and a possible increase in the fan size or decrease in reliability.

4-13 FAN INSTALLATION

The installation of the cooling fan is determined by the vehicle cooling system design and may vary from a simple conventional type installation as shown in Fig. 4-4 to a complex installation as shown in Fig. 4-13. Space limitations and vehicle performance requirements often are met best by unconventional installations, particularly in combat

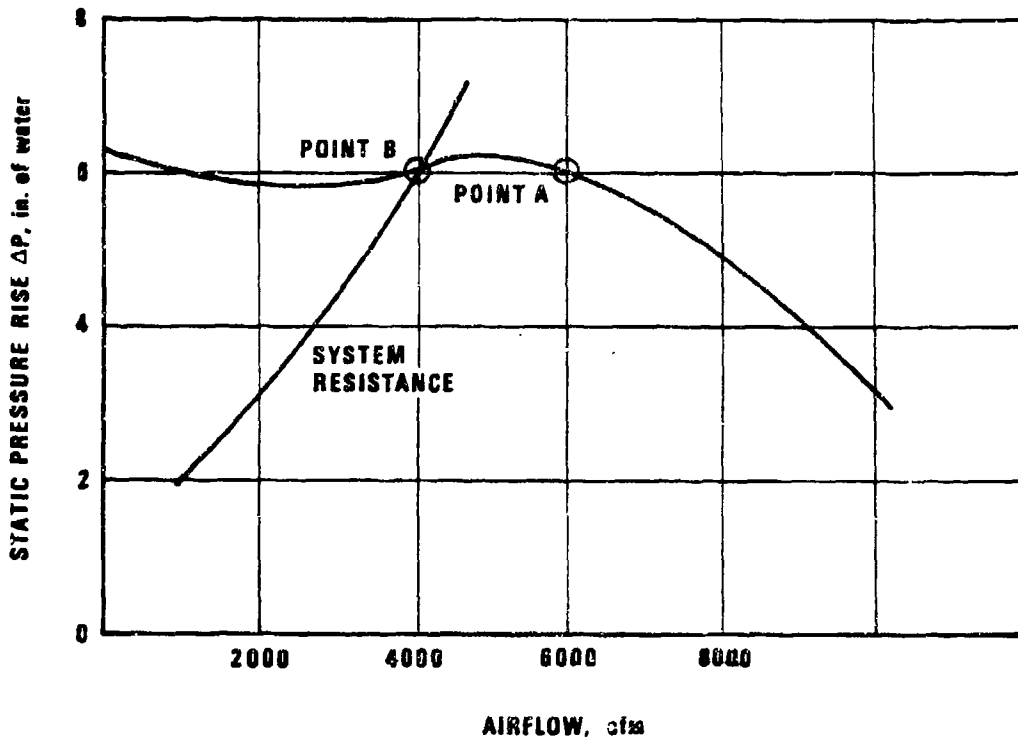

Figure 4-12. Fan Overspecification Curve

vehicles. Regardless of the type of installation, the effects of a number of basic fan installation parameters must be observed. These parameters include fan tip clearance; fan position in relation to the shroud, radiator, and/or engine shrouding design; and air inlet discharge conditions.

Optimization of the airflow path, as well as the fan installation, is difficult to achieve in practice. Recognizing this, the cooling system engineer can evaluate several options that can partially compensate for less than desirable conditions.

A disadvantage of the suction mode system is the higher temperature of the inlet air to

the cooling fan and radiator, after absorbing heat in the engine compartment, which will require the use of a larger heat exchanger and a higher capacity fan.

In either one of the previously described cooling systems, the cooling fan can be used as a suction or blowing fan as shown in Fig. 4-14. A blowing fan is defined as a fan that blows air through the radiator or heat exchanger, and a suction fan is defined as a fan that draws the air through the radiator or heat exchanger.

Blowing fans are generally more efficient in terms of power expended for a given air mass flow since they will always operate with lower

AMCP 706-361

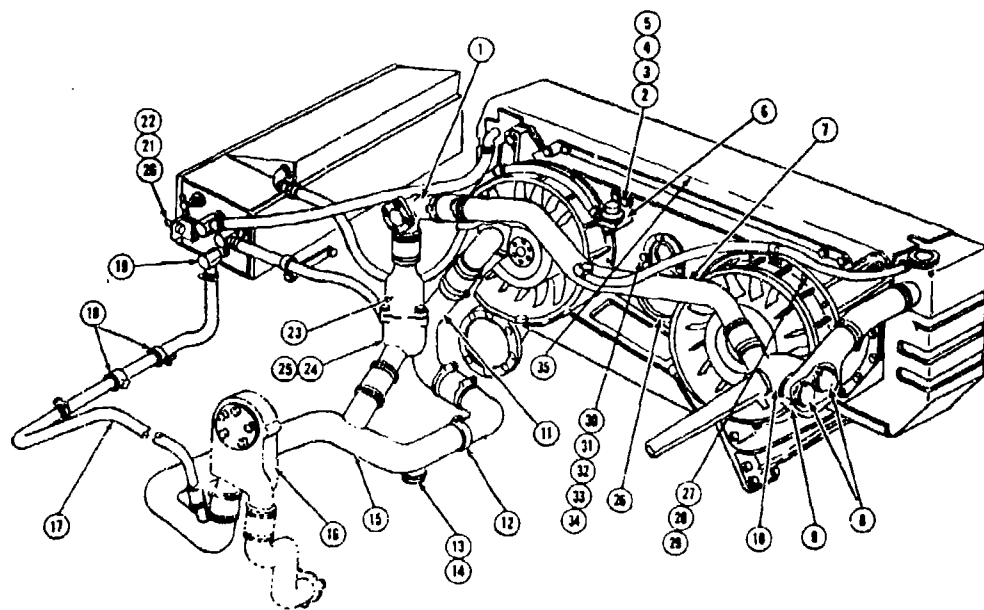

- | | |
|------------------|-----------------------|
| 1. HOUSING | 19. ELBOW |
| 2. BLOCK | 20. SCREW |
| 3. SCREW | 21. WASHER |
| 4. WASHER | 22. WASHER |
| 5. NUT | 23. HOUSING |
| 6. SCREW | 24. HOUSING |
| 7. TUBE | 25. THERMOSTAT |
| 8. THERMOSTAT | 26. SHROUD, RADIATOR |
| 9. HOUSING | 27. SCREW |
| 10. HOUSING | 28. WASHER |
| 11. TUBE | 29. WASHER |
| 12. CLAMP | 30. GASKET |
| 13. GASKET | 31. RETAINER |
| 14. DRAIN PLUG | 32. SCREW |
| 15. TUBE | 33. WASHER |
| 16. COOLANT PUMP | 34. NUT |
| 17. TUBE | 35. RADIATOR ASSEMBLY |
| 18. CLAMP | |

Figure 4-13. Dual Cooling Fan Installation (Ref. 8)

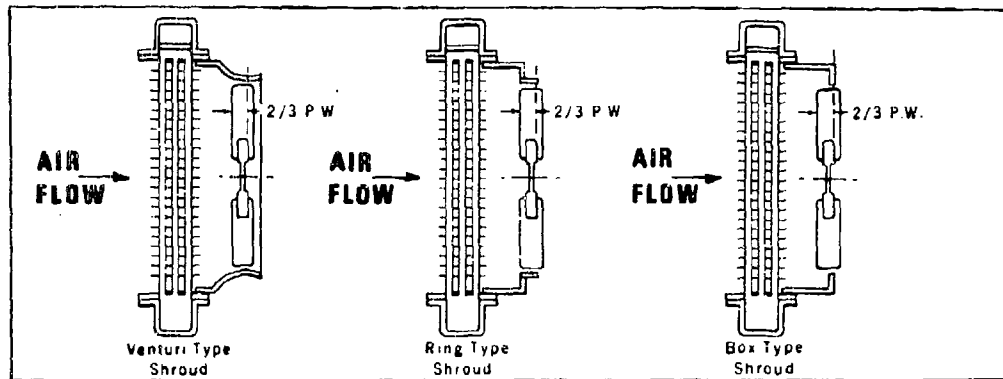

(A) SUCTION MODE

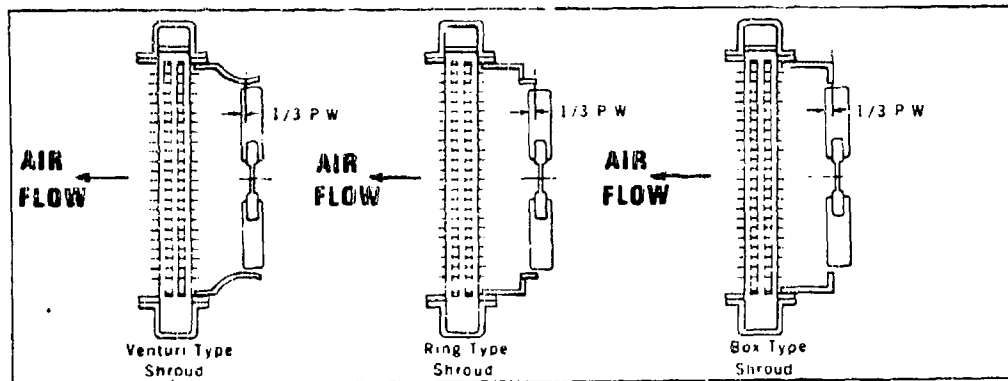

(B) BLOWING MODE

P W - Projected Width

*Figure 4-14. Fan Shroud Types and Relative Fan Blade Positions
 (Courtesy of Cummins Engine Co., Inc.)*

temperature air as compared to a suction fan. The air entering the suction fan is heated as it passes through the radiator. A blowing fan will receive air at a relatively lower temperature.

regain is possible with a blowing fan. The total pressure and the horsepower requirements of the fan are reduced in direct proportion to the static pressure regain in the more efficient blowing fan system.

A certain percentage of static pressure

For example, whether a fan is used in a

AMCP 706-361

blowing or suction mode (see Fig. 4-14) can have a great impact on the effectiveness of the cooling system. This choice should be made during the preliminary design phase. A blowing fan handles lower temperatures and is thus able to provide a greater weight flow rate of air for the same horsepower as compared with a suction fan. In addition, a certain percentage of static regain is possible with a blowing fan. The total pressure and the horsepower requirements of the fan are reduced in direct proportion to the static regain in the more efficient blowing fan system. The blowing fan requires a low angle transition (approximately 15 deg included angle) from fan to heat exchangers in order to prevent "hot spots".

The suction fan (Fig. 4-14(A)), however, is able to draw air through a heat exchanger with more uniform distribution and can be located very near the heat exchanger.

Reasons for the use of a blowing fan (Fig. 4-15(D)) include:

1. Lowering the engine compartment air temperature
2. Minimizing vapor lock in fuel system
3. Minimizing fire hazards
4. For combat vehicles, an exhaust axial blower fan usually is used to maintain a negative pressure in the power plant compartment. This negative pressure prevents noxious gases from entering the crew compartment during combat operations when explosive materials are ingested into the power plant compartment.

In order to prevent cooling air recirculation, the general direction of cooling airflow in the power plant compartment should be

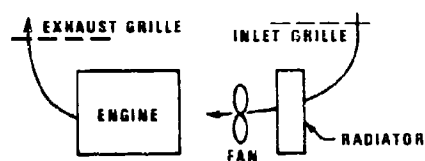

(A) SUCTION FAN LOCATED IN HEATED AIR

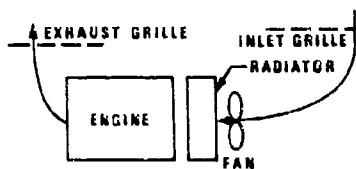

(B) BLOWING FAN LOCATED IN COLD AIR

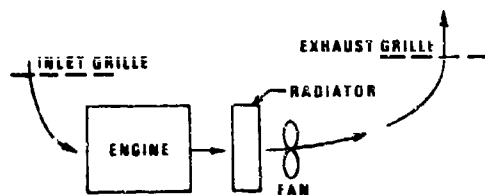

(C) SUCTION FAN LOCATED IN HEATED AIR

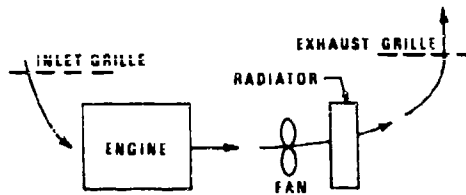

(D) BLOWING FAN LOCATED IN HEATED AIR

Figure 4-15. Optional Cooling Fan Locations

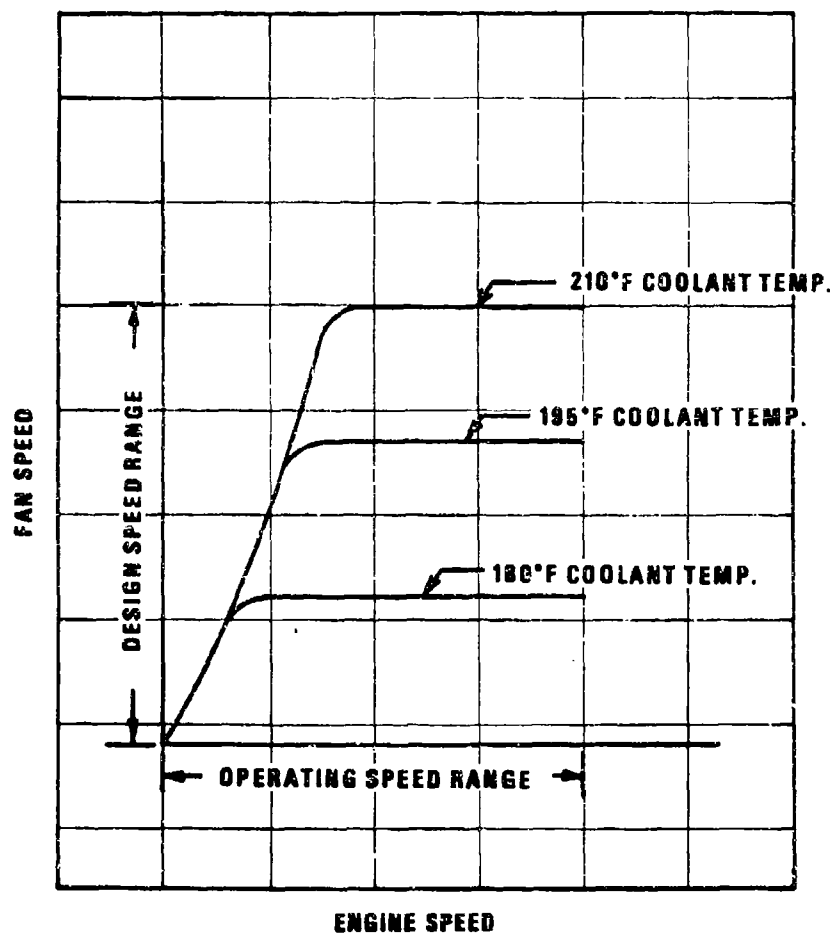

Figure 4-16. Hydraulic Fan Drive Performance Characteristics

opposite to that of the primary vehicle travel direction as shown in Fig. 6-16.

Fig. 4-15 shows optional locations of suction and blowing fans mounted both behind and in front of the radiator.

Transition sections between the fan and the intake and exhaust grilles are important aspects of cooling system design. Generally, a

15-deg or less transition angle should be maintained to minimize expansion and friction losses. Abrupt changes of flow cross section and ducts, the location of grilles or heat exchangers too near the cooling fan, and obstructions such as belts, pulleys, plumbing, and mounting brackets will create turbulence in the moving air and decrease the efficiency of the air moving system. The use of aerodynamically correct inlet housings should

AMCP 706-361

be considered when no inlet duct is required (see Fig. 4-3(D)). Actually, it usually is not possible to provide for aerodynamic ducting because of overall size considerations.

A detailed discussion of resistance in the vehicle cooling system is found in Chapter 7.

The system designer should consider locations for protection of the fan to prevent damage caused by objects entering the fan from outside the vehicle or the breaking away of components upstream of the fan. Debris deflectors are discussed in Chapter 1 and grille screens are discussed in Chapter 6.

4-14 FAN SHROUDING

A fan shroud normally is used to provide a smooth transition and uniform airflow over the heat exchanger or radiator core, improve the fan efficiency, and minimize air recirculation at the fan.

Three types of fan shrouds currently in use are illustrated in Fig. 4-14, namely:

1. Venturi
2. Ring
3. Box.

Maximum fan efficiency normally can be obtained with the venturi type shroud when the fan blade tip clearance is 1.5 percent or less of the fan diameter. The M561 cooling performance was improved 10 deg F by changing from a ring type to a venturi type fan shroud. The tip clearance may present installation difficulties if used with belt drives that require tension adjustments. Clearance problems also may occur when the radiator and shroud are mounted on a separate frame from the engine and fan. Air delivery is appreciably reduced with any type of shroud when the fan blade tip clearance exceeds 2.5 percent of the fan diameter.

The ideal position of the fan in the shroud is dependent on the individual installation and is determined best by experiment. The most acceptable practice is to put two-thirds of the projected blade width (P.W.) inside the shroud for suction fans and one-third for blowing fans. These installations are shown in Fig. 4-14. For taper blade or curved tip fans, the projected width should be considered at the narrowest part of the projected width of the blade. Normally, the blade is located from 1 to 4 in. away from the radiator (heat exchanger) core.

4-15 FAN DRIVES AND SPEED CONTROLS

A variety of fan drive options is available to the cooling system designer. The relative merits and disadvantages of each type must be considered if the vehicle cooling system design requires deviation from the conventional automotive type installation. Fan drives generally may be classified as mechanical, electrical, or hydraulic with variations existing within these general classifications.

4-15.1 MECHANICAL DRIVES

Mechanical fan drives can be operated at the drive speed, or any ratio either above or below it, by means of gears or pulleys. On-off engagement clutches thermostatically controlled to engage and disengage at specific temperatures commonly are used. The MERDC 20-Ton Rough Terrain Crane uses a thermostatic control that actuates an air operated clutch to engage when the coolant temperature increases to 183°F and disengages when the coolant temperature decreases to 178°F. An automatic engine shut-off is actuated if the coolant temperature should reach 220°F.

A centrifugally engaged cooling fan drive clutch is used in the AVI-1790-8, AVDS-1790-2, and AVCR-1100 air-cooled Tank engines. An example of this drive is shown in

Fig. 1-26. The engagement and slip characteristics for this fan drive are determined by the centrifugal force, generated by the balls, that is applied to the pressure plate and disc assemblies.

4-15.1.1 Belt Drives

Engine cooling fans driven by V-belts are common today, although higher performance fans with speeds above 8000 rpm make extensive use of cog type belts for power transmission. This type of belt employs drive lugs to provide a positive, no-slip drive. Cog type belts eliminate the need for matched sets of V-belts and are stronger and capable of sustaining higher running speeds without slippage. Table 4-5 defines some of the characteristics of the belt-drives for cooling fans. An illustration of a belt driven propeller fan is shown in Fig. 1-4.

4-15.1.2 Shaft Drives

If the fan can be located on the centerline of an accessory drive pad, a direct shaft drive by spline or quill shaft connection is possible. Frequently, however, the location of the accessory drive pad requires the fan to be driven through a right-angle gearbox. The latter arrangement affords the designer some latitude in determining fan size in that the fan speed can be increased or decreased through the gearbox. This type of fan drive is shown in Fig. 1-18.

Shaft drives have several advantages. They provide for disconnection as well as connection. They also may provide sufficient flexibility to protect shafts and bearings against misalignment, shock loads, or torsional vibration. Some designs may include slip features to protect the shafts against overload. The couplings also may include variable speed features.

4-15.1.3 Gearbox Drives

4-15.1.3.1 Single Speed

Gearbox drives for fans have better

reliability than belt drives. The drive units are less expensive than hydraulic drives or electric drives. Like all mechanically driven fans, gearbox driven fans must be located near the power plant and are slaved to power plant speed. For example, gearbox driven fans are used for engine cooling on the M109 vehicle and the XM803 Experimental Tank for engine and transmission cooling.

4-15.1.3.2 Multispeed

Multispeed planetary gear fan drives have been evaluated for military vehicles. The primary advantage of this type of drive is that the fan power requirement is minimum when the cooling load is low. The fan speeds are automatically controlled by a thermostatic element as described in par. 4-15.3.

4-15.2 ELECTRIC DRIVES

By selecting an electrical fan drive, the designer is able to install heat exchangers and fans in a location where space is available and an electrical connection can be made. Utilization of the vehicle electrical system, normally 24 VDC, is the most direct and easily available means of supplying power to cooling fans. Rotating DC machines can be a problem, however, because of the radio interference, dust sealing, high temperature, high vibration, and overhaul requirements caused by the brushes used for commutation. The weight and size of electrical fan drives generally limit their use to crew compartment ventilation, gun purging, electronics cooling, etc.

By means of an alternator or DC to AC solid state inverter, it is possible to eliminate contact brushes and extend electric motor overhaul periods. Inverter driven fans, fuel pumps, and other devices of the type that have been used in aircraft applications also have been used for commercial automotive applications.

Table 4-6 indicates typical characteristics for AC and DC electrical fan drives.

TABLE 4-5

BELT DRIVEN FAN CHARACTERISTICS (BELT DRIVE VS HYDRAULIC DRIVE)

<p>1. <u>ADVANTAGES</u></p> <ul style="list-style-type: none"> a. Readily available drive for engine and transmission cooling b. Belts and pulley losses are low c. Performance range changed by pulley change d. Least expensive e. Light Weight f. Proven design 	<p>2. <u>DISADVANTAGES</u></p> <ul style="list-style-type: none"> a. Obstruction caused by belts and pulleys. Ducting is difficult. b. Limited location c. Sometimes requires matched sets of V-belts d. Side loads on bearings e. Broken or damaged belt area common occurrence f. Performance varies with engine speed
--	--

Courtesy of Joy Manufacturing Company

4-15.3 HYDRAULIC DRIVES

The function of the hydraulic variable speed fan drive is to stop fans for fording, to serve as a cold weather warm-up aid, and to minimize fan horsepower requirements. Hydraulic fan drives are approximately one-third the weight of an equivalent electric fan drive, and the flexibility of mounting allows the designer to locate the heat exchanger and fan where space is available. A hydraulically driven fan normally is driven in proportion to cooling requirements independent of engine speed. This is done by installing a temperature sensing element in the fluid to be cooled. This element basically controls hydraulic flow and/or pressure. When the cooling system temperature increases, the

hydraulic pressure and/or volume are varied and the fan speed is increased. Various control systems are available to provide specified fan speed characteristics. The location of the hydraulically driven fan is not determined by the drive limitations imposed for mechanically driven units. The fan drive is often powered by the fluid it cools.

If a mechanical, nonmodulated fan drive is used to provide adequate cooling airflow at low engine speeds, a large amount of additional power is required at high speeds since the fan horsepower is proportional to the cube power of fan speed. With a hydraulic drive, the fan speed can be controlled with a hydraulically modulated drive to minimize the horsepower required. Hydraulic couplings

TABLE 4-6

ELECTRICALLY DRIVEN COOLING FAN CHARACTERISTICS (DC vs AC)

DC DRIVE

ADVANTAGES

Optional location
 Optional speed
 Power readily available
 Easily ducted
 Many available designs
 Low cost
 Performance independent
 of engine speed

DISADVANTAGES

Short Time Between Overhaul
 Brushes
 Radio interference
 Performance is limited by
 motor HP and speed
 Lower average efficiency than
 that of an AC Drive
 Heavier than hydraulic or
 AC drive
 Difficult to make explosion
 proof
 Dust
 Temperature } Development needed
 Vibration }

AC DRIVE

ADVANTAGES

Optional location
 Optional speed
 Excellent Time Between
 Overhaul up to 4000 hr
 Easily ducted
 Many available designs
 Performance independent
 of engine speed
 Higher average efficiency
 than DC Drive

DISADVANTAGES

Inverter required if AC not
 available
 Most costly
 Requires more axial length
 than belt or shaft drive
 Not yet proven in vehicle
 applications
 Dust
 Temperature } Development needed
 Vibration }

Courtesy of Joy Manufacturing Company

AMCP 706-361

transmit power without any mechanical contact of parts. The input power is used to drive the impeller. This applies the force to accelerate the fluid. The fluid decelerates in the runner and applies the forces to drive the output shaft and connected load. There is always some relative rotation or slip between the impeller and runner. The minimum slip may range from 2 to 5 percent of the input shaft speed. Control is maintained by adjusting the amount of fluid in the working circuit. A pump delivers fluid from a sump through a cooler to the impeller. A constant pressure hydraulic fluid supply system may be used with an adjustable regulator or compensator to vary the pressure setting. A thermostatic element installed in the engine coolant provides the medium for actuating the regulator/compensator. This system allows the fan speed to be determined by engine coolant outlet temperature to provide only the amount of cooling that the engine requires. As shown in Fig. 4-16, the fan can operate at any speed, between the design limits, dependent on the cooling required.

Table 4-7 indicates typical characteristics of hydraulic fan drives and typical fan drive motor sizes are shown in Figs. B-30 through B-33.

4-15.4 VISCOUS FAN DRIVE

Self-contained viscous variable speed fan drives are available also. This type of drive may use a silicone fluid as the actuating medium controlled by a heat sensor. Fig. 4-17 illustrates the self-contained viscous variable speed fan drive used on the M551 vehicle. A representative performance curve for this type of fan drive is shown in Fig. 4-18.

Viscous drive fan speeds are varied as a function of the fan air temperature. When the temperature (and cooling requirement) is low, the viscous drive slips and the fan runs at a speed lower than the input shaft speed. Conversely, when the temperature (and cooling requirement) increases, the drive fully

engages and the fan operates at speeds approaching the input shaft speed (some slippage always occurs).

The viscous drive fan has the advantage of minimizing the fan power requirements when the cooling loads are less than maximum. The disadvantage of this drive is the additional length required for installation and added cost.

4-15.5 VARIABLE BLADE-PITCH FAN¹

The pitch or blade angle of the fan can be changed to control the volumetric airflow rate much like the pitch of an airplane propeller is changed during the flight. The pitch control mechanism may be operated by a pneumatic, electric, or hydraulic system actuated by various sensing devices at appropriate locations.

4-16 FAN DRIVE NOISE

The fan drive types that follow are listed in their general order of decreasing noise level:

1. Hydraulic drive
2. Gearbox drive
3. DC Motor
4. Belt drive
5. AC Motor
6. Shaft drive.

Generally, for quieter operation, vibration-isolation mounts should be provided for the fan installation wherever possible. A high degree of noise isolation can be obtained with very flexible mounts and flexible duct connections, however, the installation must be such that this flexibility does not cause interference during rough terrain operations.

¹Courtesy of Mr. Edward J. Ramhic

TABLE 4-7

HYDRAULIC COOLING FAN DRIVE CHARACTERISTICS (HYDRAULIC vs MECHANICAL)

<u>ADVANTAGES</u>	<u>DISADVANTAGES</u>
Optional location	Requires higher capacity pump and reservoir
Drive systems generally available	Generally results in noisiest fan
Optional operating speeds	Requires more axial length than belt or shaft drive
Performance can be varied according to cooling requirements	Requires clean hydraulic system
Easily ducted	Lower average percent efficiency than a mechanical drive
Approximately one-third weight of electric fans	Expensive
Generally independent of engine speed (after a minimum engine speed is reached)	

Courtesy of Joy Manufacturing Company

4-17 EXHAUST EJECTORS

The energy of the exhaust gases can be used directly without supplementary rotational devices for the movement of cooling air. This can be achieved by the use of an ejector.

The ejector uses the kinetic energy of the exhaust gas to draw cooling air. A diagram of an ejector is shown in Fig. 4-19. Exhaust gases are discharged at the venturi throat of the ejector where the surrounding cool air is

entrained and the mixture discharges from the end of the ejector to the atmosphere. The ejector is a venturi throat section surrounding the end of the exhaust pipe. A conical extension called a diffuser sometimes is added. The part is extremely simple. It contains no moving parts and does not require frequent servicing.

A number of design parameters become important in the design of an ejector. These are exhaust gas jet velocity, ratio of cooling air mass flow rate to exhaust gas mass flow

AMCP 706-361

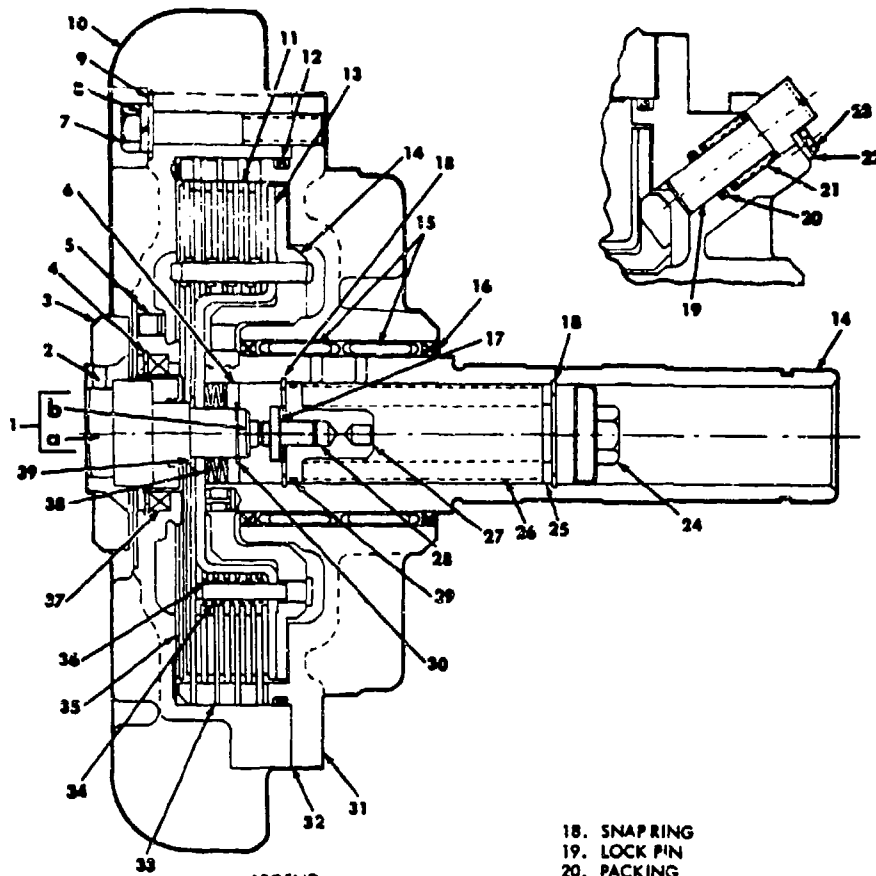

LEGEND

- | | |
|---|---|
| <p>1. TEMPERATURE CONTROL ASSY
 a. THERMOSTATIC ELEMENT WITH HEAT DEFLECTOR
 b. PISTON
 2. SETSCREW
 3. HEAT TRANSFER ELEMENT
 4. SNAP RING
 5. FILLER PLUG
 6. RECESSED WASHER
 7. SCREW
 8. LOCK WASHER
 9. FLAT WASHER
 10. COVER
 11. FRICTION PLATE
 12. PACKING
 13. DRIVE CUP
 14. DRIVE FLANGE AND SHAFT ASSY
 15. NEEDLE BEARING
 16. SEAL
 17. SHIM (AS REQUIRED)</p> | <p>18. SNAP RING
 19. LOCK PIN
 20. PACKING
 21. HELICAL SPRING
 22. LOCK PLATE
 23. SCREW
 24. GREASE RETAINER
 25. FLAT WASHER
 26. HELICAL SPRING
 27. SEAL PLUG
 28. CALIBRATION PIN
 29. SEAL PLUG PACKING
 30. RETAINING RING
 31. CLUTCH HOUSING
 32. COVER GASKET
 33. DRIVE DISC
 34. HELICAL SPRING
 35. FRONT PLATE (BONDED)
 36. SNAP RING
 37. OIL SEAL
 38. SPRING WASHER
 39. FIBER WASHER</p> |
|---|---|

Figure 4-17. Viscous Fan Drive (Ref. 8)

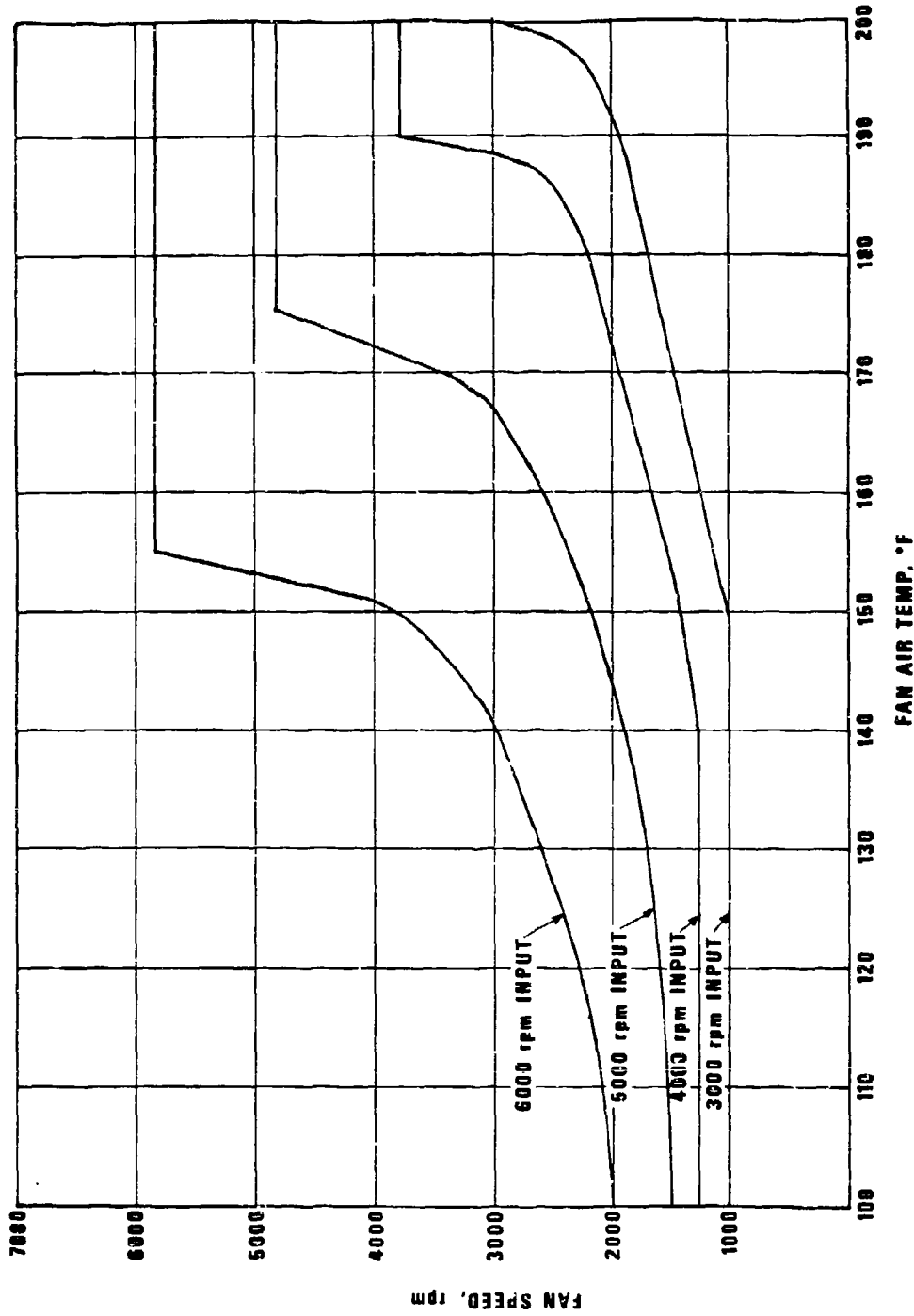

Figure 4-18. Viscous Fan Drive Performance Characteristics
(Courtesy of Schwitzer Division, Wallace Murray Corporation)

AMCP 706-361

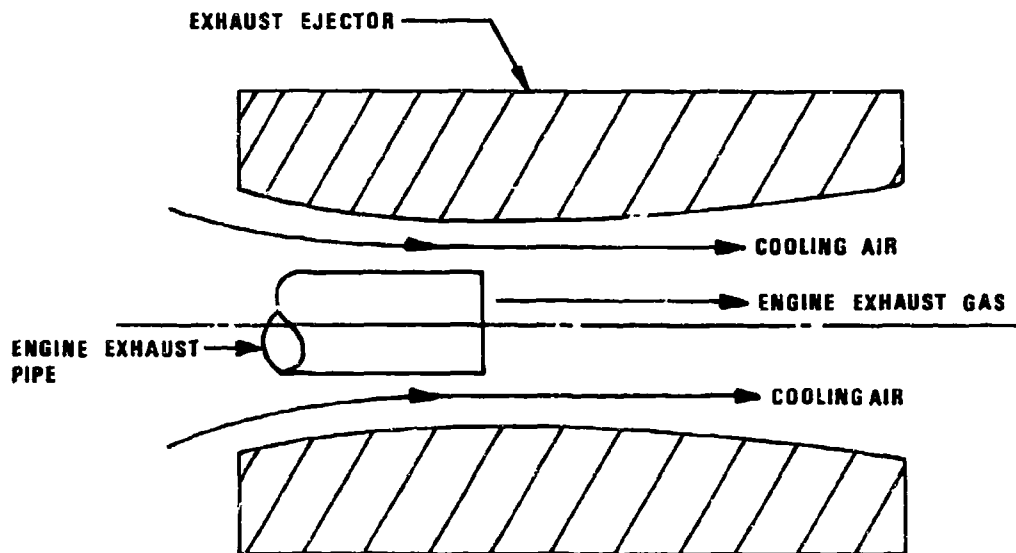

Figure 4-19. Exhaust Ejector

rate, ratio of mixing chamber duct cross-sectional area to exhaust gas nozzle cross-sectional area, length of straight section in the mixing chamber, length of diffuser, angle of diffuser, and position and shape of the exhaust gas nozzle used—all determine the back pressure on the engine. Preliminary studies of back pressure, horsepower, and nozzle area usually are made to determine the engine power loss with decreasing nozzle size. The engine manufacturer usually will specify the maximum allowable exhaust back pressure.

A series of investigations of exhaust gas ejectors for a model AOS-895-3 air-cooled, spark ignition engine were conducted by the University of Michigan (Ref. 9). The results of the investigation indicated that the ejector alone would not cool the engine at full load. Fig. 4-20(A) shows the theoretical and actual cooling air pressure rise ΔP for 3:1 and 5:1

cooling air weight to the exhaust gas weight ratios w_a/w_e . The required ratio for adequate engine cooling is approximately 8:1. As shown in Fig. 4-20(A), an increase in w_a/w_e is obtainable only with a reduction in cooling air static pressure drop. It also illustrates that an ideal duct area exists for each value of w_a/w_e .

Exhaust ejectors have the advantages of simplicity, low cost, minimum service and maintenance requirements, and have no moving parts. The disadvantages of exhaust ejectors are the limited amount of air moved without creating excessive engine exhaust back pressure and corresponding power loss (see Fig. 4-20(B)), and the limited static pressure rise ΔP that can be obtained. Additional exhaust ejector design and performance information can be found in Refs. 10 and 13.

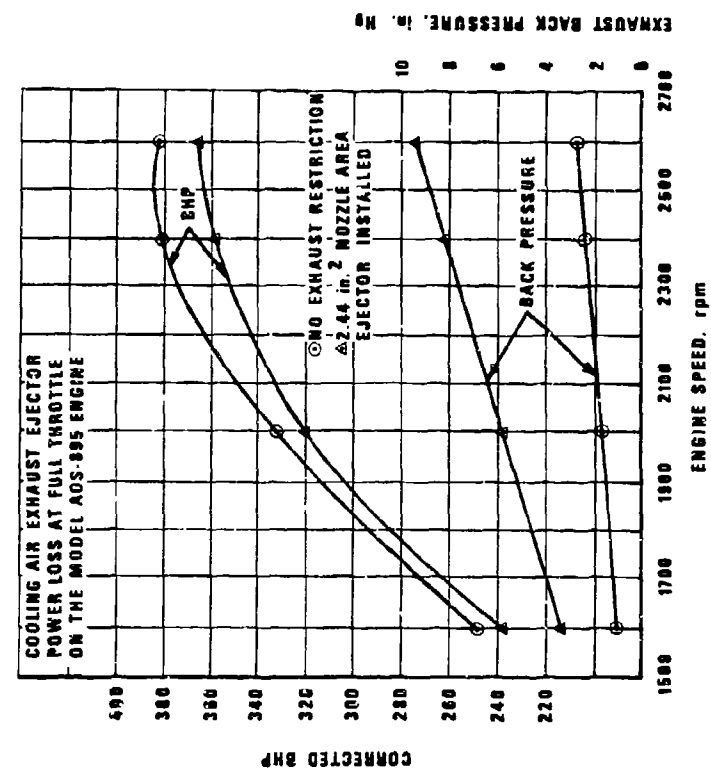

w_a = cooling air flow rate
 w_e = exhaust gas flow rate

(A) STATIC PRESSURE RISE

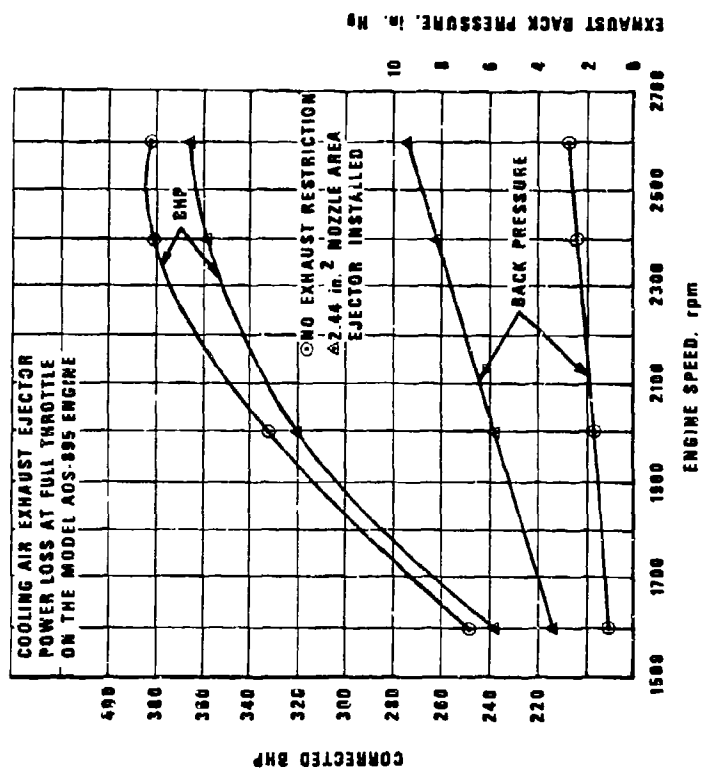

(B) ENGINE POWER LOSS

Figure 4-20. Exhaust Gas Ejector Performance (Ref. 9)

AMCP 708-381

REFERENCES

1. A. J. Stepanoff, *Turboblowers*, John Wiley and Sons, New York, N.Y., 1964.
2. *Aerospace Applied Thermodynamics Manual*, SAE, New York, N.Y., 1968.
3. Robert Jorgensen, *Fan Engineering*, 7th Edition, Buffalo Forge Company, Buffalo, N.Y., 1970.
4. Cyril M. Harris, *Handbook of Noise Control*, McGraw-Hill Book Company, Inc., New York, N.Y., 1957.
5. James R. Pharis, *Kool Pak - A High-capacity, Quiet, Thermostatically Modulated Cooling System for Mobile Vehicles*, Paper No. 720715, SAE, New York, N.Y., September 1972.
6. Harold F. Farquhar, *Fans and Blowers*, Lau Industries, Dayton, Ohio, 1972.
7. Robert Pollack, "Selecting Fans And Blowers", *Chemical Engineering*, 86-100, January 22, 1973.
8. TM 9-2350-217-10, *Operators Manual For Howitzer, Light, Self-propelled, 105 mm, M109*, December 1969.
9. Frank Schwartz and Robert Eaton, *Investigation of Exhaust Gas Ejectors for the AOS-895-3 Engine*, University of Michigan, Ann Arbor, Mich., May 1955.
10. Julius Mackerle, *Air-Cooled Motor Engines*, Cleaver-Hume Press Ltd., London, England, 1958.
11. Carlos C. Chardon and Ira J. Roy, "Packing The Maximum Fan in the Minimum Space", *Machine Design*, (September 1973).
12. J. Barrie Graham, "Methods of Selecting & Rating Fans", *ASHRAE Journal*, January 1972.
13. H. S. Sandu, *Analysis of The Cooling Air Ejector on the AVCR-1100-3B Engine*, Report No. HSS-108, Teledyne Continental Motors, Warren, Michigan, June 1971.

BIBLIOGRAPHY

- J. Barry Abraham, *Fan Application, Testing and Selection*, ASHRAE Symposium Bulletin, American Society of Heating, Refrigeration and Air Conditioning Engineers, New York, N.Y., January 1970.
- Austin H. Church, *Centrifugal Pumps and Blowers*, John Wiley & Sons, Inc., New York, N.Y., 1950.
- Theodore Baumeister, *Marks Standard Handbook for Mechanical Engineers*, McGraw-Hill Book Company, New York, N.Y., 1967.
- Engineering Bulletin*, Rotron Manufacturing Company, Woodstock, N.Y.
- J. M. Harlock, *Axial Flow Compressors*, Butterworth Scientific Publications, London England, 1958.
- R. A. Wallis, *Axial Flow Fans*, Academic Press, New York, N.Y., 1961.

CHAPTER 5

CONTROL AND INSTRUMENTATION OF THE COOLING SYSTEM

The function of a vehicle cooling system and methods of cooling control are discussed, and the construction and performance characteristics of various components are described. Operation of thermostats, surge tanks, radiator caps, shutters, heaters, temperature sending units, coolant level and aeration indicators, and related cooling system controls are presented.

5-1 FUNCTIONS OF THE COOLING SYSTEM

The functions of a vehicle cooling system include:

1. Control of engine temperature within acceptable limits
2. Control of the transmission, torque converter, clutch, and/or retarder temperatures as applicable within acceptable limits
3. Dissipation of heat generated by the air conditioning system, other accessories, and/or subsystems
4. Provision of heat for the comfort of the occupants in cold weather
5. Control of exhaust emissions.

As previously discussed in par. 1-1.1, an engine running too hot will destroy itself or running too cold will cause engine damage, inefficiencies, stalling, and increased emission of pollutants. The importance of a properly designed cooling system cannot be overemphasized. To accomplish these design goals, adequate controls must be incorporated into the cooling system.

5-2 PRESSURIZED LIQUID-COOLANT SYSTEMS

Most of the modern vehicle liquid-coolant

systems are pressurized systems. Pressurized simply means that the cooling system is equipped with a pressure cap so that the coolant pressure in the system may be raised to a predetermined maximum condition. Fig. 5-1 illustrates the effect of increased coolant pressure on the boiling point of water and ethylene glycol-water solutions. Generally, for each pound of additional pressure in the system, the boiling point of the coolant will rise about 3 deg F.

5-2.1 COOLANT OPERATING TEMPERATURE

A pressurized system can raise the coolant operating temperature without boiling and will cause the engine to operate at a relatively higher temperature with higher thermal efficiency. It will also cause the radiator to operate at higher coolant temperatures with corresponding higher heat transfer capability.

5-2.2 COOLANT PUMP CAVITATION

System pressurization discourages the tendency for the coolant pump to cavitate when coolant temperatures are high and create greater vapor pressures. The coolant pressure at the pump inlet reduces cavitation. This prevents the coolant pump from becoming vapor bound, which could result in a complete breakdown of coolant flow through the radiator preceding total failure of the cooling system (see Chapter 7).

AMCP 706-361

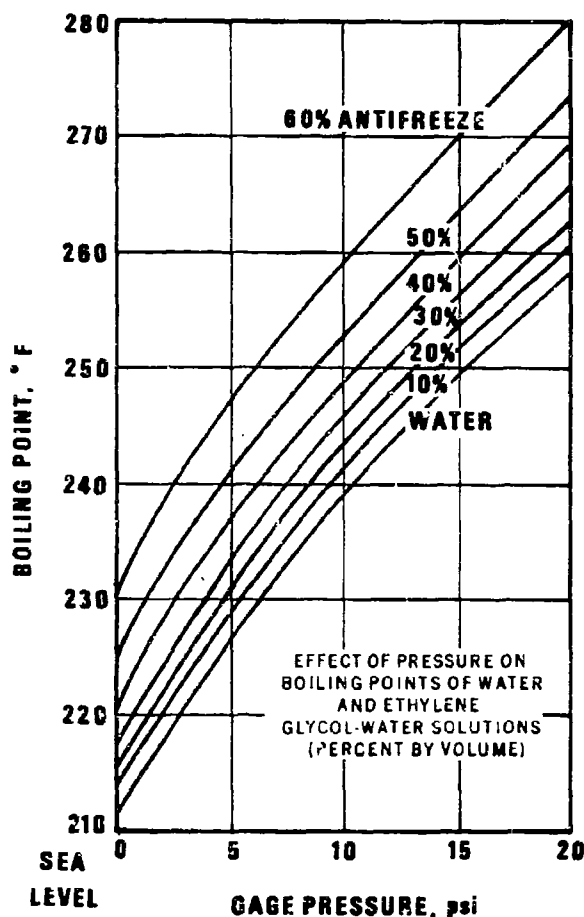

Figure 5-1. Effect of Increased Cooling System Pressure on Boiling Points of Water and Antifreeze Compound Solutions (Ref. 4)

5-2.3 AFTER BOIL

The pressurized system also prevents the loss of coolant through "after boil". After boil is caused when the heat stored in the engine block during a high speed, wide-open throttle run is transferred to the coolant when the engine is stopped immediately or left to idle. Even during normal operation, the pressurized system will prevent overflow and evaporation losses of coolant.

5-2.4 ALTITUDE OPERATION

Pressurization allows the cooling system to operate practically independent of altitude. For example, the boiling point of water in an atmospheric cooling system is only 194°F at 10,000 ft elevation. In going up a mountain, a considerably larger radiator obviously would be required with a nonpressurized radiator than with a pressurized type. Actually a 14-psi cap at the base of the mountain

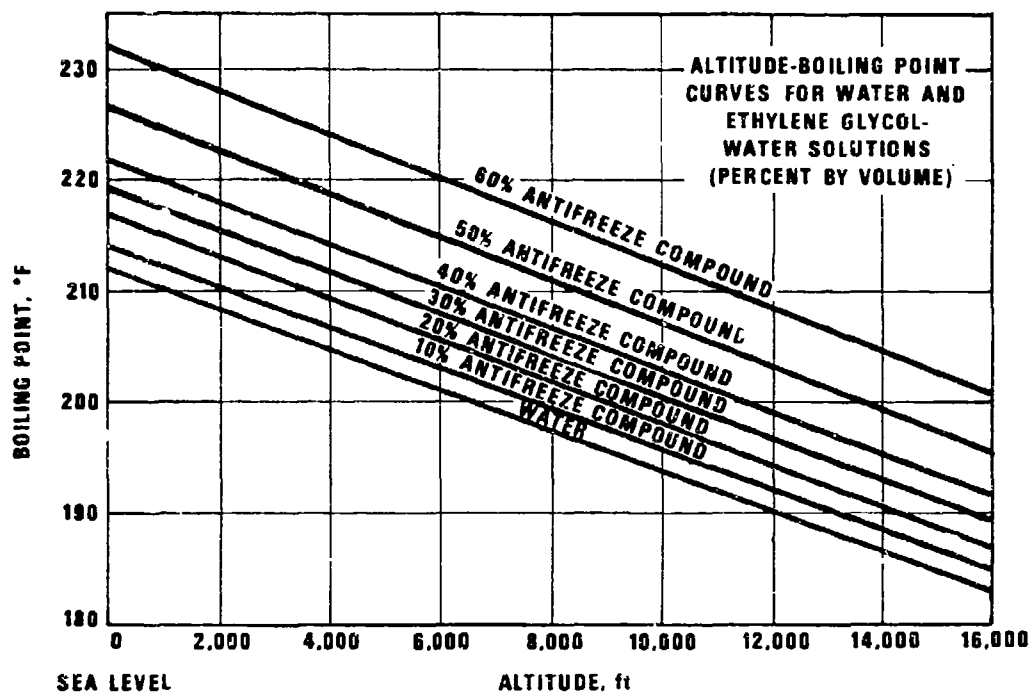

Figure 5-2. Effect of Altitude on Boiling Points of Water and Antifreeze Compound Solutions (Ref. 4)

becomes only as effective as a 10-psi cap at the 10,000 ft level because of decreased barometric pressure. Fig. 5-2 illustrates the effect of altitude on the boiling point of water and antifreeze compound solution. This may not be consequential because the ambient air temperature also drops considerably with increased altitude at a rate of about 3°F per 1000 ft of elevation. A pressurized cooling system is preferred for military vehicles.

5-3 METHODS OF COOLING CONTROL

The most frequently applied methods of cooling control are:

1. Throttling of the cooling airflow

2. Heating of the cooling air
3. Heating of the lubricating oil
4. Modulation of the cooling fan speed
5. Control of the coolant flow rate in liquid-cooled systems
6. Control of the lubricating oil flow rate to the oil cooler.

These methods of cooling control are applied not only to control maximum temperature limits but also to maintain minimum temperature limits when operating in low temperatures. Ref. 1 contains helpful supplemental information regarding vehicle winterization practices.

AMCP 706-361

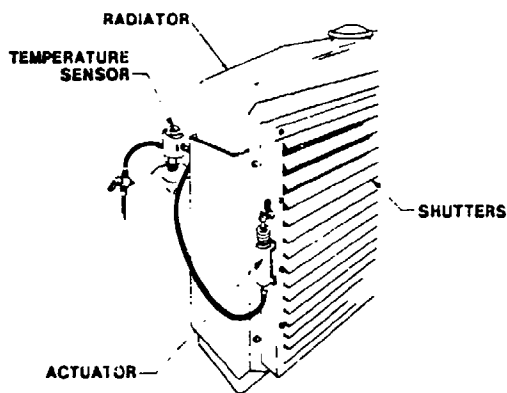

Figure 5-3. Thermal Actuated Radiator Shutters
 (Courtesy of Kysor of Cadillac)

Armored Personnel Carriers and are used widely for commercial vehicles.

Fig. 5-3 illustrates a typical installation of radiator shutters.

5-3.1.1.2 Operation

The shutters may be actuated by air, hydraulic, or vacuum controls. Fig. 5-3 illustrates a typical air operated shutter. A typical hydraulic system is illustrated in Fig. 5-4. The operating medium for the hydraulic system is generally the engine lubricating oil. A detailed discussion of thermostatic operating elements is presented in par. 5-4.3.5.

The thermostatic elements for the shutter systems are available in various temperature ranges, depending on the chosen location of the element in the cooling system. The design requirements for temperature range of the shutter systems generally are that the shutters are fully open when the radiator top tank temperature is above 185°F and fully closed when the top tank temperature is below 177°F (see Fig. 5-5). These requirements, however, vary with makes and types of engines. Accordingly, engine manufacturers' recommendations should be followed in each case. A manual control (Fig. 5-6) can be provided as an override to close the shutters when the engine is not running. As a safety factor, these override controls can be provided with an automatic release actuated when the engine is operated.

5-3.1 THROTTLING OF THE COOLING AIR

Throttling of the cooling air normally is done to reduce the overcooling effect of the airflow during low temperature operations. In extreme cold environments, the effects of winds (or air movement produced by fans) produce a tremendous over-cooling effect on the vehicle cooling system. For satisfactory operation, these effects must be minimized. Additionally, it has been established that rapid engine warm-up reduces cylinder wear in reciprocating engines.

5-3.1.1 Radiator Shutters

Shutters provide an effective means of reducing the wind chill effect of cooling air movement at extremely low ambient temperatures. The shutters may be controlled manually or thermostatically. Fail-safe thermostatic controls are preferred since they completely eliminate the element of human error.

5-3.1.1.1 Application

Radiator shutters have been used on military vehicles such as the M3 and M5

5-3.1.2 Winterization Shutters

5-3.1.2.1 Purpose

Winterization shutters have been applied to air-cooled engines to restrict the cooling fan air inlet or exit. Fig. 5-6 shows a manually operated inlet winterization shutter for the M274 vehicle, and Fig. 5-7 illustrates a thermostatically controlled outlet shutter assembly installed on the cooling fan of the model AOS-895 air-cooled engine. The

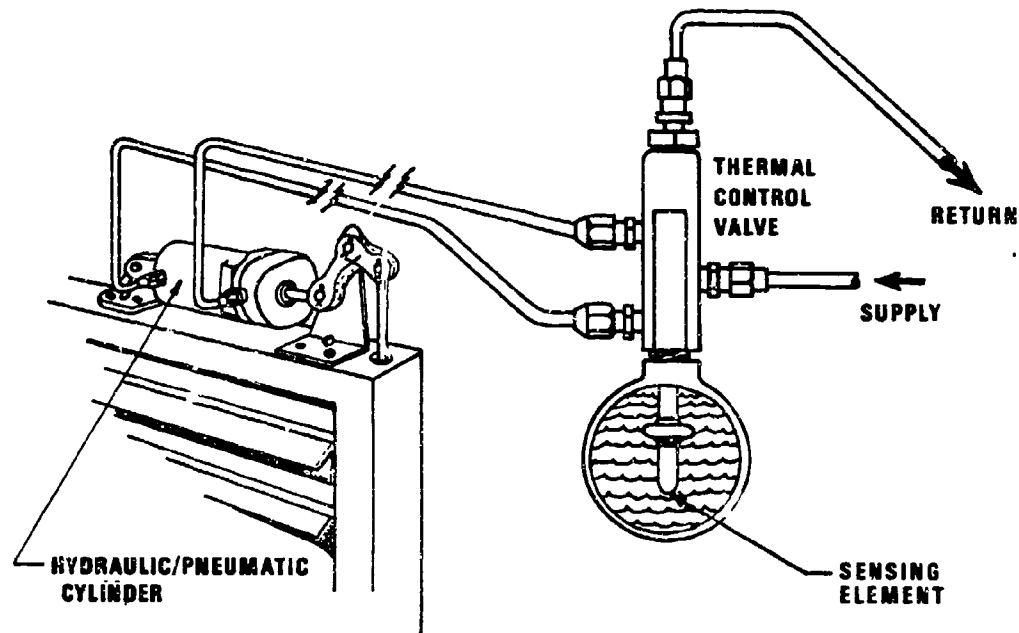

*Figure 5-4. Hydraulic or Thermally Controlled Shutter Systems
 (Courtesy of Kysor of Cadillac)*

movable shutter vanes are controlled by a power thermostat that opens or closes the vanes to control the cooling fan airflow.

By the use of a thermostat in a liquid-cooled engine, nearly constant engine temperatures are maintained over a wide ambient temperature range and engine warm-up rate is accelerated in cold weather. By controlling the cooling airflow in an air-cooled engine, the same result may be approximated.

5-3.1.2.2 Operation

An experimental thermostatically-controlled guide vane shutter design for the air-cooled AOS-895-3 engine consists of a circular guide vane assembly in which alternate vanes are pivoted. All movable vanes are fastened through a linkage permitting movement to a position that closes the area

between the fixed blades (see Fig. 5-7).

The guide vanes are actuated by a double-acting hydraulic cylinder that uses engine oil pressure as its actuating source. The double action of the hydraulic cylinder thereby provides positive opening and closing of the shutters.

The hydraulic cylinder is controlled by a temperature sensitive servo valve assembly. This actuating assembly consists of three temperature sensing elements that are located in the valve assembly. The temperature sensing elements and bellows are charged in a negative atmosphere with a compound with characteristics such that sufficient cylinder heat on the sensing elements causes expansion of the bellows that actuates the servo piston in the regulator valve assembly. The servo piston regulates the flow of oil through two ports that connect to the power piston by

AMCP 706-361

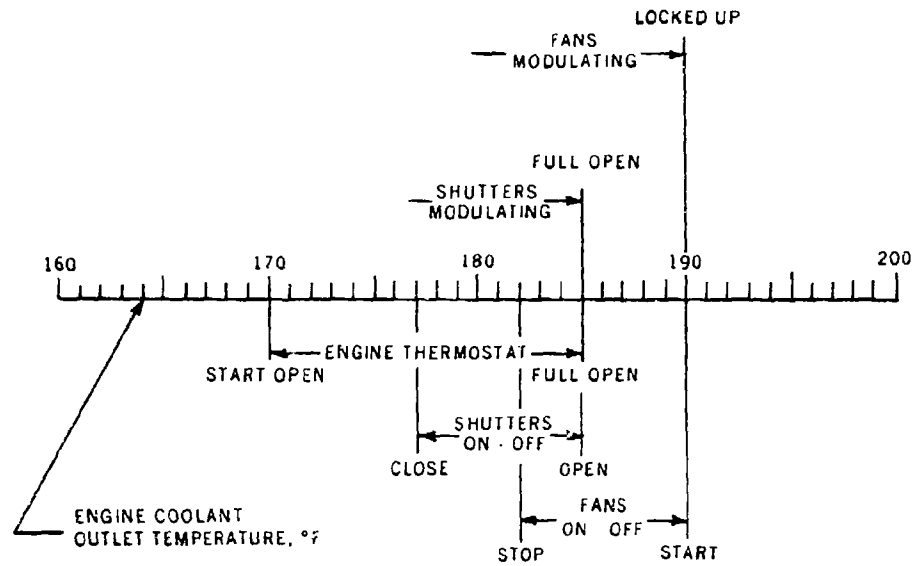

Figure 5-5. Temperature Settings for Radiator Shutters (Ref. 1)
 (Release Granted by Society of Automotive Engineers, Inc., Paper No. SP-346.)

steel tubing. The regulator valve has a third port that permits the oil to drain from the unpressurized side to the engine oil sump. The temperature sensing system is charged in a negative atmosphere so that a leak in the bellows or capillary line failure would permit atmospheric pressure to act exactly as a hot cylinder head and thereby move the vanes to an open position.

The guide vane shutter is set to open when the engine cylinder head spark plug gasket temperature reaches 300°F with the engine operating at a speed of 800 rpm. The 300°F-shutter opening was selected to ensure that the engine would be at a safe operating temperature for shut down. Fig. 5-8 illustrates the improvement in warm-up rate using the guide vane shutter assembly.

5-3.2 HEATING OF THE COOLING AIR

Supplemental heat normally is required for engine and transmission warm-up prior to starting the engine and operation of the

vehicle in low ambient temperature. An auxiliary power unit (APU) or combustion heater (Fig. 1-51) can be used to supply heated air to the engine and transmission compartment. Fig. 5-9 illustrates the installation of the APU/heater in the XM803 Experimental Tank.

5-3.3 HEATING OF THE LUBRICATING OIL AND COOLANT

Engine and transmission cranking loads at low ambient temperatures are excessive, and preheat of the lubricants usually is necessary before the engine can be started readily. Electric oil pan and/or engine block heaters, electric oil pan and/or engine block heaters, heated air, and/or coolant heaters (Fig. 1-50) are used individually or in combination to provide the necessary engine and transmission preheat. The MBT70 Prototype Tank power package cranking load at low ambient temperatures is shown in Fig. 5-10 to illustrate the increase in battery power required for cranking at low ambient temperatures.

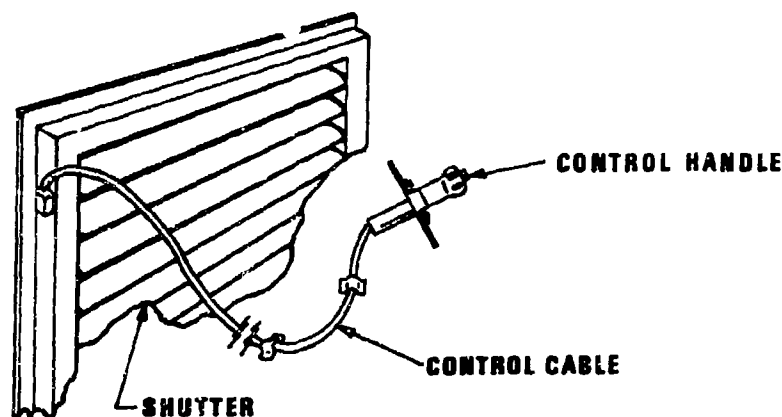

Figure 5-6. Manual Shutter Control (Ref. 17)
 (Courtesy of Kysor of Cadillac)

5-3.4 MODULATION OF COOLING FAN SPEED

Thermostatic modulation of the cooling fan speed permits the fan speed to vary in proportion to the actual cooling load. When cooling is not required because of low ambient temperature, light loads, or ram air when the vehicle is moving, the fan will operate at a speed less than the maximum rpm allowing additional horsepower for vehicle propulsion. Additional information on modulated fan drives is found in par. 4-15.3 and the bibliography references at the end of this chapter.

5-3.5 LIQUID-COOLANT FLOW RATE CONTROL

Coolant flow rate control is provided by a thermostat that performs two functions:

1. Maintains a constant coolant temperature range regardless of engine speed, load, coolant flow rate, ambient temperature, or system pressure (except when the heat rejection rate exceeds the radiator or heat exchanger heat transfer capacity)

2. Restricts the coolant flow to the radiator or heat exchanger during the initial warm-up period to achieve optimum engine operating temperature in the shortest possible time.

5-3.6 CONTROL OF OIL FLOW RATE TO OIL-COOLERS

Engine and/or transmission oil coolers may incorporate thermostatic bypass valves to maintain a predetermined oil temperature. Fig. 5-11 illustrates the engine oil cooler thermostatic bypass arrangements for the model AVDS-1790 air-cooled engine that powers the M60 Tank. Details of the thermostatic bypass valve are shown in Fig. 5-12.

In operation, if the temperature of the oil is below the predetermined value (148°F), the oil-cooler core is bypassed. As the oil warms up, the thermostatic valve gradually closes the oil bypass and reduces flow rates until the oil reaches the predetermined temperature. At this point, the oil bypass function is stopped and all oil flow is through the cooler core.

AMCP 706-361

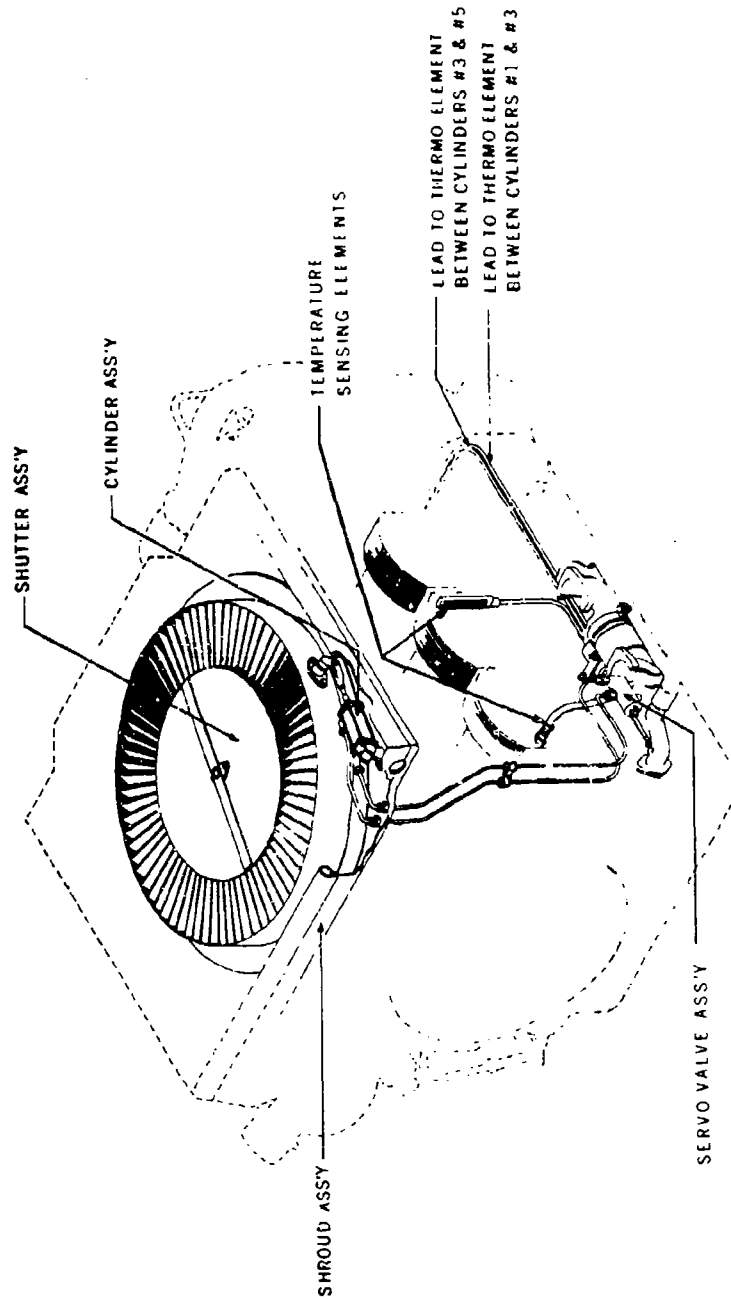

Figure 5-7. AOS-895-3 Air-cooled Engine Winterization Shutter Assembly (Ref. 2)

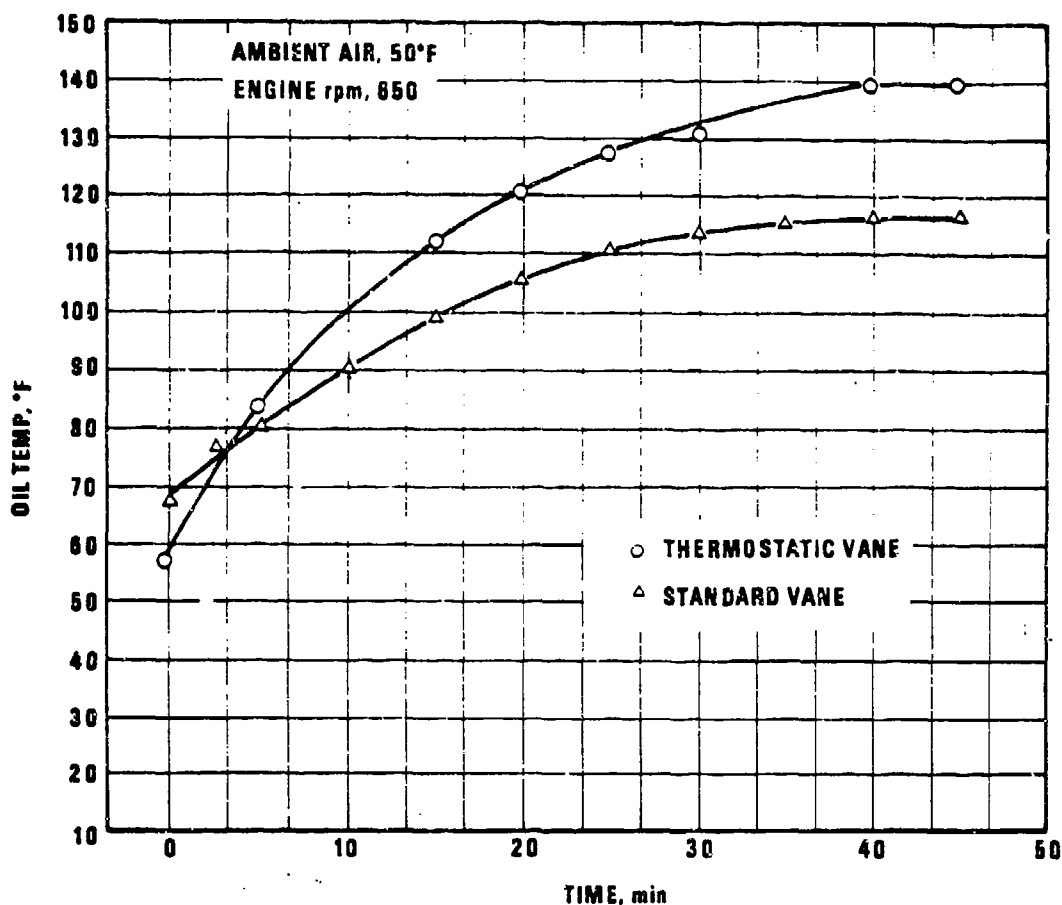

Figure 5-8. Air-cooled Engine Warm-up Rate With Thermostatically Controlled Fan Shutters (Ref. 2)

5-4 CONTROLS AND INSTRUMENTS

Special requirements of military engines and severe conditions of transport and combat operation make it necessary that the engine cooling system be maintained as closely as possible to maximum efficiency at all times. Many military vehicles are powered with comparatively large engines that generate proportionately large amounts of heat that must be dissipated from the system. Also, cooling often is made more difficult by the presence of airflow obstructions necessary for ballistic protection and the limited space available in many installations.

Some cooling system troubles can be detected by an alert driver in their early stage before they seriously affect vehicle operation. The two most important indications are coolant operating temperature and coolant level. While preventive maintenance services—such as checks for leakage or defective mechanical condition of parts—also are necessary, unsatisfactory cooling system operating conditions nearly always are indicated by the engine temperature gage, by the level of the coolant in the radiator, or by both. Cooling system control components and their operation are described in the paragraphs that follow.

AMCP 706-361

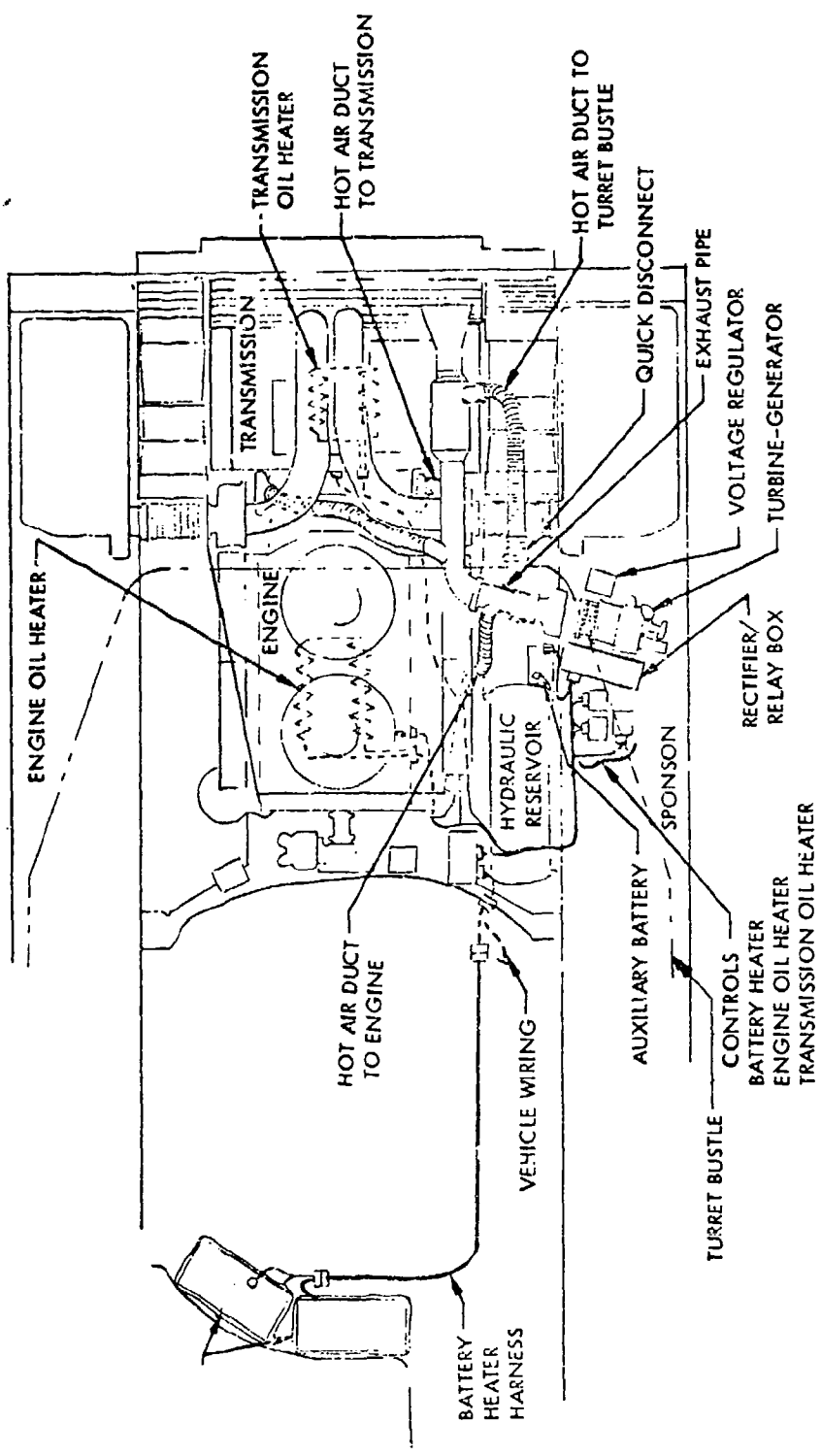
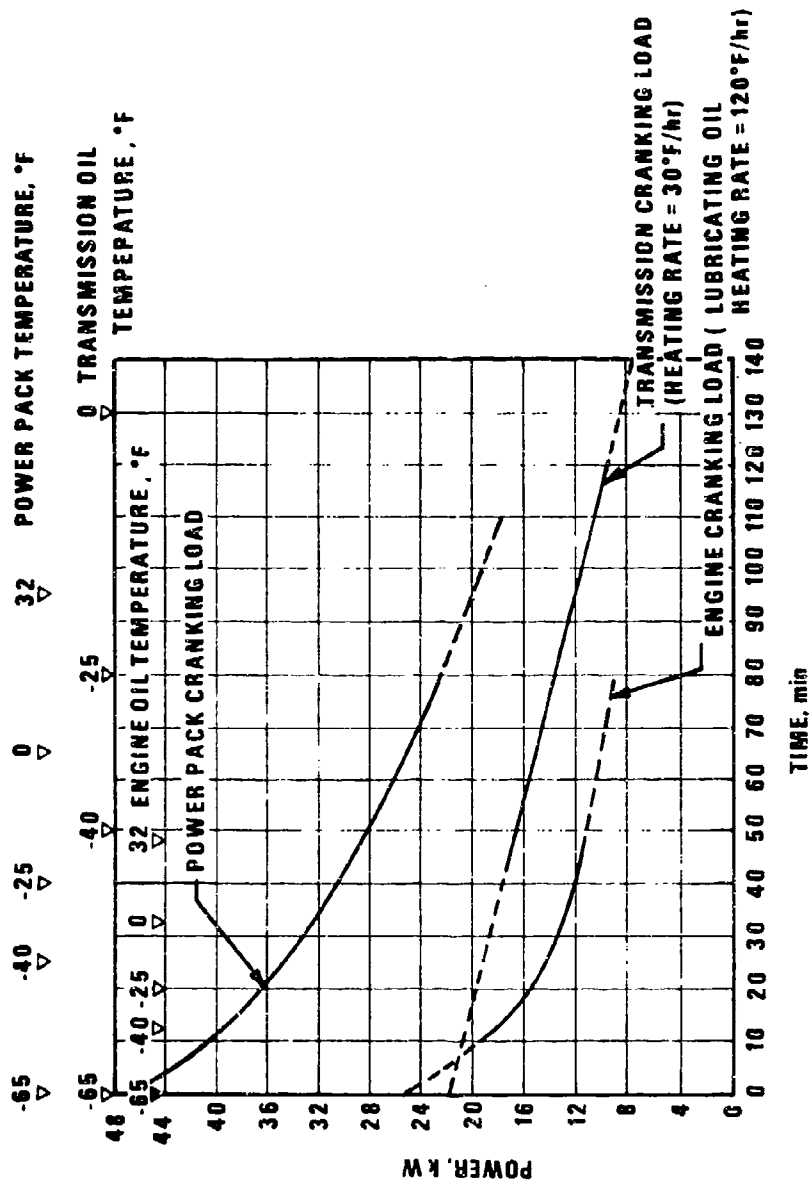

Figure 5-9. APU/Heater Installation in the XM803 Experimental Tank (Ref. 13)



NOTE: SEE FIG. 5-9 FOR ENGINE/TRANSMISSION OIL HEATER INSTALLATION

Figure 5-10. MBT70 Prototype Tank Engine/Transmission Power Package Cranking Load at Low Ambient Temperature With the Daimler-Benz Engine

AMCP 706-361

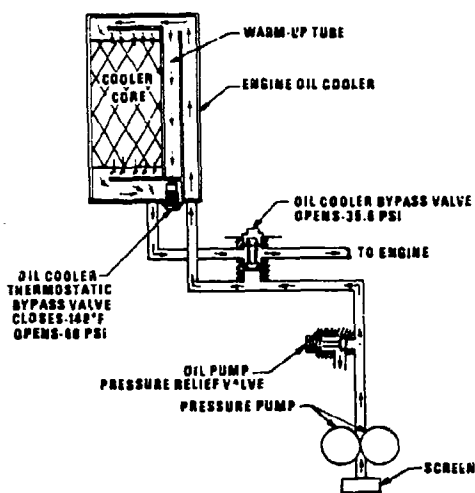

Figure 5-11. Oil Cooler With Thermostatic Bypass Valve (AVDS-1790 Air-cooled Engine)

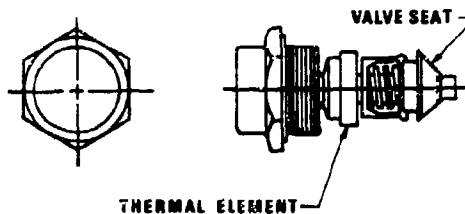

Figure 5-12. AVDS-1790 Engine Oil Cooler Thermostatic Bypass Valve

normally for a nonpressurized cooling system either as a seal or a filler cap for the system. Some pressure or closed systems use both plain and pressure caps as illustrated in Fig. 5-14. The tube in Fig. 5-14 extends into the tank to prevent overfilling and maintain an airspace for deaeration. This system is used on the M107 and M110 vehicles.

When a surge tank is used, the location of the plain or pressure caps can be either on the radiator or the surge tank, depending on the operating conditions as described in par. 5-4.2.

5-4.1 RADIATOR CAPS

5-4.1.1 General

When a liquid-coolant system is equipped with a pressure cap, it is referred to generally as a pressure or closed cooling system. Military vehicle cooling systems generally are designed to operate at a maximum coolant temperature of 230°F which corresponds to a 7-psi system. However, to prevent after boiling, a 15-psi pressure cap normally is used (see Table 3-4). MIL-C-45167 covers requirements for radiator caps for use with industrial and automotive internal combustion engine radiators (Ref. 3).

5-4.1.2 Types of Radiator Caps

Radiator caps can be described generally as plain or pressure types, with the pressure caps being further classified as vented or constant pressure type.

5-4.1.2.1 Plain (Solid) Caps

The plain radiator cap (Fig. 5-13) is used

5-4.1.2.2 Pressure Caps

5-4.1.2.2.1 Purpose and Application

The radiator pressure cap is essential to the pressurized cooling system. Its major functions are:

1. To provide a seal for the system that permits a vapor pressure rise above ambient pressure without coolant boiling.
2. To provide pressure relief above the cap pressure rating to protect cooling system components such as the radiator, hoses, and personnel heater core from damage caused by excessive pressure in the system.
3. To provide a vacuum relief to prevent hose collapse when the system cools and the pressure drops below atmospheric.

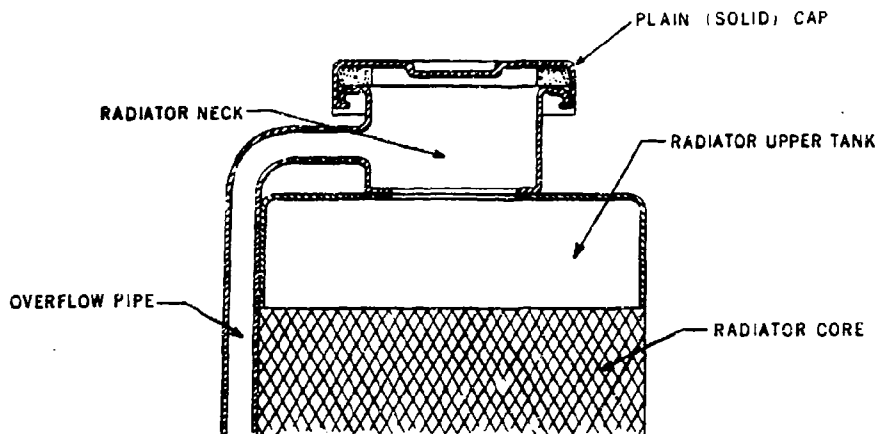

Figure 5-13. Plain (Solid) Radiator Cap (Ref. 4)

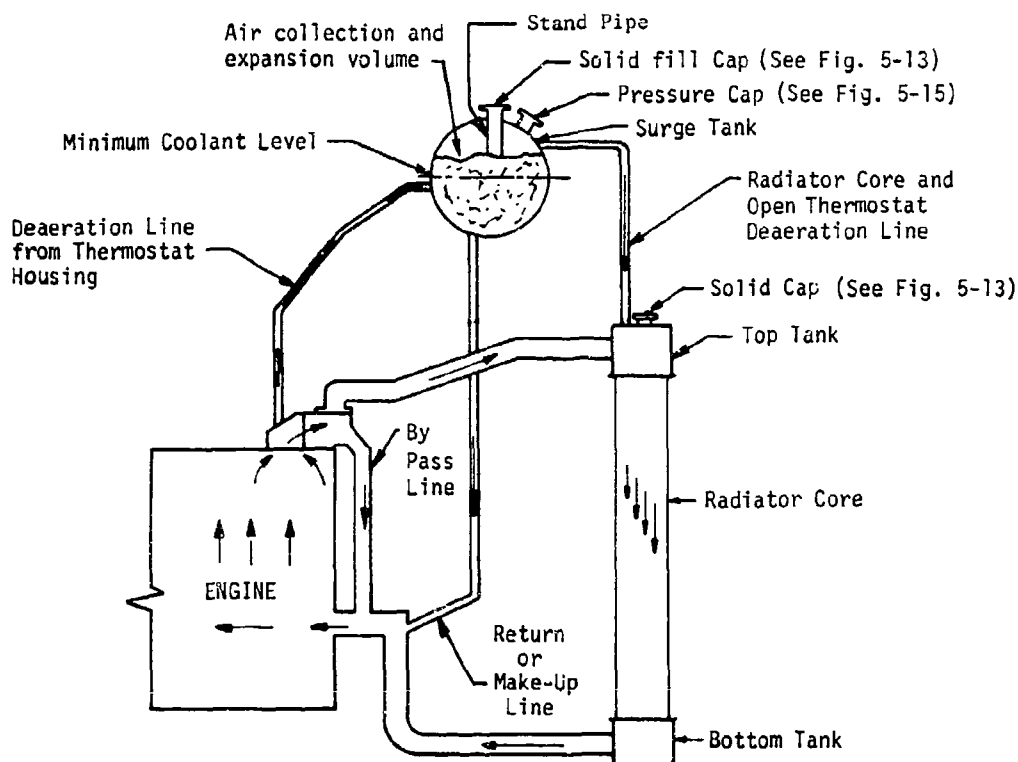

Figure 5-14. Pressure System Using Both Plain (Solid) and Pressure Caps
(Courtesy of Cummins Engine Co., Inc.)

AMCP 706-361

5-4.1.2.2.2 Types of Pressure Caps

Pressure caps generally are classified as vented atmospheric type and constant pressure type as shown in Fig. 5-15. The caps are similar except that the vacuum relief valve is spring loaded in a normally closed position.

Either type of cap can be provided with a manually operated safety pressure release as shown in Fig. 5-15(C). The safety release forces the vacuum relief valve off the seat and permits pressure to escape safely through the overflow tube. This release cannot be operated without loss of coolant if the system is under pressure.

5-4.1.2.2.3 Operation

The constant pressure cap, Fig. 5-15(B), contains two spring-loaded normally closed valves. The larger valve is called the pressure valve, and the smaller one is called the vacuum valve. A shoulder in the radiator filler neck provides a seat for the bottom of the cap assembly, and a gasket on this seat prevents leakage between the cap and the filler neck. The pressure cap prevents overflow loss of coolant during normal operation (Ref. Fig. 5-15(B)) by closing off the overflow tube opening. It also allows a certain amount of pressure to be developed within the system which raises the boiling point of the coolant and permits the engine to operate at higher temperatures without coolant overflow from boiling.

The pressure valve acts as a safety valve to relieve extra pressure within the system and maintain cooling system pressure at the pressure cap rating. When the valve is forced open, it allows vapor and coolant to escape through the overflow pipe until the pressure drops below the pressure cap rating, (see Fig. 5-16(A)).

The vacuum valve opens only when pressure within the cooling system drops below ambient air pressure as the engine cools

down. Higher ambient pressure then forces the valve open and allows air to enter the system by way of the overflow pipe. When pressure inside and outside again becomes approximately equal, the vacuum valve closes. This automatic action of the vacuum valve prevents collapse of hoses and other unsupported thin-walled parts of the cooling system (see Fig. 5-16(B)).

The operation of the vented atmospheric cap is similar except no pressure build-up occurs until boiling starts. The claimed advantage for this system is that it is not under pressure during normal engine operation. This means that the endurance life of the radiator, hoses, and other cooling system components is increased because of the reduced number of pressurization cycles.

The philosophy for the constant pressure system is that less fresh air is introduced into the radiator, resulting in reduced corrosion of the engine and cooling system components. From a functional view, both caps are interchangeable.

5-4.2 SURGE TANKS

5-4.2.1 Purpose

Radiator overflow tanks, usually called surge tanks or expansion tanks, are standard equipment for many vehicles. They also may be installed on vehicles as kits or special equipment for operation in hot, dry climates. The general purposes of the surge tank are:

1. To serve as a receptacle for coolant overflowing from the radiator and provide for its return to the system. The surge tank conserves coolant that would be lost because of after boil following a hot shutdown, and reduces the need for frequent filling of the radiator.
2. To serve as a deaeration tank for air or combustion gases that become entrained in the coolant.

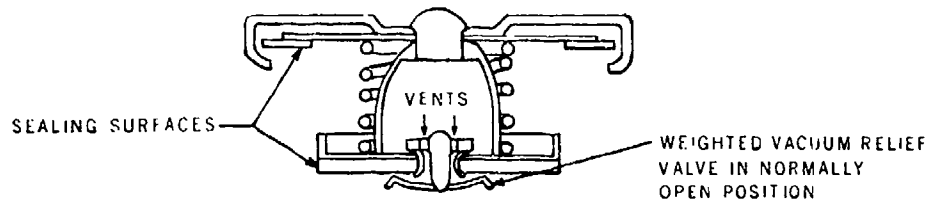

(A) VENTED ATMOSPHERIC PRESSURE RADIATOR CAP

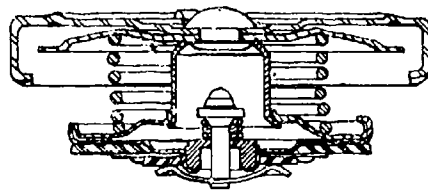

(B) CONSTANT PRESSURE RADIATOR CAP

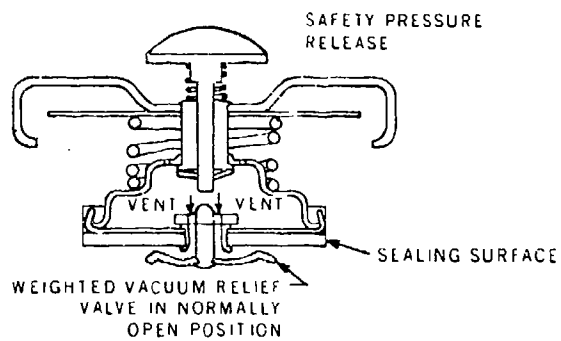

(C) VENTED ATMOSPHERIC PRESSURE RELEASE TYPE RADIATOR CAP

Figure 5-15. Radiator Pressure Caps (Ref. 3)

AMCP 706-361

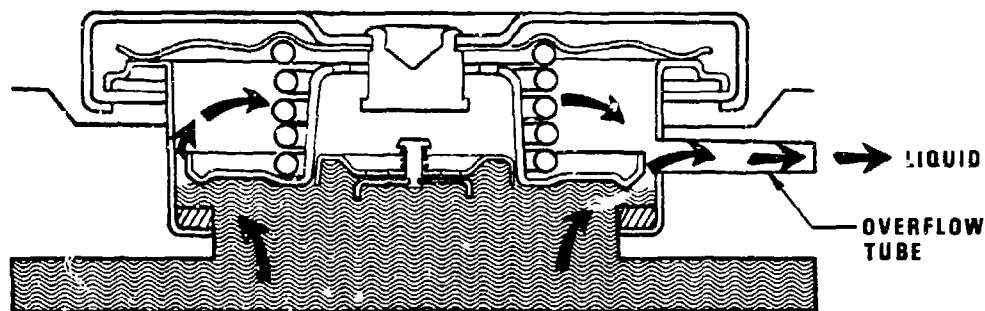

(A) PRESSURE VALVE OPEN

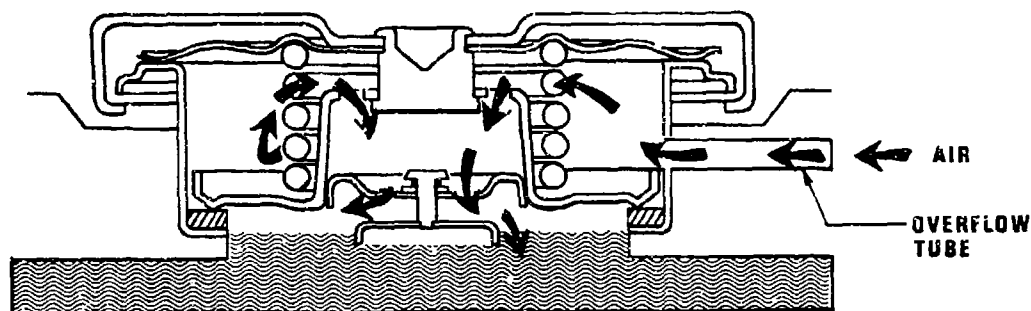

(B) VACUUM VALVE OPEN

Figure 5-16. Radiator Cap Operation (Ret. 10)

The problems encountered with surge tank installations are:

1. More possibilities of coolant leaks
2. Servicing of other parts of the vehicle in the area of the surge tank is slightly more difficult
3. Additional cost required to install a surge tank kit vs a larger radiator or pump.

5-4.2.2 Application and Operation

Antifreeze compound solutions expand slightly more than water when heated. When

the temperature of a 50 percent ethylene glycol-water solution is raised from 40° to 180°F, the solution expands about 1/8 pint per gallon more than water under the same conditions (see Fig. 5-17). However, during very cold weather, the differential between ambient and maximum operating temperature of the coolant is much greater and thermal expansion of the solution is therefore a more serious matter. For example, the expansion of a 50 percent ethylene glycol antifreeze solution when heated from -20° to 180°F is nearly 0.5 pint per gallon. If a 5-gal cooling system containing a 50 percent solution were filled completely full with the coolant temperature at -20°F, approximately 2.5

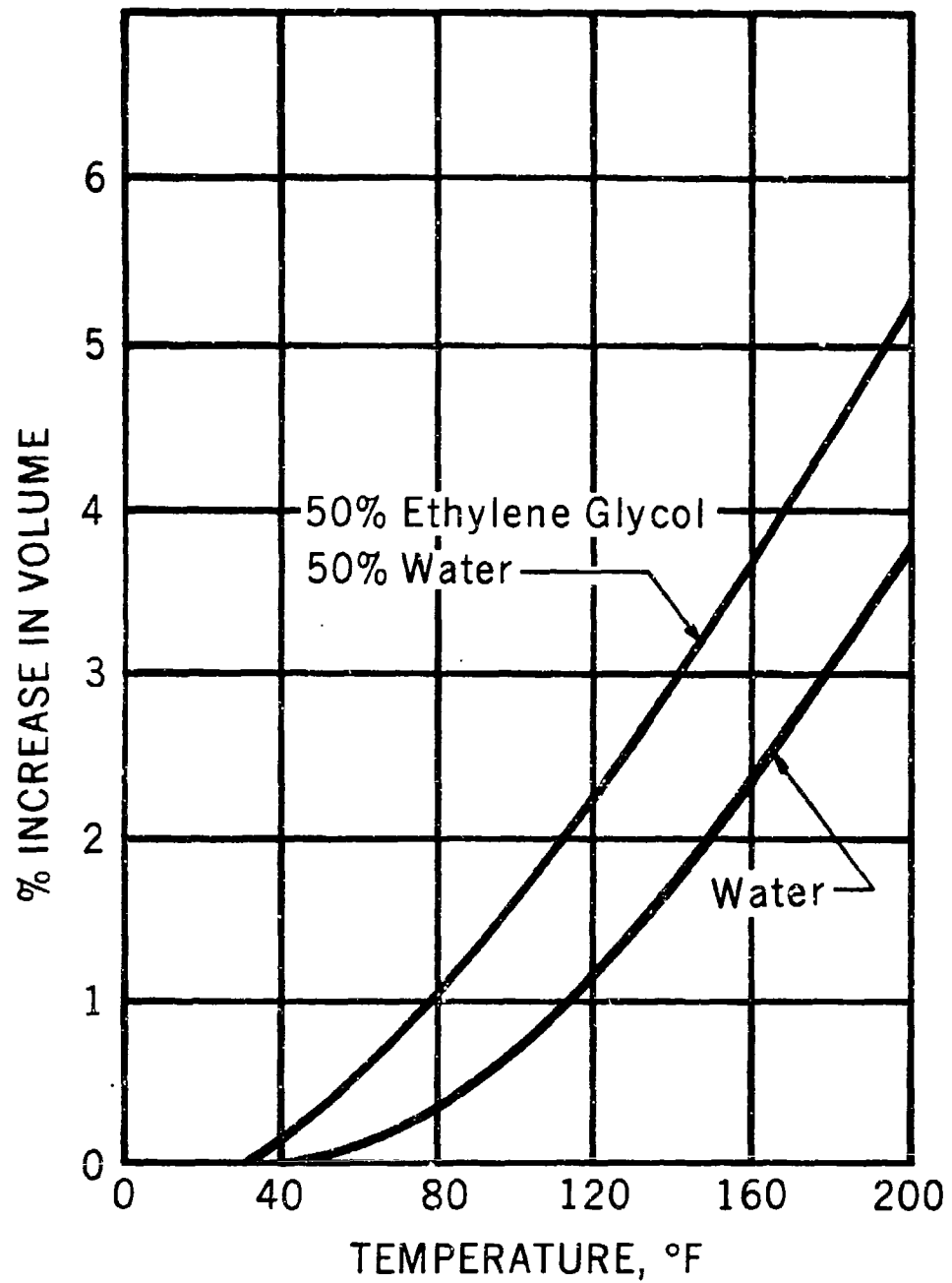

Figure 5-17. Percent Increase in Volume for Water and Antifreeze Solution
(Courtesy of Detroit Diesel Division, General Motors Corporation)

AMCP 706-381

pints of solution would overflow from the radiator by the time the coolant temperature had reached 180°F.

Following long, hot operation, boiling may occur after the engine is shut off, even though the coolant was not boiling during operation. This after boil is caused by the rapid rise of coolant temperature in the coolant jacket; sometimes as much as 20 deg F or more. The temperature rise is due to the coolant absorbing the heat produced in the engine during operation since no heat is dissipated with coolant circulation and airflow stopped. After boil occurs less frequently and results in less overflow loss when the boiling point of the coolant is comparatively high. After boil loss of coolant is prevented by use of radiator pressure caps and surge tanks.

Either excessive thermal expansion of the coolant when it is heated or excessive coolant vapor pressure may force coolant into the surge tank. Boiling may occur during operation, but it happens more often after the engine is stopped. When the engine cools down, pressure in the system drops below the ambient air pressure and any coolant held in the surge tank is forced back into the radiator. The surge tank also prevents loss of coolant from boiling during periods of severe vehicle operation. However, if the overflow from the radiator is so great that the tank is filled, coolant will be lost through the surge tank overflow.

The size of surge tanks may vary in capacity from 2 quarts to a gallon or more. The tank capacity normally varies from 8 to 14 percent of the cooling system coolant capacity.

5-4.2.3 Surge Tank Installation

The surge tank usually is mounted fairly high with reference to the cooling system as shown in Fig. 5-14. The tank is connected to the cooling system through metal tubing that terminates with a short piece of flexible hose

to minimize breakage caused by vibration. When space is limited, the surge tank may be mounted at radiator level or slightly below the radiator as shown in Fig. 5-18.

For any surge tank location, the pressure cap must be installed at the high point of the cooling system so that excessive system pressure will not cause coolant loss. As shown in Fig. 5-14, a fill tube standpipe extends into the surge tank to maintain an air collection and expansion volume that is necessary for effective deaeration. The plain or solid radiator cap must be used on this fill tube.

5-4.2.3.1 Pressurized Type Surge Tank

Pressurized surge tanks may be arranged as shown in Fig. 5-14. In this arrangement the surge tank is an extension of the radiator top tank or the outlet tank for cross-flow radiators. It provides a larger space that is essential for after boiling coolant expansion and effective deaeration.

The surge tank in this system is always under pressure during operation and must be designed to withstand the pressure.

5-4.2.3.2 Nonpressurized Type Surge Tank (Coolant Recovery)

In the nonpressurized surge tank arrangement shown in Fig. 5-19, the surge tank serves only as an overflow tank. This arrangement generally is used for gasoline engine power plant cooling systems and often is referred to as a coolant recovery system.

The surge tank in this system is not under pressure at any time, the tank design and construction are simple, and a plastic tank sometimes is used.

5-4.3 THERMOSTATS

5-4.3.1 Purpose

As defined in par. 5-3.5, the thermostat

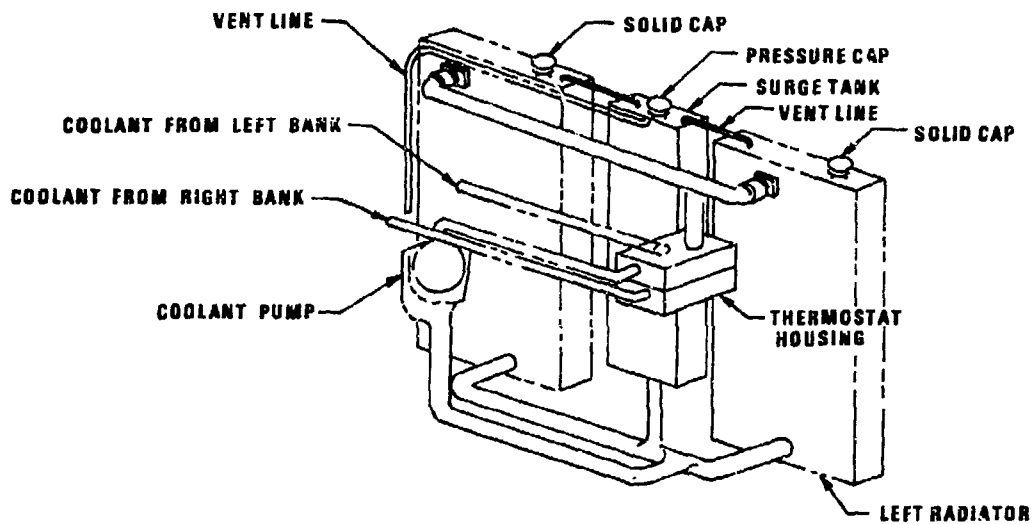

Figure 5-18. M107 Surge Tank Installation Schematic Diagram (USATACOM)

modulates the coolant flow to maintain constant coolant temperature and to minimize engine warm-up time. Prolonged operation with excessively high or low temperatures can result in various engine problems as discussed in par. 1-1.1.

5-4.3.2 Operation

The thermostat is located between the engine coolant jacket and the radiator, usually in the housing at the cylinder coolant outlet as shown schematically in Fig. 5-20. Auto-

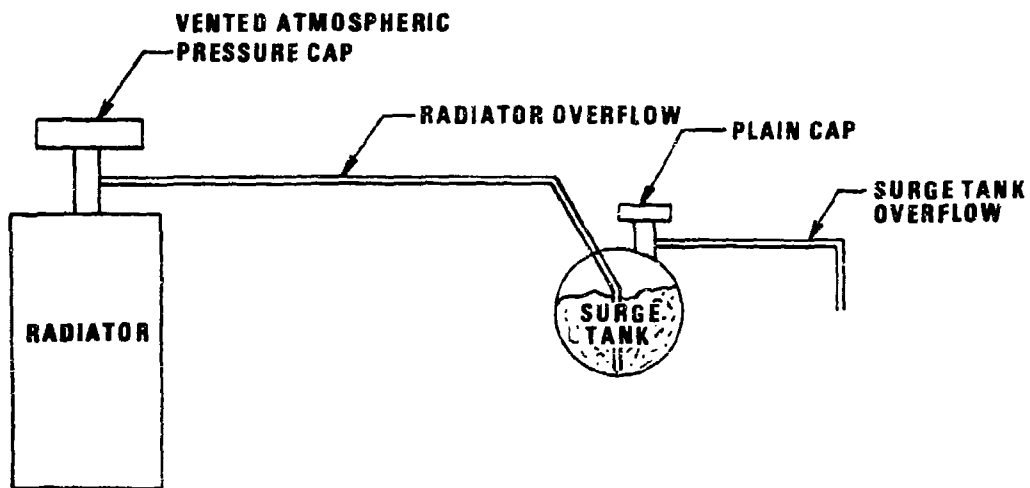

Figure 5-19. Typical Nonpressurized Surge Tank Installation Schematic Diagram (USATACOM)

AMCP 706-361

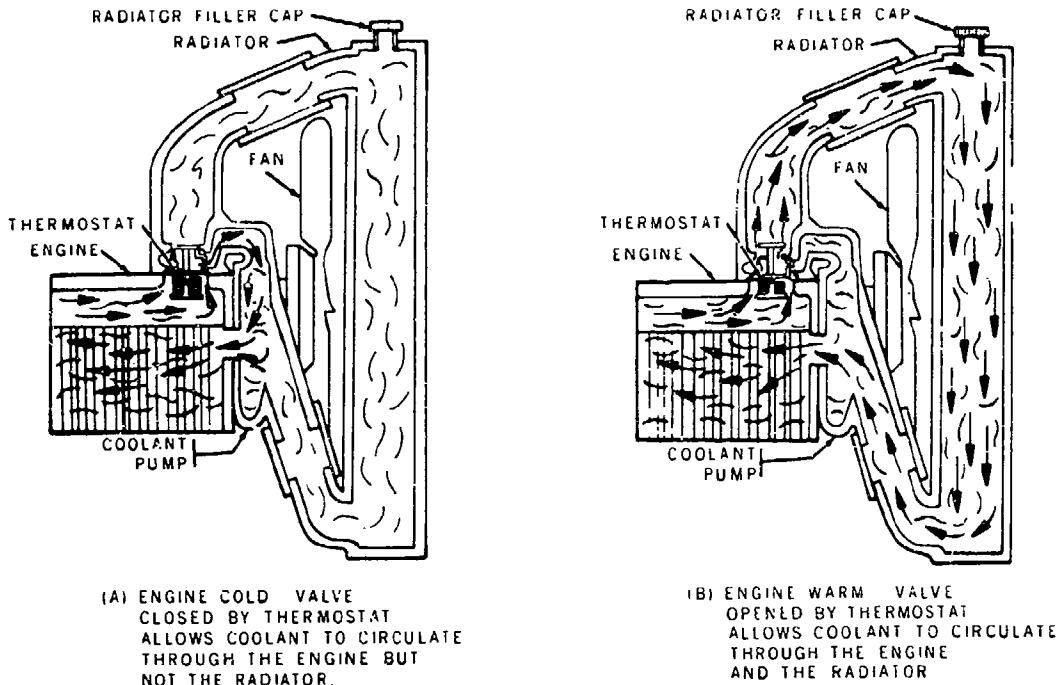

Figure 5-20. Thermostat Installation and Operation Schematic Diagram (Ref. 4)

matic operation of the thermostat valve holds coolant temperature within proper limits by controlling coolant flow through the radiator. When the engine is cold, the thermostat valve stays closed and shuts off practically all circulation to the radiator. As the engine warms up, the valve opens slowly, allowing some coolant to flow. In actual operation, the valve may move frequently to regulate coolant flow into the radiator in accordance with variations in heat output from the engine.

Cooling systems equipped with either internal or external bypass arrangements have coolant circulation within the engine coolant jacket when the thermostat is closed. The external-type bypass consists of short hoses, pipes, or tubes connecting the cylinder head coolant outlet directly with the coolant pump inlet as shown in Fig. 5-21. The internal type bypass allows the coolant to flow from the

engine directly back to the pump through passages built into the engine coolant jacket.

5-4.3.3 General Construction

The major components of a thermostat are:

1. A valve to control coolant flow
2. A power actuator element to open the valve
3. A return spring to close the valve.

(The bellows element performs the same function as the spring because of its ability to exert force to both open and close the valve.)

An important part of the thermostat installation is the design of the housing. The housing design must serve not only as the mounting base for the thermostat, but it

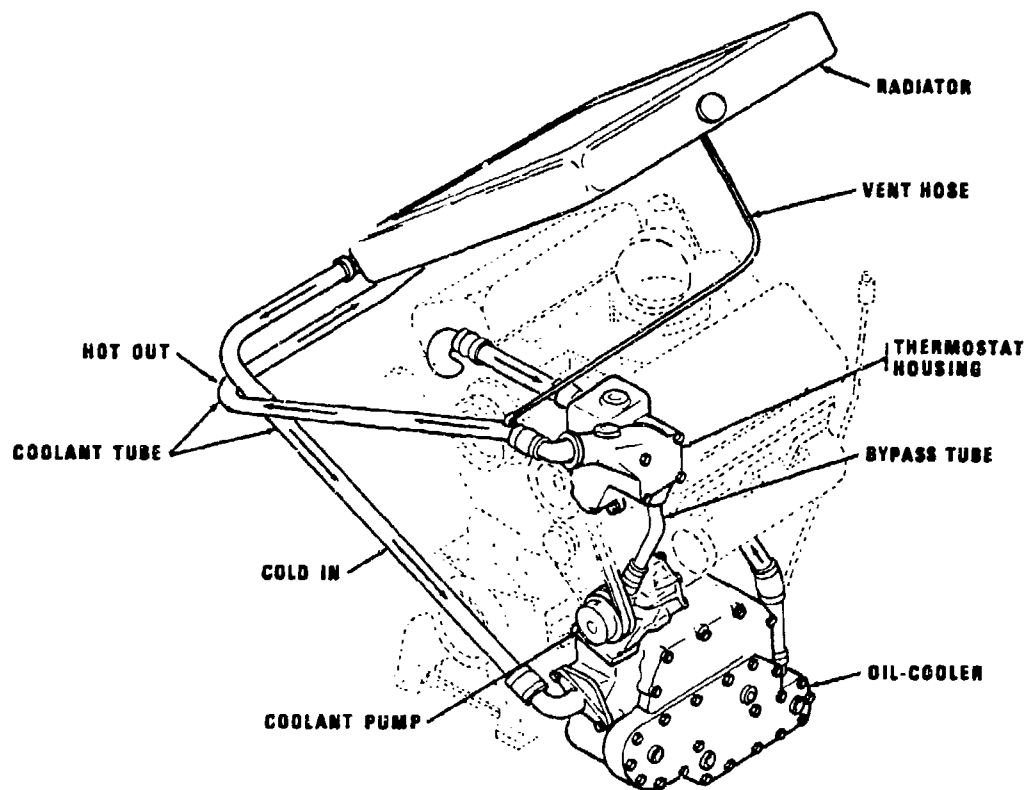

Figure 5-21. External Type Thermostat Bypass Arrangement (M113A1) (Ref. 10)

usually functions as an integral part of the thermostat valve seat. The reader is referred to Military Standard Drawing Number 35770 for installation requirements for flow control thermostats (Ref. 5).

5-4.3.4 Classification

Thermostats generally can be classified by:

1. The type of actuating element:
 - a. Bellows
 - b. Pellet (Fig. 5-22)
2. The type of control mode:
 - a. Bottom bypass type (Fig. 5-23)
 - b. Top bypass type (Fig. 5-24).
3. The type of valve:
 - a. Poppet valve
 - b. Sleeve valve (Fig. 5-22).
4. The direction of the valve opening with respect to the flow of coolant through the valve:

AMCP 708-381

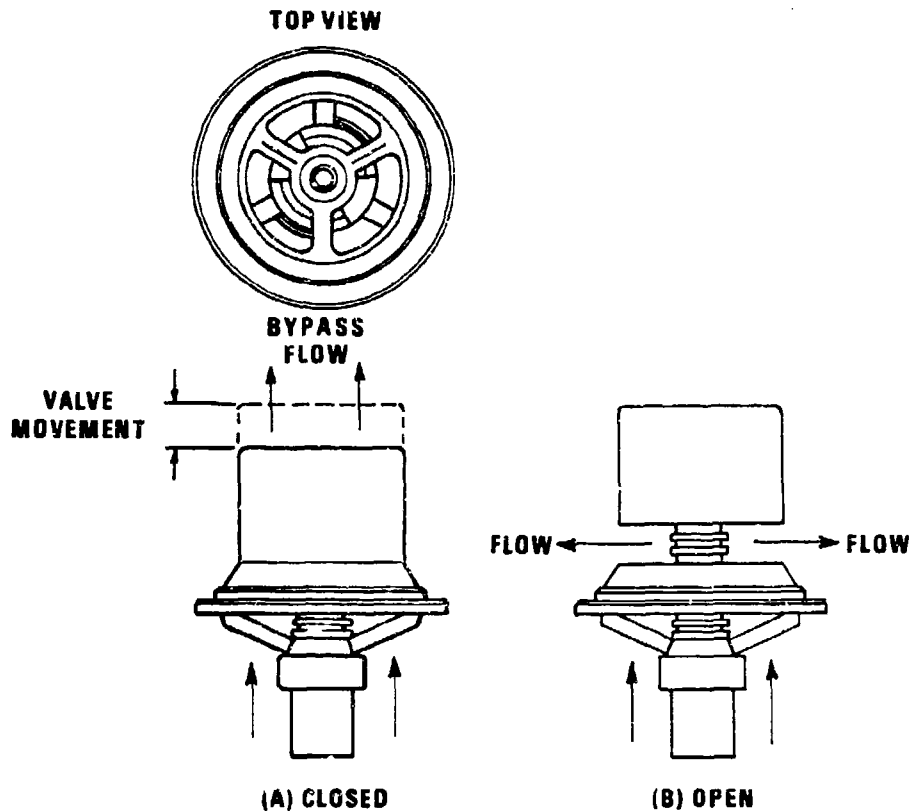

Figure 5-22. Pellet Type Thermostat With Sleeve Valve (Top Bypass)

- a. Upward stroke (Fig. 5-23)
 - b. Downward stroke
 - c. Sleeve type (Fig. 5-24).
5. The type of air bleed:

a. Noncontrolled (bleed hole)—to vent the system during filling and to let vapor escape from the system during engine operation when the thermostat is closed.

b. Controlled (jiggle pin) these pins work in the fashion of a check valve closing the thermostat bleed hole when subjected to a normal coolant flow pressure (see Fig. 5-25).

Thermostats are designed to open at specific temperatures. Generally, engine thermostats begin to open at 170°F and are fully open at 190°F.

5-4.3.5 Types of Actuating Elements

5-4.3.5.1 Bellows Type

The bellows type thermostat consists of a valve and a heat-operated bellows unit that moves the valve. This type of thermostat-operating unit contains a special liquid designed to boil at a specific temperature. When that temperature is reached, the vapor pressure expands the bellows and opens the thermostat valve. When the liquid cools and

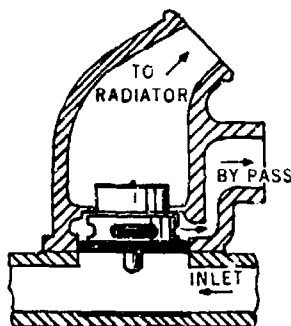

**TYPICAL INSTALLATION
 SHOWN IN BYPASS
 POSITION**

*Figure 5-23. Bottom Bypass Type
 Thermostat Control Mode
 (Courtesy of Scoville Manufacturing Co.)*

condenses, vapor pressure is reduced, allowing the bellows to contract and close the valve.

The opening temperature of a bellows type thermostat is affected by system pressures, tending to collapse the bellows and cause an increase in the temperature required to open the valve. For this reason, the pellet type thermostat has virtually replaced this design.

5-4.3.5.2 Pellet Type

The actuating element of the pellet type thermostat is a pellet cup. Basically, it is a metal cup filled with a heat-expanding wax compound that is blended to provide accurate, repeatable temperature response.

The wax compound is sealed in the cup by an elastomeric boot that extends into the housing to form a core (Fig. 5-26). The boot encloses a tapered end piston that is forcibly expelled when the wax melts and expands as pressure is exerted on the outside of the boot.

As the coolant temperature drops, the wax solidifies and contracts, allowing a spring to

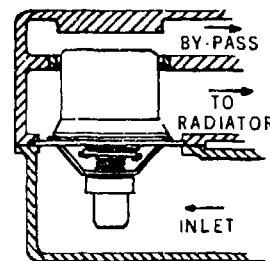

**TYPICAL INSTALLATION
 SHOWN IN BYPASS
 POSITION**

*Figure 5-24. Top Bypass Type
 Thermostat Control Mode (Ref. 14)
 (Courtesy of Scoville Manufacturing Co.)*

return the piston and close the thermostat valve.

The piston movement characteristics are related directly to the piston load, operating range, maximum temperature to which the actuator may be subjected, characteristics of the wax compound in contact with the piston, and other factors. Fig. 5-27 shows typical operating characteristics of a pellet type thermostat. As shown in this figure, when the load is decreased below the design value of the elements, the piston travel may exceed design safety limits as shown; insufficient piston travel may result if the load is increased above the design limits.

The pellet type thermostat generally is referred to by a trade name (see Refs. 11 and 12). With the advent of pressurized cooling systems, pellet type actuators virtually have replaced bellows-operated thermostats. This is due to the greater force potential available in pellet type actuators and their insensitivity to pressure.

The pellet type thermostat also is used to control oil flow in various systems as discussed in par. 5-3.6. This type of thermostatic assembly may incorporate a cooling system pressure relief feature and is

AMCP 706-361

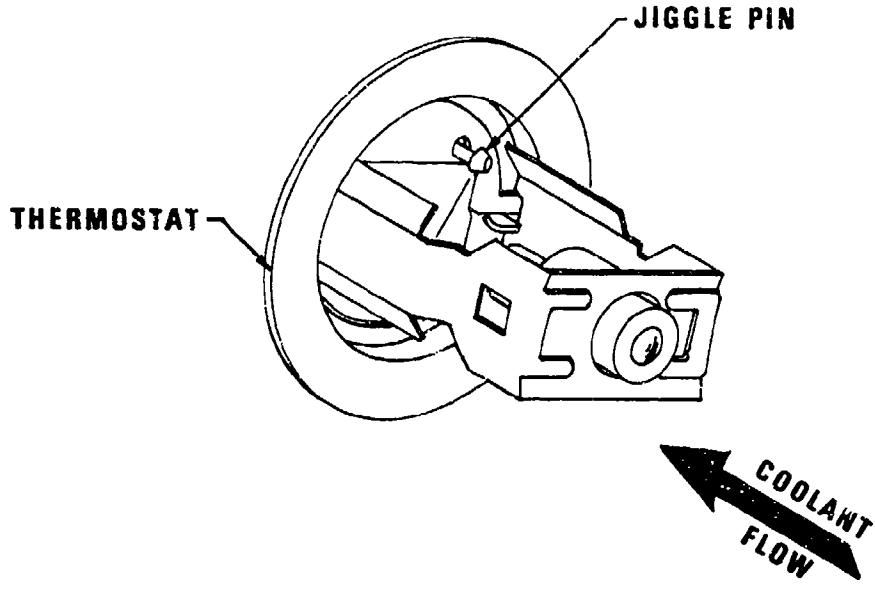

Figure 5-25. Thermostat With Jiggle Pin

used in engine, transmission, hydraulic system coolers, air compressor cooling systems, engine and transmission oil coolers, and many other applications. Fig. 5-28 illustrates a typical installation schematic diagram.

5.4.3.6 Thermostat Control Modes

The thermostat control mode functions shown in Figs. 5-20, 5-23, and 5-24 are described in the paragraphs that follow.

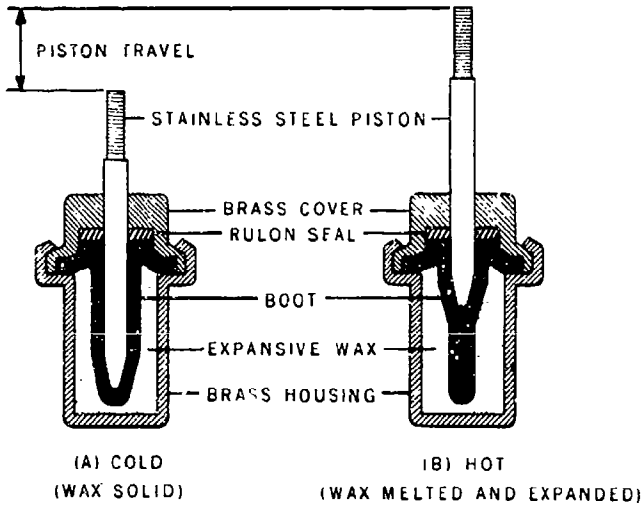

Figure 5-26. Pellet Type Thermal Actuating Element
(Courtesy of Control Products Division, Standard Thompson Corporation)

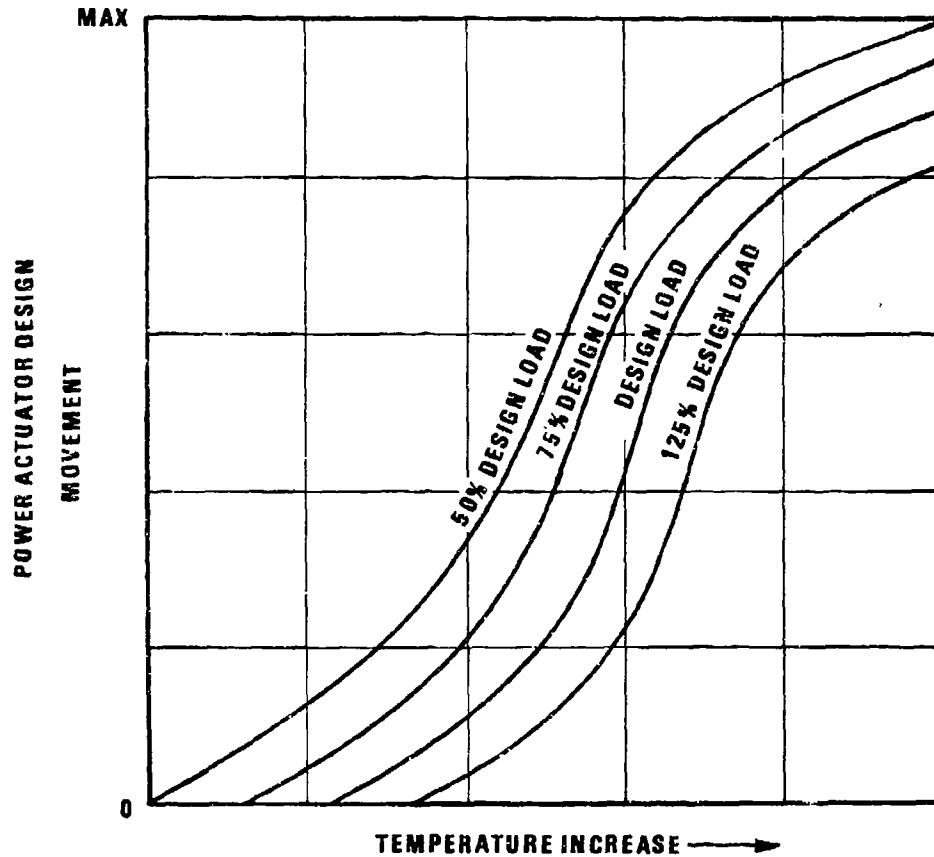

Figure 5-27. Operating Characteristics of Pellet Type Thermostatic Element

5-4-3.6.1 Choke Type

This type thermostat may be either an upward stroke (opens in the direction of coolant flow) or downward stroke (opens opposite to the direction of coolant flow). This thermostat modulates and regulates the coolant flow only to the radiator while an open bypass circuit directs the coolant back to the engine block, bypassing the radiator.

5-4-3.6.2 Top or Bottom Bypass Type

These thermostats function as a three-way valve and continuously modulate the coolant

flow to both the radiator and bypass circuit. This type of control proportions the flow by decreasing the bypass flow and increasing the flow to the radiator, as the engine warms up. There are a number of three-way valve control designs possible, however, the thermostat housing must be matched with the thermostat design to ensure satisfactory operation.

The relationship of flow rate and pressure drop for representative choke type and bypass type thermostats is shown in Fig. 5-29. Specific installation and design assistance can be obtained from the thermostat manufacturers.

AMCP 708-361

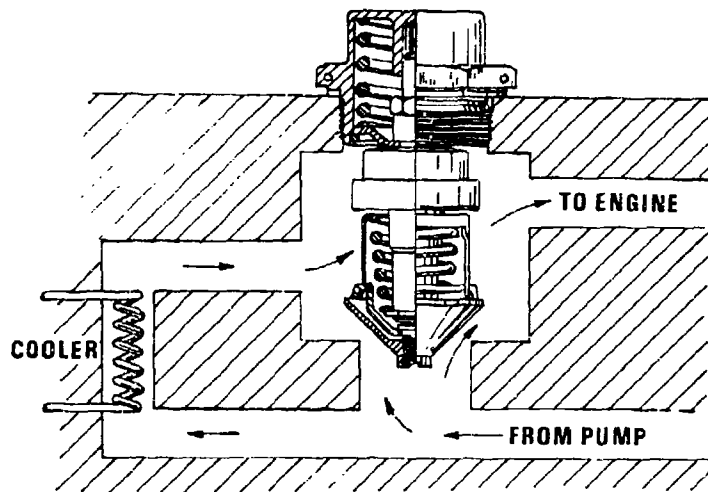

Figure 5-28. Typical Thermostatic Valve Flow Schematic Diagram
 (Courtesy of Scoville Manufacturing Co.)

5-4.3.7 Thermostat Coolant Flow Systems

The way that the thermostat controls the coolant flow is determined by the cooling system circuit. Many circuit variations are possible, however, the most common types used for vehicle applications are:

1. Thermostat located at outlet of engine (see Fig. 5-30(A))
2. Thermostat located at inlet to engine (see Fig. 5-30(C))

The most common deaeration systems in use are the separate surge tank and the radiator with a baffled top tank. The flow circuits for these systems are shown in Fig. 5-30(B) and 5-30(C).

5-5 TEMPERATURE SENDING UNITS

5-5.1 PURPOSE

Coolant, engine, and transmission oil temperatures are monitored and displayed to the vehicle operator by means of temperature sending units that transmit electrical signals

proportional to the operating temperatures--to a temperature gage, light, or signal device. Air-cooled engine cylinder head temperatures also may be monitored in this manner.

5-5.2 APPLICATION

The temperature sending unit (transmitter) is usually an electrical resistance type provided with a standard male pipe thread connection. Sending units operating on the Bourdon tube principle are available but are not used generally for military applications. Fig. 5-31 illustrates a typical Military Standard temperature transmitter.

These units are calibrated to produce a specific current and must be used with a matching indicator.

Military Standard Drawing Number 24537 and MIL-I-10986 should be referred to for complete specifications (Refs. 6 and 7).

5-5.3 OPERATION

The electric temperature indicator assembly consists of a sending unit, gage, and

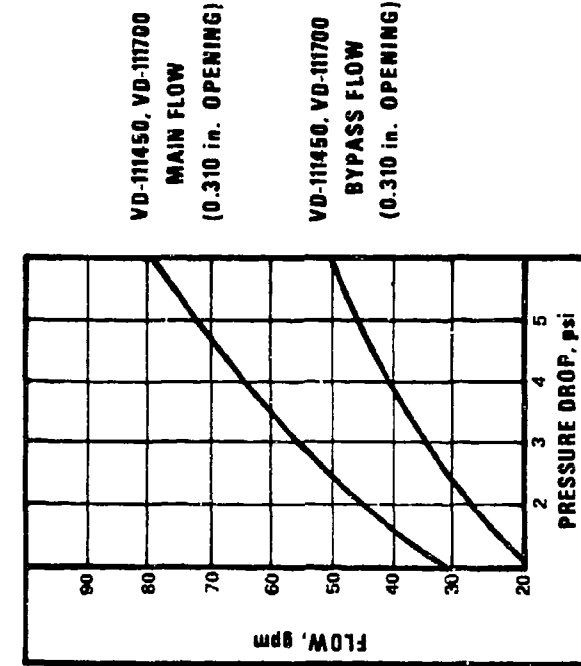

(A) CHOKE TYPE

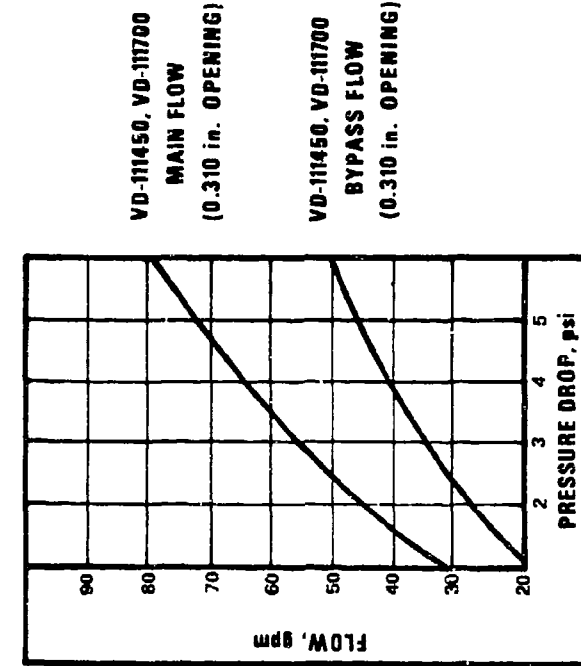

(B) BYPASS TYPE

Figure 5-29. Representative Flow Rate and Pressure Drop Characteristics of Choke Type and Bypass Type Armostats (Ref. 14)

(Courtesy of Knoxville Manufacturing Co.)

AMCP 706-361

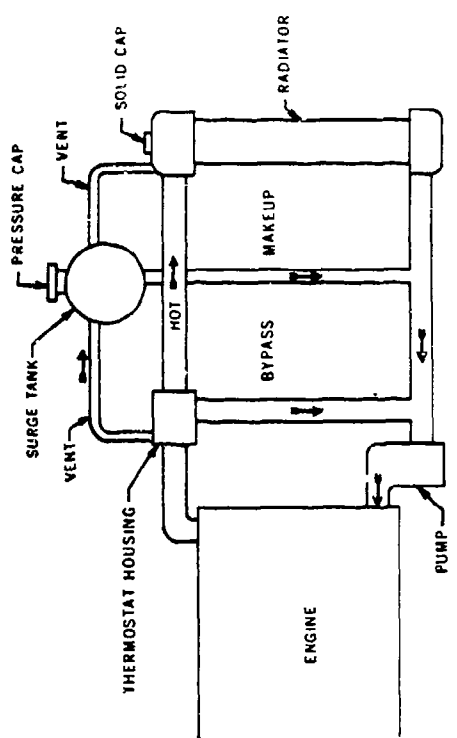

(B) THERMOSTAT AT INLET TO ENGINE

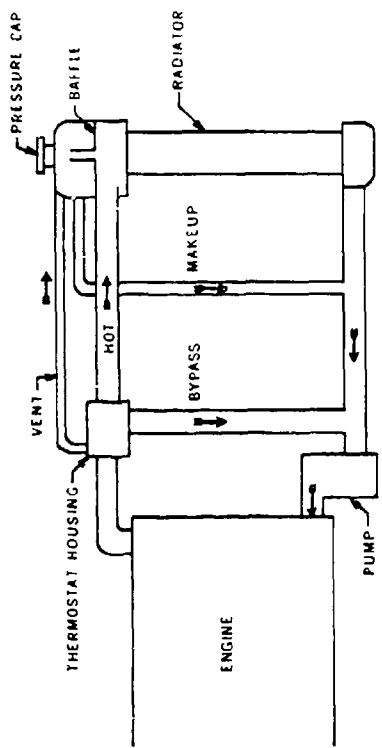

(D) BAFFLED TOP RADIATOR TANK FOR DEAERATION

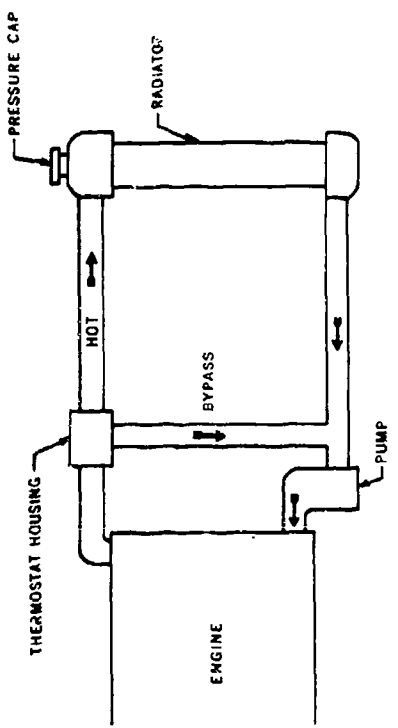

(A) THERMOSTAT AT OUTLET OF ENGINE

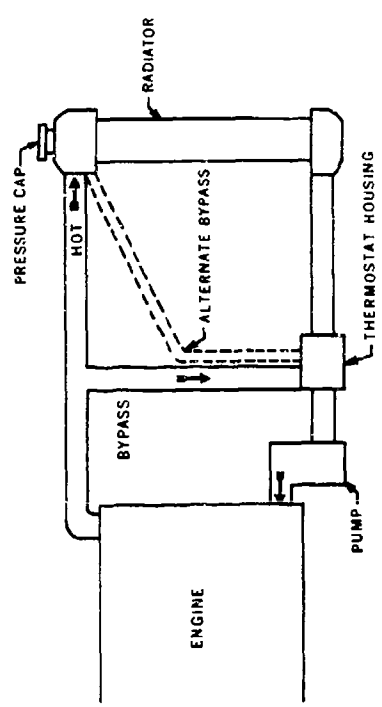

(C) DEAERATION AND SURGE TANK

Figure 5-30. Thermostat Coolant Flow Systems (Ref. 16)
(From Diesel and Gas Turbine Progress, June 1973. Used by Permission of Diesel Engines, Inc.)

C

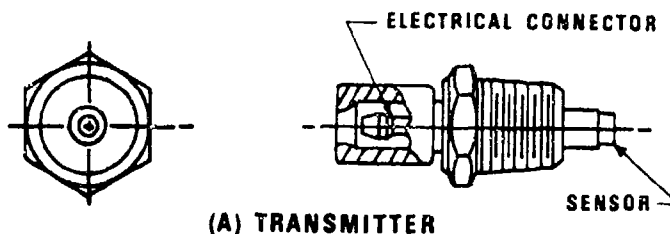

(A) TRANSMITTER

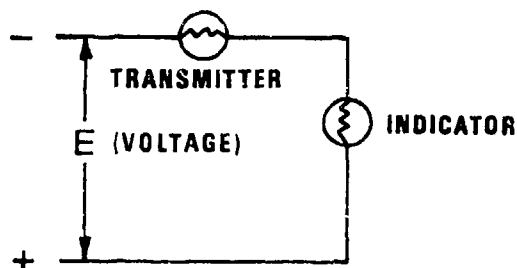

(B) SCHEMATIC WIRING DIAGRAM

Figure 5-31. Military Standard Temperature Transmitter (Ref. 6)

wiring. The sending unit resistance varies in relation to temperature, permitting more or less current to flow to the indicator unit. Fig. 5-31 also illustrates the wiring schematic for a typical installation.

The electric sending unit is essentially a resistor whose resistance varies inversely with temperature. The external configuration of the electric sending unit is a standard male pipe thread or bolt on type construction.

5-6 WARNING UNITS

The temperature sending unit and indicator assembly often are supplemented with thermostatic switches connected for parallel operation to actuate visual or audio signal devices. When abnormal temperatures are encountered, the switch will close and actuate

a warning light or buzzer to alert the operator to a cooling problem. Fig. 5-32(A) illustrates typical thermostatic switches used for this purpose. The reader is referred to Military Standard Drawing Number 18110 for additional details (Ref. 8).

Red warning lights indicating a cooling system malfunction usually are located in the vehicle instrument panel. This is illustrated in Fig. 5-32(B) for the M48 Tank instrument panel (Ref. 9).

5-7 COOLANT LEVEL INDICATORS

Radiator coolant level monitoring devices are available to provide a visual warning to the vehicle operator when the coolant level drops to a critical level.

AMCP 706-361

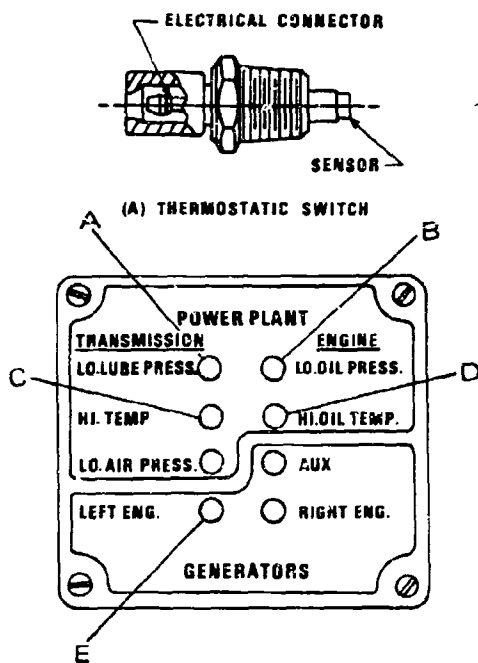

- A-TRANSMISSION OIL LOW PRESSURE WARNING LIGHT
- B-ENGINE OIL LOW PRESSURE WARNING LIGHT
- C-TRANSMISSION OIL HIGH TEMPERATURE WARNING LIGHT
- D-ENGINE OIL HIGH TEMPERATURE WARNING LIGHT
- E-MAIN ENGINE GENERATOR WARNING LIGHT

(B) INSTRUMENT PANEL WITH WARNING LIGHTS

Figure 5-32. M48 Tank Thermostatic Switch and Instrument Panel With Warning Lights (Ref. 9)

The system installed on the M44A2 Truck is shown in Fig. 5-33. The sensor, installed in the radiator top tank, consists of a magnetic float and reed switch assembly calibrated to close at the pre-determined critical coolant level. Closing of the switch activates a red

warning light on the Maintenance Indicator Panel (Fig. 5-34).

The Maintenance Indicator Panel is dashboard-mounted and sensors are mounted permanently on or within the various systems and accessories of the engine and vehicle, and connected to the panel through a wiring harness. The sensors monitor the condition and performance of the various systems and accessories, and alert the driver/mechanic when service is required or a malfunction has occurred by means of a light on the panel. Once a light on the panel has been actuated, it remains on (whenever the master switch is on) until the proper steps are taken to correct the malfunction or the proper maintenance action taken to restore performance to an acceptable level. Solid state circuitry is used to perform the electronic control of the indicator lights. As an initial check for the driver, an automatic lamp test device activates all panel lights for 3 to 7 sec during each start. The system also includes an automatic dimming control for blackout operations.

5-8 COOLANT LEVEL AND AERATION WARNING SYSTEM

This system is designed to trap any air that passes through it while sampling the engine coolant. If the system loses coolant, or if there is air in the system, a warning light on the dashboard is activated. As air is trapped in the unit, a float drops and actuates a microswitch. The microswitch activates a dashboard warning light signalling that the engine should be shut-down. The system also may be installed to sound an alarm or automatically shutdown the engine.

Air can be present from a number of causes such as suction leaks, pump seal leaks, head gasket leaks, heat cracks in the block, low coolant level, and others. Air in a cooling system accelerates engine corrosion with resultant poor cooling (hot spots), and decreased engine life.

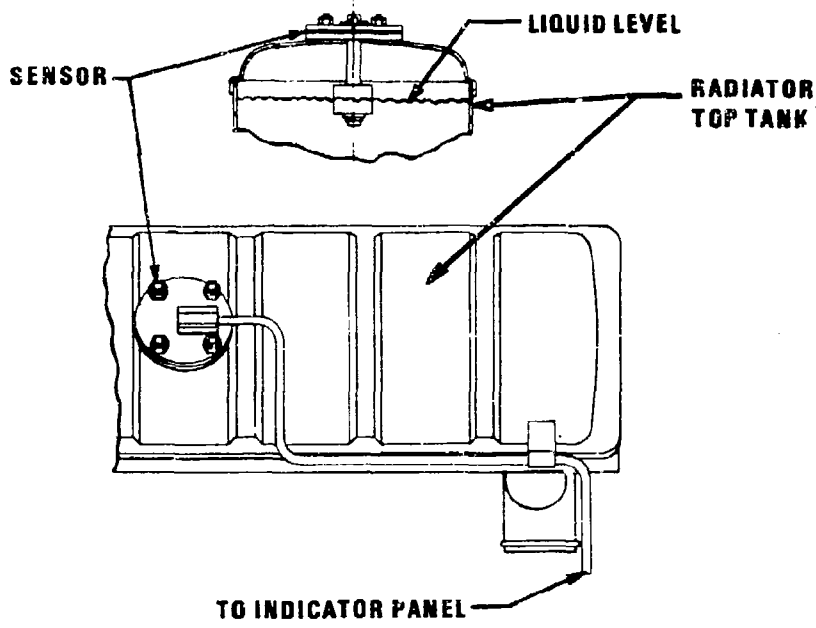

Figure 5-33. Radiator Coolant Level Sensor Installation
(Courtesy of Teledyne Continental Motors)

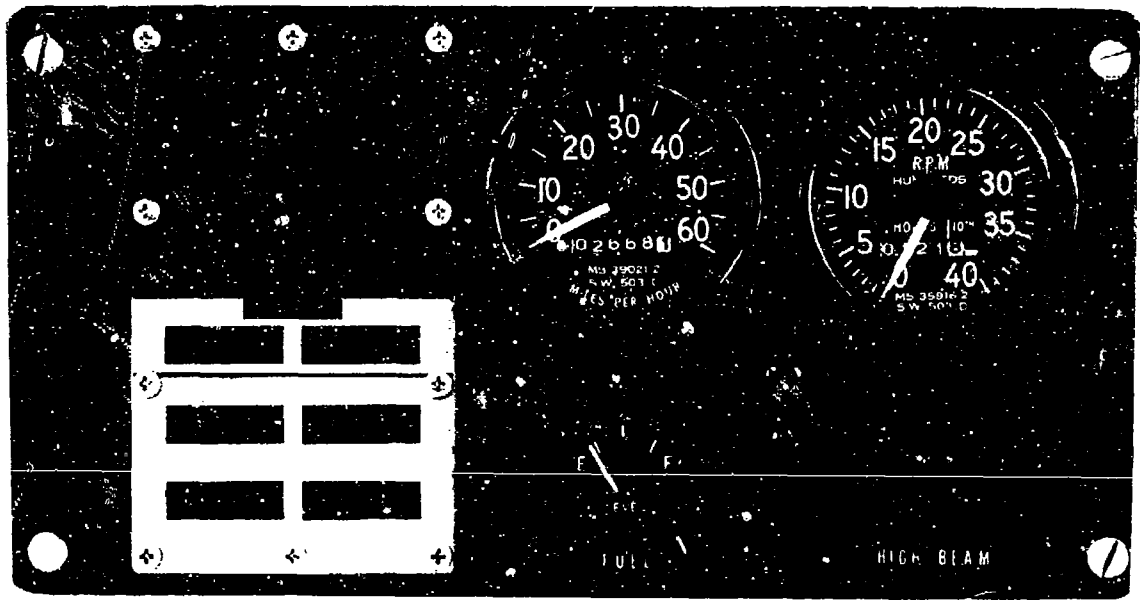

Figure 5-34. Maintenance Indicator Panel
(Courtesy of Teledyne Continental Motors)

AMCP 708-361

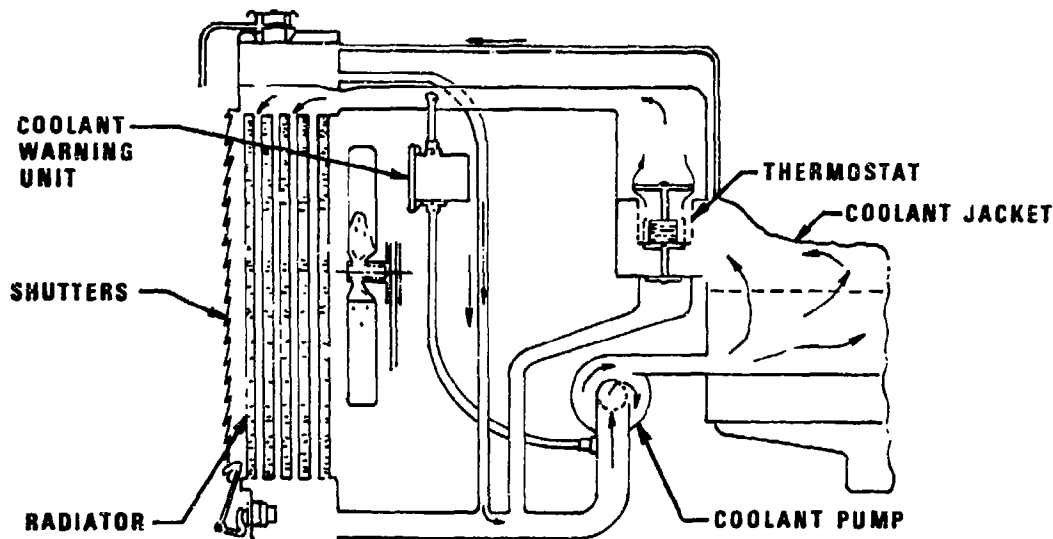

Figure 5-35. Coolant Level and Aeration Warning System Installation (Ref. 15)
 (Standard Controls, Inc.)

The system is installed between the radiator top tank and the suction side of the coolant pump (See Fig. 5-35). While the

engine is running, a small amount of coolant is drawn continuously through the warning system.

REFERENCES

1. *Design and Modification of Industrial Vehicles for Operation at Low Temperatures*, Report No. SP-346, SAE, New York, N.Y., 1968.
2. K. P. Kiefer, *Thermostatically-controlled Guide Vane Shutter*, Report No. 32, Continental Motors Corp., Muskegon, Mich., 1956.
3. MIL-C-45167, *Caps, Radiator, Pressure Relieving*.
4. TM 750-254, *Tactical Vehicle Cooling Systems*.
5. MS 35770, *Thermostats, Flow Control, for 10 to 500 HP Liquid-Cooled Internal Combustion Engines*.
6. MS 24537, *Transmitter, Temperature, Electrical Resistance*.
7. MIL-I-10986, *Transmitter, Indicator, Temperature, Electrical Resistance*.
8. MS 18110, *Switch, Thermostatic, Single Pole, Single Throw, Electric*.
9. TM 9-7012, *90mm Gun, Tank, M48*.
10. Liaison and Training Division Maintenance Directorate, *Hand Outs, M113A1 Personnel Carrier*, US Army Tank-Automotive Command, Warren, Michigan.
11. *Technical Data Sheets, Vernatherm High Force Thermostatic Actuators*, American Standard Controls Department, Pittsburgh, Pa.

12. *Engineering Manual, High Flow Heavy-Duty Thermostats*, Dole Division, Eaton Corporation, Controls Division, Carol Stream, Illinois.
13. PDTM 9-2350-235-20, Volume No. 3, *Preliminary Organizational Maintenance Manual, CAE Engine and Accessories for Main Battle Tank Armored, Full-Trackted 152mm, MBT70*, December 1969.
14. *Technical Data Sheet Nos. 24-29, 24-16-C, 24-41A*, Scoville Manufacturing Company, Waterbury, Connecticut.
15. *Water-Larm Brochure*, Standard Controls, Inc., Seattle, Washington.
16. Backman Wong, "Controlling Heavy Duty Engine Cooling Systems", *Diesel and Gas Turbine Progress*, 58-60, (June 1973).
17. *Bulletin No. 538*, Kysor of Cadillac, Cadillac, Michigan.

BIBLIOGRAPHY

Cooling of Detroit Diesel Engines, Bulletin No. 28, General Motors Corp., Detroit, Mich., May 1967.

James R. Pharis, *Kool Pak-A High-Capacity, Quiet, Thermostatically Modulated Cooling System for Mobile Vehicles*, Paper No. 720715, SAE, New York, N. Y., 1972.

Robert W. Cummings, *Design Considerations for Decongealing Oil Coolers*, Paper No. 690312, SAE, New York, N. Y., 1969.

John Gresch, Ray Beard, *Climatic Control for Air-Cooled Engines from Tropic Heat to Arctic Cold*, Paper No. 394B, SAE, New York, N. Y., Sept. 1961.

MIL-T-45019, *Thermostats, Flow Control, for 10 to 500 HP Liquid-Cooled Internal Combustion Engines*.

Cummins Installation Recommendations, Bulletin No. 952810, Cummins Engine Co., Inc., Columbus, Indiana, November 1971.

60 LIST OF SYMBOLS

- A = area, ft²
 C = orifice coefficient, dimensionless
 C_p = specific heat at constant pressure, Btu/lbm-°F
 P = pressure, in. of water
 Q = heat rejection, Btu/min
 V = velocity, ft/min
 ΔP = pressure drop, in. of water
 ΔT = temperature differential, deg F
 w = airflow, lbm/min
 ρ = density, lbm/ft³

SUBSCRIPTS

- c = corrected
 g = grille
 o = orifice
 s = static
 v = velocity

Definition of Terms (See Preface)

- Mass lbm, pounds mass
Force lbf, pounds force
Length ft, in., feet, inches
Time sec, min, hr; seconds, minutes, hours
Thermal energy Btu, British Thermal Unit

CHAPTER 6

GRILLES

Basic types and characteristics of ballistic grilles are discussed. Comparisons of the airflow performance of the various configurations of grilles are made. Grille performance characteristics are related to other design constraints to determine the best selection of a grille that requires the minimum compromise for the total system. Grille selection examples are given and methods of grille testing are discussed.

6-1 NONBALLISTIC GRILLES AND SCREENS

6-1.1 PURPOSE

Nonballistic grilles and screens are provided for the sole purpose of protecting the vehicle cooling system from damage and/or plugging from rocks, brush, twigs, grass, bugs, and other debris.

6-1.2 TYPES AND CONSTRUCTION

Nonballistic grilles and screen assemblies are constructed of expanded metal (Fig. 6-1), large or small mesh screen (Fig. 6-2), or heavy steel plate (Fig. 6-3) for construction equipment and radiator rock deflectors (Fig. 6-4). It should be noted that the lower radiator rock deflector can be removed to allow installation of a winch. In this case the winch would serve the same purpose as the radiator rock deflector (see Fig. 1-53). The screen provides a means for preventing radiators or cooling fins from plugging and are designed for easy removal and cleaning. The airflow restriction for these grilles is minimal and normally will not exceed 0.5 in. of water in most vehicles unless improperly installed.

The SHERIDAN, M551, vehicle uses debris screens on both inlet and exhaust grilles as shown in Fig. 6-5. In addition to the screens, a debris deflector is installed forward of the intake grilles, as shown in Fig.

1-38, to deflect debris thrown toward the intake grille screens.

For design purposes, the nonballistic screen or grille should have the following characteristics:

1. The effective airflow area of the grille screen must be equal to, or greater than, the radiator or heat exchanger effective airflow area.

2. The peripheral opening area between the grille/screen and the radiator should be equal to, or greater than, the radiator or heat exchanger effective airflow area to allow air entry to the cooler if the grille/screen were to plug.

6-2 BALLISTIC GRILLES

6-2.1 PURPOSE

Ballistic grilles are designed to provide maximum protection against attack. They protect engine components from fragments while permitting maximum passage of air. This satisfies the combustion and power plant cooling requirements. These grilles also must provide protection for the radiator, oil lines, electrical conduits, batteries, and other important components in the engine compartment against projectiles, bullet splash, and fragments. Unfortunately, the functional requirements of these grilles are opposed to

AMCP 708-381



Figure 6-1. Brush Guard and Expanded Metal Screen Grille (USAMERDC)

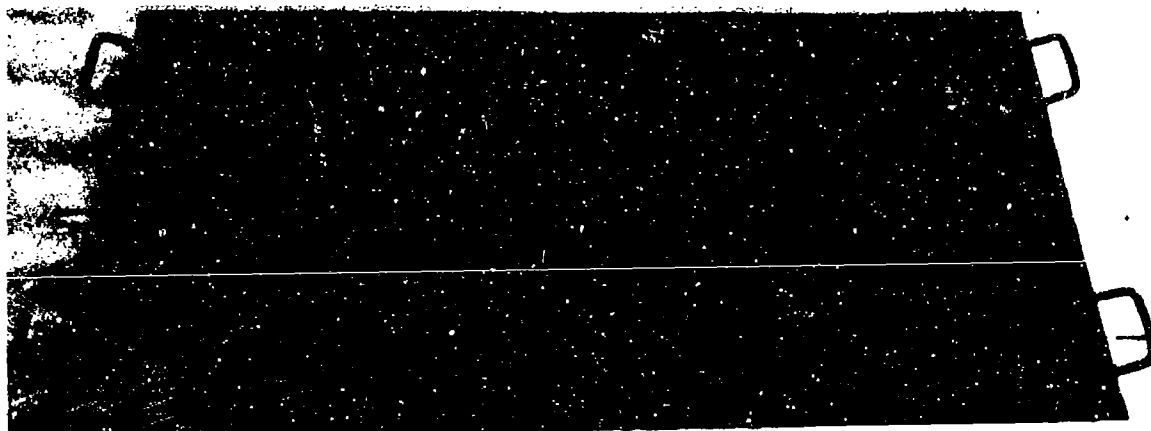

Figure 6-2. Nonballistic Screen (Large Mesh) Attached to Ballistic Grille (USATACOM)



Figure 6-3. Nonballistic Grille and Screen for Construction Equipment (USAMERDC)

each other from the standpoint of design since the greater the flow area provided for the air or gas flow, the easier it becomes for fragments to enter the engine compartment through the grilles. As a consequence, many grille designs have been developed in an attempt to satisfy the major requirements for grilles: maximum protection with minimum airflow restrictions. From an integrated vehicle design viewpoint, both the weight of grille and the volume of grille required to cover a given area of the armor envelope becomes important.

6-2.2 GRILLE DESIGN

The general specifications for grille designs

are determined by their location and available area on a vehicle. The principal design considerations are those of airflow, ballistic performance, weight, and infrared detection.

The ideal grille would provide the same protection as the armor it replaces without any increase in weight and would offer no restrictions to the flow of air. Obviously, these three design considerations are incompatible. Air passages presenting little resistance to airflow also tend to offer little resistance to the passage of projectiles and fragments. Increased ballistic protection without a drastic increase in restriction can be obtained with proper design. A compromise among good airflow, light weight, and

AMCP 706-361

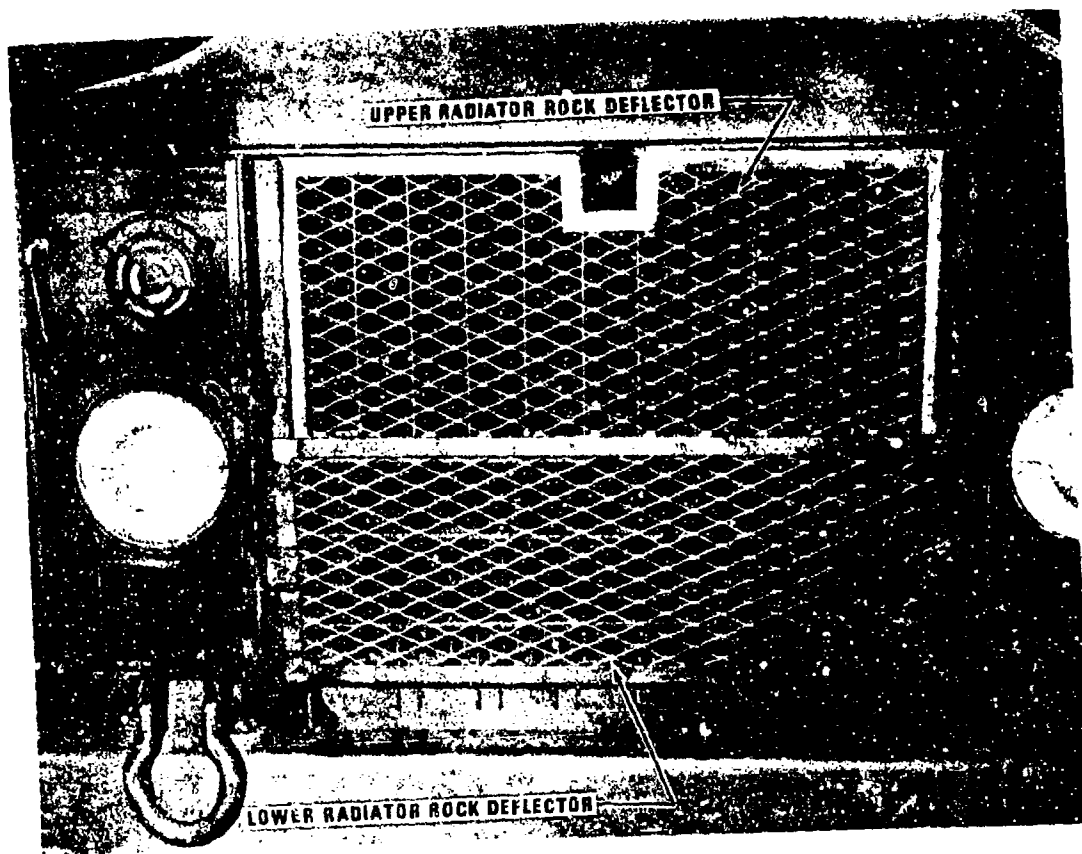

Figure 6-4. Radiator Rock Deflector (USATACOM)

adequate ballistic protection is required. Optimum designs will approach the perfect grille as closely as possible; it is the designer's responsibility to determine which parameter will be compromised the most. Often airflow and ballistic protection are favored with added weight as the compromise; occasionally, ballistic protection is sacrificed. Airflow requirements are based on power package heat rejection requirements and are compromised less easily.

It is doubtful if a design procedure can be formulated that automatically will yield the optimum grille for a given application. Instead, a valid means of evaluating ballistic

performance of any design is available to the designer (Ref. 1). The designer can create a number of designs that can be analyzed basically on paper rather than through ballistic proofing of prototypes. This will provide the means for identifying the best designs and the weak points of each design. Design modifications can be made to improve the best designs, and the improvements can be verified by performing subsequent ballistic analyses. Final proof testing of prototypes will be required only for one or two optimized designs. The considerations of airflow can be verified through airflow testing of wooden models. The ballistic performance evaluation procedure presented in Ref. 1

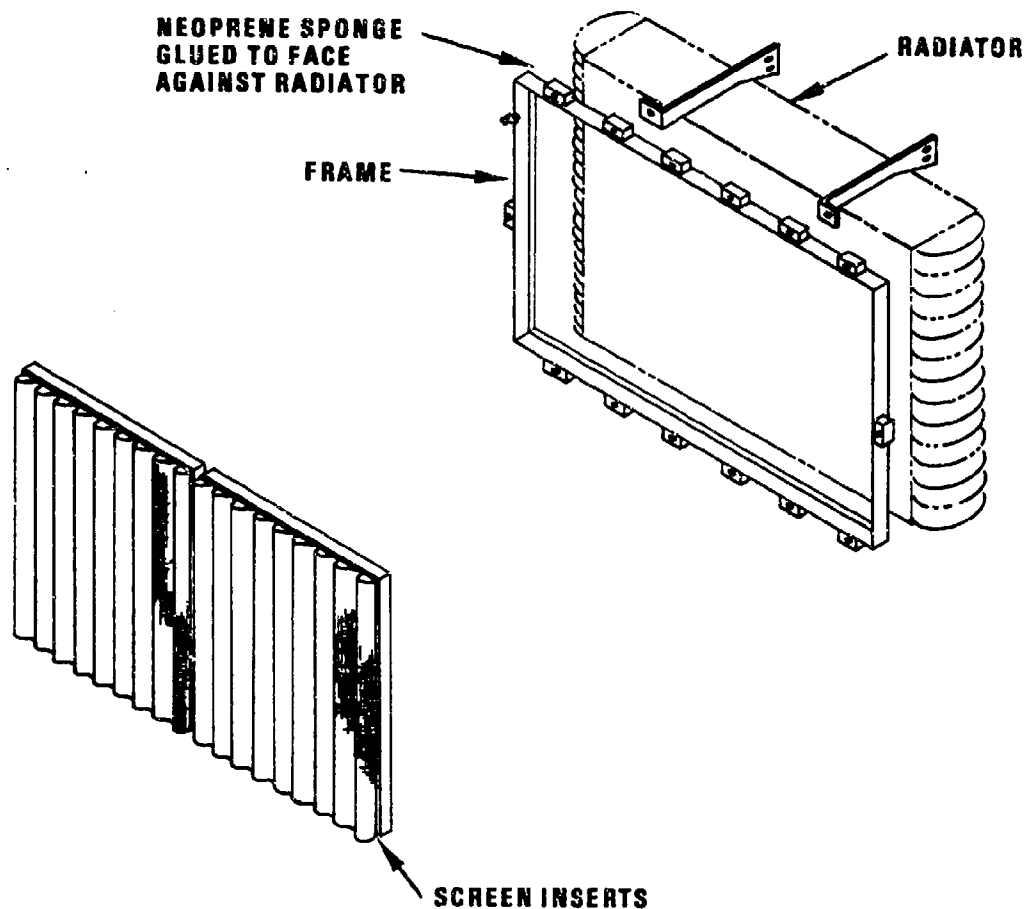

Figure 6-5. Nonballistic Grille Screen Installation (USATECOM)

provides a fast and convenient means for checking the ballistic design of a grille against fragments and small arms projectiles.

6-2.3 TYPES AND CONSTRUCTION

6-2.3.1 Venturi Type

Venturi type ballistic grilles (Ref. 2) as shown in Fig. 6-6 provide minimum restriction to airflow but also provide minimum ballistic protection.

6-2.3.2 Bar Type

Bar type grilles (Ref. 2), consisting of bars set into a frame with air gaps between the bars, were developed during World War II. Fig. 6-7 illustrates this type of construction.

Airflow restrictions were low with this type of construction and ballistic protection was good, however, the weight of the bar type grille was high. In later vehicle designs, the requirement for reduced weight led to

AMCP 706-361

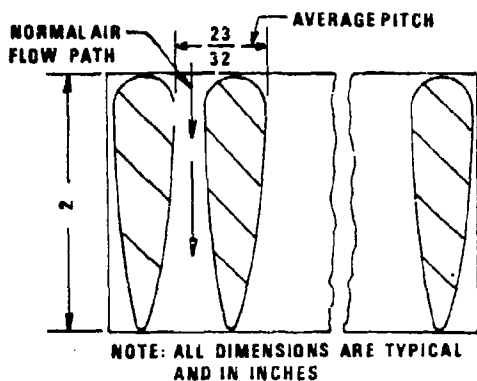

Figure 6-6. Venturi Type Louver Bar Grille Assembly (Ref. 2)

extensive grille development and evaluation. Airflow resistance characteristics for the venturi and bar type of grilles are shown in Fig. 6-8.

6-2.3.3 Fish-hook Type

The fish-hook type ballistic grille, as shown in Fig. 6-9, was developed to provide good airflow resistance characteristics with adequate ballistic protection at minimum weight.

The No. 4 type fish-hook louver bar grille was tested to determine the airflow characteristics as a function of the size (Ref. 2). In this study, the effect of scaling from full size to 3/4-, 2/3-, and to 1/2-scale sections was examined. The 2/3-size configuration performance was slightly better than the full size section, and these two sections were both considerably better than the 1/2-size section. Fig. 6-9 indicates the superiority of the 3/4-size grille airflow resistance characteristics. However, the spacing used is larger than true scale reduction would indicate. As can be noted on Fig. 6-9 the actual spacing for the 2/3-size grille is 1-21/32 in., whereas the computed scale is 1-1/2 in. (actual grille has 5/32 in. oversize spacing). This only serves to emphasize further that not only is the grille bar design critical but the spacing between the

bars greatly influences the airflow.

6-2.3.4 Table-top Type

Indirect flow or table-top grilles also have been airflow tested. This grille design varies from other grille types because the flow direction of the air is changed as it passes through the grille assembly. The cross section diagram of the table-top grille indicating the airflow, is shown in Fig. 6-10. On the basis of equal grille area, this configuration offers more protection than the No. 4 type fish-hook grille. One objection to the indirect type grille design has been its height - it causes a slight raising of the silhouette of the tank engine compartment.

6-2.3.5 Chevron Type

Ballistic grilles have presented a challenge to designers. Most of the grille designs have been made on an intuitive basis, and modifications have been attempted using trial-and-error techniques. The accumulation of all efforts to date including engineering design, test, and trial-and-error is represented in the MBT70 Prototype Tank Chevron Type grille, Fig. 6-11. A comparison of the M60 Tank and MBT70 Prototype Tank ballistic grille pressure drops is shown in Fig. 6-12. Airflow tests of this grille are described fully in Ref. 3.

6-3 AIRFLOW RESISTANCE CHARACTERISTICS

Ballistic grille airflow resistance characteristics are established by test. The flow restrictions are checked both in the normal airflow direction and reverse airflow direction to determine airflow pressure drop and resistance. Extensive test work by the US Army Tank-Automotive Command Laboratories has proven that restriction values obtained from tests of sample grille assemblies are valid for use in predicting actual vehicle grille assembly restrictions and airflow (Refs. 2, 3, 4, 5, 6, 7, and 8). Laboratory airflow

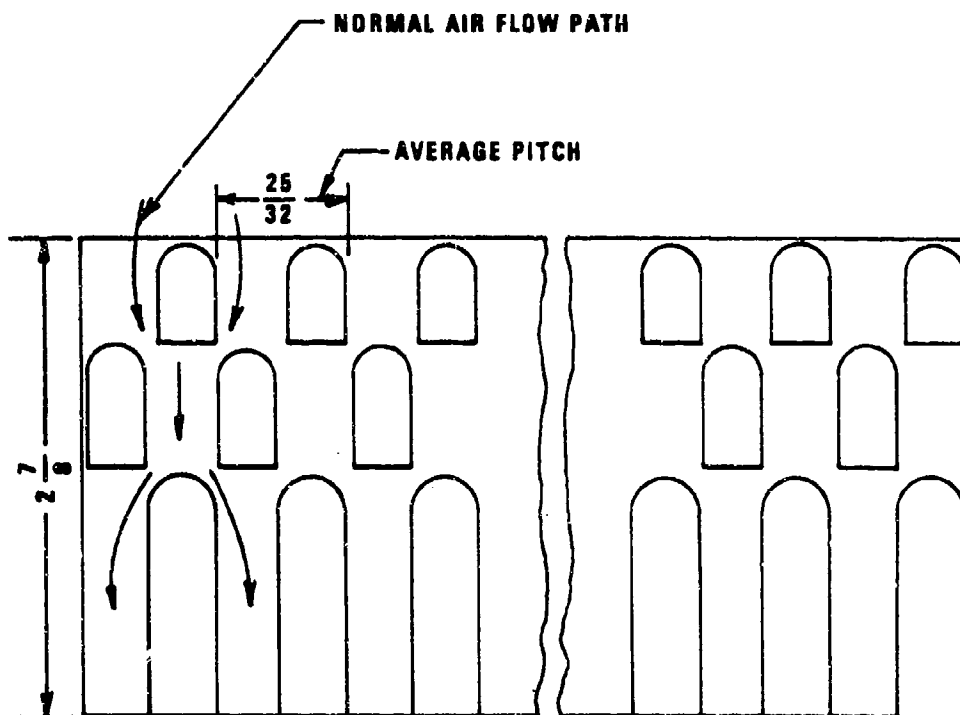

NOTE: ALL DIMENSIONS ARE TYPICAL AND IN INCHES

Figure 6-7. Bar Type Louver Bar Grille Assembly (Ref. 2)

resistance characteristics of these grille assemblies are included in Appendix C. Table 6-1 contains a summary of ballistic grilles used in contemporary military vehicles.

Example:

Determine the inlet and exhaust grille size and pressure drop for a power plant that has the following parameters:

1. 12,000 Btu/min heat rejection rate
2. 120°F inlet cooling air
3. 200°F maximum allowable air temperature
4. Venturi type grilles are used (Fig. 6-8).

The required cooling airflow w can be computed by

$$w = \frac{Q}{C_p \Delta T}, \text{ lbm/min} \quad (6-1)$$

where

C_p = specific heat of air, Btu/lbm-°F

ΔT = temperature differential of air, deg F

Q = heat rejection rate, Btu/min

The quantity of air required for cooling will be

AMCP 706-361

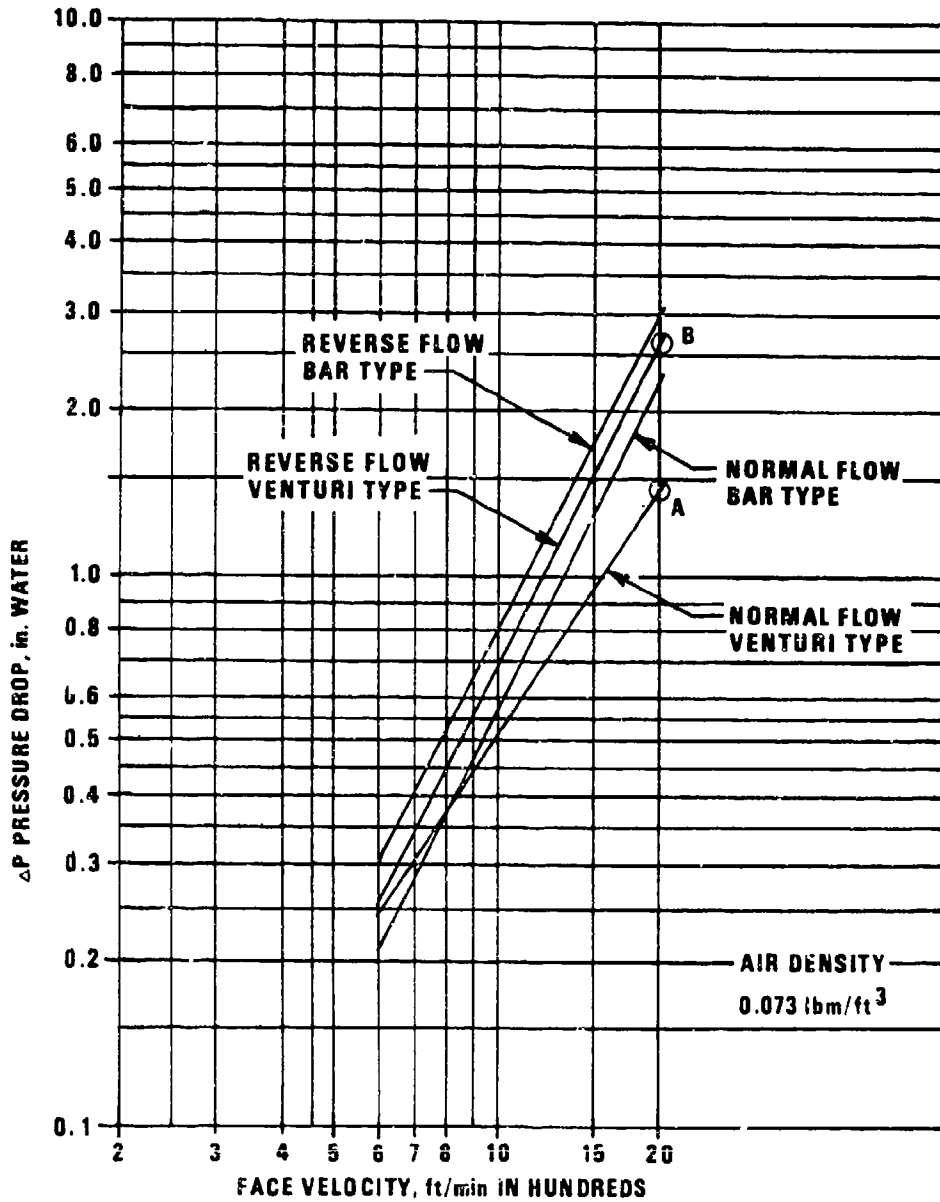

FOR CONDITIONS OTHER THAN TEST CONDITIONS THE CORRECTED PRESSURE DROP ΔP_c IS

$$\Delta P_c = \Delta P \frac{\rho}{0.073} \text{ in. water}$$

WHERE ρ IS THE DENSITY OF THE AIR FLOWING

Figure 6-8. Airflow Resistance Characteristics of Venturi and Bar Type Grilles (Ref. 2)

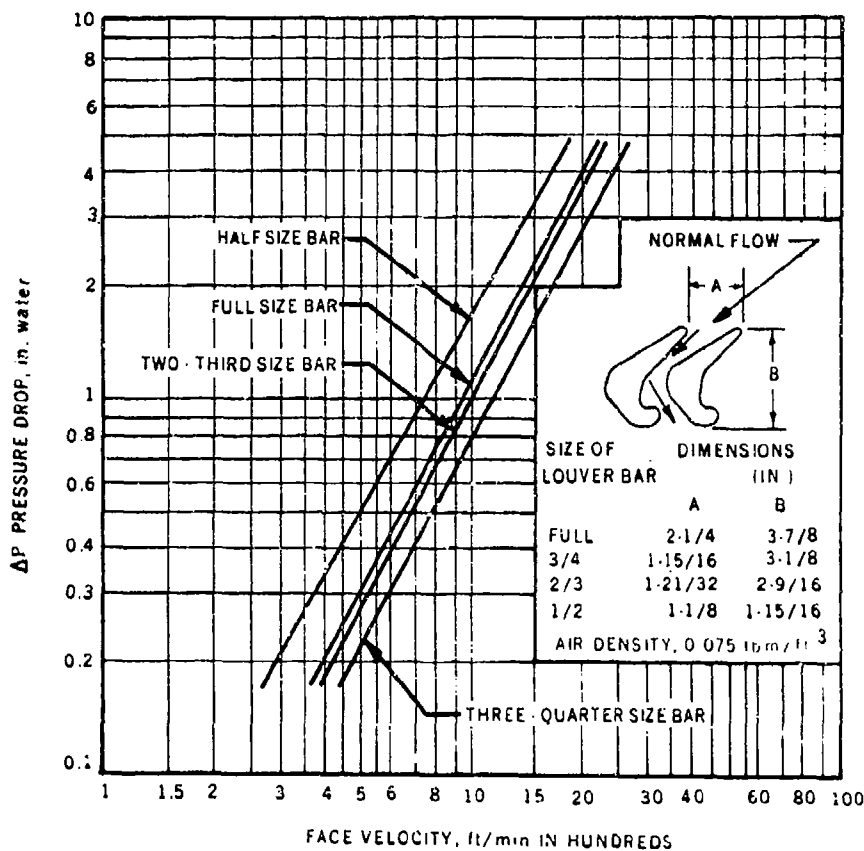

FOR CONDITIONS OTHER THAN STANDARD THE CORRECTED PRESSURE DROP ΔP_c IS

$$\Delta P_c = \Delta P \frac{\rho}{0.075} \text{ IN WATER}$$

WHERE ρ IS THE DENSITY OF THE AIR FLOWING

Figure 6-9. Airflow Resistance Characteristics of No. 4 Fish-hook Type Grilles (USATACOM)

$$w = \frac{12,000}{0.24(200 - 120)} = 625 \text{ lbm/min}$$

The density of air at 120°F is

$$\rho = 0.075 \times \frac{460 + 70}{460 + 120} = 0.06853 \text{ lbm/ft}^3$$

Therefore, the volume of inlet air is:
 $625/0.06853 = 9120 \text{ cfm}$.

Assuming an air face velocity of 2000 ft/min, the area of the inlet grille will be
 $9120/2000 = 4.56 \text{ ft}^2$.

Using the venturi type grille as shown in

AMCP 706-361

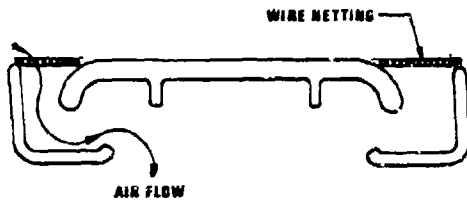

Figure 6-10. Tabie-top Grille Cross Section (USATACOM)

Fig. 6-8 with a face velocity of 2000 ft/min, the pressure drop through the inlet grille for normal flow would be 1.4 in. of water (point A). A correction for the pressure drop of the inlet air because of density change is

$$\Delta P = 1.4 \left(\frac{0.06853}{0.07300} \right) = 1.3 \text{ in. of water}$$

The density of air at 200°F is

$$\rho = 0.075 \times \frac{460 + 70}{460 + 200} = 0.06023 \text{ lbm/ft}^3$$

Therefore, the volume of exhaust air is $625/0.06023 = 10,377$ cfm.

The exhaust grille area will be $10,377/2000 = 5.19$ ft².

Using the venturi type grille as shown in Fig. 6-8 with a face velocity of 2000 ft/min, the pressure drop through the exhaust grille for reverse flow would be 2.7 in. of water (point B). A correction for the pressure drop of the exhaust air because of density change is

$$\Delta P = 2.7 \left(\frac{0.06023}{0.07300} \right) = 2.2 \text{ in. of water}$$

6-4 BALLISTIC PROTECTION CHARACTERISTICS

Ballistic protection provided by grille assemblies is classified information and a

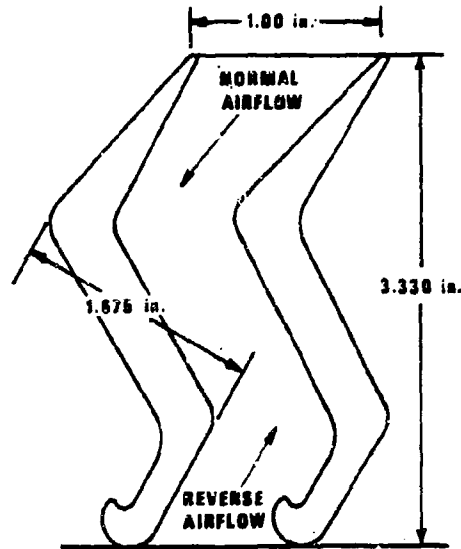

Figure 6-11. Chevron Type Grille Design Characteristics, MBT70 Prototype Tank (USATACOM)

specialized field beyond the scope of this handbook. Ref. 1 and the references cited in the Bibliography for this chapter will provide a broad coverage of this field for the vehicle cooling system designer.

6-5 NOISE

Noise characteristics of ballistic grilles may be considered in the determination of the required effective face areas (Refs. 3 and 6) if specific requirements are stated. Air velocities of 2000 ft/min and higher produced undesirable noise levels in various grilles tested in Ref. 6, and the MTB70 Prototype Tank grille (Ref. 3) simulated a rushing waterfall sound during high airflow test points (14,000 to 17,000 cfm).

Generally, the engine, cooling fan, and vehicle drive train noise levels are considerably higher than the grille airflow noise. These noise levels would have to be greatly attenuated before the grille noise would become significant.

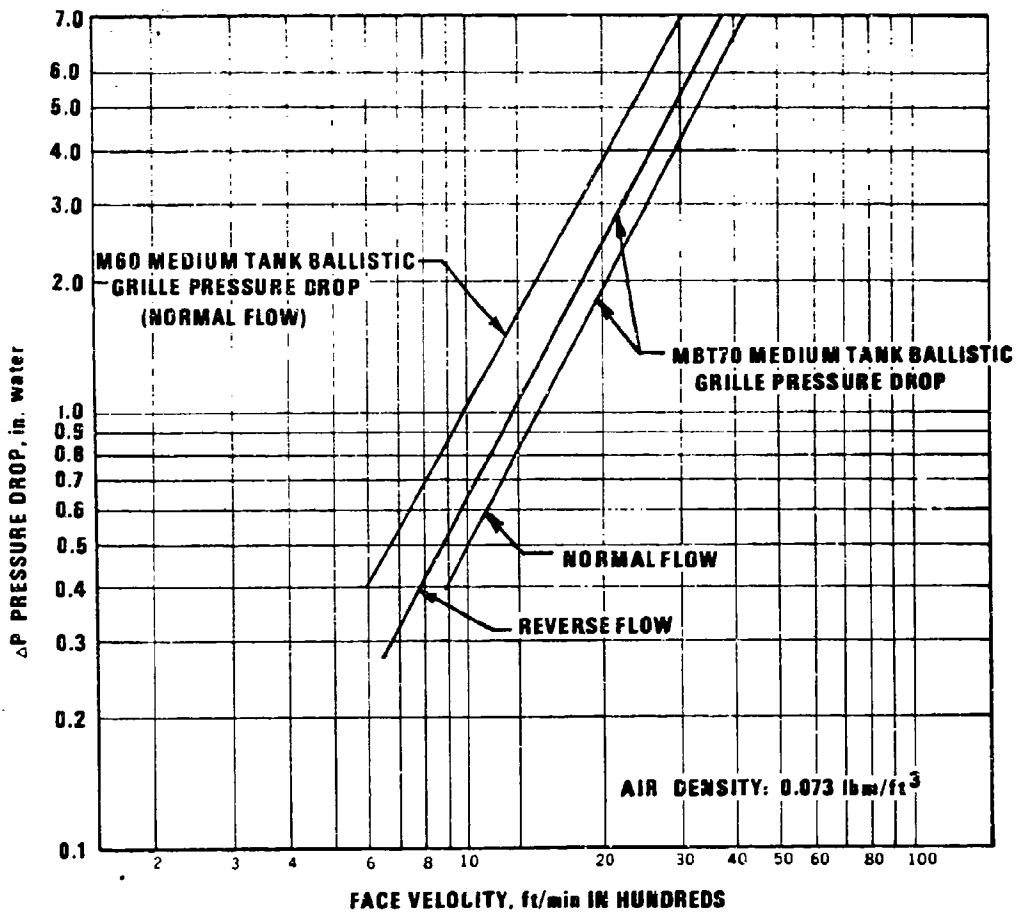

FOR CONDITIONS OTHER THAN TEST CONDITIONS THE CORRECTED PRESSURE DROP ΔP_c IS

$$\Delta P_c = \Delta P \frac{\rho}{0.073} \text{ IN WATER}$$

WHERE ρ IS THE DENSITY OF THE AIR FLOWING

Figure 6-12. Grille Pressure Drop Comparison, M60 and MBT70 Prototype Tanks (USATACOM)

TABLE 6-1

BALLISTIC GRILLES USED IN CONTEMPORARY MILITARY VEHICLES (USATACOM)

Model	Grille Shape		Grille Area, Ft ²	
	Inlet	Exhaust	Inlet	Exhaust
M41	Fish - Hook	Fish - Hook	6.0	9.5
M46 & 47	Fish - Hook	Fish - Hook	11.4	15.5
M48	Fish - Hook	Fish - Hook	21.4	16.2
M60	Fish - Hook	Fish - Hook	11.6	8.6
M103	Fish - Hook	Fish - Hook	15.4	15.8
M107	No ballistic louvers installed in this vehicle		4.2	4.2
M108 & 109	Chevron	Ribbon	11.3	5.7
M110	No ballistic louvers installed in this vehicle		4.2	4.2
M113	Elongated Chevron		5.5	2.9
M114	Chevron	Ribbon	7.5	2.4
M551	Chevron	Chevron	8.5	9.6
M578	No ballistic louvers installed in this vehicle		4.2	4.2
MBT70	Chevron		10.1*	6.0*
XM803 (Eng)	Chevron	Ballistic Deflector Plates	15.1*	4.46*
(Transmission)	-	Chevron	-	2.8*

* Areas measured from laboratory mock-ups

D

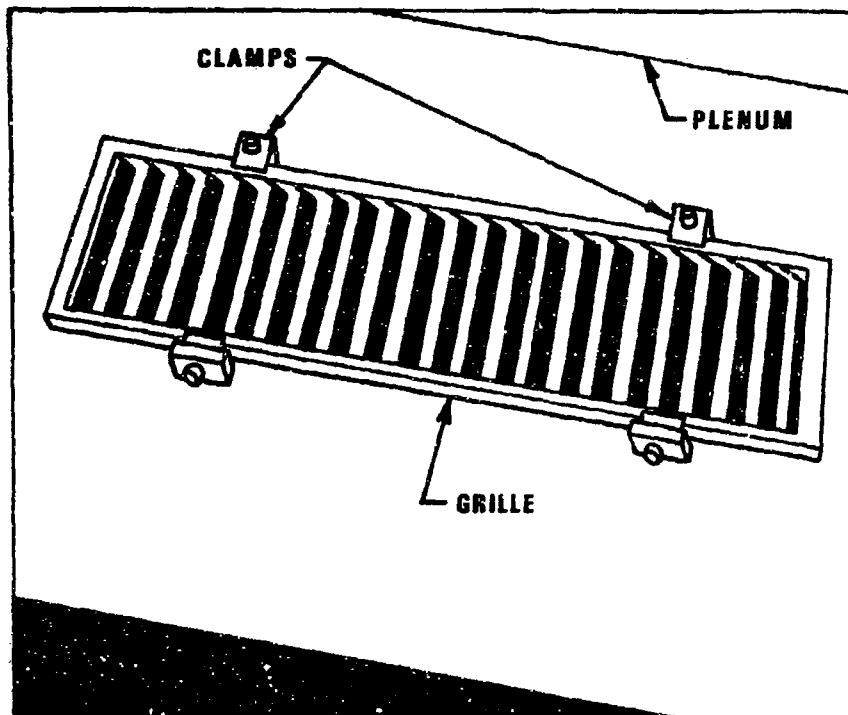

Figure 6-13. Grille Assembly Ready for Test on Flow Chamber

6-6 TEST AND EVALUATION

Testing of ballistic grille assemblies, by the US Army Tank-Automotive Command Laboratories, is conducted to provide data used in the design of vehicle grille assemblies. Wooden models are fabricated and tested to provide valid data on flow restrictions and noise. The grilles are checked for normal and reverse flow directions. Fig. 6-13 illustrates a grille assembly ready for test. The complete test equipment is shown in Fig. 6-14 and a diagram of the test set-up and instrumentation is shown in Fig. 6-15.

6-7 GRILLE INSTALLATION DESIGN CONSIDERATIONS

Evaluation of new grille and screen designs is a continuous program. The design goal of

minimum resistance to airflow, maximum ballistic protection, and the removal of dirt and debris from the incoming air present major problems for the cooling system designer. Important areas of development are in self-cleaning screens, improved armor or grille shapes, and deflectors for protection of heat exchangers and radiators.

Carefully chosen grille locations often may minimize the amount of dirt and debris that is ingested, however, vehicle design usually determines the location where the grille may be installed.

The location of the inlet and exhaust grilles must be such that recirculation of the hot exhaust air into the inlet grilles does not occur. Fig. 6-16(A) illustrates the recirculation effect when the exhaust grille is located toward the front of the vehicle. The vehicle

AMCP 708-351

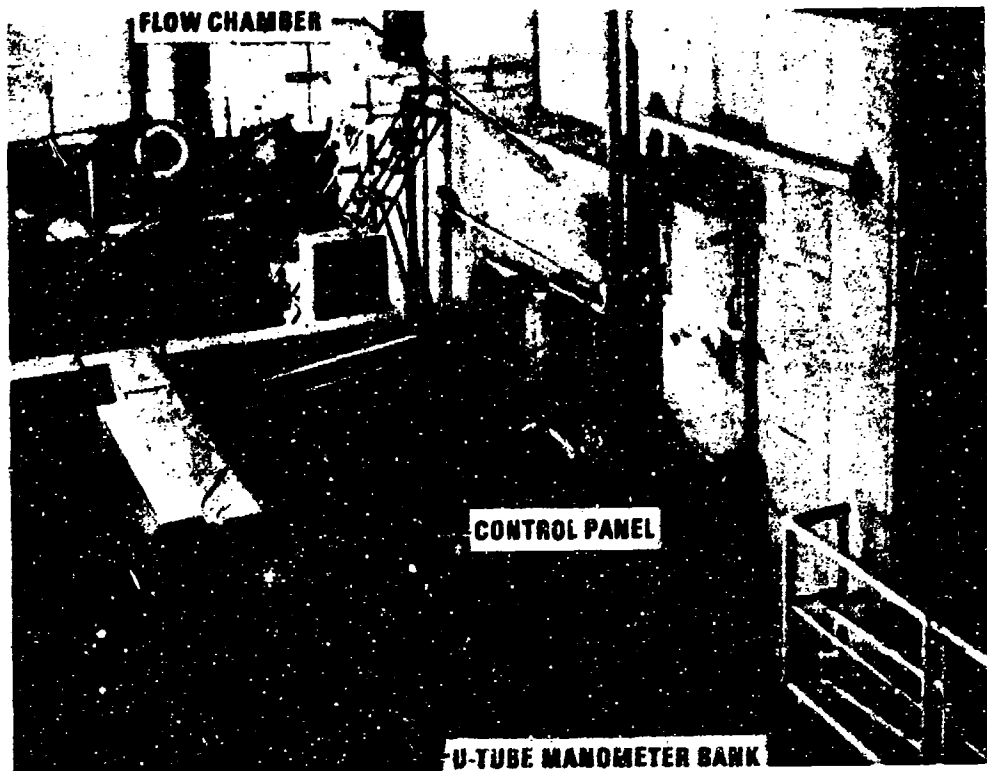
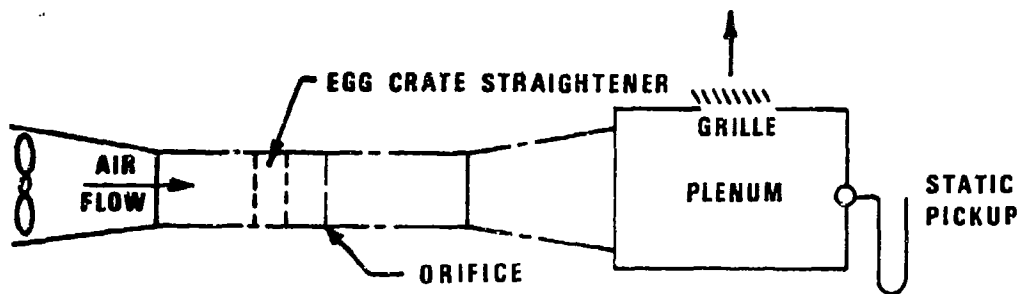

Figure 6-14. Grille Assembly Test Equipment (USATACOM)



THE GRILLE FACE VELOCITY
 IS CALCULATED AS FOLLOWS:

$$V = \frac{1096.2 \times C \times A_o \sqrt{\Delta P / \rho}}{A_g}, \text{ ft/min}$$

WHERE:

- V = FACE VELOCITY, ft/min
- A_o = AREA OF ORIFICE, ft²
- A_g = EFFECTIVE FACE AREA OF GRILLE, ft²
- ΔP = PRESSURE DROP ACROSS ORIFICE, in. water
- ρ = AIR DENSITY BEFORE ORIFICE, lbm/ft³
- C = ORIFICE COEFFICIENT, DIMENSIONLESS

Figure 6-15. Grille Airflow Test Set-up and Instrumentation Diagram (USATACOM)

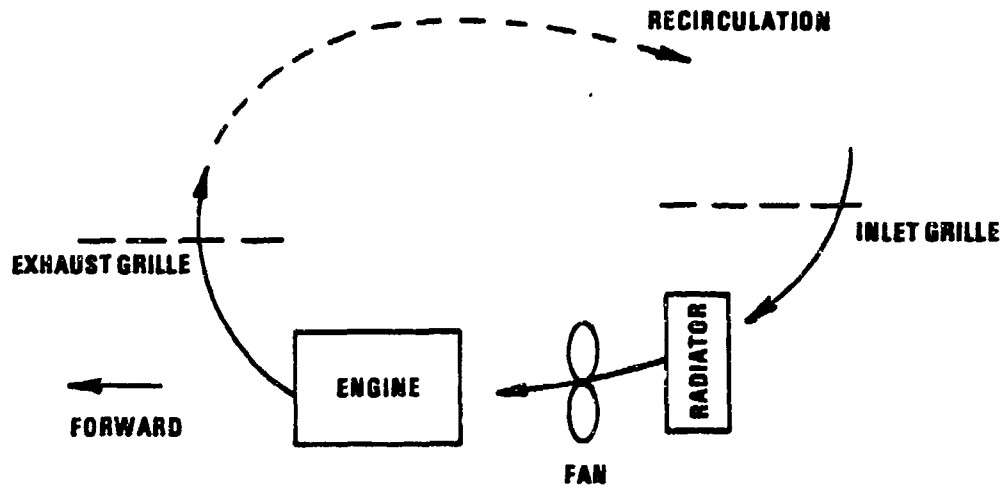

(A) INLET GRILLE LOCATED AT REAR OF VEHICLE

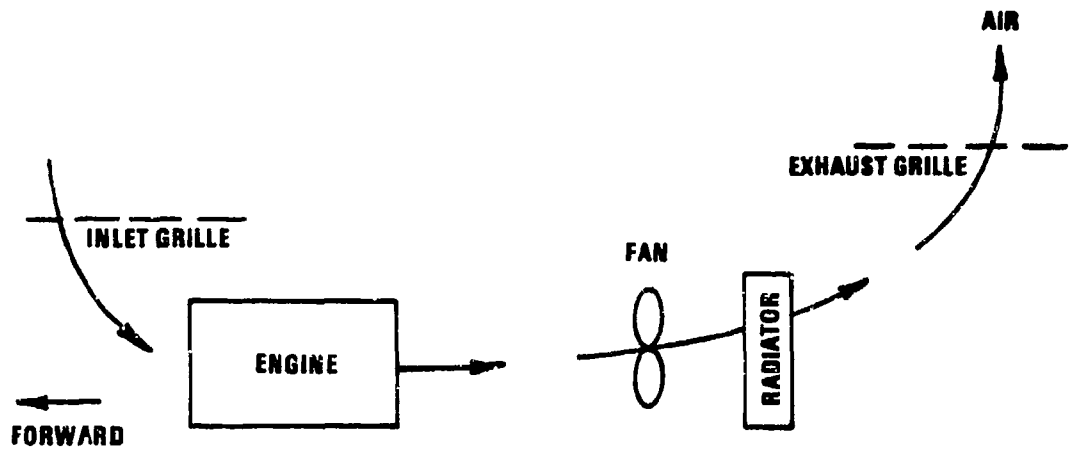

(B) GRILLES CORRECTLY LOCATED TO MINIMIZE RECIRCULATION

Figure 6-16. Inlet and Exhaust Grille Locations

AMCP 706-281

movement causes the hot air to pass over the inlet grille and the cooling capability of the system will be reduced. Fig. 6-16(B) illustrates the correct inlet grille location at the forward end of the vehicle. This configuration minimizes hot air recirculation caused by forward movement of the vehicle.

The location of the cooling fan in relation to the engine, grilles, and radiator can be varied to suit the vehicle design requirements. Either the fan suction or blowing mode as described in par. 4-13 has been used successfully with correct components.

REFERENCES

1. Rodney F. Recht and Thomas W. Ipson, *The Dynamics of Terminal Ballistics - Ballistic Evaluation Procedures for Armored Grille Designs*, (U), Report No. DRI No. 2025, Appendix (Secret), Denver Research Institute, Denver, Colorado, February 1962.
2. Daniel Ewashenko, *Air Flow Characteristics of Various Wood Model Grille Assemblies*, Report No. 3837, Detroit Arsenal, Centerline, Michigan, 26 February 1957.
3. James A. Saltesz, *Air Flow of MBT70 Top Grille Assembly*, Report No. 10574, Detroit Arsenal, Centerline, Michigan, 24 June 1969.
4. Arthur L. Jaeger, Jr., *Air Flow Test of Code G-36 Through G-49 Experimental Grille Assemblies*, Report No. 4840, Detroit Arsenal, Centerline, Michigan, 29 July 1960.
5. Arthur L. Jaeger, Jr., *Air Flow Tests of Code G-17 and G-50 Through G-54 Grille Assemblies*. Report No. 5033, Detroit Arsenal, Centerline, Michigan, 15 May 1961.
6. Arthur L. Jaeger, Jr., *Air Flow Tests of Code G-55 Through G-64 Grille Assemblies*. Report No. 7619, Detroit Arsenal, Centerline, Michigan, 22 October 1962.
7. Arthur L. Jaeger, Jr., *Air Flow Tests of Code G-65 Through G-66 Grille Assemblies*, Report No. 7827, Detroit Arsenal, Centerline, Michigan, 28 March 1963.
8. Arthur L. Jaeger, Jr., *Air Flow Test of a Mock-up of the Cooling System for the T-195 Engine Transmission Compartment*, Report No. 4488, Detroit Arsenal, Centerline, Michigan, 15 May 1959.

BIBLIOGRAPHY

AMCP 706-107, Engineering Design Handbook, *Elements of Armament Engineering, Part Two, Ballistics*.

Murray M. Jacobson, *Proceedings of Symposium on Lightweight Armor Materials* (U), Army Materials and Mechanics Research Center, April 1969, Confidential.

Francis S. Mascianica, *Ballistic Technology of Lightweight Armor*, (U), Army Materials and Mechanics Research Center, July 1971, Confidential.

Francis S. Mascianica, *Summary of Terminal and Ballistic Data on Lightweight Armor Materials* (U), Army Materials and Mechanics Research Center, July 1969, Confidential.

AMCP 706-170 (S) Engineering Design Handbook, *Armor and Its Applications* (U).

D.K. Stafford, et al., *Armor Materials Selection and Design Information* (U), Good-year Aerospace Corporation, January 1969, Confidential.

7-0 LIST OF SYMBOLS

<i>A</i>	= area, ft ²
<i>a</i>	= duct width, in.
<i>b</i>	= duct height, in.
<i>C</i>	= correction factor, dimensionless
<i>CFM</i>	= flow rate, ft ³ /min
<i>D</i>	= diameter, ft, in.
<i>f</i>	= friction factor, dimensionless
<i>g_c</i>	= gravitational conversion constant, 32.2 lbm-ft/lbf-sec ² (see Preface)
<i>GPM</i>	= flow rate, gal/min
<i>K</i>	= loss coefficient, dimensionless
<i>L</i>	= length, ft
<i>M</i>	= Mach number, dimensionless
ΔP	= change in fluid pressure, in. water, lbf/ft ²
<i>Re</i>	= Reynolds number, dimensionless
<i>r</i>	= radius, ft or in.
<i>SSU</i>	= viscosity, saybolt seconds universal
<i>T</i>	= temperature, °F
<i>V</i>	= velocity; ft/sec, ft/min, ft/hr
<i>Y</i>	= system flow characteristics constant, in. water/(cfm) ²
ν	= kinematic viscosity, centistokes
ϵ	= surface roughness of duct, ft
θ	= angle, deg

AMCP 706-361

μ = absolute viscosity, lbm/hr-ft

ρ = fluid density, lbm/ft³

Subscripts

a = angle, actual

b = barometric

c = centerline

d = duct

e = equivalent, exit

h = hour

m = mean

o = orifice

0 = zero

s = screen, standard

t = transition

T = turn

T90 = 90-deg turn

1 = upstream

2 = downstream

w = wire

Definition of Terms (see Preface)

Mass lbm, pounds mass

Force lbf, pounds force

Length ft, in., feet, inches

Time sec, min, hr; seconds, minutes, hours

Thermal

Energy Btu, British Thermal Unit

CHAPTER 7

SYSTEM FLOW RESISTANCE ANALYSIS

This chapter presents the principles of fluid flow resistance and the procedures used to predict flow pressure drops. The fluids considered are air, oil, and coolant. Examples have been made for these fluids showing the resistance to flow in straight passages, various turns, obstructions, and changing flow areas. Pumps for oil and coolant are discussed, and typical performance characteristics presented.

7-1 FLUID FLOW CONDITIONS

The fluid flow treated in this chapter is considered to be

1. Isothermal
2. Subsonic
3. Incompressible.

The effect of heat transfer is not considered. The effects of changes in elevation are not considered either.

7-2 FLOW RESISTANCE

Fluid flow in a vehicle cooling system encounters various resistances and, as a result, a drop in fluid pressure occurs. Fluid pressure generally is expressed as

1. Static pressure
2. Dynamic pressure
3. Total pressure.

In the large majority of cooling systems, velocities of various flows are held to moderate levels and the flows are nearly incompressible (see par. 7-2.1). Under these conditions the dynamic pressure is very small compared with the static pressure; therefore, throughout this chapter "pressure" will mean

static pressure unless otherwise stated. The energy equation for incompressible frictionless flow is expressed by the simplified form of Bernoulli's equation (Eq. 4-1).

For the purpose of convenience, experimental fluid pressure drop data for specific conditions usually are presented directly in the units most commonly used in industry.

7-2.1 FLOW RESISTANCE OF INCOMPRESSIBLE FLUID FLOW

Fluids most generally used in cooling systems of military ground vehicles are water, water and antifreeze mixtures, oils, refrigerant, and air.

Due to the wide variation in the physical properties of liquid and air, it is necessary to discuss airflow resistance and liquid-flow resistance separately. In doing so, repetition of some data may occur.

An incompressible fluid is considered as one in which a change in pressure causes no corresponding change in density. The assumption that liquids are incompressible does not introduce appreciable errors in the calculation of fluid pressure drop but the assumption that air is incompressible introduces errors whose magnitude depends on the velocity of the fluid and the loss coefficient of the particular component or duct section. For an airflow restriction of 30 in. of water, the air density

AMCP 706-361

change would be less than 10 percent. Vehicle cooling system restrictions are normally considerably lower than this value.

Compressible fluids used in systems with small loss coefficients, can be treated as incompressible for velocities below Mach 0.2 with reasonable accuracy. For air at standard atmospheric pressure, 29.92 in. Hg, the Mach number M is

$$M = \frac{V}{49.1 \cdot \sqrt{T + 460}}, \text{ dimensionless} \quad (7-1)$$

where

V = fluid velocity, ft/sec

T = temperature, °F

Most ground vehicle cooling systems operate with low cooling air velocities and pressure drops. For example, the average velocity in front of a typical radiator is in the order of 2000 ft/min which corresponds approximately to Mach 0.03. In these conditions, cooling-air can be treated as incompressible fluid with negligible error when the equations presented in this chapter are used under the stated conditions.

7-2.2 PRESSURE DROP CLASSIFICATIONS

In general, fluid pressure drops may be classified as due to:

1. Surface shear
2. Form drag
3. Variations in flow direction, flow cross-sectional area, shape of flow conduits, and immersed objects
4. Variations in fluid properties or flow velocity due to heat transfer effect.

Surface shear loss often is referred to as skin friction and occurs in all flow passages as a result of dissipation of energy at the walls or surfaces.

Form drag also is referred to as pressure drag and occurs in discontinuous flow passages or in flow over an immersed object. Under these conditions, fluid pressure over the object is distributed unevenly as the result of separation of the flow immediately downstream from the immersed object. Fluid energy is dissipated in the vortices created in the downstream flow. Fig. 7-1 illustrates the vortices shed from behind a tube in a crossflow air stream.

In high velocity flow past immersed components, skin friction loss is negligible compared with the form drag losses. Streamlining of the immersed objects can reduce these losses. Combination of the fluid pressure drops caused by form drag and of flow direction and flow cross-sectional variations also is referred to as dynamic or shock loss.

Fluid pressure loss caused by heat transfer effects is associated with changes in fluid density. This loss generally is significant in airflow or in two-phase flow such as that produced by boiling or condensation.

In determining the overall fluid pressure drop in a cooling system, the four types of losses all must be considered; however, in some cases, one or more types of the pressure drops may be so small that they can be eliminated in the final analysis.

7-2.2.1 Friction Pressure Drop

Friction pressure drop due to skin friction alone generally occurs in straight pipe or duct systems. This pressure drop ΔP for round ducts usually is expressed as

$$\Delta P = f \left(\frac{L}{D_e} \right) \rho \left(\frac{V^2}{2g_c} \right), \text{ lbf/ft}^2 \quad (7-2)$$

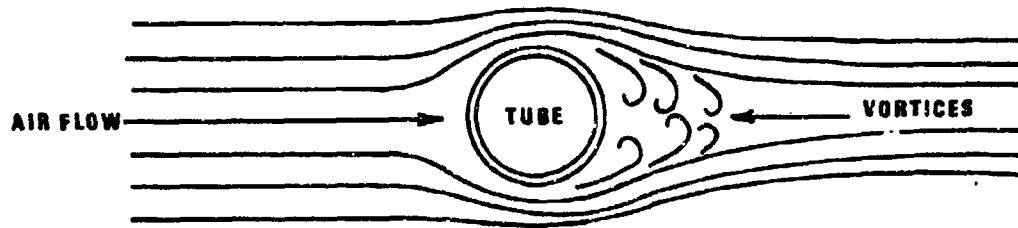

Figure 7-1. Airflow Separation Caused by a Tube in the Cooling System Airflow

where

f = friction factor, dimensionless

L = equivalent length of pipe, ft

D_e = equivalent pipe diameter, ft

ρ = density of fluid flowing, lbm/ft³

g_c = gravitational conversion constant,
32.2 lbm-ft/lbf-sec²

V = fluid velocity, ft/sec

Eq. 7-2 can be rewritten for standard air density as

$$\Delta P = f \left(\frac{L}{D_e} \right) \left(\frac{V_m}{4005} \right)^2, \text{ in. water} \quad (7-3)$$

where

V_m = mean velocity, ft/min (see Appendix D for test methods of determining V_m)

For nonstandard air density, the pressure drop ΔP must be corrected to the actual pressure drop ΔP_a as follows if air velocity is kept constant

$$\Delta P_a = \Delta P \left(\frac{\rho_a}{\rho_s} \right) = \Delta P \left(\frac{\rho_a}{0.075} \right), \text{ in. water} \quad (7-4)$$

where

ρ_s = 0.075 lbm/ft³ for standard air at 70°F and 29.92 in. Hg

$$\rho_a = 0.075 \left(\frac{530}{460 + T_a} \right) \left(\frac{P_b}{29.92} \right), \text{ lbm/ft}^3 \quad (7-5)$$

where

T_a = temperature of air, °F

P_b = barometric pressure, in. Hg

The equivalent diameter D_e (or hydraulic diameter) of a noncircular flow cross section is defined as

$$D_e = \frac{4(\text{flow cross-sectional area})}{\text{wetted perimeter}}, \text{ ft} \quad (7-6)$$

For a circular duct the equivalent diameter is equal to the inside diameter D of the duct. For noncircular ducts the equivalent diameter D_e can be computed by Eq. 7-6 (see par. 7-2.4.2.5 for an example) or found from Fig. 7-5.

Note: The values for friction factor f have been determined for use in Eq. 7-3. Other texts that the designer may use for reference may calculate the friction factor f values on the basis of hydraulic radius instead of diameter as shown here. Extreme caution

AMCP 706-361

must be used to assure that correct numerical values for the friction factor f are used in Eq. 7-3.

7-2.2.1.1 Reynolds Number

For a smooth straight duct or pipe, friction factor f is a function of the Reynolds number Re of the flow. Re is a dimensionless parameter used to characterize the flow pattern. It is defined as

$$Re = \frac{\rho D_e V_h}{\mu}, \text{ dimensionless} \quad (7-7)$$

where

D_e = duct diameter, ft (or equivalent diameter for noncircular ducts)

V_h = fluid velocity, ft/hr

ρ = fluid density, lbm/ft³

μ = fluid absolute viscosity, lbm/hr-ft

The relationship between Reynolds number Re , relative roughness ϵ/D , and friction factor f are shown in Fig. 7-2. Note that in the laminar flow region the relative roughness has no effect on the friction factor f .

7-2.2.1.2 Relative Roughness

Roughness ϵ is defined as the average roughness of the duct or pipe surface. Fig. 7-3 illustrates the relative roughness ϵ/D for various circular ducts.

Pressure drop ΔP (in. of water) for airflow in straight ducts with constant cross-sectional area can be read directly from Fig. 7-4. The values given in this figure are based on standard air density of 0.075 lbm/ft³ and average commercial production duct surface roughness. When air of greater or less density is handled, the value given by Fig. 7-4 is corrected by multiplying it by the ratio of the

actual density of the air handled to standard density as shown by Eq. 7-4.

The data from Fig. 7-4 also can be used for a rectangular duct by using the equivalent diameter from the nomograph in Fig. 7-5 as the duct diameter.

7-2.2.2 Dynamic Pressure Drops

Fluid pressure drop ΔP due to a change in flow direction, cross-sectional area, or shape of the flow cross section for standard air density may be expressed by

$$\Delta P = K_T \left(\frac{V_m}{4005} \right)^2, \text{ in. water} \quad (7-8)$$

where

K_T = loss or resistance coefficient, dimensionless (see Table 7-1 for values of K)

V_m = velocity of air, ft/min

The loss or resistance coefficients for turns shown in all figures in this chapter give total fluid pressure drop due to flow direction change only. Wall or straight duct friction loss (par. 7-2.2.1) must be added to the turning loss to obtain the overall fluid pressure drop caused by the turn.

7-2.2.2.1 Fluid Pressure Drops in a Bend or Elbow

Fluid pressure drop in a bend or elbow is the summation of surface skin friction and the dynamic loss due to the change in flow direction. This dynamic loss generally is expressed by using either a loss or resistance coefficient or an equivalent length of straight pipe.

7-2.2.2.2 Loss Coefficient for Bends and Elbows

Loss coefficients for 90-deg turns K_{T90}

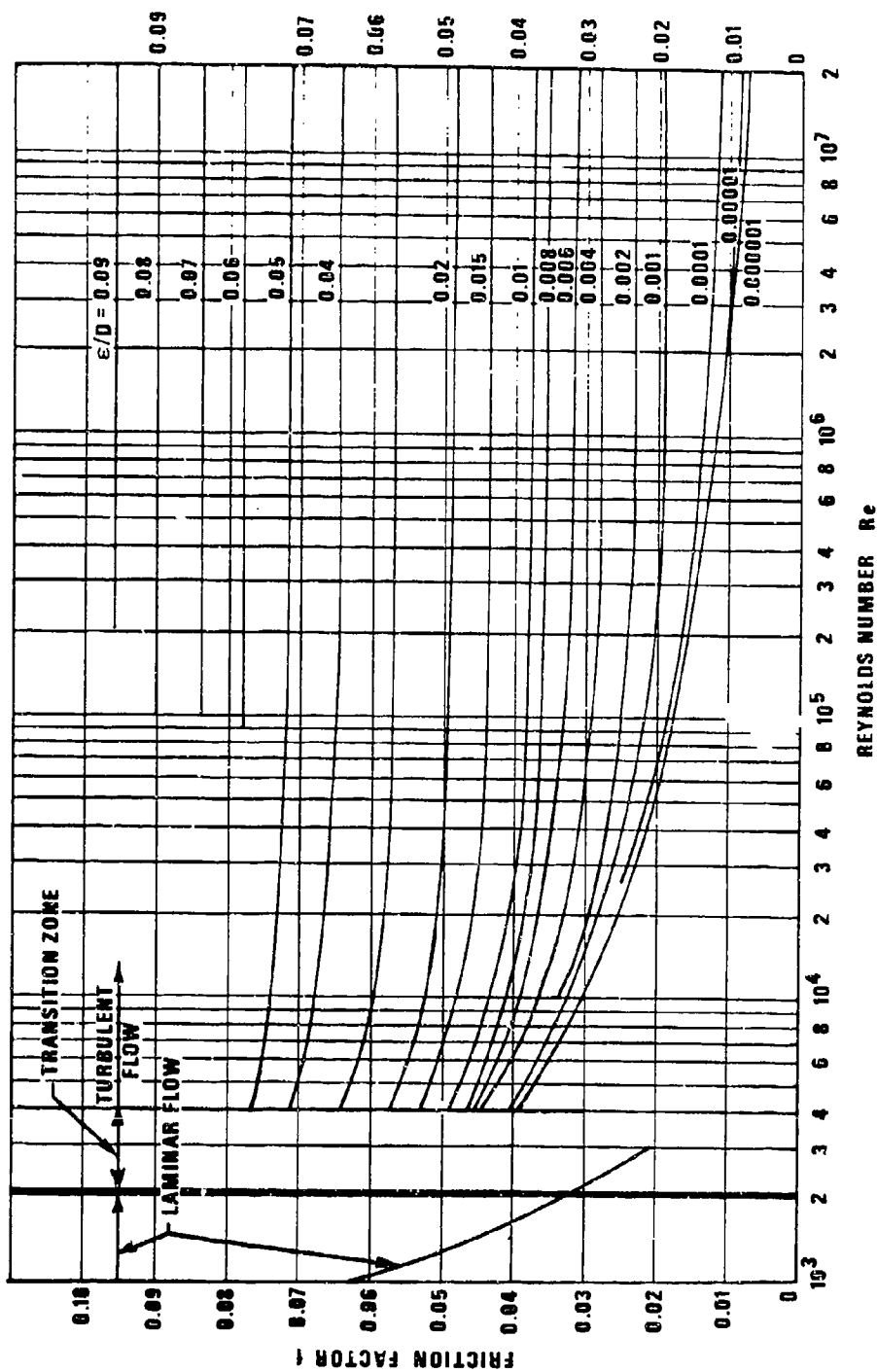

Figure 7-2. Friction Factor vs Reynolds Number (Ref. 3) (Release Granted by Society of Automotive Engineers, Inc., Aerospace Applied Thermodynamics Manual.)

AMCP 706-361

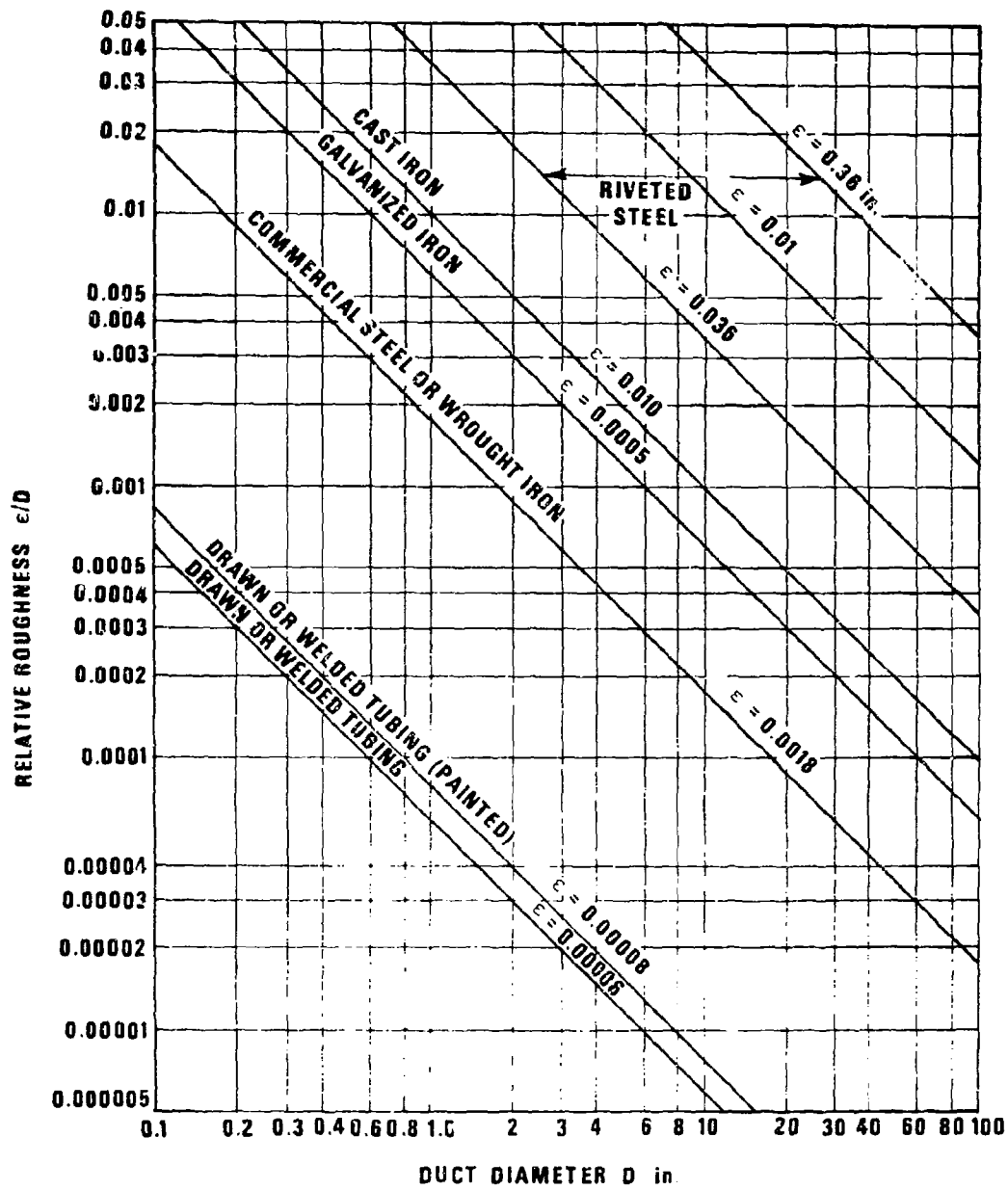

Figure 7-3. Relative Roughness of Circular Ducts (Ref. 3) (Release Granted by Society of Automotive Engineers, Inc., Aerospace Applied Thermodynamics Manual.)

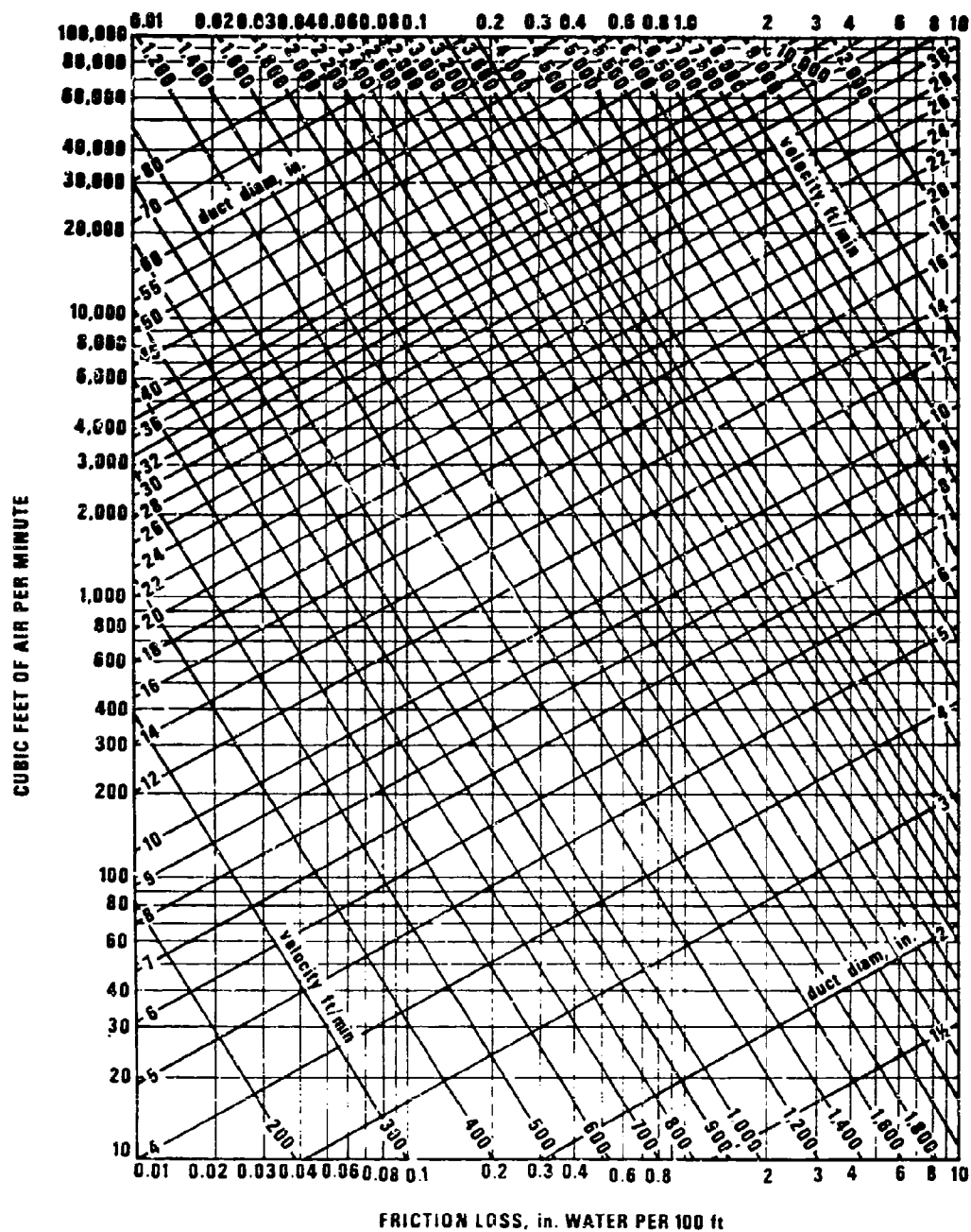

Figure 7-4. Friction of Air in Straight Ducts for Volumes of 10 to 100,000 cfm (Ref. 13)
(Courtesy of Buffalo Forge Company)

AMCP 708-381

Example: What is the equivalent hydraulic diameter of a duct having sides of 60 and 30?

Solution: When using the nomogram both A and B are multiplied by N , thus D_e must also be multiplied by N . Construct a line from 6 on the A scale to 3 on the B scale and where this line intersects the D_e scale read the answer of $D_e = N(4) = 40$.

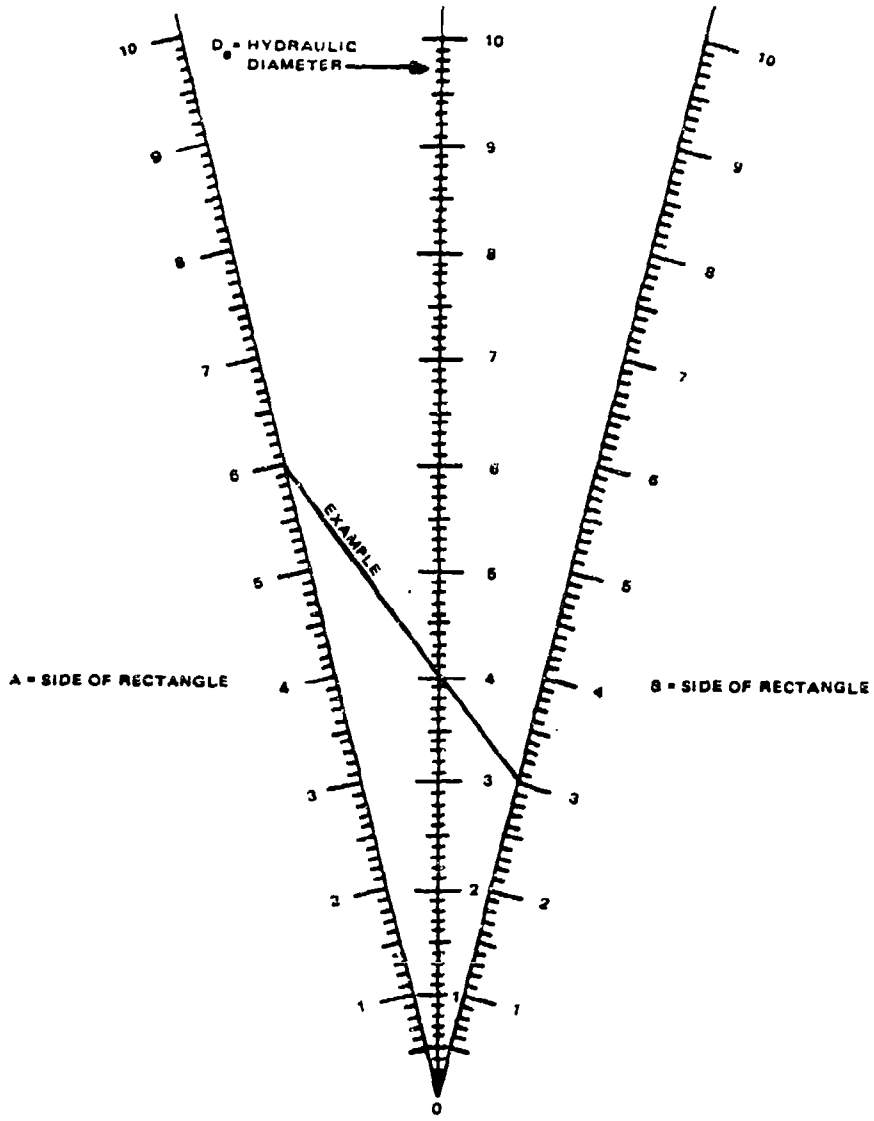

Figure 7-5. Equivalent Diameter of Rectangular Ducts (Ref. 16)
(Courtesy of Design News)

for constant area rectangular and circular ducts are shown in Fig. 7-6. Additional values and duct configurations are found in Refs. 2, 3, and 13.

If no duct follows the elbow, the bend angle is other than 90-deg, or the bend is transitional, the loss coefficient K_{T90} must be corrected for these conditions and the total loss coefficient K_T may be expressed as

$$K_T = K_{T90} C_e C_a C_t, \text{ dimensionless} \quad (7-9)$$

where

K_{T90} = loss coefficient for 90-deg turn, dimensionless (Fig. 7-6)

C_e = loss coefficient correction factor for ducts without following or exit ducts, dimensionless (Fig. 7-7)

C_a = loss coefficient correction factor for bend angles other than 90-deg, dimensionless (from Fig. 7-8 use the applicable curve):

(A) For bends with a following duct

(B) For bends without a following duct

C_t = loss coefficient correction factor for transitional bends, dimensionless (Fig. 7-9)

The data from Fig. 7-7 can be applied to elliptical and circular ducts in lieu of specific data for these ducts.

In Eq. 7-9, only the applicable correction factors are applied.

By combining Eqs. 7-3 and 7-8, the total pressure loss for standard density airflow q to a bend is expressed by

$$\Delta P = \left[f \left(\frac{L}{D} \right) + K_T \right] \left(\frac{V}{4005} \right)^2, \text{ in. water} \quad (7-10)$$

For air density at other than standard temperature and pressure (70°F and 29.92 in. Hg), the pressure drop ΔP is corrected by using Eq. 7-4.

Fig. 7-10 shows total fluid pressure loss characteristics for various radius ratios for a 90-deg turn. While this figure applies for a Reynolds number of 10^6 , the relationship holds true for other values of Re . From this illustration, it is shown that a radius ratio between 2 and 3 results in minimum pressure losses—indicating that this radius ratio should be used for duct designs wherever possible.

7-2.2.3 Dynamic Losses for Area Changes

Table 7-1 shows loss coefficients K for a variety of area changes that are applicable to the general Eq. 7-8 (additional data on loss coefficients are found in Refs. 2 and 4). The subscript for the loss coefficient K in Table 7-1 indicates the cross section where the velocity V_m is calculated.

7-2.2.4 Diffusers

Whenever possible, a diffuser (gradual expansion in Table 7-1) should be designed symmetrically about its axis with an expansion angle θ between 7- and 10-deg. Nonsymmetrical flow or too great an expansion angle may cause the flow to separate from the diffuser walls and cause an increase in pressure loss.

7-2.2.3 Screens and Grids

The pressure loss coefficients K_T of Fig. 7-11 (based on upstream velocity head) are for screens mounted in a duct where the upstream and the downstream areas are the same. The loss coefficients are for Reynolds

AMCP 706-361

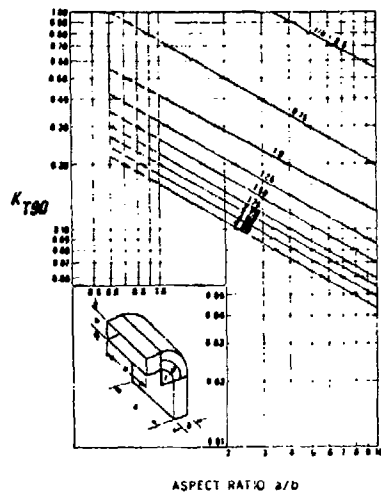

(A) Loss Coefficient for 90-deg Bends,
 Rectangular Ducts, $Re = 100,000$

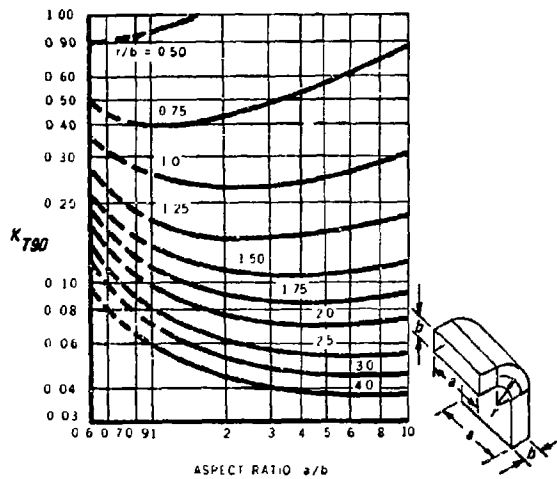

(B) Loss Coefficient for 90-deg Bends,
 Rectangular Ducts, $Re = 300,000$

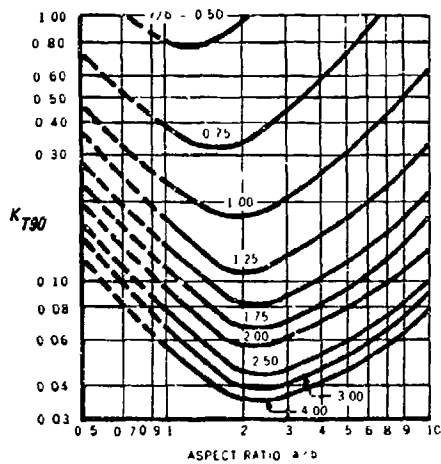

(C) Loss Coefficient for 90-deg Bends,
 Rectangular Ducts, $Re = 600,000$

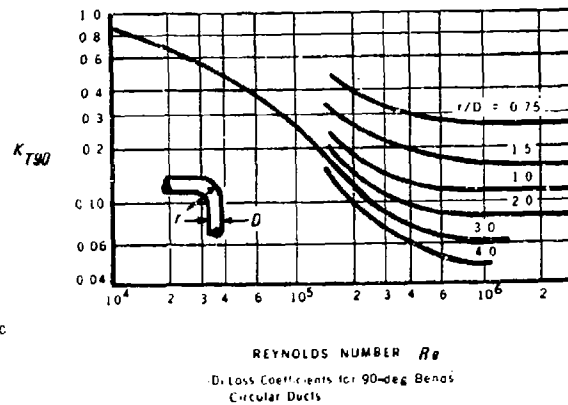

(D) Loss Coefficients for 90-deg Bends,
 Circular Ducts

Figure 7-6. Loss Coefficient for 90-deg Constant Area Bends With Following Ducts (Ref. 3)
 (Reprinted with permission, Copyright © Society of Automotive Engineers, Inc. All rights reserved.)

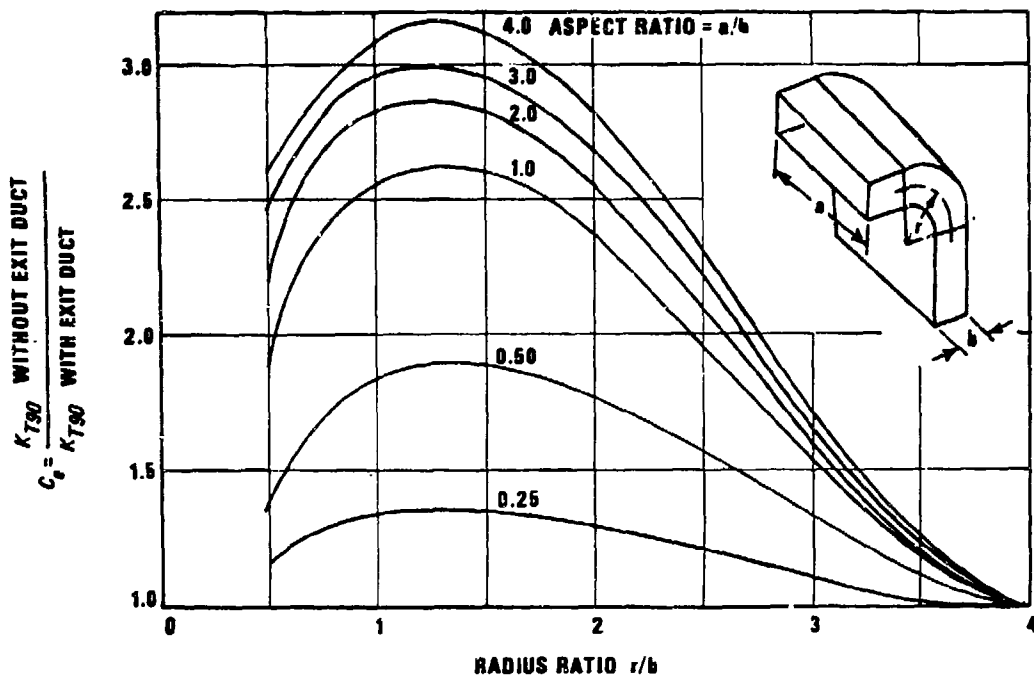

Figure 7-7. Duct Loss Coefficient Correction Factor for 90-deg Bends Without Exit Duct (Ref. 3) (Release Granted by Society of Automotive Engineers, Inc., Aerospace Applied Thermodynamics Manual.)

numbers (based on the screen open area and velocity) greater than 400. The Reynolds number Re is determined by

$$Re = \frac{\rho D_w V_l}{\mu} \left(\frac{A_d}{A_s} \right), \text{ dimensionless} \quad (7-11)$$

where

V_l = upstream velocity, ft/hr

D_w = wire diameter, ft

A_d = duct area, ft²

A_s = screen flow area, ft²

ρ = fluid density, lbm/ft³

μ = fluid absolute viscosity, lbm/hr-ft

The pressure loss ΔP can be calculated by Eq. 7-8 using K_T from Fig 7-11 and velocity V_l based on the upstream duct area.

7-2.2.4 Air Pressure Loss Over Immersed Bodies

The pressure drop resulting from the obstruction to flow due to tubes or other immersed bodies with simple shapes can be approximated by analysis of the contractions and enlargements caused by the object. Table 7-1 gives loss coefficients for several typical obstruction shapes in a duct. The coefficients are based on the ratio of the object thickness to the duct diameter.

Airflow analyses of complex shapes and configurations such as power package lines, hoses, accessories, components, and fittings are determined from actual tests because of

AMCP 706-361

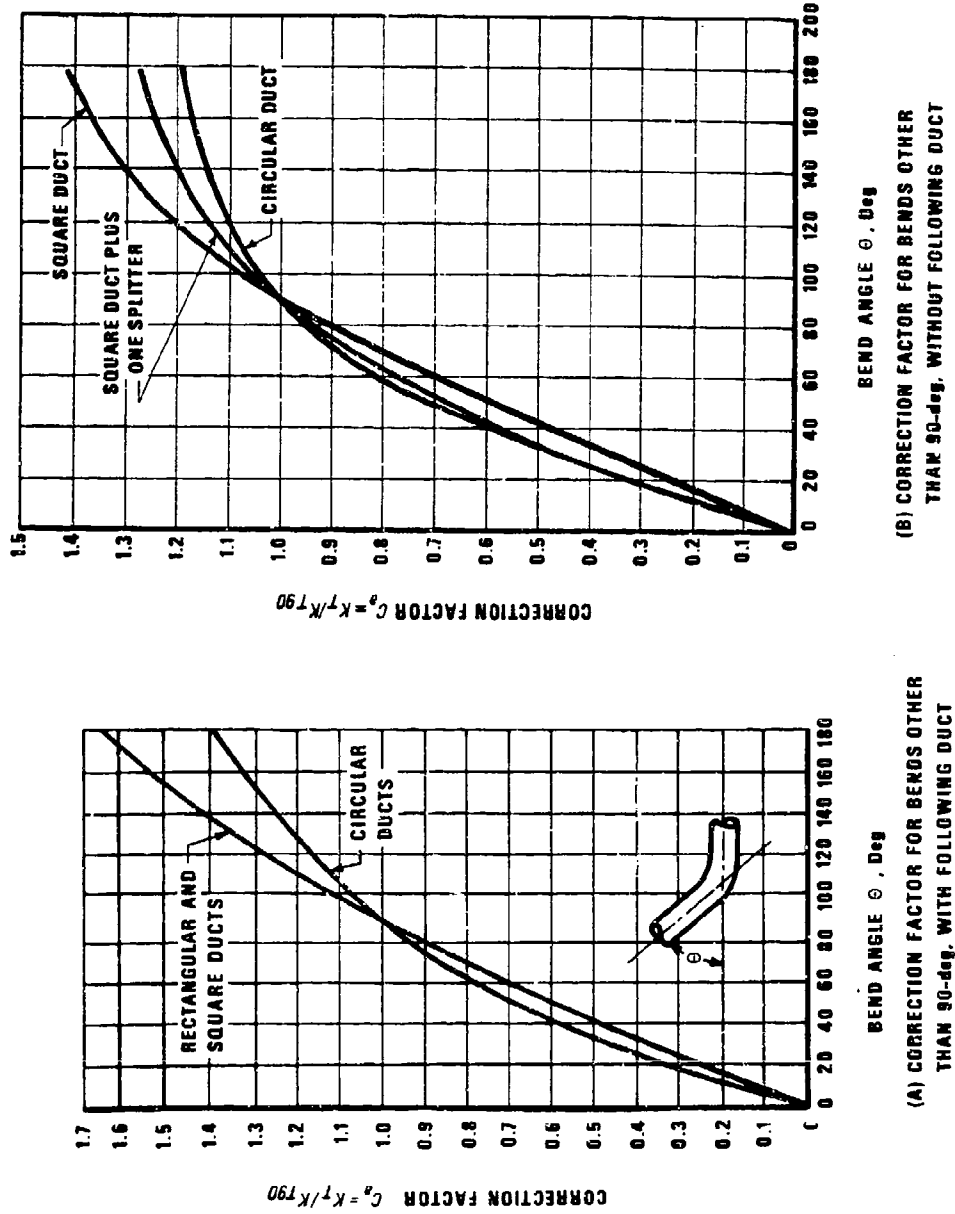

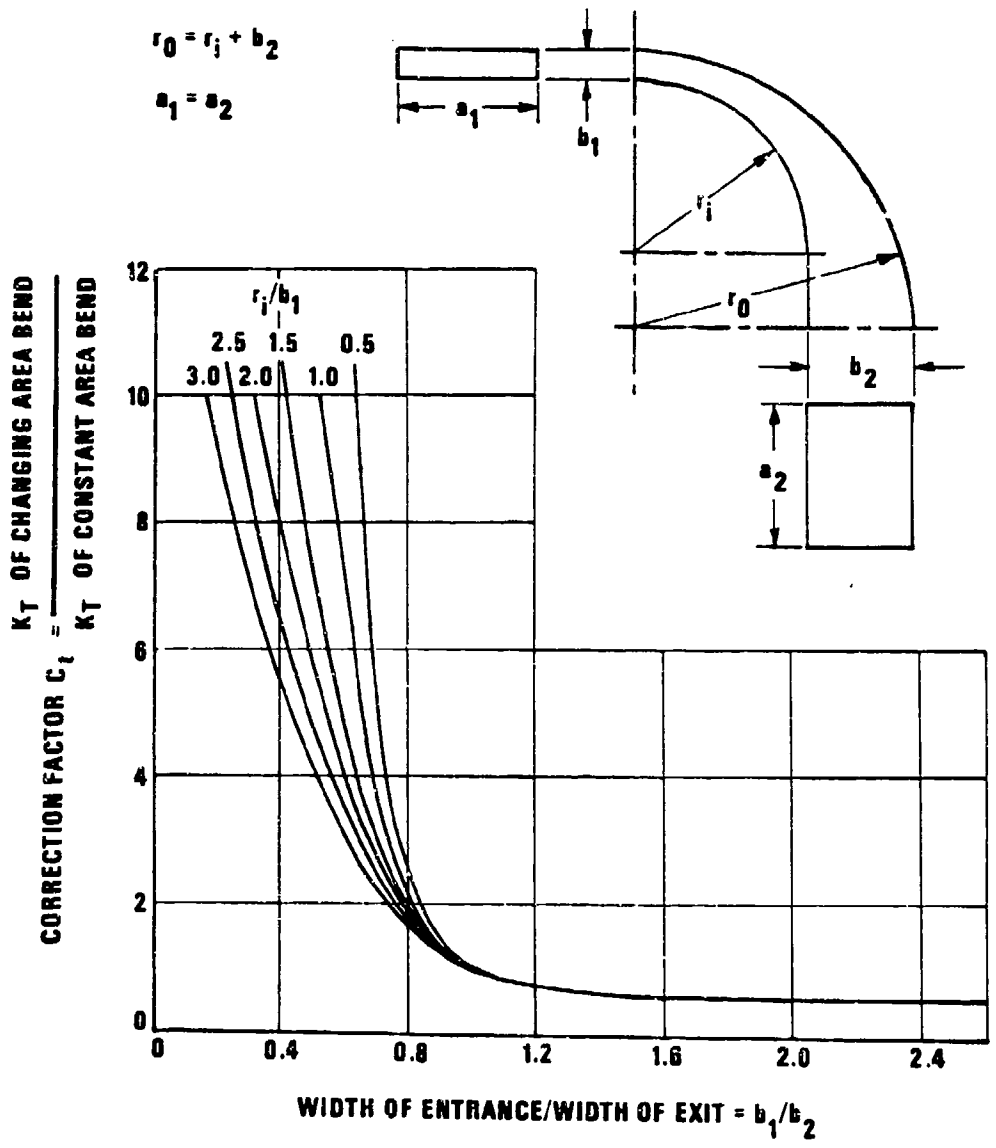

NOTE: RADIUS RATIO OF CONSTANT AREA BEND = $r_i/b_i + 1/2$

Figure 7-9. Correction Factors for Transitional Elbows (Ref. 3) (Release Granted by Society of Automotive Engineers, Inc., Aerospace Applied Thermodynamics Manual.)

AMCP 706-361

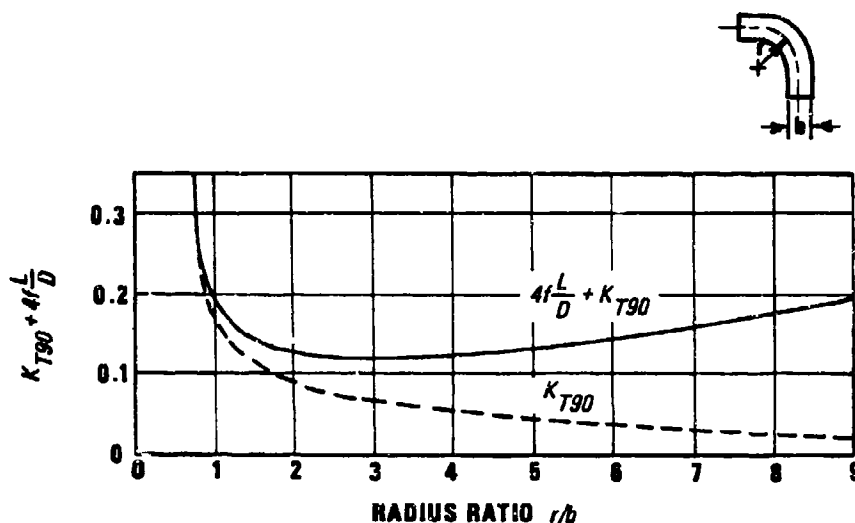

Figure 7-10. Fluid Pressure Loss vs Radius Ratio for Circular Ducts (Ref. 3) (Release Granted by Society of Automotive Engineers, Inc., Aerospace Applied Thermodynamics Manual.)

the complexity of the assembly.

7-2.2.5 Air Pressure Drop Through a Heat Transfer Matrix

Air pressure drop through a heat transfer matrix generally is due to skin friction, form drag, and variation of flow cross-sectional area and/or direction. Pressure drop data of this kind often are correlated as a friction factor and Reynolds number relationship as for a straight duct. These data may be obtained from Refs. 5 and 6.

Air pressure drop through a heat exchanger usually is expressed directly in inches of water and is plotted as a function of air velocity and heat exchanger configuration. This is discussed in detail in par. 3-5.2, and Appendix A presents typical manufacturer data illustrating the air pressure drop as a function of airflow for various heat exchanger core configurations.

When a heat exchanger or similar resistance unit is installed at an angle to the centerline

of the entrance duct, as shown in Fig. 7-12, an increase in airside loss coefficient occurs as indicated. The pressure drop ΔP through a heat exchanger therefore is increased by the factor K_T/K_{T0} obtained from Fig. 7-12.

7-2.2.6 Grille Friction Losses

Air pressure losses in grilles are caused directly by skin friction and dynamic pressure losses. Characteristics of air flowing through grilles—such as face velocity, pressure loss, and area for a particular flow capacity—are used to predict grille performance when installed in equipment. Intake and exhaust grilles also have individually specialized design criteria when operating in the vehicle. This subject is covered in par. 6-3.

7-2.2.6.1 Intake Grille

Location of the intake grille for supply air to the engine and cooling system should be compatible with the operational characteristics and speed of the vehicle. Military characteristics of swimming, fording, ingress,

TABLE 7-1

LOSS COEFFICIENT FOR AREA CHANGES (Ref. 2) (FOR USE IN EQ. 7-8)

TYPE	ILLUSTRATION	CONDITIONS		LOSS COEFFICIENT		TYPE	ILLUSTRATION	CONDITIONS		LOSS COEFFICIENT
		A_1/A_2	K_1	K_2	A_2/A_1			K_2		
ABRUPT EXPANSION		0.1	0.81	0.1	ABRUPT CONTRACTION		0.0	0.34		
		0.2	0.64	0.16			0.2	0.32		
		0.3	0.49	0.5			0.4	0.25		
		0.4	0.36	2.25			0.6	0.16		
		0.5	0.25	1.00			0.8	0.06		
		0.6	0.16	0.45			GRADUAL CONTRACTION		0	K_2
		0.7	0.09	0.18					30°	0.02
		0.8	0.04	0.08					45°	0.04
		0.9	0.01	0.01					60°	0.07
GRADUAL EXPANSION		0		K_2	EQUAL AREA TRANSFORMATION		$A_1 = A_2$	K		
		5°		0.17			$0 \leq \theta \leq 14^\circ$	0.15		
		7°		0.22	FLANGED ENTRANCE		$A = \infty$	K		
		10°		0.28				0.34		
		20°		0.45						
		30°		0.59						
40°		0.73	DUCT ENTRANCE		$A = \infty$	K				
						0.85				
ABRUPT EXIT		$A_1/A_2 = 0$		1.00	FORMED ENTRANCE		$A = \infty$	K		
SQUARE EDGE ORIFICE EXIT		A_0/A_1		K_0				SQUARE EDGE ORIFICE ENTRANCE		A_0/A_2
		0.0		2.50	0.0	2.50				
		0.2		2.44	0.2	1.90				
		0.4		2.26	0.4	1.39				
		0.6		1.98	0.6	0.98				
		0.8		1.54	0.8	0.61				
1.0		1.00	1.0	0.34						
BAR ACROSS DUCT		E/D		K	SQUARE EDGE ORIFICE IN DUCT		A_0/A	K		
		0.10		0.7					0.0	2.50
		0.25		1.4					0.2	1.80
PIPE ACROSS DUCT		E/D		K	SQUARE EDGE ORIFICE IN DUCT		A_0/A	K		
		0.10		0.20					0.4	1.21
		0.25		0.56					0.6	0.84
STREAM-LINED STRUT ACROSS DUCT		E/D		K	SQUARE EDGE ORIFICE IN DUCT		A_0/A	K		
		0.10		0.07					0.8	0.20
		0.25		0.23					1.0	0.00
		0.50		0.90						

NOTE: Subscript on K indicates cross section at which velocity is calculated.

(Reprinted by permission from ASHRAE Handbook of Fundamentals 1972)

AMCP 700-381

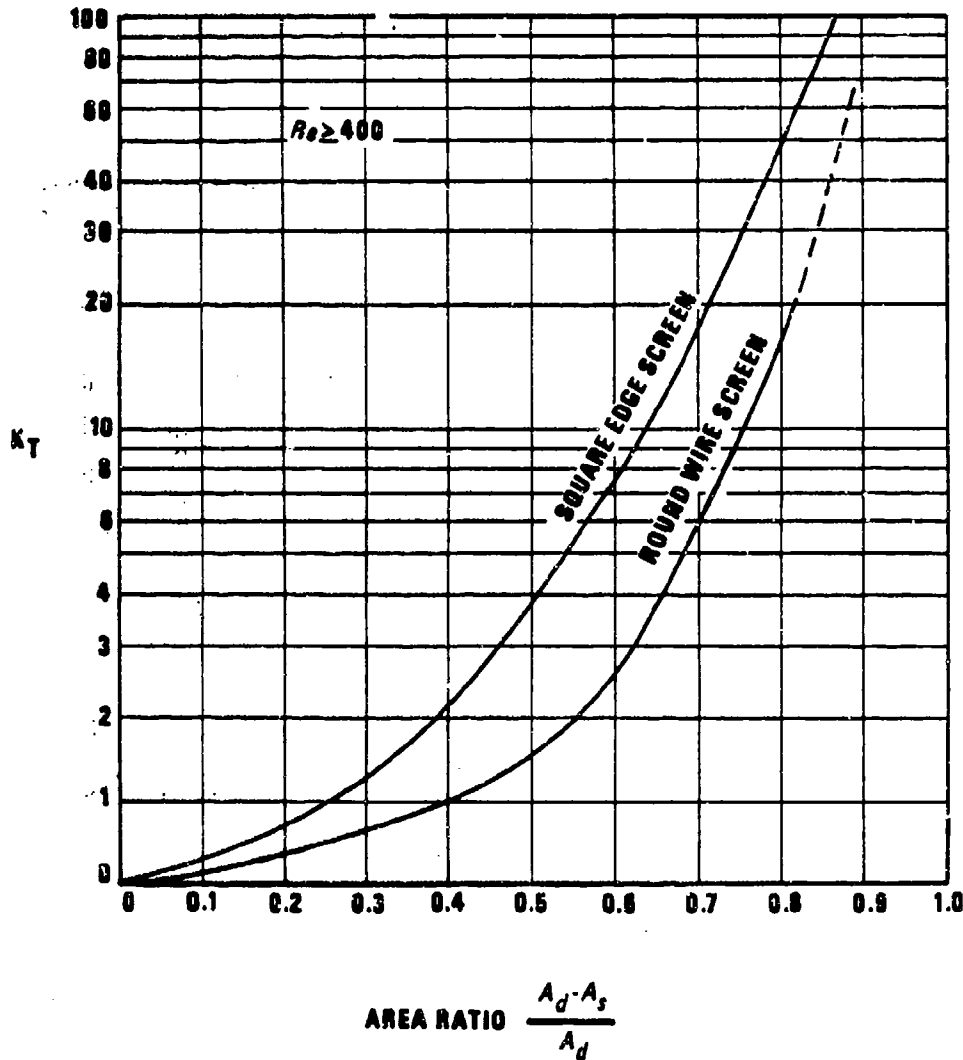
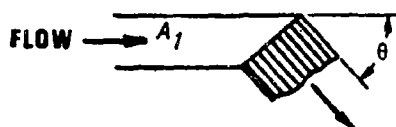

Figure 7-11. Loss Coefficient for Screens and Grids (Ref. 3) (Release Granted by Society of Automotive Engineers, Inc., Aerospace Applied Thermodynamics Manual.)

and egress must be accomplished without affecting the supply of air to the intake grille. Baffles, flotation equipment, and modification kits for operation in cold and hot climates also must be accommodated without affecting the supply of air. An equal distribution of supply air should be provided for by limiting the obstructions in the grille approach area.

Pressure loss or resistance to flow is established by the grille profile and arrangement, the area of the grille, and the face velocity for a particular capacity of intake air. An intake grille designed for a high ballistic protection level will require a large mass of material to interrupt, deflect, or stop a projectile. The decreased flow area results in an increase of air friction and corresponding



K_T = Loss Coefficient of heat exchanger plus turning angle at approach angle θ
 K_{T0} = Loss coefficient of the resistance unit at zero angle of approach

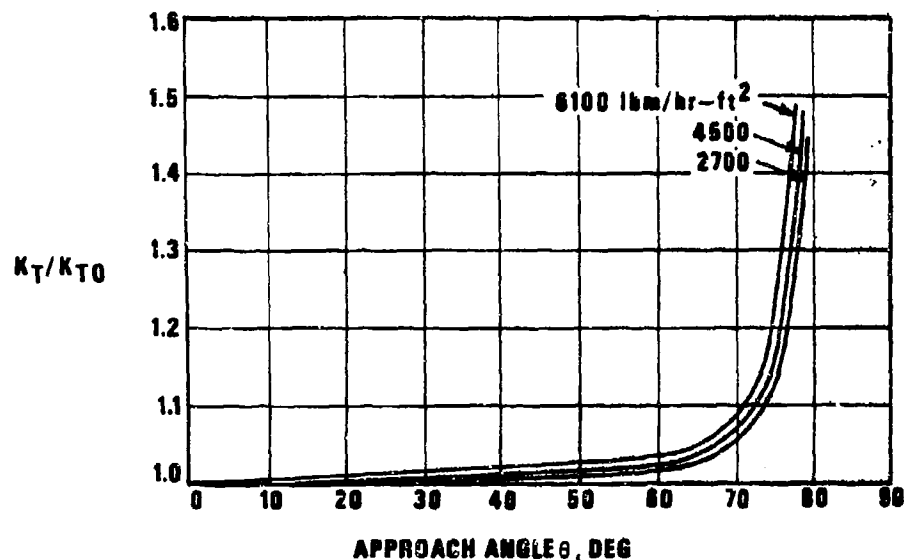

Figure 7-12. Effect of Angle on Heat Exchangers (Ref. 3) (Release granted by Society of Automotive Engineers, Inc., Aerospace Applied Thermodynamics Manual.)

dissipation of energy and pressure loss.

7-2.2.6.2 Exhaust Grille

The exhaust grille should provide minimum resistance to flow. Location of the grille as it affects the dynamic velocity of the moving vehicle should be considered. An exhaust grille at the front of the vehicle may require a higher exhaust velocity to compensate for the impact velocity of the moving vehicle in order to prevent recirculation problems as discussed in par. 6-7. This applies only to high speed vehicles since the impact velocity is negligible below speeds of 40 mph. An exhaust grille pressure loss is determined by the same

parameters that control the intake air pressure loss (see par. 6-3).

7-2.3 FLUID PRESSURE LOSS MINIMIZATION TECHNIQUES

7-2.3.1 Grille Area

Ample grille area will produce minimum velocity of the airflow through the grille. Low velocities will produce a corresponding low pressure loss or resistance to airflow with attendant minimum fan power requirements.

The vehicle intake grille area is selected to minimize the airflow restriction to the fan.

AMCP 706-361

Commonly used design values for grille maximum airflow pressure drops are 1 to 1.5 in. of water for the inlet and 2 to 2.5 in. of water for the exhaust. High fan inlet restrictions may cause flow separation (eddies), shock losses, and increased noise levels.

Installation of the radiator or heat exchanger close to the intake grille minimizes heating of the incoming air caused by contact with other components and may simplify installation of air recirculation seals.

7-2.3.2 Provisions for Uniform or Gradually Changing Grille Areas

Grilles are developed to provide optimized ballistic protection and airflow characteristics at minimum weight. Materials are selected that may be manufactured easily, are low in cost, and are compatible with other parts of the vehicle. Configurations of uniform cross section or gradually changing areas are preferred if ballistic protection requirements can be met.

Characteristics of various types of ballistic grilles are included in Appendix C.

7-2.3.3 Duct Design

Military vehicle cooling system duct designs usually are constrained by space and configuration limitations. As a result, the design normally deviates from preferred design characteristics at the expense of greater airflow pressure losses. Careful consideration of losses caused by turns, abrupt area changes, obstructions, skin friction, and the evaluation of factors affecting loss coefficients—such as the aspect ratio (duct height/duct width)—should enable the designer to select the best compromises for a satisfactory duct configuration that will incur minimum flow losses.

7-2.3.3.1 Duct Shape

Square or circular ducts are recommended

whenever possible. As the duct aspect ratio increases above 1, higher pressure drops are generated and should be avoided; however, losses do not become excessive until the aspect ratio exceeds 4. Ducts that carry all the exhaust air, for example, have been used with aspect ratios as high as 6:1.

Fluid pressure drop through a rectangular duct, whether it is straight or not, is a function of the aspect ratio of the duct and the flow Reynolds number. For airflow systems encountered in vehicle power plants, the airflow pressure drop can be estimated by formula or charts for a circular duct when the equivalent diameter of the duct is used as the parameter. This is due to the fact that pressure drop in the turbulent flow region is not seriously affected with ratios up to 10. For more detailed analysis of airflow friction through ducts with Reynolds numbers below 10,000, see Ref. 1.

7-2.3.3.2 Flow Pressure Losses

The loss coefficients for cross-sectional area changes in ducts increase in relation to the magnitude of the area change as shown in Table 7-1. Flow pressure losses should be minimized by using gradually changing duct areas and minimizing the number of obstructions in the duct or streamlining the obstructions.

The number of turns should be kept to a minimum, and sharp turns should be avoided, if possible.

7-2.3.4 Reduction of Pressure Loss in Turns

Turning vanes or splitters may be used in sharp bends to improve exit velocity distribution and reduce pressure loss. A turning vane is defined as a curved section used to direct the airflow (see Fig. 7-13). A splitter is a thin vane, usually made of sheet metal and installed the same as the splitter shown in Fig. 7-13.

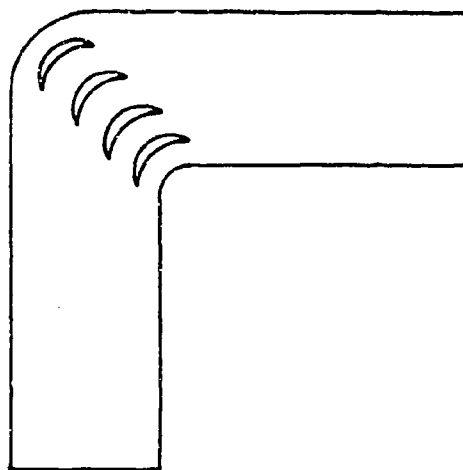

Figure 7-13. Typical Turning Vanes in a 90-deg Bend

Various vane designs and design information are available from publications listed in the Bibliography at the end of this chapter and Refs. 1 and 3.

7-2.3.5 Cooling Airflow Test of the M551 SHERIDAN Vehicle (Ref. 7)

An evaluation of the cooling fan performance and airflow through the vehicle power plant cooling system, at the rated fan speed of 4280 rpm, was greater than the specified 14,000 cfm even with all grilles and debris screens installed.

At the same fan speed, with the intake grille removed, the airflow rate increased 7 percent. Removal of the exhaust grilles resulted in an airflow increase of 3.5 percent.

7-2.4 SYSTEM TOTAL AIR RESISTANCE EXAMPLE, XM803 EXPERIMENTAL TANK

The cooling system heat rejection establishes the airflow requirement, and the required airflow characteristics establish the pressure head that the fan must develop. The

basic cooling system requirement is that the airflow rate must be sufficient to keep the operating temperatures of the power package components below maximum values.

The selection of an adequate cooling fan requires first that the airflow requirements be determined, and then it is necessary to determine the pressure head needed to force this quantity of air through the cooling system.

Once the total cooling system heat rejection and airflow rates are determined, the temperature rise of the cooling air through the system can be calculated.

Fig. 7-14 indicates the airflows through various components in the XM803 Experimental Tank cooling system. These include the inlet grilles, power package compartment, engine compartment, transmission compartment, heat exchangers, ducts, and exit grille.

In the cooling system airflow path both flow direction and flow areas vary. The total air pressure loss of system resistance is the summation of the various types of air resistances generated by the cooling system components. The total air resistance of the entire system ΔP_{system} can be expressed by

$$\Delta P_{system} = \Sigma \left[K_T \left(\frac{V_m}{4005} \right)^2 \right] + \Sigma \left[f \left(\frac{L}{D} \right) \left(\frac{V_m}{4005} \right)^2 \right], \text{ in. water} \quad (7-12)$$

The dynamic or velocity pressure loss is determined at the reference area of the resistance coefficient K_T and/or the friction factor f , as discussed in previous paragraphs of this chapter.

7-2.4.1 System Resistance Characteristics

For complete turbulent flow, which is

AMCP 706-361

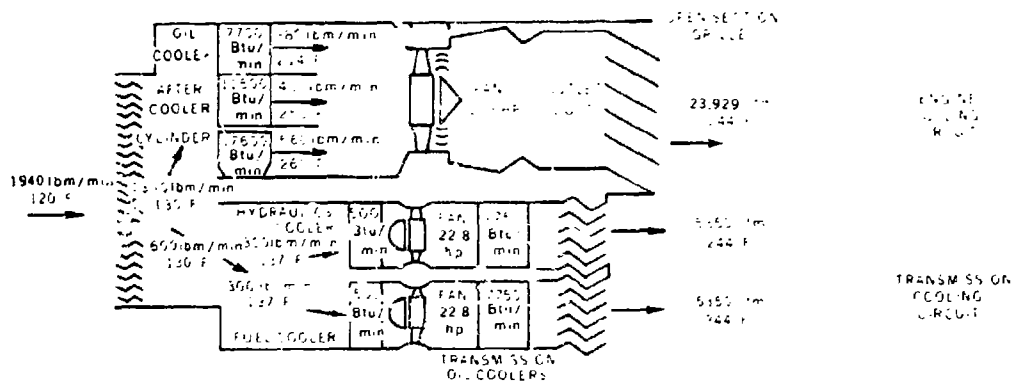

Figure 7-14. XM803 Experimental Tank Cooling System Analysis Diagram (Ref. 8)

generally the case in vehicle cooling systems under normal operating conditions, Eq. 7-12 also can be empirically written as

$$\Delta P_{\text{system}} = Y(CFM)^2 \text{ in. water} \quad (7-13)$$

where

Y = constant depending on the entire system pressure drop characteristics, in. water/(ft³, min)²

The graphical relationship of ΔP vs CFM is called the system characteristic or system resistance curve. The constant Y , and thus the entire characteristic curve, is defined when the static pressure drop resulting from any given flow rate is known. Fig. 8-34 shows the total system resistance curve for the XM803 Experimental Tank system (also see par. 8-10).

The schematic diagram in Fig. 7-14 may be used to analyze the system pressure losses. As shown in this figure, the cooling system is divided into three sections to permit analysis of the pressure loss in each of the following areas:

1. Inlet grille
2. Power package compartment

3. Engine
4. Engine fan
5. Outlet duct
6. Exit grille.

The static pressure curve can be drawn after analysis of the airflow characteristics that follow.

7-2.4.2 Example of Determination of the Air Resistance for the XM803 Experimental Tank Engine Cooling Airflow System:

The example presented is intended to illustrate a means of obtaining an approximate estimate of the system air resistance of a combat vehicle cooling system and establish baseline cooling fan requirements. This example is greatly over-simplified because airflow characteristics in this or any other cooling system are extremely complex and cannot be predicted with a high degree of accuracy. In actual operation the airflow is not divided evenly between the two fans; the velocities are not uniform in the duct; the fan exit velocities are considerably higher than the duct velocities; and air leakage, bypass, and recirculation are not considered. This

example is solved based on determining the air velocity for the temperature at each station and then correcting the ΔP for air density. (See par. 7-2.4.2.7)

7-2.4.2.1 Intake Grille

A diagram of the inlet and exhaust grille configurations is shown in Fig. 7-15. The grille airflow resistance characteristics are presented in Fig. 6-12.

The intake grille airflow is made up of the sum of the engine cooling air, engine induction air, and transmission cooling air. These requirements are provided by the respective manufacturers and are established as 1340 lbm/min engine cooling air, 600 lbm/min transmission cooling air, and 200 lbm/min engine induction air (see par. 8-5.2.2 for the procedure used to determine the transmission airflow requirements). Airflow through the intake grille is at 120°F air temperature and requires a correction for air density from Eq. 7-5 where

$$\rho = 0.075 \times \frac{530}{460 + 120} = 0.0685 \text{ lbm/ft}^3$$

$$CFM = \frac{1340 + 600 + 200}{0.0685} = 31,241$$

With an inlet grille area of (Ref. Fig. 7-15) 15.1 ft² and an airflow rate of 31,241 cfm, the grille face velocity = 31,241/15.1 = 2069 ft/min. From Fig. 6-12, the inlet grille restriction is 2.0 in. of water for normal flow. Note that the air velocity at operating conditions is used for determination of the air pressure drop data from Fig. 6-12. This pressure drop data is corrected to the reference air density of Fig. 6-12 in the table in par. 7-2.4.2.7.

7-2.4.2.2 Power Package Compartment

As shown in Figs. 7-15 and 7-16, the engine

compartment air is supplied through two identical inlet grilles to the engine that is symmetrical and has two cooling fans. This arrangement permits the analysis of one-half of the system, assuming that the same conditions apply to the remaining side because of the symmetry. A photograph of the configuration shown in Fig. 7-16 also is shown in Figs. 9-3 and 9-5.

The configuration formed by the engine oil coolers and fuel tank is similar to a sudden contraction in a duct, and the pressure drop for the power package compartment may be analyzed as such. The engine airflow is in parallel paths through the oil coolers, aftercoolers, and cylinders. Fig. 7-14 shows that the air flowing to the engine from the grilles at this point is 1340 lbm/min at 130°F, therefore the volume entering one bank of the engine from Eq. 7-5, where $\rho_a = 0.075 \times 530/(460 + 130) = 0.067 \text{ lbm/ft}^3$, is

$$CFM = \frac{1340}{0.067 \times 2} = 10,000 \text{ cfm}$$

The inlet area A_1 = area of one grille = 15.1/2 = 7.55 ft² (Fig. 7-15), and area A_2 between cooler and the top of the fuel tank = 6 × 62/144 = 2.58 ft² (Fig. 7-16).

The coefficient K_2 for sudden contraction for $A_2/A_1 = 2.58/7.55 = 0.34$ is found by interpolation as 0.26 from Table 7-1. The velocity V_m at A_2 is 10,000/2.58 = 3876 ft/min. From Eq. 7-8

$$\Delta P = 0.26 \left(\frac{3876}{4005} \right)^2 = 0.24 \text{ in. water (See Note)}$$

NOTE: This pressure drop data is calculated by using air velocity at operating conditions and Eq. 7-3. Since Eq. 7-3 is valid for standard air density, the pressure drop value will be corrected to the air density at operating conditions as shown in the table in par. 7-2.4.2.7.

AMCP 706-361

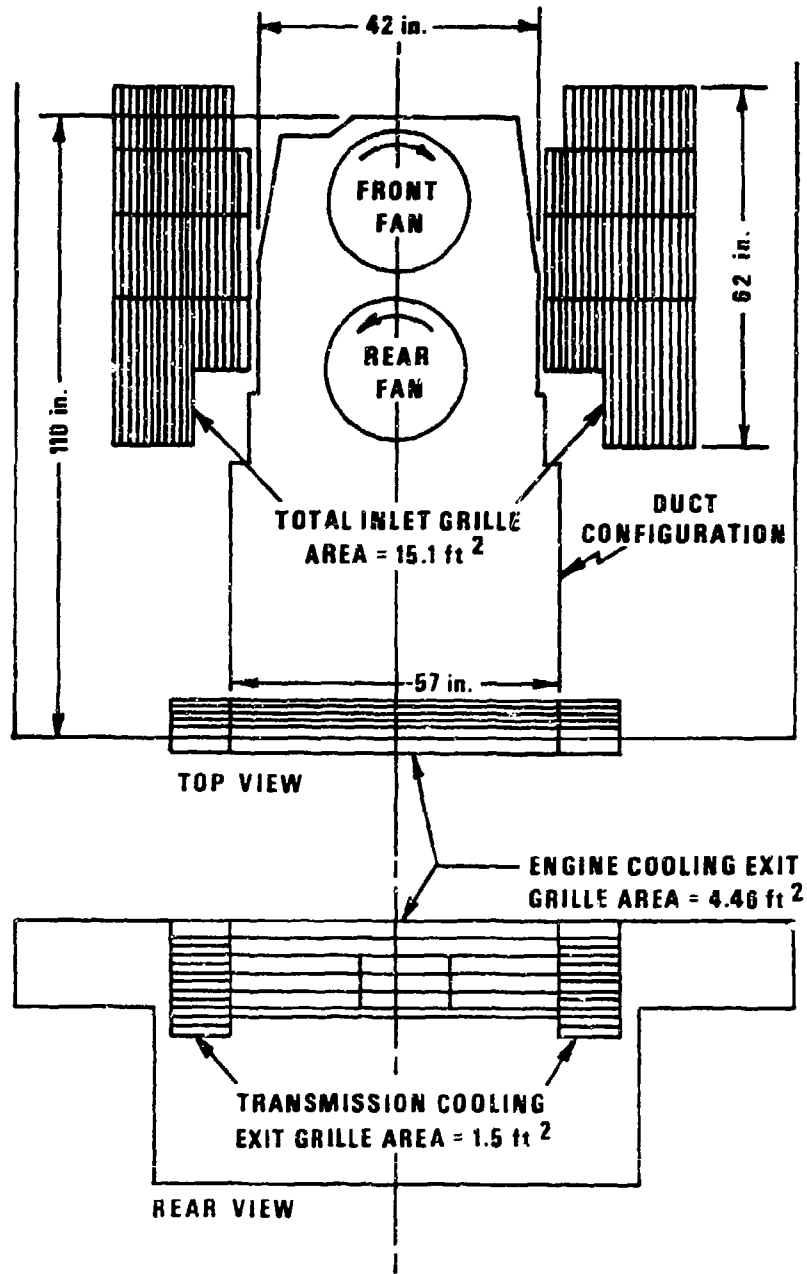

Figure 7-15. XM803 Experimental Tank Inlet and Exhaust Grille Configuration (Ref. 8)

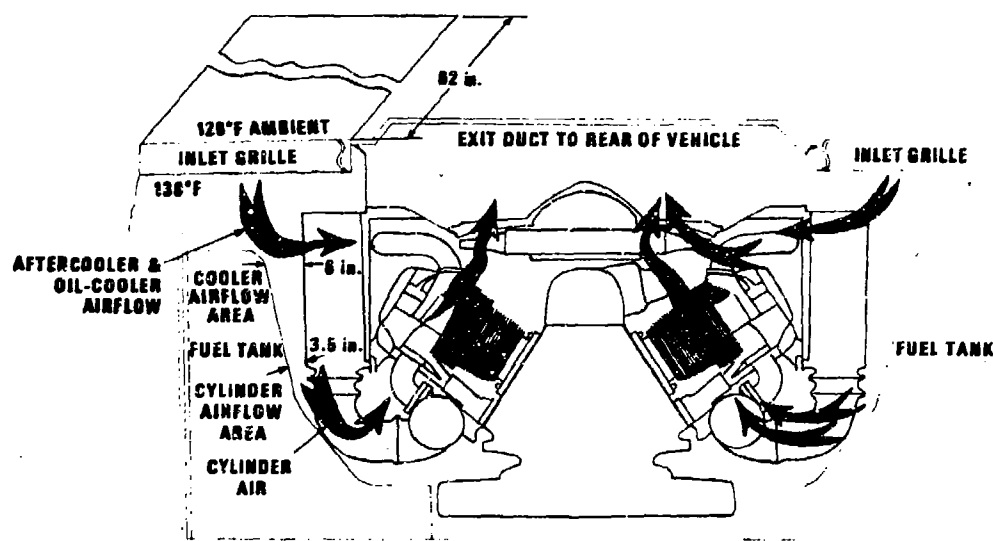

Figure 7-16. XM803 Experimental Tank Power Package Airflow Diagram

7-2.4.2.3 Engine

Airflow rates and air pressure drops through the individual oil cooler, aftercooler, and cylinders were determined by the engine manufacturer from dynamometer tests. This total engine ΔP equals 7.0 in. water static pressure drop at the 120°F ambient temperature condition.

7-2.4.2.4 Fan

Final cooling fan selection must be made after the system resistance characteristic is determined. The air pressure losses ahead of the fan normally are plotted as negative values and the pressure losses after the fan are plotted as positive values. The sum of the absolute values represents the total system resistance to which the fan must be matched. Refer to pars. 4-12.2 and 8-5.2.1.4 for fan system matching techniques.

7-2.4.2.5 Outlet Duct

The outlet duct may be analyzed as the configuration shown in Fig. 7-17. The

cross-sectional area is computed at duct sections 0 through 9 and plotted as the duct area profile graph as shown. The total air resistance through the duct is the sum of the friction losses and various dynamic shock losses. The duct cross-sectional areas shown in Fig. 7-17 are the average areas at the respective stations (see Ref. 8). The duct is not truly a rectangular shape (see Fig. 7-16) and the bottom of the duct is formed by the engine and transmission. For an approximate estimation of the air pressure drop, assumptions were made that the cross sections analyzed are true rectangular shapes and the areas are shown in Fig. 7-17. For example, the fan turning losses calculated in this paragraph assume that the fan airflows are discharged into a true rectangular duct with the bottom of the duct located at the top of the cooling fan air outlet housings. This assumption gives calculated cross-sectional areas that are less than the actual cross-sectional areas because the fan outlet housings are raised above the engine top sheet metal cover (see Fig. 2-13). The air pressure drop information obtained from these assumptions is believed to be on the conservative side.

AMCP 706-361

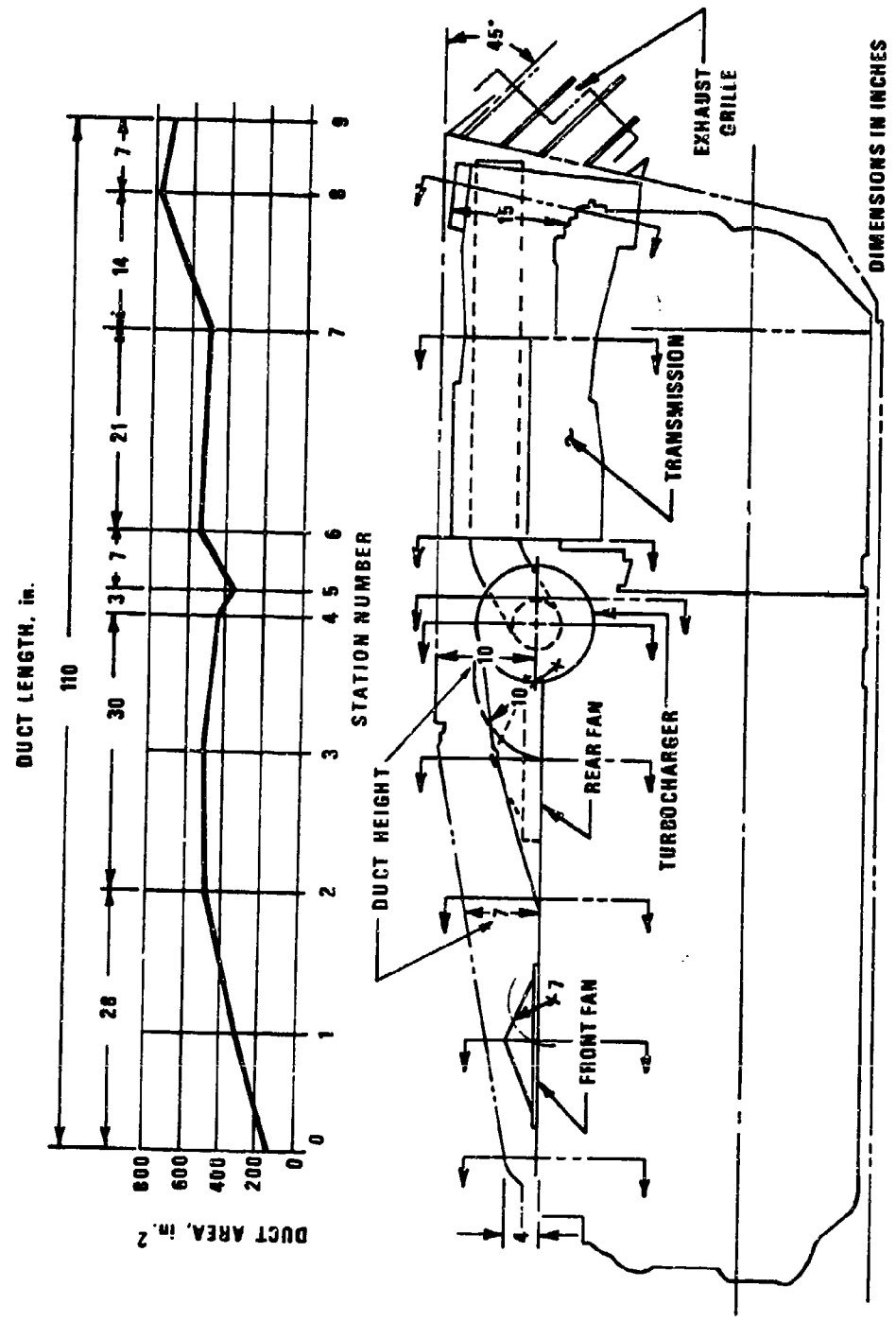

Figure 7-17. XM803 Experimental Tank Engine Cooling System Duct Area Profile (Ref. 8)

The following procedure was followed in this example to determine the duct losses:

1. Determine duct friction losses.
2. Determine fan turning losses for each cooling fan.
3. Determine flow losses at duct stations with significant changes in area. (Stations 5 to 6, 7 to 8, and 8 to 9).

Duct loss calculations are performed as follows:

1. Friction losses

The duct friction losses may be estimated by the following method:

a. Compute average air velocity in duct.

The approximate average duct section carrying the combined airflow of both fans is 10 in. high X 57 in. wide = 570 in.² (Figs. 7-15 and 7-17, Section 6). The average velocity V_m (at 244°F from Fig. 7-14) at this section is

$$V_m = \frac{\text{airflow}}{\text{duct area}}, \text{ ft/min} \quad (7-14)$$

where

$$\rho = 0.075 \times \frac{460 + 70}{460 + 244} = 0.056 \text{ lbm/ft}^3$$

where

$$CFM = \frac{1340}{0.056} = 23,929 \text{ cfm}$$

with the duct area = 570 in.²

$$V_m = \frac{23,929}{\left(\frac{570}{144}\right)} = 6045 \text{ ft/min}$$

b. Compute approximate equivalent di-

ameter of duct. The equivalent diameter of the duct from Eq. 7-6 is

$$D_e = 4 \left(\frac{\text{flow cross-sectional area}}{\text{wetted perimeter}} \right), \text{ ft}$$

From Fig. 7-15 the duct width = 57 in.

From Fig. 7-17 the duct height = 10 in.

then

$$D_e = 4 \left[\frac{\left(\frac{570}{144}\right)}{2 \left(\frac{57 + 10}{12}\right)} \right] = 1.42 \text{ ft}$$

c. Compute Reynolds Number. From Eq. 7-7,

where

$$D_e = 1.42 \text{ ft}$$

$$V_h = (6045 \times 60) = 362,700 \text{ ft/hr}$$

$$\rho = 0.056 \text{ lbm/ft}^3$$

$$\mu = 0.055 \text{ lbm/hr-ft (from Fig. 3-42)}$$

then

$$Re = \frac{1.42 (362,700) 0.056}{0.055} = 524,398$$

d. Estimate duct ϵ/D . The engine, transmission, and related power package components serve as the bottom of the duct. Assume a value of $\epsilon = 0.5$ in. for bolt heads and similar power package component projections, then the ϵ/D ratio would become

$$\frac{\left(\frac{0.5}{12}\right)}{1.42} = 0.029$$

e. Determine f . From Fig. 7-2, with Re

AMCP 706-381

= 524,398 and $\epsilon/D = 0.029$ then $f = 0.057$

f. From Eq. 7-3 for standard air

where

$$L = \frac{110}{12} = 9.17, \text{ ft (from Fig. 7-17)}$$

then

$$\Delta P = 0.057 \left(\frac{9.17}{1.42} \right) \left(\frac{6045}{4005} \right)^2$$

$$= 0.84 \text{ in. water}$$

(see note in par. 7-2.4.2.2)

2. 90-deg turns from fan outlets to duct.

a. *Front fan* (90-deg turn). From Fig. 7-6, it can be seen that the turn loss coefficient is dependent on the aspect ratio (duct width a /duct height b) and the radius/duct height ratio (r/b). From Figs. 7-15 and 7-17, $a/b = 42/7 = 6$ and $r/b = 7/7 = 1$. The Reynolds number Re is determined from Eq. 7-7 where

$$D_e = 1.0 \text{ ft (from Fig. 7-5 with } a = 42 \text{ in. and } b = 7 \text{ in.)}$$

$$V_m = \text{the airflow of one fan (CFM) of } 23,929/2 = 11,965 \text{ cfm divided by the duct area of } 500 \text{ in.}^2 \text{ (Fig. 7-17, section 2) = } \frac{11,965}{\left(\frac{500}{144} \right)} = 3446 \text{ ft/min}$$

$$\text{or } 3446 \times 60 = 206,760 \text{ ft/hr}$$

$$\rho = 0.056 \text{ lbm/ft}^3 \text{ at } 244^\circ\text{F}$$

$$\mu = 0.055 \text{ lbm/hr-ft (from Fig. 3-42)}$$

$$Re = \frac{1.0 (206,760) 0.056}{0.055} = 210,519$$

From Fig. 7-6(B) ($a/b = 6$ and $r/b = 1$) then $K_{T90} = 0.27$

Then from Eq. 7-8

$$\Delta P = 0.27 \left(\frac{3446}{4005} \right)^2 = 0.20 \text{ in. water (see note in par. 7-2.4.2.2)}$$

b. *Rear fan section* (90-deg turn). The rear fan is analyzed in the same manner as the front fan. From Figs. 7-15 and 7-17 the aspect ratio $a/b = 57/10 = 5.7$ and the radius/duct height ratio $r/d = 10/10 = 1$. The Reynolds number Re is determined from Eq. 7-7 where

$$D_e = 1.42 \text{ ft (see step 1 (b))}$$

$$V_m = \frac{11,965}{\left(\frac{430}{144} \right)} = 4007 \text{ ft/min or } 4007 \times 60 = 240,420 \text{ ft/hr}$$

$$\rho = 0.056 \text{ lbm/ft}^3 \text{ at } 244^\circ\text{F}$$

$$\mu = 0.055 \text{ lbm/hr-ft (from Fig. 3-42)}$$

$$Re = \frac{1.42 (240,420) 0.056}{0.055} = 347,603$$

From Fig. 7-6(B) then $K_{T90} = 0.265$

Then from Eq. 7-8

$$\Delta P = 0.265 \left(\frac{4007}{4005} \right)^2 = 0.27 \text{ in. water (see note in par. 7-2.4.2.2)}$$

3. The determination of flow losses between sections 5 and 6 (Fig. 7-17) can be made by analyzing this section as an abrupt expansion because the duct area changes from 375 in.² at section 5 to 525 in.² at section 6 within a 7-in. length of duct.

From Table 7-1, the loss coefficient for abrupt expansion is a function of the ratio of upstream flow area to downstream flow area

A_1/A_2 . From Fig. 7-17, $A_1/A_2 = 375/525 = 0.71$.

Interpolating for a value of $A_1/A_2 = 0.71$ Table 7-1 provides a value of $K_1 = 0.09$. The velocity V_m at section 5 = total airflow/upstream area. Then $V_m = 23,929/[(375/144)] = 9189$ ft/min.

$$\text{From Eq. 7-8, } \Delta P = 0.09 \left(\frac{9189}{4005} \right)^2 = 0.47$$

in. water (see note in par. 7-2.4.2.2)

4. The duct area between sections 7 and 8 (Fig. 7-17) may be analyzed as abrupt expansion because the area increases from 500 in.² at section 7 to 775 in.² at section 8. From Fig. 7-17, the ratio of upstream area to the downstream area $A_1/A_2 = 500/775 = 0.65$. From Table 7-1 with $A_1/A_2 = 0.65$, K_1 can be found by interpolation as 0.135. The velocity V_m at section 7 (Fig. 7-17) = $23,929/[(500/144)] = 6,892$ ft/min.

$$\begin{aligned} \text{From Eq. 7-8, } \Delta P &= 0.135 \left(\frac{6892}{4005} \right)^2 \\ &= 0.40 \text{ in. water. (see} \\ &\quad \text{note in par. 7-2.4.2.2)} \end{aligned}$$

5. The duct area between sections 8 and 9 may be analyzed as an abrupt contraction because the area decreases from 775 in.² at section 8 to 700 in.² at section 9 (Fig. 7-17) in a 7-in. length of duct.

From Fig. 7-17, $A_2/A_1 = 700/775 = 0.90$, K_2 can be found by extrapolation as 0.040 from Table 7-1.

The velocity V_m at section 9 = $23,929/[(700/144)] = 4923$ ft/min

From Eq. 7-8, $\Delta P = 0.040 (4923/4005)^2 = 0.060$ in. water (see note in par. 7-2.4.2.2)

7-2.4.2.6 Exhaust Grille

The exhaust grille is analyzed as a 45-deg

bend without a following exhaust duct. The engine exhaust is discharged immediately behind the grille through two 5-in. diameter pipes (see Fig. 2-47). The total exhaust grille face area from Fig. 7-15 is 4.46 ft² and the effective or open grille area is 4.0 ft². This value is the total grille area minus the cross-sectional area A of the three turning plates where

$$\begin{aligned} A &= \frac{57 \text{ in. wide} \times 0.38 \text{ in. thick} \times 3 \text{ plates}}{144} \\ &= 0.46 \text{ ft}^2 \end{aligned}$$

The effective area minus the two exhaust pipe areas is

$$\left[4.0 - 2 \left(\frac{\pi}{4} \right) \left(\frac{5}{12} \right)^2 \right] = 3.73 \text{ ft}^2$$

The Reynolds number based on the minimum free flow area of the deflector plates of 3.73 ft² is determined using Eq. 7-7 where

$$D_e = \frac{4 (3.73)}{2 \left(\frac{57}{12} + \frac{15}{12} \right)} = \frac{14.92}{12.0} = 1.24 \text{ ft}$$

This calculation ignores the skin friction of the 3 plates.

$$\begin{aligned} V_m &= \frac{23,929}{3.73} = 6415 \text{ ft/min} \times 60 \\ &= 384,900 \text{ ft/hr} \end{aligned}$$

$$\rho = 0.056 \text{ lbm/ft}^3 \text{ at } 244^\circ\text{F}$$

$$\mu = 0.055 \text{ lbm/hr-ft (From Fig. 3-42)}$$

$$Re = \frac{1.24 (384,900) 0.056}{0.055} = 485,954$$

From Fig. 7-8(B) for a 45-deg bend, square duct, $C_d = 0.51$ (approximate). From Fig. 7-6(C) where $r/b = 1.0$ (assumed) and $a/b = 57/15 = 3.8$ (Figs. 7-15 and 7-17), $K_{TD} = 0.25$.

AMCP 788-381

Since there is no duct following the exhaust grille, the loss coefficient K_{T90} must be corrected for the effect of sudden expansion. From Fig. 7-7, with $a/b = 3.8$ and $r/b = 1.0$, then $C_p = 3.2$ and K_T without a duct from Eq. 7-9 $= 0.25 \times 3.2 \times 0.51 = 0.41$

$$\begin{aligned} \text{From Eq. 7-8, } \Delta P &= 0.41 \left(\frac{6415}{4005} \right)^2 \\ &= 1.05 \text{ in. water (see note} \\ &\quad \text{in par. 7-2.4.2.2)} \end{aligned}$$

7-2.4.2.7 Total System Resistance

Total resistance is found by the summation of the calculated individual resistances (ΔP column below) that must be corrected for the actual air density at the respective stations by Eq. 7-4. These corrected values are indicated as ΔP at operating conditions.

Station	ΔP Calcu- lated	ρ at Station	ΔP at Operating Conditions
1. Intake grille ¹	2.00	0.0685	1.68
2. Compartment ²	0.24	0.067	0.21
3. Engine ³	—	—	7.00
4. Duct ²			
a. friction	0.84	0.056	0.63
b. 90-deg turn (front fan)	0.20	0.	0.15
c. 90-deg turn (rear fan)	0.27	0.056	0.20
d. expansion	0.47	0.056	0.35
e. expansion	0.46	0.056	0.30
f. contraction	0.06	0.056	0.04
Duct Total			1.67

Station	ΔP Calcu- lated	ρ at Station	ΔP at Operating Conditions
5. Exhaust grille ²	1.05	0.056	0.78

System Total (Total Fan ΔP , in. water) 11.54

¹Column 2: ΔP is determined from Fig. 6-12 using air velocity at operating condition.

²Column 4: Actual ΔP after air density correction.

³Column 2: ΔP is calculated by Eq. 7-3 using air velocity at operating condition as V_m .

⁴Column 4: Actual ΔP after air density correction.

⁵Direct measurement at operating condition.

The pressure profile graph may be completed as shown in Fig. 7-18. The ΔP values on the suction side of the fan are plotted as negative and the ΔP values on the discharge side of the fan are plotted as positive. The total fan ΔP is the sum of the absolute values of these air pressure changes. See par. 8-5.2.1.4 for the engine cooling fan selection procedure. The pressure profile for the transmission cooling fan circuit shown in Fig. 7-18 is developed in Chapter 8.

The basic configuration of the components chosen for this example were tested in a simulated hot mock-up and the following values were obtained (Ref. 9):

1. Intake grille and compartment	2.0
2. Engine	6.5
3. Duct and exhaust grille	2.3
System Total	10.8
	in. water

Cooling system mock-up programs are important because of the many variables involved and the estimates made in the analysis. A correctly done mock-up program, which may be costly, when executed prior to

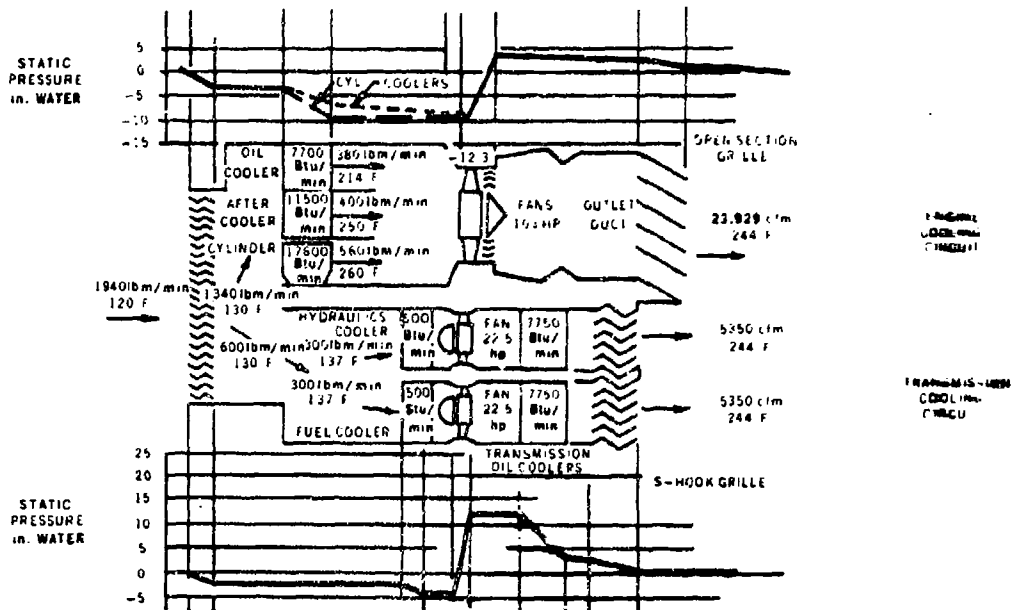

Figure 7-18. XM803 Experimental Tank Cooling System Diagram and Static Pressure Profile (Ref. 8)

desert testing can be the difference between a satisfactory or unsatisfactory cooling system.

7-3 SYSTEM LIQUID FLOW ANALYSIS

During vehicle power package operation, liquid flows absorb heat from various components. The liquid flows then dissipate the heat to the ambient air either directly or indirectly through heat exchangers. The liquids used in the vehicle power package are:

1. Water or antifreeze solution
2. Lubricating oil
3. Transmission oil
4. Hydraulic oil

5. Refrigerant (for air conditioning systems).

Various types of pumps are provided in the cooling system to generate the liquid flow.

7-3.1 ENGINE COOLANT PUMP

A centrifugal pump generally is used to move water or antifreeze/water solution through the liquid-cooled system. Figure 7-19 shows a typical engine coolant pump.

Engine coolant pump characteristics are shown in Fig. 7-20. Coolant pump capacity is related to the pump rotating speed. Figure 7-21 also illustrates the pump capacity and engine speed relationships for several typical pumps for different engine models. These pumps

AMCP 706-361

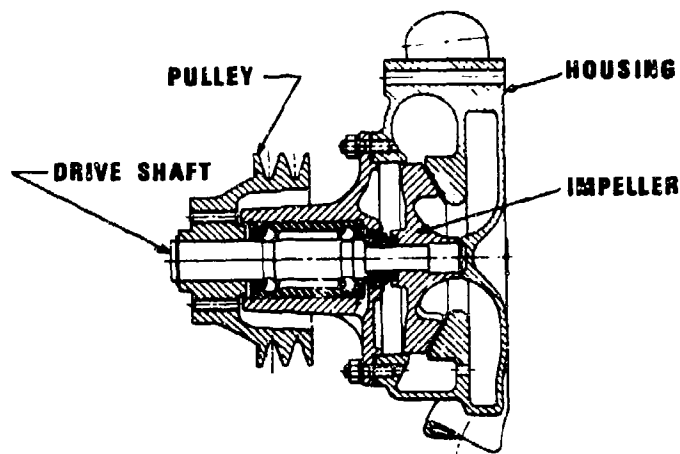

Figure 7-19. Typical Centrifugal Coolant Pump

normally are driven directly by the engine shaft. Different drive ratios may be selected as shown. Fig. 7-21 shows the pump flow and pressure head relationships for a typical pump using engine speed (or pump speed) as a parameter. Also included in Fig. 7-21 is the coolant flow resistance characteristic through the engine. It is obvious that the coolant pump performance must match the system coolant flow resistance characteristics under operating conditions.

The centrifugal coolant pump is highly sensitive to inlet restrictions. High restrictions will cause cavitation and then coolant flow to the engine will be reduced as shown in Fig. 7-22. Restriction to flow by bends or small diameter hoses is highly detrimental to the coolant flow capacity. Standard commercial engines have coolant inlet restrictions not exceeding 1.5 psi at approximately 180° to 190° F coolant temperature. In general practice the size of the inlet and outlet hoses to the engine may be calculated for a maximum coolant velocity of 10 to 12 ft/sec.

Actual coolant flow rate requirements are determined from the cooler selection and engine heat rejection as described in pars.

3-5.1.1.2.3 and 3-6.2.1.3.2.

Location of heat exchangers or radiators in close proximity to the coolant pump will minimize the resistance to the coolant flow. Installations of cooling components in remote areas will require coordination of the design with the equipment manufacturers to assure satisfactory performance.

7-3.2 OIL PUMPS

Positive displacement type rotary pumps and hydraulic motors are used for circulating engine oil, transmission oil, hydraulic oil, or refrigerant through the various systems.

Design criteria for positive displacement pumps are based on the flow rates and pressure head required. A pressure relief valve is provided in the circuit to limit the fluid pressure to prevent damage to the system or pump. Normally, the oil pump is sized to provide ample oil flow at low operating speeds so that surplus oil is bypassed by the relief valve at higher speeds. Oil circulation rates vary based on the design of the component.

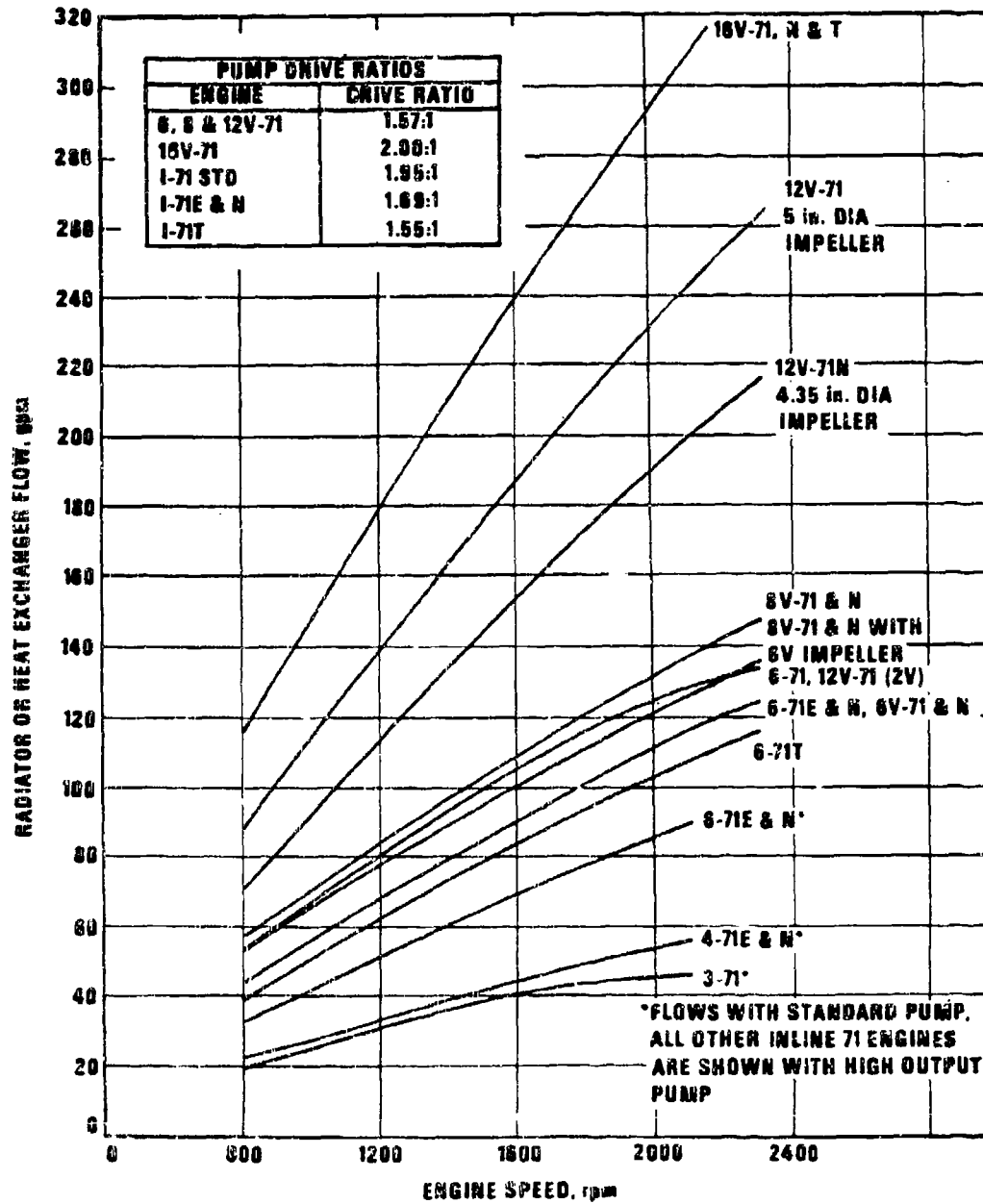

Figure 7-20. Engine Coolant Flow Through Radiator or Heat Exchanger With 180° F Blocking Type Thermostat

(Courtesy Detroit Diesel Allison Division, General Motors Corporation)

AMCP 708-361

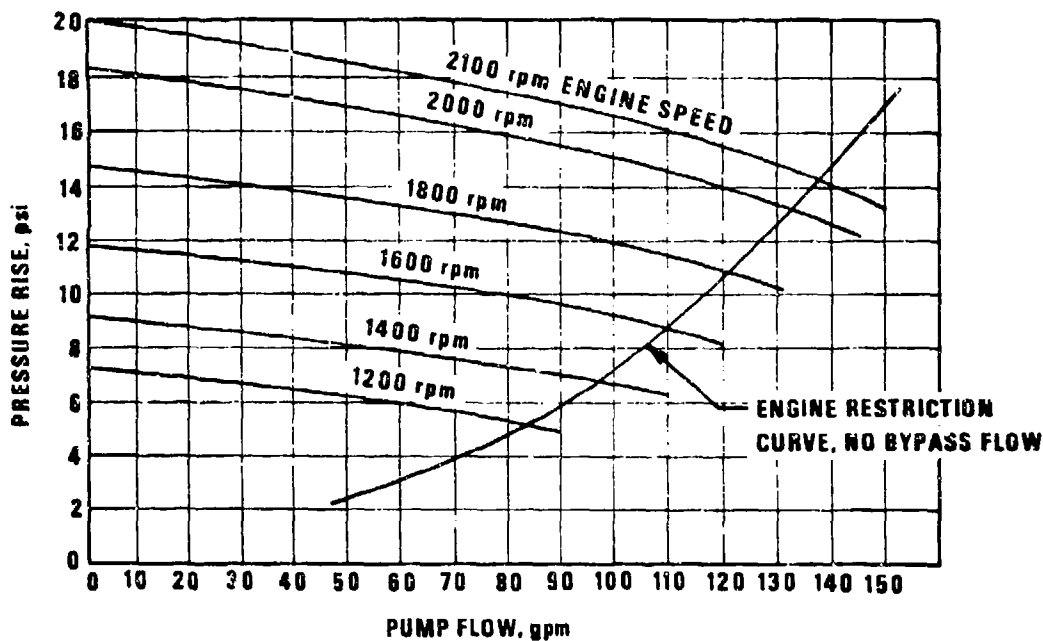

Figure 7-21. Typical Coolant Pump Capacity vs Engine Speed for Models 8V-71 and 71N
 (Courtesy of Detroit Diesel Allison Division, General Motors Corporation)

Oil pump design data may be found in Refs. 10 and 11. Typical oil flow rates vs speed for several different diesel engines are shown in Fig. 7-23.

Performance characteristics of a typical gear type oil pump are shown in Fig. 7-24.

7-3.3 LIQUID FLOW RESISTANCE

7-3.3.1 Oil Flow Resistance (Ref. 15)¹

The pipe friction loss for engine oil is calculated by first determining the Reynolds number Re as

$$Re = 3160 \frac{(GPM)}{\nu D}, \text{ dimensionless} \quad (7-15)$$

¹ From STANDARD HANDBOOK OF LUBRICATION ENGINEERING by James J. O'Conner and John Boyd, 1968. Used with Permission of McGraw-Hill Book Company

where

D = pipe inside diameter, in.

GPM = oil flow rate, gal/min

ν = kinematic viscosity, centistokes

The friction pressure drop ΔP for laminar flow (Re less than 2000) is determined by

$$\Delta P = \frac{(GPM)\rho\nu L}{229,000 \times D^4}, \text{ psi} \quad (7-16)$$

where

L = pipe length, ft

ρ = oil density, lbm/ft^3 (usually about 53)

The friction pressure drop ΔP for turbulent

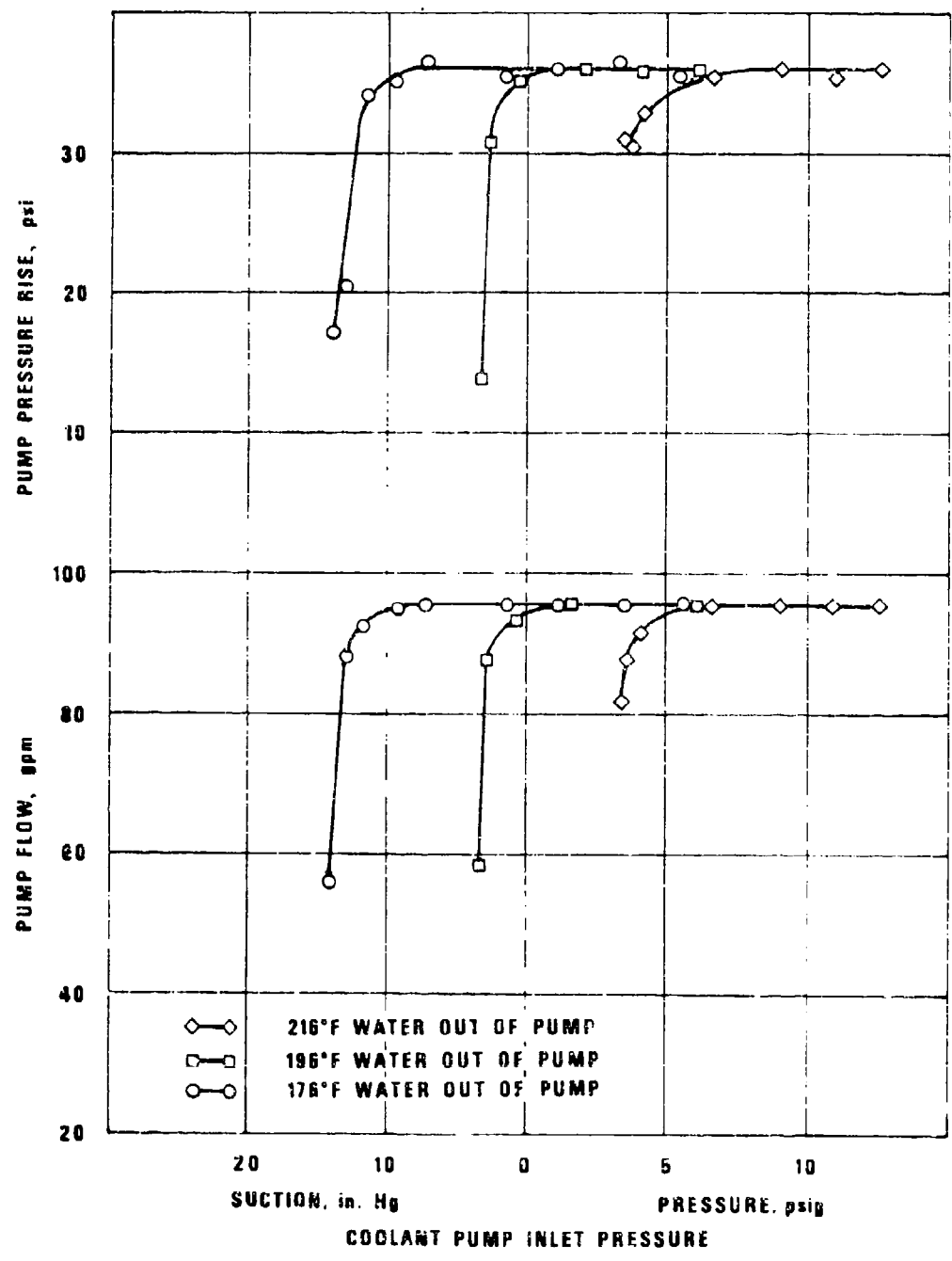

Figure 7-22. Coolant Pump Performance With Variations Inlet Pressure (Ref. 14)

AMCP 706-361

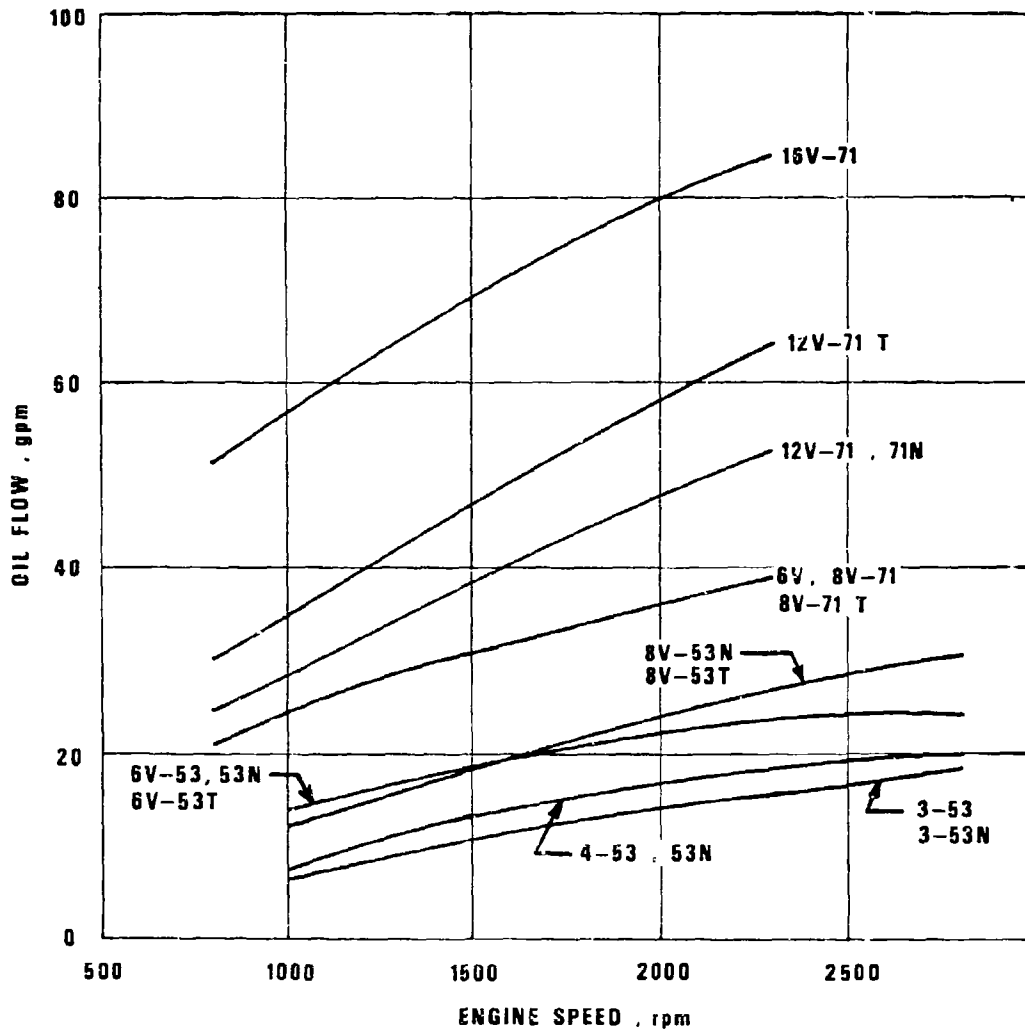

Figure 7-23. Engine Oil Flow Rates vs Speed
 (Courtesy of Detroit Diesel Allison Division, General Motors Corporation)

flow (*Re* more than 2000) is determined by

$$\Delta P = \frac{L\rho(GPM)^{1.8}\nu^{0.2}}{107,500 \times D^{4.8}}, \text{ psi} \quad (7-17)$$

Values for the kinematic viscosity of various SAE grades of engine oil are found in Fig. 7-25.

Piping is the connecting link between all components in a circulating oil system. Details differ but factors used to determine pipe size, estimate pressure loss, select orifice sizes, and choose materials are common in all systems.

Pipe should be large enough to prevent

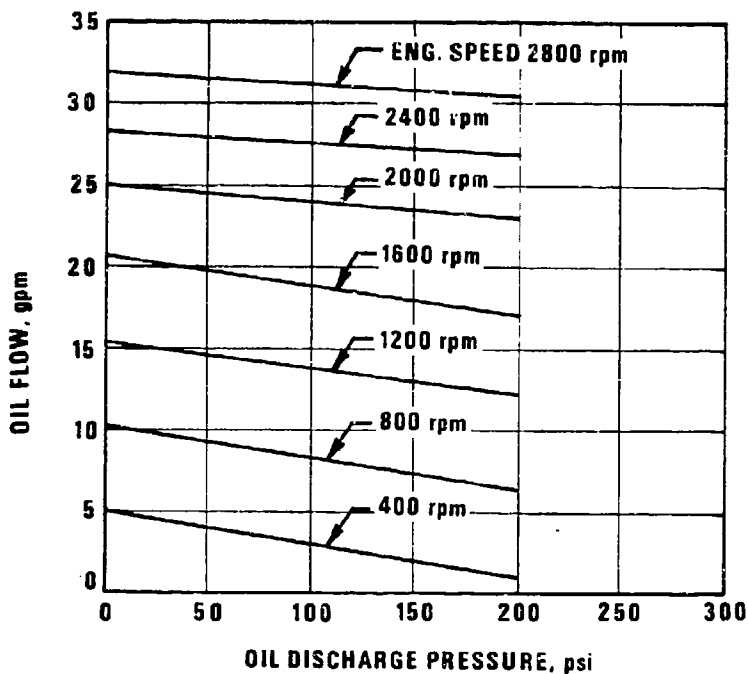

Figure 7-14. Gear Type Pump Performance Characteristics (Ref. 12)

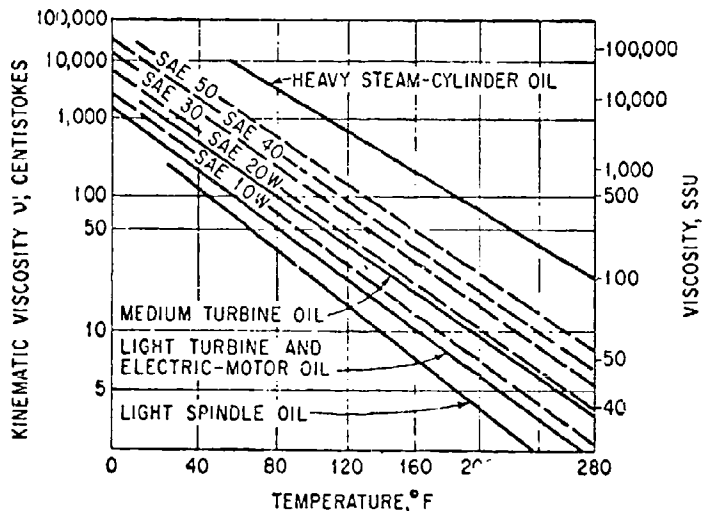

Figure 7-25. Viscosity-Temperature Variation of Lubricants (15) (From STANDARD HANDBOOK OF LUBRICATION ENGINEERING by James J. O'Connor and John Boyd. Used with Permission of McGraw-Hill Book Company.)

AMCP 706-361

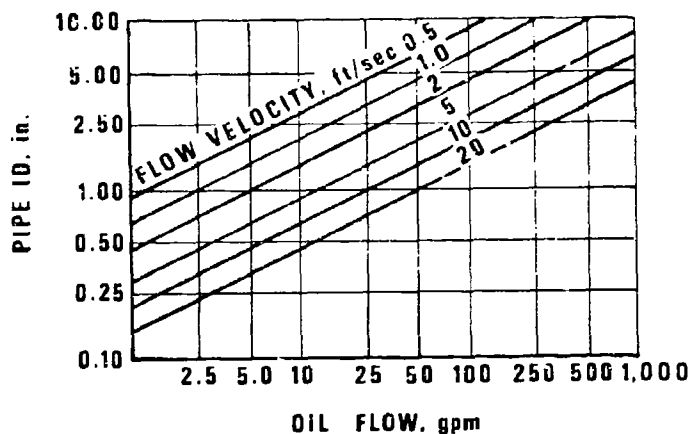

Figure 7-26. Chart for Pipe-size Approximation (Ref. 15) (From STANDARD HANDBOOK OF LUBRICATION ENGINEERING by James J. O'Connor and John Boyd, 1968. Used with Permission of McGraw-Hill Book Company.)

cavitation in pump-suction lines to avoid undue pressure drop ΔP in feed lines and to avoid backup in drain lines. Allowing for these factors, the smallest practical pipe size normally is selected for low first cost and available space.

A guide to select pipe size on the basis of flow velocity is given in Fig. 7-26. Feed lines usually operate at 5 to 10 ft/sec. Velocities up to 20 ft/sec sometimes are used for low-viscosity oil and to keep contaminants from separating in transit. On the other hand, velocities below 5 ft/sec occasionally are required to avoid excessive pressure drop ΔP in long lines carrying high-viscosity oil (Ref. 15).

Copper tubing and pipe should be avoided because they accelerate lube-oil oxidation (see Ref. 15).

Example:

Determine the oil pressure drop through a straight pipe. Given conditions:

Oil type = SAE 30 at an average temperature of 240°F

Oil flow rate = 30 gpm

Oil pipe ID = 1 in.

Oil pipe length = 5 ft

Solution:

Step 1 (From Fig. 7-25). The kinematic viscosity of SAE 30 oil at 240°F is 8.5 centistokes

Step 2. The approximate density of engine oil at 240°F is 51.5 lbm/ft³

Step 3 (By Eq. 7-15)

$$Re = 3160 \times \frac{30}{8.5 \times 1} = 11,153$$

Step 4 (By Eq. 7-17).

$$\Delta P = \frac{5 \times 51.5 \times (30)^{1.8} (8.5)^{0.2}}{107,500 \times (1)^{4.8}} = 1.68 \text{ psi}$$

7-3.3.2 Engine Coolant Flow Resistance

Engine coolant flow resistance data are

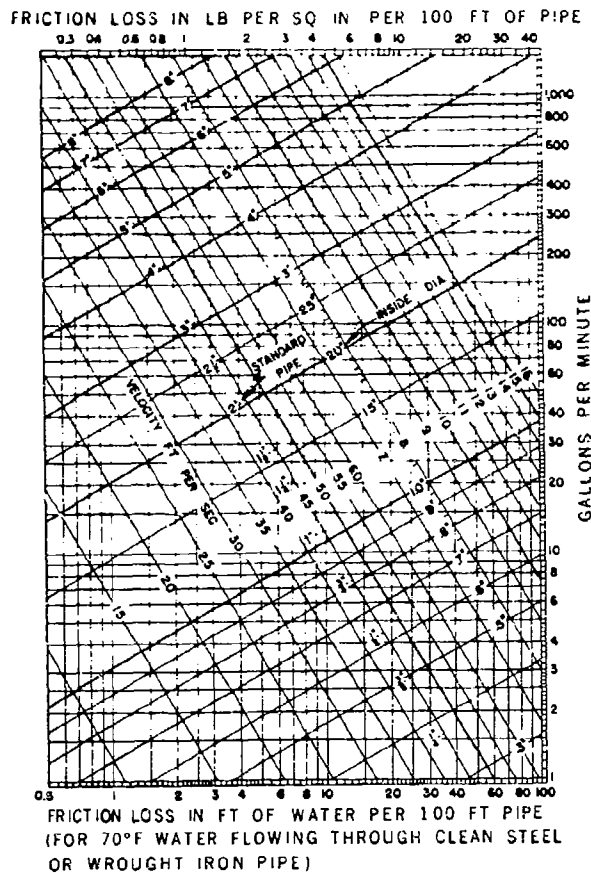

Figure 7-27. Pipe Friction Losses (Ref. 13)
 (Courtesy of Buffalo Forge Co.)

established from actual tests and will vary with the engine design.

Generally, the coolant space between the jacket and cylinder or hot wall is sized to provide reasonably high coolant velocities. The greater the heat transfer rate requirements, the higher will be the required coolant velocities until the optimum flow rate for maximum heat transfer is reached.

7-3.3.3 Fluid Flow Resistance in Piping Systems

The flow friction data for incompressible

fluid flow through ducts, pipes, turns, and related configurations presented in par. 7-2 also can be used for liquid flow analysis. Fig. 7-27 gives values for pipe friction losses for 70°F water flowing through clean steel or wrought iron pipes.

Although friction losses vary somewhat with changes of water density and viscosity, the data of Fig. 7-27 may be used without appreciable error in vehicle cooling system design provided there is no significant amount of gas or vapor existing in the system.

Liquid flow pressure drops through elbows

AMCP 708-561

and fittings generally are expressed in equivalent lengths of straight pipe. Table 7-2 shows equivalent lengths of some standard fittings. The liquid pressure drop through fittings is determined by considering the fitting to be a fictitious straight pipe of the same inside diameter, material, and surface condition. The length of this fictitious straight pipe is the summation of the equivalent lengths of the fitting and the actual length of the fitting along its centerline.

TABLE 7-2

RESISTANCE OF STANDARD PIPE FITTINGS TO FLOW OF LIQUIDS

Size, in.	Equivalent length, ft			90-deg Miter
	Elbows		180-deg	
	45-deg	90-deg		
1/4	0.66	1.2	2.1	2.4
3/4	0.9	2.0	3.2	4.0
1	1.3	2.6	4.1	5.0
1-1/4	1.7	3.3	5.6	7.0
1-1/2	2.1	4.0	6.3	8.0
2	2.6	5.0	8.2	10.0
2-1/2	3.2	6.0	10.0	12.0
3	4.0	7.5	12.0	15.0

(Reprinted by permission from ASHRAE Handbook of Fundamentals 1972)

Example:

A coolant system has a flow rate of 50 gpm of water at 194°F through 50 ft of 2-in. diameter pipe. The system contains six 90-deg elbows, four 45-deg elbows, and two 90-deg miters. What is the pressure drop in the system?

a. From Table 7-2 the equivalent lengths of pipe for the elbows are

30.0 ft for six 90-deg elbows

10.4 ft for four 45-deg elbows

20.0 ft for two 90-deg miters

50.0 ft of straight pipe

110.4 ft total

b. For a 50 gpm flow rate in the 2.0 in. diameter pipe the velocity is

$$V = \frac{GPM}{7.48 A}, \text{ ft/min} \quad (7-18)$$

where

GPM = flow rate, gal/min

A = pipe flow area, ft²

$$V = \frac{50}{7.48 \times \frac{\pi \left(\frac{2}{12}\right)^2}{4} \times 60} = 5.1 \text{ ft/sec}^*$$

*This value may also be read directly from Fig. 7-27.

c. The pressure drop ΔP in the system is found from Fig. 7-27. With a flow of 50 gpm at 5.1 ft/sec the pressure drop ΔP is found to be 2.3 psi per 100 ft of pipe at 70°F. The pressure drop ΔP for 110.4 ft of pipe would therefore be $1.104 \times 2.3 = 2.539$ psi.

The pressure drop ΔP for a system operating at 194°F would be determined by multiplying the pressure by the ratio of the density of water at 194°F to that at 70°F (see Fig. 3-43 for density values at different temperatures)

$$\Delta P = \frac{60.26}{62.30} \times 2.539 = 2.46 \text{ psi}$$

Most vehicle liquid cooling systems have

relatively short lengths of pipe and a minimum number of elbows or turns. The pipe flow pressure losses in these systems are usually insignificant. For example, from Fig. 7-27 a system flowing 150 gal/min of water in a 2-in. diameter pipe would incur a friction loss of less than 0.20 psi per foot of pipe. This would represent a small percentage of the total system losses and unless long pipes

and/or numerous turning elbows were used liquid flow pressure loss generally could be disregarded.

Actual liquid pressure drop data through various heat exchanger cores are obtained experimentally. These data are shown in Appendix A-1 together with the heat transfer performance data.

REFERENCES

1. *Fluid Flow Data Book*, General Electric Co., Schenectady, N.Y., 1970.
2. *Guide and Data Book*, American Society of Heating, Refrigerating, and Air Conditioning Engineers, New York, N.Y., 1972.
3. *Aerospace Applied Thermodynamics Manual*, SAE, New York, N.Y., 1969.
4. Theodore Baumeister, *Mechanical Engineers, Handbook*, McGraw-Hill Book Co., Inc., New York, N.Y., 1967.
5. W. Kays and A. L. London, *Compact Heat Exchangers*, McGraw-Hill Book Co., New York, N.Y., 1964.
6. W. Rosenow and J. Harnett, *Handbook of Heat Transfer*, McGraw-Hill Book Co., New York, N.Y., 1973.
7. *An Evaluation of Engine Cooling Fan Performance - M551*, Allison Division General Motors Corp., Technical Report No. 3649, Indianapolis, Ind., May 1969.
8. "Evaluation and Development Status of Chassis for MBT70 With CMC-AVCR-1100-3B/Allison XHM-1500-2B Power Pack", Presentation to Engine Evaluation Panel, General Motors Corp., Indianapolis, Ind., November 1969.
9. S. G. Berenyi, *The High Temperature Cooling Characteristics of the AVCR-1100-3B Engine as Installed in an MBT/XM803 Vehicle*, Report No. TN AVCR-1100-3B-416, Teledyne Continental Motors, Muskegon, Mich., December 5, 1972.
10. V. J. Maleev, *Internal Combustion Engines*, McGraw-Hill Book Co., Inc., New York, N.Y., 1945.
11. F. Kristal and F. Annett, *Pumps*, McGraw-Hill Book Co., Inc., New York, N.Y., 1940.
12. V. J. Bober, *Flow Bench Test and Inspection of 30 GPM Oil Pump, P/N 596607*, Technical Note No. D465 (1A) 663, Continental Aviation and Engineering Corp., Detroit, Mich., May 1968.
13. *Fan Engineering Handbook*, Seventh Edition, Buffalo Forge Company, Buffalo, N.Y., 1970.
14. C. Casaway, *LDS-465-1A Coolant Pump Characteristics*, Technical Note No. 632, Continental Aviation and Engineering Corp., Detroit, Mich., 1968.
15. James J. O'Conner and John Boyd, *Standard Handbook of Lubrication Engineering*, McGraw-Hill Book Co., Inc., New York, N.Y., 1968.
16. "Hydraulic Diameter of Rectangular Ducts" *Design News*, Volume 28, No. 16, August 20, 1973.

AMCP 706-361

BIBLIOGRAPHY

A. R. Collar, *Some Experiments With Cascades of Aerofoils*, R & M No. 1768, 1937.

John R. Henry, *Design of Power Plant Installations, Pressure-Loss Characteristics of Duct Components*, NACA Wartime Report L-208, June 1944.

G. N. Patterson, *Note on the Design of Corner*

in Duct Systems, R & M No. 1773, October, 1936.

C. Salter, *Experiments on Thin Turning Vanes*, R & M No. 2469, 1952.

Loring Wirt, "New Data for the Design of Elbows in Duct Systems", *General Electric Review*, Volume 30, June 1927.

8-0 LIST OF SYMBOLS

<i>A</i>	= area, ft ²
<i>C_p</i>	= specific heat of air at constant pressure, 0.24 Btu/lbm-°F
<i>CFM</i>	= flow rate, ft ³ /min
<i>F</i>	= correction factor, dimensionless
<i>G</i>	= flow rate, gpm/ft of core width
<i>HP</i>	= horsepower, hp
<i>HIS</i>	= shell side heat transfer coefficient, Btu/hr-ft ² -°F LMTD
<i>ITD</i>	= initial or inlet temperature difference between two heat exchanger fluids, deg F
<i>K</i>	= unit core heat transfer capability, Btu/min-°F ITD
<i>K</i>	= heat transfer capability, Btu/min-ft ² -°F ITD
<i>LMTD</i>	= log mean temperature difference, °F
<i>N</i>	= speed, miles/hr
<i>P</i>	= fluid pressure; in. Hg, in. water
<i>Q</i>	= heat rejection rate, Btu/min
<i>R</i>	= system flow characteristics constant, in. water/ (cfm) ²
<i>RPM</i>	= speed, rev/min
<i>T</i>	= temperature, °F
<i>U</i>	= overall heat transfer coefficient: Btu/min-ft ² -°F, Btu/min-°F-cyl
<i>V</i>	= fluid velocity, ft/min
<i>w</i>	= flow rate, lbm/min
<i>η</i>	= efficiency or effectiveness, dimensionless
<i>ΔP</i>	= fluid static pressure change, in. water

AMCP 706-361

LIST OF SYMBOLS (Cont'd.)

ΔT = temperature difference, deg F

ρ = density, lbm/ft³

Subscripts:

a = air, available

c = compressor, cooler, cylinder, coolant, core

con = conduction

e = effectiveness, engine, exhaust

f = fan, frontal, fuel tank, fuel induction pump, fuel

g = ground

h = heated

i = induction

o = oil, reference

oc = oil-cooler

r = radiation, required

s = static, solar

sp gr = specific gravity

t = test condition

w = water

1 = inlet, condition 1

2 = outlet, condition 2

3 = after aftercooler, condition 3

4 = cooling air out of aftercooler

Definition of Terms (See Preface)

Mass lbm, pounds mass

LIST OF SYMBOLS (Cont'd.)

Force	lbf, pounds force
Length	ft, in., feet, inches
Time	sec, min hr; seconds, minutes hours
Thermal energy	Btu, British Thermai Unit

CHAPTER 8

SYSTEM INTEGRATION AND INSTALLATION DESIGN

Cooling system integration with the overall vehicle design is analyzed and the interrelations of the various system components are discussed. Cooling system optimization, the correlation of the cooling system design with system specifications, and trade-off analyses are discussed and illustrated examples of cooling system designs are presented.

8-1 DESIGN CRITERIA

A good vehicle cooling system design requires close cooperation among the vehicle designers, cooling system designers, and the manufacturers of the engine, transmission, radiator/heat exchanger, and fan. Close coordination among all parties involved is necessary and the latest available information must be used during the design and evaluation period.

Engine performance characteristics are one of the most important data requirements for cooling system design. A typical Cummins Engine Company data sheet is shown in Fig. 8-1. Note that limiting design characteristics such as thermostat range, pressure cap specifications, water temperatures, and intake and exhaust airflows are specified.

In addition to an efficient cooling system design, the installation of the system is also important. Correct cooling component installation and arrangements are of major concern to the component manufacturers. Poor installation and arrangements can result in failure or performance degradation of their products.

The designer is not just assembling a heat transfer system but integrating a series of components into the most economical and practical system that will be compatible with the vehicle design. The problems to be

resolved are not which component is better, but does the component provide the optimum cooling system package for the specific application.

Maximum temperatures of the various components determine the type of heat exchanger to be used and also may determine the location of the heat exchanger in the cooling system.

Hydraulic oil temperatures must be limited to 160°F for open systems. Engine coolant temperatures for diesel engines are usually specified as 200°F maximum by the engine manufacturers. The temperature drop through the engine radiator is usually 10 deg F. From these temperature limits, it is apparent that it is impractical to cool the hydraulic oil with engine coolant because the maximum temperature difference between the coolant and oil would actually result in transferring heat into oil. This condition makes it necessary to use a hydraulic oil-to-air heat exchanger. The location of this heat exchanger should be upstream of the radiator or parallel with it to use the lower entering air temperature. If the heat exchanger were located in the downstream (hot air outlet) side of the radiator, a large core or additional airflow would be required for the same heat dissipation.

Transmission and torque converter oils are usually allowed to reach 250°F or 300°F for short periods. These temperatures provide an

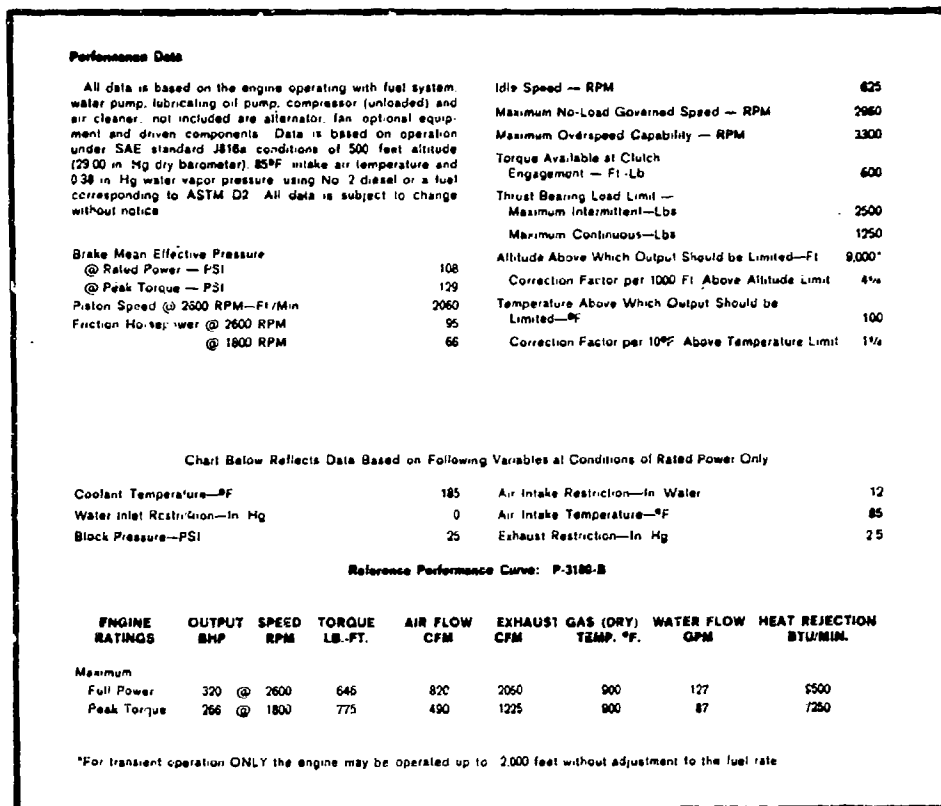

Figure 8-1. (Continued from Previous Page)

option of selecting either an oil-to-air or oil-to-water type heat exchanger when a liquid-cooled engine is used. If an air-cooled engine is used, the obvious selection would be the oil-to-air heat exchanger.

Fig. 8-2 illustrates the major components that can be found in a liquid-cooled vehicle cooling system and, if all items had to be cooled, a possible arrangement of these components.

8-1.1 COOLING SYSTEM ANALYSIS

A successful cooling system design requires a thorough and detailed analysis of all influencing characteristics of the system

components, their interaction with each other, and their combined functions when operating as a complete system.

Fig. 8-3, pictorially expanded for detailed analysis, separates the heat sources and permits the analysis of the effects of the individual heat sources on the complete cooling system.

All components shown in Fig. 8-3 must be analyzed for their effect on the overall system heat transfer characteristics. Components indicated in the schematic which are not used for a particular cooling system simply are omitted from the analysis while a breakdown of general categories such as auxiliary

AMCP 708-381

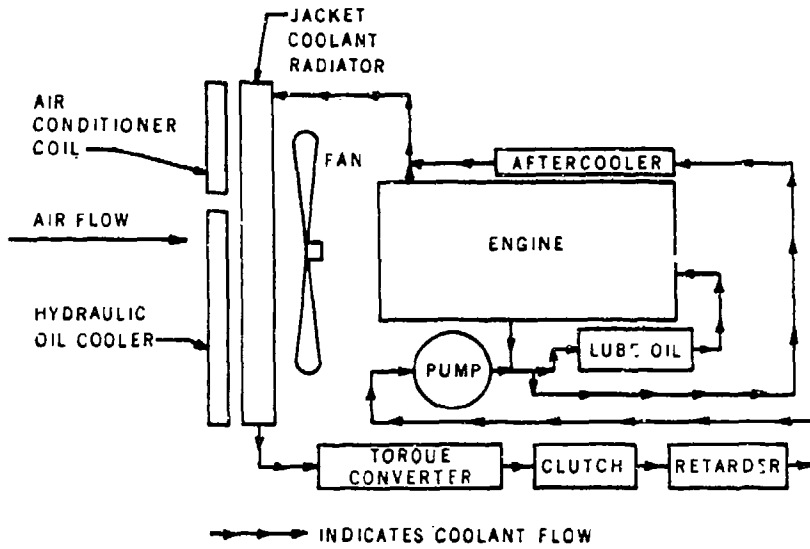

Figure 8-2. Cooling System Diagram for a Liquid-cooled System (Ref. 6)
 (Reprinted with permission, Copyright © Society of Automotive Engineers, Inc., 1972. All rights reserved.)

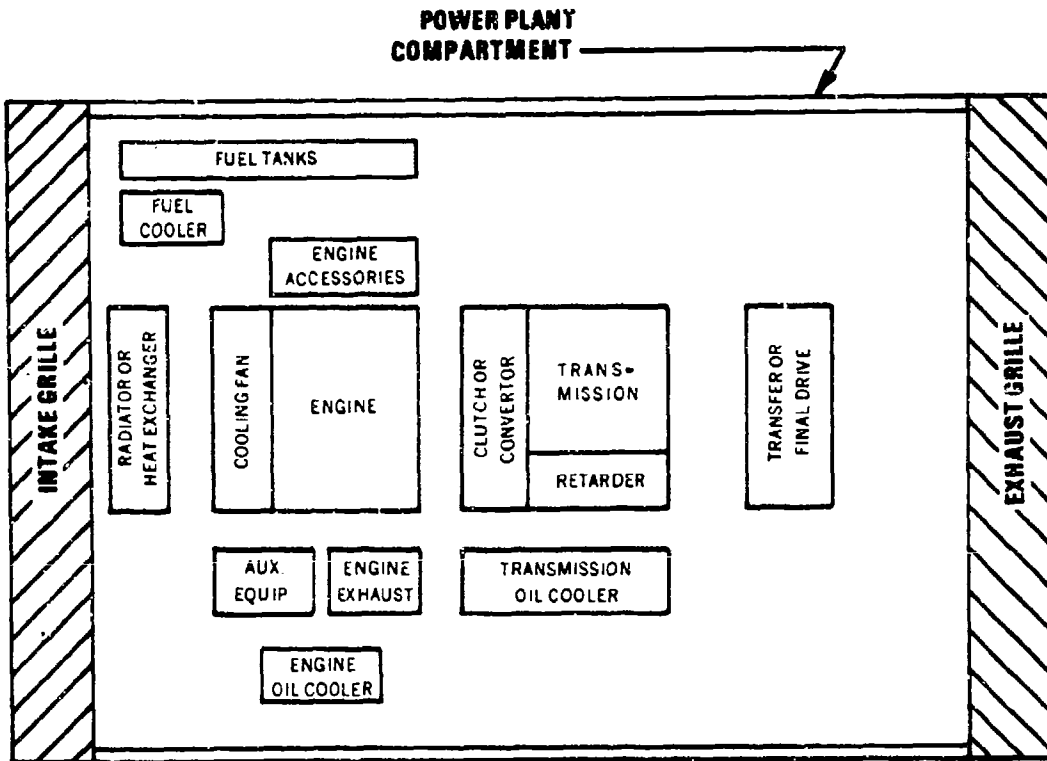

Figure 8-3. Vehicle Cooling System Component Expansion for System Analysis

equipment and engine accessories should be made.

In addition to heat rejection characteristics, the cooling system schematic may be used for analysis of other design parameters such as cooling airflow, auxiliary equipment, power requirements, engine accessory power requirements, and power plant compartment airflow resistance losses.

8-1.1.1 Power Plant Compartment Analysis

Various component heat sources in military vehicles are discussed in Chapter 2. This combined heat load must be removed from the power plant compartment by air entering the compartment at the ambient temperature defined in the vehicle specifications. The temperature range normally is specified as -25° to 125° F. After removing heat from the compartment, the air is exhausted at a higher temperature to the atmosphere.

8-1.1.2 Engine Heat Rejection

In the analysis of engine heat rejection, the engine manufacturer should be consulted during the initial vehicle design to obtain current heat rejection data and determine specific engine requirements and design parameters such as coolant flow rates, temperature limits, and installation requirements or limitations (see Fig. 8-1).

Engine heat rejection normally is specified at full throttle maximum speed conditions, and the cooling system should be designed for these values. However, when a transmission oil cooler is used, the engine heat rejection rate at maximum torque conditions must be known. The cooling system design must be based upon either maximum horsepower or maximum torque conditions, whichever is more critical.

Cooling specifications for military vehicles often require that the vehicle cooling system be adequate to permit the vehicle to perform

continuously at the point where the wheel or track would slip. Past experience indicated that this point occurs when the vehicle tractive effort is approximately 0.75 of the gross vehicle weight. However, it must be stressed that this number may be used for rough preliminary estimations only. Careful determination of the critical cooling design point must be carried out in final design.

If the engine is in a development stage and actual heat rejection characteristics are not known, heat rejection rates normally will be estimated by the engine manufacturer.

8-1.1.3 Engine Accessories and Auxiliary Equipment

Individual analysis of the heat rejection characteristics of engine accessories and auxiliary equipment is necessary. For example, an air-conditioning unit might have a separate condenser mounted in series with the vehicle coolant radiator or the unit could be designed for cab mounting in which case the heat rejected would be completely removed from the power plant compartment. Similarly, the alternator may be air-cooled and discharge heated air into the power plant compartment or it may be oil-cooled and reject its heat into the engine oil cooler, vehicle radiator, or a separate heat exchanger. Individual analysis of each of these components will determine the quantity of heat rejected and the means by which it is rejected into the vehicle cooling system.

8-1.1.4 Engine Oil Cooler

The engine oil heat transfer is dependent on the oil-cooler design. The cooler may be an integral part of the engine design for either liquid-cooled or air-cooled engines, it may be a separate component, or it may be installed in the exit tank of the coolant radiator. If the cooler is an integral part of a liquid-cooled engine design, the heat rejection into the oil is included in the engine coolant heat rejection rate.

AMCP 706-361

8-1.1.5 Engine Exhaust

The engine exhaust gases normally are piped out of the power plant compartment and do not enter into the vehicle cooling system heat analysis; however, for example, in installations similar to the MBT70 Prototype Tank, the gases are exhausted into the "hot" side of the cooling compartment and must be considered for exhaust grille and airflow analysis. Considerations must be made for heat dissipated from the exhaust system into the power plant compartment by radiation and convection.

8-1.1.6 Transmission

The transmission may be analyzed as an assembly of components including the torque converter or oil-cooled clutch and retarder. Total converter or oil-cooled clutch heat rejection normally can be dissipated by a single heat exchanger. For liquid-cooled engine applications of lower power output this heat exchanger often is located in the radiator exit tank. The transmission also may include braking and steering components that may require separate duty cycle analysis. Larger transmissions for higher horsepower output engines normally require a separate oil-to-air or oil-to-liquid heat exchanger (see Figs. 1-18 and 1-27). Comparison of these two type transmission oil coolers is discussed in par. 3-6.4.

8-1.1.7 Clutch

Conventional friction clutches used with mechanical transmissions normally are not considered separately in the cooling system analysis because of their intermittent heat rejection characteristics.

Construction equipment, fork lift trucks, and similar applications requiring repeated stopping and starting use oil-cooled clutches that require oil-coolers. The cooler design and/or location will determine the method of heat transfer in the power package compartment.

8-1.1.8 Retarder

Special consideration must be made if a retarder is used in the vehicle. The retarder functions only when the engine heat load is low and therefore its heat load should not be added to engine heat rejection. It is common for the retarder horsepower capacity to exceed the engine horsepower and may result in a cooling system size requirement that is not practical. In this case, an analysis of the vehicle duty cycle must be made to determine a compromise cooling system. A warning system must be incorporated to alert the operator when the cooling system capacity is approached if it is not sufficient to carry the maximum retarder heat load.

8-1.1.9 Fuel Tank

Fuel injected engines transfer heat into the fuel returned to the vehicle tanks. Under normal circumstances, this heat would be conducted into the vehicle structure and dissipated. It would not be considered in the cooling system design; however, the use of fuel tank liners and the location of fuel tanks in enclosed combat vehicle power plant compartments often require the addition of a liquid-to-air fuel cooler to maintain fuel temperatures below 150°F.

8-1.1.10 Power Plant Heat Transfer

Fig. 8-4 illustrates a composite heat rejection schematic for a vehicle cooling system. It should be concluded that the effect of the heat rejection of the individual components on each other is not a simple relationship. However, reasonably accurate estimations can be made for the individual component primary heat rejection modes. These relationships can be estimated by "experience factors" based on evaluations of previous designs and tests of contemporary military vehicles.

8-1.1.11 Airflow

The power plant airflow characteristics can

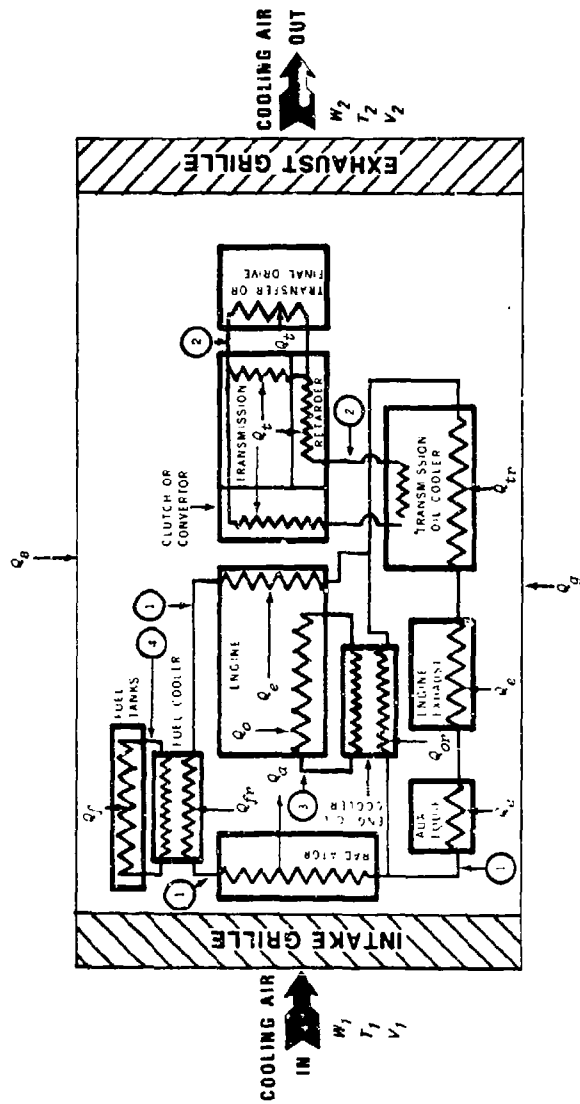

SYMBOLS:

- 1 = ENGINE COOLANT
- 2 = TRANSMISSION OIL
- 3 = ENGINE OIL
- 4 = FUEL

Subscripts:

- q = rejected to cooling air by radiator coolant
- q = rejected directly to coolant
- f = absorbed in fuel system
- fc = rejected to coolant air from fuel in fuel cooler
- e = absorbed from ground radiation
- ex = rejected to engine oil
- tr = rejected to coolant from oil in oil-cooler
- e = absorbed from solar radiation
- t = rejected to transmission oil
- tr = rejected to coolant from transmission oil in oil-cooler

NOTE:

1. External surfaces of components will have heat transfer activities with surrounding air and structures.
2. This figure shows all liquid-cooled components and accessories. In the actual power package system some of these components (except engine) may be air-cooled.
3. For air-cooled engines the components and accessories are air-cooled (fuel-oil heat exchanger is the exception).

Figure 8-4. Power Package Composite Heat Rejection (USATACOM)

AMCP 706-381

be analyzed by using the vehicle cooling system schematic as shown in Fig. 8-5. Analysis of the airflow rates and pressure losses of each of the components can be made, and estimated values can be assigned for system losses as discussed in par. 7-2. As in the case of the system heat rejection analysis, the components shown in Fig. 8-5 are arranged to agree with the actual vehicle configuration.

On some installations, air recirculation from the "hot" side to the "cold" side can affect adversely the cooling system effectiveness. Generally, recirculation can be evaluated accurately by test; however, the initial vehicle cooling system design should make provisions for minimizing this effect and compensating for what does occur. A minimum air temperature rise of 10 deg F often is used for initial design calculations. Actual temperature increases as high as 25 deg F have been observed. Fig. 6-16 shows that poor design such as locating inlet grilles directly adjacent to exhaust grilles generally results in excessive recirculation. This figure shows the external recirculation effects. The effects of internal recirculation and the desirability of maintaining a negative pressure in the engine compartment also must be considered.

8-1.1.12 Winterization

The preceding discussion deals primarily with the removal of heat from the power plant compartment. In cold ambients the problem of heat removal may cease to exist and the problem becomes one of maintaining temperatures high enough to prevent overcooling. Extended operation of liquid-cooled engines with coolant temperatures below 160°F permits sludge, water, and acid to accumulate in the crankcase or lubricating oil sump and should be avoided.

Radiator shutters, temperature controlled cooling fans, thermostats, radiator covers, compartment insulation, and/or winterization kits are usually necessary for satisfactory

vehicle performance in low ambient temperatures particularly when the engine power requirements are low. The cooling system analysis should be made for both the minimum and maximum ambient operating temperature conditions cited by the vehicle specifications.

8-1.1.13 Cooling System Variables

It must be recognized that performance characteristics specified by component manufacturers generally are stated for laboratory conditions that seldom are encountered during actual military vehicle operation. Radiators and heat exchangers become partially blocked by fin damage, or dirt or foreign matter. Cooling fans are not installed under the same conditions as they are tested and rated; and cooling performance normally will deteriorate because of scale formation in liquid-cooled systems and dirt and oxidation or corrosion in direct-cooling systems. Additional cooling fan capacity often is required to obtain the airflow necessary for satisfactory cooling system performance.

Direct-cooled engine design practice usually provides adequate airflow for anticipated cooling system deterioration. For fail-safe operation, liquid-cooled systems should be designed for the required high ambient temperatures based on an atmospheric pressure in the coolant system. A pressurized system then is used to provide adequate reserve cooling capacity.

A thorough understanding of the military environment is necessary for the cooling system designer to apply realistic "experience factors" to the system design. Tables 3-1, 3-2, and 3-4 may be used to compare existing military vehicle cooling system characteristics with the design requirements for a new vehicle. Table 3-1 shows the radiators used for contemporary vehicles, and indicates the horsepower per unit frontal area and volume of the radiator cores. It can be expected that a new vehicle cooling system will compare with a similar vehicle identified in these

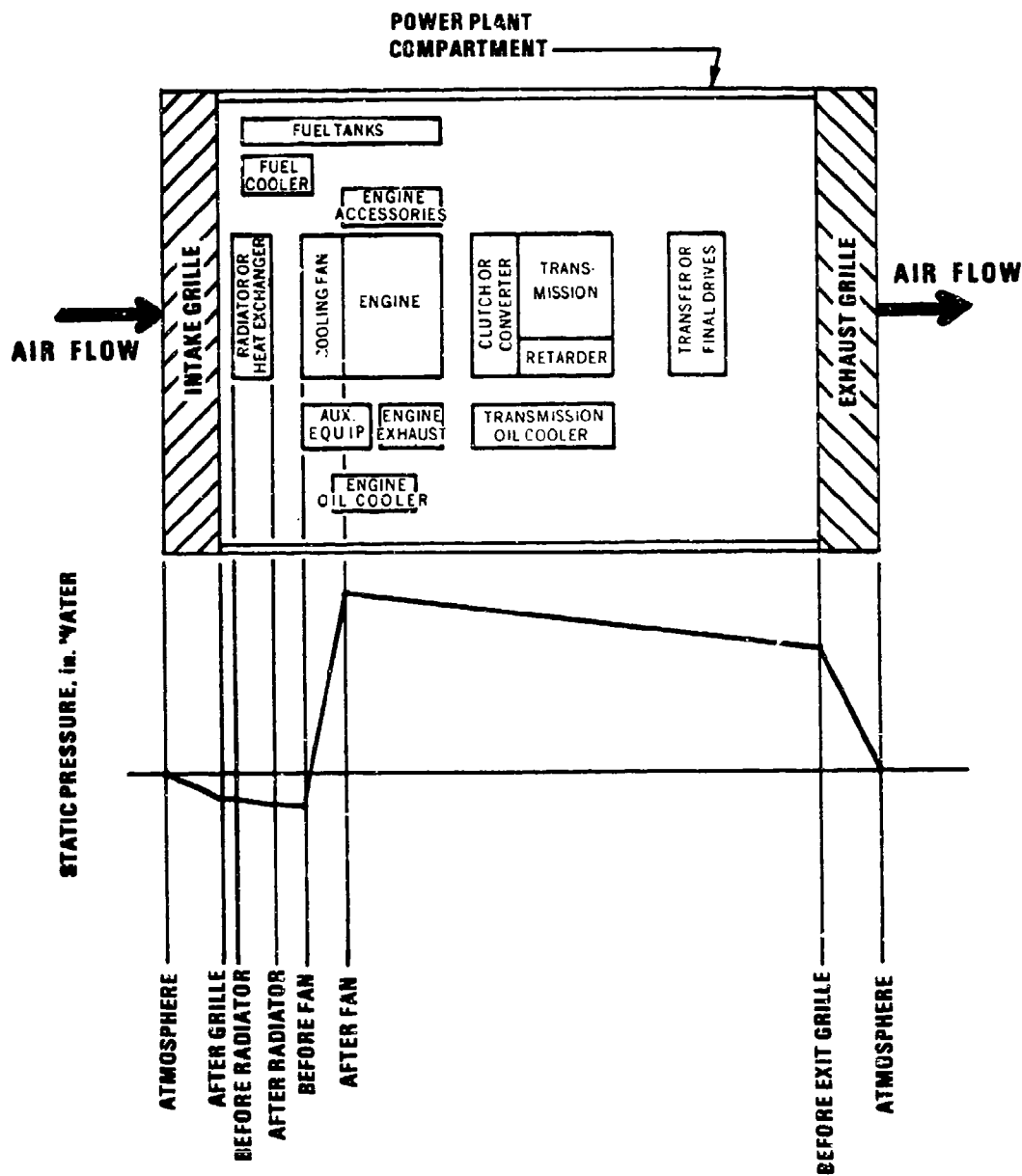

Figure 8-5. Cooling Air Static Pressure Profile

AMCP 706-361

tables. In the use of these tables, it should be noted that some vehicles do not cool adequately under all conditions.

8-1.2 VEHICLE PERFORMANCE SPECIFICATIONS

The vehicle specifications, purchase descriptions, or materiel requirements normally specify performance requirements that must be interpreted and translated into power plant and component requirements. All performance parameters must be analyzed to determine the most severe design point for the cooling system, particularly if a torque converter or hydromechanical type transmission is specified.

Generally, engine, transmission system, and other component heat rejection data should be obtained for critical operating conditions. This information should be correlated with the system air resistance and fan characteristics. The final cooling system design point is then determined. The design point occurs under one of several operating conditions such as operation on grades, during towing operations, or under engine idle conditions. Regardless of the mode of operation which results in the maximum cooling system heat load, the vehicle cooling system capacity must be adequate to handle this heat load at the design point.

8-2 COOLING SYSTEM INTEGRATION

Not only must the vehicle cooling system be analyzed as a complete unit, it also must be analyzed for its effect on the overall vehicle system design (see Ref. 5). The cooling system interfaces with the vehicle and must not affect adversely other subsystems and must be integrated for system optimization. For example, the operator/crew compartment or cab may be heated from the cooling system and, if required, a ventilation system might become a combined crew compartment and power plant compartment ventilating system (see Fig. 1-10).

Human factors engineering considerations also must be reviewed for the operator and maintenance personnel interfaces with the cooling system. Therefore, it is important to include a human factors engineering study when determining the optimum cooling system design with proper consideration being given to both the operator and maintenance personnel. Information in these areas can be obtained from Refs. 1 and 2.

8-3 COOLING SYSTEM OPTIMIZATION

An optimum cooling system design basically is the one that:

1. Meets the system performance requirements.
2. Can be installed in the allowable space.
3. Meets specified weight limitations.
4. Is cost effective.
5. Requires minimum power to operate.
6. Is convenient for maintenance service and repairs.
7. Is designed to provide for system deterioration.

These requirements often are not compatible. Power plant space and weight requirements often dictate compromises in the cooling system design, that in turn could result in higher power consumption because of higher fluid resistance in various subsystems. As a result, the final cooling system design is often a compromise that performs successfully at the expense of lesser important vehicle system design characteristics.

8-4 COOLING SUBSYSTEM TRADE-OFF ANALYSIS

One method of evaluating a number of particular components or design parameters is

a trade-off analysis. The trade-off analysis simply may be a graph of performance characteristics if only two variables are evaluated; or it may be a tabulation of characteristics as shown in Fig. 8-6 when several characteristics of varying relative importance must be evaluated.

The examples shown in Fig. 8-6 are used to demonstrate how the trade-off study may be employed for selection of a cooling fan and drive assembly, i.e.,

1. The limiting parameters, Column 1, are obtained from the cooling system design and performance requirements and/or the vehicle specifications. Cost may be one of the parameters to be considered (Ref. 6).

2. The specification or requirement, Column 2, defines the quantitative requirements for the limiting parameters.

3. The weighting factor, Column 5, assigns a factor to each specification or requirement based on its relative importance in the system or subsystem design. The example shown in Fig. 8-6 assumes that performance is five times as important as power consumption. This factor is arbitrary and may vary or even be the same for all specifications.

4. The compliance factor, Column 4, permits the component being evaluated to score higher for exceeding the basic requirements. This often is the deciding factor in the trade-off analysis.

5. The score for the item being evaluated is the sum of products of the compliance factors and the weighting factors.

It is possible with this type of trade-off study that an item being evaluated would not conform in one or more areas and yet would receive the highest score of the items under evaluation. In this event, the designer shall determine if the vehicle or system design can be altered to accept the highest ranking item.

For example, assume the Brand B fan, Fig. 8-6(B) nonconforming for excessive power consumption over the specification in which case it would receive a "0" in column 4, yet the total score would still exceed the total score of Brand A (19.0 - 1.5 or 17.5). Since the power requirement was given the lowest weighting factor in this example, it is probable that the additional power required to use Brand B could have been tolerated.

8-5 COOLING SYSTEM DESIGN EXAMPLES

The vehicle cooling system analysis examples presented here are selected to show the typical applications of the vehicle cooling system analysis developed in par. 8-1.1. The basic procedure can be applied to any type of cooling system, however, it must be kept in mind that numerical values for many of the heat transfer and airflow parameters cannot be obtained easily but may be based on previous designs and test results of similar cooling systems.

8-5.1 PRELIMINARY COOLING SYSTEM DESIGN

A first approximation of a vehicle cooling system design should be made. This can be done without selection of specific cooling components by applying typical experience factors and operating parameters. This allows a general and preliminary sizing of components and understanding of the requirements of all subsystems from total vehicle system specifications. Specific examples of how this can be done follow.

8-5.1.1 Engine Cooling

An example of a first approximation for the cooling system requirement is presented here for an air-cooled turbocharged engine. This example is based on the following assumptions:

1. Engine power rating $HP = 1250$ hp

TRADE-OFF STUDY WORK SHEET

ITEM Brand B Fan and Drive Assy. Date 15 December 1972

Limiting Parameter	Specification or Requirement	Item Capability	Compliance Factor	Weighting Factor	Score
Performance	2000 cfm at 1 In. Water	2000 cfm at 1 In. Water	1.0	5	5.0
Size	20 In. Dia (max)	18 In. Dia	1.0	2	2.0
Power Consumption	1.2 HP (max)	0.7 HP	1.5	1	1.5
Noise	65 dB (max)	60 dB	1.5	4	6.0
Reliability	2000 Hours MTBF**	4500 Hours MTBF**	1.5	3	4.5
TOTAL SCORE					19.0

**Mean Time Between Failures
*Compliance Factor:
0 = Does not meet specifications or not applicable
1.0 = Average compliance with specifications or requirements
1.5 = Significantly exceeds specification requirements
(B) Brand B Fan and Drive Assembly

TRADE-OFF STUDY WORK SHEET

ITEM Brand A Fan and Drive Assy. Date 15 December 1972

Limiting Parameter	Specification or Requirement	Item Capability	Compliance Factor	Weighting Factor	Score
Performance	2000 cfm at 1 In. Water	2000 cfm at 1 In. Water	1	5	5.0
Size	20 In. Dia (max)	20 In. Dia	1	2	2.0
Power Consumption	1.2 HP (max)	0.9 HP	1	1	1.0
Noise	65 dB (max)	65 dB	1	4	4.0
Reliability	2000 Hours MTBF**	2000 Hours MTBF**	1	3	3.0
TOTAL SCORE					15.0

**Mean Time Between Failures
*Compliance Factor:
0 = Does not meet specifications or not applicable
1.0 = Average compliance with specifications or requirements
1.5 = Significantly exceeds specification requirements
(A) Brand A Fan and Drive Assembly

Figure 8-6. Trade-off Study Work Sheet

2. Ambient air temperature $T_1 = 120^\circ\text{F}$
3. Cylinder cooling airflow = 600 lbm/min (normally obtained from engine test)
4. Cylinder heat rejection = 18,000 Btu/min (normally obtained from engine test)
5. Engine induction manifold pressure $P_2 = 105$ in. Hg absolute
6. Induction airflow rate = 200 lbm/min
7. Turbocharger compressor inlet pressure $P_1 = 28.0$ in. Hg absolute
8. Compressor adiabatic efficiency $\eta_c = 70\%$ (assumed)
9. Maximum allowable intake manifold temperature $T_3 = 250^\circ\text{F}$ (to obtain required engine horsepower)
10. Induction air cooler cooling air side effectiveness $\eta_c = 40\%$ (assumed) See Eq. 8-20 for η_c definition.
11. Engine oil heat rejection = 7500 Btu/min
12. Maximum allowable oil sump temperature = 260°F
13. Engine oil flow rate = 500 lbm/min
14. Oil-cooler cooling air side effectiveness $\eta_c = 65\%$ (assumed).
15. Radiation and recirculation increases the ambient air temperature by 10 deg F.
16. Typical static pressure losses in contemporary vehicles are:

<u>Area</u>	<u>in. water</u>
a. Inlet grille	2.0
b. Ducts to engine	1.5

c. Through engine (and coolers)	8.0
d. Discharge ducts	1.5
e. Exit grille	<u>2.0</u>
Total	15.0

17. Fan is located after the engine, then

- a. Air static pressure at fan inlet = -11.5 in. water
- b. Air static pressure at fan exit = +3.5 in. water
- c. Total fan air static pressure rise = 15.0 in. water
- d. Fan air static efficiency = 45% (assumed).

The values used in these assumptions are fairly representative of practice found in combat vehicles requiring armor grilles and minimum size for the cooling components.

Step 1. The induction air cooling (heat rejection Q_i) requirement (in the aftercooler) is analyzed as follows:

$$Q_i = w_i C_p (T_2 - T_3), \text{ Btu/min} \quad (8-1)$$

where

C_p = specific heat of air at constant pressure, 0.24 Btu/lbm- $^\circ\text{F}$

T_2 = air temperature out of compressor, $^\circ\text{F}$

T_3 = air temperature in induction manifold (after the aftercooler), $^\circ\text{F}$

w_i = induction airflow rate, lbm/min

The induction air temperature T_2 out of the compressor is

AMCP 706-361

$$T_2 = T_1 + \frac{(T_1 + 460)[(P_2/P_1)^{0.283} - 1]}{\eta_c}, \quad (8-2)$$

°F

where

- P_1 = compressor inlet pressure, in. Hg absolute
- P_2 = induction manifold air pressure, in. Hg absolute
- T_1 = compressor cooling air inlet temperature (ambient +10), °F
- η_c = compressor efficiency, dimensionless

therefore

$$T_2 = 130 + \frac{(130 + 460)[(105/28)^{0.283} - 1]}{0.70}$$

$$= 513^\circ\text{F}$$

$$Q_i = (200)(0.24)(513 - 250) = 12,624 \text{ Btu/min}$$

The cooling airflow rate w_a through the induction cooler is

$$w_a = \frac{Q_i}{(T_2 - T_1)\eta_a C_p}, \text{ lbm/min} \quad (8-3)$$

where

- η_a = cooling air side effectiveness of aftercooler, dimensionless (0.40 assumed)

therefore

$$w_a = \frac{12,624}{(513 - 130)(0.40)(0.24)} = 343 \text{ lbm/min}$$

Step 2. The engine oil cooling airflow rate w_o is

$$w_o = \frac{Q_o}{(T_o - T_1)\eta_e C_p}, \text{ lbm/min} \quad (8-4)$$

where

- Q_o = heat rejection to engine oil, Btu/min
- T_o = maximum allowable sump oil temperature, °F
- T_1 = cooling air temperature (ambient + 10), °F
- η_e = air side effectiveness of oil-cooler, dimensionless (0.65 assumed)

Therefore

$$w_o = \frac{7500}{(260 - 130)(0.65)(0.24)} = 370 \text{ lbm/min}$$

Step 3. The total heat rejection rate and cooling air flow rate summation is

	Airflow w , lbm/min	Heat Rejection Q , Btu/min
Cylinders	600	18,000
Induction air	343	12,624
Oil cooling	<u>370</u>	<u>7,500</u>
Total	1313	38,124

Step 4. Determination of fan airflow and horsepower T_h (air into cooler). The temperature of the heated air after the coolers and in front of the fan is

$$T_h = T_1 + \frac{Q}{C_p w}, \quad (8-5)$$

therefore

$$T_h = 130 + \frac{38,124}{(0.24)(1313)} = 251^\circ\text{F}$$

For nonstandard air the density ρ is

$$\rho = 0.075 \times \frac{T_s + 460}{T_a + 460} \times \frac{[29.92 - (P_1/Hg_{sp\ gr})]}{29.92}, \text{lbm/ft}^3 \quad (8-6)$$

where

T_s = temperature of standard air, $^\circ\text{F}$
(use 70°F)

T_a = actual temperature of air, $^\circ\text{F}$

P_1 = pressure of air used, in. Hg
absolute

$Hg_{sp\ gr}$ = specific gravity of mercury, di-
mensionless (use 13.6)

Therefore

$$\rho = 0.075 \times \frac{460 + 70}{460 + 251} \times \frac{[29.92 - (11.5/13.6)]}{29.92} = 0.0543 \text{ lbm/ft}^3$$

The volume CFM of the heated air at the fan inlet is

$$CFM = \frac{w}{\rho}, \text{ft}^3/\text{min} \quad (8-7)$$

Therefore

$$CFM = \frac{1313}{0.0543} = 24,180 \text{ cfm}$$

The density of the air ρ at the inlet grille is

$$\rho = 0.075 \times \frac{460 + 70}{460 + 120} = 0.0685 \text{ lbm/ft}^3$$

Therefore the volume CFM at the inlet grille is

$$CFM = \frac{1313}{0.0685} = 19,168 \text{ cfm}$$

The cooling fan horsepower HP_f is

$$HP_f = \frac{CFM \times \Delta P \times 1.575 \times 10^{-4}}{\eta_s}, \text{hp} \quad (8-8)$$

Therefore

$$HP_f = \frac{(24,180)(15)(1.575)(10^{-4})}{0.45} = 127 \text{ hp}$$

These results can be summarized as follows:

1. Total heat rejection = 38,124 Btu/min
2. Volume of cooling air at inlet grille = 19,168 cfm
3. Volume of heated cooling air = 24,180 cfm
4. Cooling fan horsepower = 127 hp

Step 5. From these data the approximate duct size and grille areas can be calculated. For instance if the grille shown in Fig. 6-12 were chosen, the required grille area in order to meet the air pressure drop requirements would be

1. Inlet = 12.2 ft²
2. Outlet = 14.1 ft².

AMCP 706-361

If the engine cooling system were to be combined with the transmission system, then the results can be added to those of the transmission as determined by the method shown in par. 8-15.1.2, and the grille areas determined in accordance with the total airflow rates. (Refer to Chapter 6 to determine areas for different air densities.)

8-5.1.2 Transmission Cooling

The requirement for transmission cooling is influenced very heavily by the specified tractive effort and ambient temperature at which continuous operation must be maintained without overheating. To illustrate this, a prediction for a hypothetical vehicle has been made showing these relationships. This prediction was made by using a computer program. It should be noted that by changing the transmission drive ratio a significant change in cooling horsepower requirement can be obtained as plotted in Fig. 8-7. Tables 8-1 and 8-2 are the tabulation of the computer program output. Inputs to the computer program were the vehicle performance equations found in Table 2-5. This example is for a vehicle having the following features:

1. Gross vehicle weight = 120,000 lb
2. Engine gross horsepower = 1400 hp
3. Engine rated speed = 2600 rpm
4. Transmission type = converter with lock-up
5. Maximum allowable transmission oil temperature = 300°F
6. Entering cooling air temperature = 125°F
7. Oil-cooler airside effectiveness = 65% (assumed)
8. Total cooling air system pressure drop at engine rated speed = 15 in. water

9. Cooling fan efficiency = 50% (assumed).

The heat rejection rate from the transmission is a function of the converter characteristics and transmission spin losses at the vehicle speed, engine speed, and tractive effort output (par. 2-2.3.2). Note that with a design change in final drive ratio to go from a 44 mph top speed (Table 8-1) to a 36 mph top speed (Table 8-2) a significant change in the "heat rejection-vehicle speed-engine speed-tractive effort" relationships occur.

The formulas used to calculate the required cooling airflow rate and fan *HP* are:

$$w = \frac{Q_o}{(T_o - T_1)\eta_c C_p}, \text{ lbm/min} \quad (8-9)$$

where

C_p = specific heat of air at constant pressure, Btu/lbm·°F

Q_o = transmission oil heat rejection rate, Btu/min

T_o = temperature of air into cooler, °F

T_1 = temperature of air into cooler (ambient + 10), °F

η_c = airside effectiveness of cooler, dimensionless

The transmission cooling fan horsepower HP_f at rated engine speed is

$$HP_f = \frac{CFM(2600/N_c)1.575\Delta P \times 10^{-4}}{\eta_f} \cdot \text{hp} \quad (8-10)$$

where

CFM = airflow rate, cfm at 2600 rpm engine speed

N_c = fan speed at operating point, rpm

TABLE 8-1

**TRANSMISSION COOLING REQUIREMENT PREDICTED FOR
 VEHICLE DESIGNED FOR 44 MPH TOP SPEED**

CONDITIONS: 4.3 FINAL DRIVE RATIO
 TRANSMISSION IN FIRST GEAR CONVERTER

VEHICLE		TRANSMISSION			ENGINE
SPEED, MPH	TRACTIVE FORCE, LB	HEAT REJECTION, BTU/MIN	COOLING		SPEED, RPM
			AIRFLOW RATE, CFM	HP AT 2600 RPM	
1	98280	33440	18130	108	2040
2	88660	21690	13390	79	2060
3	78940	17810	9650	57	2070
4	70030	13770	7470	43	2120
5	61920	11720	6350	35	2202
6	53670	11140	6040	32	2290
7	46590	11530	6250	32	2390

NOTE: FOR FULL COOLING, A FAN MUST BE PROVIDED THAT PERMITS THE VEHICLE TO OPERATE CONTINUOUSLY AT THE TRACTIVE FORCE REQUIRED BY THE VEHICLE SPECIFICATIONS.

TABLE 8-2

**TRANSMISSION COOLING REQUIREMENT PREDICTED FOR
 VEHICLE DESIGNED FOR 36 MPH TOP SPEED**

CONDITIONS: 5.2 FINAL DRIVE RATIO
 TRANSMISSION IN FIRST GEAR CONVERTER

VEHICLE		TRANSMISSION			ENGINE
SPEED, MPH	TRACTIVE FORCE, LB	HEAT REJECTION, BTU/MIN	COOLING		SPEED, RPM
			AIRFLOW RATE, CFM	HP AT 2600 RPM	
1	117880	30870	16730	100	2053
2	103460	21140	11460	68	2070
3	89290	14830	8040	46	2110
4	76740	11870	6440	36	2190
5	64560	11180	6060	32	2310

NOTE: FOR FULL COOLING, A FAN MUST BE PROVIDED THAT PERMITS THE VEHICLE TO OPERATE CONTINUOUSLY AT THE TRACTIVE FORCE REQUIRED BY THE VEHICLE SPECIFICATIONS.

AMCP 706-361

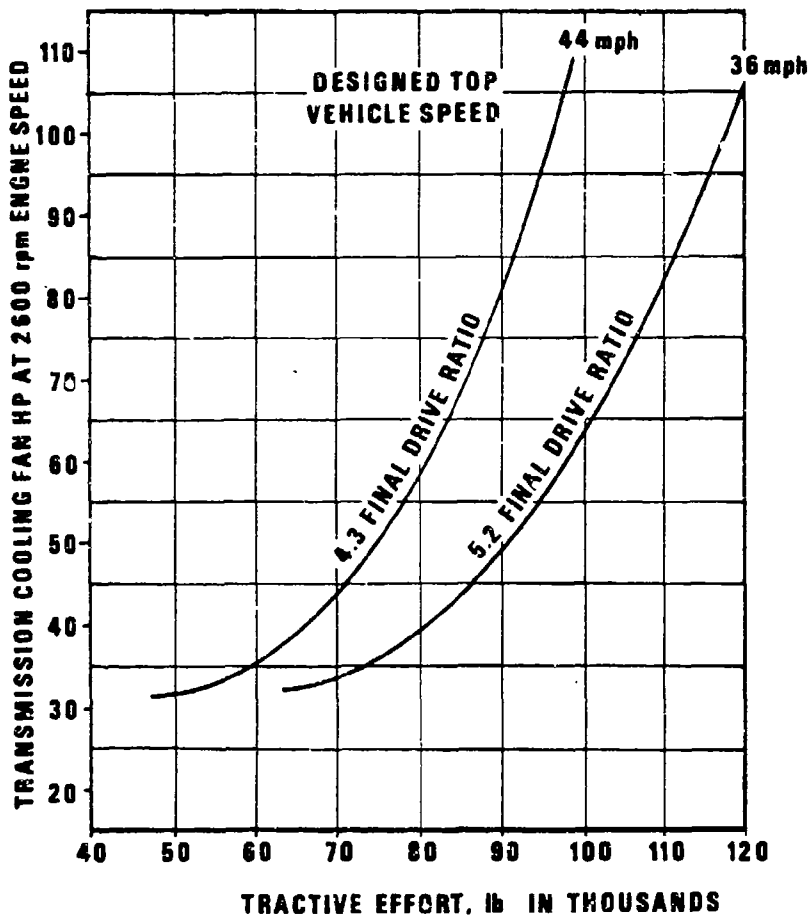

Figure 8-7. Effects of Transmission Gear Ratio Selection and Required Tractive Effort on Transmission Cooling Fan Horsepower Requirements

ΔP = total vehicle system air static pressure drop, in. water

η_s = cooling fan static efficiency dimensionless

It should be recognized that each point on the curves shown on Fig. 8-7 represents a different design, each capable of cooling at the respective tractive effort points. A study of this curve shows the severe penalty paid in cooling power as a function of designed

vehicle top speed and the specified tractive effort cooling point. These factors should be considered in establishing the vehicle performance requirements specifications. These calculations are based on the assumption that airflow system resistance can be maintained at 15 in. water with the variation in required airflow rate. If this cannot be done due to limitations on cooling airflow areas, cooler size, and grille areas, then the rate at which fan horsepower increases with tractive effort will be greater than that shown.

8-5.1.3 Design of the Experimental Power Plant Cooling System Installation for the M114 Product Improvement Program (PIP) Vehicle (USATACOM)

A cooling study for an increased power version of the M114 Vehicle was conducted by the US Army Tank-Automotive Command. The vehicle originally used the Chevrolet 283 CID engine rated at 143 maximum hp at 4600 rpm engine speed. The power train system included a hydromatic 305-MC transmission and a GS-100 steer unit. The gross vehicle weight (GVW) was 16,500 lb.

The PIP vehicle was to incorporate the Chrysler 361 CID (75M) engine rated at 200 hp maximum at 4000 rpm engine speed and a hydrokinetic torque converter X-200 Allison prototype transmission.

The original vehicle used an inefficient sheet metal propeller fan. In the redesign it was decided that this fan would be replaced with a modern efficient axial flow fan. The new fan performance curve is shown in Fig. 8-8. The fan design was based on a maximum allowable fan power consumption value of 15 percent of gross engine horsepower. The fan size was determined by the fan manufacturer after the airflow and static pressure were specified. To minimize fan noise, a fan speed of 4000 rpm was chosen.

The original M114 did not have an engine oil cooler, and desert tests had shown that the engine oil cooling was inadequate. An engine oil cooler was incorporated for the PIP vehicle to eliminate this problem.

8-5.1.3.1 Cooling System Description for the Repowered Vehicle

The cooling system consisted of the following components:

1. Fan and shroud assembly

2. Radiator
3. Transmission oil cooler
4. Engine oil cooler.

The general cooling system arrangement is shown in Fig. 8-9. Since a gasoline engine was used, it was desired to avoid high engine compartment temperatures that could cause vapor lock. The cooling airflow path was selected to provide airflow over the engine before entering the fan, with the cooling system pressurized.

The oblique orientation of the radiator and transmission oil cooler is due to the space constraints in the power plant compartment and was selected to provide for sufficient core area. An air-cooled transmission oil cooler was used to increase heat dissipation from the engine under operating conditions of high engine HP and high losses in the transmission system. The transmission oil cooler is located on the downstream side of the radiator. This is possible because the operating temperature of the transmission oil is higher than that of the engine coolant. A liquid-cooled engine oil cooler was chosen because of space considerations. The overall power package is shown in Fig. 8-10.

8-5.1.3.2 Cooling System Design Procedure

The system design procedure consisted of determining the following:

1. Engine coolant heat rejection:
 - a. The engine heat rejection including the engine oil heat rejection was provided by the engine manufacturer as:

Total Engine Heat Rejection Q , Btu/min		
Engine rpm	Manufacturer Test Data	Radiator Specification Design*
3800	5700	6270
2300	4150	4565

*A 10 percent safety margin was used in the design. This safety margin is considered necessary for military combat vehicles

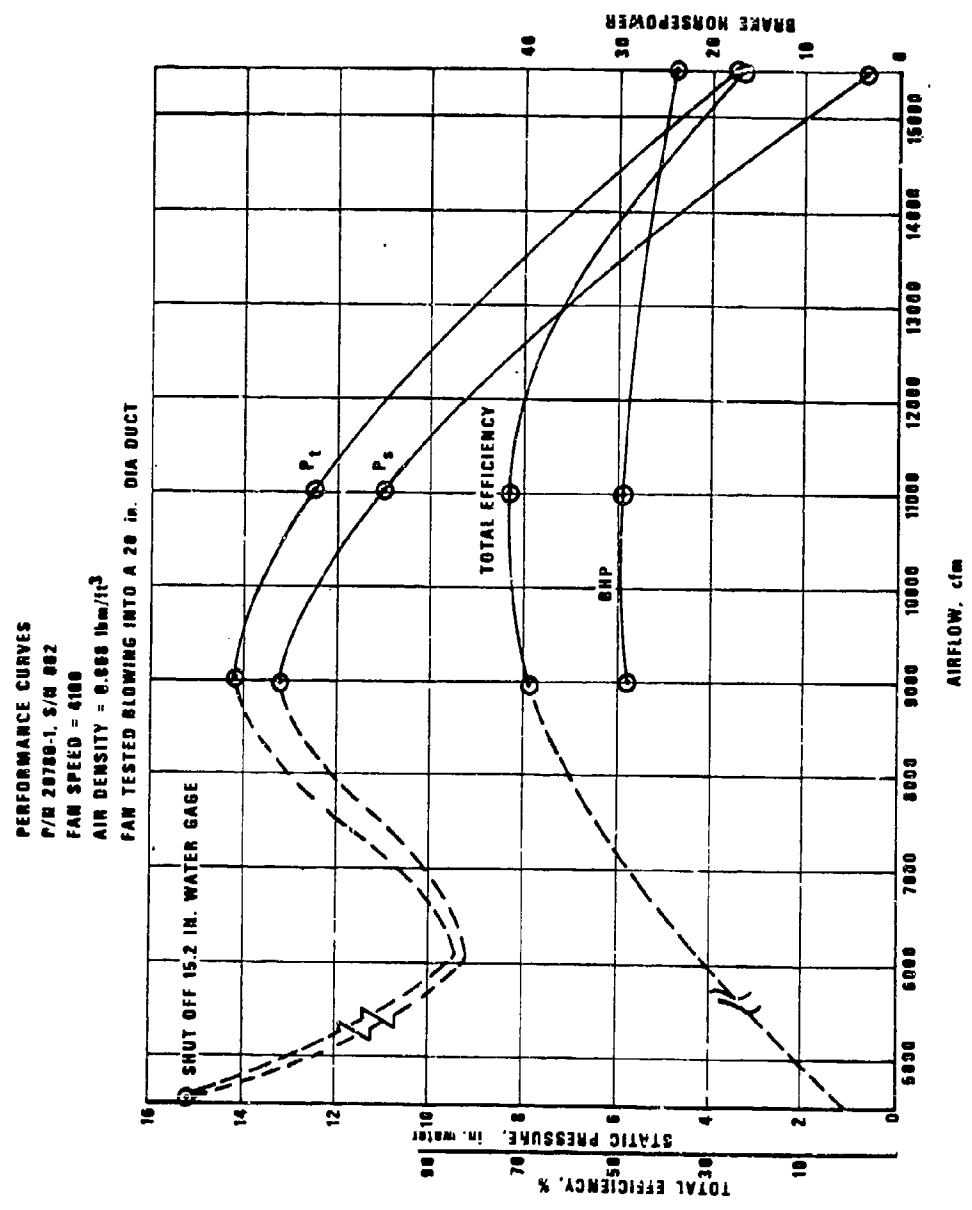

Figure 8-8. Axial Flow Fan Performance for the M114 Product Improvement Program Vehicle
 (Courtesy of Joy Manufacturing Company)

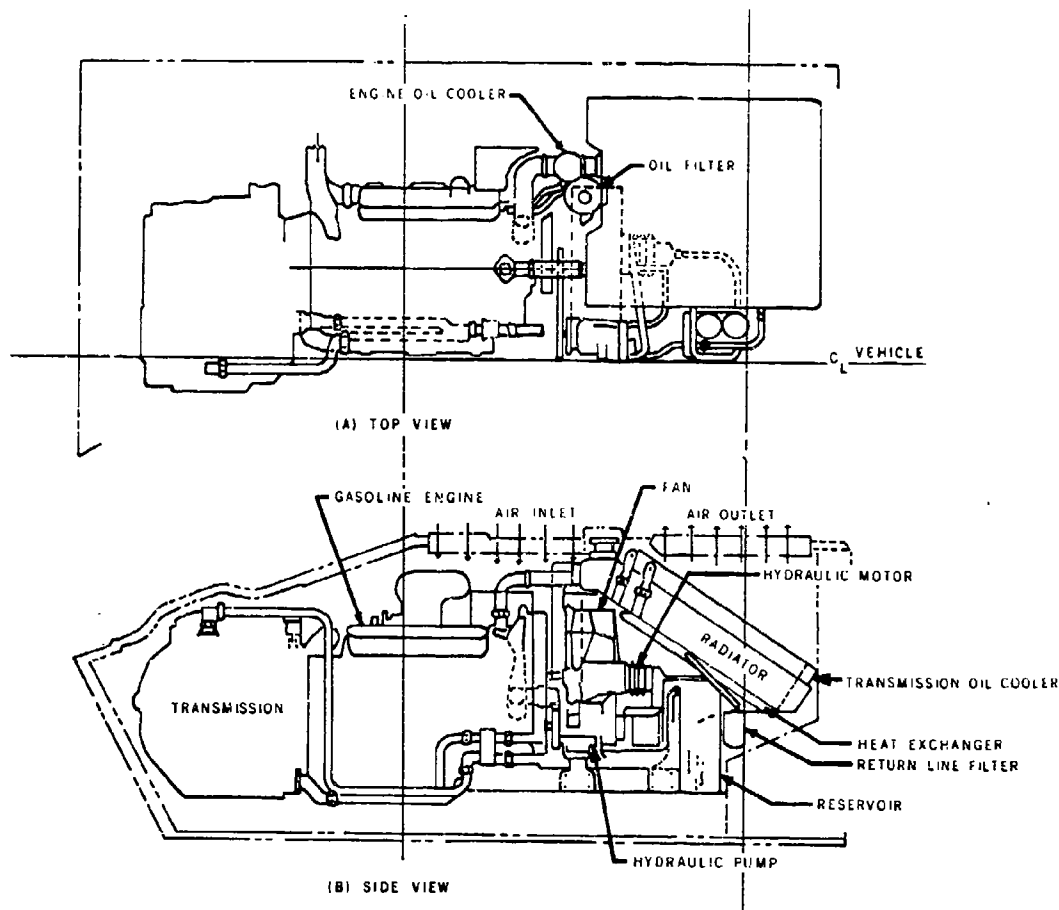

Figure 8-9. Cooling System for the M114 Product Improvement Program Vehicle

2. *Engine Compartment Temperature.* (A 15 deg F air temperature increase was assumed through the engine compartment due to air recirculation and engine heat rejection.)

Inlet Radiator Air Temperature = $125^{\circ}\text{F} + 15^{\circ}\text{F} = 140^{\circ}\text{F}$

3. *Air Static Pressure Drop.* The estimated system ΔP in inches of water is

Inlet Grille	1.5
Radiator	3.0

Transmission Oil Cooler	1.5
Exit Grille	2.0
Power Plant Compartment	<u>3.0</u>
Total	11.0 in. of water

4. *Fan Rotating Speed.* The maximum allowable engine speed is 4000 rpm. Consultation with the fan manufacturer was held to determine performance that could be predicted based on a maximum of 15 percent of the gross engine HP being used for cooling. At

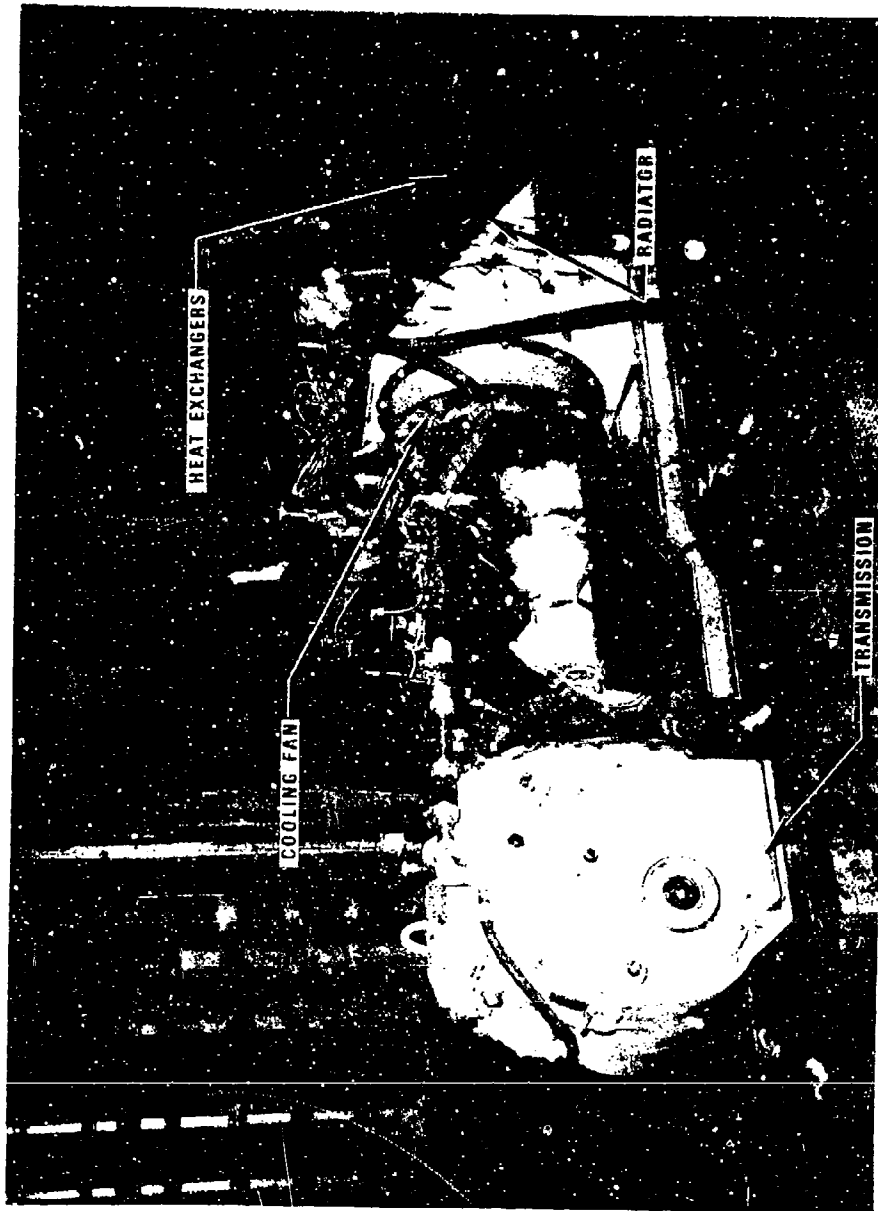

Figure 8-10. Power Package for M114 Product Improvement Program Vehicle

this value of 30 hp, it was predicted that at a 4000 rpm fan speed, a total of 11,000 cfm of air could be delivered at 11 in. of water at 0.068 lbm/ft³ air density (125°F) with a 20 in. diameter impeller and a fan width of 8 in.

It was decided that the final airflow required would be determined from tests, and adjustment made to the fan speed to give the required flow. The fan as designed met the desired performance at 4100 rpm instead of the originally predicted 4000 rpm (See Fig. 8-8). The actual engine fan operating at maximum speed for the installation was later determined to require only 3800 rpm to meet the vehicle performance requirements.

5. *Engine Oil Heat Rejection.* The engine oil heat rejection required, in accordance with data supplied by the engine manufacturer, is approximately 500 Btu/min at a maximum engine speed of 4000 rpm.

6. *Transmission Oil Cooler:*

a. The design criteria used for the transmission oil cooling was for a track slip at 0.70 tractive effort to vehicle weight ratio

b. *Transmission oil heat rejection prediction.* At the design criteria point the heat rejection was determined as follows:

$$(1) \text{ Design Tractive Effort} = 0.70 \times 16,500 = 11,550 \text{ lb}$$

(2) From Fig. 8-11 showing the relationship between vehicle speed and tractive effort, it is found that the vehicle speed at the system design point is 2.6 mph in first gear converter. From the same figure, it is found that the engine speed for third gear converter mode operation at 2.6 mph is approximately 2300 rpm (it is often necessary to conduct dynamometer testing in 3rd gear because of time limitations when operating at full power in 1st gear as well as the torque limits of the dynamometer).

(3) The transmission output speed is approximately 400 rpm for third gear converter operation at 2300 rpm engine speed (see Fig. 8-12). The transmission input and output *HP* of the system are 122 and 77 hp (Points A), respectively, at this speed.

(4) The heat rejection rate under this condition is

$$(122 - 77) \times 42.4 = 1908 \text{ Btu/min}$$

Applying a 10 percent safety margin, the minimum design heat rejection chosen was 2100 Btu/min.

(5) The transmission heat rejection at maximum engine speed and third gear lock-up occurs at a transmission output speed of 1920 rpm. The transmission input and output *HP* of the system are 167 and 144 (Points B), respectively, at this speed. The heat rejection rate under this condition is

$$(167 - 144) \times 42.4 = 975 \text{ Btu/min}$$

Applying a 10 percent safety margin, the design heat rejection rate chosen was 1073 Btu/min.

8-5.1.3.3 Determination of Radiator Size

The following parameters are given for the radiator:

Heat rejection required = 6270 Btu/min (at 3800 engine rpm this includes 10% safety margin)

The core face area available (from design) is:

29.36 in. wide \times 29 in. long in the coolant flow dimension = 5.9 ft² of core face area

Inlet water temperature = 220°F

Inlet air temperature = 140°F

AMCP706-361

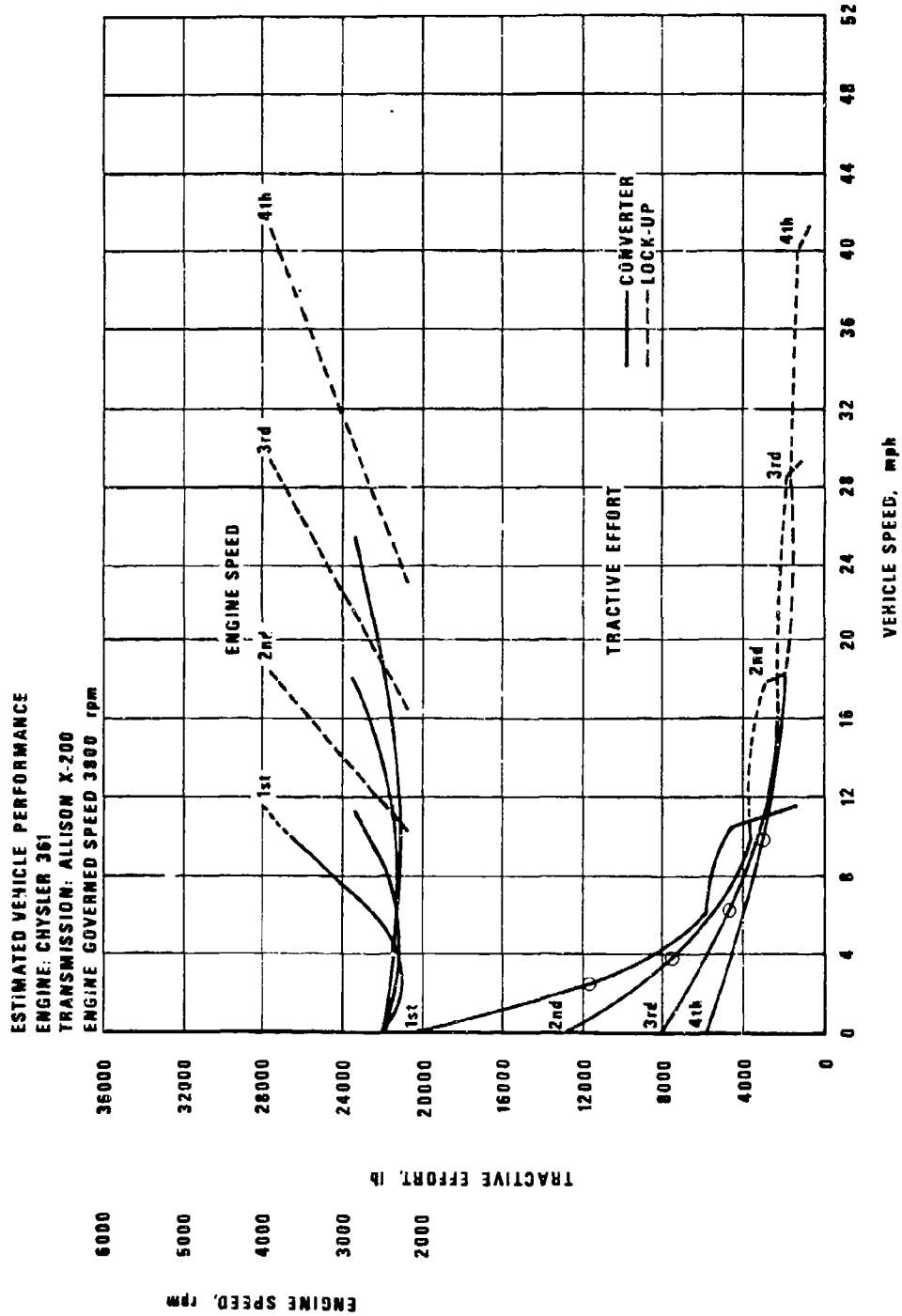

Figure 8-11. Tractive Effort/Vehicle Speed Prediction for the M114 Product Improvement Program Vehicle
 (Courtesy of Detroit Diesel Allison Division General Motors Corporation)

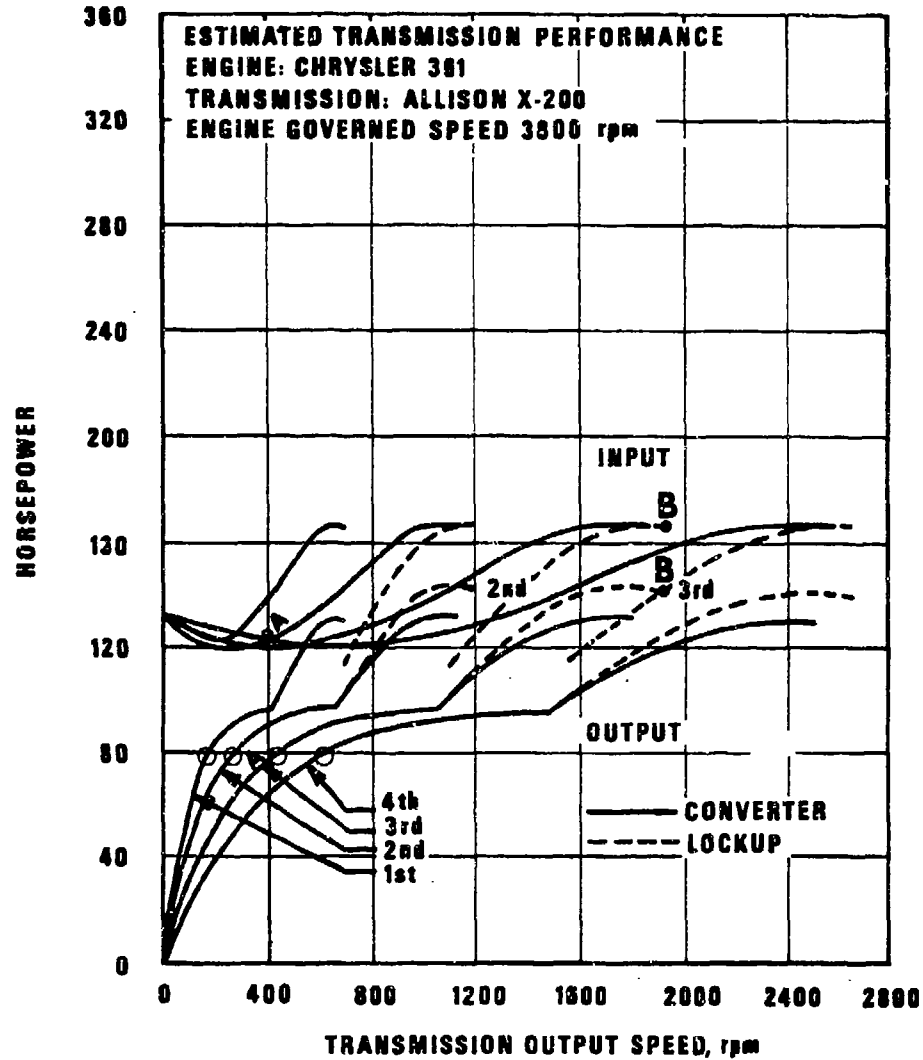

Figure 8-12. Horsepower/Transmission Output Speed Prediction for the M114 Product Improvement Program Vehicle
 (Courtesy of Detroit Diesel Allison Division General Motors Corporation)

Step 1. Determination of ITD:

Assume a 10 deg F reserve for system degradation

$$ITD = 220 - 140 - 10 = 70 \text{ deg F}$$

Step 2. Determine the unit core heat transfer capability K to meet the required heat rejection:

$$K = \frac{6270 \text{ Btu/min}}{5.9 \text{ ft}^2 \times 70^\circ\text{F}} = 15.2 \text{ Btu/min-ft}^2 \cdot ^\circ\text{F ITD}$$

AMCP 706-381

Step 3. Estimation of airflow available:

The fan tested performance (see Fig. 8-8) is

$$CFM = 11,000 \text{ cfm at } 4100 \text{ rpm}$$

$$\Delta P = 11 \text{ in. of water}$$

$$\rho = 0.068 \text{ lbm/ft}^3 \text{ air density at } 125^\circ\text{F}$$

The maximum engine operating speed is 3800 rpm. The fan performance at 3800 rpm is determined by the fan laws:

$$CFM = \frac{3800}{4100} \times 11,000 = 10,195 \text{ cfm}$$

$$\Delta P = \left(\frac{3800}{4100}\right)^2 \left(\frac{0.075}{0.068}\right) \times 11.0$$

= 10.4 in. of water (varies as the square of fan speed and directly with density)

$$\rho = 0.068 \text{ lbm/ft}^3 \text{ air density at } 125^\circ\text{F}$$

$$RPM = 3800 \text{ rpm engine speed}$$

The CFM of airflow converted to standard air density of 0.075 lbm/ft³ at 70°F for constant air mass flow rate is

$$CFM = \frac{0.068}{0.075} \times 10195 = 9243 \text{ cfm}$$

The face velocity of the air stream in front of the radiator core is

$$\frac{9243}{5.9} = 1567 \text{ ft/min}$$

Step 4. The McCord wavy fin, 11 fins/in., 8 row tube heat exchanger core was chosen. The K for a 12 in. X 12 in. base core and for a coolant velocity of 7 gpm per row of tubes

per 12 in. width core is 21.5 Btu/min-ft²-°F ITD (From Fig. 8-13) based on a face velocity of 1567 ft/min. The coolant velocity was calculated to be 1.37 ft/sec with one pass on the coolant side. To decrease scale formation on the tube surface, it generally is recommended that the coolant velocity in the radiator core be about 2 to 3 ft/sec minimum. Therefore, a two-pass arrangement was used on the coolant side.

Step 5. The equation for the unit core heat transfer capability K_c required to meet the required heat rejection is

$$K_c = K_c F_1 F_2 F_3, \text{ Btu/min-ft}^2\text{-}^\circ\text{F ITD} \quad (8-11)$$

where

K_c = unit core heat transfer capability (available), Btu/min-ft²-°F ITD

K_c = unit core heat transfer capability (base core), Btu/min-ft²-°F ITD

F_1 = correction factor due to deviation of coolant velocity from reference value, dimensionless (see Fig. A-38)

F_2 = correction factor due to deviation of coolant tube length from reference value, dimensionless (see Fig. 3-12)

F_3 = correction factor due to nonuniform air distribution for this system configuration, dimensionless (estimate based on system design)

The fan exit and radiator inlet are offset in all three major axes. A special guide vane assembly was used as shown in Fig. 8-14 to improve the airflow distribution.

where

$$F_1 = 1.01$$

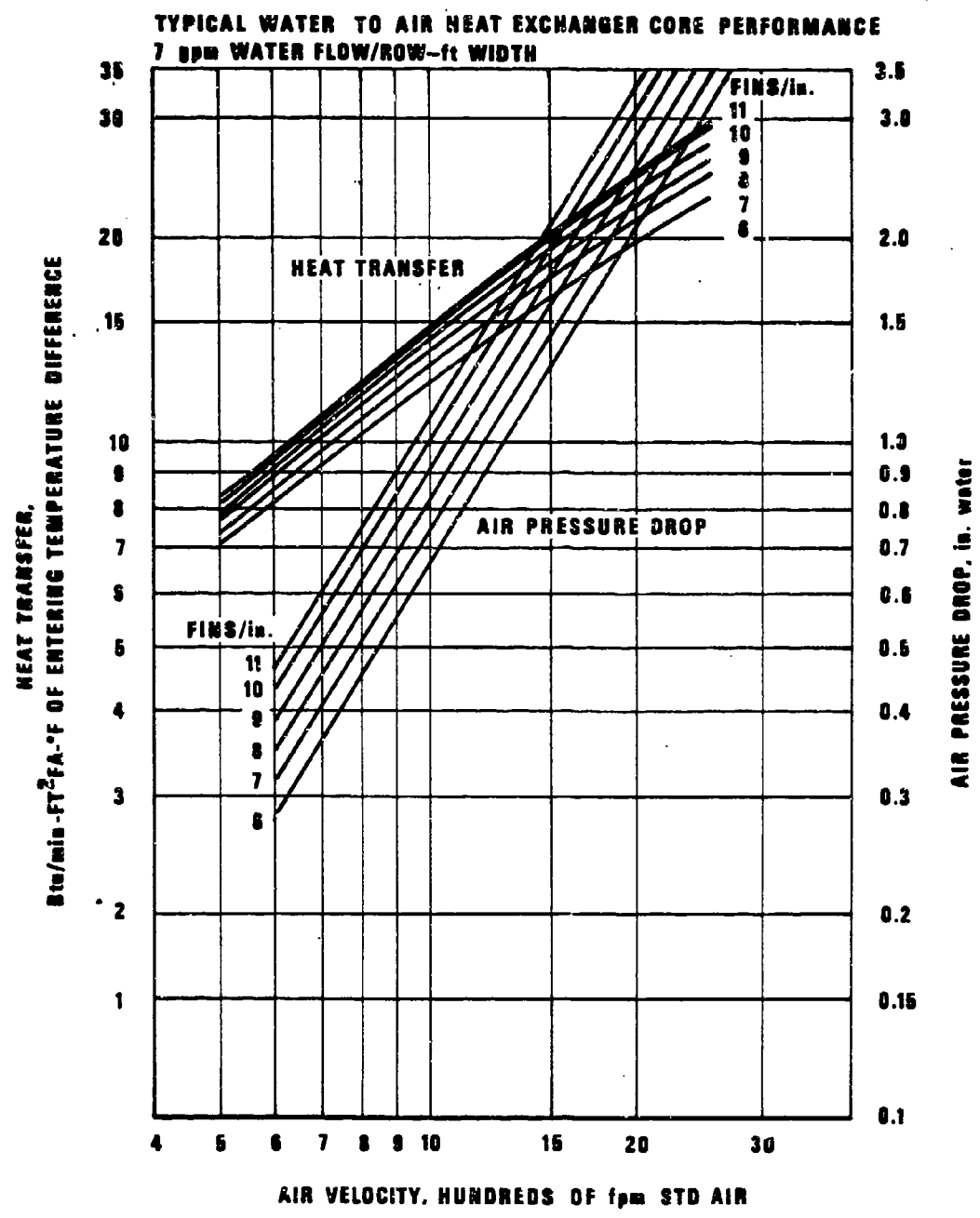

Figure 8-13. Radiator Core Performance Characteristics
 (Courtesy of McCord Corporation)

AMCP 706-361

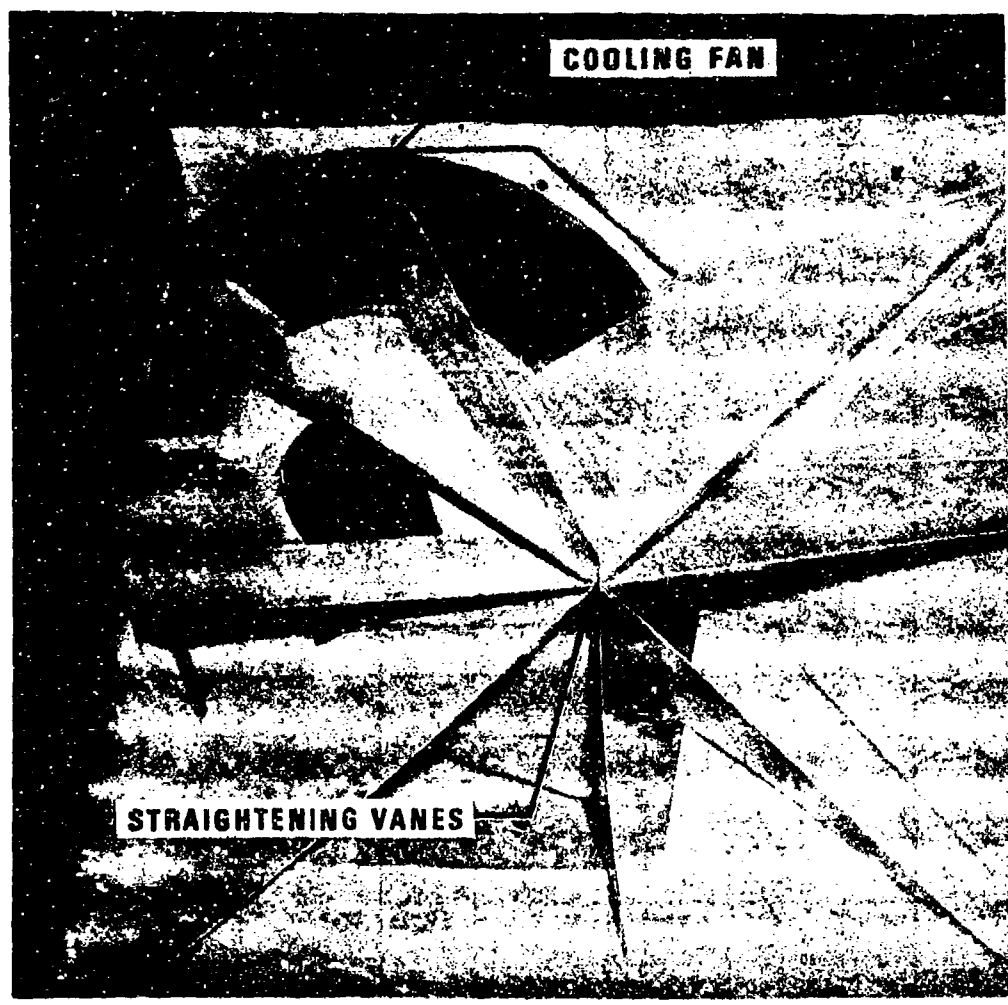

Figure 8-14. Guide Vane Assembly for M114 Product Improvement Program Vehicle

$$F_2 = 0.9$$

$$F_3 = 0.85$$

Using Eq. 8-11 the unit core heat capability K_c (available) is found to be

$$K_c = 21.5 \times 1.01 \times 0.90 \times 0.85$$

$$= 16.6 \text{ Btu/min-}^\circ\text{F ITD}$$

Step 6. To check radiator performance at

the 0.70 tractive effort point, the previous calculation is repeated:

1. At the track slip point, the engine RPM and the coolant heat rejection rate are 2300 rpm and 4565 Btu/min, respectively.

2. The airflow rate available at 3800 rpm is

$$CFM = \frac{9243 \text{ cfm} \times 2300 \text{ rpm}}{3800 \text{ rpm}}$$

$$= \frac{2300}{3800} \times 9243 = 5594 \text{ cfm}$$

3. The unit core heat transfer capability required K_r is

$$K_r = \frac{4565}{5.9 \times 70} = 11.1 \text{ Btu/min-ft}^2\text{-core-}^\circ\text{F ITL}$$

4. The face velocity of the air stream in front of the radiator for constant air mass flow rate at standard condition is

$$\frac{5594}{5.9} = 948 \text{ ft/min}$$

5. From the core performance data the unit core heat transfer capability K of the basic core is 14.3 Btu/min- $^\circ\text{F}$ ITD (Fig. 8-13). The correction factors are:

$$F_1 = 0.95$$

$$F_2 = 0.90$$

$$F_3 = 0.85$$

Therefore

$$K_a = 14.3 \times 0.95 \times 0.90 \times 0.85 \\ = 10.4 \text{ Btu/min-}^\circ\text{F ITD}$$

6. This indicates that cooling conditions at the 0.70 tractive effort point are more severe than those at the maximum engine speed point. At this point the design effort was terminated and cooling mock-up tests were started to determine the overall adequacy of the system.

8-5.1.3.4 Determination of Engine Oil Cooler Size

The following parameters are given for the engine oil cooler given the required heat rejection of 6270 Btu/min:

500 Btu/min heat rejection rate at 3800 engine rpm

605 lbm/min coolant flow rate (assume $C_p = 1$)

4 gpm oil flow rate

Inlet oil temperature is 250 $^\circ\text{F}$.

Step 1. Exit coolant temperature from the radiator is

$$220 - \frac{6270}{1.0 \times 605} = 209.6^\circ\text{F}$$

Step 2. The *ITD* between the inlet engine oil temperature and the inlet coolant temperature is

$$250 - 209.6 = 40.4 \text{ deg F}$$

Step 3. The unit core heat transfer capability required K_r is

$$K_r = \frac{500}{40.4} = 12.4 \text{ Btu/min-}^\circ\text{F ITD}$$

Step 4. From the performance curves, it is found that the McCord No. 7 oil-cooler unit is about adequate as shown in Fig. 8-15(A). The unit has 11.9 Btu/min-ft 2 - $^\circ\text{F}$ ITD at 4.0 gpm of oil flow.

8-5.1.3.5 Determination of Transmission Oil Cooler Size

The following parameters are given for the transmission oil cooler:

22 gpm oil flow rate

Inlet oil temperature = 300 $^\circ\text{F}$

2100 Btu/min heat rejection rate at 2300 engine rpm

The following approximations indicate:

1. Airflow at 2300 rpm engine speed

AMCP 706-361

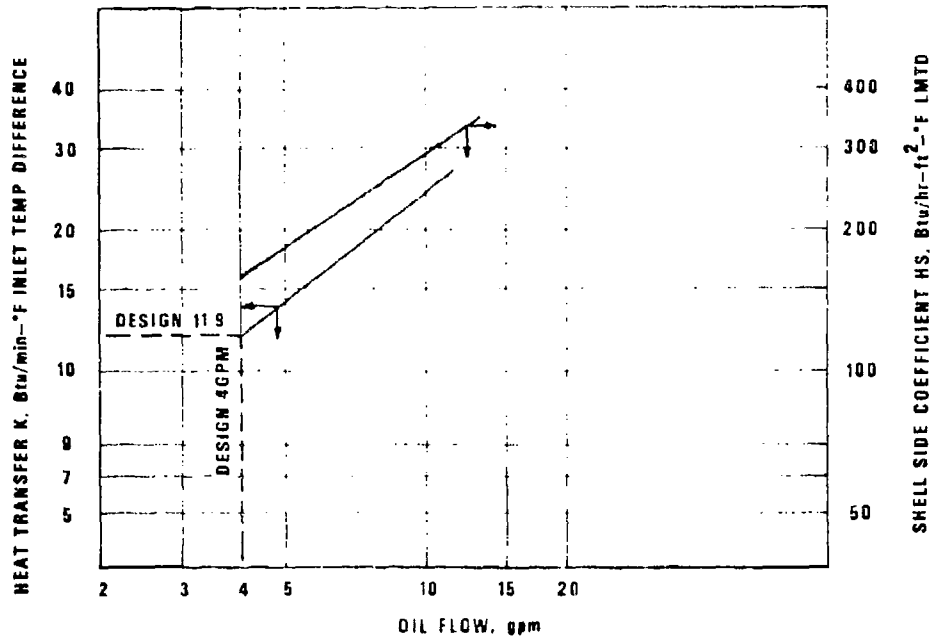

(A) HEAT TRANSFER CHARACTERISTICS

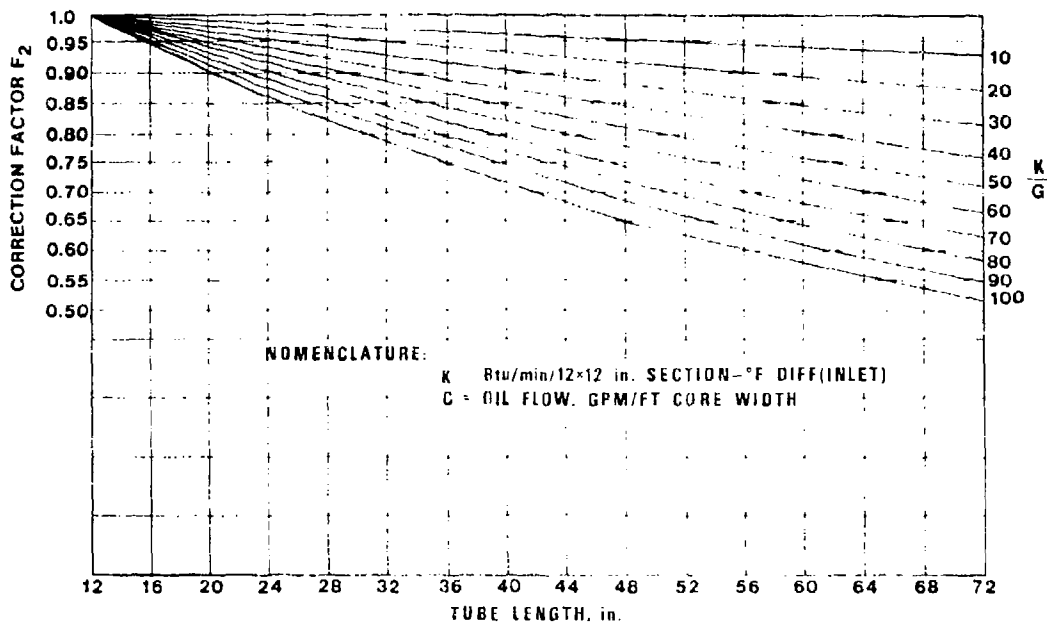

(B) CORRECTION FACTOR FOR VARIOUS TUBE LENGTH

Figure 8-15. Oil cooler Heat Transfer Characteristics and Correction Factors for Various Tube Lengths (Courtesy of McCord Corporation)

$$CFM = \frac{2300}{4100} \times 11,000 = 6171 \text{ cfm}$$

2. Airflow rate per ft² core frontal area

$$\frac{6171}{5.9} = 1046 \text{ ft/min}$$

3. The exit air temperature from radiator or the inlet air temperature to the transmission oil cooler is (using the previously calculated available air flow of 5594 cfm, and given 4565 Btu/min heat rejection rate)

$$140 + \frac{4565}{5594 \times 0.068 \times 0.24} = 190^\circ\text{F}$$

The unit core heat transfer capability required K_r is

$$K_r = \frac{2100}{5.9 (300 - 190)}$$

$$= 3.24 \text{ Btu/min-ft}^2\text{-}^\circ\text{F ITD}$$

From par. 8-5.1.3.3, Step 6, the equivalent air velocity in front of the core at standard condition is 948 ft/min. The equivalent oil flow rate per 12 in. width core is 22 gpm (30/12) = 8.8 gpm.

From Fig. 8-16, the base core heat transfer capability K_c is 5.5 Btu/min-ft²-°F ITD.

4. From Eq. 8-11

$$K_a = K_c F_1 F_2 F_3 \text{ Btu/min-ft}^2\text{-}^\circ\text{F ITL}$$

Here

$$K_c = 5.5 \text{ Btu/min-ft}^2\text{-}^\circ\text{F ITD}$$

$$F_1 = 1.00 \text{ (NOTE: No oil velocity correction is needed because Fig. 8-16 uses oil velocity as a parameter)}$$

$$F_2 = 0.89 \text{ (Fig. 8-15(B))}$$

$$F_3 = 0.85 \text{ (estimated)}$$

$$\text{Thus, } K_a = 5.5 \times 1.00 \times 0.89 \times 0.85 = 4.2 \text{ Btu/min-ft}^2\text{-}^\circ\text{F ITD}$$

The design is therefore acceptable.

8-5.1.3.6 Cooling System Mock-up Tests

An overall power plant and cooling system hot mock-up test was conducted on the M114 Prc luct Improvement Program (PIP) power plant at the Propulsion Systems Division of USATACOM (Ref. 7). The results of this test are contained in Figs. 8-17 through 8-20.

A summary chart comparing the design specifications to actual results is included in Table 8-3. It can be observed that the overall cooling system proved adequate to meet the requirements.

8-5.1.3.7 M114 Product Improvement Program Hydrostatic Fan Drive

It was desired to have a thermostatically controlled fan drive system available for the M114 Product Improvement Program Vehicle, in addition to the standard fan belt drive. A fan drive system was designed as an optional system. The pump for the hydrostatic drive is mounted to the side but was located so that the same fan belt length could be used either for the fan belt drive or to drive the pump with the hydrostatic drive. The hydraulic motor drive was located to drive the fan from opposite the pulley end (see Fig. 8-9).

This fan drive system was developed by the Vickers Corporation based on use of standard pump and motor hardware for operation up to 4000 rpm at hydraulic fluid pressure up to 4000 psi. This system was not tested in the mock up. The benefit to be derived from using a thermostatically controlled hydrostatic drive system is operation of the main power system components of the engine and transmission at more ideal temperatures under cold climatic conditions, especially at part

AMCP 706-361

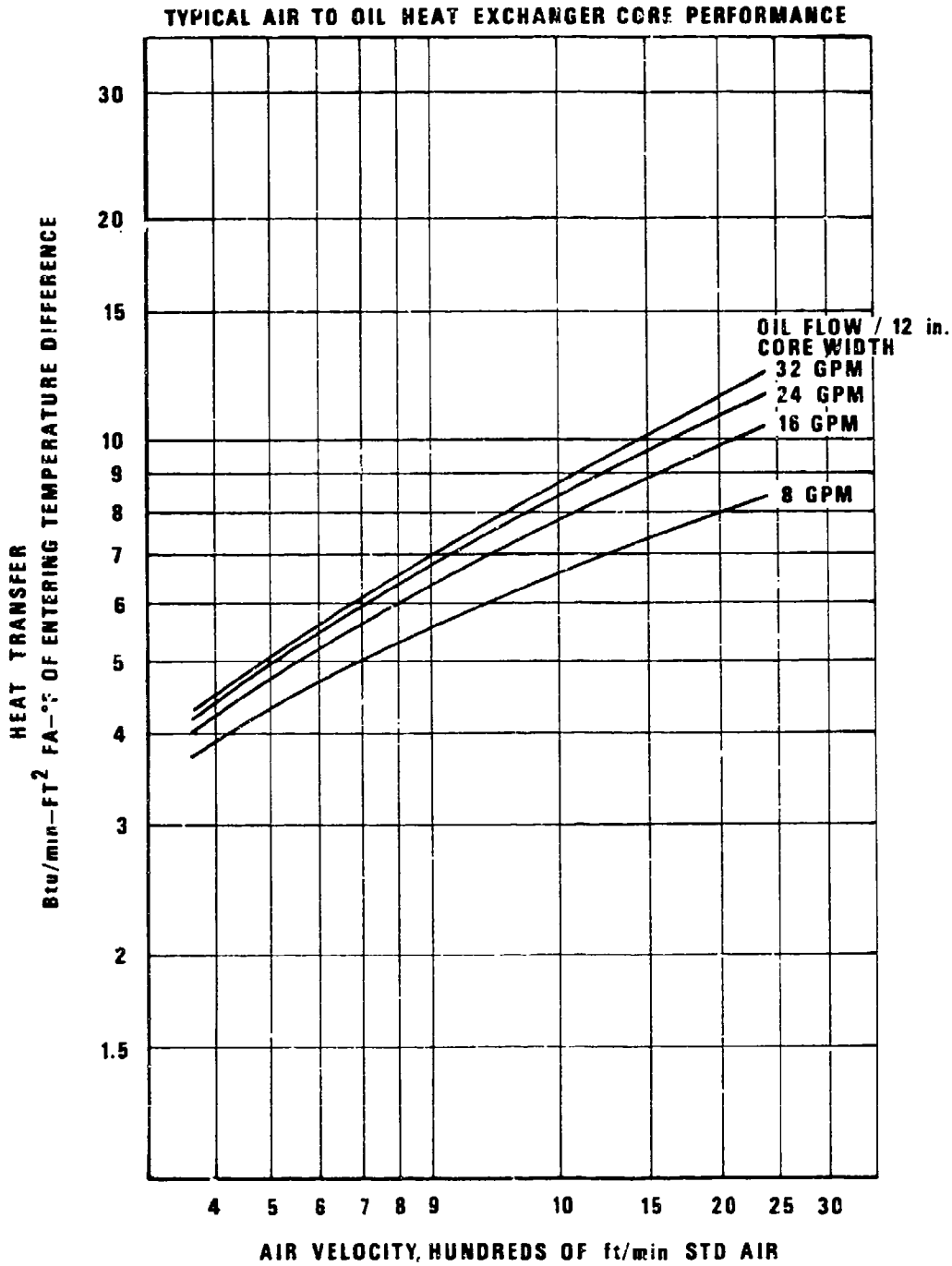

Figure 8-16. Transmission Oil Cooler Performance Characteristics
(Courtesy of McCord Corporation)

TEST CONDITIONS :

- 1. CELL AMBIENT = 120°F
- 2. FUEL = GASOLINE, MIL-G-46015
- 3. WIND VELOCITY = 5 mph
- 4. ENGINE LOAD = FULL
- 5. TRANS GEAR RANGE = 3rd

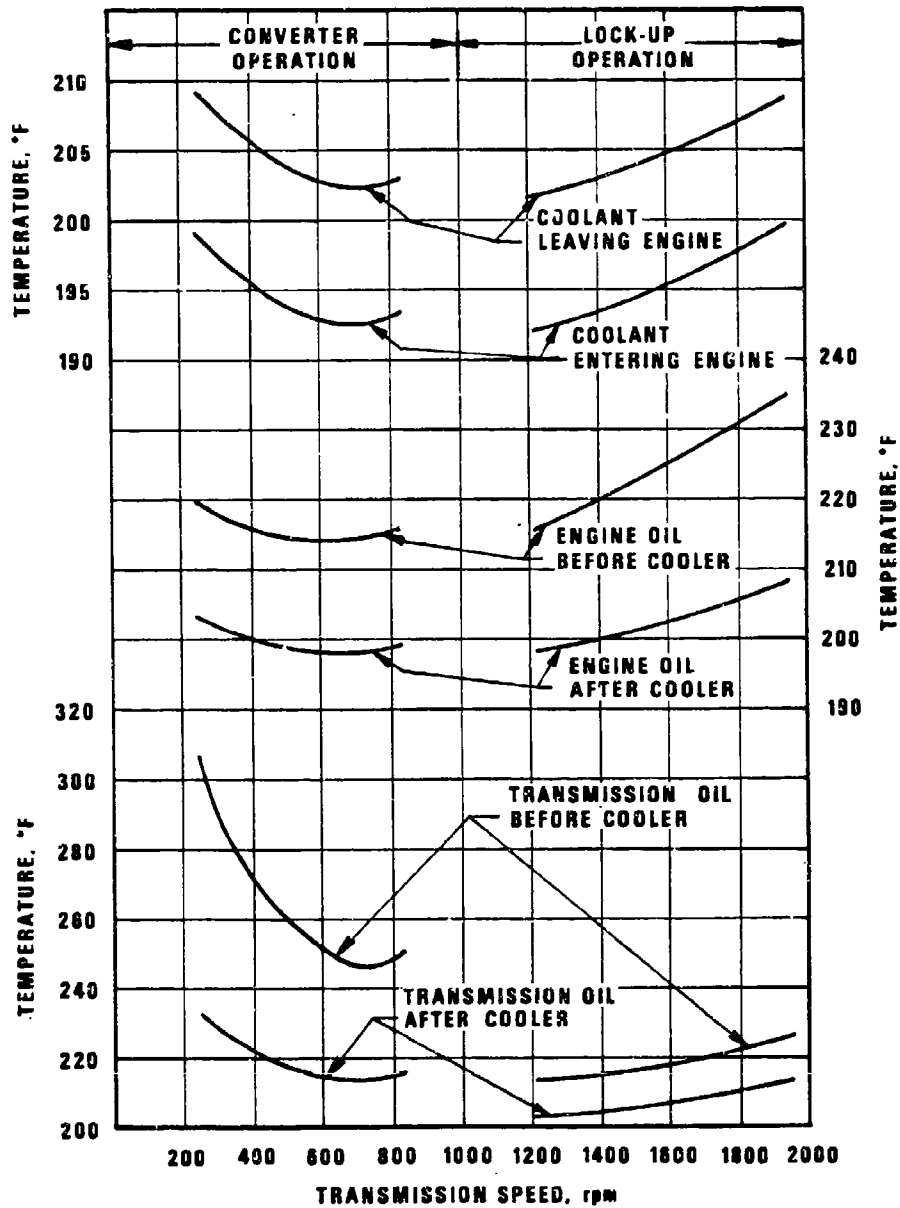

Figure 8-17. M114 Product Improvement Program Vehicle Full Load Cooling Test Results - Transmission Speed vs Temperature

AMCP 706-361

- TEST CONDITIONS:**
- 1. CELL AMBIENT = 120°F
 - 2. FUEL = GASOLINE, MIL-G-46015
 - 3. WIND VELOCITY = 5 mph
 - 4. ENGINE LOAD = FULL
 - 5. TRANS GEAR RANGE = 3rd

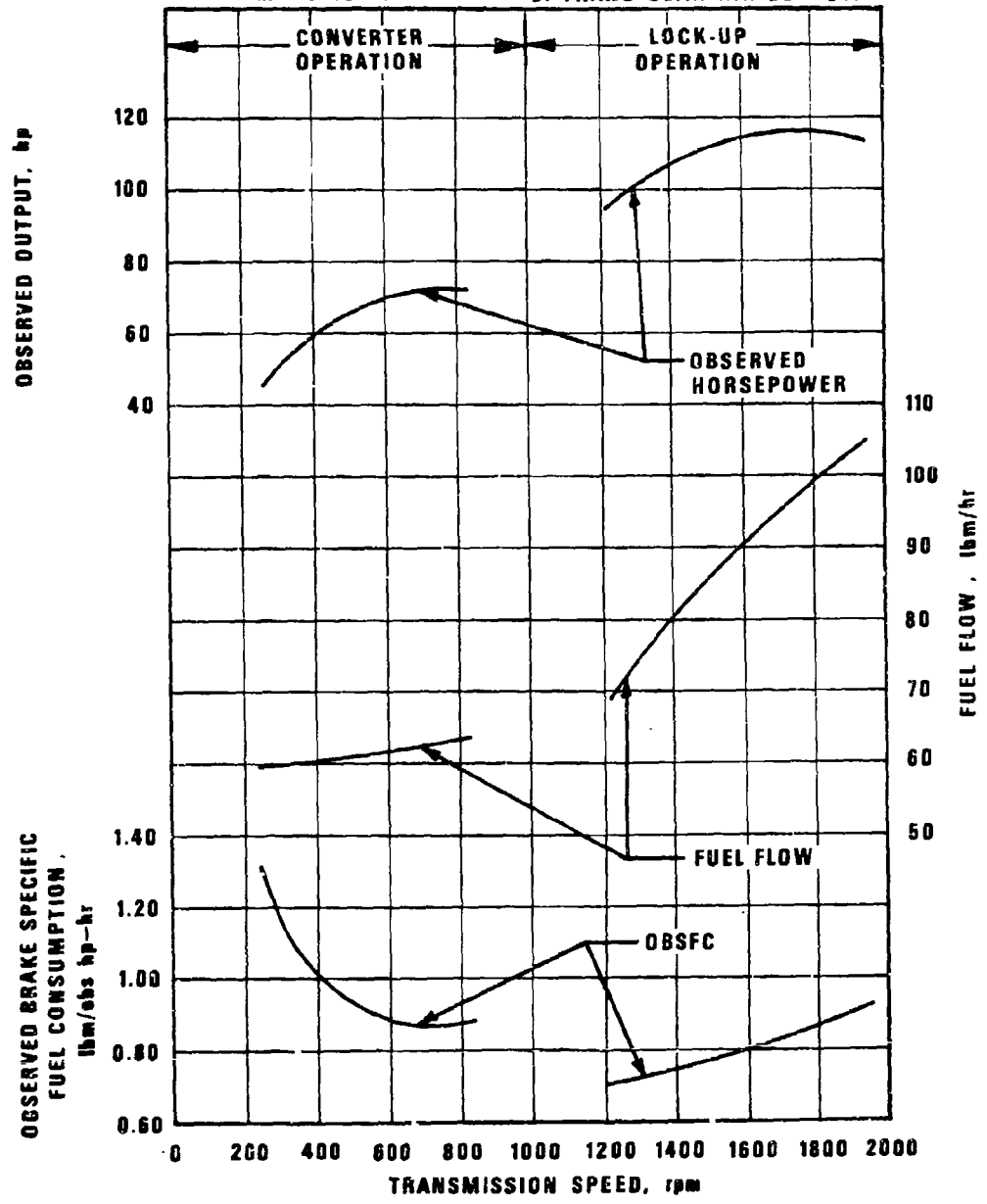

Figure 8-18. M114 Product Improvement Program Vehicle Full Load Cooling Test Results - Transmission Speed vs Horsepower and Specific Fuel Consumption

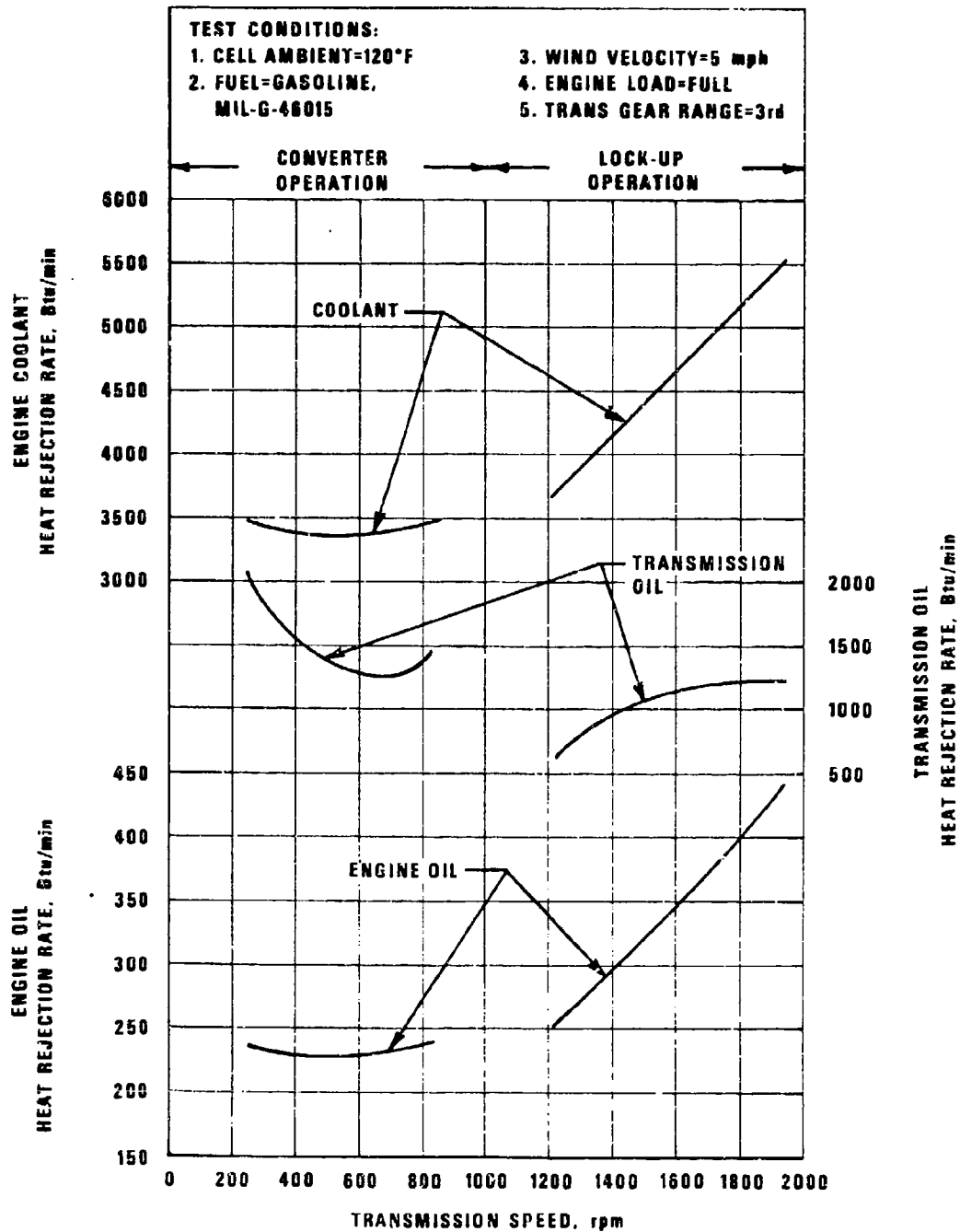

Figure 8-19. M114 Product Improvement Program Vehicle Full Load Cooling Test Results – Transmission Speed vs Heat Rejection Rate

AMCP 706-361

- TEST CONDITIONS:**
1. CELL AMBIENT= 120°F
 2. FUEL= GASOLINE, MIL-G-46015
 3. WIND VELOCITY= 5 mph
 4. ENGINE LOAD= FULL
 5. TRANS GEAR RANGE= 3rd

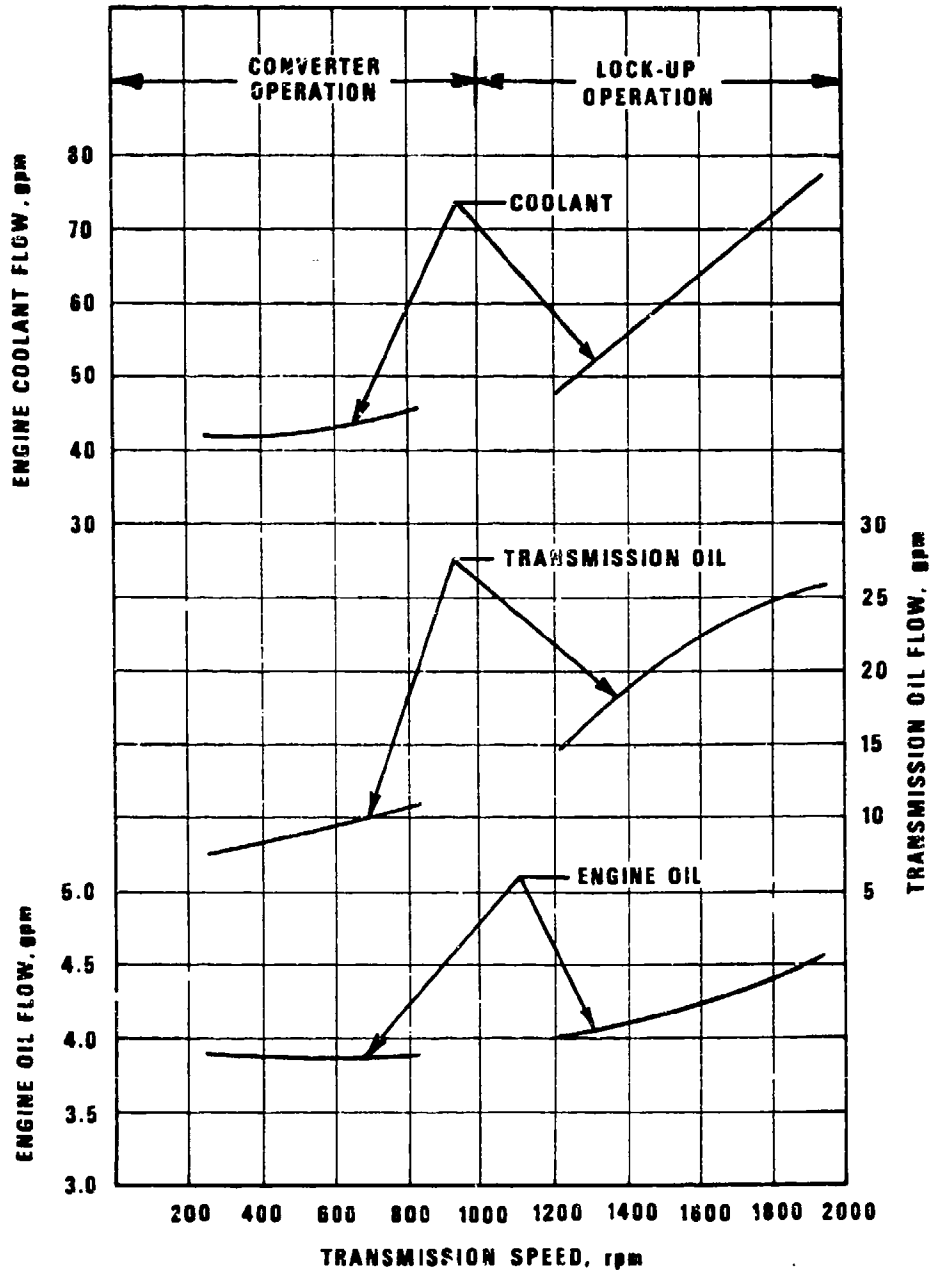

Figure 8-20. M114 Product Improvement Program Vehicle Full Load Cooling Test Results – Transmission Speed vs Coolant Flow

TABLE 8-3
DESIGN OF EXPERIMENTAL POWER PLANT INSTALLATION AND COOLING SYSTEM FOR THE M114 VEHICLE

Conditions	Engine RPM	Radiator		Engine		Oil-Cooler	
		SPEC.	ACTUAL	SPEC.	ACTUAL	SPEC.	ACTUAL
Heat Rejection, Btu/min	3800 ⁴ 2300 ³ 2100 ⁶	6270 ¹ 4565 ¹	5523 ² 3755 ²	500 500	441 240	975 1908	1221 1746
Maximum Water Inlet Temperature, °F	3800 ⁴ 2300 ³	220 220	209 204	208	200		
Water Flow, lbm/min	3800 ⁴ 2300 ³	605 431	616 436				
Airflow Rate, cfm	3800 ⁴	10195 ⁵	8702 ⁵				
Maximum Air Inlet Temperature, °F	3800 ⁴ 2300 ³	150 150	156 150				
Air Density, lbm/ft ³	3800 ⁴	0.0680	0.0645				
Maximum Oil Inlet Temperature, °F	3800 ⁴ 2100 ⁶			250	235	300 300	227 227
Oil Flow Rate, gpm	3800 ⁴ 2300 ³			4.0	4.5	35.0 22.0	25.5 10.9

¹Includes a 10 percent reserve
²Lock-up operation
³0.7 converter speed (max torque)
⁴1:1 engine to fan speed ratio
⁵0.3 converter speed

CALCULATION FOR AIRFLOW RATE - From Eqs. D-2 and D-3 the heat balance for the airflow is: $[wC_p\Delta T]_a = [wC_p\Delta T]_w$
 Therefore: $w = 1 \text{ lbm/min} \times 0.24 \text{ Btu/lbm-}^\circ\text{F} \times 41^\circ\text{F} = 76.9 \text{ gal/min} \times 8.0 \text{ lbm/gal} \times 1 \text{ Btu/lbm-}^\circ\text{F} \times 8.97^\circ\text{F}$

$w = 560.8 \text{ lbm/min}$

The volume airflow rate CFM is: $w/\rho = [560.8 \text{ lbm/min}]/[0.0645 \text{ lbm/ft}^3] = 8695 \text{ cfm}$

AMC[®] 706-381

throttle operation. Fan drive horsepower also is reduced, providing fuel savings in addition to faster vehicle acceleration.

Operation at steady state, under desert climatic conditions at full load, requires higher fan drive horsepower. The maximum hydraulic drive efficiency attained on bench tests was 67 percent.

8-5.2 XM803 EXPERIMENTAL TANK WITH AIR-COOLED DIESEL ENGINE (Ref. 3)

The XM803 Experimental Tank is used as an example because considerable effort has been spent by USATACOM in the design and evaluation of the cooling system for the vehicle. This vehicle incorporated the AVCR-1100-3B engine rated at 1250 bhp at standard conditions, and the XHM-1500 hydrostatic transmission. The XM803 Experimental Tank power plant is shown in Fig. 1-18.

Selection of the components to be individually evaluated is determined by their installation and analysis of their heat rejection modes. For example, the heat rejected by the fuel injection pump is dissipated by a fuel cooler installed ahead of one of the transmission cooler fans. In this instance, the fuel tanks are no longer a heat sink for the heated fuel and can be ignored in the cooling system analyses. Conversely, the vehicle final drive efficiency is considered in the transmission efficiency for vehicle performance analysis.

The AVCR-1100-3B engine is equipped with individual cylinders that are air-cooled by two axial flow fans mounted in the vee of the engine as shown in Fig. 1-19. Engine oil cooling is provided by two coolers mounted one on each side. The engine induction air from the supercharger is cooled similarly by two aftercoolers. The cooling air is drawn through the cylinder fin spacings and the coolers in parallel paths, and is discharged vertically through the two fans. When

installed in the XM803 Experimental Tank, the discharge air enters a low silhouette exit duct, is directed rearward, and flows out of the exit grilles at the rear of the vehicle.

The air flowing through the oil-coolers and aftercoolers also flows over the top of the cylinders and across the exhaust manifold before entering the suction side of the fan. This path offers a flow restriction resulting in a pressure drop across the cooler somewhat less than that available for the cylinders; as will be brought out in the discussion that follows. Fig. 8-35 shows the cooling system performance diagram.

To conduct this analysis, it has been necessary to use existing data as much as practical to predict the cooling characteristics of the engine as it is installed in the XM803 Experimental Tank (Ref. No. 3). Along with these data, certain assumptions have been made in order to complete this analysis. These assumptions are:

1. Full throttle engine horsepower output will vary as a function of engine induction air temperature and pressure, and fuel temperature as determined by correction factor tests conducted on an AVCR-1100-3B engine. In actual vehicle operation, induction air temperatures are often 15 to 50 deg F above ambient. Fuel temperatures depend on the length of time the vehicle is operated. These correction factors are:

- a. 1% reduction per 10 deg F induction air temperature above 70°F
- b. 1.3% decrease per in. Hg induction air pressure below 29.92 in. Hg
- c. 1.5% decrease per 10 deg F fuel temperature above 70°F.

2. Cooling and induction inlet air temperature will be 10 deg F above ambient temperature (this allows for an air temperature rise in the vehicle due to radiation and recirculation).

3. Fuel temperature will be 30 deg F above ambient temperature (this assumes the use of a fuel cooler).

4. Cooling fan horsepower varies as the cube of its *RPM* and as the first power of the air density.

5. Cooling fan pressure rise and the air static pressure drop through any portion of the flow system varies as the square of the fan *RPM*.

6. The engine power rating is 1250 bhp using DF-2 fuel at the following conditions:

- a. 60°F fuel supply temperature
- b. 60°F engine induction air inlet temperature
- c. 29.92 in. Hg (dry) induction air inlet pressure.

8-5.2.1 Engine Cooling

8-5.2.1.1 Engine Cylinder Heat Rejection

The engine cylinder cooling characteristics have been determined as a function of engine fuel flow rate, cylinder air pressure drop and operating temperatures, cooling airflow rate, and heat rejection rate. Empirical formulas have been developed for this engine from experimental data that established these relationships for predicting operation temperatures in the installation. The method, employing these formulas, is presented.

The heat rejected Q_c from the cylinder is

$$Q_c = w_c C_p (T_2 - T_1), \text{ Btu/min-cyl} \quad (8-12)$$

where

C_p = specific heat of air at constant pressure, Btu/lbm°F (0.24 Btu/lbm-°F)

T_1 = temperature of the cooling air before the cylinder (assumed to be 10 deg F above the ambient temperature), °F

T_2 = temperature of the cooling air leaving cylinder, °F

w_c = cooling airflow rate, lbm/min-cyl

The cooling airflow rate w_c was obtained from test results as shown in Fig. 8-21 where flow rate is plotted vs pressure drop ΔP_s for a single cylinder. The cooling air outlet temperature was obtained from a cylinder head temperature survey test as summarized in Table 8-4. The results are from a single cylinder test engine running at an equivalent rating of 1475 bhp. These results also supply the basis for the cylinder temperature correction vs cooling air pressure drop across the cylinder.

The heat picked up by the cooling air Q_c as given in Eq. 8-12 is transferred from the cylinder at a rate of

$$Q_c = U_c \left[(T_c - T_1) - \frac{\Delta T_a}{2} \right], \text{ Btu/min-cyl} \quad (8-13)$$

where

U_c = overall heat transfer coefficient between the cylinder surface and the cooling air (including the geometry, area, and air velocity distribution), based on the arithmetic mean temperature difference, Btu/min-°F-cyl

T_c = external cylinder surface temperature obtained from thermocouple readings at a standard location (below the exhaust port in the aluminum and near the combustion chamber surface), °F

ΔT_a = $(T_2 - T_1)$, rise in cooling air temperature, deg F

AMCP 708-361

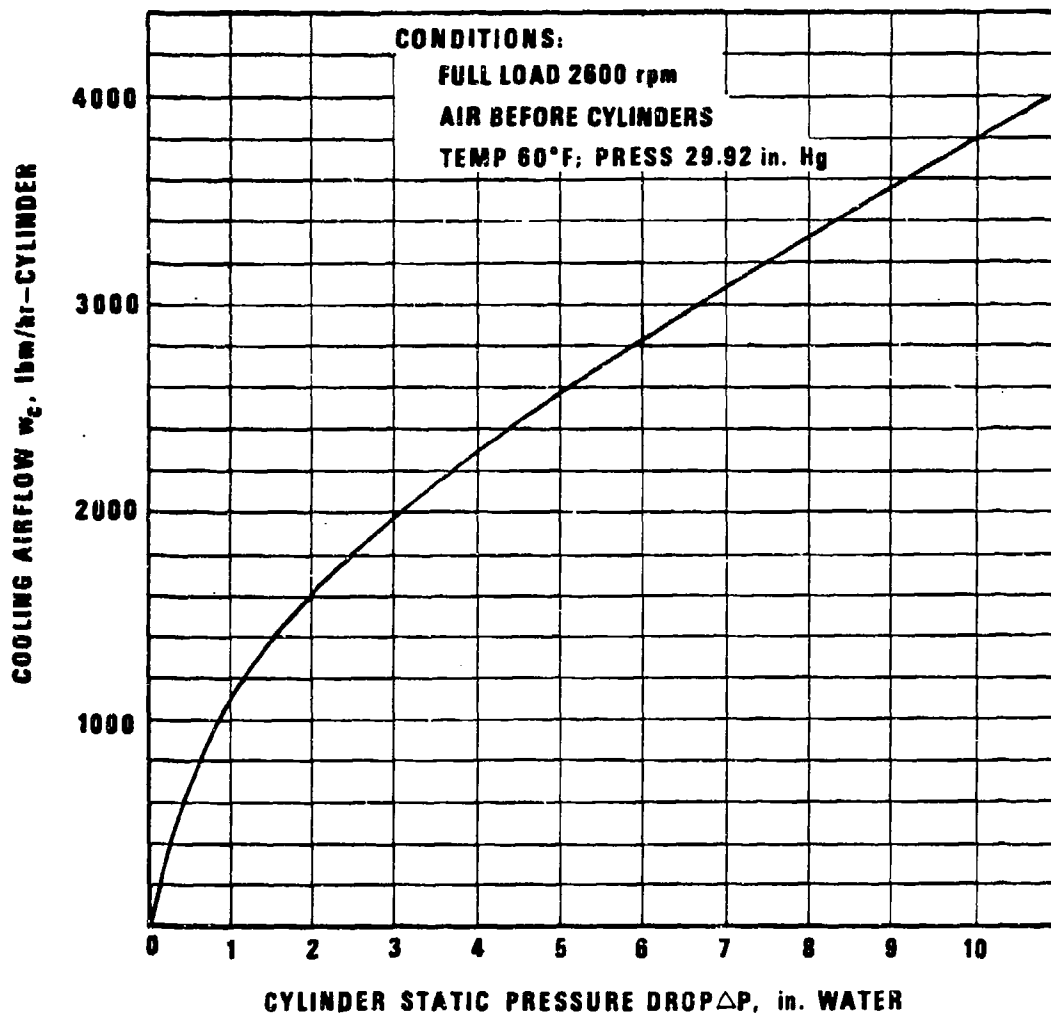

Figure 8-21. AVCR-1100-3B Cylinder Cooling Airflow

U_c is now determined by setting Eq. 8-12 equal to Eq. 8-13, i.e.,

$$U_c = \frac{w_c C_p \Delta T_a}{(T_c - T_1) - \frac{\Delta T_a}{2}}, \text{ Btu/min-}^\circ\text{F-cyl} \quad (8-14)$$

and, by applying available experimental results, an empirical formula can be developed. By use of the data from Table 8-4,

the empirical formula for the AVCR-1100-3B is

$$U_c = 3.6 + 0.3 \Delta P_s, \text{ Btu/min-}^\circ\text{F-cyl} \quad (8-15)$$

where

ΔP_s = pressure drop of the cooling air across cylinder, in. water

The cooling air temperature rise ΔT_a may be expressed as

TABLE 8-4
 CYLINDER HEAD TEMPERATURE SURVEY SUMMARY OF COOLING DATA FOR AVCR-1100-3

RPM	2800	2800	2800	2800	2800	2800	2800	2800	2800	2800
% Load (100% = 1475 bhp Equivalent)	100	106	112	100	100	100	25	50	75	100
Lbm Air/lbm Fuel (Air/Fuel Ratio)	26.2	23.9	21.4	25.5	26.5	41.0	33.1	30.8	26.2	
Cooling Air Pressure Drop Across Cylinder, ΔP in. Water	7.0	7.0	7.0	3.0	5.0	7.0	7.0	7.0	7.0	7.0
Ambient Temperature, °F	100	104	108	108	108	101	105	108	108	100
Increase in Cooling Air Temperature Across Cylinder ΔT_s , deg F	145	160	174	196	160	61	89	117	145	
Cylinder Head Temperature Standard T/C Location Corrected to 100°F Ambient Temperature	480	508	536	540	496	267	337	408	480	

AMCP 706-381

$$\Delta T_a = (20 + 0.22 w_f) \left(\frac{\Delta P_o}{\Delta P} \right)^{0.29}, \text{ deg F} \quad (8-16)$$

where

ΔP_o = reference pressure drop used as 10 in. water corresponding to data as shown on Fig. 8-22

w_f = fuel flow rate for a 12 cylinder engine, lbm/hr

The exponent (0.29) and constants (20) and (0.22) were derived by empirical methods using the data in Table 8-4 and Fig. 8-22.

The cylinder temperature T_c from Eq. 8-14 is

$$T_c = \frac{w_c C_p \Delta T_a}{U_c} + T_1 + \frac{\Delta T_a}{2}, \text{ } ^\circ\text{F} \quad (8-17)$$

Sample Calculation

A sample calculation employing the method described follows:

Let

$$\Delta P = 8 \text{ in. water}$$

$$T_1 = 70^\circ\text{F}$$

$$w_f = 481 \text{ lbm/hr}$$

then

$$w_c = 54 \text{ lbm/min-cyl (from Fig. 8-21)}$$

From Eq. 8-16

$$\begin{aligned} \Delta T_a &= (20 + 0.22 \times 481) \left(\frac{10}{8} \right)^{0.29} \\ &= 134 \text{ deg F} \end{aligned}$$

From Eq. 8-15

$$U_c = 3.6 + 0.3 \times 8 = 6.0 \text{ Btu/min-}^\circ\text{F-cyl}$$

From Eq. 8-17

$$T_c = \frac{54 \times 0.24 \times 134}{6} + 70 + \frac{134}{2} = 426^\circ\text{F}$$

From Eq. 8-12

$$Q = 54 \times 0.24 \times 134 = 1737 \text{ Btu/min-cyl}$$

Table 8-5 and Fig. 8-23 give the results for a range of pressure drops and ambient temperatures.

8-5.2.1.2 Engine Oil Heat Rejection

In order to establish the oil heat rejection characteristics of an engine, for use in making an accurate vehicle cooling prediction, some very specialized tests must be conducted. These tests are represented by Fig. 8-24 (A), (B), and (C), and are used to establish the oil heat rejection characteristics of the engine. They should not be confused with the heat rejection characteristics of an oil-cooler which may be provided for dissipating that heat.

Test A is conducted by holding constant the cooling and induction air inlet temperature and the engine fuel flow rate (power), and varying the engine oil outlet temperature.

Test B is conducted with varying air inlet temperatures, but with constant oil outlet temperature and fixed fuel flow rate.

Test C varies fuel flow rate while holding constant the oil outlet temperature and air inlet temperature. In each case the heat rejection rate to the oil is measured to establish the effects of these three variables. From these data, cross plots can be made to show the oil heat rejection rate as a function of fuel flow rate at several air inlet

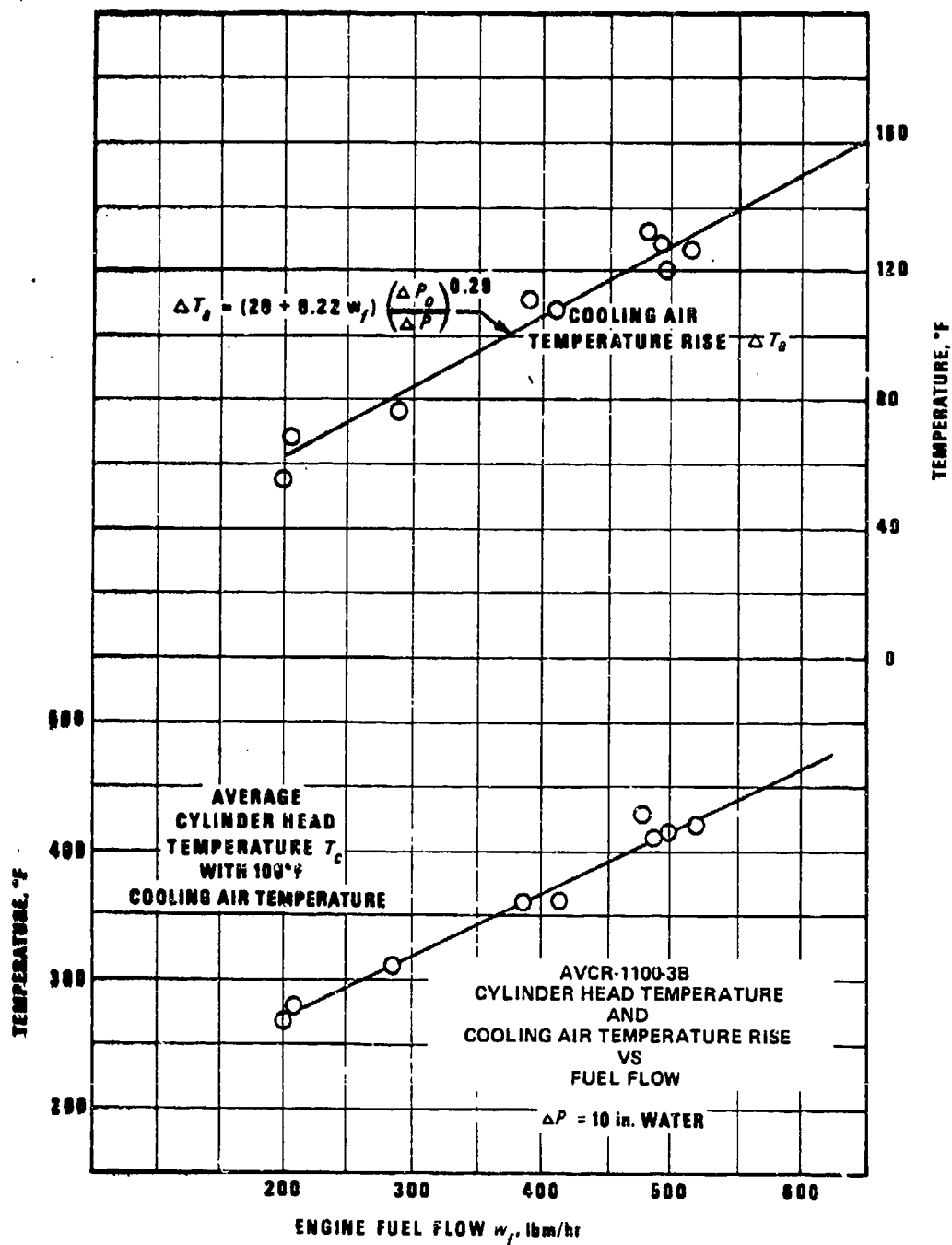

Figure 8-22. AVCR-1100-3B Cylinder Head Temperature and Cooling Air Temperature Rise vs Fuel Flow at 2600 rpm

AMCP 706-361

TABLE 8-5
 AVCR-1100-38 CYLINDER COOLING CHARACTERISTICS

Amb Temp T_g , °F	Inlet Air Temp T_i , °F	Fuel Temp T_f , °F	Fuel Flow w_f , lbm/hr-eng.	Cooling Air Flow Per Cyl w_g , lbm/min	Cooling Air Temp RISE ΔT_g , deg F	Overall Heat Transfer Coefficient U , Btu/min-°F-Cyl.	Cyl Head Temp T_c , °F	Heat Rejection Per Cyl Q_c , Btu/min
$\Delta P = 8$ in. Water (Cylinder Cooling Air Pressure Drop)								
60	70	90	481	54	134	6	426	1740
80	90	110	468	53	131.5	6	434	1670
100	110	130	455	52	128	6	440	1600
120	130	150	442	51	124.5	6	446	1525
$\Delta P = 7$ in. Water								
60	70	90	481	50	140	5.7	434	1680
80	90	110	468	49	136	5.7	439	1600
100	110	130	455	48	133	5.7	455.5	1530
120	130	150	442	47	129.5	5.7	452	1465
$\Delta P = 6$ in. Water								
50	70	90	481	46.0	147	5.4	443.5	1620
80	90	110	460	45.1	143	5.4	449	1550
100	110	130	455	44.2	139.5	5.4	454	1480
120	130	150	442	43.3	136	5.4	460	1415
$\Delta P = 5$ in. Water								
60	70	90	481	42	156	5.1	451	1550
80	90	110	468	41.2	150.5	5.1	456	1485
100	110	130	455	40.4	147	5.1	462.5	1425
120	130	150	442	39.6	142.5	5.1	469	1360

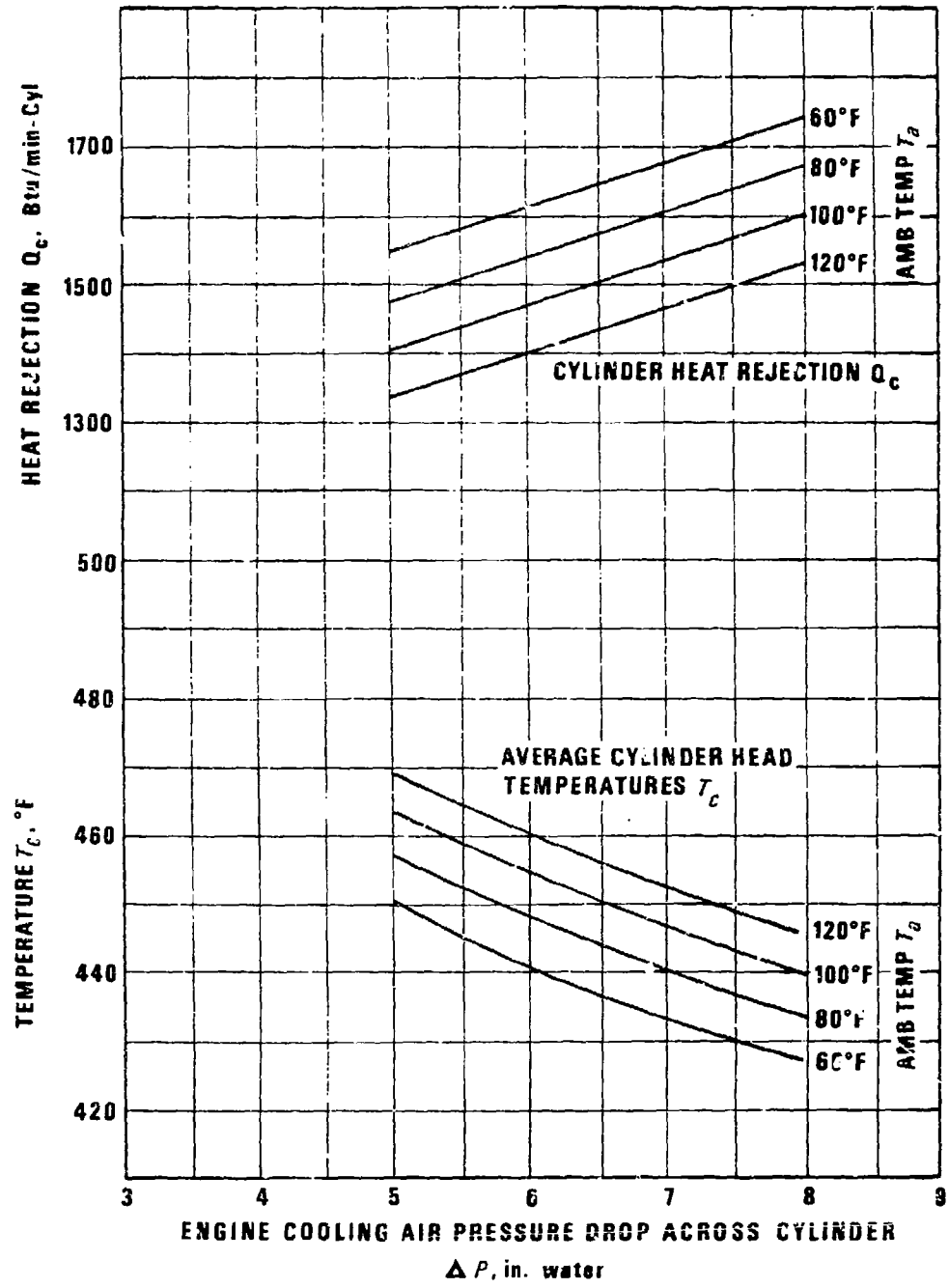

Figure 8-23. AVCR-1100-3B Cylinder Head Temperatures and Heat Rejection at 2600 rpm Full Load

AMCP 706-361

temperatures and at a fixed engine oil outlet temperature.

Fig. 8-25 shows the results of these tests for the AVCR-1100-3B engine at 260°F oil outlet temperature and engine speed of 2600 rpm. Superimposed on this curve are the ambient air inlet temperature effects on full load fuel flow to show full throttle operating fuel flow rates vs ambient air inlet temperature. The respective heat rejection rate values, at full load fuel flow rates for these ambient temperatures, at 260°F oil outlet temperature, is then plotted on Fig. 8-26 with the slope of the heat rejection lines as previously derived from Test A. Fig. 8-26 then represents the engine oil heat rejection rate vs oil sump temperature, at full throttle setting, while operating in various ambient air temperatures. On this curve, the oil-cooler heat rejection characteristics can be superimposed to determine resulting installed operating temperatures.

An oil-cooler is selected that gives the required heat rejection and will fit the design. Several studies usually are made to determine the best selection for the vehicle design. For this application, the cooler is represented by the Harrison Radiator Division curve as shown on Fig. 8-27. Fig. 8-28 repeats the engine oil heat rejection curves of Fig. 8-26 and adds the cooler capacity characteristics at 4 in. water air ΔP , for 100° and 120°F ambient temperature.

In calculating the engine oil cooler heat capacity for plotting on Fig. 8-28, only 90 percent of the heat rejection rate values shown on Fig. 8-27 are used to allow for a 10 percent degradation due to dirt clogging.

The oil-cooler heat rejection capacity curve data as plotted on Fig. 8-28 were calculated as follows:

Given

Engine oil flow rate = 500 lbm/min or 250 lbm/min-cooler (using 2 coolers)

Cooling air $\Delta P = 4$ in. water (limiting factor based on past experience on previously designed engines, see Fig. 8-33).

Then from Fig. 8-27

$$\text{Heat rejection/cooler} = 3350 \text{ Btu/min} - 100 \text{ deg F ITD}$$

Then, for example, the heat rejection capacity at 120°F ambient, and 250°F oil temperature, will be

$$Q = 3350 \times 2 \times \frac{250 - (120 + 10)}{100} \times 0.90$$

$$= 7236 \text{ Btu/min}$$

8-5.2.1.3 Engine Induction Air Heat Rejection in Aftercooler

The engine induction air heat rejection rate in the aftercooler and the resulting induction air manifold temperatures for the AVCR-1100 engine at various aftercooler cooling air pressure drops are calculated (as shown in Fig. 8-29) using well known methods and available test data. A schematic diagram of the induction system is shown in Fig. 8-30. The methods used in these calculations follow.

The heat rejected in the aftercooler Q_i by the induction air is

$$Q_i = w_i C_p (T_2 - T_3), \text{ Btu/min-cooler} \tag{8-18}$$

where

C_p = specific heat of air at constant pressure, 0.24 Btu/lbm-°F

T_2 = induction air temperature before the aftercooler (or after the compressor), °F

T_3 = induction air temperature after the aftercooler (or inlet manifold air temperature), °F

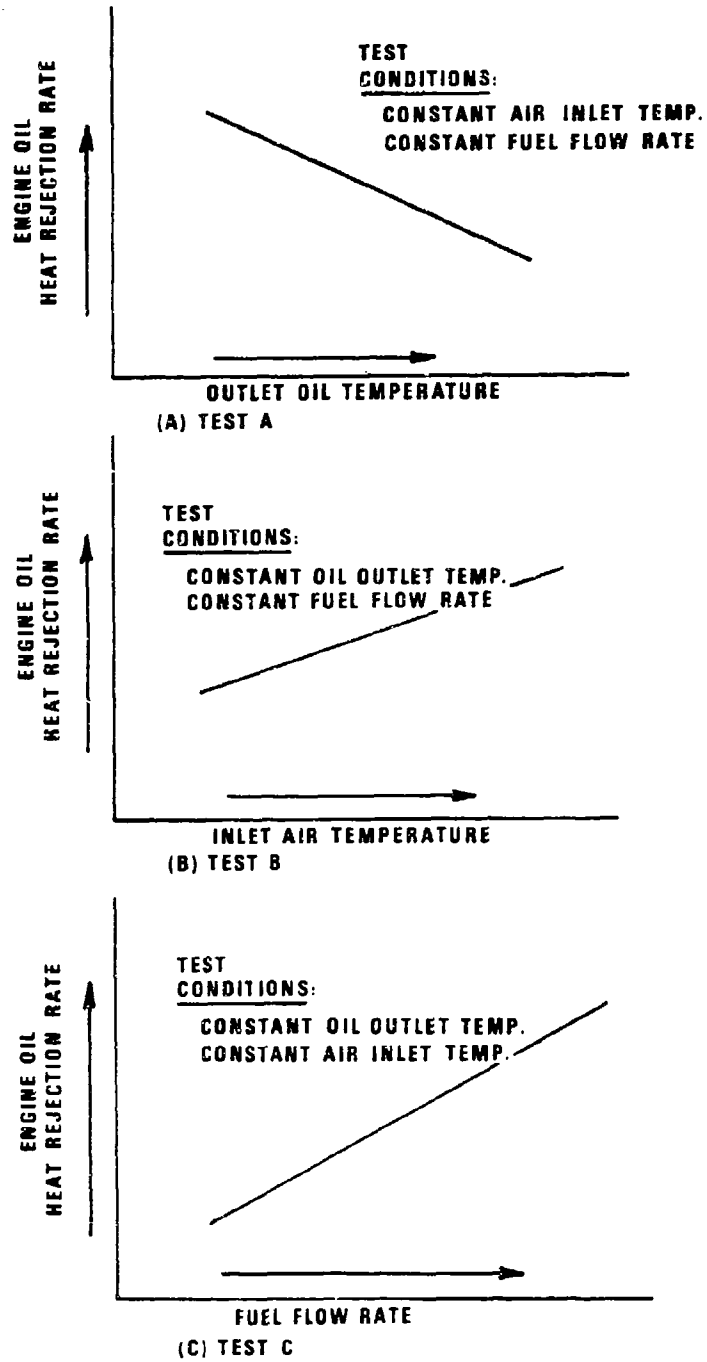

Figure 8-24. Engine Oil Heat Rejection Rate Characteristics

AMCP 706-361

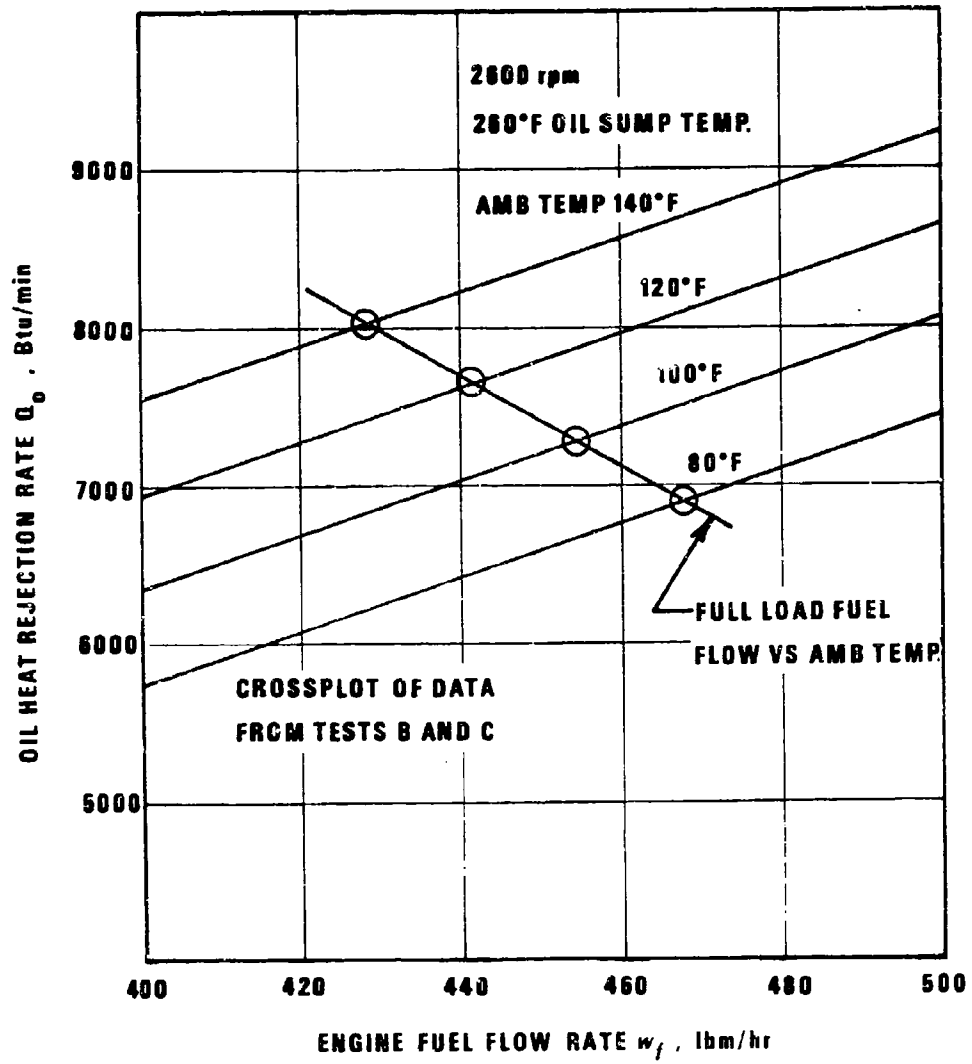

Figure 8-25. AVCR-1100-38 Engine Oil Heat Rejection vs Fuel Flow

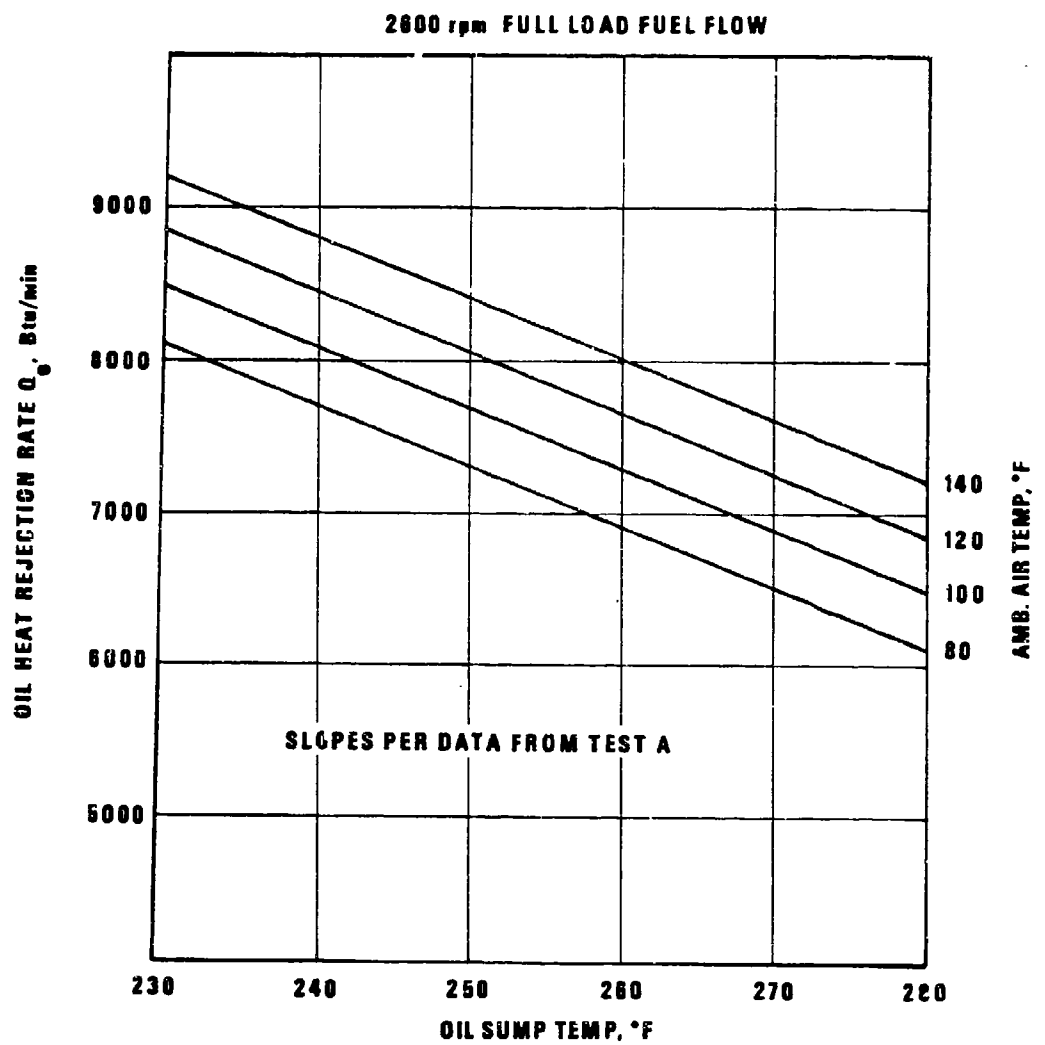

Figure 8-26. AVCR-1100-3B Engine Oil Heat Rejection vs Oil Temperature

AMCP 708-361

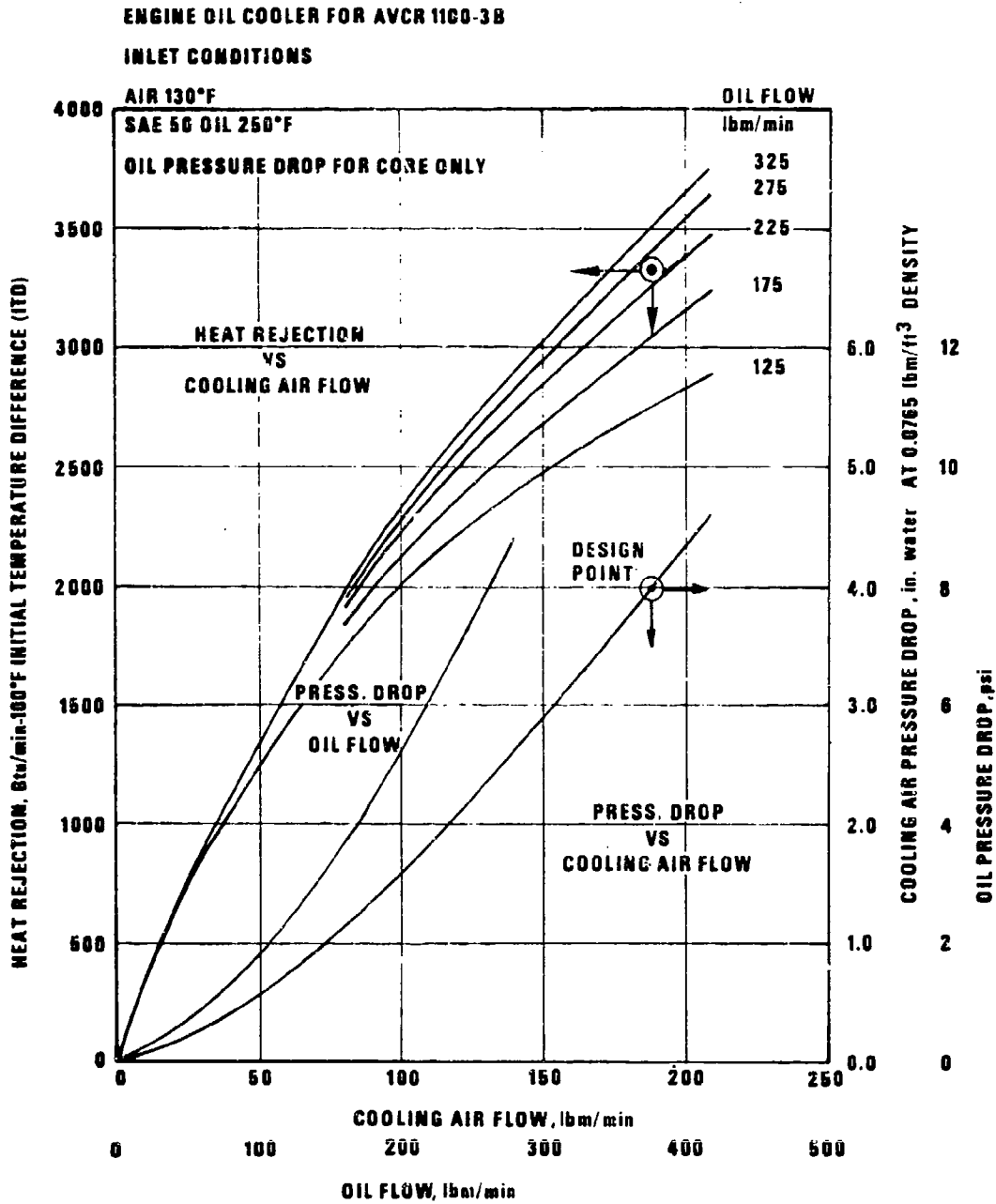

Figure 8-27. Engine Oil Cooler Characteristics
 (Courtesy of Harrison Radiator Division-GMC)

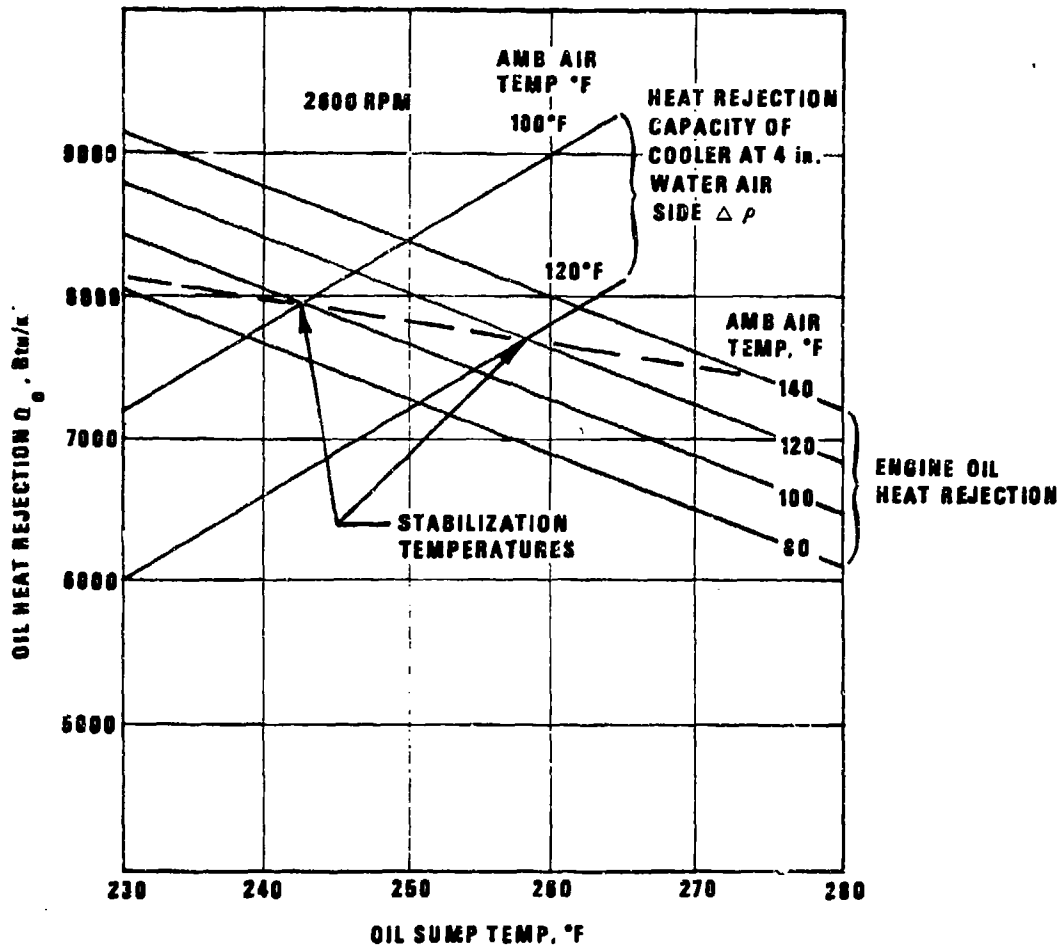

Figure 8-28. AVCR-1100-3B Engine Full Load Cooling Characteristics

w_i = rate of flow of the induction air,
 lbm/min-cooler

The rate of flow of the engine induction air w_i was obtained by plotting w_i versus fuel flow rate w_f . Fig. 8-31 represents the data of the AVCR-1100-3B engine. The same figure gives manifold air pressure also as a function of fuel flow rate. In part (A) of the curve, a correlation for full load fuel flow rate according to fuel temperature and ambient temperature is included. For a given value of ambient temperature the values of full load fuel flow, induction airflow, and manifold

pressure can be read from an ordinate of the figure. It is noted that the basis of the curves assumes a vehicle fuel temperature that is 30 deg F above the ambient temperatures. This figure shows the combined effect of changes due to ambient air and associated fuel temperatures.

This induction airflow rate, however, is given for ambient temperature of 80°F and a compressor inlet pressure of 27.5 in. Hg. The following correction is required for variation of ambient temperature or pressure

AMCP 706-381

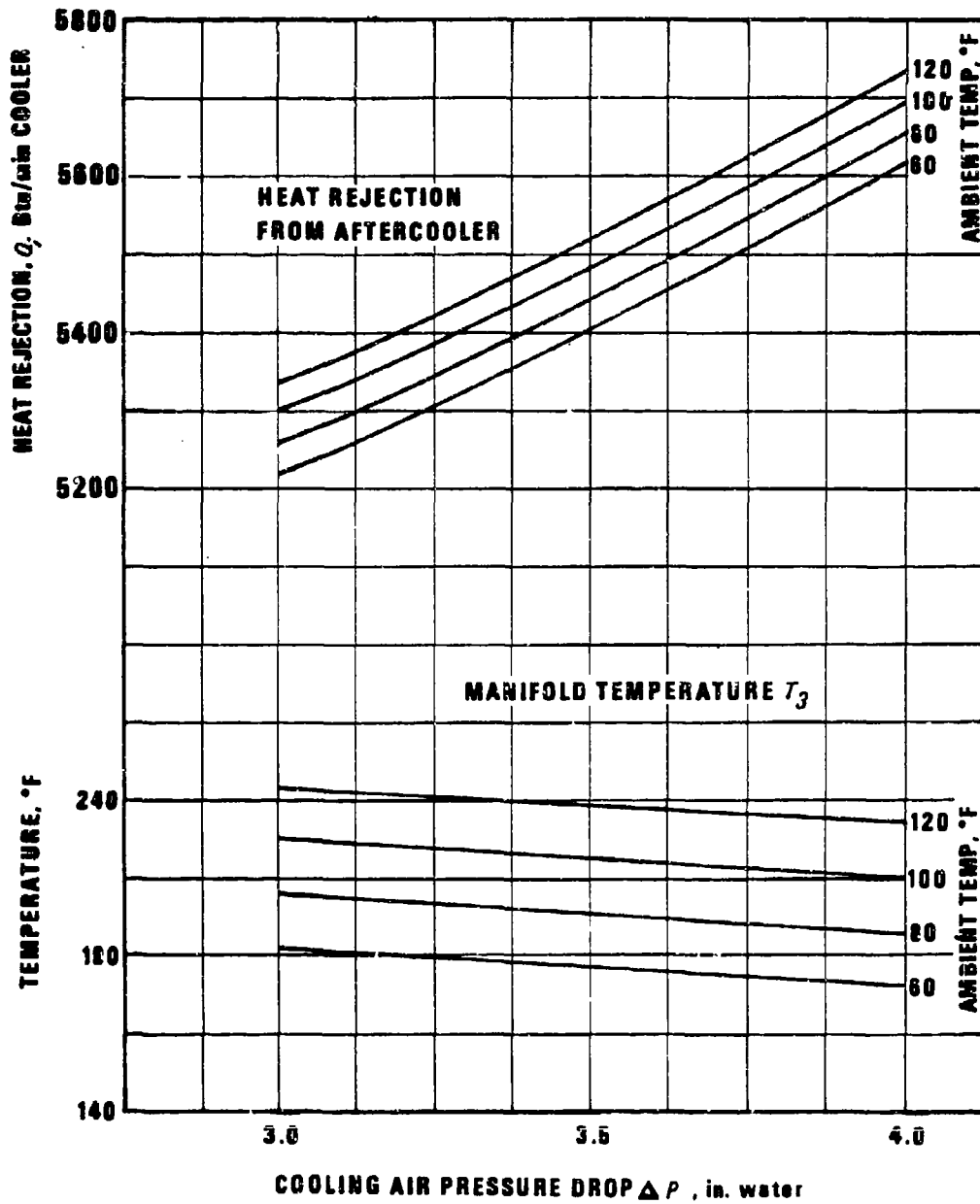

Figure 8-29. AVCR-1100-3B Induction Air Heat Rejection and Intake Manifold Temperature

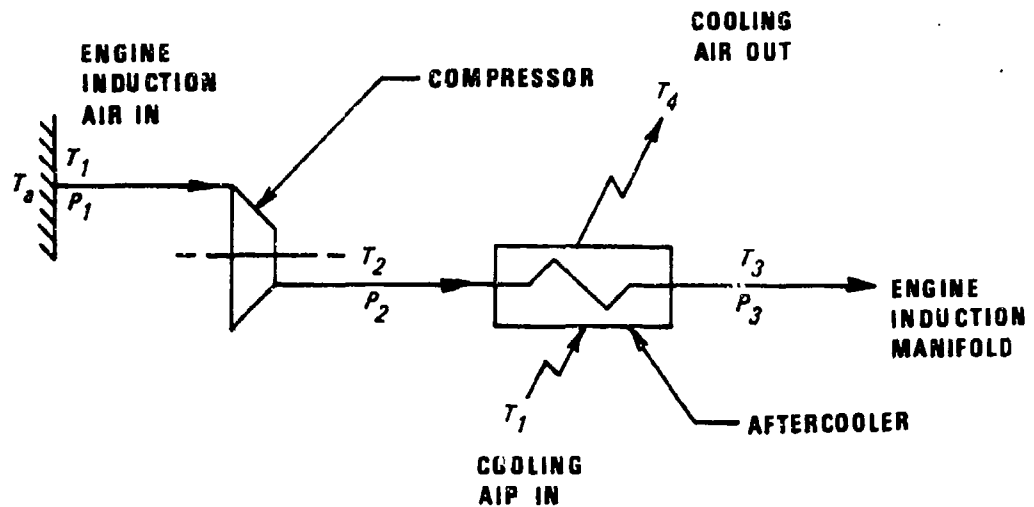

Figure 8-30. Schematic Diagram of AVCR-1100-3B Induction System

$$w_i = w_t \left(\frac{P_1}{P_t} \right) \sqrt{\frac{460 + T_t}{460 + T_1}}, \text{ lbm/min} \quad (8-19)$$

where

T_1 = induction air temperature before compressor, °F

P_1 = induction air pressure before compressor, in. Hg

P_t = pressure out of compressor, in. Hg

w_t = induction airflow rate per cooler and subscript t relates to test conditions of Fig. 8-31, lbm/min

T_t = temperature at test conditions, °F

The induction air temperature T_2 after the compressor is obtained from Eq. 8-2.

The engine induction air temperature in the manifold T_3 is derived from the definition of induction air-side cooler effectiveness η_e

$$\eta_e = \frac{T_2 - T_3}{T_2 - T_1}, \text{ dimensionless} \quad (8-20)$$

However, η_e is read from the curves given by Harrison, Fig. 8-32 which is for the aftercooler selected for this application. Solving Eq. 8-20 explicitly for T_3 yields

$$T_3 = T_2 - \eta_e (T_2 - T_1), \text{ °F} \quad (8-20a)$$

The amount of heat rejected by the induction air that is transferred to the cooling air is expressed by

$$Q_i = w_c C_p (T_4 - T_1), \text{ Btu/min-cooler} \quad (8-21)$$

where

T_4 = cooling air out temperature, °F

w_c = rate of flow of cooling air, obtained from Fig. 8-32 as a function of cooling air pressure drop and corrected for change of ambient temperature, lbm/min-cooler

AMCP 706-361

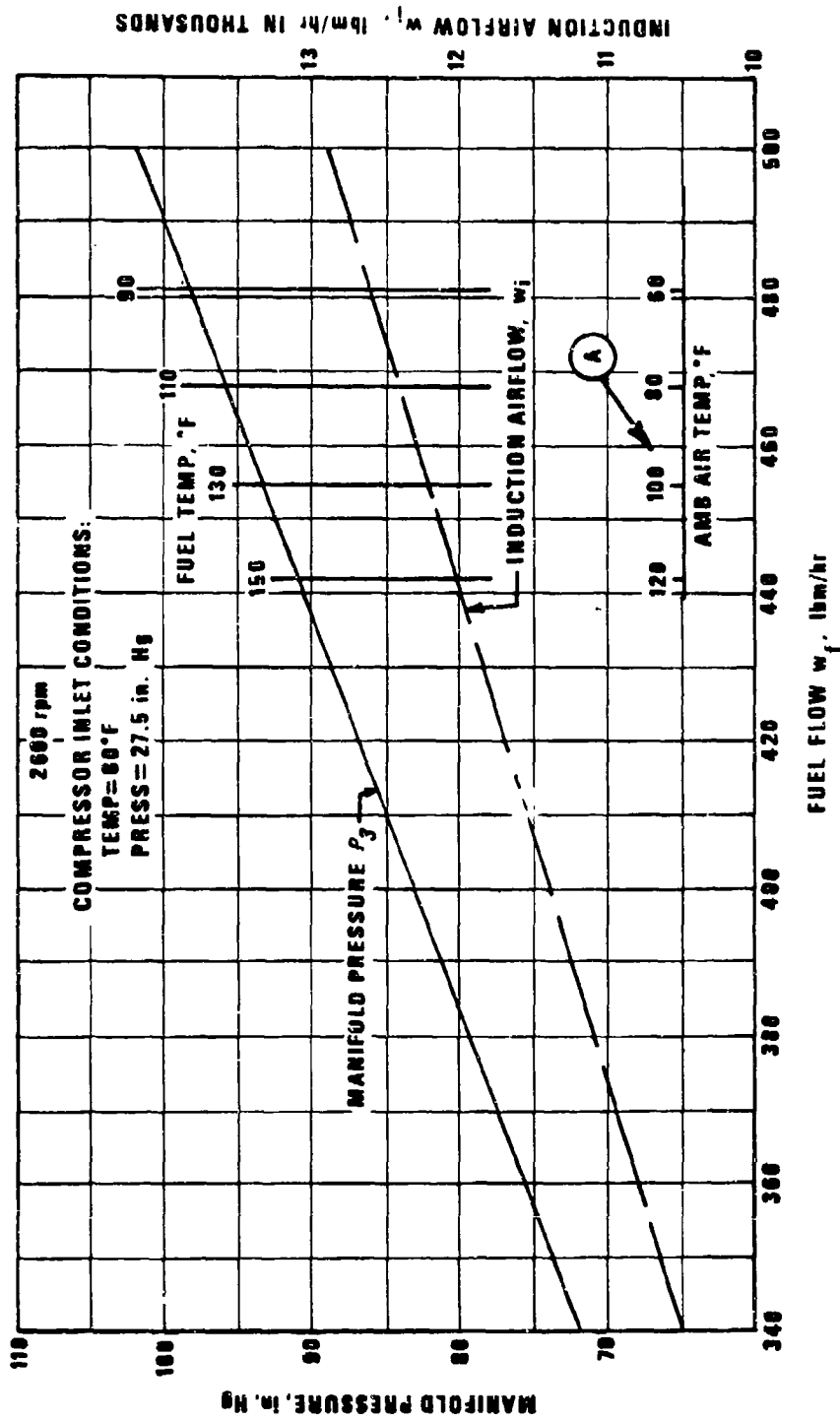

Figure 8-31. AVCR-1100-3B Engine Induction Airflow Characteristics

AVCR 1100-3B AFTERCOOLER

INLET CONDITIONS **RANGE**
 COOLING AIR 130°F 50 TO 250 lbm/min
 INDUCTION AIR 590°F 20 TO 140 lbm/min
 INDUCTION AIR PRESSURE DROP CORE ONLY

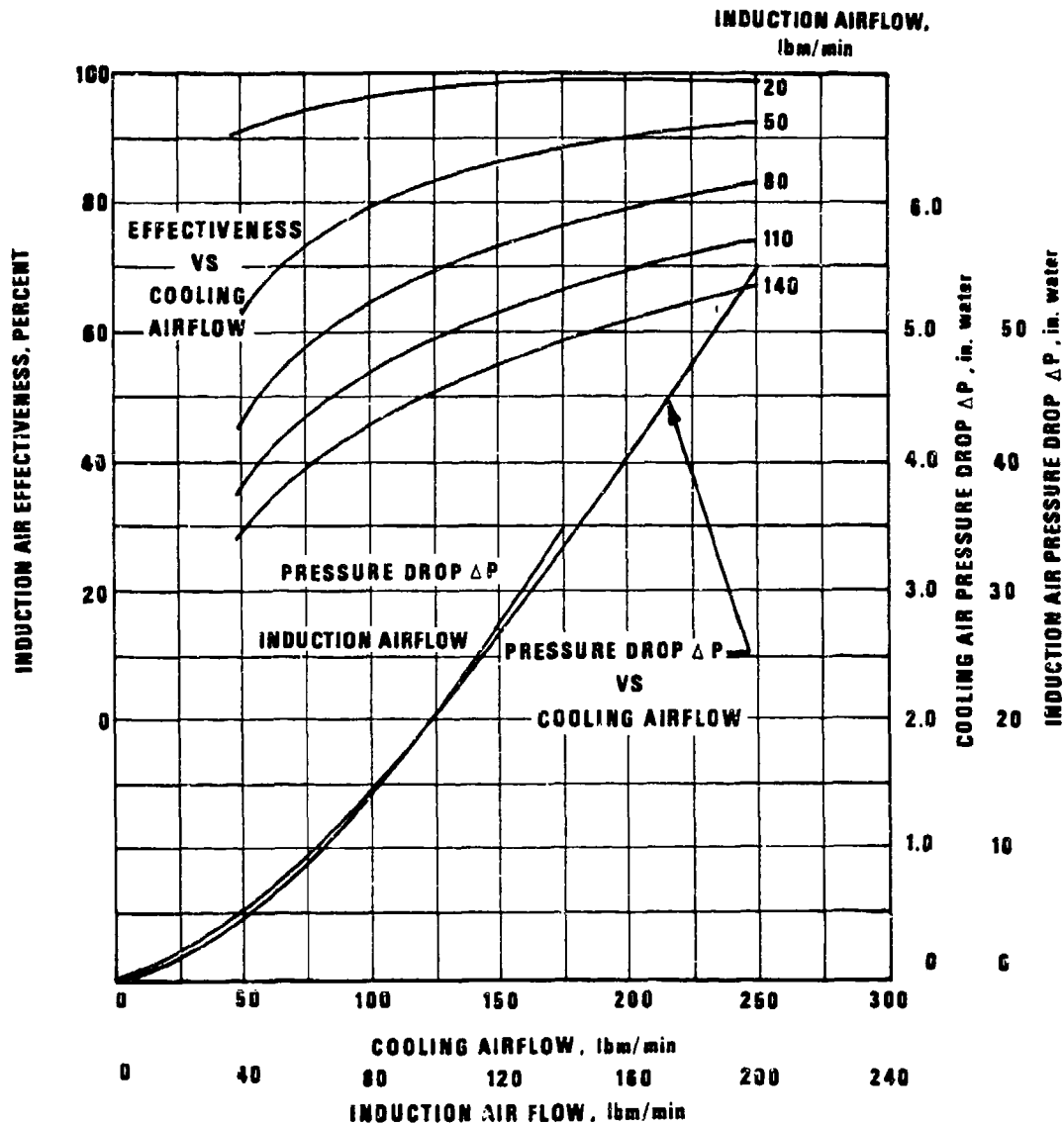

Figure 8-32. Aftercooler Characteristics
 (Courtesy of Harrison Radiator Division-GMC)

AMCP 706-361

$$w_c = w_t \sqrt{\frac{460 + T_t}{460 + T_1}}, \text{ lbm/min} \quad (8-22)$$

Subscript *t* indicates the test conditions for Fig. 8-32.

From Eq. 8-21 the temperature of the cooling air after the cooler is calculated as

$$T_4 = \frac{Q_i}{w_c C_p} + T_1, \text{ }^\circ\text{F} \quad (8-23)$$

All calculated results are tabulated in Table 8-6. The aftercooler design is sized for maximum heat rejection.

8-5.2.1.4 Engine Cooling Fan Selection

In complex cooling systems where cooling components operate in parallel circuits, as do the coolers and the cylinders on the AVCR-1100 engine, it is necessary to determine the detailed flow losses to predict the operating points of the individual components. In this case, it is necessary to determine air pressure flow losses within the vee of the engine to determine the pressure drop at which the oil-coolers and aftercoolers will operate. This was done by measuring the flow loss characteristic as shown on Fig. 8-33 as a function of the cooling air flow rate through the coolers. This is better understood by reviewing the engine cooling arrangement shown in Fig. 1-19. As shown in Fig. 8-33 this loss detracts from the ΔP available to flow air through the cooler. Superimposing the ΔP vs the cooler airflow from the Harrison data curves (Figs. 8-27 and 8-32) shows that with a ΔP of 7 in. water across the cylinders, only 4 in. of air pressure drop will be available at the cooler cores.

Chapter 7 covers in detail the determination of losses through various sections of the vehicle. Based on the example given in par. 7-2.4.2, it is estimated that a 4.5 in. water loss will be encountered giving a total cooling fan

rise requirement of approximately 11.5 in. water. Chapter 4 treats the theory and practice of fan design characteristics. The fan for the AVCR-1100-3B engine has been tested to establish its operating characteristics. Fig. 8-34 shows those characteristics at conditions approximating the full load operation (i.e., at 250°F and 29.92 in. Hg at fan outlet). This curve shows performance for one fan. The engine incorporates the use of two of these fans. The total system resistance curve obtained from the analysis of pars. 8-5.2.1.1, 8-5.2.1.2, and 8-5.2.1.3, and summarized on Table 8-7 is shown plotted on the fan curve, Fig. 8-34. From these data it can be predicted that a fan speed of approximately 5450 rpm is required where the fan efficiency will be 43 percent. From Eq. 8-8 the fan power for two fans is calculated as

$$\begin{aligned} HP_f &= \frac{23,929 \times 11.5 \times 1.575 \times 10^{-4}}{0.43} \\ &= 101 \text{ hp} \end{aligned}$$

This power along with the other calculated operating parameters are compiled in Table 8-7.

This combination of components was tested in a full scale engine compartment mock-up (Ref. 4) and a summary of measured results of that test also are given in Table 8-7 for comparative purposes. It should be noted that operating temperatures quite closely agree with calculated values, however, some deviations can be seen in airflow rates and measured air pressure drops.

8-5.2.2 Transmission Heat Rejection

The heat rejection rate for the XHM-1500 transmission at the 1250 gross horsepower engine rating is 15,500 Btu/min. This is the heat rejection from the transmission when the tractive effort/vehicle weight factor is equal to 0.70 of the vehicle weight or 75,600 lb. This normally is used as the limit of tractive slip and heat rejection under these conditions

TABLE 8-6
 AVCR-1100-3B AFTERCOOLER COOLING CHARACTERISTICS

Amb. Temp. °F T_a	Inlet Temp. °F T_1	Fuel Temp. °F T_f	Fuel Flow Wf. lbm/min	Ind. Air Flow Per Cooler W _i . lbm/min	Cooling Air Flow Per Cooler W _c . lbm/min	Comp. Pressure Ratio P_2/P_1	After Cooler Effective-ness η_e	Comp. Out Temp. °F T_2	Cooler Out Temp. °F T_3	Cooling Air Out Temp. °F T_4	Heat Rej. Per Cooler Q_j , Btu/min
$\Delta P = 4.0$ in. Water											
60	70	90	481	106	212	3.54	.67	400	179	180	5620
80	90	110	468	104	208	3.45	.68	424	197	204	5670
100	110	130	455	102	204	3.34	.69	448	215	226	5700
120	130	150	442	100	200	3.28	.70	472	232	250	5750
$\Delta P = 3.5$ in. Water											
60	70	90	481	105	171	3.54	.65	400	186	201	5400
80	90	110	468	103	174	3.45	.66	424	204	220	5450
100	110	130	455	101	177	3.34	.67	448	222	239	5480
120	130	150	442	99	180	3.28	.68	472	240	258	5520
$\Delta P = 3.0$ in. Water											
60	70	90	481	104.5	157.5	3.54	.63	400	192	208	5220
80	90	110	468	102.5	160	3.45	.64	424	210	227.5	5260
100	110	130	455	100.5	162.5	3.34	.65	448	225	246	5300
120	130	150	442	98.5	165	3.28	.66	472	246	260	5350

AMCP 708-381

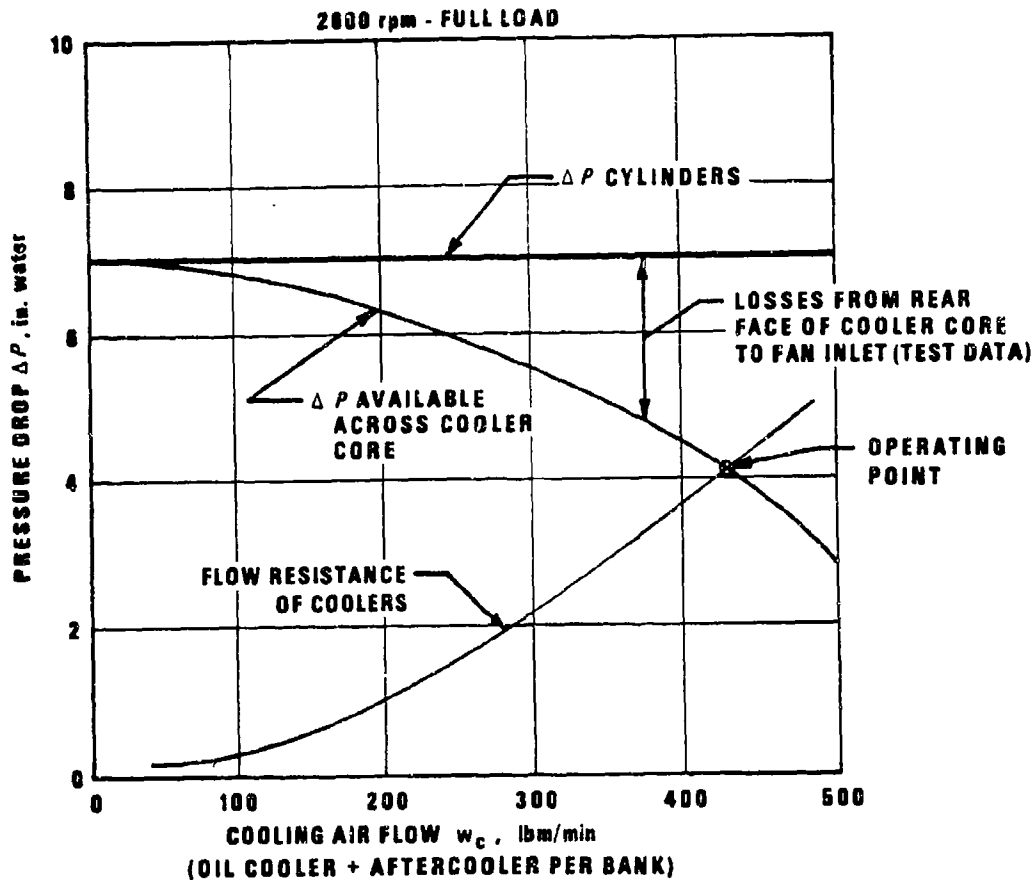

Figure 8-33. AVCR-1100-3B Cooling Airflow Characteristics from Hot Mock-up Tests

must be provided for. Each of the two transmission oil coolers must handle a heat load of 7,750 Btu/min (15,500/2). The maximum allowable transmission oil temperature is 300°F.

In addition to the transmission oil coolers as shown in Fig. 8-35, a fuel cooler core and a hydraulic oil cooler core (one in each of the two ducts) are located ahead of the cooling fans—in order to achieve the desired oil and fuel temperatures. These cores dissipate approximately 500 Btu/min under the ambient conditions in the installation and the total

heat load handled by each cooling fan is 8,250 Btu/min (7,750 + 500). To handle this total heat load, each of the transmission cooling fans is sized to flow 300 lbm/min of air.

The air temperature rise ΔT from Eq. 8-1 is through:

1. The hydraulic oil cooler

$$\Delta T = \frac{500}{300 \times 0.24} = 7 \text{ deg F}$$

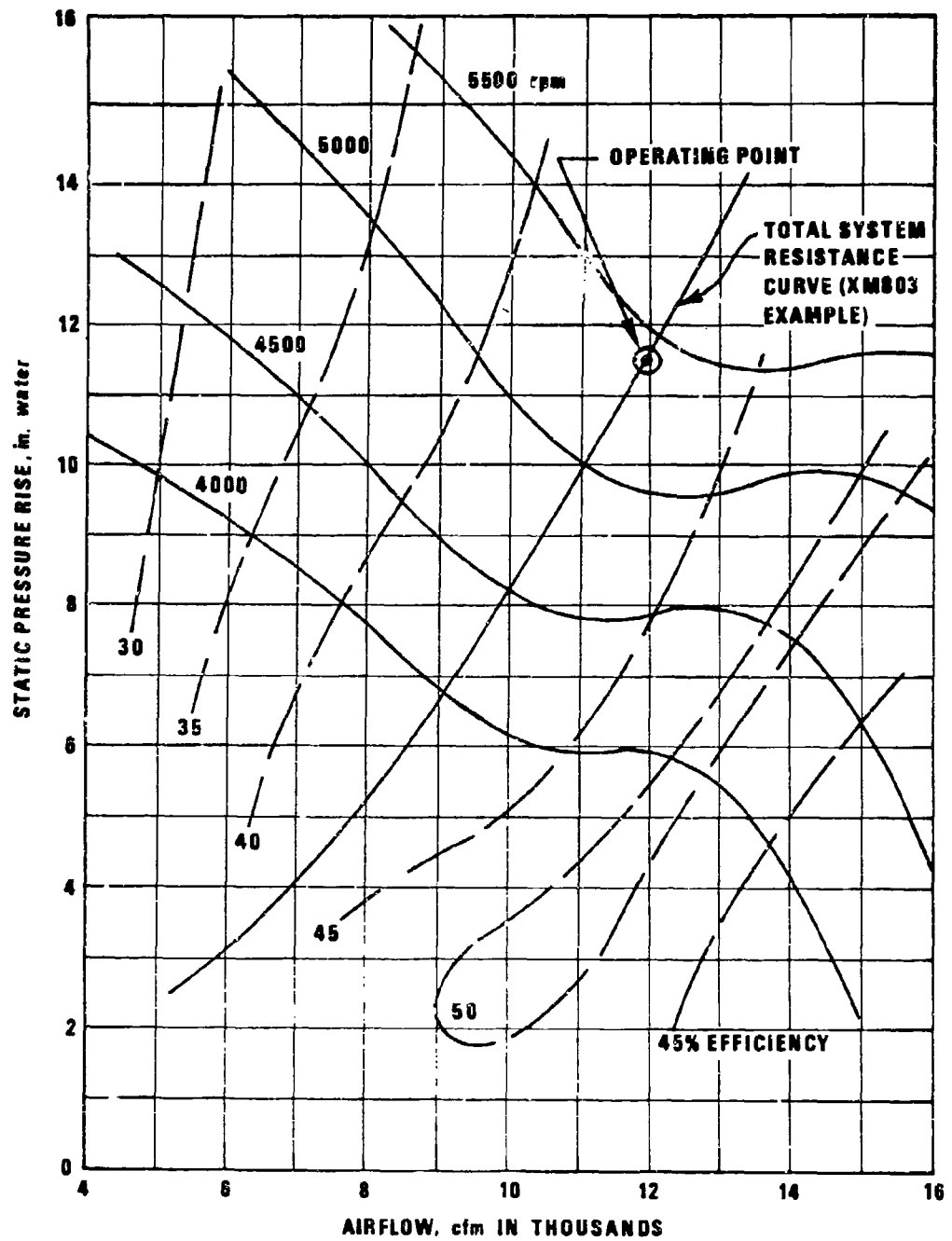

Figure 8-34. AVCR-1100-3B Cooling Fan Performance Measured for One Fan During Hot Mock-up Test

AMCP 706-361

TABLE 8-7

**SUMMARY OF COOLING SYSTEM OPERATION OF AVCR-1100-38
 IN THE XM803 EXPERIMENTAL TANK**

CHARACTERISTICS	CALCULATED COOLING CONDITIONS	MEASURED RESULT HOT MOCK-UP
TEMPERATURE, °F		
AMBIENT AIR	120	120
COOLING INLET AIR	130	123
COOLING INLET AIR RISE	114	126
COOLING INLET AIR AT OUTLET	244	249
CYLINDER HEAD (AVERAGE)	452	480
ENGINE INDUCTION AIR	232	230
OIL SUMP	258	252
SPEED, RPM		
ENGINE	2600	2600
FAN	5450	5250
FAN HP (2 FANS)	101	102
COOLING AIRFLOW, LBM/MIN		
OIL COOLERS	380	375
AFTERCOOLERS	400	330
CYLINDERS	<u>560</u>	<u>515</u>
TOTAL	1340	1220
HEAT REJECTION, BTU/MIN		
OIL	7700	7500
INDUCTION AIR	11500	12400
CYLINDERS	<u>17600</u>	<u>16900</u>
TOTAL	36800	36800
SYSTEM PRESSURE DROP ΔP, IN. WATER		
OIL COOLER	4.0	3.4
AFTERCOOLERS	4.0	4.6
CYLINDERS	7.0	6.5
VEHICLE LOSS	4.5	4.3
TOTAL FAN STATIC PRESSURE RISE	11.5	10.8
FAN INLETS		
AIR DENSITY, LBM/FT ³	0.0548	0.0541
AIRFLOW RATE, CFM (2 FANS)	23,929	21,500

(SEE FIG. 8-35 FOR DIAGRAM)

AMCP 706-361

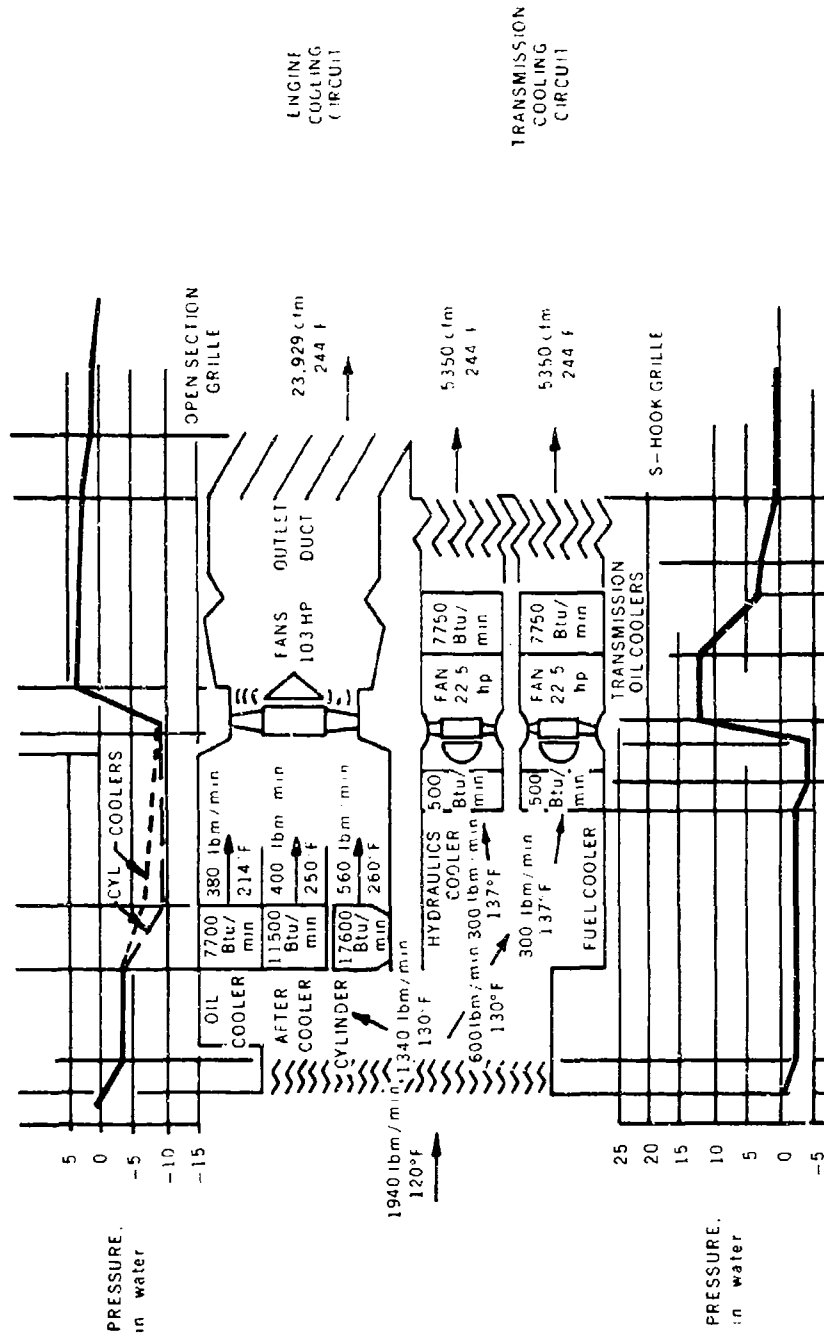

Figure 8-35. XM803 Experimental Tank Cooling System Performance Diagram

AMCP 708-381

2. Each of the transmission coolers

$$\Delta T = \frac{7750}{300 \times 0.24} = 107 \text{ deg F}$$

The air temperature before and after the transmission cooler is $130 + 7 = 137^\circ\text{F}$ and $130 + 7 + 107 = 244^\circ\text{F}$, respectively. The airside effectiveness η_e for the transmission cooler, Eq. 8-20, is

$$\eta_e = \frac{107}{300 - 137} = 0.66 \quad \text{which is in accordance with typical commercial practices.}$$

The *CFM* of air at the inlets of each fan by Eq. 8-7 is

$$CFM = \frac{300}{0.075 \times \frac{460 + 70}{460 + 137}} = 4506 \text{ cfm}$$

and the fan horsepower by Eq. 8-8 is

$$HP_f = \frac{4506 \times 16^* \times 1.575 \times 10^{-4}}{0.50} = 22.7 \text{ hp}$$

The *CFM* of air at the exit grille is

$$CFM = \frac{300}{0.075 \times \frac{460 + 70}{460 + 4}} = 5313 \text{ cfm}$$

*The total fan air pressure rise ($\Delta P = 16$ in. water) is apportioned as follows (design objectives)

	<u>in. water</u>
Inlet grille and compartment	2.0
Hydraulic and fuel cooler	2.0

Transmission cooler	9.0
Exit duct and grille	<u>3.0</u>
Total	16.0

Fig. 8-35 shows the complete cooling system performance diagram for the XM803 Experimental Tank with details of the airflow rates and heat rejection rate for each of the components. It must be noted that the design of a vehicle cooling system is not strictly an analytical procedure but is actually a combination of design, analysis, and test evaluations. The final complete design must be tested to confirm the acceptability of the system.

8-5.3 LIQUID-COOLED ENGINE INSTALLATION

An example of the cooling system for a vehicle using a liquid-cooled engine is presented to illustrate techniques in optimizing the total system. This example is for a hypothetical vehicle weighing 17,000 lb, using a 325 gross bhp rated engine, and a conventional gear shift type transmission. For this analysis it is assumed that the transmission heat will be transferred to the engine coolant by an oil-to-water heat exchanger. A parametric study is shown employing the radiator cooling characteristics as shown in Fig. 8-36.

This figure shows values of unit core heat rejection capacity *K* in terms of Btu/min-ft²-°F ITD (initial temperature difference) and cooling air pressure drop vs airflow in cfm/ft² of core area. Coolant flow rate does have an effect on heat rejection capacity of the core, however, it is relatively insensitive in the flow rate ranges normally applied. Therefore, in this example, it has been ignored to simplify the parametric study. Values for various core thicknesses are given in terms of number of rows of tubes. The parametric study involves calculating the required volume of cooling air and fan *HP* using cores of various rows of

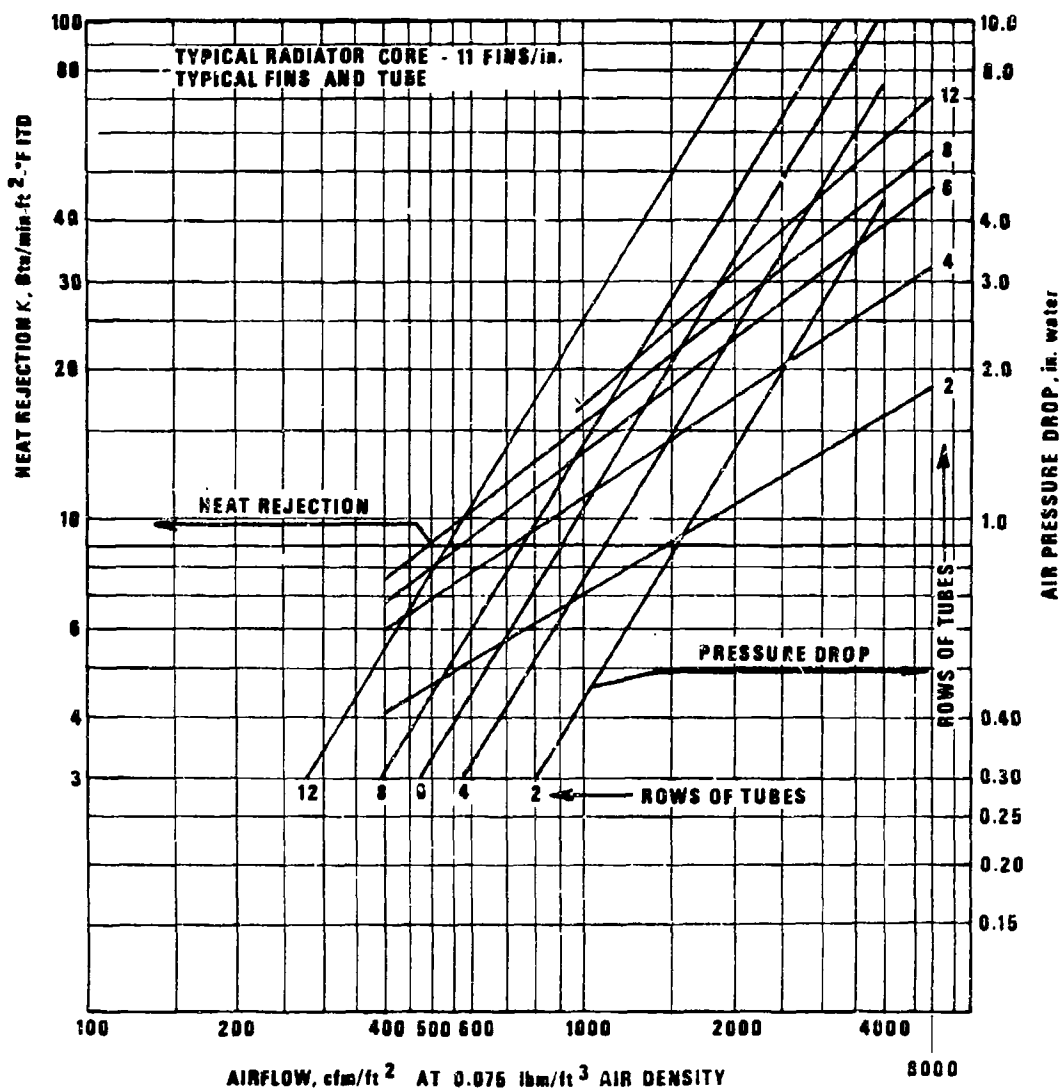

Figure 8-36. Typical Radiator Core Performance Characteristics

tubes, frontal area, and airflow velocities. The results of those calculations are given in Table 8-8, and the assumptions used for these parameters are listed also. The equations and methods used are exemplified by the calculations that follow for the first row of results shown in Table 8-8. For the core frontal area A_f

$$A_f = \frac{Q}{K \times ITD}, \text{ ft}^2 \quad (8-24)$$

where

Q = total heat rejection rate, Btu/min

K = unit core heat transfer capability factor, Btu/min-ft²-°F ITD

AMCP 706-361

TABLE 8-8
COOLING SYSTEM PARAMETRIC STUDY

Assumptions:

Gross Observed BHP = 290
 Heat Rejection:
 Engine = 9300 Btu/min
 Transmission = 1500 Btu/min
 Total = 10800 Btu/min
 = 125°F
 Ambient Air Inlet Temperature = 130°F (assumed 5 deg F rise over amb. T)
 Air Temperature Before Cooler = 240°F
 Inlet Water Temp = 0.0658 lbm/ft³
 Air Density ρ = 4.4 in. Water at 10,000 cfm
 Vehicle Airflow Resistance = 50%
 Fan Efficiency =

Radiator Core No. Tube Rows	Airflow Velocity, scfm/ft ²	K	Frontal Area, ft ²	Core Depth, in. Aprox.	Air Flow Rate, * cfm	Core ΔP , in. Water	Vehicle Air Rest., in. Water	Fan Static Press Rise, in. Water	Fan HP
4	1000	11.0	8.9	2.9	10,400	0.8	4.5	5.3	16.9
6	1000	13.5	7.3	4.2	8,460	1.2	3.1	4.3	11.2
8	1000	15.4	6.4	5.9	7,470	1.6	2.4	4.0	9.4
12	1000	17.3	5.7	8.8	6,650	2.6	1.9	4.5	9.4
4	1500	14.2	6.9	2.9	12,100	1.7	6.4	8.1	30.8
6	1500	18.3	5.4	4.2	9,450	2.5	3.9	6.4	19.0
8	1500	21.2	4.7	5.9	8,150	3.2	2.9	6.1	15.6
12	1500	24.6	4.0	8.8	6,930	4.9	2.1	7.0	15.3
4	2000	17.3	5.7	2.9	13,200	2.7	7.6	10.3	42.8
6	2000	23.0	4.3	4.2	10,000	3.9	4.4	8.3	26.0
8	2000	26.6	3.7	5.9	8,600	5.2	3.2	8.4	22.3
12	2000	31.3	3.2	8.8	7,300	7.9	2.3	10.2	23.4

*At operating condition

ITD = initial temperature difference, deg F

Given from Table 8-8 and read from Fig. 8-36

$$Q = 10,800 \text{ Btu/min}$$

$$K = 11.0 \text{ Btu/min-ft}^2\text{-}^\circ\text{F}$$

$$ITD = 240 - 130 = 110 \text{ deg F}$$

Therefore

$$A_f = \frac{10800}{11 \times 110} = 8.9 \text{ ft}^2$$

and

$$CFM = A_f V \left(\frac{\rho_o}{\rho} \right), \text{ ft}^3/\text{min at operating condition} \quad (8-25)$$

where

V = inlet cooling air velocity through cooler at standard condition, ft/min

ρ_o = air density at 70°F and 29.92 in. Hg = 0.075 lbm/ft³

ρ = density of cooling air flowing, lbm/ft³

From Eq. 8-25 the CFM at operating condition can be calculated

$$CFM = 8.9 \times 1000 \times \frac{0.075}{0.0658} = 10,144 \text{ ft}^3/\text{min}$$

$$\Delta P_{cooler} = \Delta P_{Fig. 8-36} \times \frac{0.075}{\rho} = 0.74 \times \frac{0.075}{0.0658} = 0.8 \text{ in. water at operating condition}$$

$$\Delta P_{vehicle} = R \left(\frac{CFM}{10,000} \right)^2, \text{ in. water (8-26)}$$

where

R = vehicle flow resistance, in. water/cfm (from Table 8-8)

CFM = airflow through vehicle, cfm therefore

$$\Delta P_{vehicle} = 4.4 \left(\frac{10,144}{10,000} \right)^2, = 4.5 \text{ in. water}$$

and

Fan static pressure rise ΔP_f

$$\Delta P_f = \Delta P_{cooler} + \Delta P_{vehicle}, \text{ in. water} \quad (8-27)$$

$$\Delta P_f = 0.8 + 4.5 = 5.3 \text{ in. water}$$

From Eq. 8-8 the fan HP can be calculated

$$HP_f = \frac{10144 \times 5.3 \times 1.575 \times 10^{-4}}{0.50} = 16.9 \text{ hp}$$

NOTE: The static efficiency of all fans in this parametric study was assumed as 50%.

The core depth in inches is furnished by the radiator core manufacturer and is related to the number of tube rows.

The results of these calculations are plotted in Figs. 8-37 and 8-38 showing required cooling fan HP vs cooler frontal area and cooling airflow rate, respectively. Examination of these data shows the influence on required cooling fan HP as affected by volume airflow rate and the resulting total system pressure drop. Note that the assumption of vehicle flow resistance ΔP (loss) being a function of flow rate is a major factor in fan HP . However, minimum

AMCP 706-361

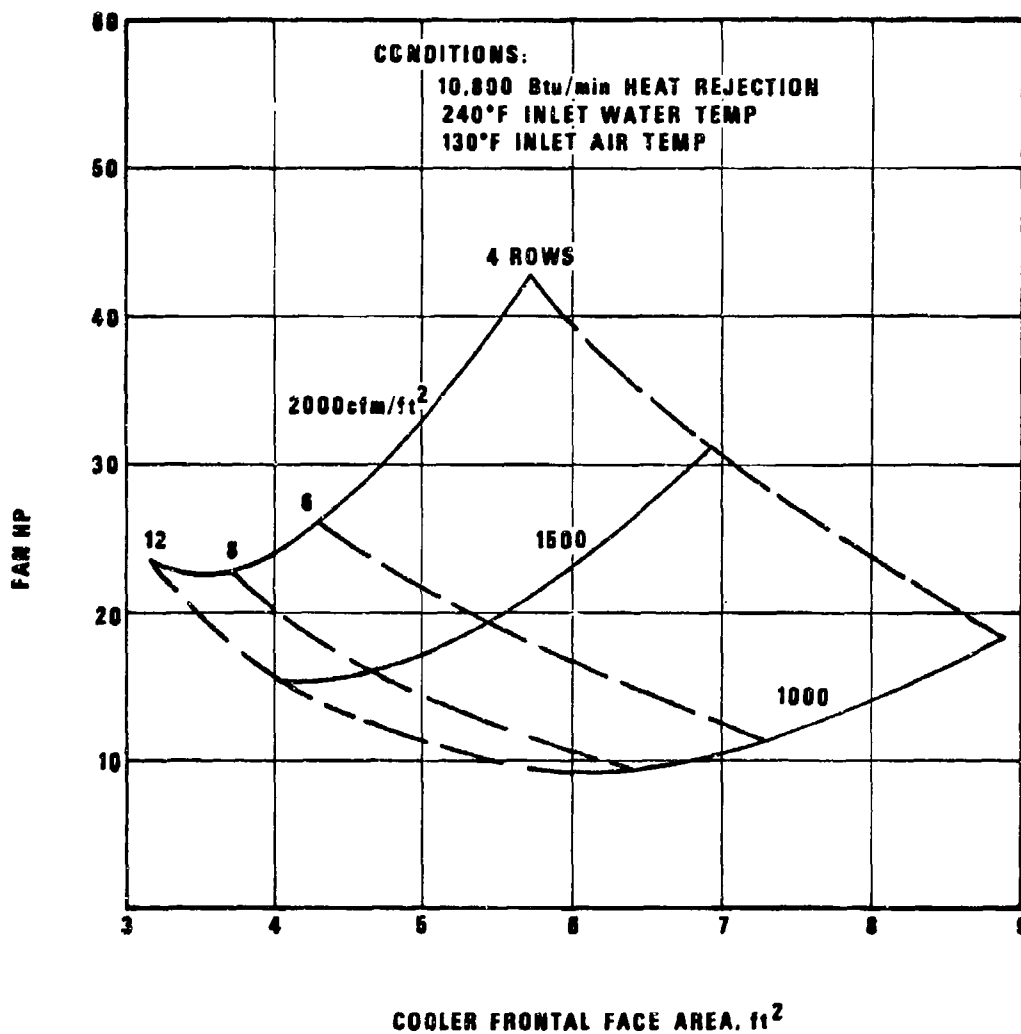

Figure 8-37. Parametric Cooling Study vs Cooler Frontal Face Area

fan *HP* does not necessarily occur at minimum ΔP because the efficiency of the fan for the particular application must be considered. This assumption is felt justified since in most military vehicles flow areas and grille sizes are limited. If, however, flow areas can be increased for the high *CFM* combinations, a much different optimization would occur. These curves indicate that the 8-row core with 5 to 6 ft² area is optimum,

requiring near minimum fan horsepower and cooler frontal area.

To study further the impact on fan power, the calculations were repeated at several water temperatures using 4-, 5-, and 6-ft² areas of 8-row cores. The result of this study, as shown on Fig. 8-39, indicates that cooling to low coolant temperature requires additional core frontal area to avoid high fan power

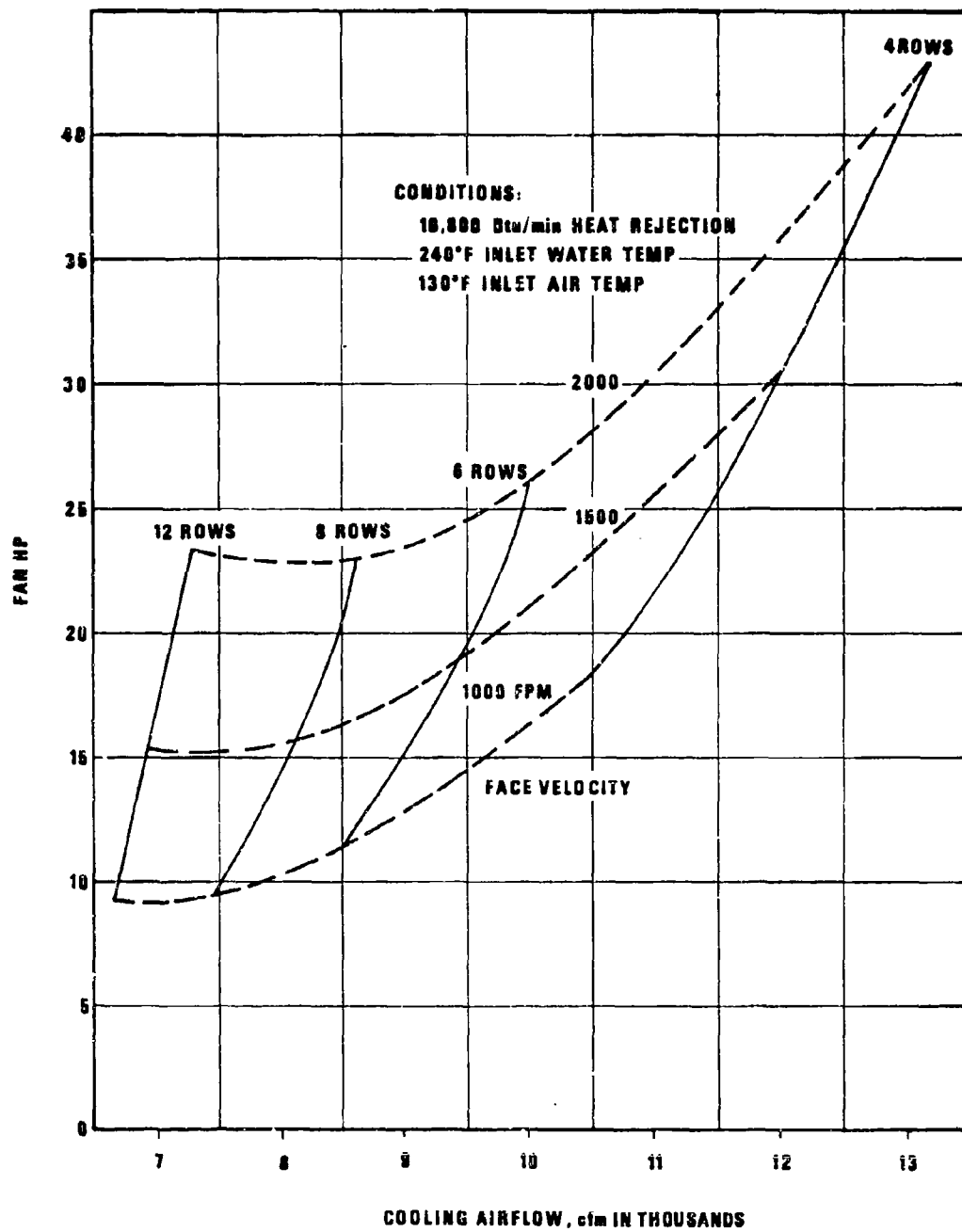

Figure 8-38. Parametric Cooling Study vs Cooling Airflow

AMCP 706-361

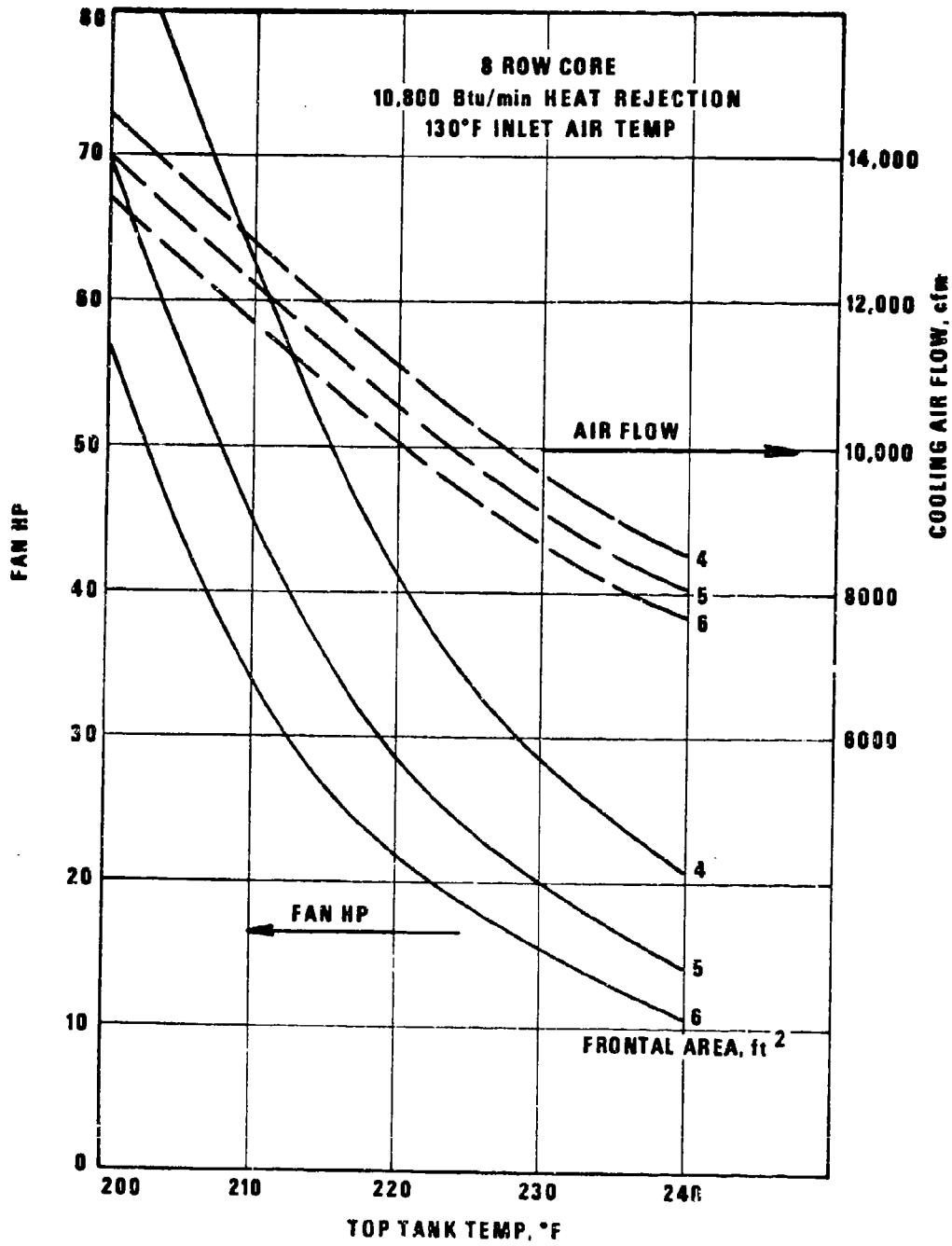

Figure 8-39. Parametric Cooling Study vs Coolant Temperature

requirements. This may be made possible by reconsidering the impact of existing trade-off on the overall vehicle operational capability.

In order to study the effect of engine power on the cooling requirement, calculations were made at 3 part load conditions. For this analysis it was assumed that the coolant heat rejection varied directly proportional to the engine power level. The cooler core selected for this study has 8 rows with 5-ft² area as shown on Fig. 8-40. Also shown on this graph are the results of a 15 percent degradation of radiator heat rejection performance in anticipation of dirt clogging.

The results of the parametric study to this point have indicated that a core frontal face area of between 5 and 6 ft² is desirable, especially in light of the advisability to provide a safety margin for dirt clogging degradation. Therefore, for the last iteration a 5.75-ft² area was chosen using a 15 percent degradation of core performance (at an equal airflow a 15% reduction in heat rejection was assumed). Calculations using the procedures explained, were made at several power levels and water temperatures and plotted as shown in Fig. 8-41. Fan *HP* vs engine gross observed *BHP* at the several water temperatures are plotted. The same data are used also to plot net *BHP* (gross *BHP* - fan *HP*) vs gross observed *BHP* at various water temperatures as shown on Fig. 8-42. It is evident in Fig. 8-42 that at 200°F water temperature and at 130°F air temperatures there is no increase in net available power at gross power above 250 bhp. This is because the cooling power load increases at a faster rate than gross power, resulting in an actual decrease in net engine power available at over 250 gross bhp.

To further illustrate the impact of ambient air temperature on net engine power, calculations at various gross power levels,

water temperatures, ambient air temperatures, and cooling fan powers were made culminating in the plot on Fig. 8-43. Note that this figure shows the gross observed *BHP* and how it drops with increasing ambient temperature as a function of ambient air temperature. Net full load *BHP* is shown for 3 fan combinations, i.e., 20, 30, and 40 fan hp, respectively, at 125°F ambient. The water temperature lines shown on Fig. 8-43 indicate the temperature at which the coolant will operate vs various engine powers, ambient temperatures, and installed fan *HP*. This curve shows, for example, if a 40 hp fan were used and a 220°F top tank water temperature selected, satisfactory cooling could be realized at 125°F ambient temperature. However, if only a 20 hp fan were used, the operation would have to be limited to 96°F ambient or the allowable top tank water temperatures would need to be increased to approximately 240°F (Fig. 8-43). A cross plot of the required fan *HP* at 220°F water temperature vs ambient air temperature, Fig. 8-44, is presented to show how seriously the required fan *HP* increases with increased ambient temperatures. System reliability and component life also may be adversely affected.

This study indicates that a practical alternative may be to apply a fuel flow (power) limiting device that is responsive to a coolant temperature. This will limit the engine power at high coolant temperatures, thus allowing minimum fan *HP* requirements while preventing overheating. This will sacrifice vehicle performance at high ambient temperatures, and gain performance and economy at low ambient temperatures. This is a trade-off that the vehicle system engineer can make in optimizing the user's overall objectives. A fuel limiting device of this type currently is used by the Mercedes Benz liquid-cooled 1500 hp engine that powers the German Leopard Tank (see Fig. 3-34).

AMCP 706-361

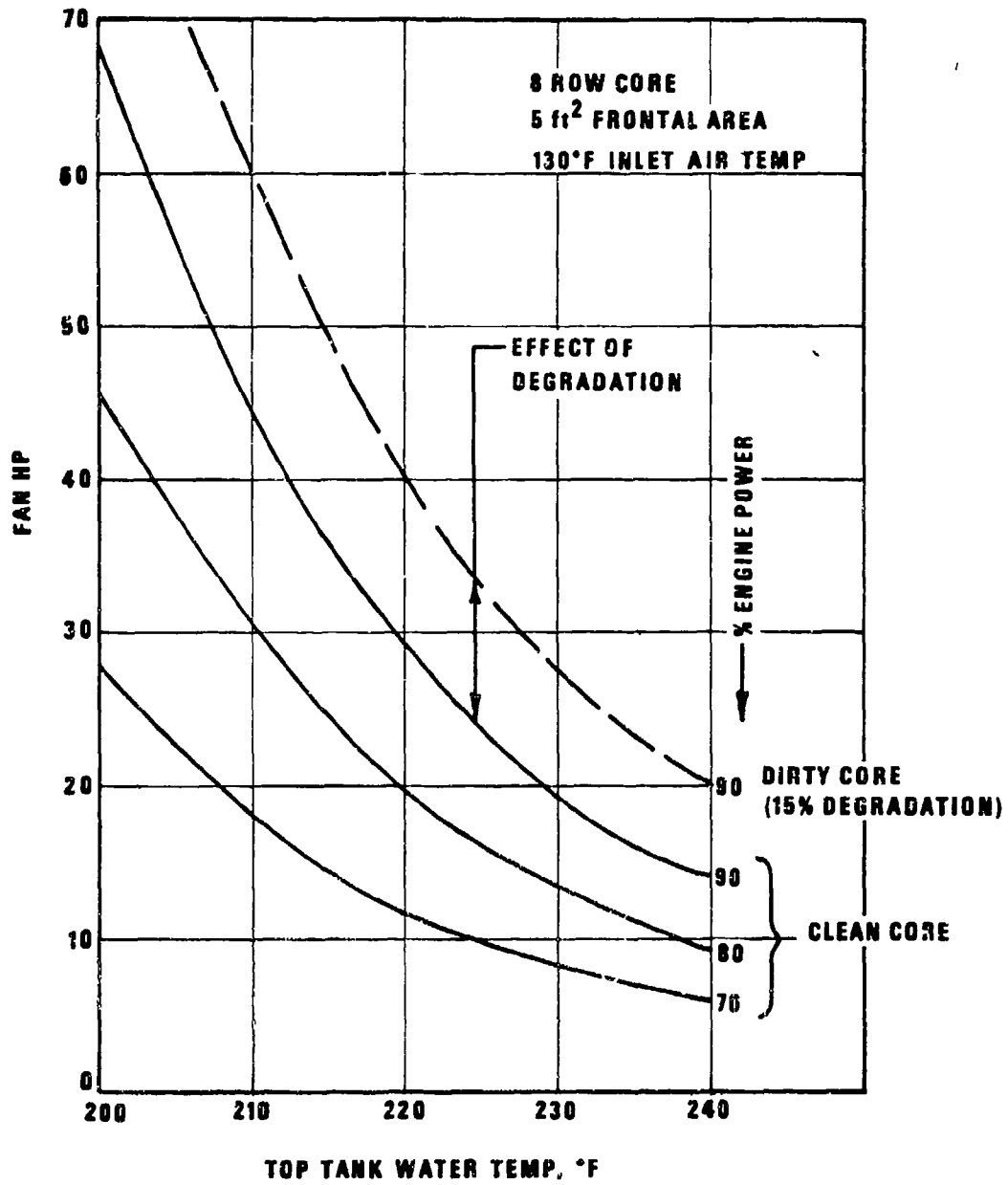

Figure 8-40. Parametric Cooling Study vs Water Temperatures and Engine Power

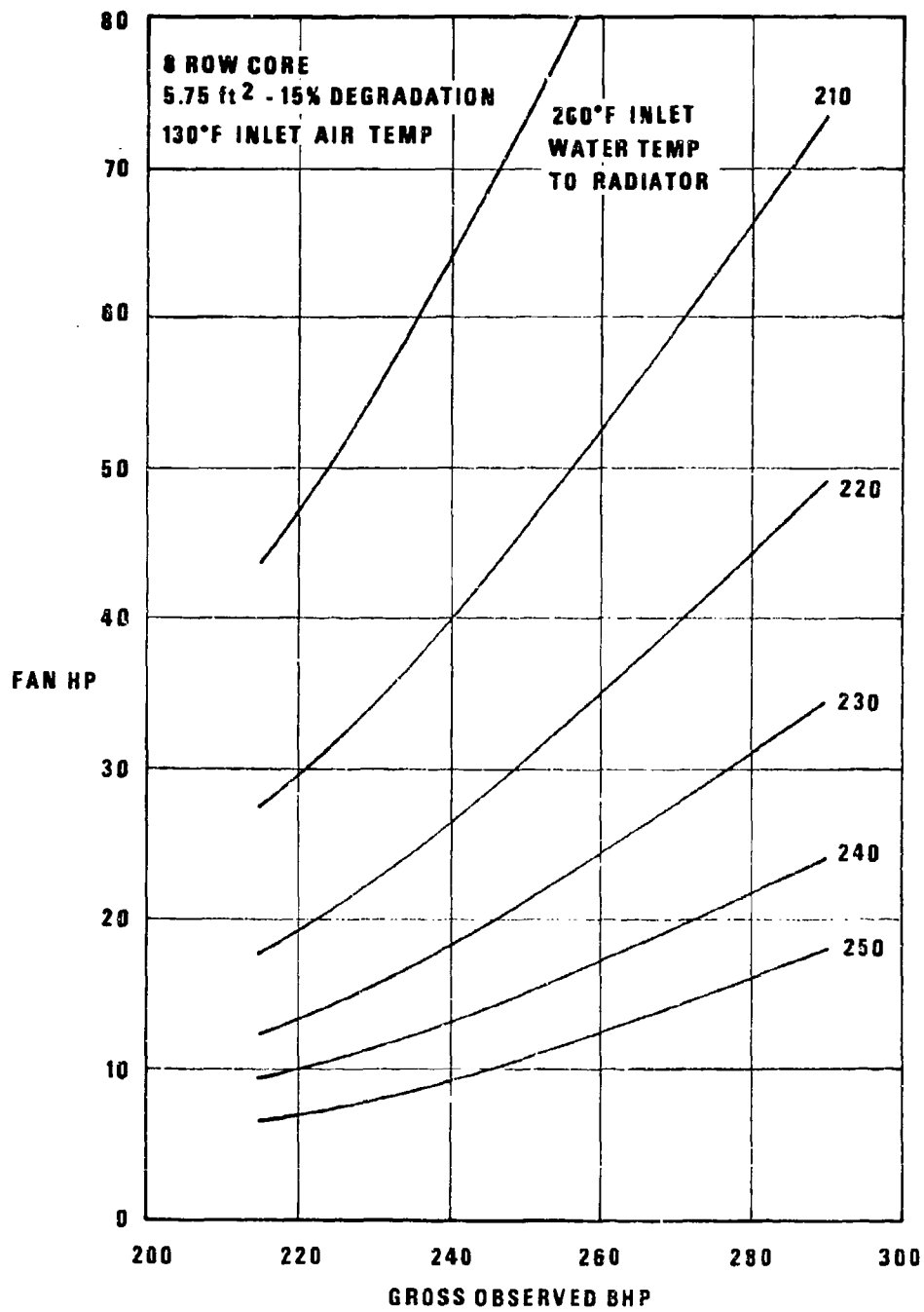

Figure 8-41. Cooling System Performance vs Gross Engine Power

AMCP 708-381

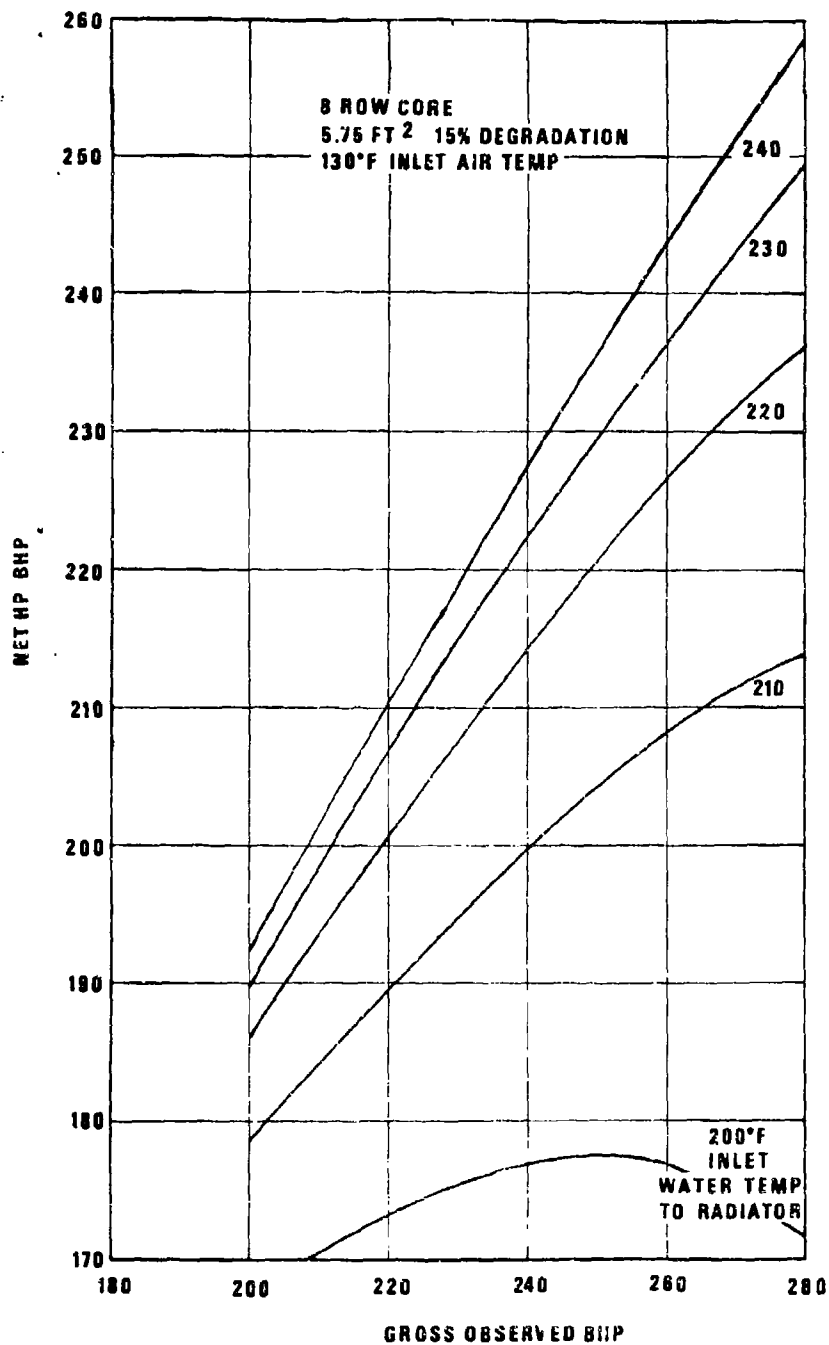

Figure 8-42. Engine Net Performance vs Gross BHP and Coolant Temperature

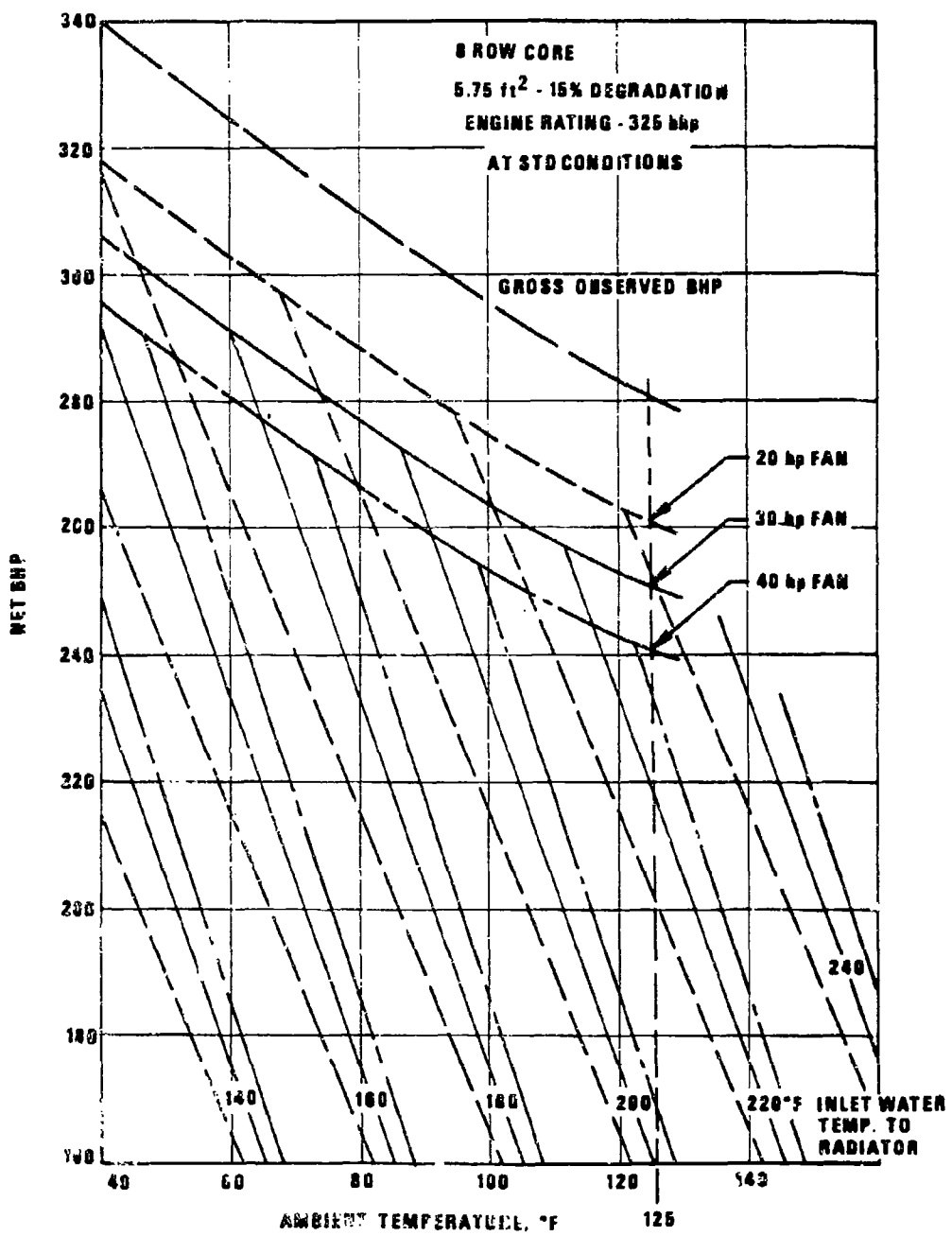

Figure 8-43. Engine and Cooling System Performance vs Ambient Temperature

AMCP 706-361

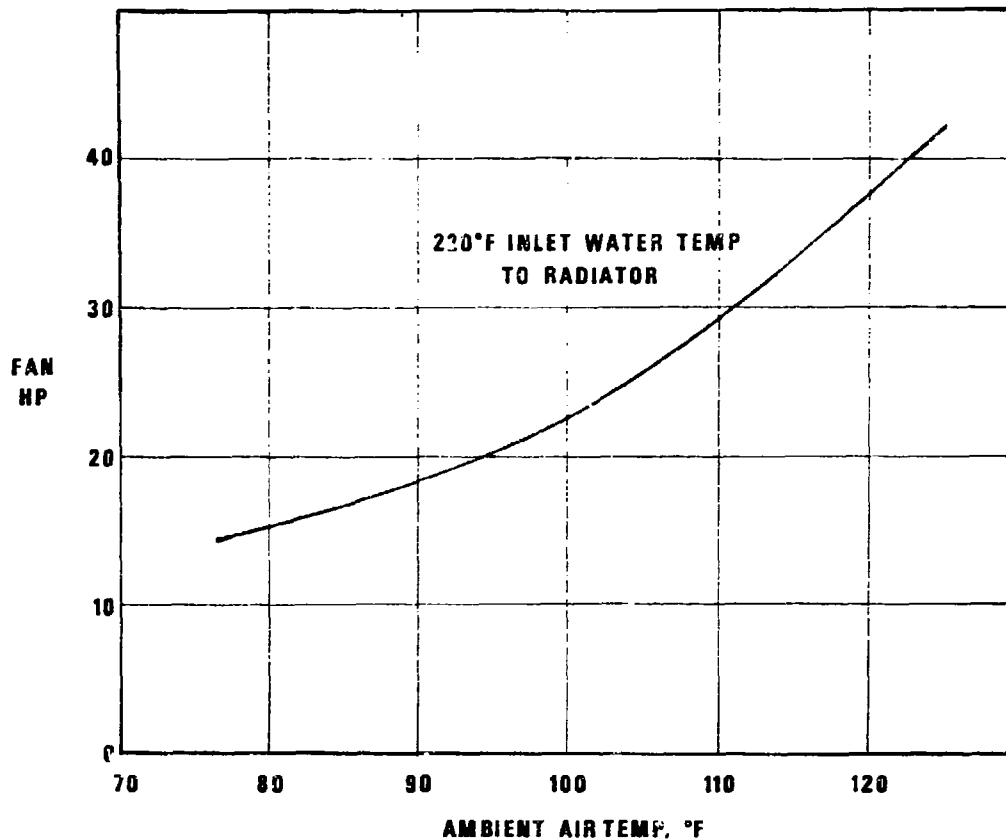

Figure 8-44. of Ambient Temperature on Required Fan Power

REFERENCES

1. W. E. Woodson and D. W. Corover, *Human Engineering Guide For Equipment Designers*, University of California Press, Los Angeles, Calif., 1970.
2. AMCP 706-134. *Engineering Design Handbook, Maintainability Guide for Design*, 1972.
3. W. F. Isley, *AVCR-1100-3B Cooling Characteristics Analysis*, Report PA-114, Teledyne Continental Motors, Warren, Michigan, April 1971.
4. S. G. Berenyi, *The High Temperature Cooling Characteristics of the AVCR-1100-3B Engine As Installed In An MBT/XM803 Vehicle*, Report No. TN AVCR-1100-3B-416, Teledyne Continental Motors, Muskegon, Michigan, December 5, 1972.
5. TM 38-760. *System Engineering Summary*, November 1973.
6. Earl Bell, *Coordinating the Complete Cooling Package*, Paper No. 720717.

AMCP 706-361

Society of Automotive Engineers, Inc.,
New York, N.Y., 1972.

7. William C. Whitcomb, *Full Load Cooling
Evaluation and Heat Rejection of M114*

(PIP) *Vehicle Cooling Buck*,
(USATACOM, E. J. Rambie, AMSTA-
RGL, was in charge of the new system
design), Memo Report No. RGE-73-4, US
Army Tank-Automotive Command, War-
ren, Michigan, December 1973.

BIBLIOGRAPHY

Neal A. Cook, *Economic Factors in Radiator
Selection*, Paper No. 720714, Society of

Automotive Engineers, Inc., New York, N.Y.,
1972.

CHAPTER 9

TEST AND EVALUATION

This chapter describes the test and evaluation procedures applied during the vehicle cooling system development, including findings from several cooling tests. These tests include evaluation of complete cooling systems in vehicles, heat exchangers, radiators, engine/transmission oil coolers, fans, coolant pumps, grilles, and surge tanks. Methods for testing and determining the heat transfer capabilities and flow friction characteristics of items in the cooling system are described.

9-1 IMPORTANCE OF VEHICLE TESTS

The importance of a properly designed and tested vehicle cooling system is apparent since a cooling failure immobilizes the vehicle. The many variables present in a cooling system make it difficult for the designer to arrive at the "ideal design". The actual testing and evaluation of the complete system in the vehicle confirms or disproves the proper functioning of all cooling components.

Combat and field conditions to which the vehicles are subjected vary greatly, for example, wartime conditions differ from peacetime conditions. Many instances are documented where cooling problems have surfaced after the vehicle was fielded, requiring initiation of Product Improvement Programs (PIP) to correct the deficiencies.

9-2 REQUIREMENTS FOR COMPONENT TESTS

Throughout the vehicle development cycle, the requirements for individual component testing exists. Component tests are required:

1. To determine the difference in performance between the analytical model and the hardware
2. To evaluate performance under controlled environments and conditions

3. To select optimum components from multiple options to permit efficient total system testing from a time/cost basis

4. To determine conformance with or establish specifications

5. To accomplish accelerated endurance testing.

9-2.1 HEAT EXCHANGERS

Individual component tests often are conducted on heat exchangers prior to the testing of a new vehicle and during Product Improvement Programs of an existing military vehicle. It must be recognized that published heat exchanger rejection rates are based on ideal installation conditions. Seldom are these conditions duplicated in a military vehicle.

9-2.1.1 Radiators

Component tests for radiators are outlined in Military Specification MIL-R-45306 (Ref. 18). The portion of the specification concerned with test and evaluation is found in Appendix D. A schematic diagram of a typical radiator test rig is shown in Fig. D-1.

Fig. 9-1 illustrates a test laboratory for conducting cooling component tests under simulated engine operation (radiators, oil-coolers, etc.).

AMCP 70S-361

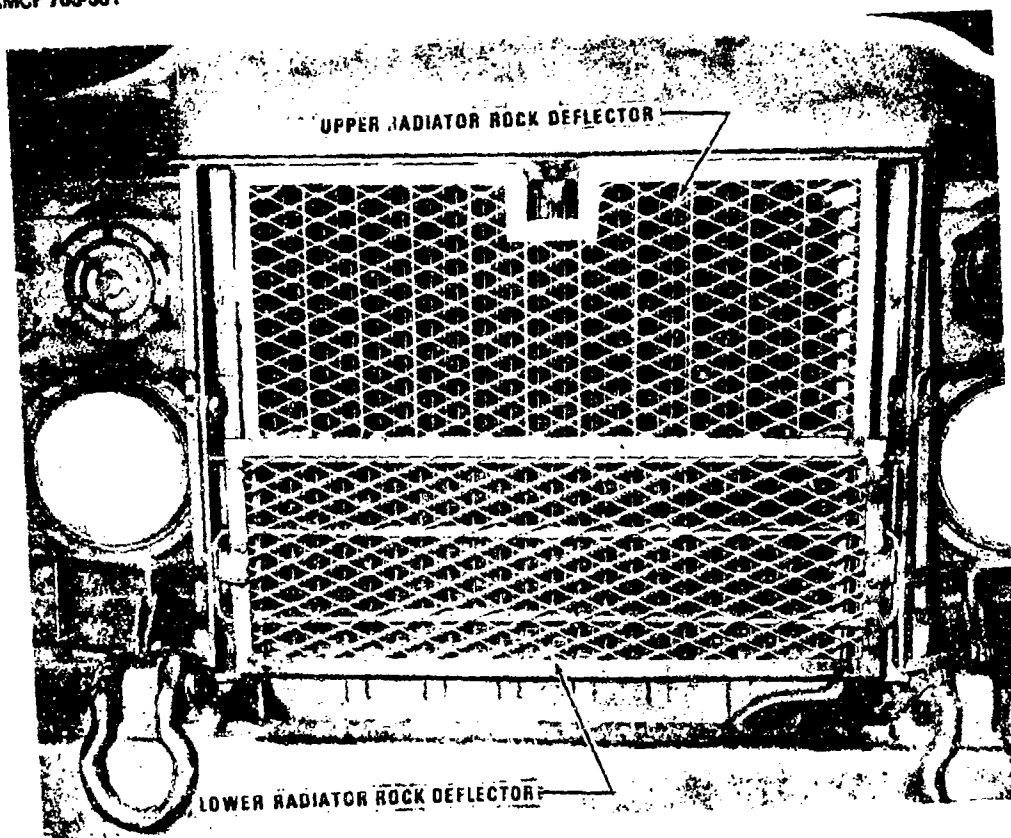

Figure 9-1. Test Laboratory Cooling Component Test Equipment Set-up (USATACOM)

9-2.1.2 Engine/Transmission Oil Coolers

Component tests are run on engine/transmission oil coolers to ensure that the coolers meet the prescribed specifications. The coolers use either air or water as the cooling medium. The performance and endurance test specifications normally are called out on the cooler drawings. Typical test specifications and test procedures are outlined in Appendix D, par. D-2, for both air- and water-cooled oil coolers.

9-2.1.3 Miscellaneous Coolers

Coolers are used in military applications peculiar to various vehicle or engine specifications. Induction air aftercoolers and fuel-

coolers are examples of coolers installed to meet special requirements.

Induction air aftercoolers are installed on high output diesel engines to increase the power output by increasing the density of the inlet air charge from the supercharger.

Coolers can be employed on some diesel engines to reduce the fuel temperature at high ambient temperatures in an effort to maintain fuel density and minimize fuel oxidation. A constant fuel density enables the diesel engine to supply nearly the same horsepower with variations in ambient air temperatures.

Test specifications for the coolers normally are shown on the engineering drawings. The

method and type of test conducted are similar to those tests conducted on the engine/transmission oil coolers as described in appendix D, par. D-2.

9-2.2 FANS

The fan airflow often is restricted as a result of vehicle imposed installation compromises. The effect of fans not centered in the heat exchanger, and irregular shrouding and obstructions -- such as the engine, transmission, accessories, hoses, and other cooling system components -- cannot be analytically determined. Fan testing is done to determine these effects and normally is accomplished during mock-up tests of the complete cooling system as discussed in par. 9-3; however, a new design must be performance tested. A fan performance test procedure is given in appendix D, par. D-3. The AMCA Standards for airflow nozzles and flow straighteners are shown on Fig. D-7 (See Ref. 13).

Another test which may be conducted as part of the fan performance testing is sound level measurement. This test is conducted according to AMCA Standard 300-67 *Test Code for Sound Rating* (Ref. 14). Also see Ref. 15.

9-2.3 COOLANT PUMPS

Coolant flow rates are supplied by the engine manufacturers, and the values normally are specified for no inlet restriction to the coolant pump and a specified pressure in the engine block. Nonconventional coolant systems with external thermostat housings, long coolant pipes, and additional elbows and hose connections all contribute additional coolant flow resistance to the system. These designs should be evaluated by test to determine the actual coolant flow characteristics.

The effect of inlet pressure on the coolant pump flow rates and coolant pump pressure rise for the model L1S-465-1A diesel engine is shown in Fig. 9-2. The pressure and flow

rates remain relatively constant until cavitation occurs. Note that this is a function of both coolant temperature and inlet pressure.

A report of a water pump test is included for reference in appendix D, par. D-4 (Ref. 17).

9-2.4 GRILLES

Grille airflow tests may be conducted individually as described in Chapter 6 or evaluated as part of the system resistance test as described in par. 9-3. The preferred method is to evaluate the grilles in the system resistance test. This test simulates the actual vehicle compartment configuration.

9-3 COOLING SYSTEM

The cooling system is a major vehicle subsystem and specific vehicle tests are conducted to fully evaluate cooling performance. The process of evaluation, modification, and retest of cooling system components is conducted during the normal vehicle testing program.

Vehicle cooling tests are conducted during the major test and evaluation programs defined in AR 70-10 (Ref. 1). The maximum cooling requirements for a new vehicle (and sometimes during a PIP for an existing vehicle) normally are specified in terms of ambient temperature requirements (AR 70-38, Ref. 9) and vehicle operating conditions. Maximum stabilized temperatures of engine oil, transmission oil, and liquid coolant at a prescribed ambient temperature condition are used to define the cooling requirement. To conform with worldwide climatic categories of AR 70-38, the vehicle cooling system should be designed for operating in ambient air temperature up to 125°F at sea level. The vehicle operating conditions are used to determine the maximum cooling requirements of a new vehicle and generally are specified at two conditions. The first condition specifies that the vehicle must operate at full load

AMCP 708-381

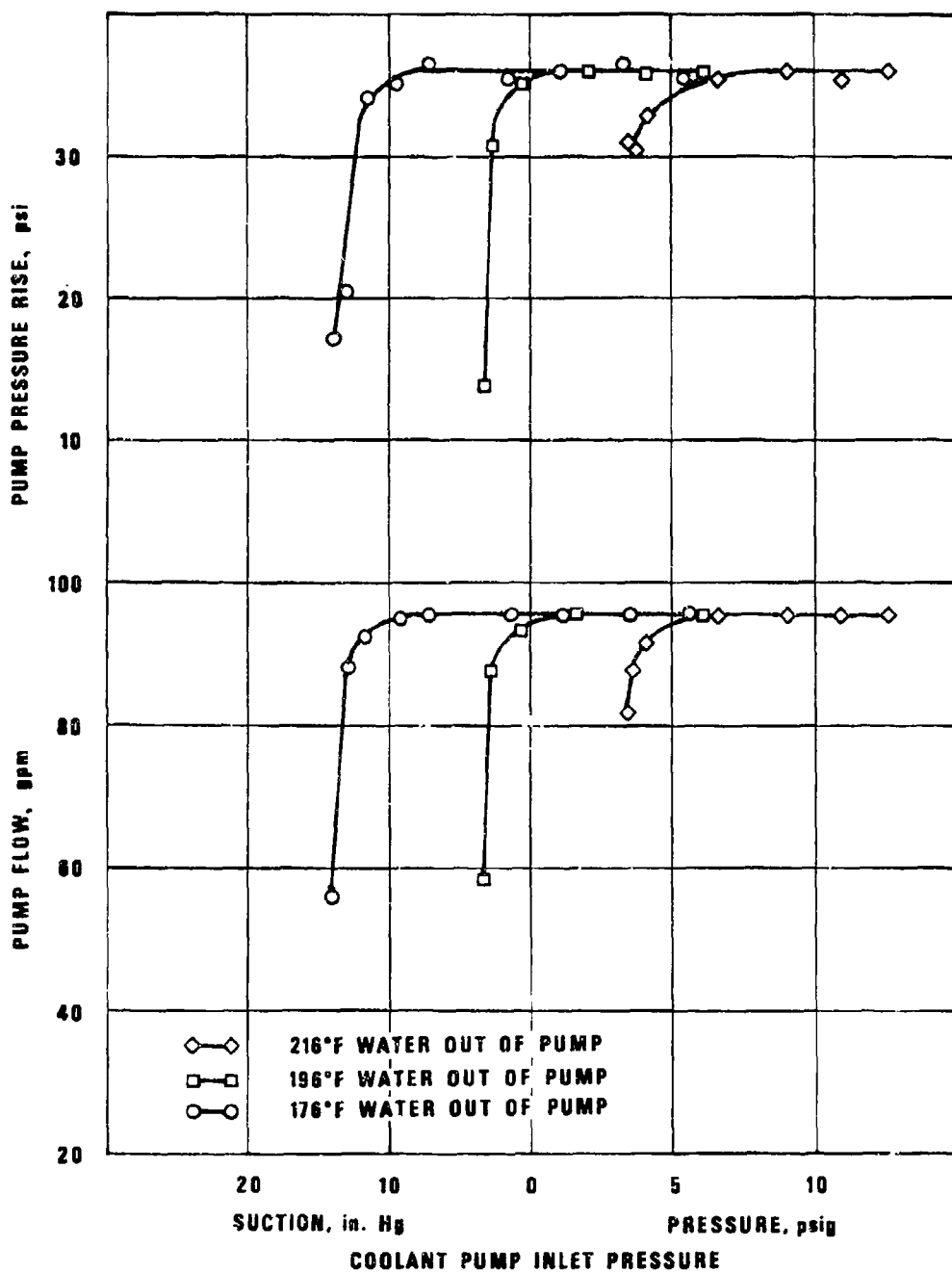

Figure 9-2. LDS-465-1A Diesel Engine Coolant Pump Performance With Varying Inlet Pressure (Ref. 28)

maximum vehicle speed in any specified gear range (maximum engine cooling requirement). In some instances the maximum engine cooling requirement may occur at other than the rated speed for maximum horsepower. The second condition specifies that the vehicle is expected to operate at the tractive force required to make the track or wheels slip (maximum transmission cooling requirement). This second condition applies to vehicles with an automatic or semi-automatic transmission equipped with a torque converter and may result in a vehicle operating condition as low as a 0.4 to 0.5 converter speed ratio. These requirements should be established by the vehicle performance specifications.

9-3.1 COOLING SYSTEM VEHICLE SIMULATION TESTS

Specific tests simulating the vehicle cooling system normally are run to evaluate fully the cooling system component performance prior to total vehicle cooling tests.

9-3.1.1 Cold Mock-up Tests

To provide early design guidance for the vehicle cooling system, a mock-up of the proposed power package and vehicle power package compartment is made to evaluate cooling system components and arrangement options.

A cold mock-up, used for the MBT70 Prototype Tank preliminary cooling system evaluation, is illustrated in Fig. 9-3. The engine normally is operated at no-load for this evaluation because system air resistance and cooling airflow are nearly independent of engine load. The engine employed in the MBT70 Prototype Tank was the Teledyne Continental Motors air-cooled AVCR-1100 diesel engine. Consequently, all coolers used air as the cooling medium.

The pressure drop across various components in the cooling airflow path can be

measured using static pressure drop ΔP pickups. Acceptable static pressure test results can be obtained employing sintered ball or multiorifice type pickups. When measuring ΔP across a cooler core, the pickup should be placed 0.25 to 0.5 in. away from the core surface.

A relatively large number of pressure readings should be obtained across any component that presents a large face area to the cooling air path. The large number of readings are required to ensure that a correct average value is obtained. As an example, an air-to-oil cooler with a core 3 ft wide and 2 ft high requires about nine pressure measuring points to determine an accurate pressure profile. The airflow also can be measured, if the cold mock-up is instrumented sufficiently. The airflow is measured on either the inlet or outlet side of the cooler, depending on the case of installation and available instrumentation.

The changes in pressure drops and airflow are used to determine the optimum cooling component location and size to be used in further cooling tests such as the hot mock-up.

The determination of cooling system resistance in a cold mock-up also can be obtained by using wooden mock-ups with simulated component subassemblies (see Ref. 3) without an operating engine.

The wooden mock-up of the engine/transmission compartment is constructed to simulate engine/transmission airflow restrictions with adjustable engine and heat exchanger plate openings. For an air-cooled engine power pack, simulated openings for engine cylinders and oil-coolers are calibrated separately at various airflows to correspond to cooling airflow requirements of each of the components. The air moved through the system is supplied by a test facility blower. With the simulated openings calibrated and secured, the system resistance is determined by airflow tests of the system complete with grilles.

AMCP 706-361

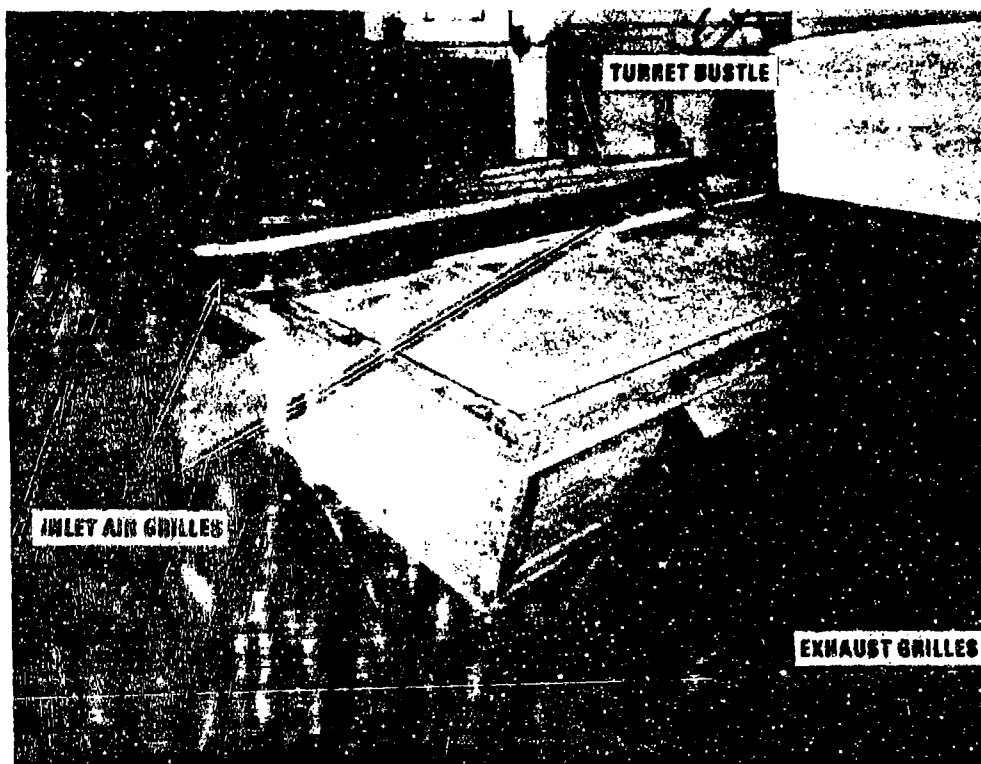

Figure 9-3. MBT70 Prototype Tank Cold Mock-up for the AVCR-1100 Engine With Turret Bustle in Gun Forward Position

9-3.1.2 Hot Mock-up Tests

Hot mock-up tests provide a means to evaluate cooling system and component performance simulating actual conditions under laboratory controlled conditions.

The hot mock-up is a cooling system power package compartment similar to the vehicle system, or it may even be the complete vehicle, connected to a dynamometer. As shown in Fig. 9-4, solar radiation may be simulated by lamps, and the test cell air is heated to the required test ambient conditions.

The MBT70 Prototype Tank hot mock-up installation is shown in Fig. 9-5. This test

employs a simulated compartment for power package and cooling system components instead of the complete vehicle. No provisions were made to simulate the effect of solar radiation. A description of this particular test is found in Ref. 5.

A complete list of the instrumentation and schematics of the installation for the XM803 Experimental Tank hot mock-up is included in Appendix D, par. D-5. The XM803 Experimental Tank test was run primarily to evaluate the cooling ability of the Teledyne Continental Motors air-cooled AVCR-1100-3B engine installed in a mock-up of the vehicle engine compartment. This mock-up was fabricated from steel sheet and plates. The removable fuel tank mock-ups surround-



Figure 9-4. XM571 Vehicle Hot Mock-up With Simulated Solar Radiation (Ref. 23)

ing the engine were fabricated from aluminum and plywood.

The engine induction air was supplied by the test cell system. This air was drawn from outside and passed through a filter and cooler before entering the test cell air blower room. This centrifugal blower had a manually controlled airflow outlet restriction. Air then was directed through a heater unit before being ducted into the test cell. In the test cell, the air was divided into left and right bank branches. Each branch had an airflow measuring device. Air from each branch was ducted to the vehicle air cleaner through 6-in. flexible tubes.

Cooling air for the engine was supplied from outside and was heated to the desired

temperature. Air entered the engine compartment through the vehicle inlet duct. The airflow path through the engine is shown in Fig. D-8.

The cooling air pressure was measured through the vehicle exit duct. At the exhaust grille, the exhaust gases and cooling air were separated.

Cooling air pressure was measured in appropriate positions throughout the system to determine pressure drops through various portions of the engine hot mock-up. Extensive measurements of temperatures were recorded in the cooling system for determining heat rejection and airflows.

Approximately 45 ft from the exit grille, a

AMCP 706 361

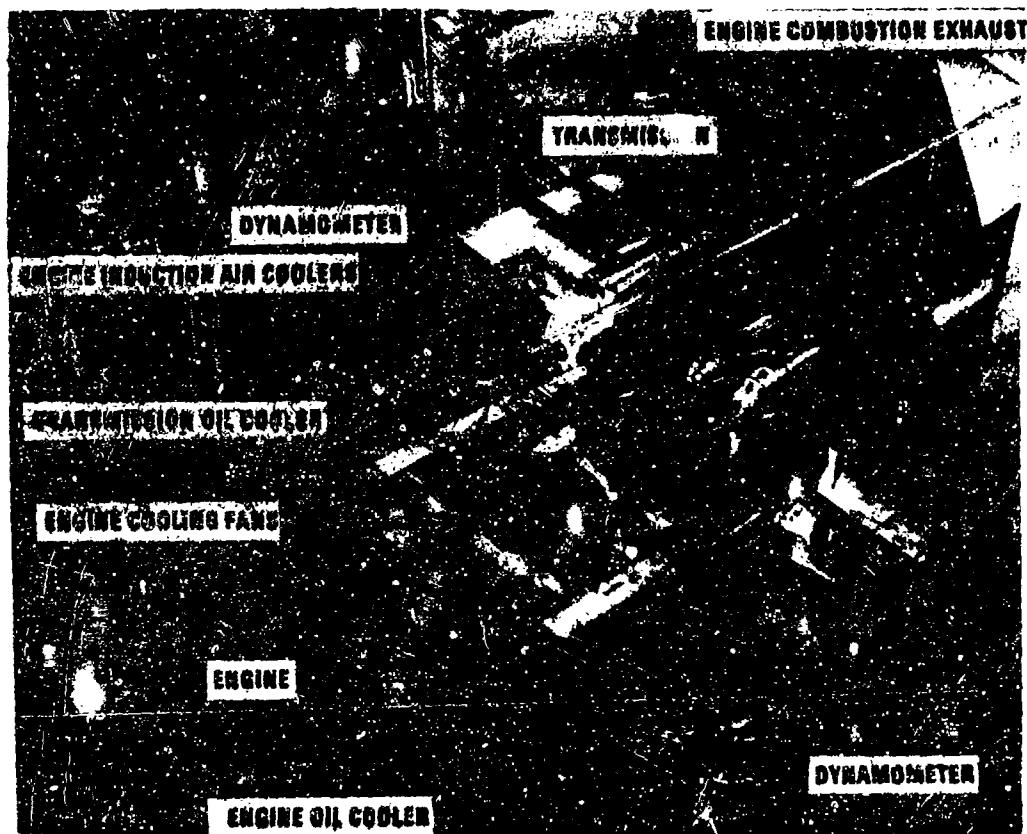

Figure 9-5. Hot Mock-up of the MBT70 Prototype Tank Power Package and Cooling System

station was set up to measure gas flow in the duct with a pitot-static tube. Slip fittings on the duct enabled the pitot-static tube to be traversed vertically within the duct in three positions to determine the velocity profile. A heavy gage wire mesh was installed in the duct about 20-ft upstream from the measuring station in an attempt to flatten the velocity profile.

Exhaust gas temperatures and pressures were monitored on all test points. Exhaust gas temperatures were measured at each cylinder exhaust stack, at the turbocharger turbine inlets, and before the exhaust ejector. Exhaust pressures were measured at the two turbine inlets of both left and right turbochargers.

The engine lubrication system is self-contained, however, routing of some oil lines was altered for oil flow determinations. Oil flowmeters were installed in both the left and right bank lines to measure flow to the oil-coolers. Temperatures of the oil to and from the coolers were measured to determine heat transfer rates (see Fig. D-8).

Critical engine metal temperatures were recorded. These consisted of all cylinder head temperatures, cylinders No. 6 left and No. 1 right, and outboard cylinder flange temperatures.

A large number of temperature and static pressure readings are required on the coolers to provide a pressure and temperature profile.

This procedure is described in par. 9-3.1.1. The tips of the thermocouples used to measure air temperatures in the hot mock-up must not contact any component and may need thermal radiation shielding.

Hot mock-up tests for liquid-cooled military vehicles usually are run in a facility that can control engine speed and load, air temperature, airflow, and radiant heat load.

To determine heat rejection, the thermostat bypass is blocked to the hot position. Coolant, oil, and air flow are measured. Temperatures are measured throughout the coolant and lubrication system, and across the air side of the radiator. Engine and transmission oil cooler heat rejection rates are calculated separately.

Two different methods of reporting engine cooling capacity independent of the particular ambient test temperature are used:

1. Coolant temperature and oil temperatures corrected for specified ambient temperature. Normally the coolant and oil temperatures are reported as corrected to a specified ambient temperature on a degree for degree basis. This is done for the radiator coolant as well as the engine and transmission oil stabilized temperatures where

$$\begin{aligned} \text{Corrected} \\ \text{Temperature} &= (\text{Observed Temperature}) \\ &+ (\text{Specified Ambient} \\ &\quad \text{Temperature}) \\ &- (\text{Test Ambient Tem-} \\ &\quad \text{perature}), ^\circ\text{F} \quad (9-1) \end{aligned}$$

2. Air-to-boil (ATB). The extrapolated test ambient temperature at which the coolant would boil is reported as

$$\begin{aligned} \text{ATB} &= (\text{Test Ambient}) \\ &+ (\text{Coolant Boil Temperature}) \end{aligned}$$

– (Observed Coolant Temperature at Radiator Top Tank), $^\circ\text{F}$ (9-2)

The first method of reporting does not relate to the type of coolant used or the pressure cap. Therefore, it gives no information as to how far the system is from boiling without considering other data such as the coolant boiling point or the air-to-coolant temperature difference at which boiling occurs. This method gives emphasis to the level of the coolant temperature and normally is used in military specifications.

The ATB method relates only to the coolant boil point and provides information as to how far the cooling system is from boiling under specified conditions. The ATB method gives no indication of oil temperature limits that also must be considered. It also permits direct comparison between systems with different pressure caps or different coolants insofar as degree of protection from boiling is concerned. However, it gives no direct information as to the actual coolant temperature unless the boiling point is specified. This method gives emphasis to protection of the cooling system from coolant boiling.

Full load and idle cooling tests usually are conducted by operating until stabilized temperatures are reached or until the coolant boils, whichever occurs first. Test results are recorded in three different ways:

1. Stabilized coolant temperature reached at "X" minutes
2. Minutes to boil
3. Coolant temperature at 30 min (understood to be still rising).

Methods of correcting the recorded data for test ambient are given as follows:

1. The stabilized coolant temperature may be corrected directly for test ambient over a

AMCP 706-361

moderate ambient range. Normally a degree-for-degree correction is applied except if a specific test has been conducted to demonstrate a relationship other than degree-for-degree for a specific vehicle.

2. The minutes to boil cannot be corrected directly for test ambient. However, if coolant temperatures are recorded at frequent intervals up to the boil point, the curve of coolant temperature versus time may be corrected for test ambient and the corrected time to boil read from the adjusted curve. If the test is conducted at a temperature higher than the specified ambient temperature, it is desirable to use a higher than standard pressure cap. This is to permit running to a coolant temperature above the normal boiling point so that, after temperatures are corrected downward, this corrected curve will still intersect the boil temperature.

3. If the temperature is still rising at 30 min, corrections similar to those for minutes-to-boil are required.

9-3.1.3 Cooling System Deaeration Requirements

Cooling systems for gasoline engines usually are not required to separate any air other than that contained in the coolant system at start up. However, it is entirely possible to have air bubbles flowing from the engine at temperatures of 180°F and higher with a pressurized coolant system. In the gasoline engine system, air is separated in the radiator top tank at the overflow location. The higher combustion pressures associated with the diesel engine may allow more gas into the coolant system. These gases must be separated and eliminated from the system to prevent them from causing air locks or driving the coolant from the system. To determine the acceptability of a proposed cooling system, a series of tests are run which examine the system ability to expel air. A test example is given in appendix D, par. D-6.4.

9-3.1.4 Test Rig

Power package and cooling system components often are evaluated in a test rig prior to the assembly of the first prototype vehicle. The test rig is usually a similar vehicle modified to duplicate the power package installation.

An example of a cooling test rig is the M48 Tank with the M60 Tank power package installed. This test rig was fabricated and tested to determine the engine oil cooler airflow characteristics that could be expected in the M60 installation (Ref. 6). Another example of a test rig is the M114 vehicle. In the M114, the original vehicle hull of the M114 was modified to accept a new power package configuration. This was then classified as an M114_g(PIP) cooling test rig, and cooling tests were conducted to verify the cooling system performance.

9-3.2 TOTAL VEHICLE TESTS

After the development tests have been completed on the cooling system components, subsystems, mock-ups, and test rig, the total vehicle must be tested to demonstrate the cooling ability of the vehicle. A cooling safety margin, between hot mock-up results and the specified temperatures, must exist if the vehicle is to be successful in the field. Coolant degradation must be anticipated due to such items as plugging of coolers and radiators by dirt and/or debris, internal scaling, and flow resistance.

Total vehicle cooling system tests are associated with either the initial design and development of a vehicle system or with a product improvement program. Product improvement programs are initiated when a problem is discovered after a vehicle is fielded or where existing equipment is to be repowered or updated.

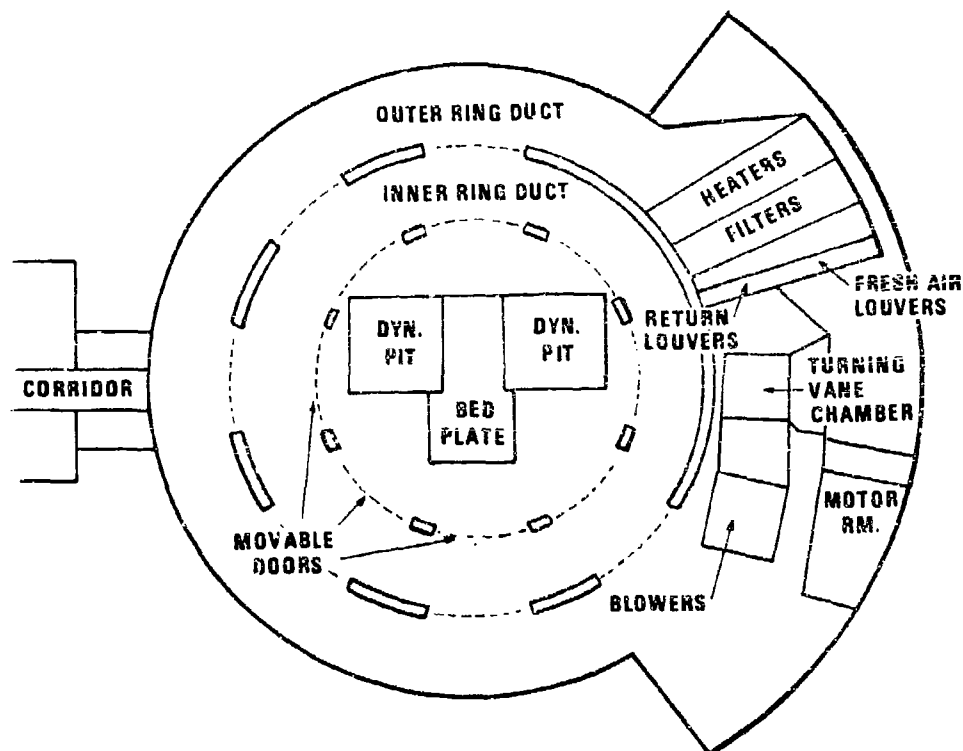

Figure 9-6. USATACOM Propulsion Division Vehicular Test Cell

9-4 EXAMPLES OF VEHICLE COOLING PROGRAM TESTS

Vehicle cooling verification and product improvement programs have been conducted on a number of military units. To illustrate typical examples of the programs completed, the M113A1, M110, M551, and M561 programs will be reviewed. A complete test plan for the M110 is included in Appendix D, par D-7. Also see Refs. 26 and 27 for additional wheeled vehicle cooling tests.

9-4.1 TEST FACILITIES, METHODS, AND PROCEDURES

All the vehicle tests discussed here except the M551, were conducted in the

USATACOM Propulsion System Division vehicular test cell. The USATACOM test chamber is 80 ft in diameter and has a 40 ft maximum usable height (see Fig. 9-6). Wind direction can be changed through 360 deg in 45-deg increments and wind velocity maintained up to 20 mph. The total sprocket output load absorbing capacity of 128,000 lb-ft of torque at stall and 88,000 lb-ft. at 15 rpm per side, permits testing of any known vehicle in any transmission gear range.

Each of the vehicles tested was positioned in the test cell and connected to the dynamometer. The M113A1, M110, M551, and M561 test cell installations are shown in Figs 9-7, 9-8, 9-9, and 9-10, respectively.

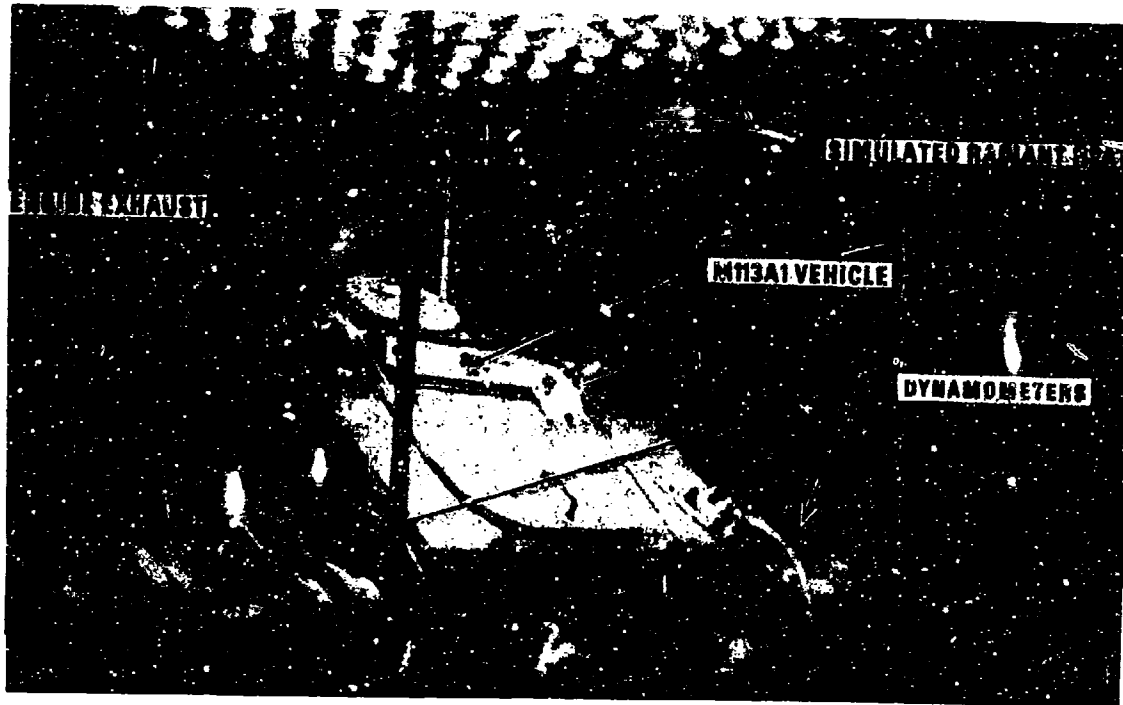

Figure 9-7. M113A1 Vehicle Cooling Test Installation (USATACOM)

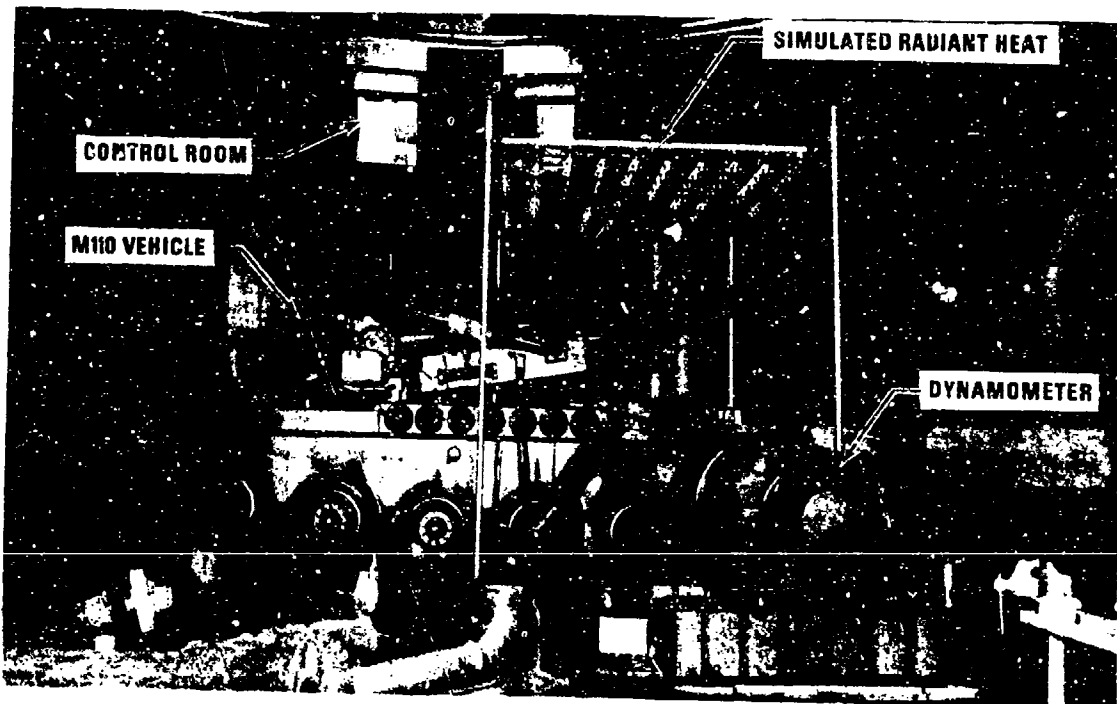

Figure 9-8. M110 Vehicle Cooling Test Installation (USATACOM)

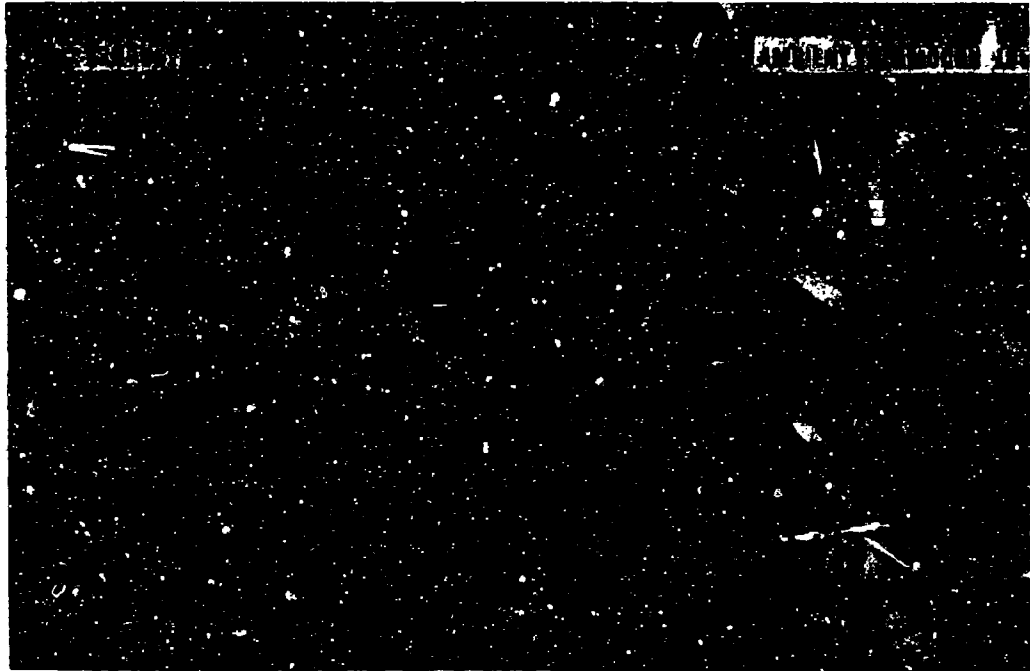

Figure 9-9. M551 Vehicle Cooling Test Installation (USATACOM)

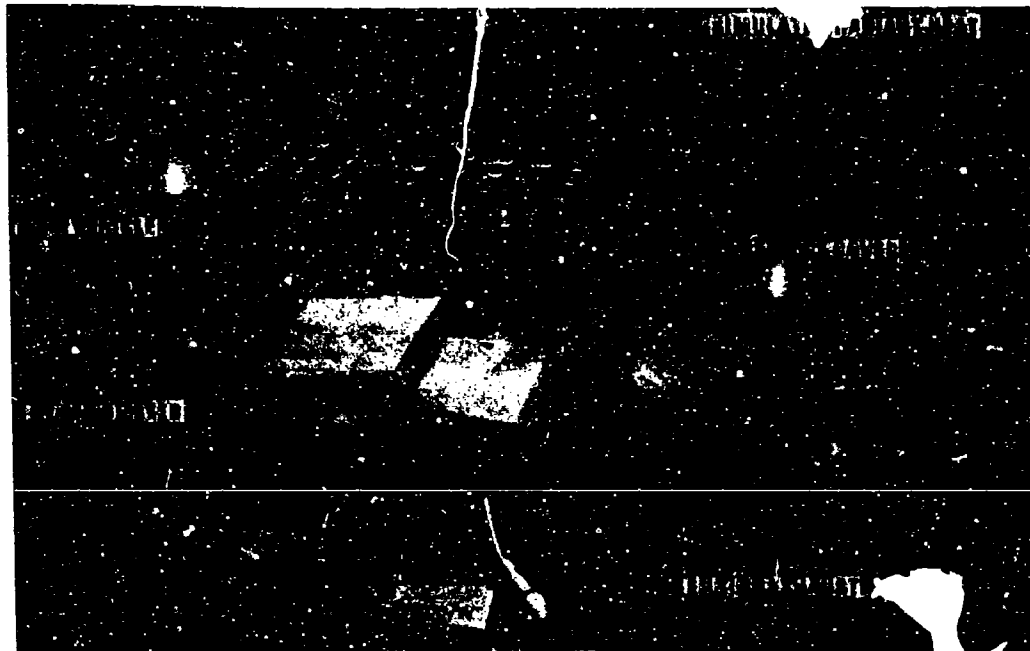

Figure 9-10. M561 Vehicle Cooling Test Installation (USATACOM)

AMCP 706-361

Each vehicle was instrumented to measure critical temperatures, pressures, and related data. After an initial vehicle checkout was made, stabilized vehicle cooling tests were conducted. Cooling tests normally were conducted with 5 mph wind velocity and a light bank above the vehicle to simulate solar radiation. Normally, the light bank was positioned to provide 360 Btu/ft²-hr on the vehicle decks. A cooling test was considered stabilized when three consecutive readings, each 10 min apart, showed a change of 1 deg F or less in a critical temperature. In general, these vehicle tests were conducted to:

1. Measure the adequacy of the production vehicle cooling system, under controlled laboratory conditions, simulating field operating conditions
2. Determine if modifications are required to the vehicle cooling system and conduct comparison tests
3. Obtain test results to be analyzed to provide the basis for recommendations for improving vehicle cooling.

9-4.2 M113/M113A1 COOLING VERIFICATION AND PRODUCT IMPROVEMENT PROGRAM TESTS (Refs. 11 and 19)

9-4.2.1 General

The M113/M113A1 Full Tracked Armored Personnel Carrier is a multipurpose vehicle fielded by the US Army in the early 1960's. It carries up to 12 men as a personnel carrier. It also can be used as a cargo, litter, weapon carrier, command post, or a reconnaissance vehicle.

Intended principally for operation over all types of cross-country terrain, the vehicle has a water-tight hull of welded aluminum which affords both armor protection for the men inside and allows the vehicle to swim streams and rivers. The mobility of the vehicle

resulted in its becoming the workhorse of the Army vehicle fleet.

The early model M113 was equipped with a 200-hp gasoline engine. In the late 1960's the M113A1 came into being. The M113A1 basically was identical to the M113 except that it incorporated a diesel engine.

The M113/M113A1 saw extensive combat service. Used by US and Allied Forces, it has fulfilled all the missions envisioned and through field adaptations has had new roles added. It has been used as an assault vehicle, used to clear jungle, and used as a recovery vehicle. The combination of high load operation, poor maintenance, and extremes of terrain and climate began to take its toll and cooling problems began to surface.

9-4.2.2 Cooling Test Objectives

Objective 1. The initial test objective was to determine if the as-received vehicle cooling system was adequate to maintain the engine coolant and transmission oil temperatures within the allowable temperature limits of 230°F coolant and 300°F transmission oil (Ref. 19) at 115°F ambient.

Objective 2. The final test objective was to develop test data to form a basis for adequate cooling system improvements as required in order to permit the vehicle to meet the specified temperatures under high ambient field operating conditions.

9-4.2.3 As-received Vehicle Cooling Test Results

At 115°F ambient temperature under the most severe design operation conditions (0.4 converter speed ratio), the as-received vehicle equipped with production components failed to meet the established temperature limits for coolant and transmission oil. The projected temperature of the transmission oil to the cooler exceeded the limit by 24 deg F and the coolant temperature exceeded the limit by 17

deg F. Fig. 9-11 shows the temperature characteristics during testing at various torque converter speed ratios and lock-up. The actual test cell temperature was limited to 98°F to prevent the vehicle temperature from exceeding the maximum specified limits that could result in damage to the power package components. Test temperatures were extrapolated to 115°F ambient conditions on a degree-for-degree basis.

Tests were conducted with and without simulated solar radiation. When solar radiation was simulated at a rate of 431 Btu/hr-ft², only a 2 deg F difference in coolant temperature was noted.

9-4.2.4 Modified Vehicle Cooling Tests

A series of tests was conducted with modifications intended to reduce the coolant and transmission oil temperatures. The modifications included changes to the radiator, fan speed, and engine mufflers.

The effects of the vehicle modifications on coolant and transmission oil temperatures extrapolated to 115°F ambient are given in Table 9-1.

Static and dynamic testing also was conducted on the radiator individually and in the vehicle. On the basis of all tests, it was decided to incorporate a new design radiator (Code B) with fan speed increased 7 percent in a specific number of production vehicles.

9-4.3 M110 COOLING VERIFICATION AND PRODUCT IMPROVEMENT PROGRAM TESTS

9-4.3.1 General

Employed as a tactical support vehicle, the M110 Self-propelled Howitzer has a primary mission of providing fire power on enemy targets. Intended to be employed in relatively secure areas, the vehicle does not have any armor protection, weighs 58,500 lb, and can travel at road speeds up to 34 mph.

In 1967 a series of engine failures was reported. The US Army Materiel Command Project Manager, M107/M110, requested that a full-load cooling test be conducted to determine the adequacy of the vehicle cooling system. The test was conducted by the Propulsion System Laboratory of USATACOM. The data presented are condensed from their technical report, Ref. 12.

9-4.3.2 Cooling Test Objectives

The initial test objective was to determine if the as-received vehicle cooling system was adequate to maintain the engine coolant, engine oil, and transmission oil within the allowable temperature limits during full-load testing at 115°F ambient. Military Specification MIL-G-45397 (Ref. 2) sets the temperature limits of 230°F engine coolant, 275°F engine oil sump, and 300°F transmission oil into the cooler.

If the vehicle cooling system was found to be inadequate, the next objective was to develop cooling system improvements to meet specification requirements. A third objective was to evaluate a revised cooling system incorporating a surge tank.

9-4.3.3 As-received Vehicle Cooling Test Results

At a 115°F ambient temperature and the most severe design operating condition (0.4 converter speed ratio), the production vehicle cooling system exceeded the specified temperature limits for engine coolant and engine oil. Extrapolated to a 115°F ambient (vehicle specification requirement), the engine coolant exceeded the limit by 9 deg F and the engine oil sump exceeded the limit by 7 deg F. Fig. 9-12 shows the as-received (baseline) cooling test results.

9-4.3.4 Modified Vehicle Cooling Tests

A series of cooling tests was conducted with modifications to reduce the coolant and engine oil sump temperatures. The modifica-

AMCP 706-361

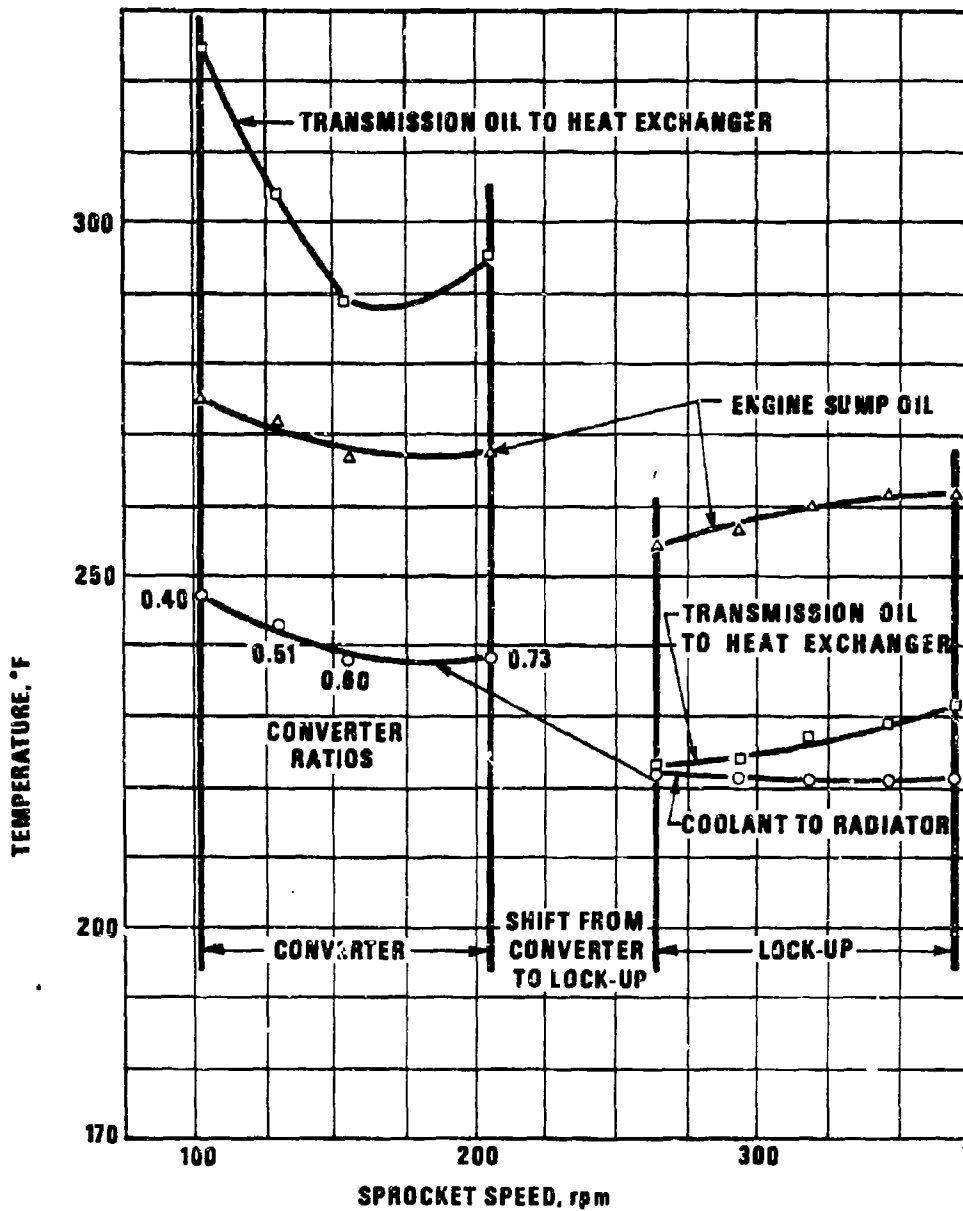

NOTE: TEST TEMPERATURES EXTRAPOLATED
 TO 115°F AMBIENT CONDITIONS

Figure 9-11. Temperature Characteristics of Power System in M113A1 Vehicle

TABLE 9-1
EFFECTS OF VEHICLE MODIFICATIONS ON COOLANT AND TRANSMISSION
OIL TEMPERATURES OF M113A1

Configuration Tested	Temperature, °F			
	Coolant to Radiator	Difference*	Transmission Oil to Cooler	Difference*
Original Vehicle	247	0	324	0
Radiator C	242	-5	322	-2
Radiator A	236	-11	328	+4
Radiator C and 7% Fan Speed Increase	231	-16	324	0
Radiator B and 7% Fan Speed Increase	225	-22	305	-19
Original Vehicle with Muffler Removed	232	-4	281	-5

* Temperature difference is change from original vehicle temperature value.

tions included changes to the engine, inlet grille area, deck, fan, and radiator.

The effects of the vehicle modifications on coolant and engine oil temperatures extrapolated to 115°F ambient are given in Table 9-2.

9-4.3.5 Surge Tank Tests

Tests with a surge tank installed in the vehicle cooling system revealed:

1. The surge tank permits a 10-qt coolant loss from a full cooling system before aeration (where air begins circulating with coolant) occurs. Aeration in the production vehicle (without surge tank) occurs after a 2-qt coolant loss.

2. The surge tank allows a more complete filling of the vehicle cooling system. Without the surge tank, the position of the production radiator cross-over tube causes an air pocket

when filling through one radiator. With the surge tank installed, the cross-over tube is positioned at the top of each radiator permitting both radiators to be filled completely.

9-4.4 M551 COOLING VERIFICATION AND PRODUCT IMPROVEMENT PROGRAM (Refs. 20, 21, and 23)

9-4.4.1 General

The SHERIDAN M551 is a full-tracked, Armored Reconnaissance/Armored Assault Vehicle weighing 34,450 lb combat loaded and travels at a top speed of 43 mph. The vehicle is equipped with a 152 mm Gun/Launcher Weapon System and can launch a SHILLELAGH missile and fire various 152 mm rounds. The purpose of the vehicle is to function as the main reconnaissance weapon for armor, infantry, airborne operations, and arms teams when the Main Battle Tank is not employed.

AMCP 706-361

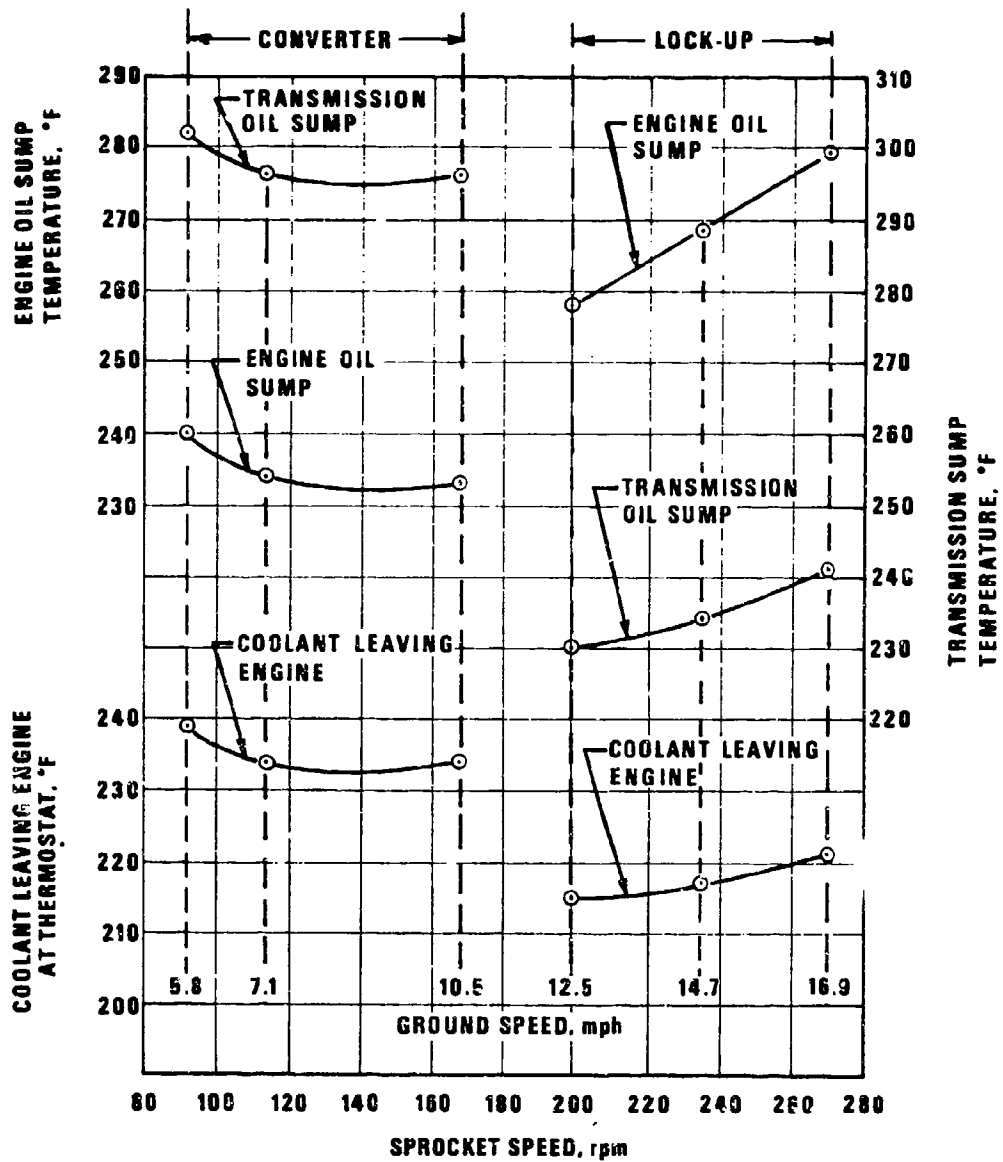

NOTE: TEST TEMPERATURES EXTRAPOLATED TO 115°F AMBIENT CONDITIONS

Figure 9-12. M110 Baseline Stabilization Cooling Results

TABLE 9-2

EFFECTS OF VEHICLE MODIFICATION ON COOLANT AND ENGINE OIL TEMPERATURE OF M110

Configuration Tested	TEMPERATURE, °F			
	Coolant to Radiator	Difference*	Engine Oil Sump	Difference*
Original Vehicle (Code E-335 and E-336 Engines)	239		283	
Code E-336 Engine, Code F-93 Fan, Increased air inlet grille area	229	-10	275	-8
Code E-337 Engine (water below port) (increased air inlet grille area)	235	-4	268	-15
Code E-337 Engine & Code R-47 Radiators	227	-12	262	-21
Code E-337 Engine, Code R-47 Radiators, Code F-93 Fan	220	-19	255	-28
Code E-337 Engine, Simulated Trans. Deck raised 7 in. on right side	228	-11	262	-21
Code E-337 Engine, Code R-47 Radiators Code F-93 Fan Simulated Trans. Deck Raised 7 in. on right side.	214	-25	249	-34

* Temperature difference is change from original vehicle temperature value.

During operations in Southeast Asia, numerous engine failures were reported. These could have been caused by many factors, including the cooling system capability and a vehicle weight increase (by the addition of armor protection) to 40,000 lb. A test program was initiated to determine and evaluate performance, endurance, and cooling

characteristics of the M551 SHERIDAN Vehicle.

9-4.4.2 Cooling Test Objectives

The cooling test objectives were to determine if the cooling system was adequate to maintain engine coolant and engine and

AMCP 706-361

transmission oil temperatures within the specified allowable limits of 230°F coolant, 275°F engine oil sump, and 300°F transmission oil during vehicle operation in first gear converter at 3 mph, in a 125°F ambient temperature environment (Ref. 22). If the vehicle failed to cool adequately, then proceed to develop adequate cooling improvements to the vehicle cooling system to meet military specification requirements.

9-4.4.3 As-received Vehicle Cooling Test Results (Nominal 300-hp Engine)

At a 125°F cell ambient and maximum designed operating condition (3 mph, 1st gear converter, 0.5 converter speed ratio), the as-received production vehicle failed to meet with vehicle specifications. The engine coolant temperature exceeded the 230°F maximum limit by 3 to 7 deg F, and the transmission oil-to-cooler temperature exceeded the maximum limit by 5 to 9 deg F.

At a 125°F cell ambient (extrapolated from a 115°F ambient) and maximum design operating condition (3rd gear converter, 0.5 converter speed ratio), the as-received production vehicle failed to comply with vehicle specifications. The engine coolant temperature exceeded the 230°F maximum limit by 4 deg F and the transmission oil temperature into the cooler exceeded the maximum limit by 10 deg F.

Fig. 9-13 shows the sprocket horsepower output of the vehicle in each of the transmission shift combinations, and indicates the critical cooling speeds at 115°F and 125°F ambient conditions as determined. This shows that full load cooling (shaded area Fig. 9-13) could not be obtained at 125°F ambient air temperature in 4th gear converter at vehicle speeds below 27 mph.

9-4.4.4 Modified Vehicle Cooling Tests

Several tests were conducted with modified components installed in the vehicle to reduce coolant and transmission oil temperatures.

The modifications included derating the engine power from 300 to 255 hp, opening the turret access door, repositioning the radiator, modifying shrouds, and changing the radiator.

The effects of these vehicle modifications on coolant and transmission oil temperatures extrapolated to a 125°F ambient are given in Table 9-3.

A schematic diagram showing the airflow path in the power package is presented in Fig. 9-14.

A carry-on program related to the earlier testing of the M551 at the US Army Tank-Automotive Command resulted in a cooling product improvement program for the vehicle. The cooling improvement consisted of the installation of a transmission oil-to-air cooler, mounted between the radiator and the cooling fan as shown in Fig. 9-15. The installation of an oil-to-air cooler relieved the transmission heat rejection load from the engine radiator circuit. On the production vehicle, an oil-to-water heat exchanger mounted on the side of the engine was used for transmission oil cooling.

A cooling test (Ref. 29) performed at the Propulsion Systems Division high ambient temperature test chamber, test cell no. 9, demonstrated that the M551 (PIP) cooling system has reserve capacity at 125°F ambient. Stabilized tests were made at full power, 125°F ambient from 0.30 transmission converter speed ratio up to 2800 rpm engine speed transmission lock-up. The production cooling system could be operated only down to 0.44 converter ratio at 115°F ambient without exceeding critical temperature. At every test condition, using the transmission oil-to-air cooler, the specified temperature limits of MIL-A-45559B(AT) dated 4 Dec 67 were not exceeded. The maximum temperatures recorded occurred at 0.30 converter speed ratio and were: engine coolant out temperature 226°F, engine oil sump tempera-

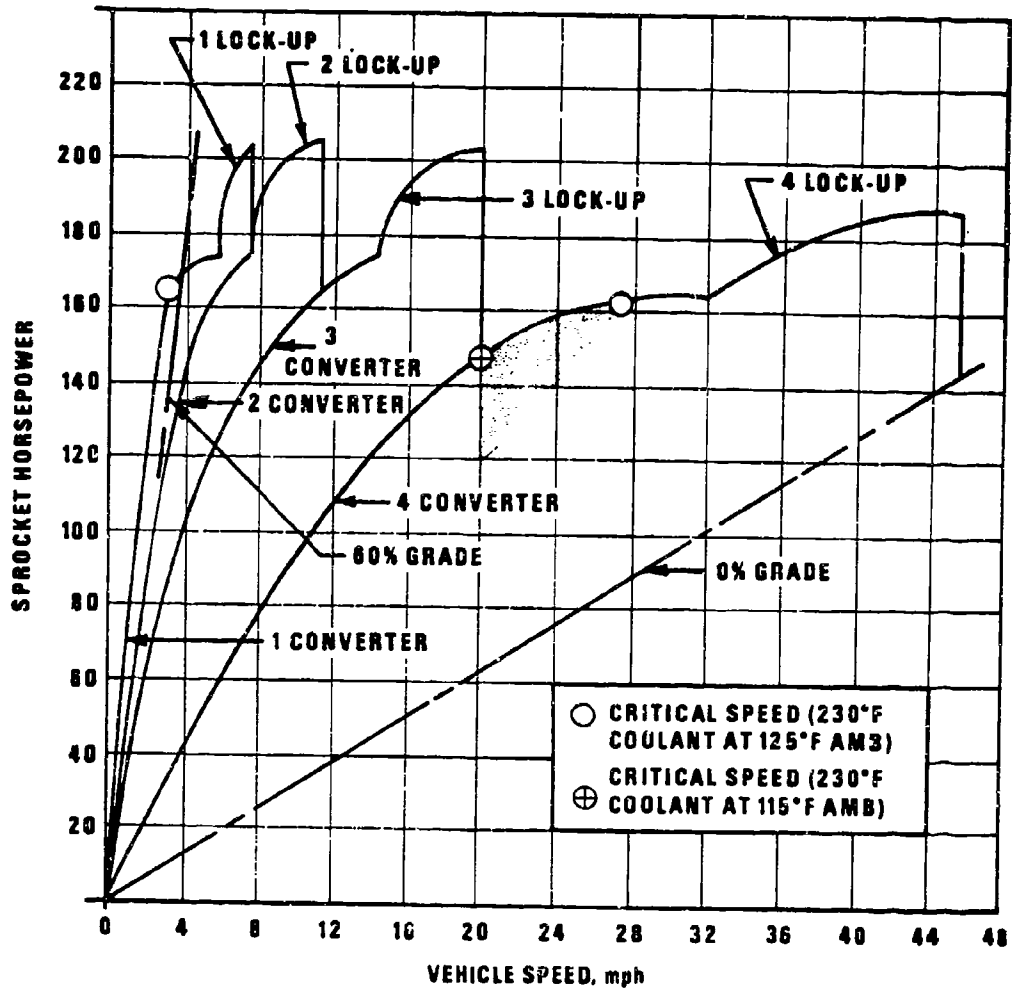

Figure 9-13. M551 Vehicle, Sprocket Horsepower vs Vehicle Speed Curve Showing 4th Gear Critical Cooling Operating Conditions (USATACOM)

ture 259°F, and transmission oil out temperature 311°F.

A test run was performed to compare the M551 (PIP) system to the production M551 cooling system. This test was performed with the same average air temperature before the radiator as previously tested in an M551 production cooling system cited in par. 9-4.4.3. The results of this comparison run

shows a 28-deg F coolant improvement of the PIP cooling system, with the oil-to-air transmission cooler, over the production version when tested at a 0.44 converter ratio. The transmission oil temperature was reduced 49 deg F and the engine oil was reduced 22 deg F. This type of cooling system also was employed in the M114 PIP cooling system design (see par. 8-5.1.3).

Removal of the transmission heat rejection

AMCP 706-361

TABLE 9-3

**EFFECTS OF VEHICLE MODIFICATION ON ENGINE COOLANT AND TRANSMISSION
 OIL SUMP TEMPERATURES OF THE M561**

Configuration Tested	TEMPERATURES, F				Remarks
	Coolant to Radiator	Difference*	Transmission Oil Sump	Difference*	
As-received Vehicle Configuration (Nominal 300hp)	234		310		Configuration Tested in 3rd Gear
As-received Vehicle Configuration (Nominal 255hp)	223	-11	294	-6	
As-received Vehicle Configuration (Nominal 300hp)	233		305		Configuration Tested in 1st Gear
Two Turret Access Doors Open	230	-3	303	-2	
As-received Radiator (Code R-56), Moved 1-1/4 In. Ahead, Modified Shroud Access Doors Open	227	-6	309	-5	
Code R-56 Radiator, Moved 1-1/4 In. Ahead, Enlarged Shroud, Access Doors Open	227	-6	301	-4	
Code R-57 Radiator, Moved 1-1/4 In. Ahead, Enlarged Shroud	227	-6	304	-1	

* Temperature difference is change from original vehicle temperature value.

from the engine liquid coolant, by use of a larger face area low pressure drop transmission oil-to-air cooler, is highly recommended to provide exceptional improvement in cooling over use of an oil-to-water transmission cooler in liquid-cooled installations.

9-4.5 M561 COOLING VERIFICATION AND PRODUCT IMPROVEMENT PROGRAM (Ref. 24)

9-4.5.1 General

The M561 (Gamma Goat) is classified as a

Truck, Cargo, 1-1/4 ton, 6 X 6, Multipurpose Articulated Vehicle. A requirement was established to provide a tactical wheeled vehicle with maximum operational capability for general and special purposes in the transportation of personnel, cargo, weapons, and other military supplies and equipment, and for special tasks during tactical military operations. The vehicle is a six-wheel drive tractor and cargo carrier combination and obtains a maximum vehicle speed of 58.5 mph in fourth gear, high transfer range. The vehicle is capable of floating and swimming on inland waters and is air transportable.

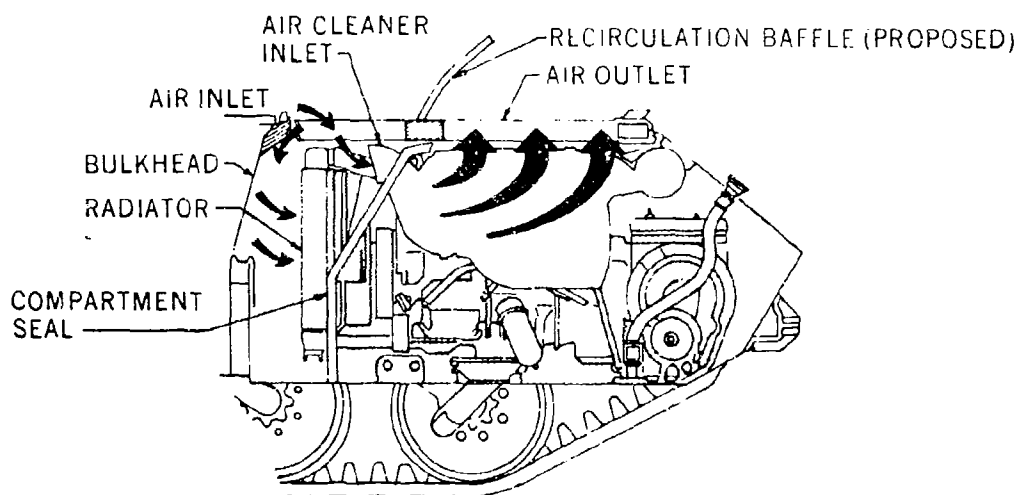

Figure 9-14. M551 Vehicle Cooling Airflow Path (Yuma Proving Ground)

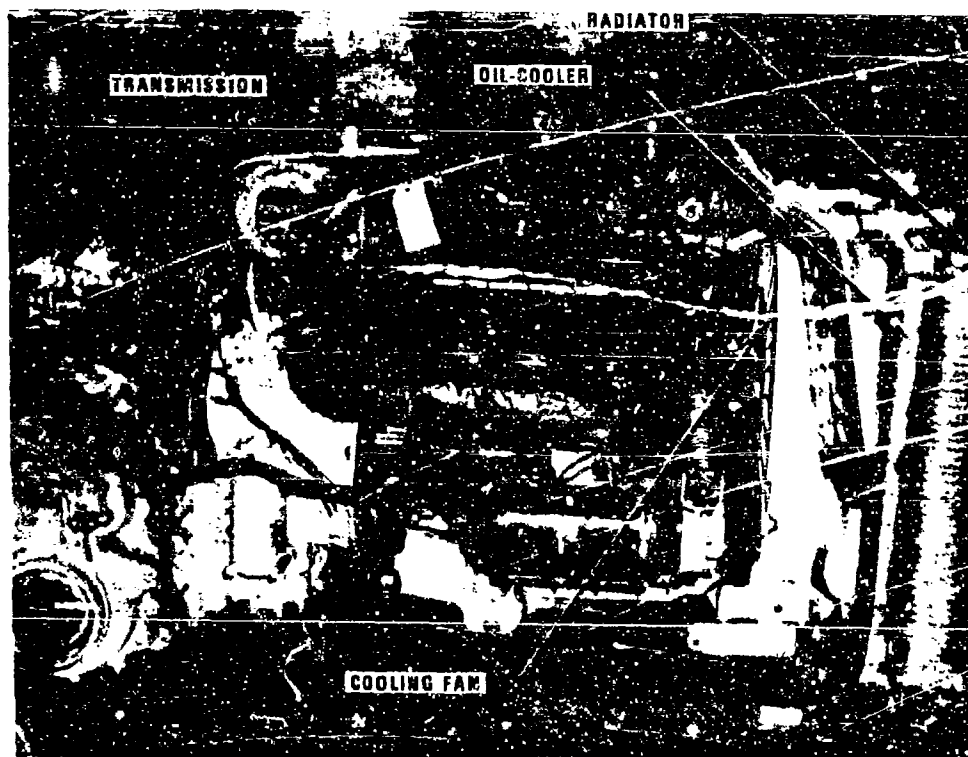

Figure 9-15. M551 Vehicle Power Package With Oil-to-Air Transmission Oil Cooler Installed (USATACOM)

AMCP 706-361

During initial production testing at Yuma Proving Ground, a cooling problem was discovered. Consequently, the Project Manager's Office authorized the Propulsion Systems Division of USATACOM to conduct full-load cooling tests to verify Yuma's findings and correct any cooling deficiencies encountered.

9-4.5.2 Cooling Test Objectives

The primary test objective was to determine if the cooling system would maintain engine coolant and oil sump temperatures within the specified allowable limits of 230°F coolant and 275°F engine oil sump; during full load vehicle operation in all speed ranges in a 120°F ambient environment (Ref. 4).

The secondary test objective was to develop adequate cooling improvements to the cooling system to meet the military specification requirements.

9-4.5.3 As-received Vehicle Cooling Test Results

At a 120°F ambient (extrapolated from a 90°F cell ambient degree-per-degree) and maximum design operating condition of 1600 and 2800 rpm, fourth gear, high transfer range, the as-received production vehicle failed to comply with the military specification. The engine coolant temperature exceeded the 230°F maximum limit by 26 deg F, and the engine oil sump temperature exceeded the maximum limit by 24 deg F.

9-4.5.4 Modified Vehicle Cooling Tests

Many tests were conducted with modified components installed in the vehicle, in an attempt to reduce coolant and oil sump temperatures. The most significant modifications included derating the engine 18 percent, sealing around the radiator, changing the shroud shape, and increasing the fan speed.

The effects of the most significant vehicle

modifications on engine coolant and oil sump temperatures, extrapolated to a 120°F ambient, are given in Table 9-4.

9-4.5.5 Observations and Conclusions

A minimum combination of modifications required to the as-received vehicle for marginal compliance with vehicle specification cooling requirements during full load, fourth gear, high transfer range, vehicle operation in a 115°F ambient environment were:

1. N50 injectors
2. Seals around radiator
3. Bell-mouthed shroud.

A minimum combination of modifications required to the as-received vehicle for compliance with vehicle specification cooling requirements during full load, fourth gear, high transfer range, vehicle operation in a 120°F ambient environment were:

1. N50 injectors
2. Seals around radiator
3. Bell-mouthed shroud
4. Vehicle hood with inlet and exhaust louvers fabricated to production drawing specifications.

9-4.5.6 Evaluation of Vehicle Coolant Solutions

Two stabilization cooling tests were conducted at engine speeds of 1600 and 2800 rpm, with a coolant solution consisting of 45.5% (10 qt) ethylene glycol and 54.5% (12 qt) water. Tests were conducted at a 120°F cell ambient with all vehicle modifications installed. The purpose of these tests was to determine how stabilized engine coolant and oil sump temperatures compared against

TABLE 9-4
EFFECTS OF VEHICLE MODIFICATIONS ON ENGINE COOLANT AND OIL SUMP TEMPERATURES OF
THE M661 (EXTRAPOLATED TO 120°F)

Configuration Tested	TEMPERATURES, °F			
	Coolant to Radiator	Cumulative Difference*	Engine Oil Sump	Difference*
As received Vehicle Configuration (M65 Injectors, CITE Fuel)	256		299	
As Received Vehicle Configuration (N50 Injector VV-F-800a Grade DF-2 Fuel)	253	-3	288	-11
Seals Around Radiator	245	-11	283	-16
Seals Around Radiator, Bell Mouth Shroud	234	-22	279	-20
Seals Around Radiator, Bell Mouth Shroud, APE Vehicle Hood	228	-28	278	-21
Same as Above Test Except with Different Radiator, Fan, Bell Mouth Shroud	232	-24	280	-19
Seals Around Radiator Bell Mouth Shroud Inlet and Exhaust Grilles Fabricated to Production Drawing Specification	228	-28	280	-19
Same Components As Above Test Including 12 to 13 % Increase In Fan Speed	220	-36	270	-29

* Temperature difference is change from original vehicle temperature value.

AMCP 706-361

cooling tests conducted with 100% water coolant and cooling tests conducted with a combination ethylene glycol and water coolant solution. Stabilization temperatures with 100% water as the coolant were compared against the combination ethylene glycol and water coolant solution. The comparison results were:

ENGINE COOLANT/ SOLUTION	ENGINE SPEED, rpm	COOLANT TEMPERATURE BEFORE RADIATOR, °F	ENGINE OIL SUMP TEMPERATURE, °F
100% Water	1600	220.3	251.4
45.5% Ethylene Glycol, 54.5% Water by volume	1600	227.2	263.4
100% Water	2800	222.8	266.3
45.5% Ethylene Glycol, 54.5% Water by volume	2800	224.1	270.7

9-5 US ARMY TANK-AUTOMOTIVE COMMAND COOLING SYSTEM RESPONSIBILITIES

As described in par. 9-7, USATACOM is responsible for research, development, design, and engineering support of all types of military vehicles and their components. The responsibilities of various groups within USATACOM in these areas are presented briefly. The Propulsion Systems Laboratory is responsible for:

1. Research, design supervision, development, and performance testing of military engine cooling systems
2. Testing of commercial engine cooling system adequacy for military usage, surveil-

lance of suppliers cooling tests when tests are performed by the manufacturer, and recommending changes to meet military requirements

3. Furnishing project/product managers and engineers necessary information on engine cooling systems
4. Conducting and making recommendations on trade-off studies
5. Coordinating and monitoring military proving ground vehicle cooling tests.

Each USATACOM project engineering and project/product manager having responsibility for cooling system and end item or materiel development, is responsible for:

1. Overall cooling system design, development, procurement, and service to the Army during the life of the vehicle. Service responsibility includes successful cooling system performance.
2. Evaluating components and materiel in conjunction with the Propulsion Systems Laboratory to insure that adequate cooling systems are incorporated into:
 - a. Basic design of new items
 - b. Modification or retrofits, when required, to items in the area of responsibility that are in more advanced stages of development or in the field
3. Taking action concerning in-process reviews insuring that adequacy of the cooling system and components is addressed at all scheduled in-process reviews to insure fulfillment of operational requirements (TACOM Reg 70-7)
4. Insuring, through the Propulsion Systems Laboratory, the inclusion of an effective cooling system evaluation clause when contracts for materiel are initiated or modified,

and maintaining contact with contractors to insure effective implementation

5. Furnishing to Propulsion Systems Laboratory, for review and consideration, materiel and engineering development documents specifying cooling systems and end item requirements

6. Including additional funding in annual program submissions and materiel development plans for the accomplishment of the cooling system evaluations.

See Ref. 7 for additional details.

9-5.1 DEVELOPMENTAL TESTS II AND III

Suitability Tests II and III generally may be defined as evaluations that normally lead to type classifications of materiel or recommendations as to suitability for release of end items for issue to the field.

Testing and evaluation of all tactical vehicles used by the army are the responsibility of the US Army Materiel Command. These tests usually are performed by the US Army Test and Evaluation Command (USATECOM). The major tests performed by USATECOM are:

1. Engineering Test DT II (ET)
2. Service Test DT II (ST)
3. Integrated Engineering/Service Test DT II (ES)
4. Product Validation Test DT III (PV)
5. Check Test (CK)
6. Initial Production Test (IP)
7. Product Improvement (PI).

Test plans and reports are written by the USATECOM test agencies. Most subtests,

including cooling tests, are selected from established Materiel Test Procedures (see Ref. 8). Fig. 9-16 illustrates a mobile field dynamometer used for full load and towed load cooling tests during USATECOM vehicle suitability testing. A complete listing of USATECOM test types is given in Table 9-5.

9-5.2 ENVIRONMENTAL TESTS

Environmental tests are conducted to determine if an item will perform effectively in the environments of its intended use. The environmental requirements are specified in the Vehicle Specification documents in terms of the climatic categories defined in AR 70-38 (Ref. 9). The document that further defines the operational characteristics may permit the use of kits to enable the vehicle to perform in the temperature range specified.

Vehicle cooling tests at Yuma Proving Ground are divided into two major divisions: full load cooling and road load cooling. Typical procedures for conducting full load tests are:

1. Vehicle preparation (for other than special as-is tests):
 - a. Insure that the vehicle has been subjected to the applicable portions of MTP 2-2-505, *Preliminary Operations (Automotive)*.
 - b. Special attention should be paid to cooling and lubrication systems for cleanliness, proper levels, belt tensions, etc.
 - c. Radiator pressure cap should be checked for proper relief setting and the radiator should be flow checked.
 - d. Install the proper payload.
 - e. Install calibrated instrumentation.
 - f. Block all thermostats open.

AMCP 706-361

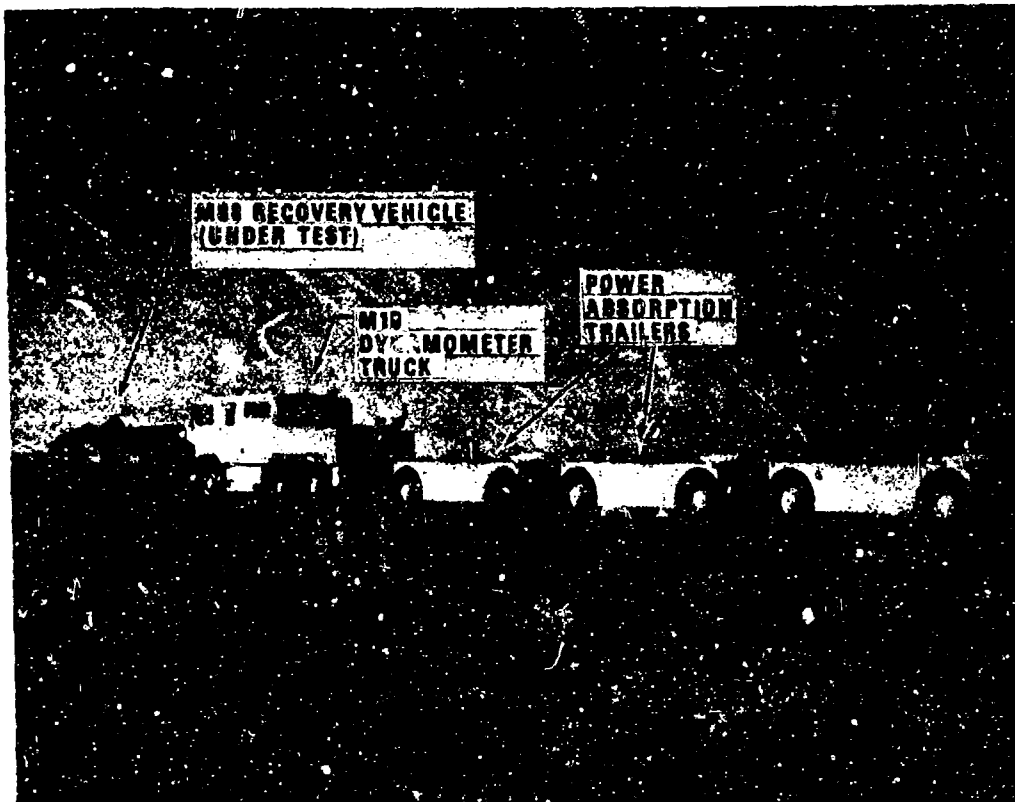

Figure 9-16. Mobile Field Dynamometer With M88 Recovery Vehicle Under Test (Yuma Proving Ground)

g. Adjust governor approximately 50 rpm above rated speed; determine that the throttle rack is fully open when accelerator pedal is fully depressed.

h. Use MIL Specification fuels and lubricants.

2. The following instrumentation and supporting equipment should be installed (for usual type tests):

a. Thermocouples to measure:

(1) Engine oil sump or gallery temperature and/or temperature into and out of the cooler, as applicable

(2) Gear box oil sump temperature and/or oil temperatures into and out of the cooler, when applicable .

(3) Transmission fluid temperature, and/or temperature into and out of the cooler, when applicable

(4) Fuel temperature, to injector pump/carburetor and return to tank as applicable

(5) Air temperatures before and after coolers, crew area, and others as required

(6) Exhaust port temperature, when applicable.

TABLE 9-5

US ARMY TEST AND EVALUATION COMMAND TEST TYPES

<u>Test Type</u>	<u>Code</u>	<u>Reference</u>
*Acceptance Test	PA	-
Check Test	CK	-
*Comparison Test	IC	AR 700-78
Development Test I	DS	-
Development Test II (Engineering Phase)	ET	-
Development Test II (Service Phase)	ST	-
Development Test II (Integrated Engineering/ Service Phases)	ES	-
Development Test III (Production Validation)	PV	-
*Engineer Design Test	ED	-
*Feasibility Test	FE	-
*Firing Table Test	FT	-
Initial Production Test	IP	AR 700-78
*Product Improvement Test	PI	AR 700-35
*Preproduction Test	PP	AR 700-78
*Research Test	RE	-
*Research and Development Acceptance Test	RD	-
Reconditioning Test	RT	AR 700-78
Special Study	SS	-
Support Test	SP	-
*Surveillance Test	SU	AR 700-78

* Test normally performed as a customer test.

(USATECOM)

AMCP 706-361

b. Transducer or pressure gage to measure engine and transmission oil pressure, fuel pressures, and coolant pressures, as applicable

c. Vacuum or pressure gages to measure manifold vacuum or air box pressure, as applicable

d. Tachometer to measure engine speed

e. Cylinder head temperatures of air-cooled engines

f. Temperature of the coolant to and from the radiator of liquid-cooled engines.

3. Procedure:

a. Pretest:

(1) Inspect vehicle for proper coolant and lube levels, tire pressures, and other problem areas that might cause erroneous data.

(2) Hook-up to field dynamometer and perform an instrumentation and communication checkout.

(3) Determine road speed versus engine speed for usable gear ranges. If applicable, determine full load shift points when the transmission is warm.

(4) Perform a "high stall", engine-transmission check when applicable. Check drawbar horsepower against previous reports to assure that the vehicle is operating normally.

b. During Operation:

(1) Operate vehicle under full throttle (full rack), full load in the selected gear range at the proper engine or road speed, until temperatures have stabilized. At this point a cooling run will be started. A run will consist of a maximum of six readings (3 in each

direction) taken at 5-min intervals. If a set of readings taken in one direction varies no more than 5 deg F and if there is no more than a 10 deg F total variance in any reading and if the temperatures are not rising, this shall be considered a valid stabilized run.

(2) Dependent on vehicle characteristics, enough runs will be made throughout the available speed and gear ranges to obtain the full load cooling characteristics of the test item. These runs should cover road speeds for specified slope requirements, maximum cross-country driving range, normal convoy speed, if possible, and one run at maximum road speed (no dynamometer load). Usually one gear range is covered throughout the usual engine operating range, i.e., 5 or more different engine speeds in one gear. Spot checks are made in other gears at similar road or engine speeds.

(3) In the event stabilization is impossible, the vehicle will be run until an overheat condition is attained. "Rate of rise" will be determined during this condition.

(4) Judgment is important in deciding whether runs are valid or not. For example, if the areas of major interest are the engine oil and coolant temperatures (as in an engine test), rather than transmission oil temperature, then, when the former parameters are stabilized, it may constitute a valid run even if the transmission oil temperature is still rising.

(5) Meteorological data are obtained from the meteorological team. Preliminary ambient temperatures taken from an on-vehicle thermocouple may be misleading to any observer. Any data released at test time must be considered preliminary.

4. Data Presentation:

a. Stabilized data. Data are prepared for final form by averaging and extrapolation. An average is made of the six data points taken

during the run; it is then extrapolated to the temperature established by the criteria (e.g. TECR 70-38). This is done by adding 1 deg F to the averaged data for each degree that the ambient temperature was below the criteria. These data will be presented in both tabular and graphical form. Component temperature vs engine speed can be plotted for the data obtained in each gear range.

b. Unstabilized data. Dependent on the test requirements, these data may or may not be extrapolated; in any event, they will be presented in graphical form as a "rate of risk" curve. Temperatures will be plotted against elapsed running time.

Road load cooling tests at Yuma Proving Ground are conducted in accordance with the following procedure:

1. Vehicle Preparation:

- a. Payload must be the rated load for the terrain
- b. Proper tire inflation or track tension
- c. Towed load, if applicable
- d. Engine performance at optimum, thermostat blocked open
- e. Brakes properly adjusted
- f. Full crew or simulated full crew
- g. All OVM (On Vehicle Materiel) installed
- h. Instrumentation—similar, but less than full load cooling.

2. Test Conditions:

- a. No unusual weather conditions—temperature should be over 100°F, if possible.

b. Operate vehicle at maximum safe speeds (unless otherwise specified) over the following test courses until representative operation has been accumulated. This would be at least 2 hr (preferably more) so that temperatures of the components stabilize. The course conditions are:

- (1) Paved road
- (2) Straight and winding gravel roads
- (3) Level cross-country
- (4) Hilly cross-country
- (5) Desert pavement
- (6) Hummocky sand
- (7) Sand dunes
- (8) With and across a dry wash
- (9) Stony desert
- (10) Sand plains.

c. Operate vehicle continuously except for operator change.

d. Record temperatures and pressures of critical components.

e. Record miles driven and driving time elapsed.

3. Data Presentation. As in full load cooling, data are extrapolated to the specified upper air temperature limit on a degree-per-degree basis. Data are presented in tables, and possibly curves, if fluctuating but continuous temperature rise occurs.

Test procedures for environmental tests may be found in Ref. 10.

AMCP 706-361

9-6 MILITARY SYSTEM DEVELOPMENT DESCRIPTIONS

During the development cycle for a military vehicle, three configuration baselines are established for the equipment:

1. **Functional Baseline (concept).** The functional baseline is established at the end of the concept formulation phase and normally is concurrent with approval to initiate engineering development or operational vehicle development. This baseline is established by the approval and release of the system specification that defines the functional requirements of the vehicle.

2. **Allocated Baseline (definition).** The allocated baseline is established at the end of the contract definition phase of the development cycle and represents the vehicle configuration after the application of the System Engineering Process. Approval and release of the vehicle Development Specifications establishes this baseline.

3. **Product Baseline (production).** The product baseline is established at the completion of the Physical Configuration Audit that is conducted after the vehicle test and development program has been completed, and consists of product specifications, process specifications, and material specifications. In addition, system engineering provides engineering drawings and related data adequate for procurement, production, evaluation, and acceptance of the developed vehicle.

These baselines define the vehicle at various stages in its life cycle. The subsystems of the vehicle (which would include the cooling system) similarly go through these discrete phases. Modifications are made as required to arrive at a final configuration that fully meets the vehicle specifications (Ref. 16).

These baselines serve as system engineering management reference points and represent the progressive, evolutionary development of

specifications, drawings, and associated data necessary to field a reliable, fully developed, and type classified military vehicle.

This process of development requires evaluation of the vehicle by test to obtain performance data and to determine whether the product is satisfactory for its intended use.

Materiel under development by the US Army Materiel Command and its agencies is subjected to tests and evaluations. Life cycle testing Army Regulations (AR's) are shown in Table 9-6.

9-6.1 CONDUCT OF DEVELOPMENT TESTING (DT) AND OPERATIONAL TESTING (OT)

Development Testing (DT) is requirement-oriented testing conducted to determine the degree to which the performance of a system meets performance specifications and to assess the operability and maintainability of a system by a prospective user. This category of testing encompasses DT I, DT II, DT III, and other development tests. Operational Testing (OT)—which includes OT I, OT II, and OT III—is mission-oriented testing conducted to provide a user-oriented assessment of a system throughout the materiel acquisition process. The concepts, policies, and responsibilities for DT and OT are provided in AR 70-10. The principle of separating initial planning and independent evaluations is followed. However, in the interest of developing the most efficient and economical testing programs for all systems, development and operational testing are accomplished in all possible cases by:

1. Combined conduct of DT I and OT I
2. Conduct of separate DT III and OT III
3. Determination of preferred means of conduct of DT II and OT II on a case-by-case basis.

TABLE 9-6

ARMY REGULATIONS (AR) APPLICABLE TO LIFE CYCLE TESTING OF MATERIEL

<p>AR 70-10</p> <p><i>Subject:</i> Research and Development Test and Evaluation During Development and Acquisition of Materiel</p> <p><i>Scope:</i> Prescribes the objectives, concepts, responsibilities, policies, and major tests that apply in testing and evaluation leading to type classification.</p>
<p>AR 700-78</p> <p><i>Subject:</i> Quality Assurance Testing During Production and Post Production of Army Materiel</p> <p><i>Scope:</i> Prescribes the objectives, concepts, responsibilities, and policies for testing of Army materiel during the production and post production portion of materiel life cycle.</p>
<p>AR 71-3</p> <p><i>Subject:</i> User Field Tests, Experiments, and Evaluation</p> <p><i>Scope:</i> Outlines objectives, policy, responsibilities, and procedures for conduct of user field tests, experiments, and evaluations. These include troop tests, confirmatory tests, field evaluations, field experiments, and combat evaluations.</p>
<p>AR 700-35</p> <p><i>Subject:</i> Major Improvement of Materiel</p> <p><i>Scope:</i> Specifies responsibilities for conduct of product improvement of materiel within Department of the Army.</p>

NOTE: Check latest AR's for current information.

AMCP 706-381

In addition to the description of DT and OT contained in AR 70-10, the following conceptual definitions and objectives apply:

1. Development Test II Engineering Phase. DT II (Engineering Phase) is characterized by use of engineering approaches under controlled conditions employing multidisciplined engineers and scientists. This phase is designed to provide quantitative data to assess performance characteristics inherent in the design against the requirements contained in the Development Plan (DP). This phase of the testing will examine the safety aspects of the new system and provide a safety release for the equipment prior to testing by troops, to include both service aspects of development and operational testing.

2. Development Test II Service Phase. *General Statement:* The DT II (Service Phase) is a test conducted during the engineering development cycle of system acquisition by military personnel representative of those who will operate and maintain the equipment in the field. The service phase of DT will be performed under controlled field conditions representative of the anticipated tactical environment to determine to what degree the item or system and its associated training and maintenance test package conform to the requirements and standards specified in the Development Plan (DP). Measurement and recording instrumentation will be used where appropriate to accumulate statistical data necessary for the quantitative assessments and evaluation of system performance, durability, reliability, maintainability, and the numerous man-materiel interfaces. Normally, the service phase of DT should precede the initiation of the operational test (OT II) field exercise to confirm safety and insure readiness of the item or system for troop unit type testing. *Responsibility:* The materiel developer's independent test command (TECOM) will plan for, conduct, and report the results of the service phase of DT II. The DT II (Service Phase), when an appropriate safety release exists, may be conducted concurrently with

the engineering phase DT II and may involve simultaneous testing at one or more of the service test boards and environmental test centers. An evaluation letter, interim (if appropriate) and final, containing results and analyses of all DT II test activities will be prepared by the materiel developer's test command and provided to the materiel developer and other participants in the acquisition process for review and use in preparation for IPR or ASARC/DSARC (Army System Acquisition Review Council/ Defense Systems Acquisition Review Council) proceedings.

3. Operational Test II. *General Statement:* OT II is a test conducted during the engineering development phase of system acquisition to assess the overall operational effectiveness of an item or system. OT II will be characterized by the conduct of field exercises under realistic operational conditions using tactical scenarios and TOE (Table of Organization and Equipment) troop units/personnel of the type and qualifications of those expected to use and maintain the item or system when deployed. As a natural extension of the controlled service phase of DT II, OT II will be oriented toward qualitative observations and judgments pertaining to operational effectiveness in comparison with standard items and current threat, tactical and strategic deployment, communication and control, doctrine and logistics, and training.

9-6.2 DEVELOPMENT TESTING

Development testing is conducted as follows:

1. General:

a. DT should be started as early in the development cycle as possible and should first test components, then subsystems, and finally prototypes or preproduction models of the entire system. Previously acquired test data that can be validated, regardless of

source, will be used whenever applicable. DT will include "soldier proofing" through participation of representative user personnel DT test results, reports, and evaluations will be distributed in a manner to assure timely review by commands and agencies involved in the decision-making process.

b. During advanced development, adequate DT should be accomplished to demonstrate that the technical risks have been identified and are manageable.

c. During engineering development and prior to the first major production decision, the DT accomplished should be adequate to insure that the engineering is reasonably complete; that all significant design problems (including reliability, maintainability, and logistical considerations) have been resolved; that manufacturing methods and production engineering data have been generated; and that production planning has been completed to the extent required to provide a realistic basis for estimating costs and delivery schedules.

d. Early production models should be subjected to DT to assure that the characteristics of the production item meet the specifications prescribed.

2. Development Test I (DT I). This test is conducted early in the development cycle, normally during the Validation Phase. Components, subsystems, or the entire system, are examined to determine whether the system is ready for Full-scale Development. This test may, in the case of competitive systems, provide a comparison between the systems tested. Where appropriate, operational testing is conducted concurrently with this test.

3. Development Test II (DT II). This test provides the technical data necessary to assess whether the system is ready for production. It measures the technical performance and safety characteristics of the item and its associated tools, test equipment, training

package, and maintenance test package as described in the DT. Technical reliability and maintainability will be assessed during this test. The test encompasses all the elements of the formerly designated Engineering Test/Expanded Service Test (ET/EST) except for the field test with a troop unit. DT II will include "soldier-proofing" through participation of user personnel but not necessarily in a truly operational environment. Operational testing normally is conducted concurrently with DT II by the designated command or agency in coordination with the materiel developer's command.

4. Development Test III (DT III). This test is conducted on systems from the initial production run to verify that the system meets the specifications prescribed for it. The test also serves to confirm that deficiencies found in DT II have been corrected and it has the same scope and purpose as specified in AR 70-10 for the Initial Production Test. For Commercial Non-Developmental Items (CNDI), a DT III type test will provide the basis to evaluate the conformance of the commercial system to the specifications of the contract and the requirements of Section II of the DP.

5. Other Development-type Testing. There are other types of technical tests that the materiel developer conducts as part of materiel system acquisition or in the examination of materiel systems of interest to the Army. Examples are those previously designated as Engineer Design Tests (EDT), Contractor Demonstrations, Research and Development Acceptance Tests (RDAT), and Pre-Production Tests (PPT). Other technical testing and assessments of systems developed by another Service, foreign ally, or commercially, which may provide input for a new required operational capability or development plan, will be included in this category.

9-6.3 OPERATIONAL TESTING

Operational testing is conducted as follows:

AMCP 706-381

1. General:

a. OT is conducted as necessary and as early as practicable, beginning with early prototypes and continuing through production. OT will be accomplished by user and support personnel of the type and qualifications of those expected to use and maintain the system when deployed. OT normally will be conducted in phases, each keyed to the appropriate decision point. OT test results, reports, and evaluations will be distributed in a manner to assure timely review by commands and agencies involved in the decision-making process.

b. When established, the Operational Test and Evaluation Agency (OTEA), will be responsible for assuring that adequate OT is conducted for all major systems. In the case of major systems, the OTEA actively will participate with the designated user in the planning for and conduct of OT, and will prepare an independent evaluation of the adequacy of the testing and the validity of the results upon completion of each phase of OT. For nonmajor systems, the designated user will plan for, conduct, and report the results of OT. Involvement by the OTEA in OT of nonmajor systems may be directed by HQDA (Headquarters, Department of The Army) on a case-by-case basis.

2. Operational Test I (OT I). This test provides early information on system operational suitability, and a comparison with existing systems, in order to assist in determining whether the system should enter Full-scale Development. OT I also may help identify or refine critical issues to be examined in subsequent operational testing. In those cases where the opportunity exists for the conduct of OT I—for example, where competitive prototypes or well advanced prototypes exist—it will be conducted concurrently with DT I using a single, coordinated test plan.

3. Operational Test II (OT II). This test is

accomplished prior to the production decision (ASARC IIa/DSARC IIa for major systems) and provides an assessment of system operational suitability and effectiveness. It also provides information needed to refine or validate organizational and employment concepts and determine training and logistic requirements. OT II normally is accomplished concurrently with DT II, using complete preproduction prototypes. Complete interchange of information and data obtained during DT II and OT II is mandatory. During OT II, the system is subjected to a realistic operational environment, using a small troop unit typical of a unit that ultimately will be equipped with the system. OT II will produce sufficient and timely results to allow an independent evaluation to be available to assist in making a Low Rate Initial Production decision at ASARC IIa/DSARC IIa for major systems, or a production recommendation at the IPR (In Process Review) for other systems. The DA letter authorizing development of nonmajor systems will specify the command to conduct OT II.

4. Operational Test III (OT III). This test is accomplished using early production models and provides information to refine or validate earlier estimates of operational effectiveness, to determine the operational suitability of the production model, to optimize organization and doctrine, to validate training and logistic requirements, and to identify any additional actions that should be taken before the new system is deployed.

In those cases where Low Rate Initial Production has been carried out pursuant to ASARC IIa/DSARC III, OT III will be conducted by the designated user and normally will be independent of DT III. The system will be placed in the hands of the designated user, tested by troops in appropriate units, and subjected to a realistic operational environment. The OTEA will, in the planning for OT III of major systems, actively participate in its conduct, and independently evaluate the adequacy of the

testing and the validity of the results. The scope of OT III will be influenced by the results of the earlier OTE (Operational Test of Equipment) and the extent and importance of critical issues still to be answered. Results of OT III, in conjunction with the results of DT III, will provide input for the ASARC IIa/DSARC IIa, and a Full-scale Production decision is made following DT II and OT II. A determination will be made concerning whether additional OTE using production models is necessary. The determination to conduct this additional OTE will consider the recommendation of the user, the results of earlier OTE, and whether critical operational issues remain unanswered.

5. Other Operational-type Testing. There are other types of operational tests that the user may conduct at any time during the materiel life cycle that relate to operational suitability or operational effectiveness of a system.

9-7 TEST AGENCIES

The principal agencies and offices concerned with the testing of wheeled, tracked, and special purpose vehicles and their involvement are:

1. *USATRADO*C (Training and Doctrine Command), Fort Monroe, Virginia. Responsible for Vehicle Specifications

2. *USAMC* (Army Materiel Command). Specific project managers are assigned to direct and manage the funding of the development and procurement of specific vehicles or classes of vehicles

3. *USATACOM* (Tank-Automotive Command), Warren, Michigan. Responsible for research, development, design, and support of all types of military vehicles, and their major components to meet the needs of the Army at present and 20 yr or beyond in the future. Toward these goals, this command has continued to strengthen the technology base

necessary to exploit scientific knowledge useful to the armed forces relevant to future as well as to current requirements. To accomplish this mission, USATACOM has provided laboratory facilities and supported personnel in Propulsion System (engine, cold climate studies, power train, cooling, air cleaners, fuel and lubricants, diagnostic equipment, and long range research), Surface Mobility Systems (frame, suspension, and track), physics, sciences, instrumentation, materials, and various component study laboratories. This command provides engineering support to project managers for development and procurement of military vehicles, and engineering and technical support to the field Army

4. *USATROSCOM* (Troop Support Command), St. Louis, Missouri. Same as USATACOM except vehicles are for surface transportation, construction, bridging, and miscellaneous areas. (This function will be assigned to USATACOM.)

5. *USATECOM* (Test and Evaluation Command):

a. Armor Directorate. Responsible for accomplishing the testing and evaluation of combat vehicles

b. Field Artillery Directorate. Responsible for accomplishing the testing and evaluation of self-propelled artillery

c. General Equipment Directorate. Responsible for accomplishing the testing and evaluation of construction and service vehicles

d. Aberdeen Proving Ground/Material Test Directorate. Principal engineering test (ET) agency for testing vehicles

e. Yuma Proving Ground. Secondary ET agency for vehicles; primary desert environmental test agency and air delivery engineering test

AMCP 706-361

f. Arctic Test Center, Fort Greely, Alaska. Responsible for field arctic tests

g. Tropic Test Center, Panama. Responsible for tropic testing of vehicles

h. Armor and Engineer Board, Fort Knox, Kentucky. Responsible for service testing (ST) of most construction, support, and service equipment vehicles

i. Artillery Board, Fort Sill, Oklahoma.

Responsible for ST of field artillery, including self-propelled and towed

j. Infantry Board, Fort Benning, Georgia. Responsible for tests related to tactical application of certain vehicles

k. Airborne, Electronics, and Special Warfare Board, Fort Bragg, North Carolina. Responsible for airdrop and air transportability tests.

REFERENCES

1. AR 70-10, *Test and Evaluation During Development and Acquisition of Materiel*.
2. MIL-G-45397, *Gun, Field Artillery, Self-propelled*.
3. Arthur L. Jaeger, *Airflow Test of a Mock-up of the Cooling System for the T-195 Engine Transmission Compartment*, Report No. 4488, Detroit Arsenal, Centerline, Michigan, May 1959.
4. MIL-T-62045, *Engine, Diesel, Three Cylinder In-line-type, 103 Horsepower*.
5. E. Fisher, *Cooling Requirements for the AVCR-1100-1 and AVCR-1100-2 Air-cooled Engines When Installed in the MBT70*, Report No. 1005, Continental Aviation and Engineering, Detroit, Michigan, April 1966.
6. Peter D. Welch, *Cooling Air Rerouting for the AVDS-1790-2CM/M60 Power Pack - A Feasibility Study*, Technical Note No. AVDS1790-2CM-127, Teledyne Continental Motors, Warren, Michigan, June 1972.
7. Regulation No. 70-20, *Research and Development Cooling Evaluation Test of Cooling Systems and Components*, US Army Tank-Automotive Command, Warren, Michigan, November 1971.
8. Materiel Test Procedure 2-1.001, *Testing Wheeled, Tracked, and Special Purpose Vehicles*, USATECOM, Aberdeen Proving Ground, Maryland, July 1970.
9. AR 70-38, *Research Development, Test, and Evaluation of Materiel for Extreme Climatic Conditions*.
10. MIL-STD-810, *Environmental Test Methods*.
11. *Adequacy of Cooling System for Power System in M113A1 Vehicle*, Technical Report No. 11241, USATACOM, Warren, Michigan, January 1971.
12. *Cooling and Performance Characteristics of the Howitzer, 8-inch, Self-propelled, M110 Vehicle*, Report No. 10515, USATACOM, Warren, Michigan, May 1969.
13. AMCA Standard No. 210-67, *Test Code for Air Moving Devices*, Air Moving and Conditioning Association, Inc., Arlington Heights, Illinois, 1967.
14. AMCA Standard No. 300-67, *Test Code for Sound Rating*, Air Moving and

- Conditioning Association, Inc., Arlington Heights, Illinois, 1967.
15. *Performance and Sound Tests of M107-110 Cooling Fans*, Report No. 10587, USATACOM, Warren, Michigan, July 1969.
 16. TM 38-760, *A Guide to System Engineering Summary*, November 1973.
 17. *Test of Water Pumps*, Technical Report No. 7281, USATACOM, Warren, Michigan, March 1962.
 18. MIL-R-45306, *Radiators, Engine Cooling, Industrial*.
 19. MIL-C-4678 (MO), *Carrier, Personnel, Full Tracked, Armored, M113A1*.
 20. Frank Margriff, *Cooling and Performance Evaluation of Proposed Modifications for M551 SHERIDAN Vehicle*, Report No. 11417, USATACOM, Warren, Michigan, May 1971.
 21. Frank Margriff, *Thermal Design Verification Test (Cooling, Performance and Endurance Characteristics of the M551 SHERIDAN Vehicle*, Report No. 11177, USATACOM, Warren, Michigan, June 1970.
 22. MIL-A-455598, *Armored Reconnaissance/Airborne Assault Vehicle, Full Tracked, 152MM, XM551*.
 23. John Parker, *EO Test of SHERIDAN M551 Cooling Performance Tests*, Yuma Proving Ground Report 0104, January 1972.
 24. Frank Margriff, *Cooling and Performance Characteristics of M561 Truck (GAMMA Goat)*, Report No. 11552, USATACOM, Warren, Michigan, October 1971.
 25. Wsewolod Hnatzuk, *Cooling and Performance Tests of Carrier, Utility Articulated, XM571*, Report No. 11459, USATACOM, Warren, Michigan, October 1971.
 26. William C. Whitcomb, *Cooling and Performance Tests of 2-1/2 ton, 6 x 6, M275A2 Tractor Truck With Calibrated LD-465-2 Engine*, Report No. 10272(F), USATACOM, Warren, Michigan, January 1970.
 27. Wsewolod Hnatzuk, *Cooling and Heat Rejection Test of XM817, 5 ton, w/w, 6 x 6 Dump Truck (Engineering Audit Program)*, Report No. 11228, USATACOM, Warren, Michigan, January 1970.
 28. C. Gasaway, *LDS-465-1A Coolant Pump Characteristics*, Technical Note No. 632, Continental Aviation and Engineering Corporation, Detroit, Michigan, 1968.
 29. Peter C. Manning, *Cooling and Performance Evaluation of M551 Product Improvement Package (PIP) Cooling System*, (USATACOM AMSTA-RGL E.J. Rambie was in charge of the new system design) Report No. 11837, US Army Tank-Automotive Command, Warren, Michigan, 1974.

APPENDIX A

A-1 OIL-COOLER PERFORMANCE¹

A series of performance charts for oil-to-air heat exchangers is included to aid design engineers in selecting preliminary oil-cooler sizes in the design of military vehicle cooling systems (see Figs. A-1 through A-32). Because of the wide range of variables involved, these size determinations can be considered approximate only, and the manufacturer should be consulted before a final design is established, especially where space, weight, air horsepower or any other consideration may be critical.

The type of heat exchanger used here is brazed aluminum plate-fin construction having extended surfaces ("fins" or "centers") on both oil and air sides. The air side fin height is 0.375 in. and the oil side fin height 0.125 in. The separating plate thickness is 0.021 in. The actual fin configuration on both sides of the interrupted fin variety are proprietary to the manufacturer. The flow pattern is single-pass cross-flow.

The performance charts given here are based upon 1 ft² of heat exchanger face area exposed to airflow. The variables for the various charts are (a) core depth in the

direction of airflow, and (b) air side fin density, expressed as number of fins per inch of core width. For each performance chart there are variable airflows and variable oilflows. All are based on SAE 30 oil at 225°F inlet to the heat exchanger, which will give close approximations for other oil grades at temperatures from roughly 160° to 300°F. The reference inlet air condition, 100°F, will allow for close approximations of heat transfer over a range of roughly 0° to 200°F using mass airflow rate, lbm/min. Air pressure loss is given in terms of standard air density, $\rho = 0.07651 \text{ lbm/ft}^3$, which allows for correction to other conditions over a moderate range, the actual loss being inversely proportional to the inlet air density. For the range of all the variables given, interpolations and moderate extrapolations may be made readily.

There are two sets of charts (Figs. A-1 through A-32) given for all these variables, one incorporating a high-performance oil-side surface suitable for medium to high oil pressure losses. The other, although having a reduced heat transfer rate, has an appreciably lower oil pressure loss. This is a qualitative guide only; actual values for each construction should be compared.

¹Courtesy of Harrison Radiator Division-GMC

AMCP 706-361

OIL-TO-AIR HEAT EXCHANGER—SQUARE FOOT FACE AREA
 AIR FIN HEIGHT 0.375 in. CORE DEPTH 1.5
 OIL FIN HEIGHT 0.125 in. FINS/INCH 11
 PLATE THICKNESS 0.021 in.
 OIL SIDE FINS LOW/MODERATE PRESSURE LOSS
 INLET CONDITIONS AIR AT 100°F
 SAE 30 OIL AT 225°F

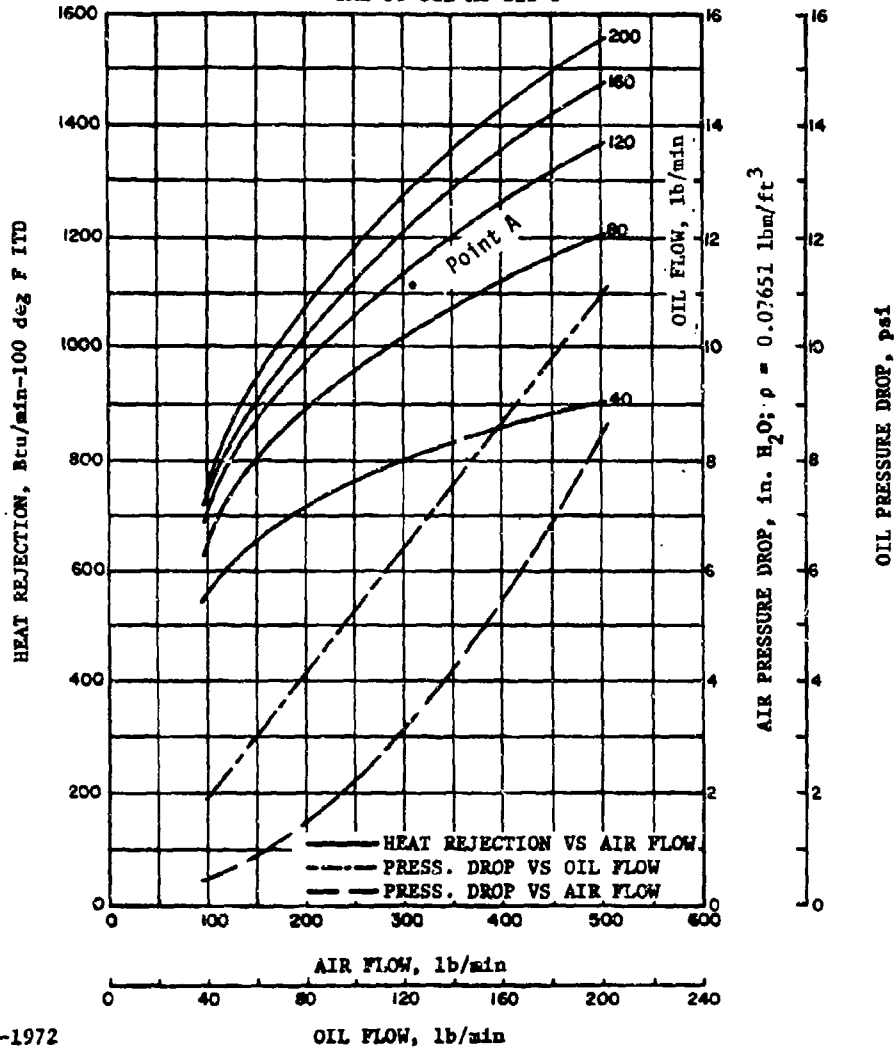

Courtesy of HARRISON RADIATOR DIVISION - GMC

Figure A-1. 11 Fins/in., Core Depth 1.5 in., Oil Cooler Performance, I

OIL-TO-AIR HEAT EXCHANGER--SQUARE FOOT FACE AREA
 AIR FIN HEIGHT 0.375 in. CORE DEPTH 1.5 in.
 OIL FIN HEIGHT 0.125 in. FINS/INCH 12.5
 PLATE THICKNESS 0.021 in.
 OIL SIDE FINS LOW/MODERATE PRESSURE LOSS
 INLET CONDITIONS AIR AT 100°F
 SAE 30 OIL AT 225°F

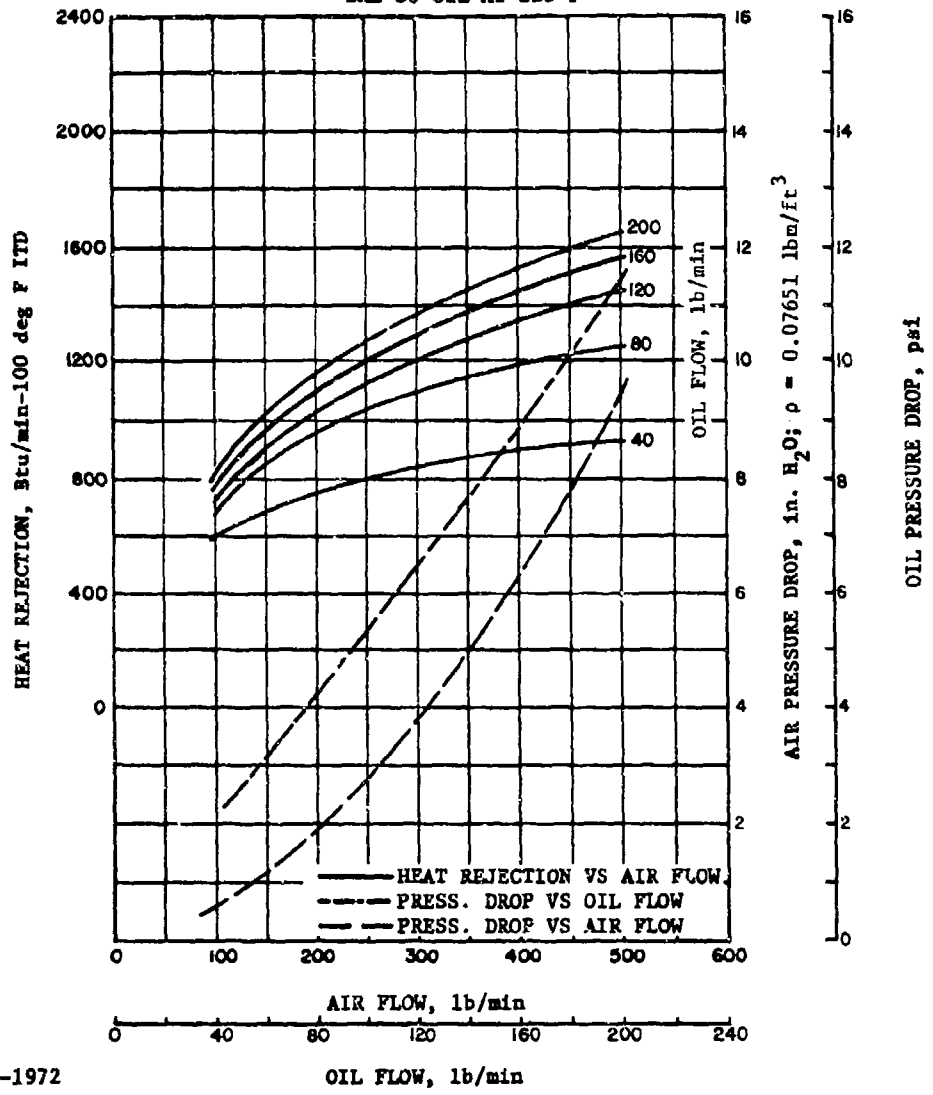

8-31-1972

Courtesy of HARRISON RADIATOR DIVISION - GMC

Figure A-2. 12.5 Fins/in., Core Depth 1.5 in., Oil Cooler Performance, I

AMCP 706-361

OIL-TO-AIR HEAT EXCHANGER--SQUARE FOOT FACE AREA
 AIR FIN HEIGHT 0.375 in. CORE DEPTH 1.5 in.
 OIL FIN HEIGHT 0.125 in. FINS/INCH 14
 PLATE THICKNESS 0.021 in.
 OIL SIDE FINS LOW/MODERATE PRESSURE LOSS
 INLET CONDITIONS AIR AT 100°F
 SAE 30 OIL AT 225°F

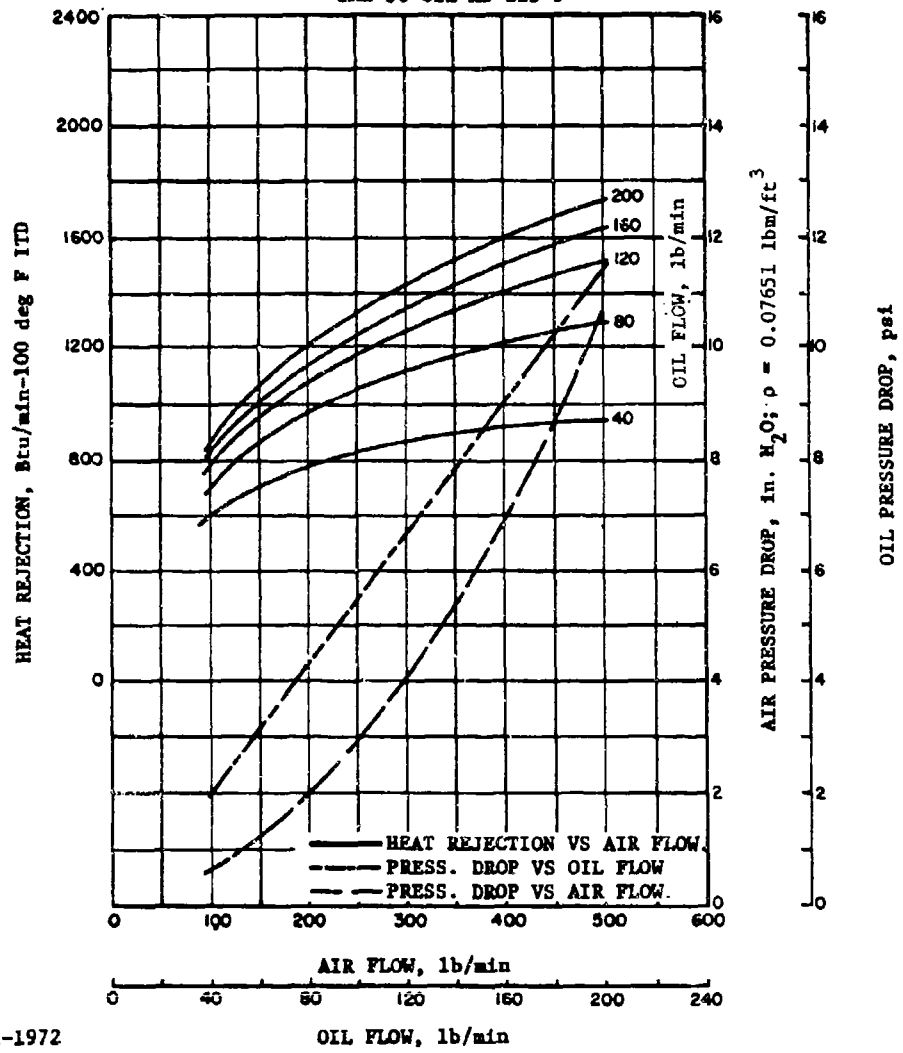

8-31-1972

Courtesy of HARRISON RADIATOR DIVISION - GMC

Figure A-3. 14 Fins/in., Core Depth 1.5 in., Oil Cooler Performance, I

AMCP 700-381

OIL-TO-AIR HEAT EXCHANGER—SQUARE FOOT FACE AREA
 AIR FIN HEIGHT 0.375 in. CORE DEPTH 1.5 in.
 OIL FIN HEIGHT 0.125 in. FINS/INCH 18
 PLATE THICKNESS 0.021 in.
 OIL SIDE FINS LOW/MODERATE PRESSURE LOSS
 INLET CONDITIONS AIR AT 100°F
 SAE 30 OIL AT 225°F

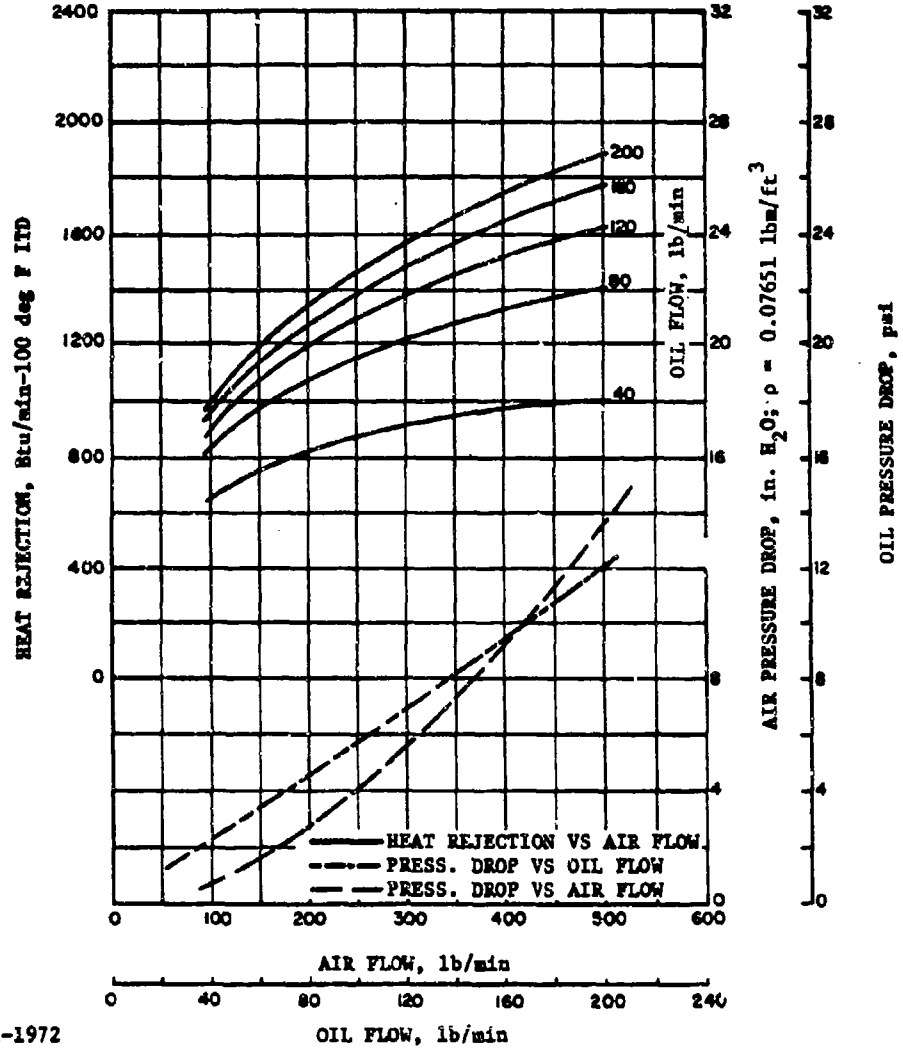

8-31-1972

Courtesy of HARRISON RADIATOR DIVISION - GMC

Figure A-4. 18 Fins/in., Core Depth 1.5 in., Oil Cooler Performance, I

AMCP 706-361

OIL-TO-AIR HEAT EXCHANGER—SQUARE FOOT FACE AREA
 AIR FIN HEIGHT 0.375 in. CORE DEPTH 3.0 in.
 OIL FIN HEIGHT 0.125 in. FINS/INCH 11
 PLATE THICKNESS 0.021 in.
 OIL SIDE FINS LOW/MODERATE PRESSURE LOSS
 INLET CONDITIONS AIR AT 100°F
 SAE 30 OIL AT 225°F

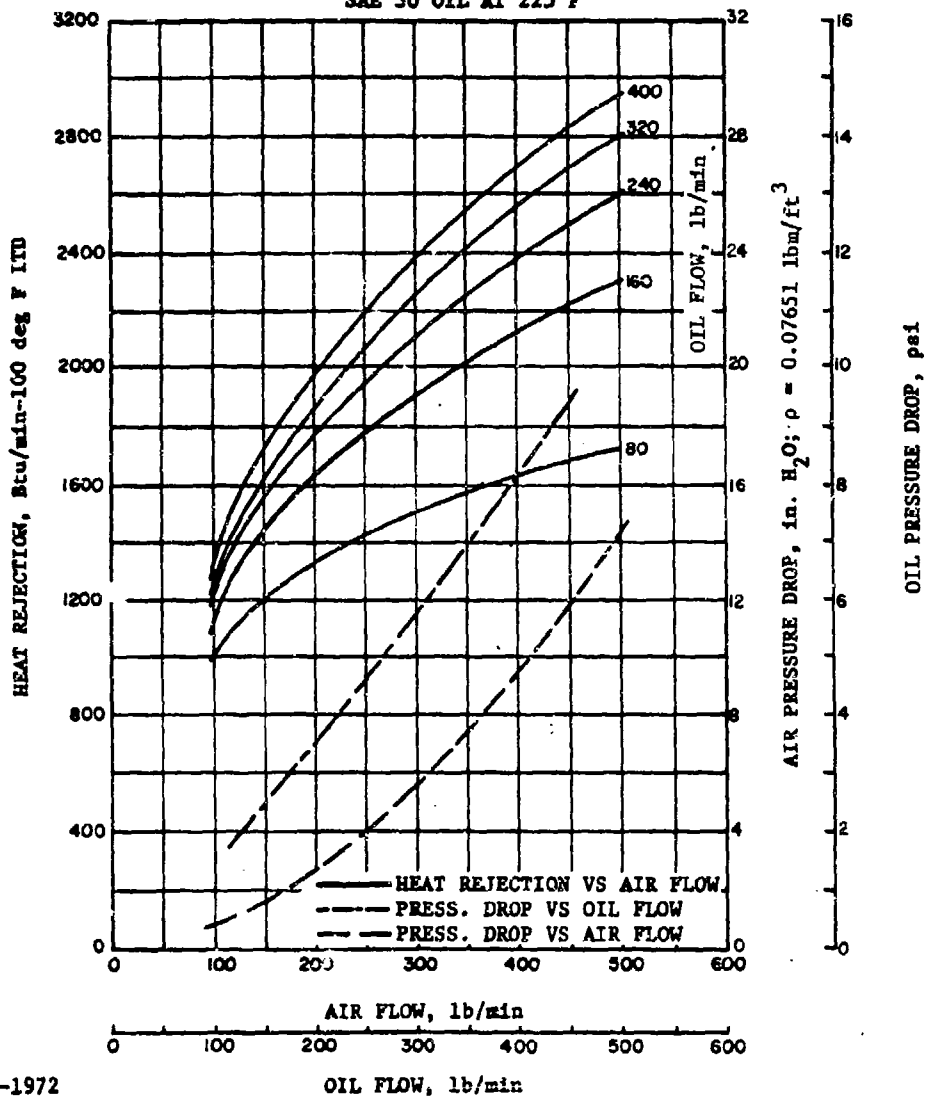

8-31-1972

Courtesy of HARRISON RADIATOR DIVISION - GMC

Figure A-5. 11 Fins/in., Core Depth 3 in., Oil Cooler Performance, I

OIL-TO-AIR HEAT EXCHANGER--SQUARE FOOT FACE AREA
 AIR FIN HEIGHT 0.375 in. CORE DEPTH 3.0 in.
 OIL FIN HEIGHT 0.125 in. FINS/INCH 12.5
 PLATE THICKNESS 0.021 in.
 OIL SIDE FINS LOW/MODERATE PRESSURE LOSS
 INLET CONDITIONS AIR AT 100°F
 SAE 30 OIL AT 225°F

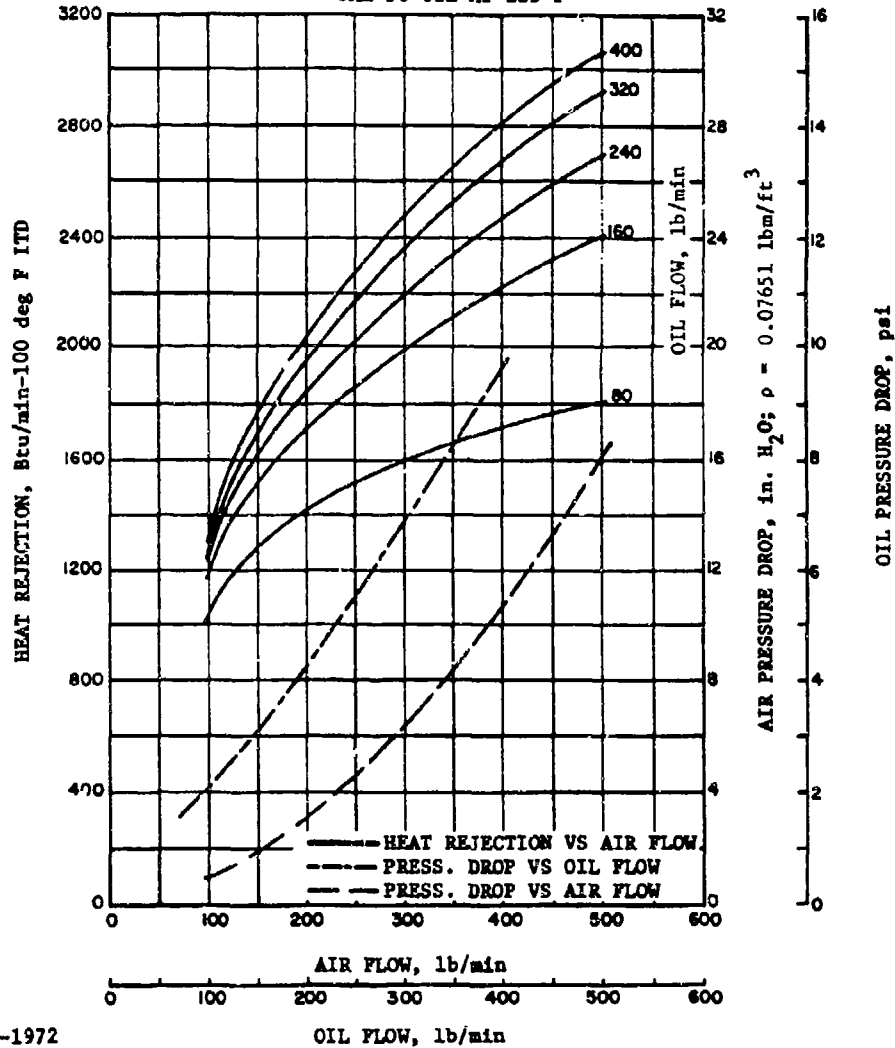

Courtesy of HARRISON RADIATOR DIVISION - GMC

Figure A-6. 12.5 Fins/in., Core Depth 3 in., Oil Cooler Performance, I

AMCP 708-361

OIL-TO-AIR HEAT EXCHANGER--SQUARE FOOT FACE AREA
 AIR FIN HEIGHT 0.375 in. CORE DEPTH 3.0 in.
 OIL FIN HEIGHT 0.125 in. FINS/INCH 14
 PLATE THICKNESS 0.021 in.
 OIL SIDE FINS LOW/MODERATE PRESSURE LOSS
 INLET CONDITIONS AIR AT 100°F
 SAE 30 OIL AT 225°F

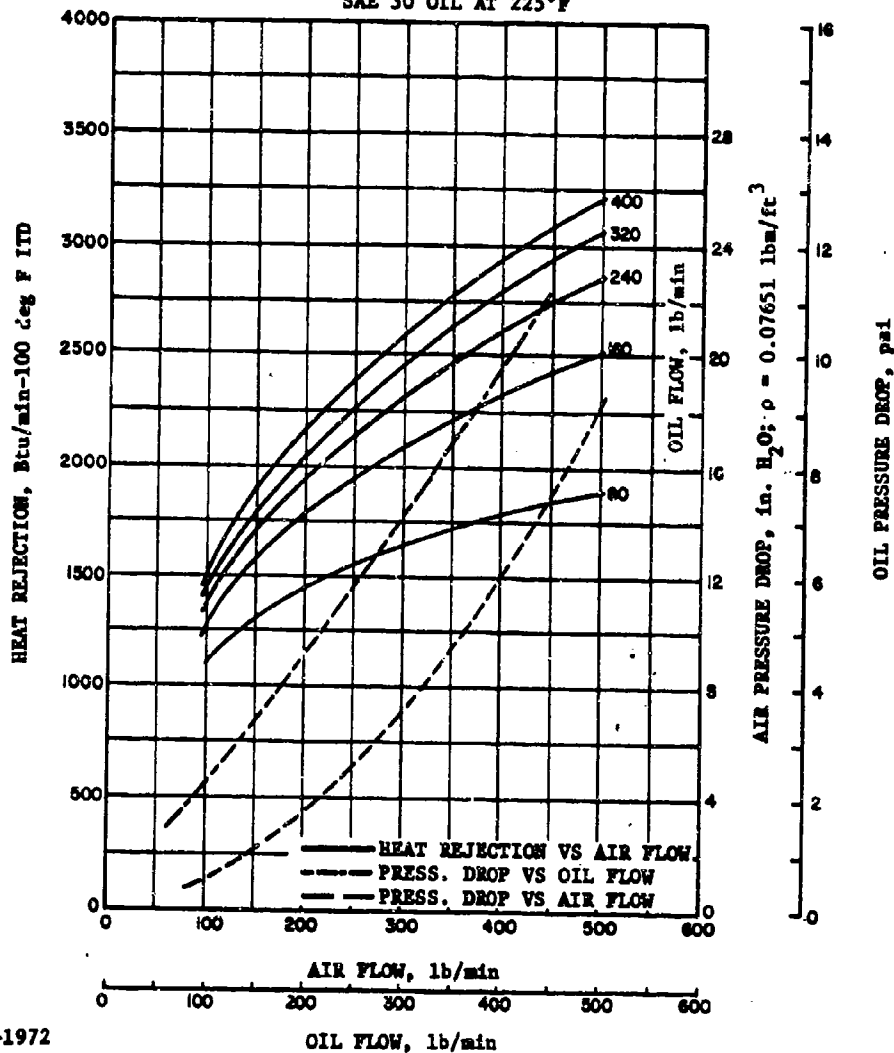

8-31-1972

Courtesy of HARRISON RADIATOR DIVISION - GMC

Figure A-7. 14 Fins/in., Core Depth 3 in., Oil Cooler Performance, I

OIL-TO-AIR HEAT EXCHANGER--SQUARE FOOT FACE AREA
 AIR FIN HEIGHT 0.375 in. CORE DEPTH 3.0 in.
 OIL FIN HEIGHT 0.125 in. FINS/INCH 18
 PLATE THICKNESS 0.021 in.
 OIL SIDE FINS LOW/MODERATE PRESSURE LOSS
 INLET CONDITIONS AIR AT 100°F
 SAE 39 OIL AT 225°F

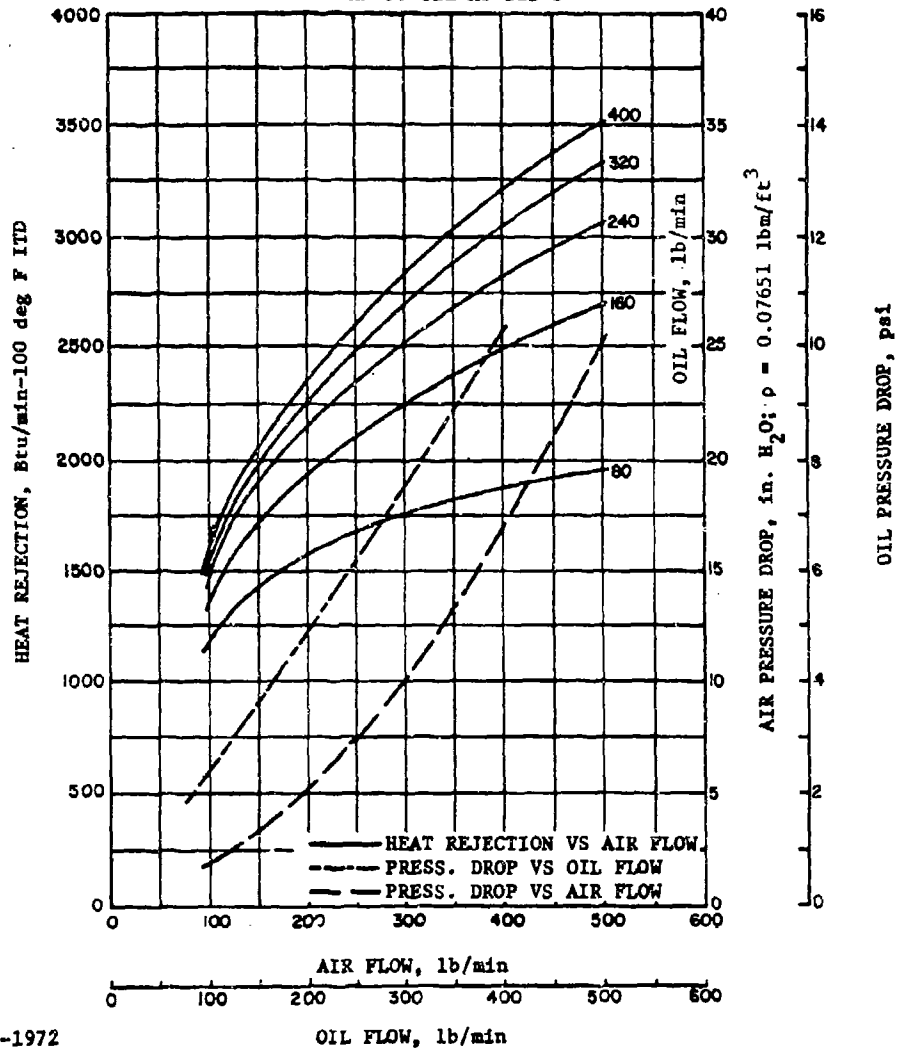

8-31-1972

Courtesy of HARRISON RADIATOR DIVISION - GMC

Figure A-8. 18 Fins/in., Core Depth 3 in., Oil Cooler Performance, I

AMCP 706-361

OIL-TO-AIR HEAT EXCHANGER—SQUARE FOOT FACE AREA
 AIR FIN HEIGHT 0.375 in. CORE DEPTH 4.5 in.
 OIL FIN HEIGHT 0.125 in. FINS/INCH 11
 PLATE THICKNESS 0.021 in.
 OIL SIDE FINS LOW/MODERATE PRESSURE LOSS
 INLET CONDITIONS AIR AT 100°F
 SAE 30 OIL AT 225°F

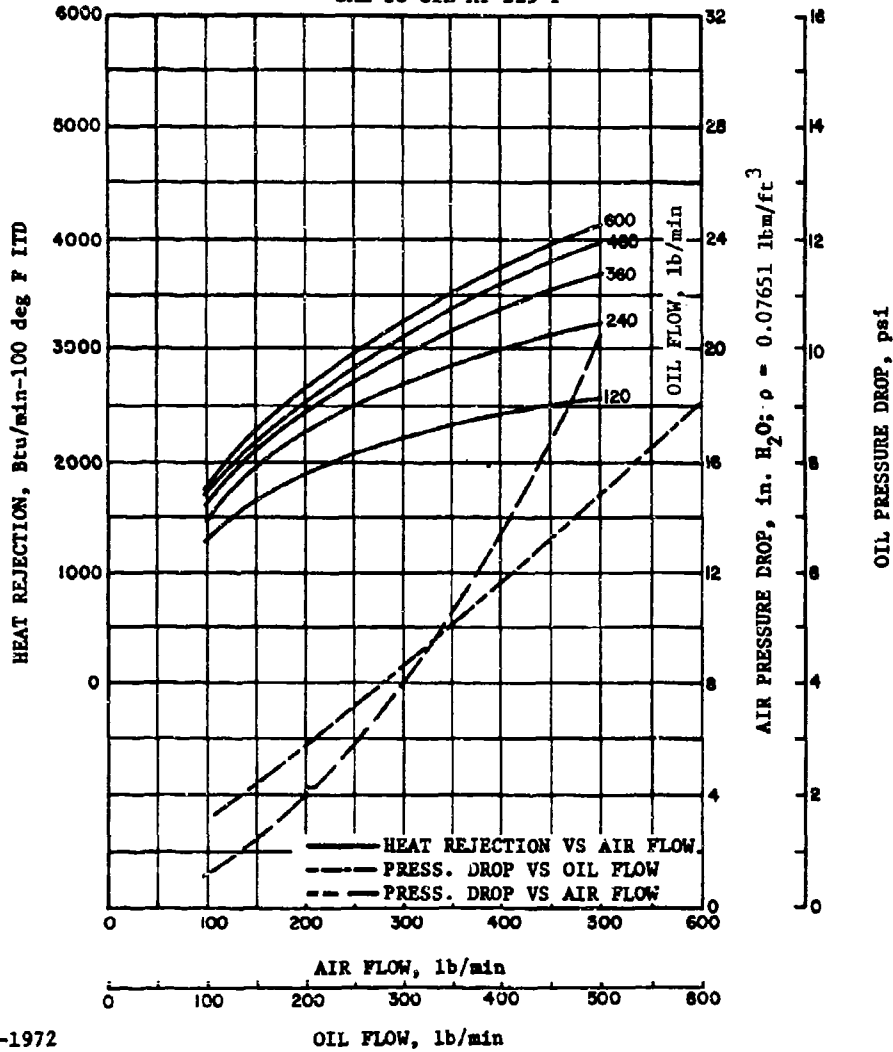

8-31-1972

Courtesy of HARRISON RADIATOR DIVISION - GMC

Figure A-9. 11 Fins/in., Core Depth 4.5 in., Oil Cooler Performance, I

OIL-TO-AIR HEAT EXCHANGER--SQUARE FOOT FACE AREA
 AIR FIN HEIGHT 0.375 in. CORE DEPTH 4.5 in.
 OIL FIN HEIGHT 0.125 in. FINE/INCH 12.5
 PLATE THICKNESS 0.021 in.
 OIL SIDE FINS LOW/MODERATE PRESSURE LOSS
 INLET CONDITIONS AIR AT 100°F
 SAE 30 OIL AT 225°F

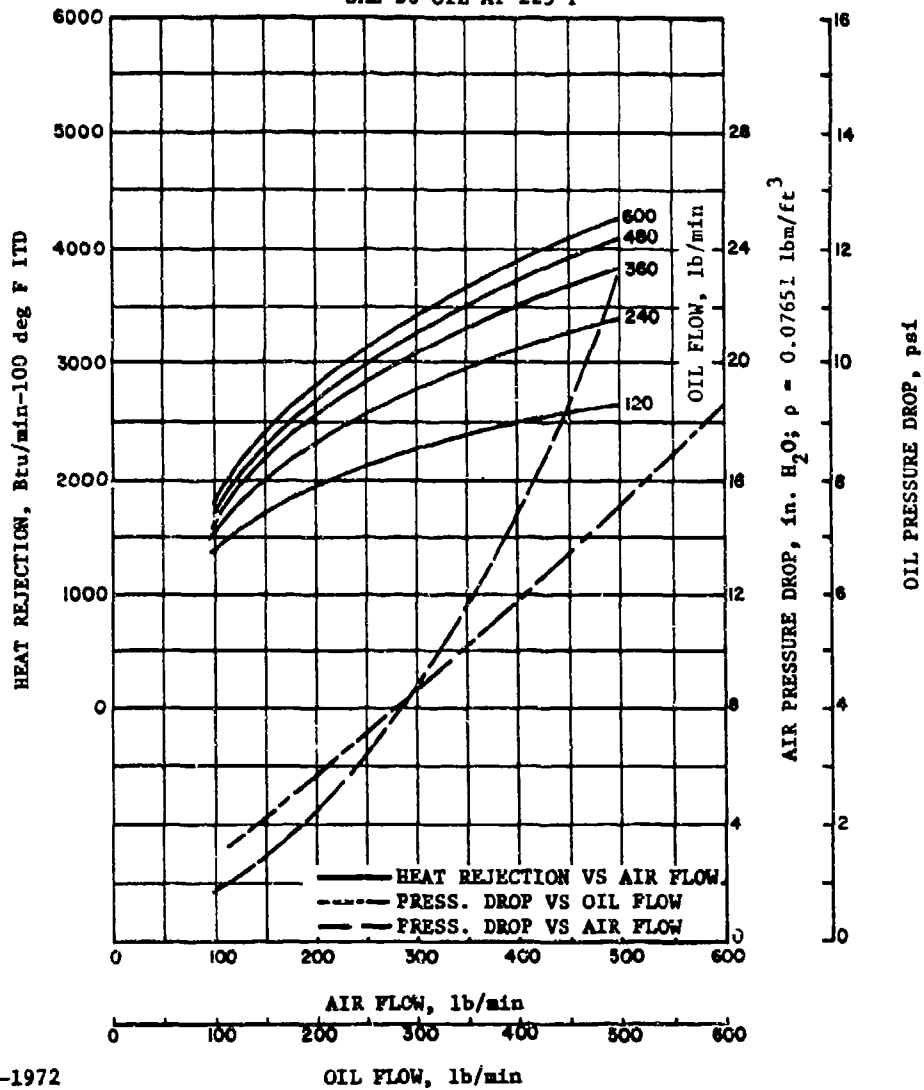

8-31-1972

Courtesy of HARRISON RADIATOR DIVISION - GMC

Figure A-10. 12.5 Fins/in., Core Depth 4.5 in., Oil Cooler Performance, i

AMCP 706-381

OIL-TO-AIR HEAT EXCHANGER--SQUARE FOOT FACE AREA
 AIR FIN HEIGHT 0.375 in. CORE DEPTH 4.5 in.
 OIL FIN HEIGHT 0.125 in. FINS/INCH 14
 PLATE THICKNESS 0.021 in.
 OIL SIDE FINS LOW/MODERATE PRESSURE LOSS
 INLET CONDITIONS AIR AT 100°F
 SAE 30 OIL AT 225°F

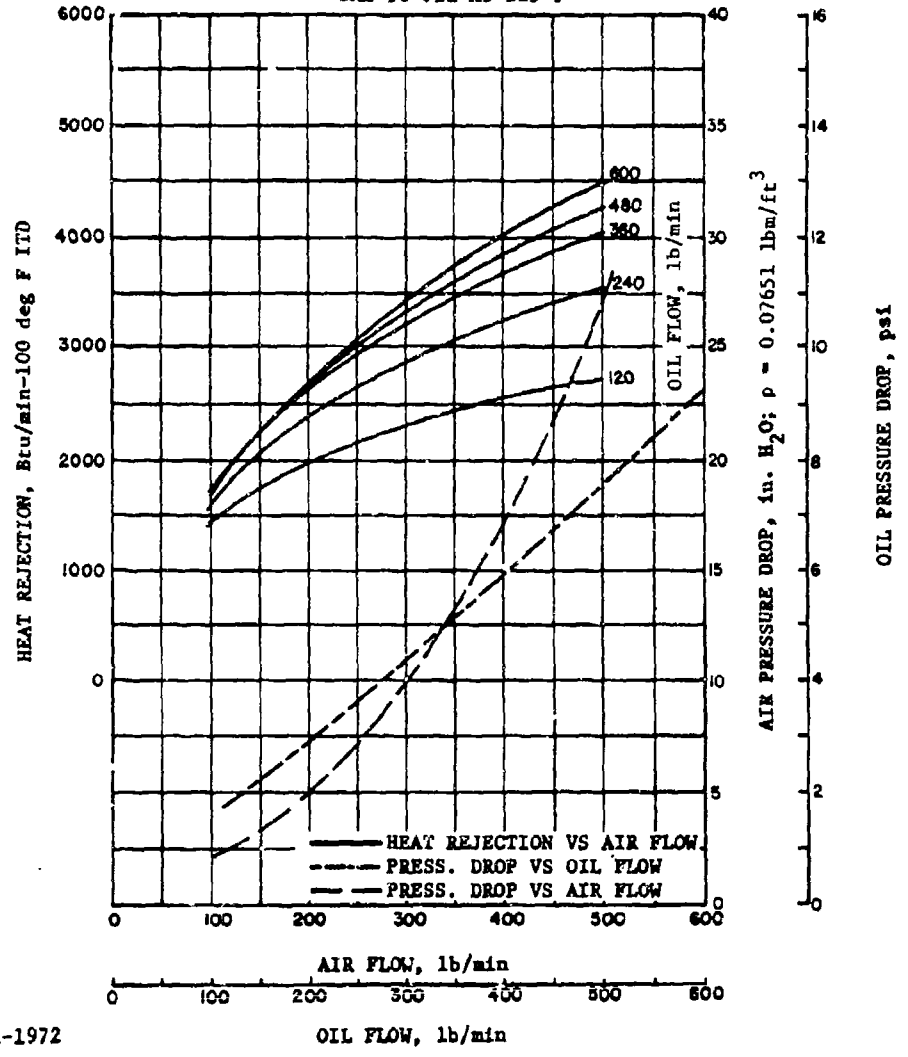

8-31-1972

Courtesy of HARRISON RADIATOR DIVISION - GMC

Figure A-11. 14 Fins/in., Core Depth 4.5 in., Oil Cooler Performance, I

OIL-TO-AIR HEAT EXCHANGER--SQUARE FOOT FACE AREA
 AIR FIN HEIGHT 0.375 in. CORE DEPTH 4.5 in.
 OIL FIN HEIGHT 0.125 in. FINS/INCH 18
 PLATE THICKNESS 0.021 in.
 OIL SIDE FINS LOW/MODERATE PRESSURE LOSS
 INLET CONDITIONS AIR AT 100°F
 SAE 30 OIL AT 225°F

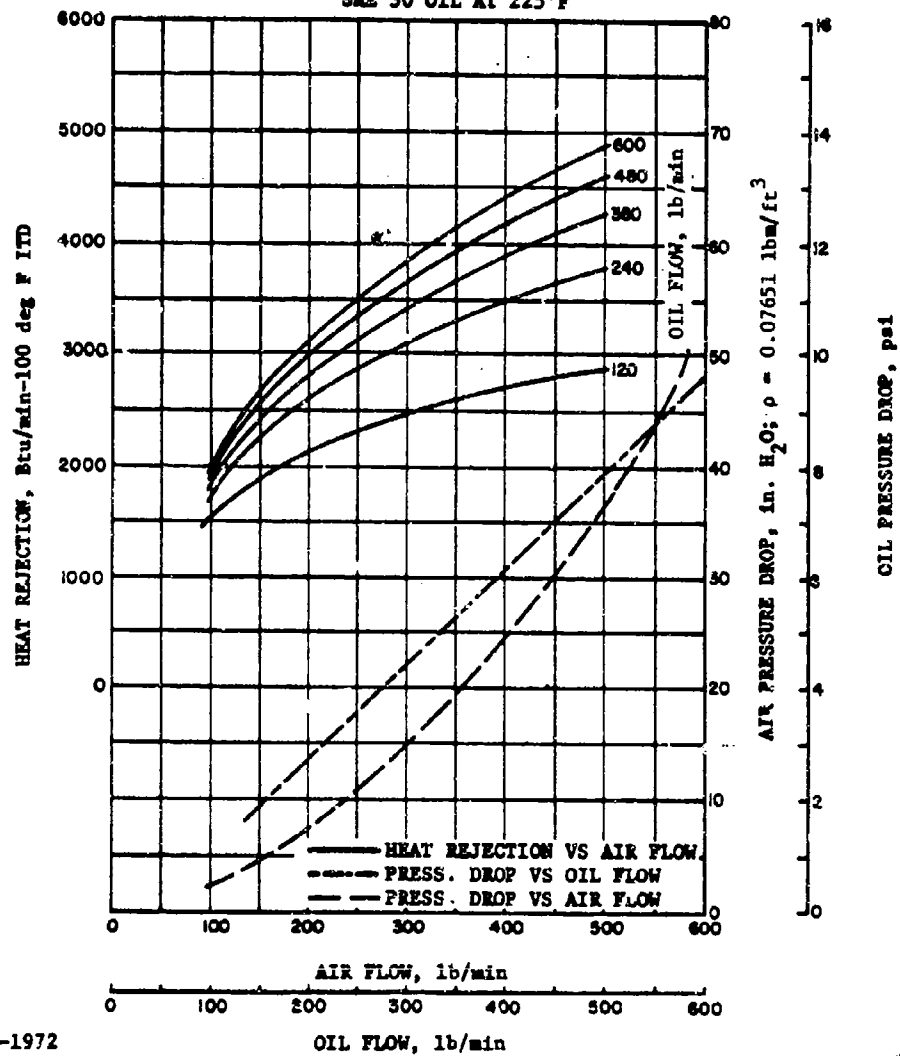

8-31-1972

Courtesy of HARRISON RADIATOR DIVISION - GMC

Figure A-12. 18 Fins/in., Core Depth 4.5 in., Oil Cooler Performance, I

AMCP 708-381

OIL-TO-AIR HEAT EXCHANGER—SQUARE FOOT FACE AREA
 AIR FIN HEIGHT 0.375 in. CORE DEPTH 6.0 in.
 OIL FIN HEIGHT 0.125 in. FINS/INCH 11
 PLATE THICKNESS 0.021 in.
 OIL SIDE FINS LOW/MODERATE PRESSURE LOSS
 INLET CONDITIONS AIR AT 100°F
 SAE 30 OIL AT 225°F

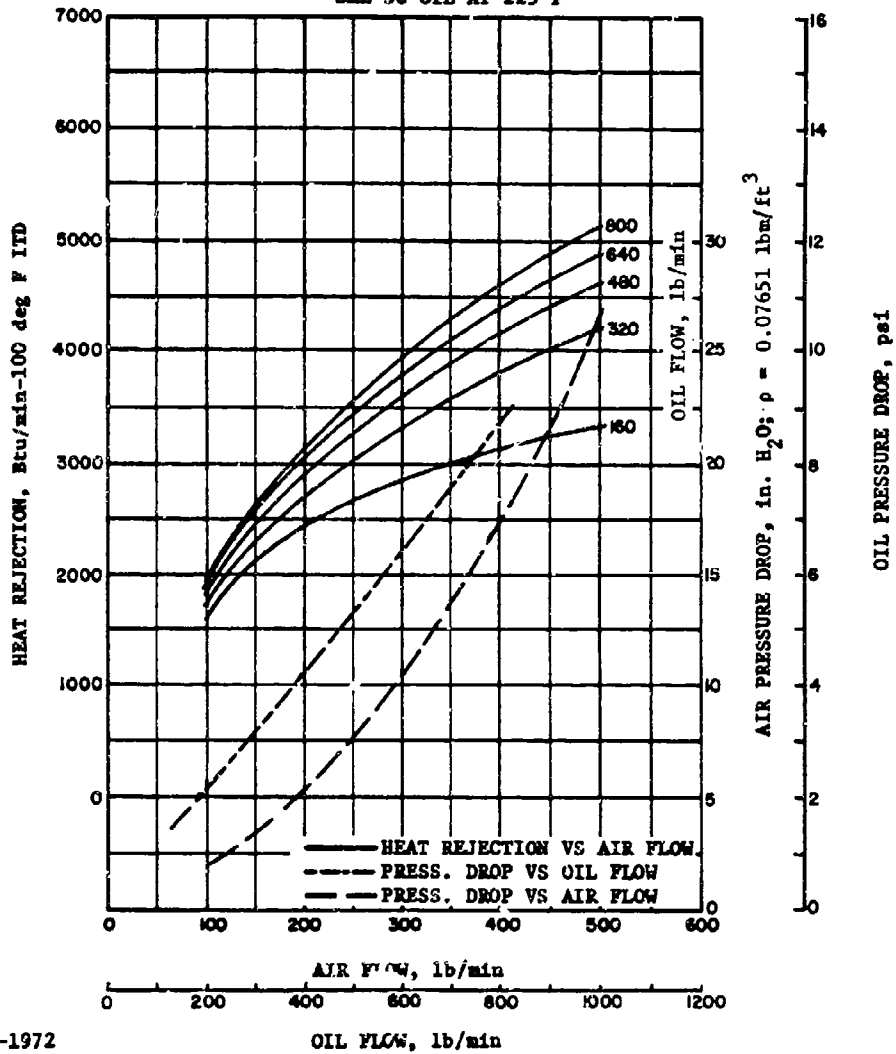

8-31-1972

Courtesy of HARRISON RADIATOR DIVISION - GMC

Figure A-13. 11 Fins/in., Core Depth 6 in., Oil Cooler Performance, I

OIL-TO-AIR HEAT EXCHANGER--SQUARE FOOT FACE AREA
 AIR FIN HEIGHT 0.375 in. CORE DEPTH 6.0 in.
 OIL FIN HEIGHT 0.125 in. FINS/INCH 12.5
 PLATE THICKNESS 0.021 in.
 OIL SIDE FINS LOW/MODERATE PRESSURE LOSS
 INLET CONDITIONS AIR AT 100°F
 SAE 30 OIL AT 225°F

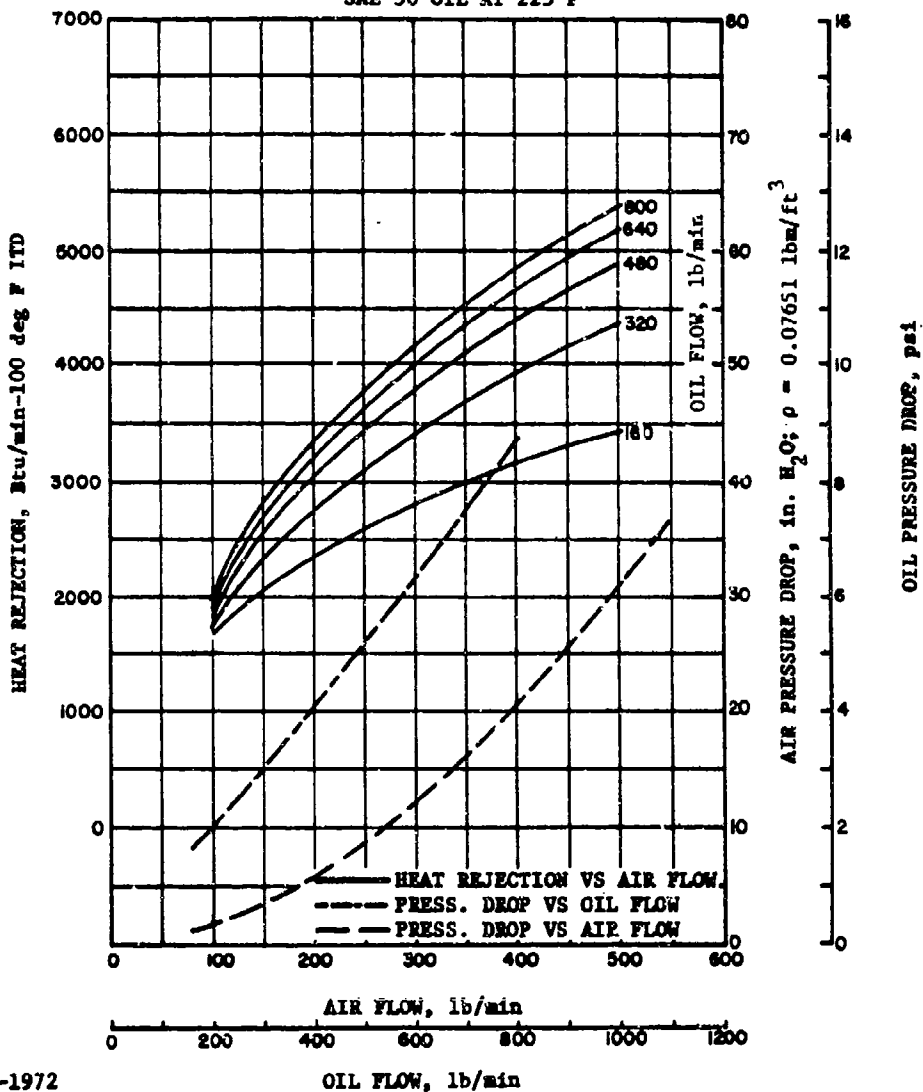

8-31-1972

Courtesy of HARRISON RADIATOR DIVISION - GMC

Figure A-14. 12.5 Fins/in., Core Depth 6 in., Oil Cooler Performance, I

AMCP 708-381

OIL-TO-AIR HEAT EXCHANGER--SQUARE FOOT FACE AREA
 AIR FIN HEIGHT 0.375 in. CORE DEPTH 6.0 in.
 OIL FIN HEIGHT 0.125 in. FINS/INCH 14
 PLATE THICKNESS 0.021 in.
 OIL SIDE FINS LOW/MODERATE PRESSURE LOSS
 INLET CONDITIONS AIR AT 100°F
 SAE 30 OIL AT 225°F

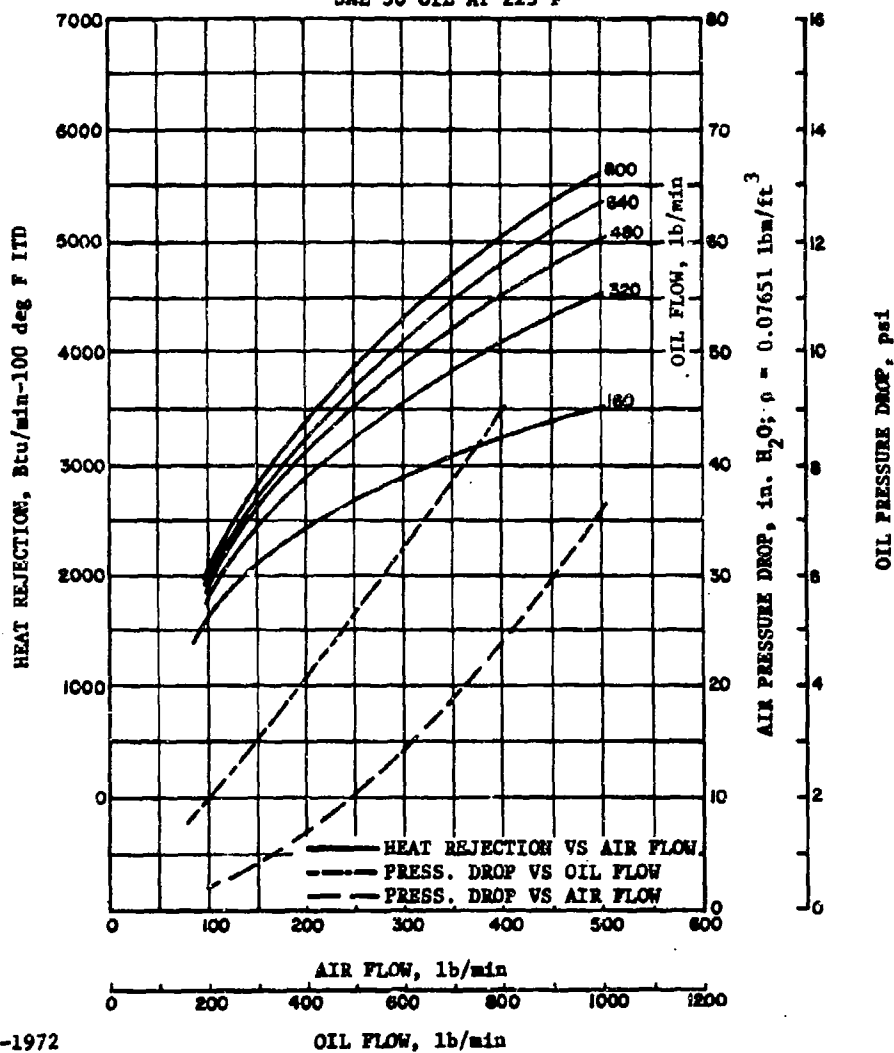

Courtesy of HARRISON RADIATOR DIVISION - GMC

Figure A-15. 14 Fins/in., Core Depth 6 in., Oil Cooler Performance, I

OIL-TO-AIR HEAT EXCHANGER--SQUARE FOOT FACE AREA
 AIR FIN HEIGHT 0.375 in. CORE DEPTH 6.0in.
 OIL FIN HEIGHT 0.125 in. FINS/INCH 18
 PLATE THICKNESS 0.021 in.
 OIL SIDE FINS LOW/MODERATE PRESSURE LOSS
 INLET CONDITIONS AIR AT 100°F
 SAE 30 OIL AT 225°F

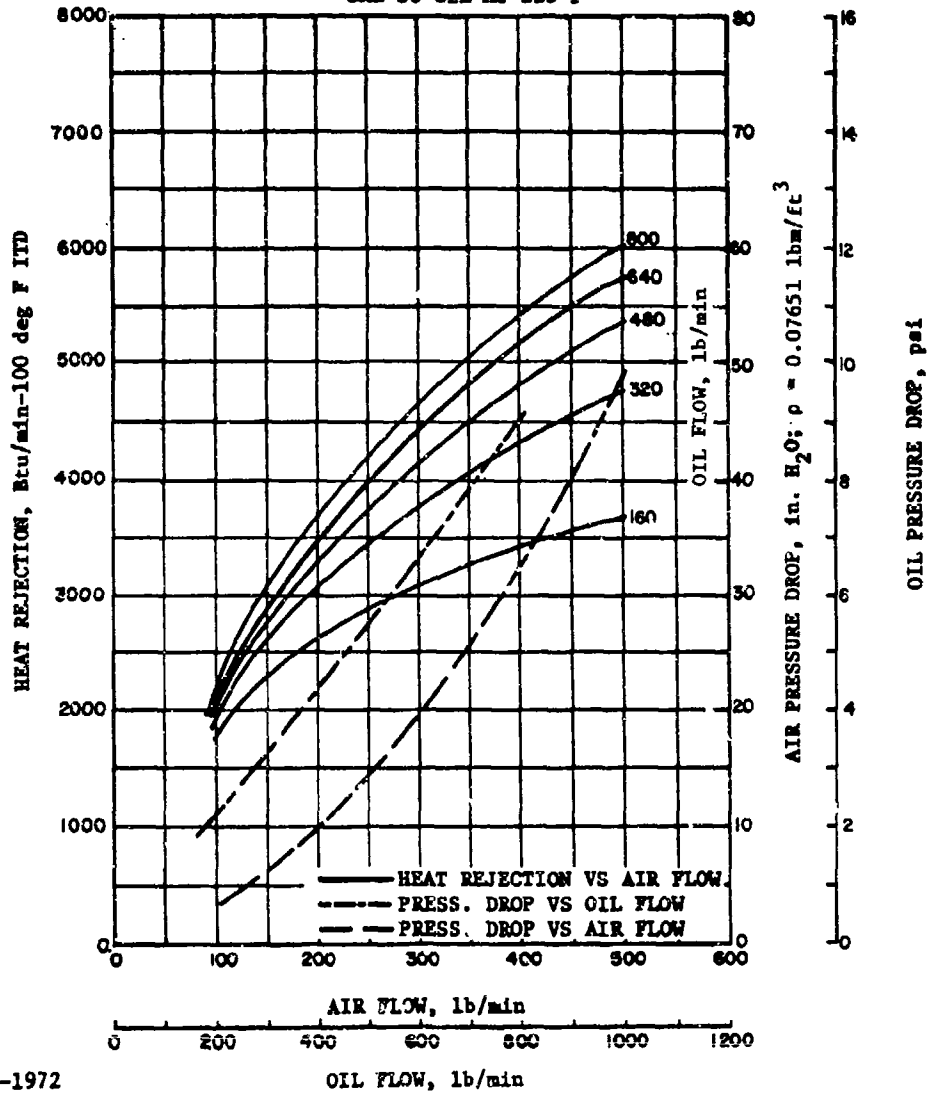

8-31-1972

Courtesy of HARRISON RADIATOR DIVISION - GMC

Figure A-16. 18 Fins/in., Core Depth 6 in., Oil Cooler Performance, I

AMCP 708-361

OIL-TO-AIR HEAT EXCHANGER—SQUARE FOOT FACE AREA
 AIR FIN HEIGHT 0.375 in. CORE DEPTH 1.5 in.
 OIL FIN HEIGHT 0.125 in. FINS/INCH 11
 PLATE THICKNESS 0.021 in.
 OIL SIDE FINS LOW/MODERATE PRESSURE LOSS
INLET CONDITIONS AIR AT 100°F
SAE 30 OIL AT 225°F

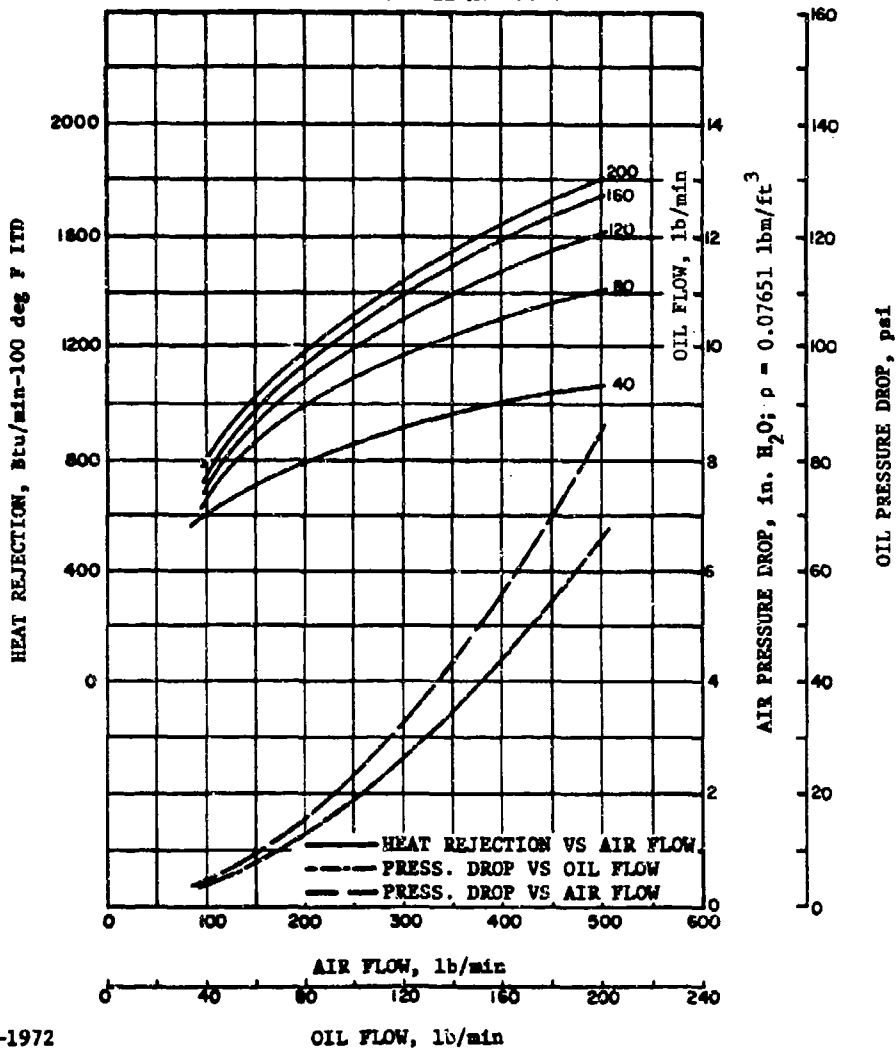

8-31-1972

Courtesy of HARRISON RADIATOR DIVISION - GMC

Figure A-17. 11 Fins/in., Core Depth 1.5 in., Oil Cooler Performance, II

OIL-TO-AIR HEAT EXCHANGER--SQUARE FOOT FACE AREA
 AIR FIN HEIGHT 0.375 in. CORE DEPTH 1.5 in.
 OIL FIN HEIGHT 0.125 in. FINS/INCH 12.5
 PLATE THICKNESS 0.021 in.
 OIL SIDE FINS LOW/MODERATE PRESSURE LOSS
 INLET CONDITIONS AIR AT 100°F
 SAE 30 OIL AT 225°F

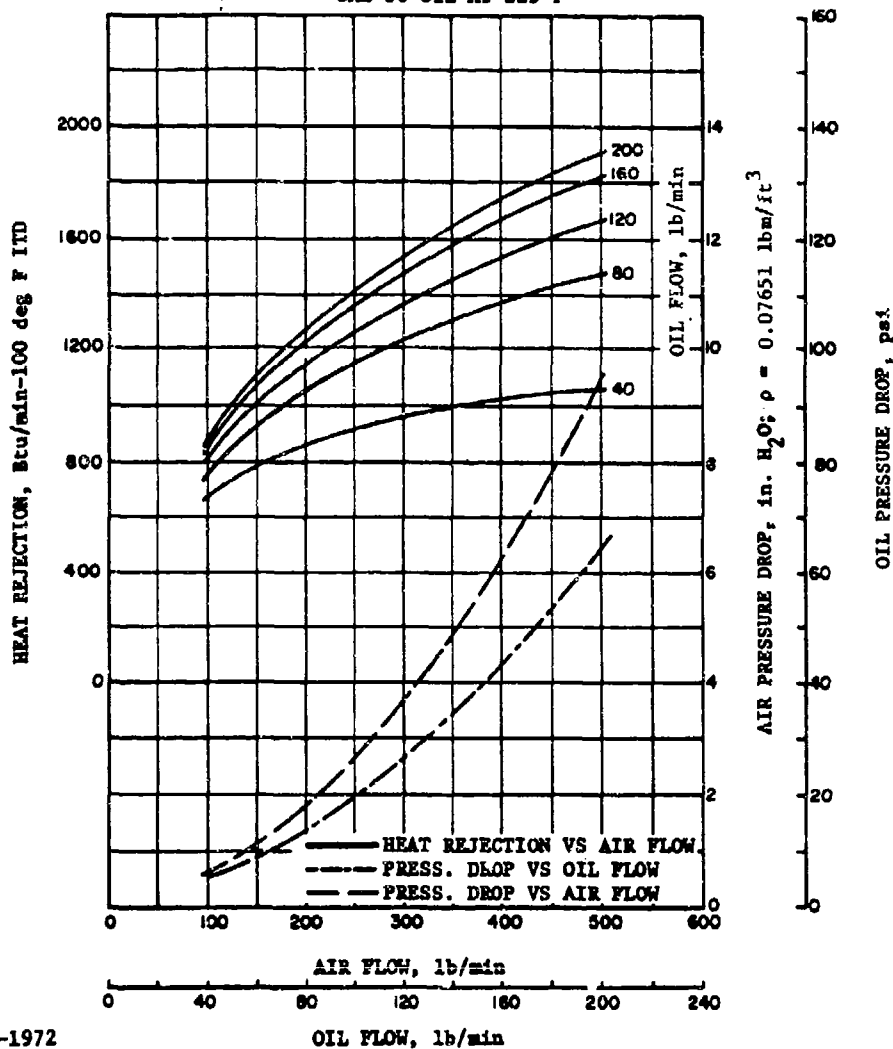

8-31-1972

Courtesy of HARRISON RADIATOR DIVISION - GMC

Figure A-18. 12.5 Fins/in., Core Depth 1.5 in., Oil Cooler Performance, II

AMCF 706-381

OIL-TO-AIR HEAT EXCHANGER--SQUARE FOOT FACE AREA
 AIR FIN HEIGHT 0.375 in. CORE DEPTH 1.5 in.
 OIL FIN HEIGHT 0.125 in. FINS/INCH 14
 PLATE THICKNESS 0.021 in.
 OIL SIDE FINS LOW/MODERATE PRESSURE LOSS
 INLET CONDITIONS AIR AT 100°F
 SAE 30 OIL AT 225°F

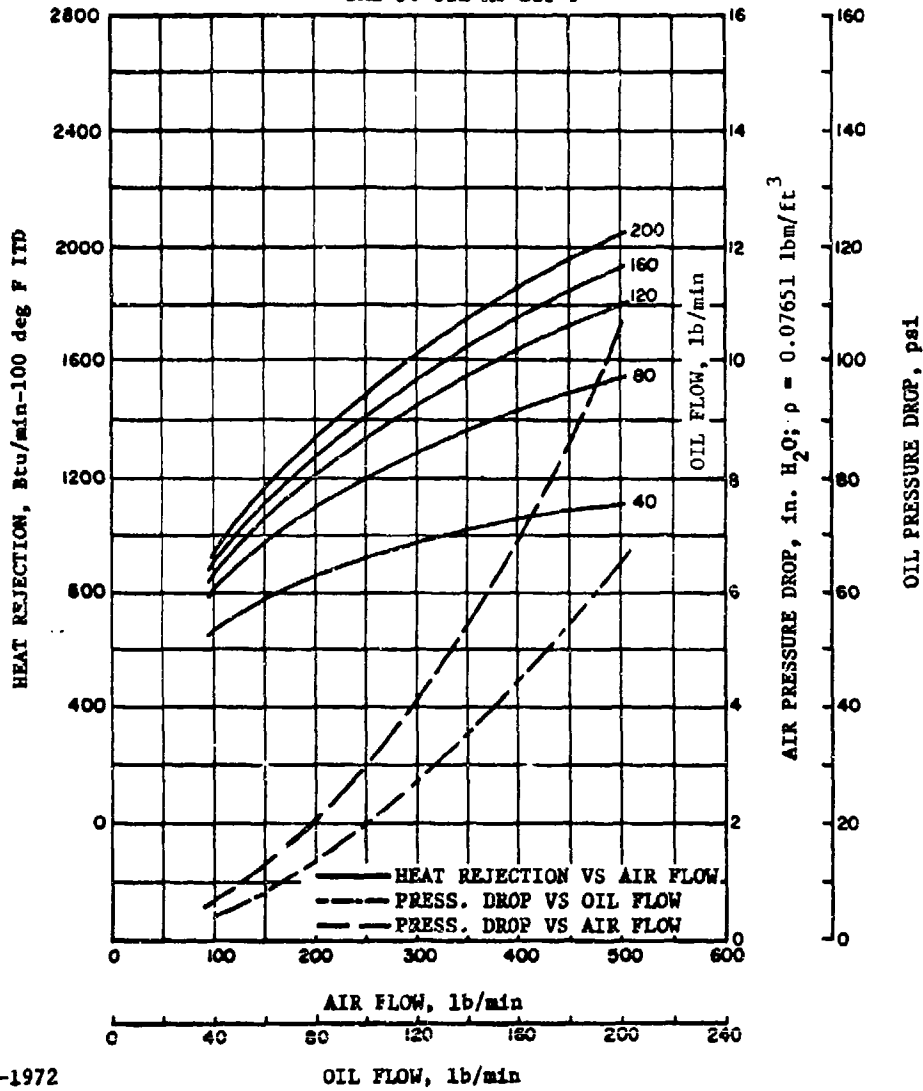

8-31-1972

Courtesy of HARRISON RADIATOR DIVISION - GMC

Figure A-19. 14 Fins/in., Core Depth 1.5 in., Oil Cooler Performance, II

OIL-TO-AIR HEAT EXCHANGER--SQUARE FOOT FACE AREA
 AIR FIN HEIGHT 0.375 in. CORE DEPTH 1.5 in
 OIL FIN HEIGHT 0.125 in. FINS/LNCH 18
 PLATE THICKNESS 0.021 in.
 OIL SIDE FINS LOW/MODERATE PRESSURE LOSS
 INLET CONDITIONS AIR AT 100°F
 SAE 30 OIL AT 225°F

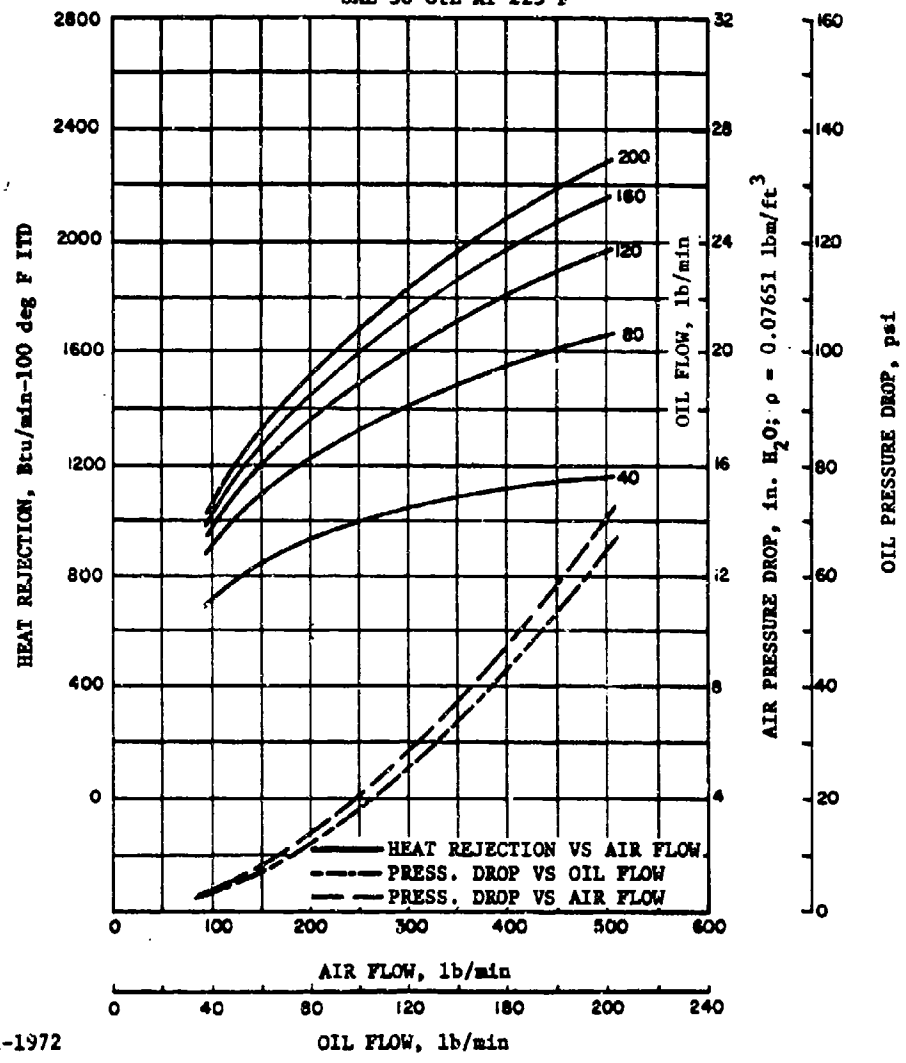

8-31-1972

Courtesy of HARRISON RADIATOR DIVISION - GMC

Figure A-20. 18 Fins/in., Core Depth 1.5 in., Oil Cooler Performance, II

AMCP 708-381

OIL-TO-AIR HEAT EXCHANGER—SQUARE FOOT FACE AREA
 AIR FIN HEIGHT 0.375 in. CORE DEPTH 3.0 in.
 OIL FIN HEIGHT 0.125 in. FINS/INCH 11
 PLATE THICKNESS 0.021 in.
 OIL SIDE FINS LOW/MODERATE PRESSURE LOSS
 INLET CONDITIONS AIR AT 100°F
 SAE 30 OIL AT 225°F

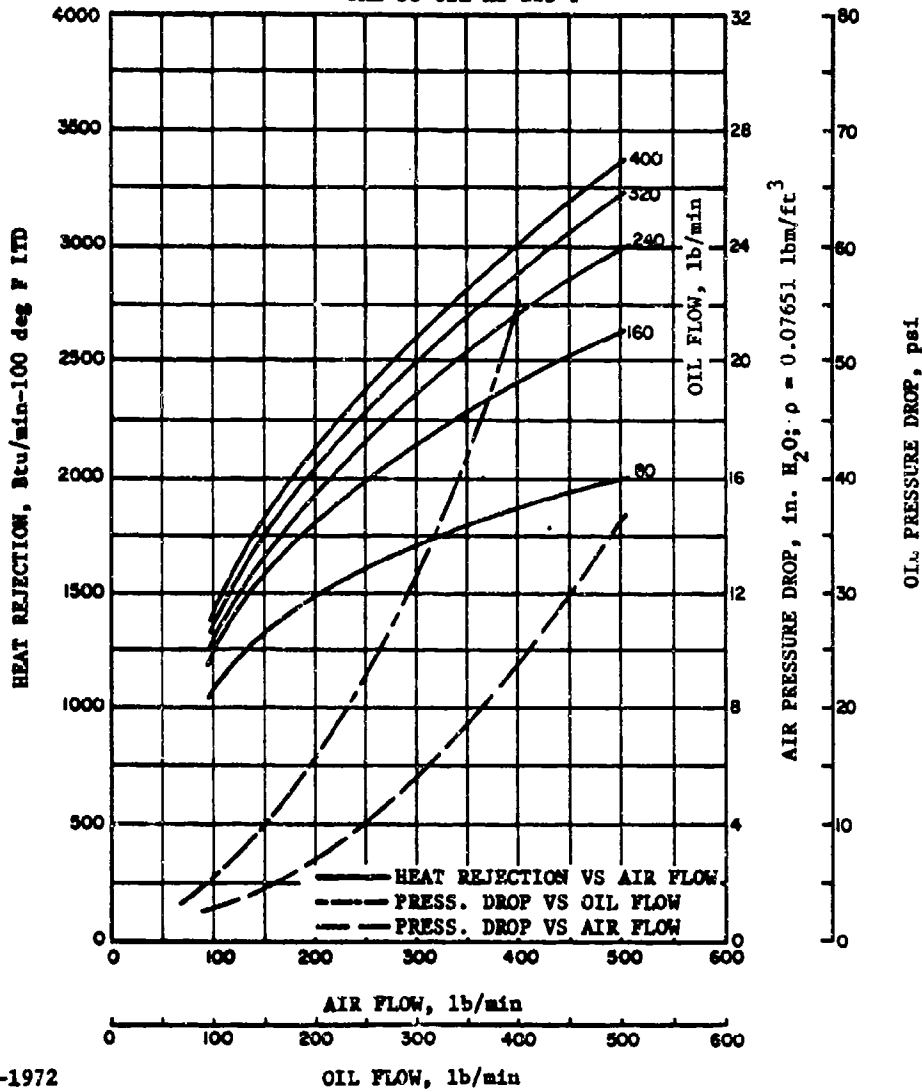

8-31-1972

Courtesy of HARRISON RADIATOR DIVISION - GMC

Figure A-21. 11 Fins/in., Core Depth 3 in., Oil Cooler Performance, II

OIL-TO-AIR HEAT EXCHANGER--SQUARE FOOT FACE AREA
 AIR FIN HEIGHT 0.375 in. CORE DEPTH 3.0 in.
 OIL FIN HEIGHT 0.125 in. FINS/INCH 12.5
 PLATE THICKNESS 0.021 in.
 OIL SIDE FINS LOW/MODERATE PRESSURE LOSS
 INLET CONDITIONS AIR AT 100°F
 SAE 30 OIL AT 225°F

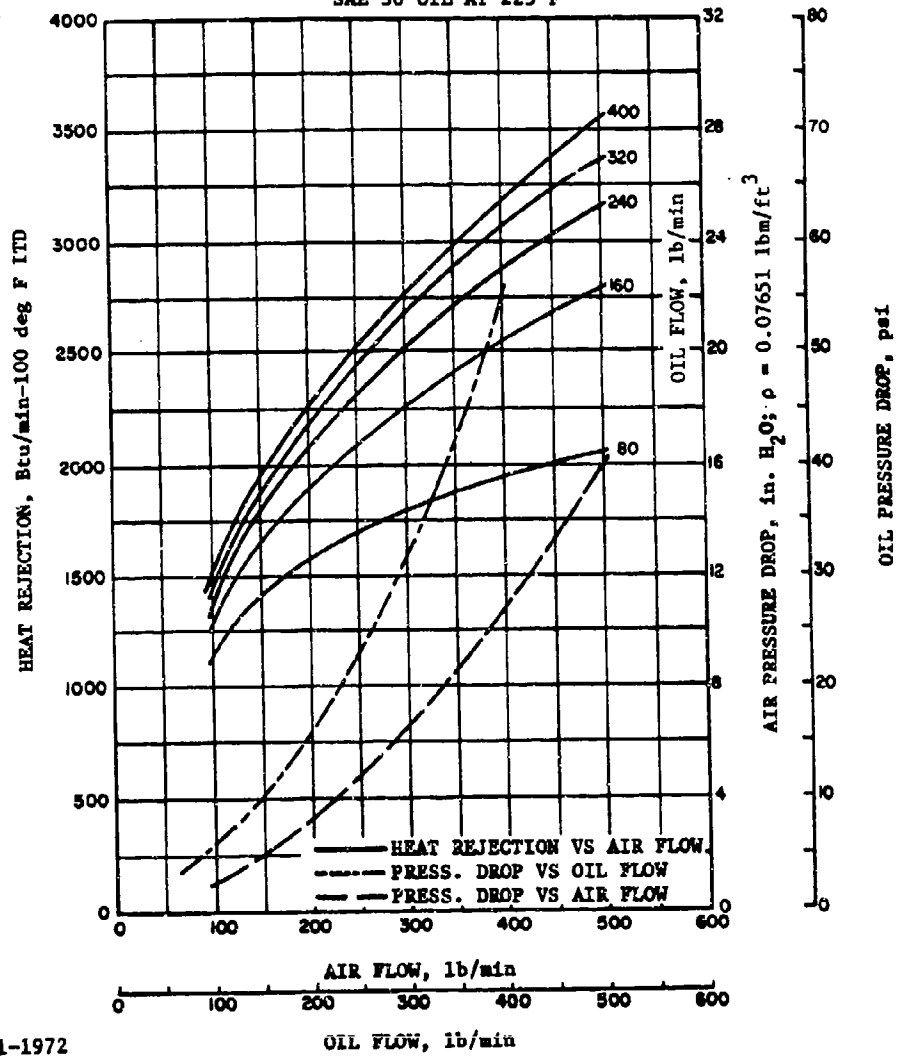

8-31-1972

Courtesy of HARRISON RADIATOR DIVISION - GMC

Figure A-22. 12.5 Fins/in., Core Depth 3 in., Oil Cooler Performance, II

AMCP 708-361

OIL-TO-AIR HEAT EXCHANGER--SQUARE FOOT FACE AREA
 AIR FIN HEIGHT 0.375 in. CORE DEPTH 3.0 in.
 OIL FIN HEIGHT 0.125 in. FINS/INCH 14
 PLATE THICKNESS 0.021 in.
 OIL SIDE FINS LOW/MODERATE PRESSURE LOSS
 INLET CONDITIONS AIR AT 100°F
 SAE 30 OIL AT 225°F

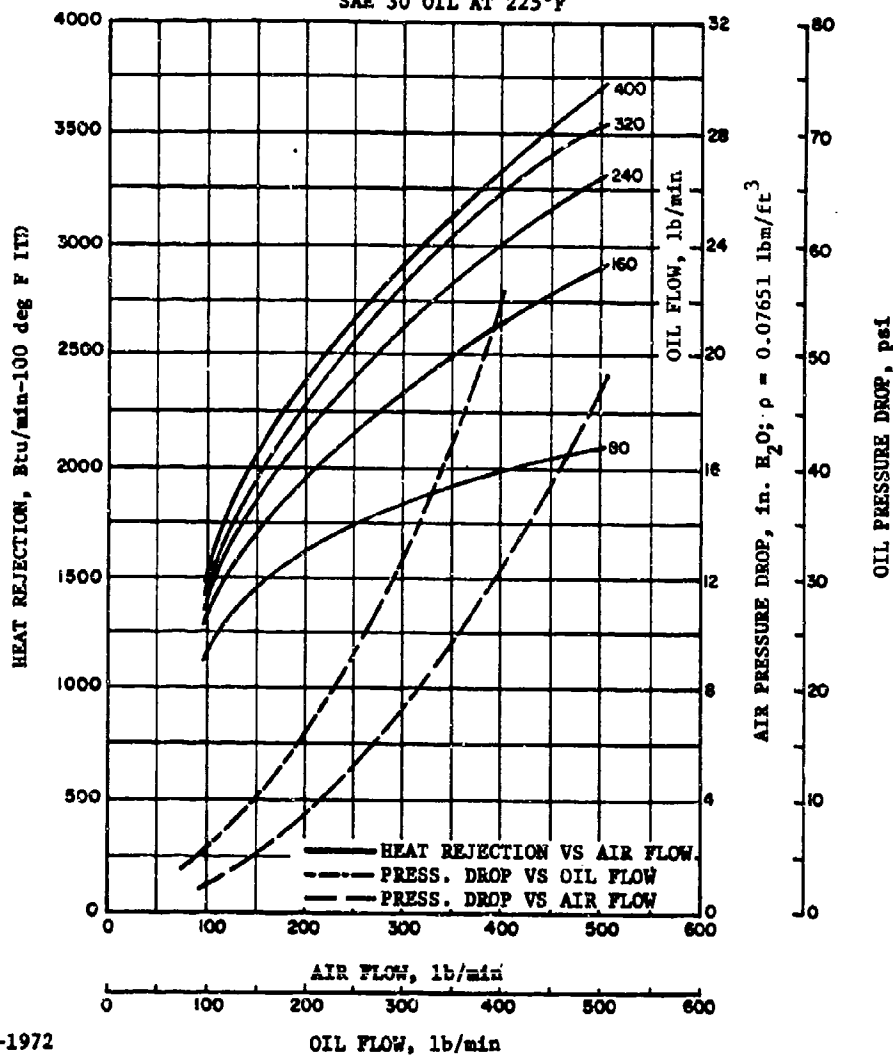

8-31-1972

Courtesy of HARRISON RADIATOR DIVISION - GMC

Figure A-23. 14 Fins/in., Core Depth 3 in., Oil Cooler Performance, II

OIL-TO-AIR HEAT EXCHANGER--SQUARE FOOT FACE AREA
 AIR FIN HEIGHT 0.375 in. CORE DEPTH 3.0 in.
 OIL FIN HEIGHT 0.125 in. FINS/INCH 18
 PLATE THICKNESS 0.021 in.
 OIL SIDE FINS LOW/MODERATE PRESSURE LOSS
 INLET CONDITIONS AIR AT 100°F
 SAE 30 OIL AT 225°F

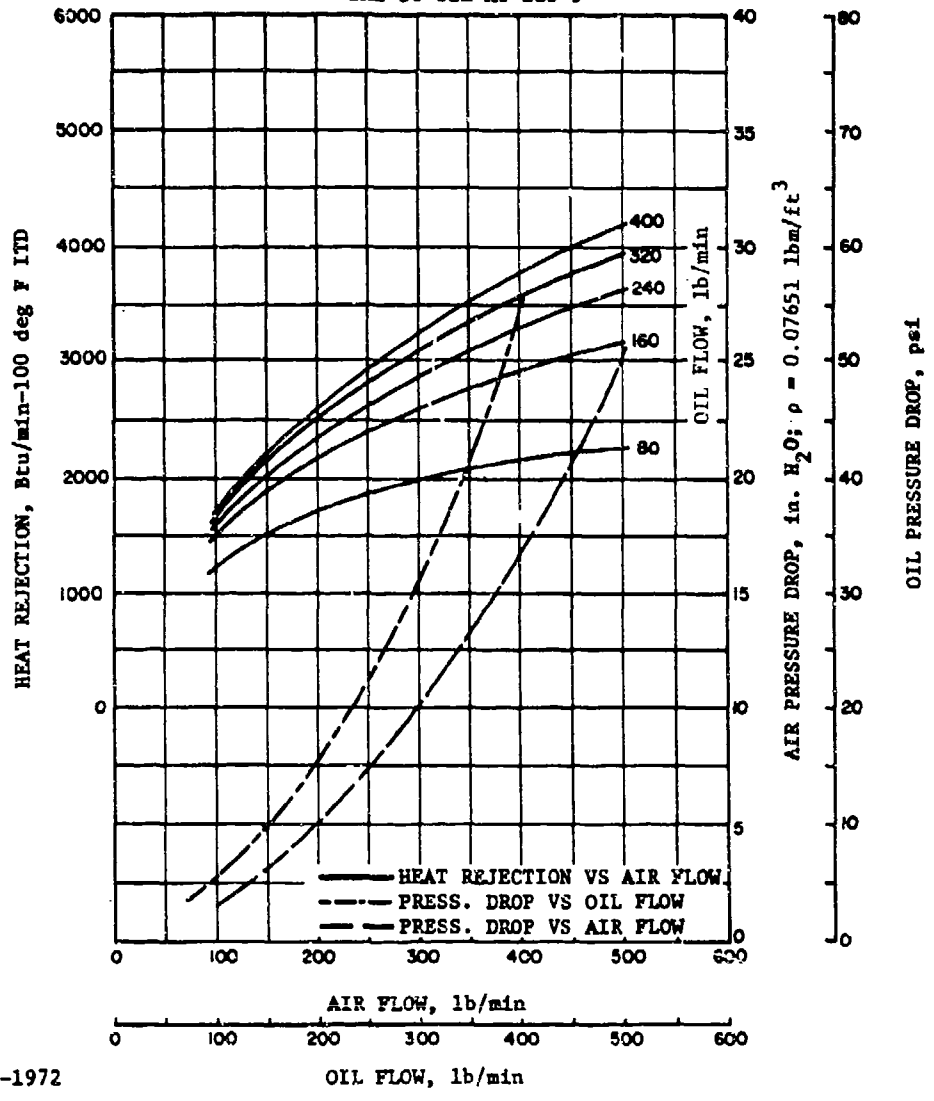

8-31-1972

Courtesy of HARRISON RADIATOR DIVISION - GMC

Figure A-24. 18 Fins/in., Core Depth 3 in., Oil Cooler Performance, II

AMCP 708-361

OIL-TO-AIR HEAT EXCHANGER—SQUARE FOOT FACE AREA
 AIR FIN HEIGHT 0.375 in. CORE DEPTH 4.5 in.
 OIL FIN HEIGHT 0.125 in. FINS/INCH 11
 PLATE THICKNESS 0.021 in.
 OIL SIDE FINS LOW/MODERATE PRESSURE LOSS
 INLET CONDITIONS AIR AT 100°F
 SAE 30 OIL AT 225°F

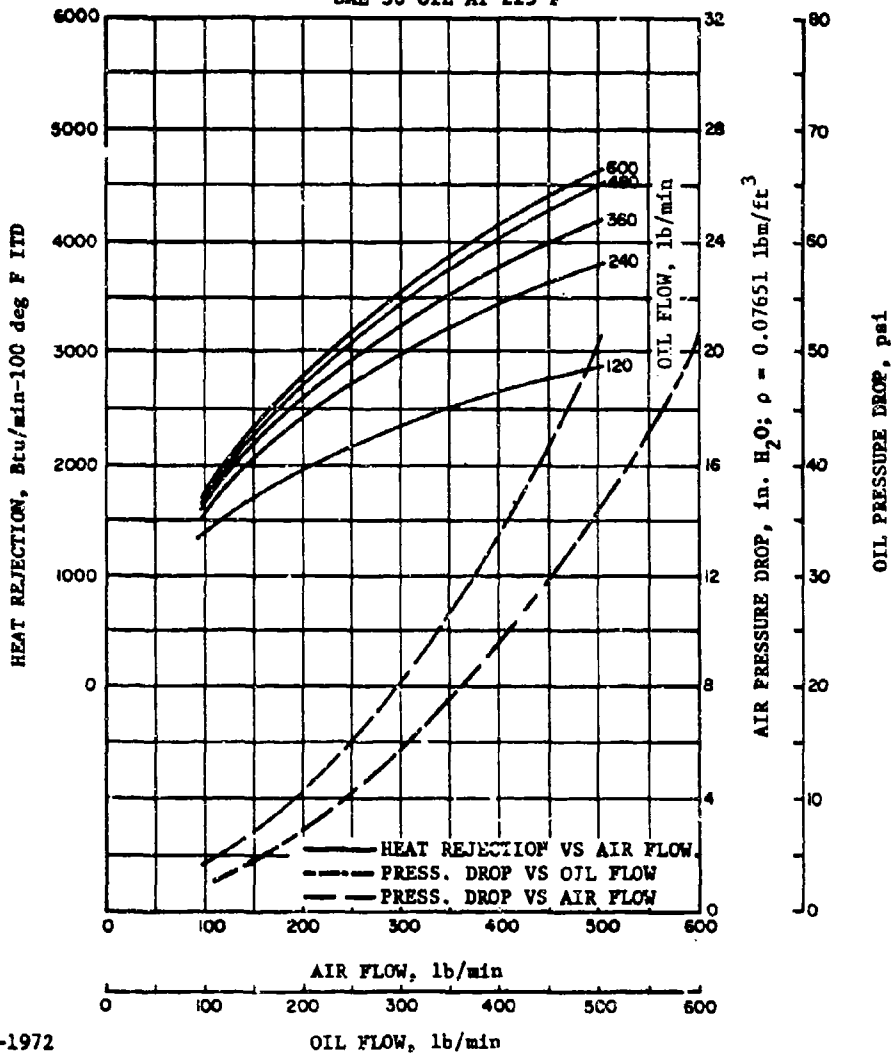

8-31-1972

Courtesy of HARRISON RADIATOR DIVISION - GMC

Figure A-25. 11 Fins/in., Core Depth 4.5 in., Oil Cooler Performance, 11

OIL-TO-AIR HEAT EXCHANGER--SQUARE FOOT FACE AREA
 AIR FIN HEIGHT 0.375 in. CORE DEPTH 4.5 in.
 OIL FIN HEIGHT 0.125 in. FINS/INCH 12.5
 PLATE THICKNESS 0.021 in.
 OIL SIDE FINS LOW/MODERATE PRESSURE LOSS
 INLET CONDITIONS AIR AT 100°F
 S.E 30 OIL AT 225°F

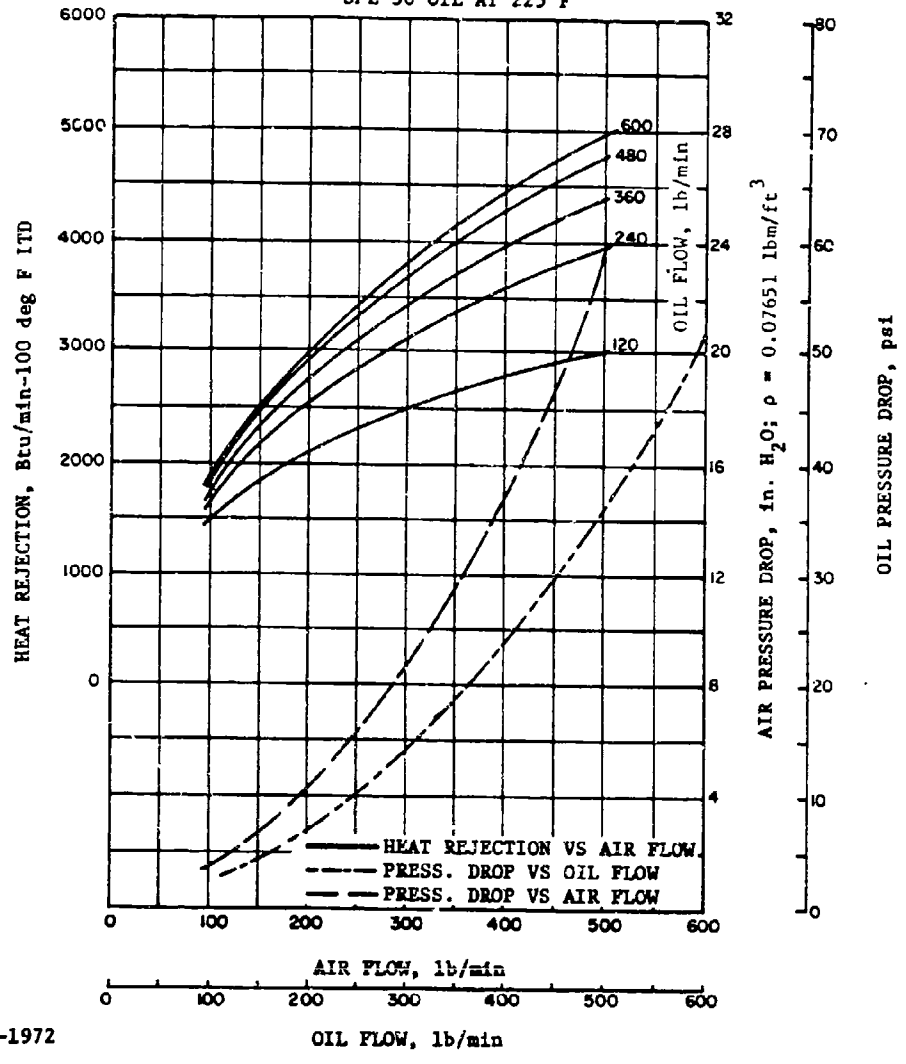

8-31-1972

Courtesy of HARRISON RADIATOR DIVISION - GMC

Figure A-26. 12.5 Fins/in., Core Depth 4.5 in., Oil Cooler Performance, II

AMCP 706-361

OIL-TO-AIR HEAT EXCHANGER--SQUARE FOOT FACE AREA
 AIR FIN HEIGHT 0.375 in. CORE DEPTH 4.5 in.
 OIL FIN HEIGHT 0.125 in. FINS/INCH 14
 PLATE THICKNESS 0.021 in.
 OIL SIDE FINS LOW/MODERATE PRESSURE LOSS
 INLET CONDITIONS AIR AT 100°F
 SAE 30 OIL AT 225°F

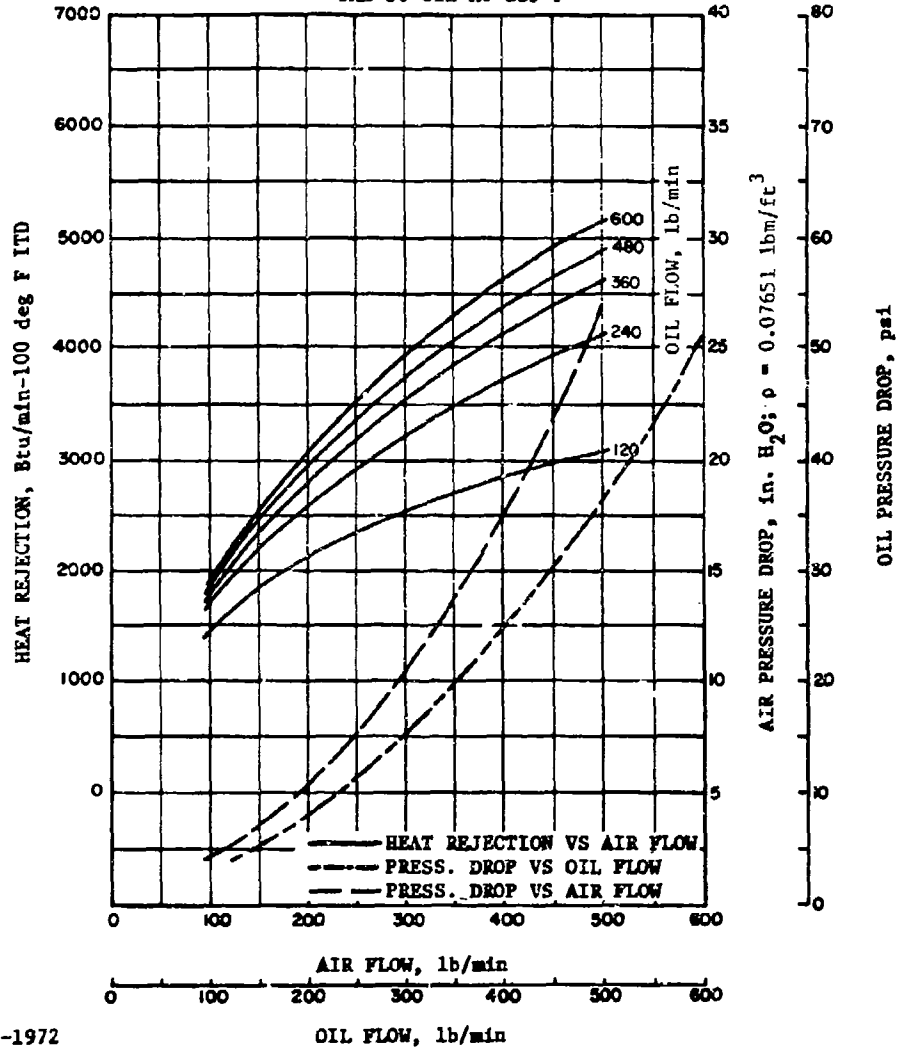

8-31-1972

Courtesy of HARRISON RADIATOR DIVISION - GMC

Figure A-27. 14 Fins/in., Core Depth 4.5 in., Oil Cooler Performance, II

OIL-TO-AIR HEAT EXCHANGER—SQUARE FOOT FACE AREA
 AIR FIN HEIGHT 0.375 in. CORE DEPTH 4.5 in.
 OIL FIN HEIGHT 0.125 in. FINS/INCH 18
 PLATE THICKNESS 0.021 in.
 OIL SIDE FINS LOW/MODERATE PRESSURE LOSS
 INLET CONDITIONS AIR AT 100°F
 SAE 30 OIL AT 225°F

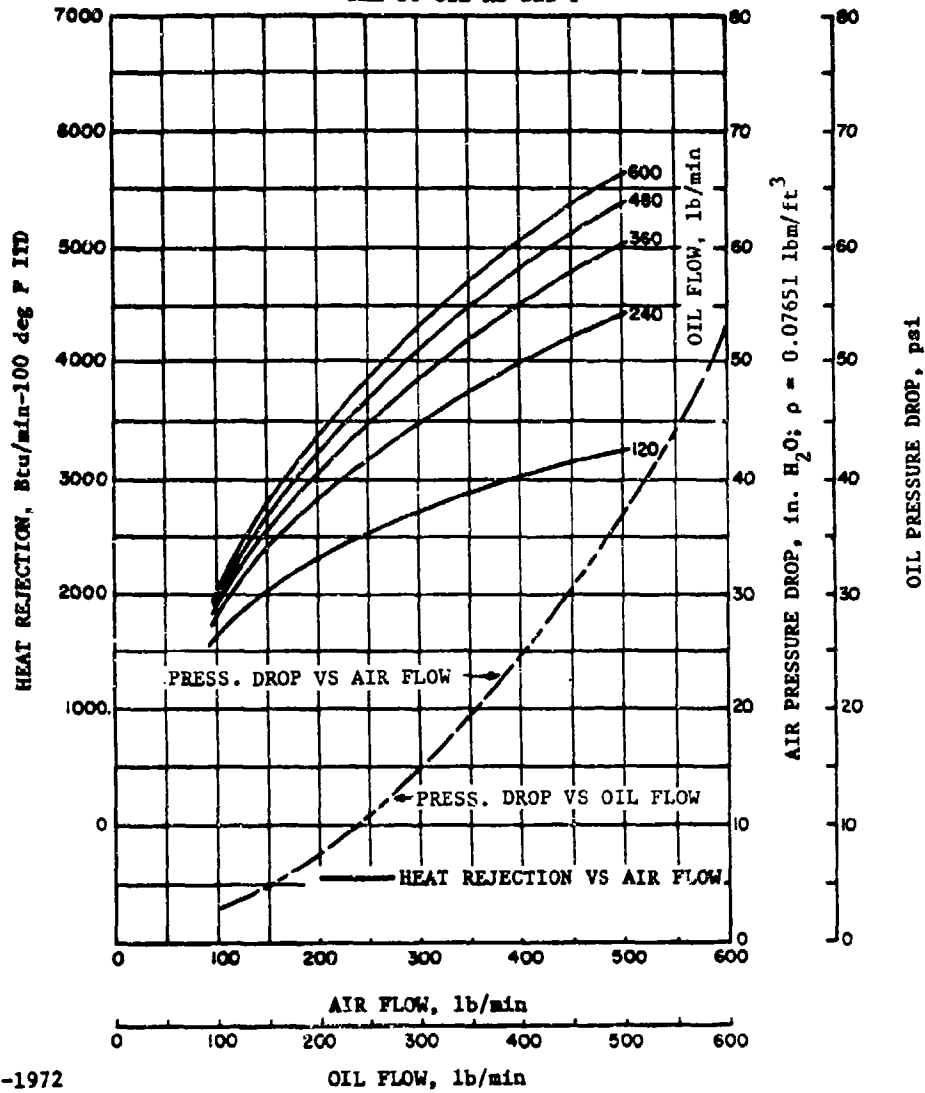

8-31-1972

Courtesy of HARRISON RADIATOR DIVISION - GMC

Figure A-28. 18 Fins/in., Core Depth 4.5 in., Oil Cooler Performance, II

AMCP 706-281

OIL-TO-AIR HEAT EXCHANGER--SQUARE FOOT FACE AREA
 AIR FIN HEIGHT 0.375 in. CORE DEPTH 6.0 in.
 OIL FIN HEIGHT 0.125 in. FINS/INCH 11
 PLATE THICKNESS 0.021 in.
 OIL SIDE FINS LOW/MODERATE PRESSURE LOSS
 INLET CONDITIONS AIR AT 100°F
 SAE 30 OIL AT 225°F

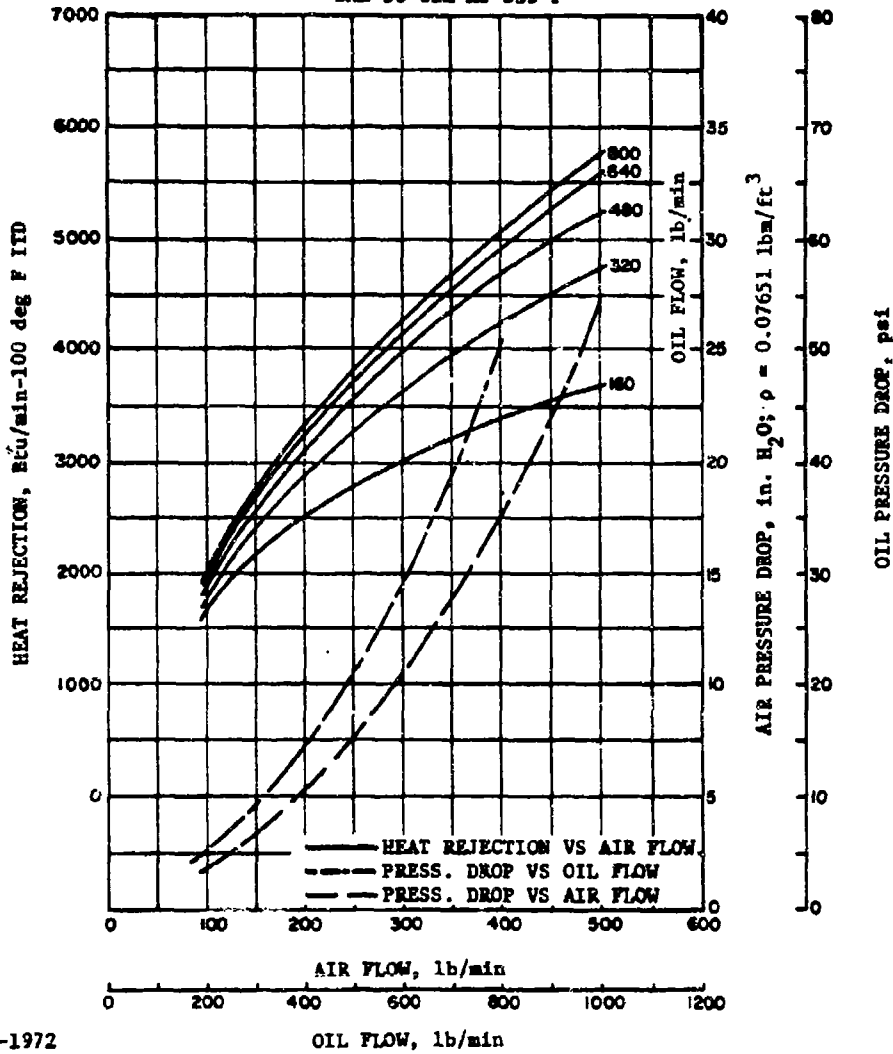

8-31-1972

Courtesy of HARRISON RADIATOR DIVISION - GMC

Figure A-29. 11 Fins/in., Core Depth 6 in., Oil Cooler Performance, II

OIL-TO-AIR HEAT EXCHANGER--SQUARE FOOT FACE AREA
 AIR FIN HEIGHT 0.375 in. CORE DEPTH 6.0 in.
 OIL FIN HEIGHT 0.125 in. FINS/INCH 12.5
 PLATE THICKNESS 0.021 in.
 OIL SIDE FINS LOW/MODERATE PRESSURE LOSS
 INLET CONDITIONS AIR AT 100°F
 SAE 30 OIL AT 225°F

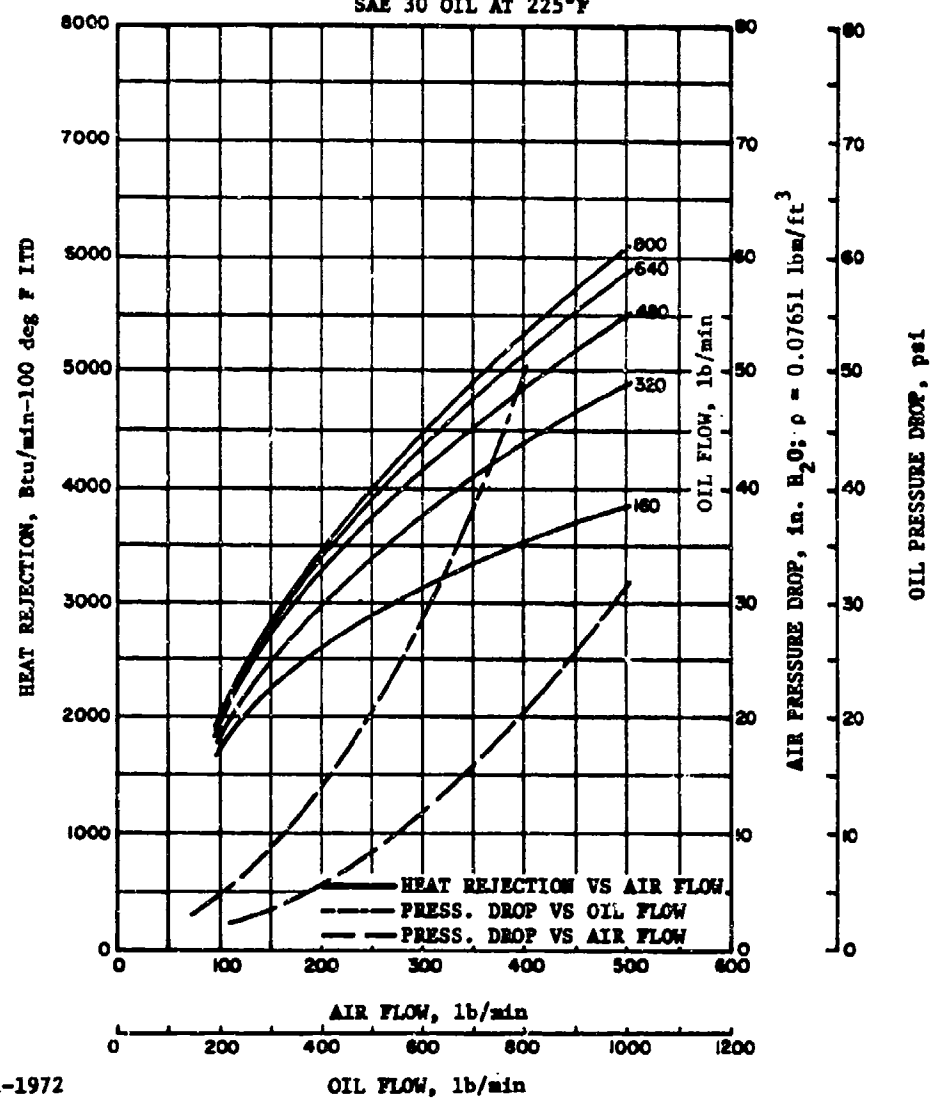

8-31-1972

Courtesy of HARRISON RADIATOR DIVISION - GMC

Figure A-30. 12.5 Fins/in., Core Depth 6 in., Oil Cooler Performance, II

AMCP 708-381

OIL-TO-AIR HEAT EXCHANGER—SQUARE FOOT FACE AREA
 AIR FIN HEIGHT 0.375 in. CORE DEPTH 6.0 in.
 OIL FIN HEIGHT 0.125 in. FINS/INCH 14
 PLATE THICKNESS 0.021 in.
 OIL SIDE FINS LOW/MODERATE PRESSURE LOSS
 INLET CONDITIONS AIR AT 100°F
 SAE 30 OIL AT 225°F

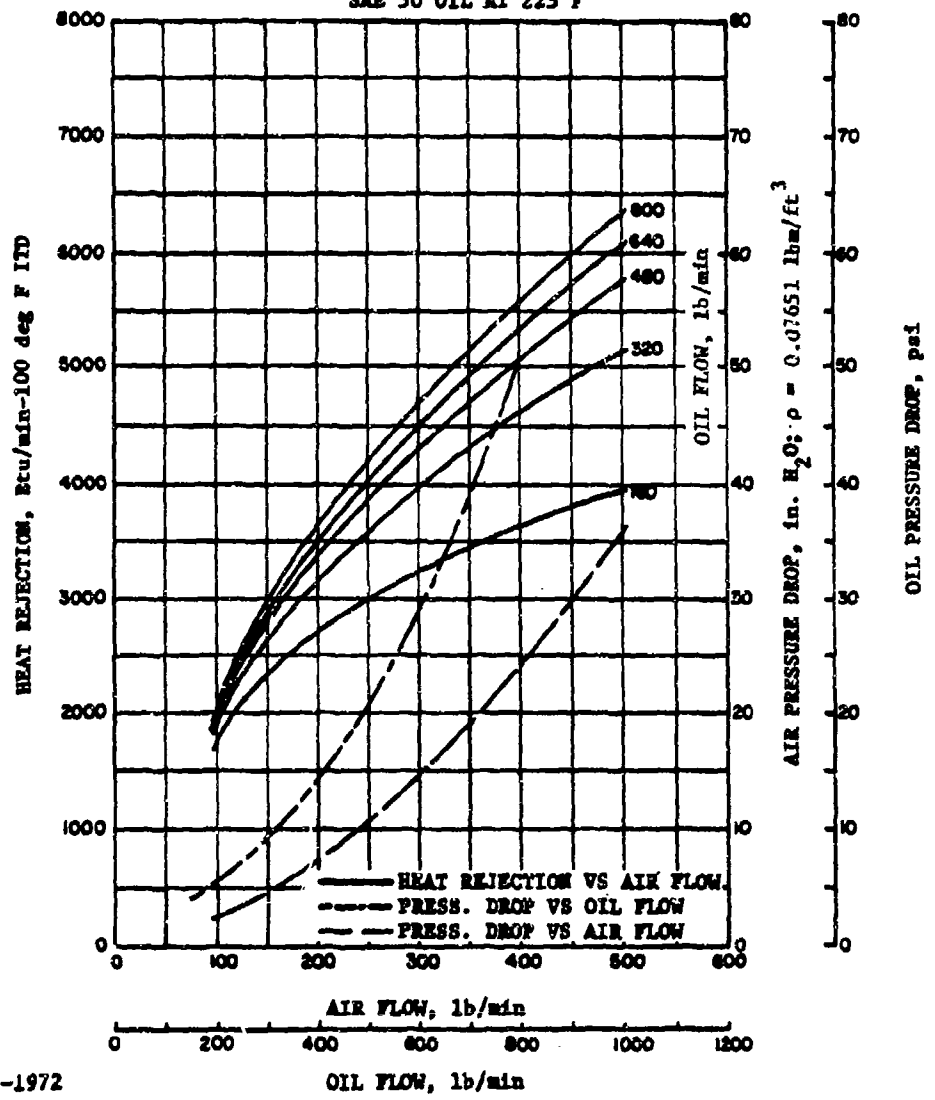

OIL-TO-AIR HEAT EXCHANGER--SQUARE FOOT FACE AREA
 AIR FIN HEIGHT 0.375 in. CORE DEPTH 6.0 in.
 OIL FIN HEIGHT 0.125 in. FINS/INCH 18
 PLATE THICKNESS 0.021 in.
 OIL SIDE FINS LOW/MODERATE PRESSURE LOSS
 INLET CONDITIONS AIR AT 100°F
 SAE 30 OIL AT 225°F

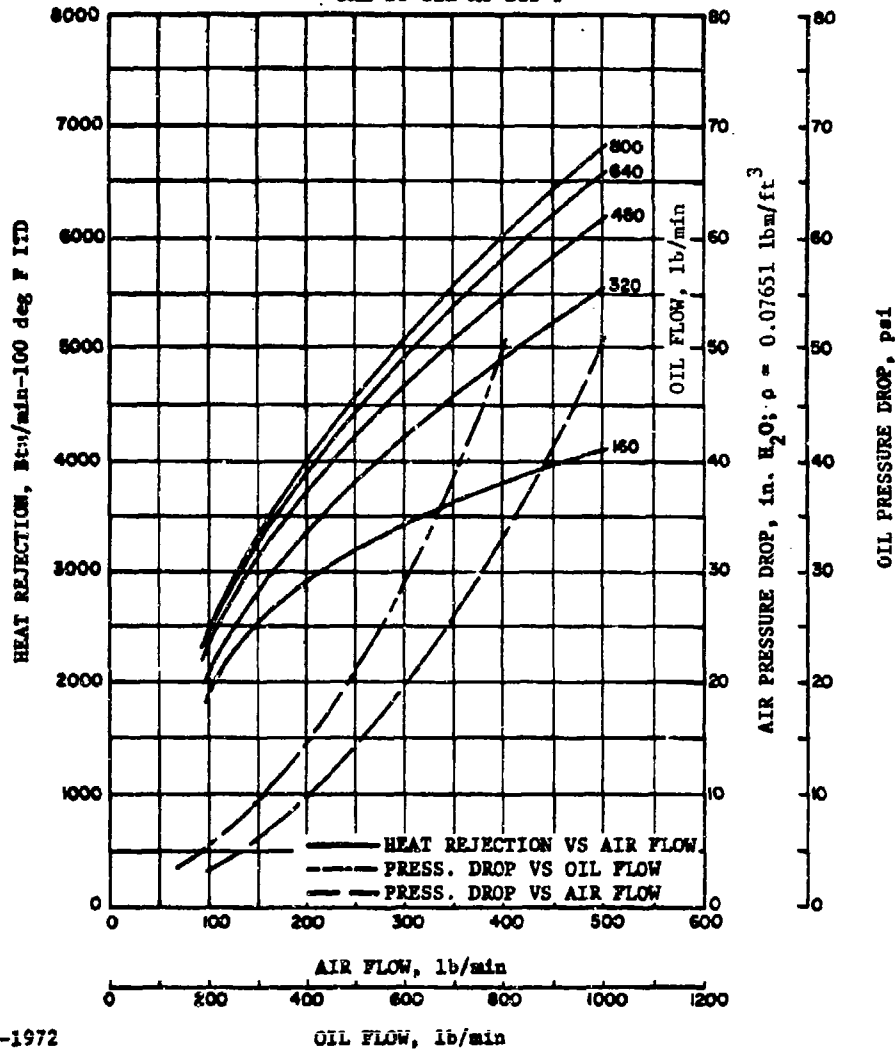

8-31-1972

Courtesy of HARRISON RADIATOR DIVISION - GMC

Figure A-32. 18 Fins/in., Core Depth 6 in., Oil Cooler Performance, II

AMCP 706-281

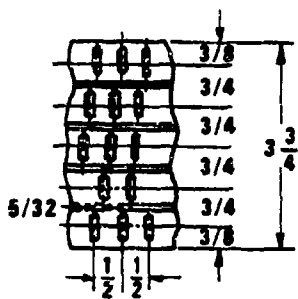

(A) RADIATOR CORE TYPE 1

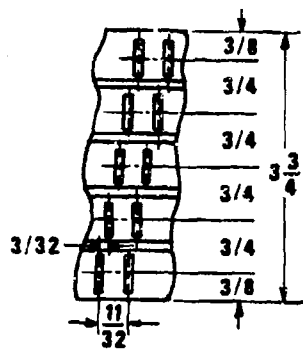

(C) RADIATOR CORE TYPE 5

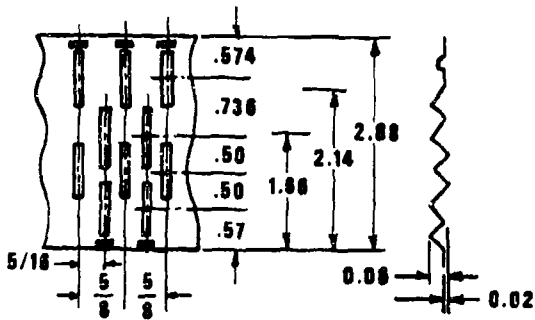

(B) RADIATOR CORE TYPE 4

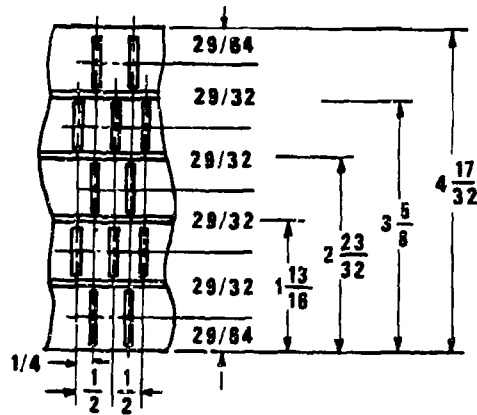

(D) RADIATOR CORE TYPE 6

Figure A-33. Typical Radiator Core Tube Arrangements
 (Courtesy of McCord Corporation)

A-2 TYPICAL RADIATOR CORE PERFORMANCE—FIN AND TUBE CORE¹

Typical radiator core arrangements (Fig. A-33) and performance characteristics (Figs. A-34 through A-37)¹ are presented to serve as a reference for the designer in selecting existing core designs. The data presented are intended to be representative of data supplied by the radiator manufacturers. Specific

¹Courtesy of McCord Corporation

performance charts should be obtained for each particular heat exchanger application.

The variation in heat transfer capacity due to water flow applicable to Figs. A-34 through A-37 is shown on the chart Fig. A-38.

Performance charts for another series of core configuration² are shown in Figs. A-39, A-40, and A-41.

²Courtesy of Young Radiator Company

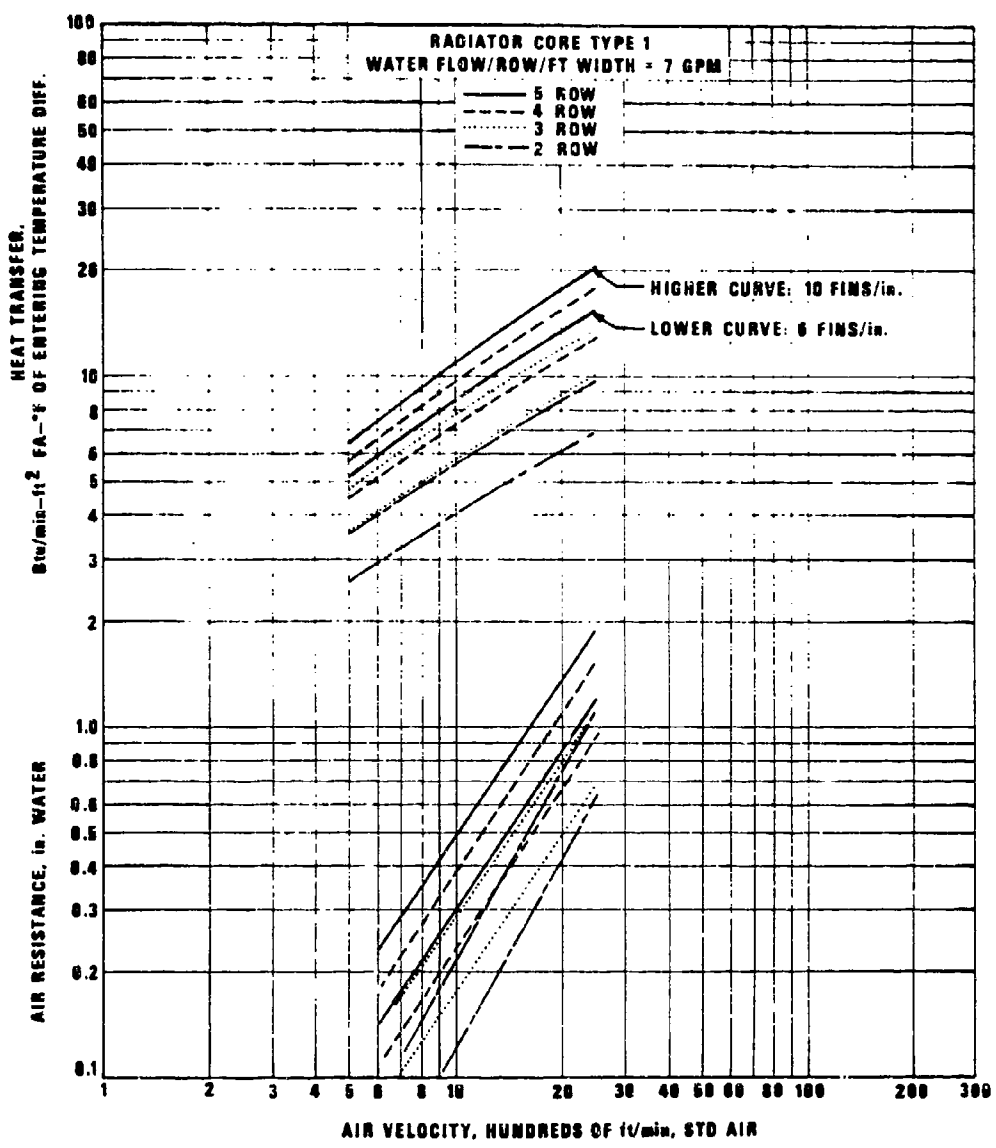

Figure A-34. Type 1 Radiator Core Performance
 (Courtesy of McCord Corporation)

AMCP 706-361

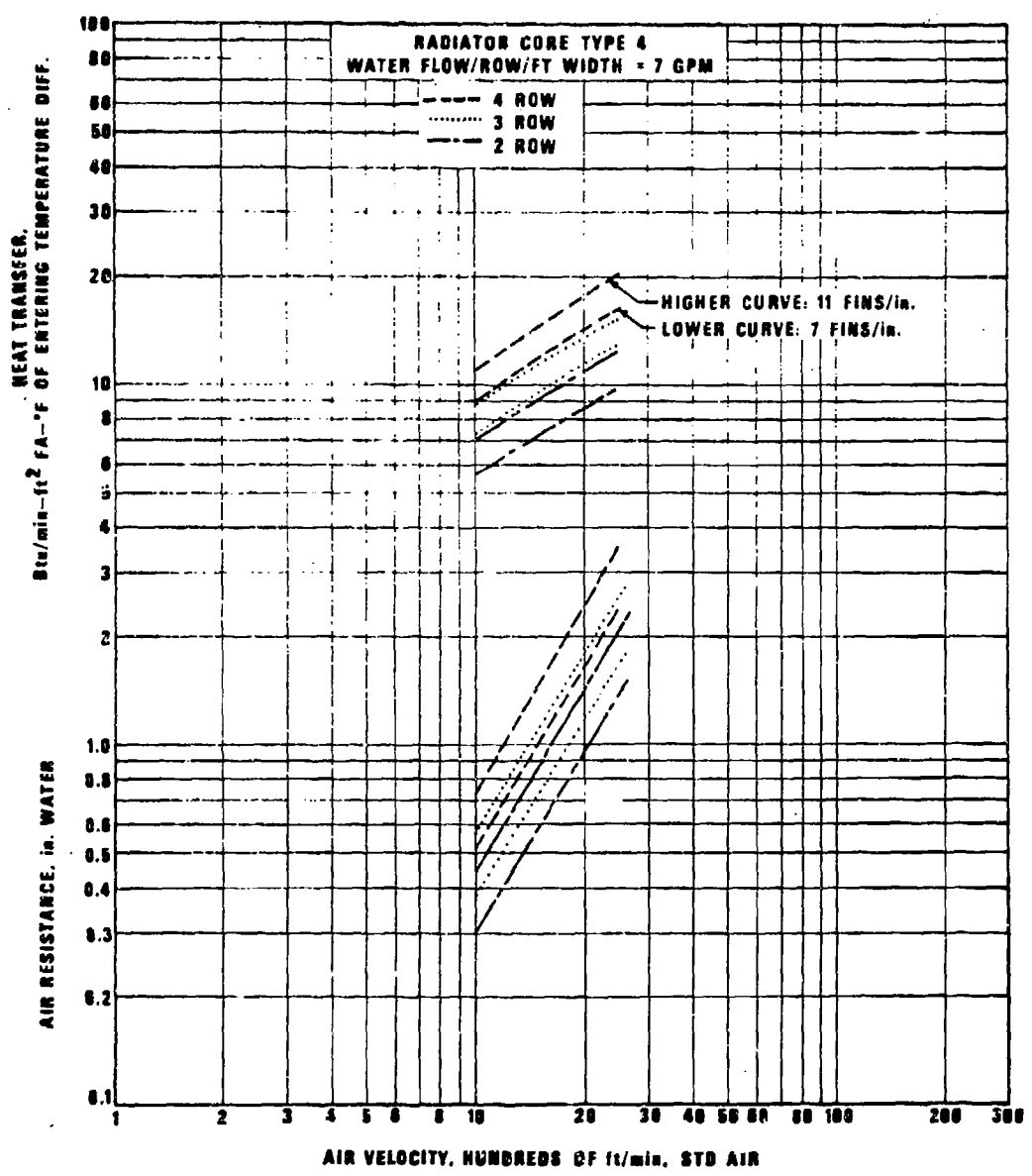

Figure A-35. Type 4 Radiator Core Performance
 (Courtesy of McCord Corporation)

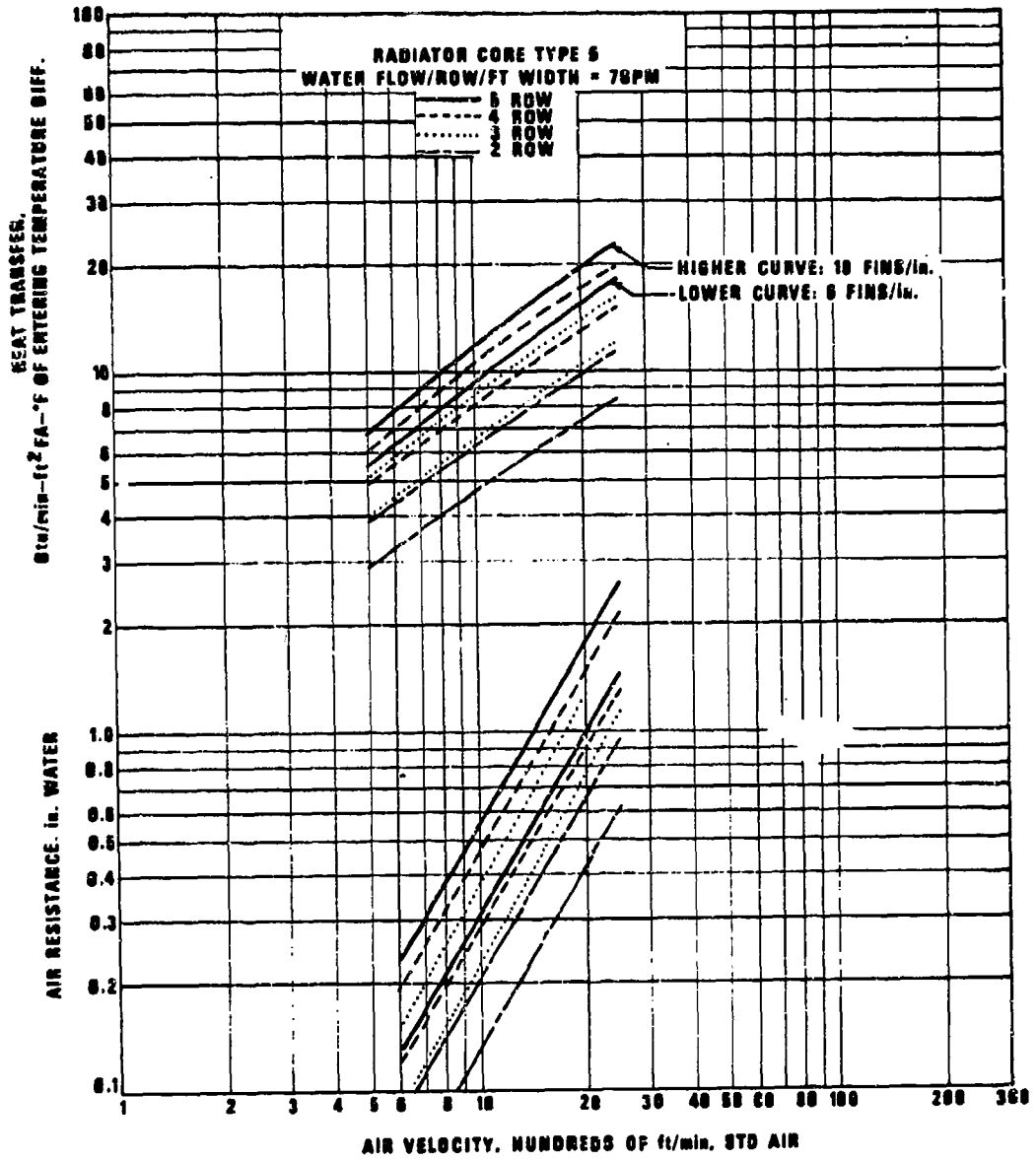

Figure A-36. Type 5 Radiator Core Performance
 (Courtesy of McCord Corporation)

AMCP 706-361

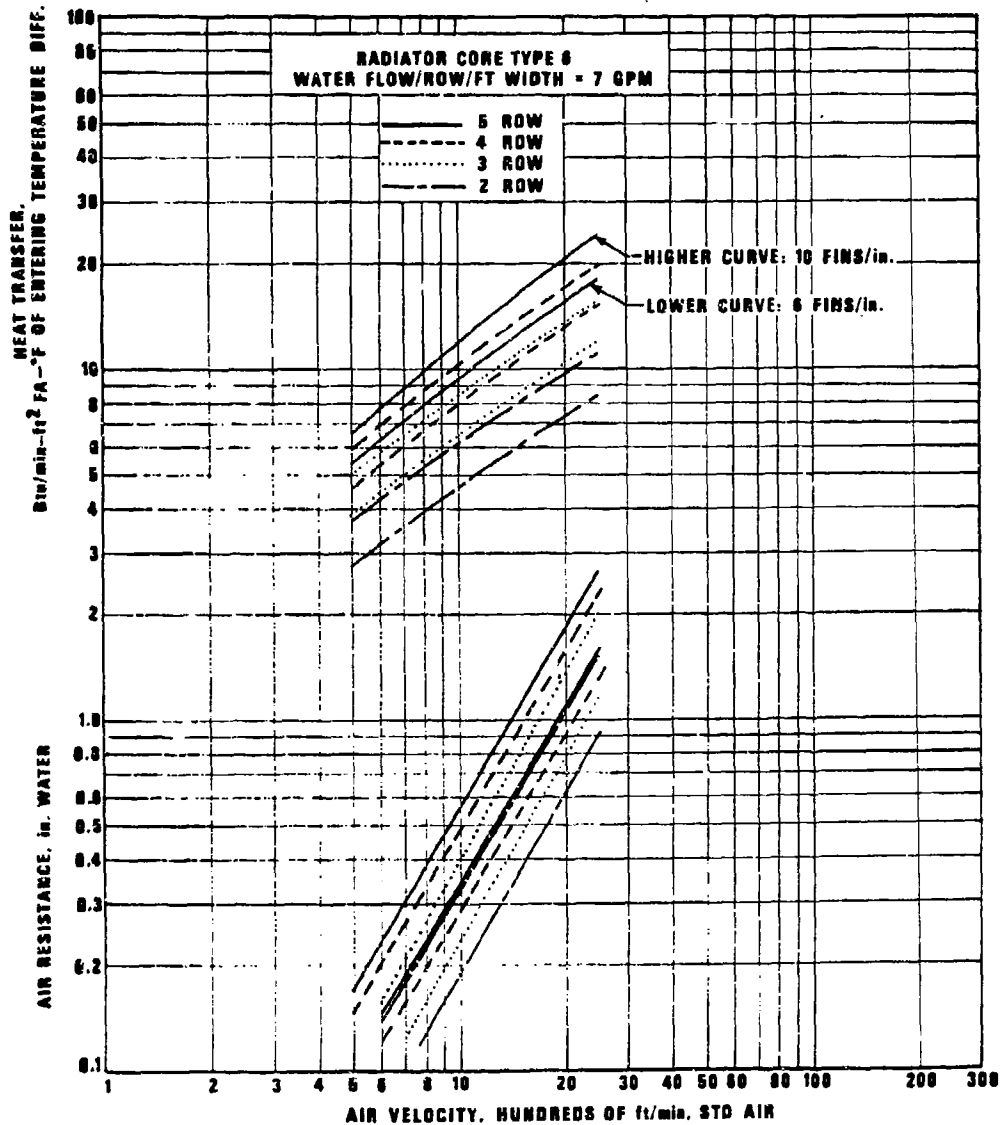

Figure A-37. Type 6 Radiator Core Performance
 (Courtesy of McCord Corporation)

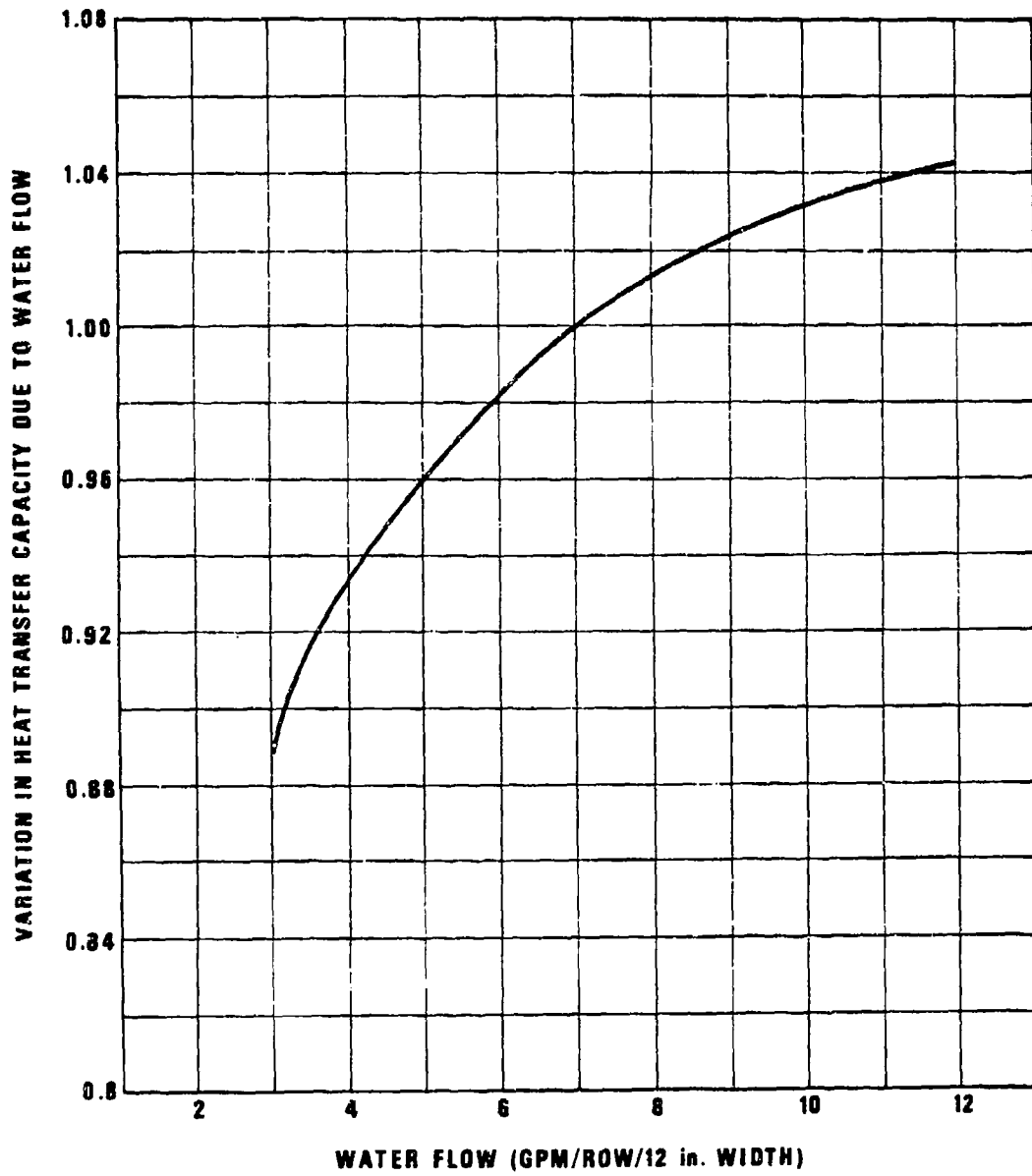

Figure A-38. Variation in Heat Transfer Capacity Due to Water Flow
(Courtesy of McCord Corporation)

AMCP 706-381

5-5/16 in. DEEP CORE 11 FINS/in.
HOT WATER TO AIR HEAT TRANSFER

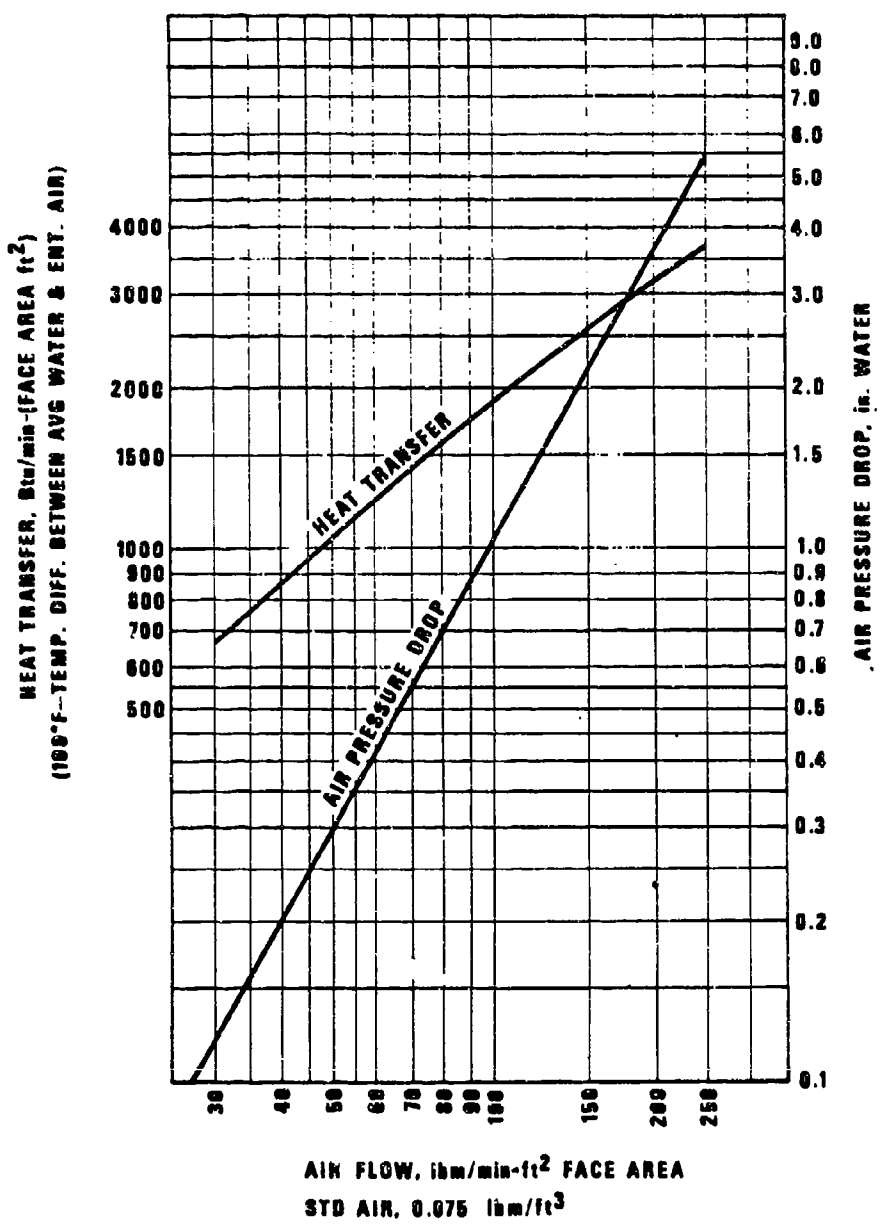

Figure A-39. 11 Fins/in. Radiator Core Performance Characteristics
 (Courtesy of Young Radiator Company)

4-7/16 in. DEEP CORE 10 FINS/in.
HOT WATER TO AIR HEAT TRANSFER

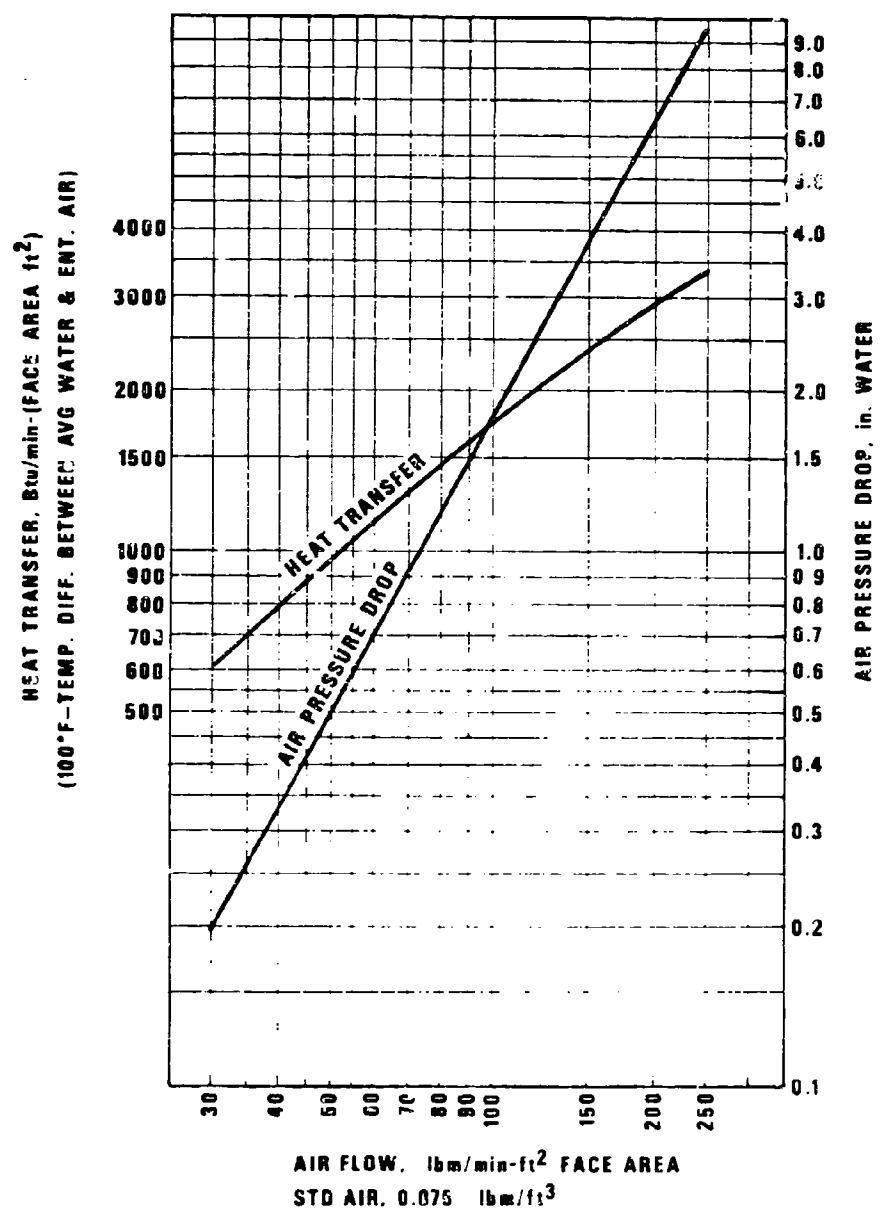

Figure A-40. 10 Fins/in. Radiator Core Performance Characteristics
 (Courtesy of Young Radiator Company)

AMCP 706-387

3 in. DEEP CORE 8 FINS/in.
HOT WATER TO AIR HEAT TRANSFER

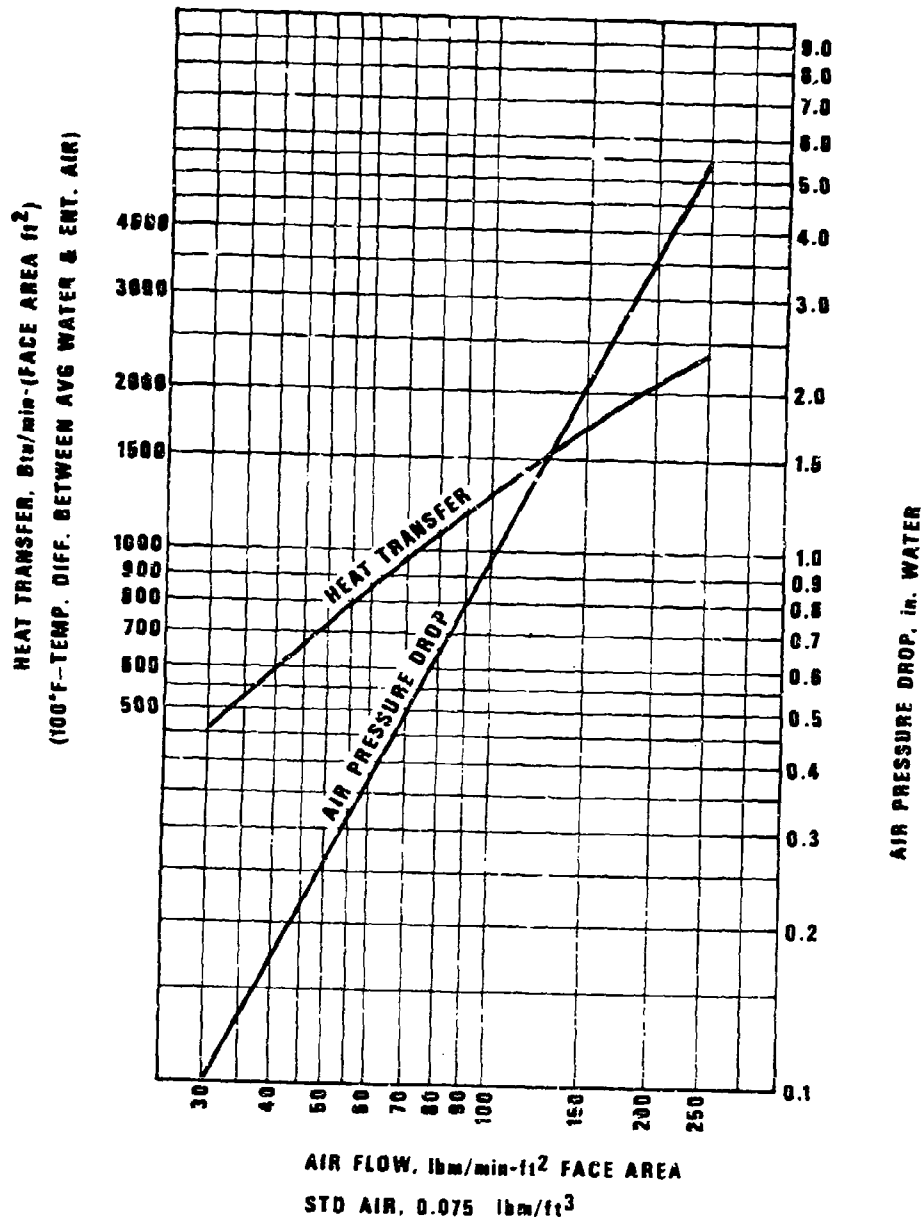

Figure A-41. 8 Fins/in. Radiator Core Performance Characteristics
 (Courtesy of Young Radiator Company)

APPENDIX B

B-1 COOLING FAN DETAILS AND PERFORMANCE CHARACTERISTICS

The physical and performance characteristics of a number of cooling fans used in contemporary military vehicles are presented to aid the cooling system designer in selecting

the best design to satisfy a particular vehicle requirement.

The data presented here are intended only to be representative of the types of fans commercially available.

The fan manufacturer should be consulted before a final fan selection is made.

AMCP 706-201

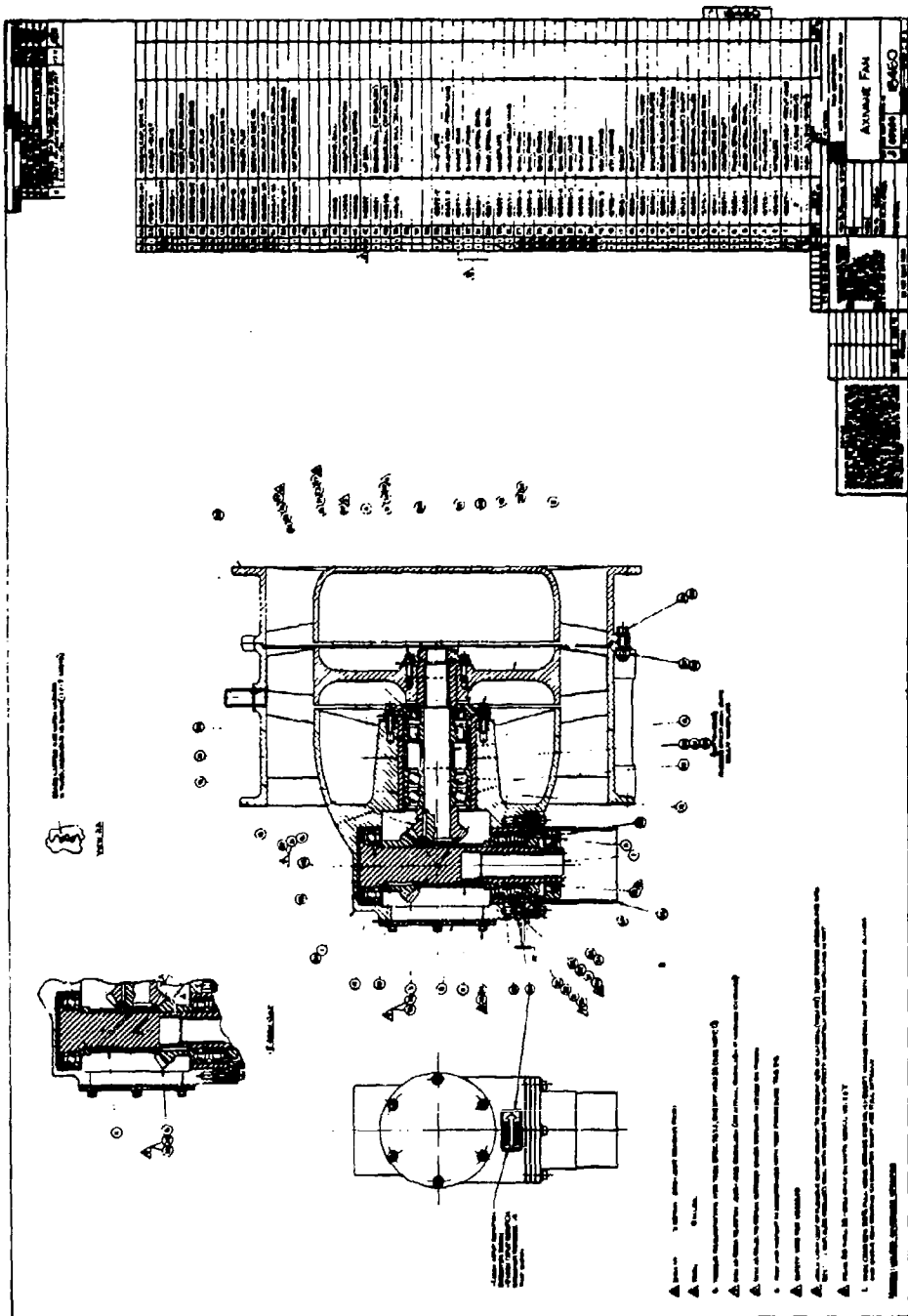

Figure B-1. Gear Box Drive Fan Drawing, 4000 cfm
 (Courtesy of Joy Manufacturing Company)

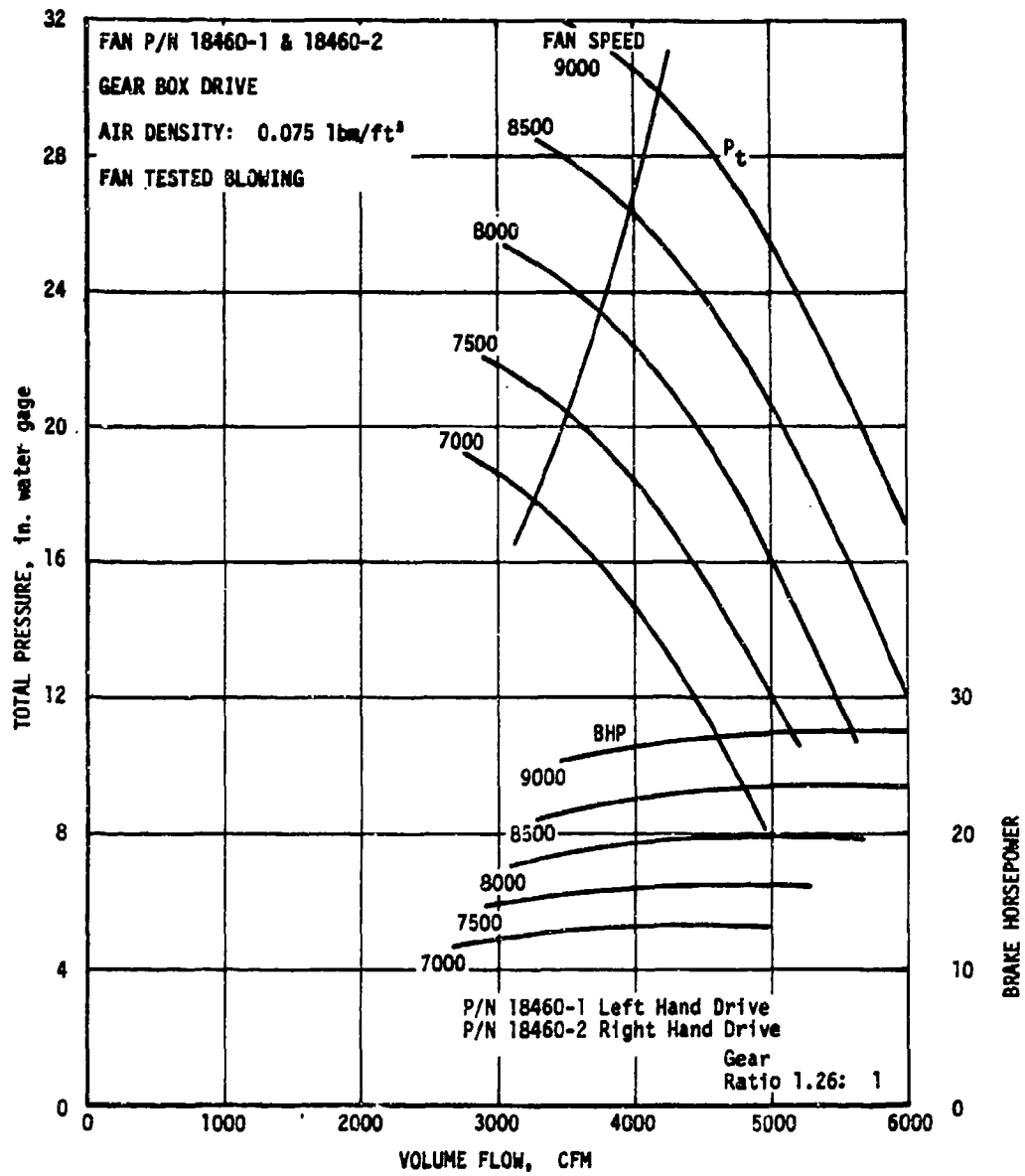

Figure B-2. Gear Box Drive Fan Performance Curve, 4000 cfm
 (Courtesy of Joy Manufacturing Company)

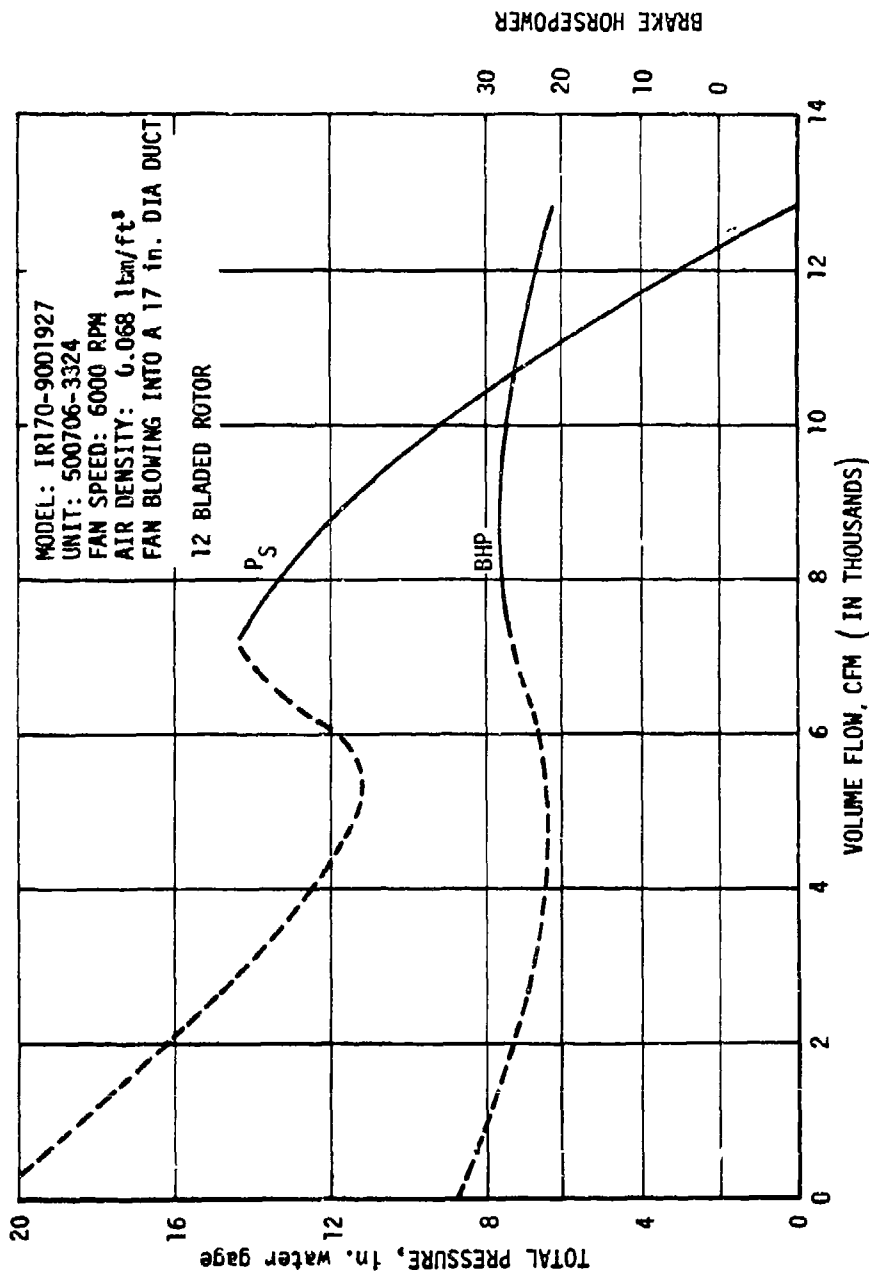

Figure B-4. Vane-axial Fan Performance Curve, 9200 cfm
(Courtesy of Joy Manufacturing Company)

AMCP 706-381

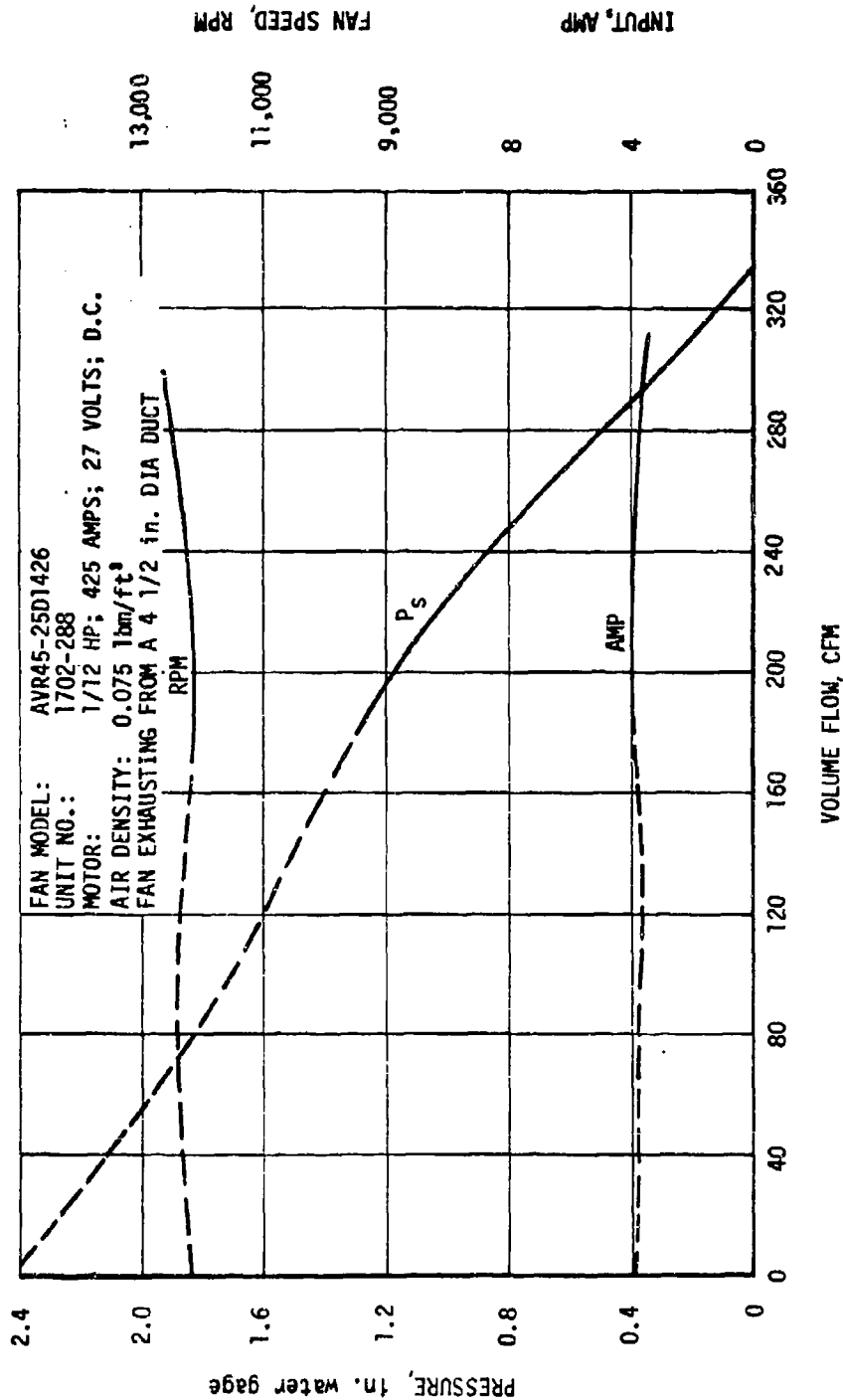

Figure B-6. Vane-axial Fan Performance Curve, 200 cfm, Electric Drive
 (Courtesy of Joy Manufacturing Company)

AMCP 706-351

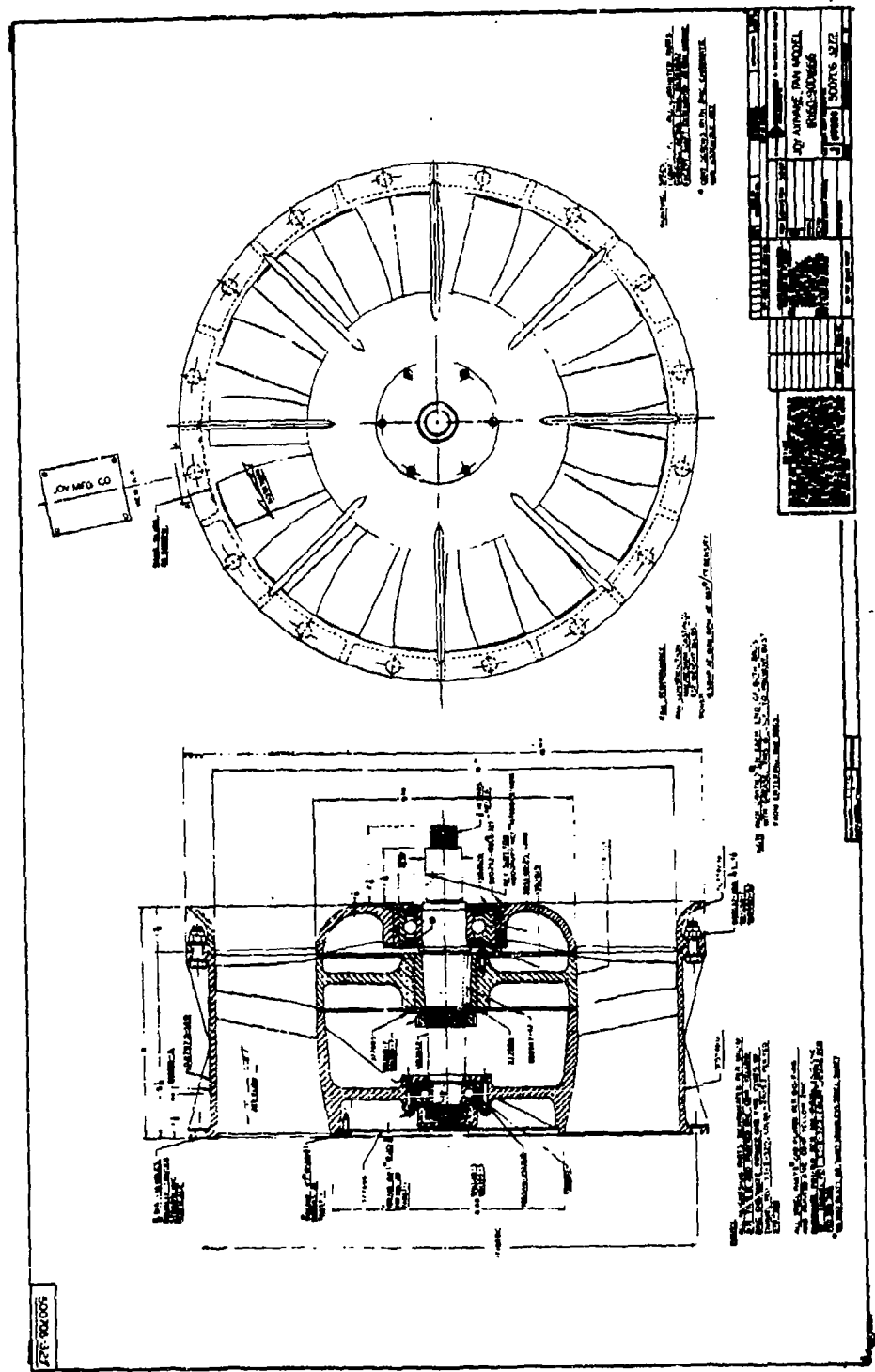

Figure B-7. Vane-axial Fan Drawing, 9000 cfm
(Courtesy of Joy Manufacturing Company)

FAN MODEL: AV160-90D1666
UNIT NO: X706-296 & 500706-327
MOTOR: 18.5 HP; 6100 RPM
AIR DENSITY: 0.067 lbm/ft³
FAN TESTED BLOWING INTO A PLENUM

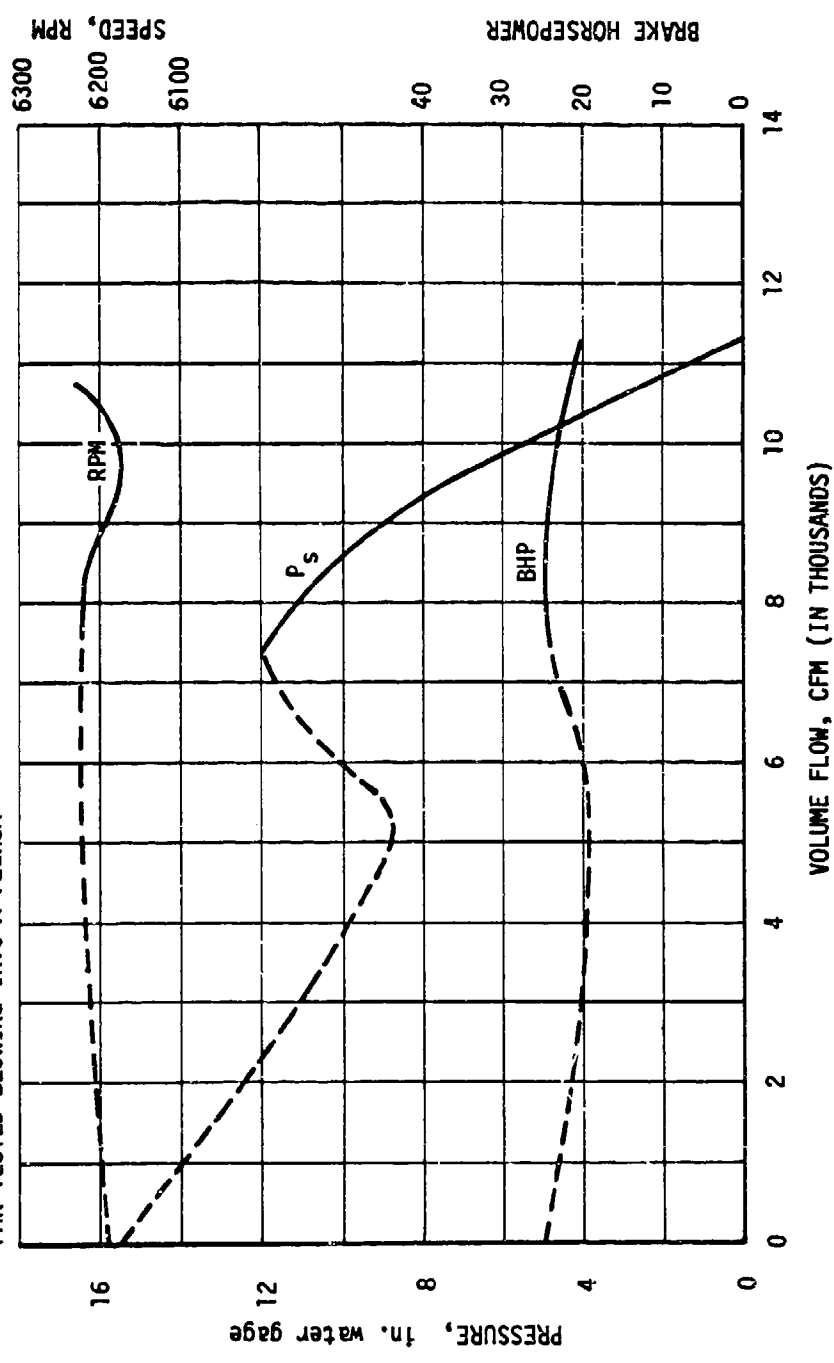

Figure B-8. Vane-axial Fan Performance Curve, 9000 cfm
(Courtesy of Joy Manufacturing Company)

AMCP 708-281

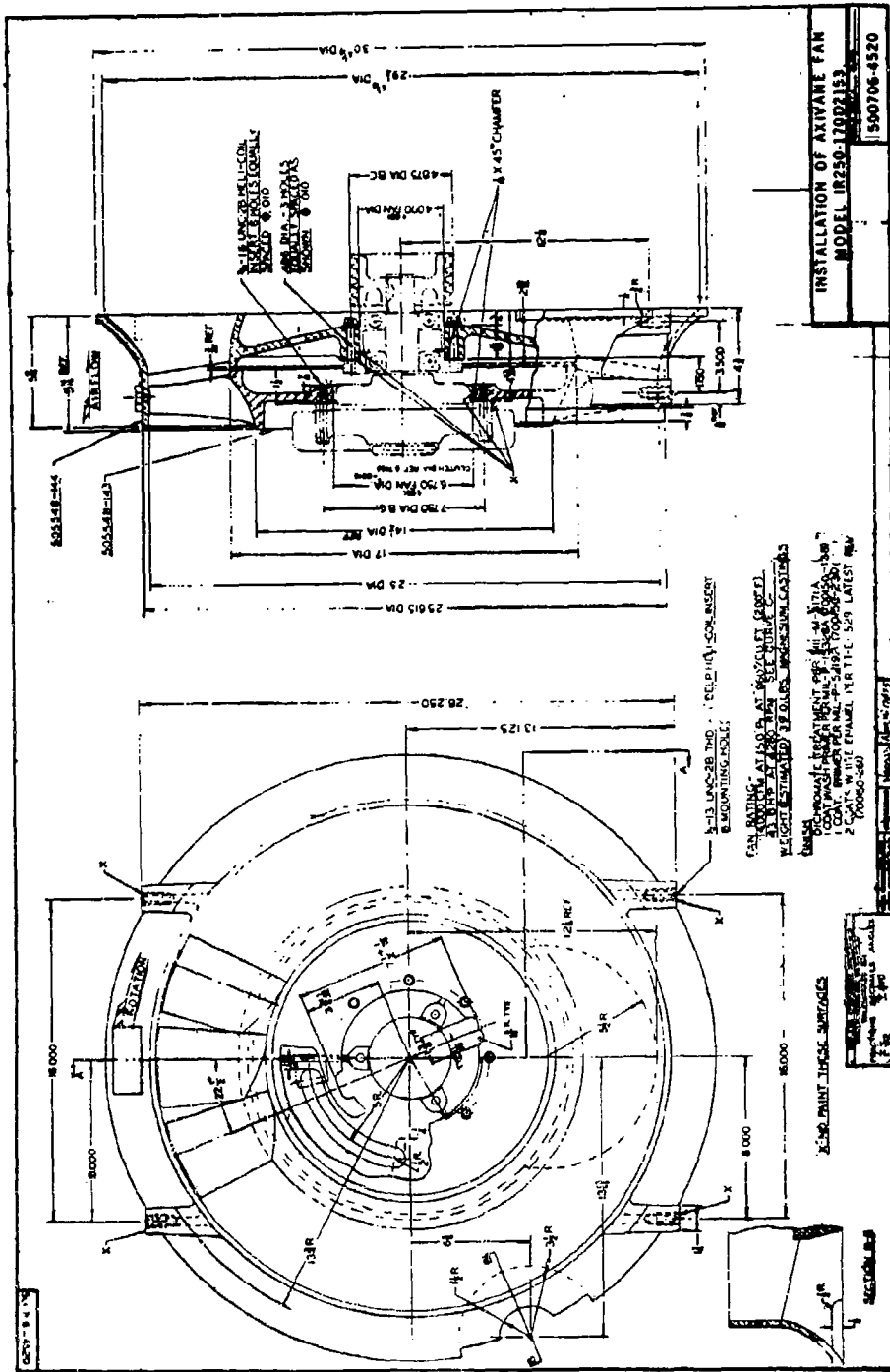

Figure B-9. Vane axial Fan Drawing, 14,000 cfm
 (Courtesy of Joy Manufacturing Company)

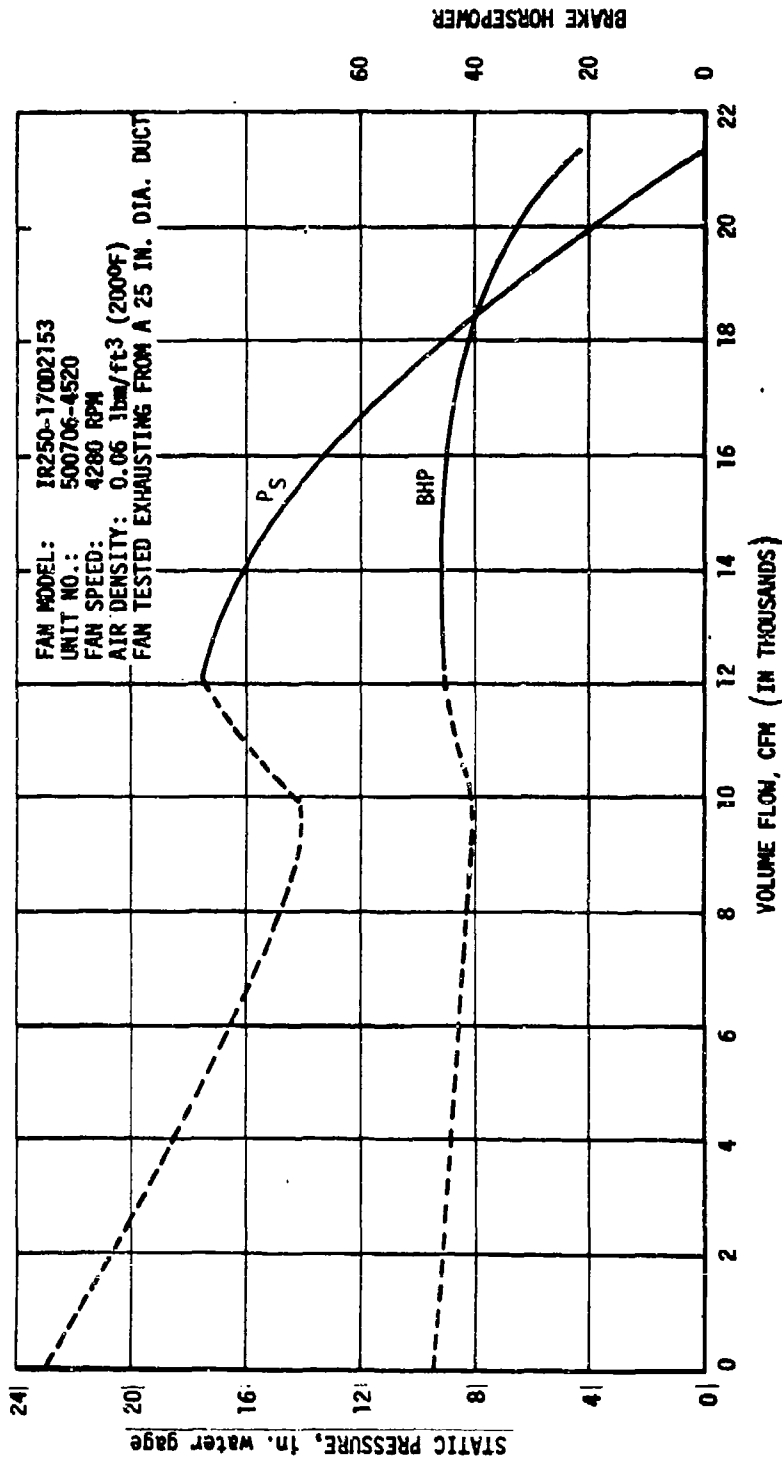

Figure B-10. Vane-axial Fan Performance Curve, 14,000 cfm
 (Courtesy of Joy Manufacturing Company)

AMCP 708-361

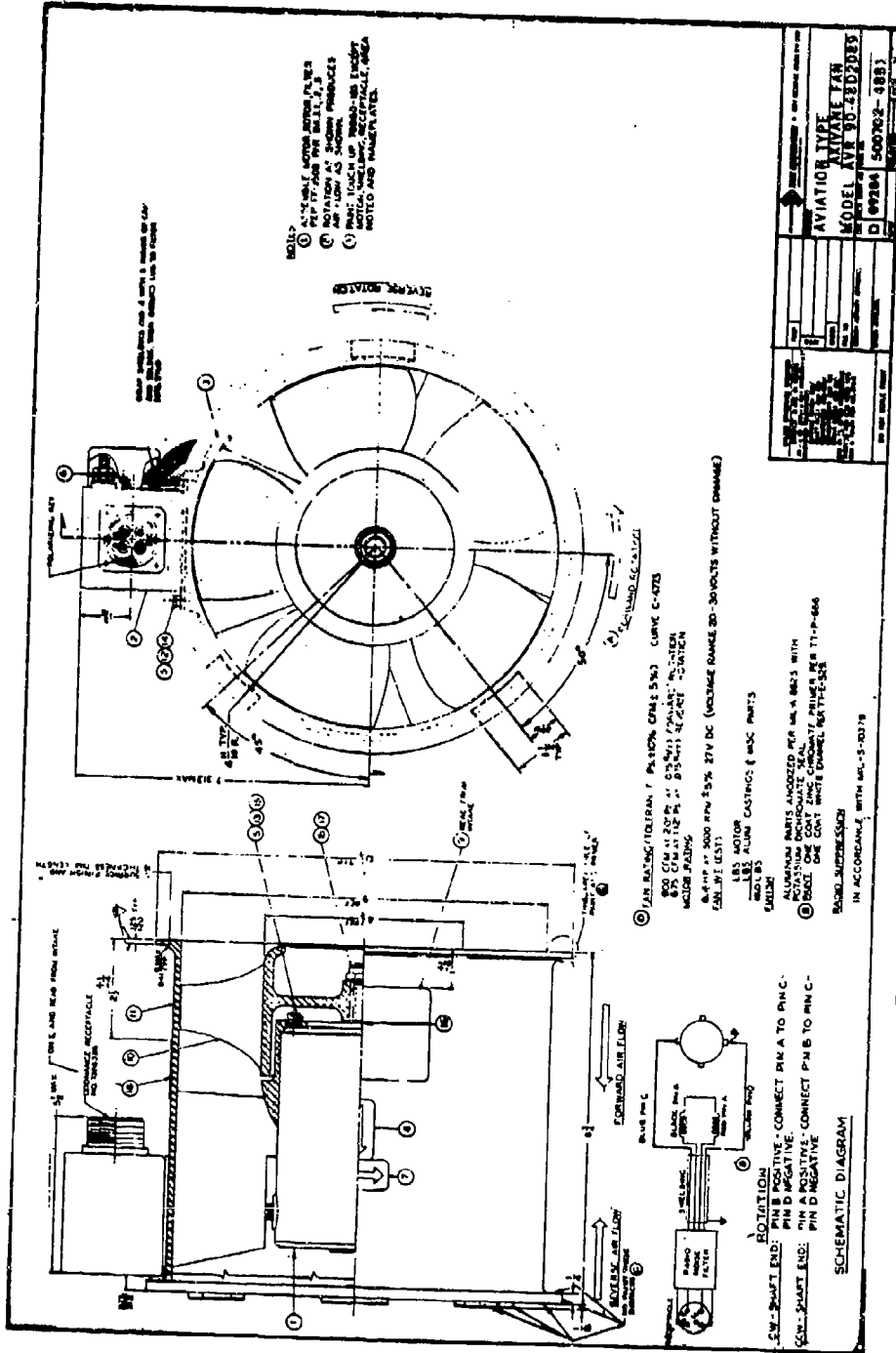

Figure B-11. Vane-axial Fan Drawing, 900 cfm, Electric Drive
 (Courtesy of Joy Manufacturing Company)

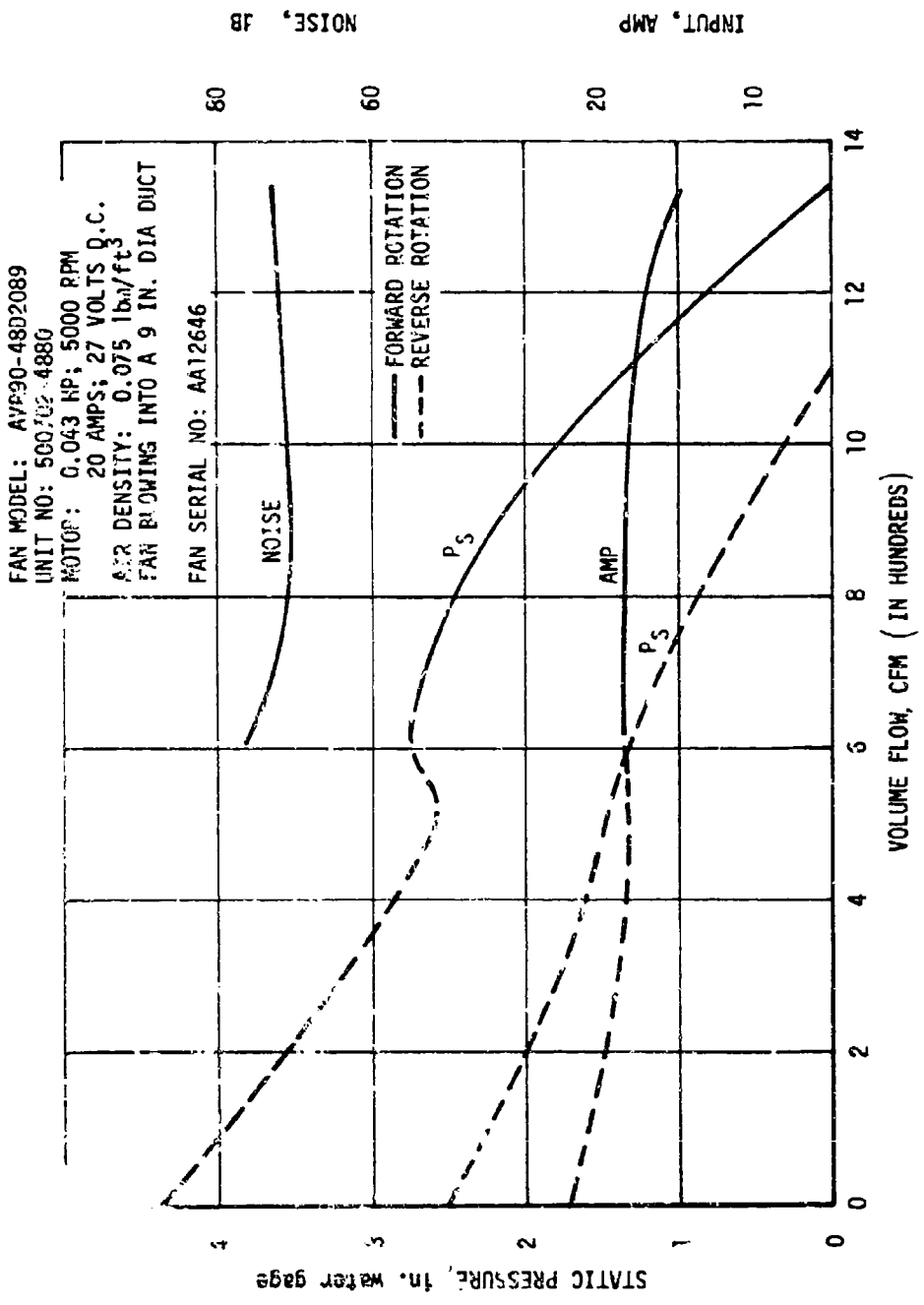

Figure B-12. Vane-axial Fan Performance Curve, 900 cfm, Electric Drive
 (Courtesy of Joy Manufacturing Company)

AMCP 708-381

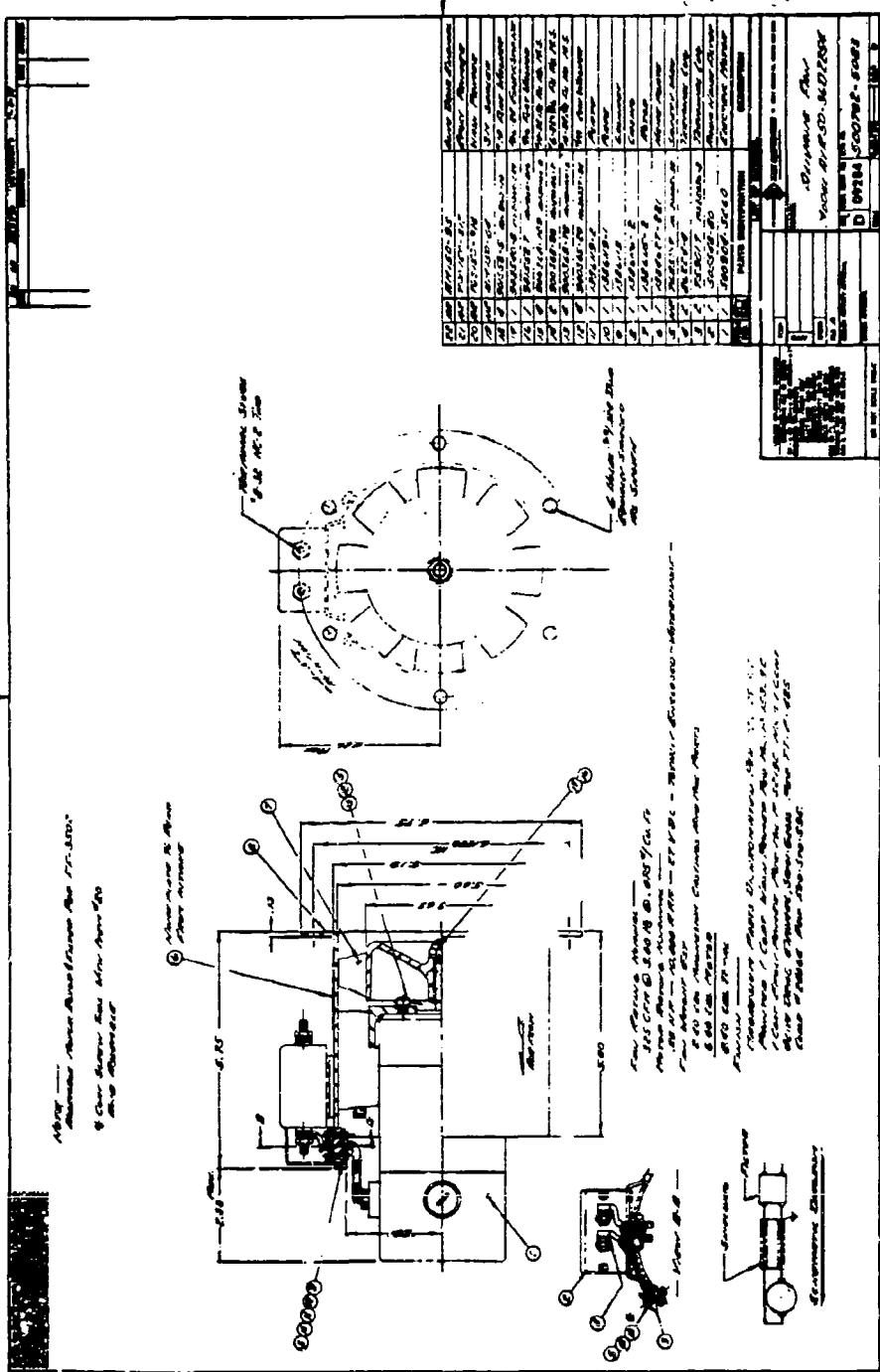

Figure B-13. Vane-axial Fan Drawing, 325 cfm, Electric Drive
 (Courtesy of Joy Manufacturing Company)

AMCP 706-361

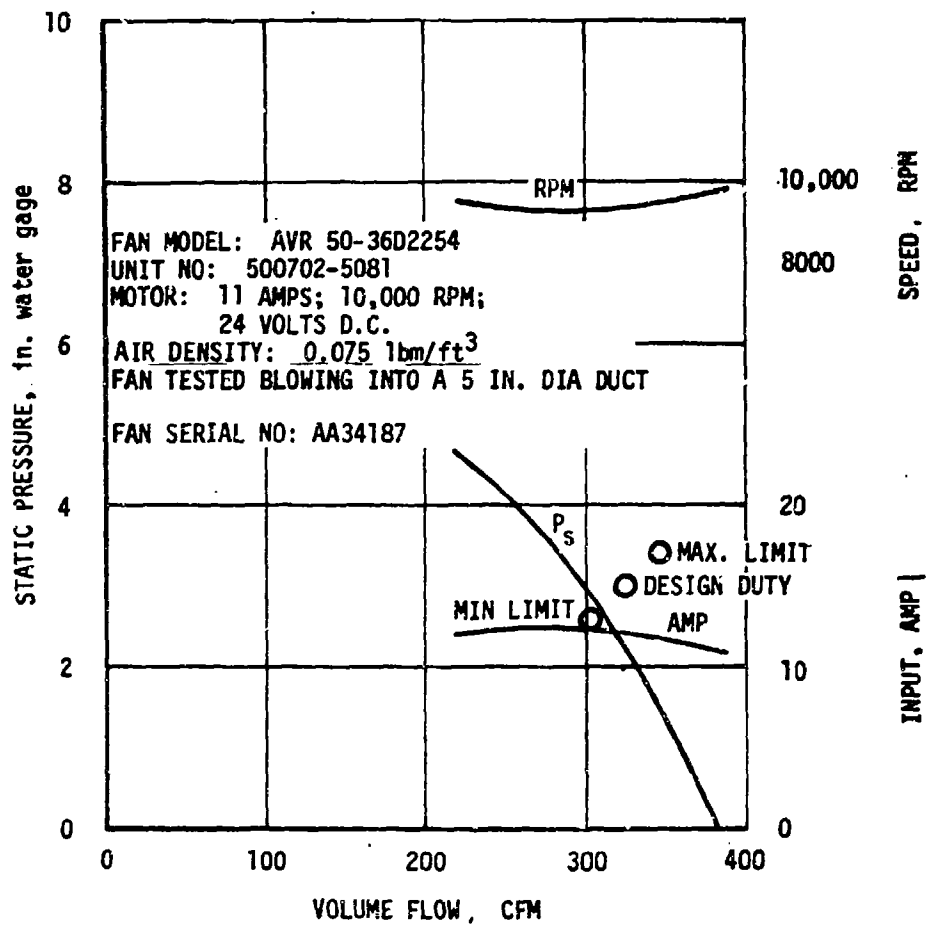

Figure B-14. Vane-axial Fan Performance Curve, 325 cfm, Electric Drive
 (Courtesy of Joy Manufacturing Company)

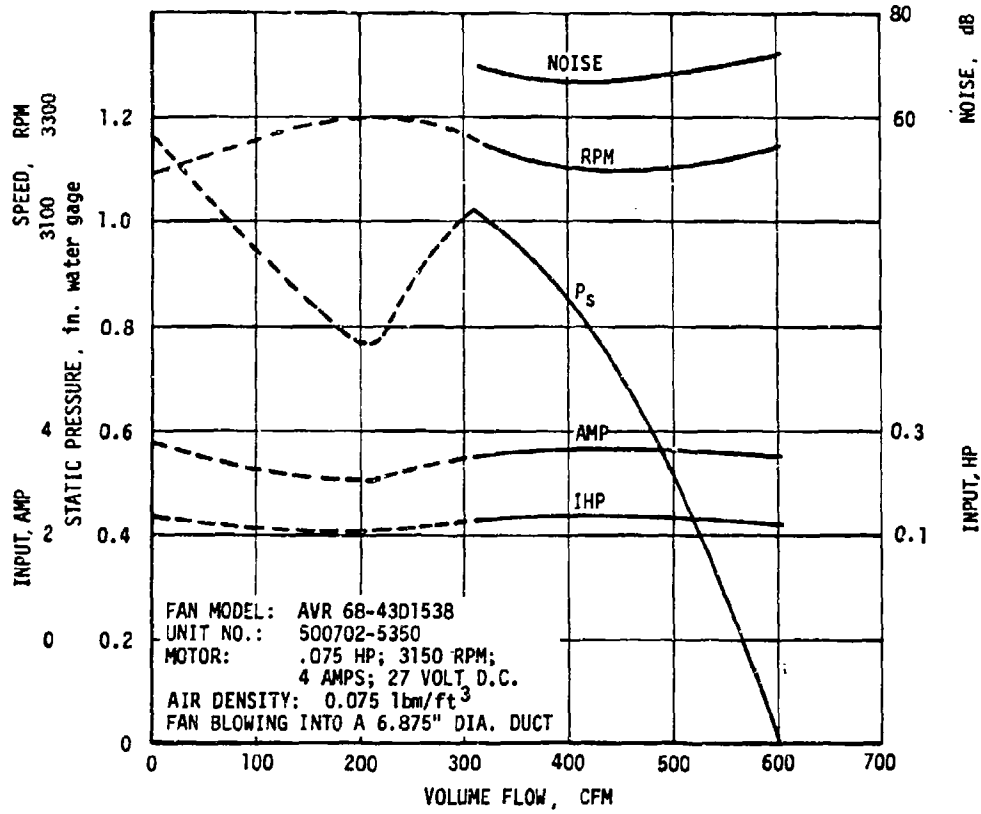

Figure B-16. Vane-axial Fan Performance Curve, 425 cfm, Electric Drive
 (Courtesy of Joy Manufacturing Company)

AMCP 795-281

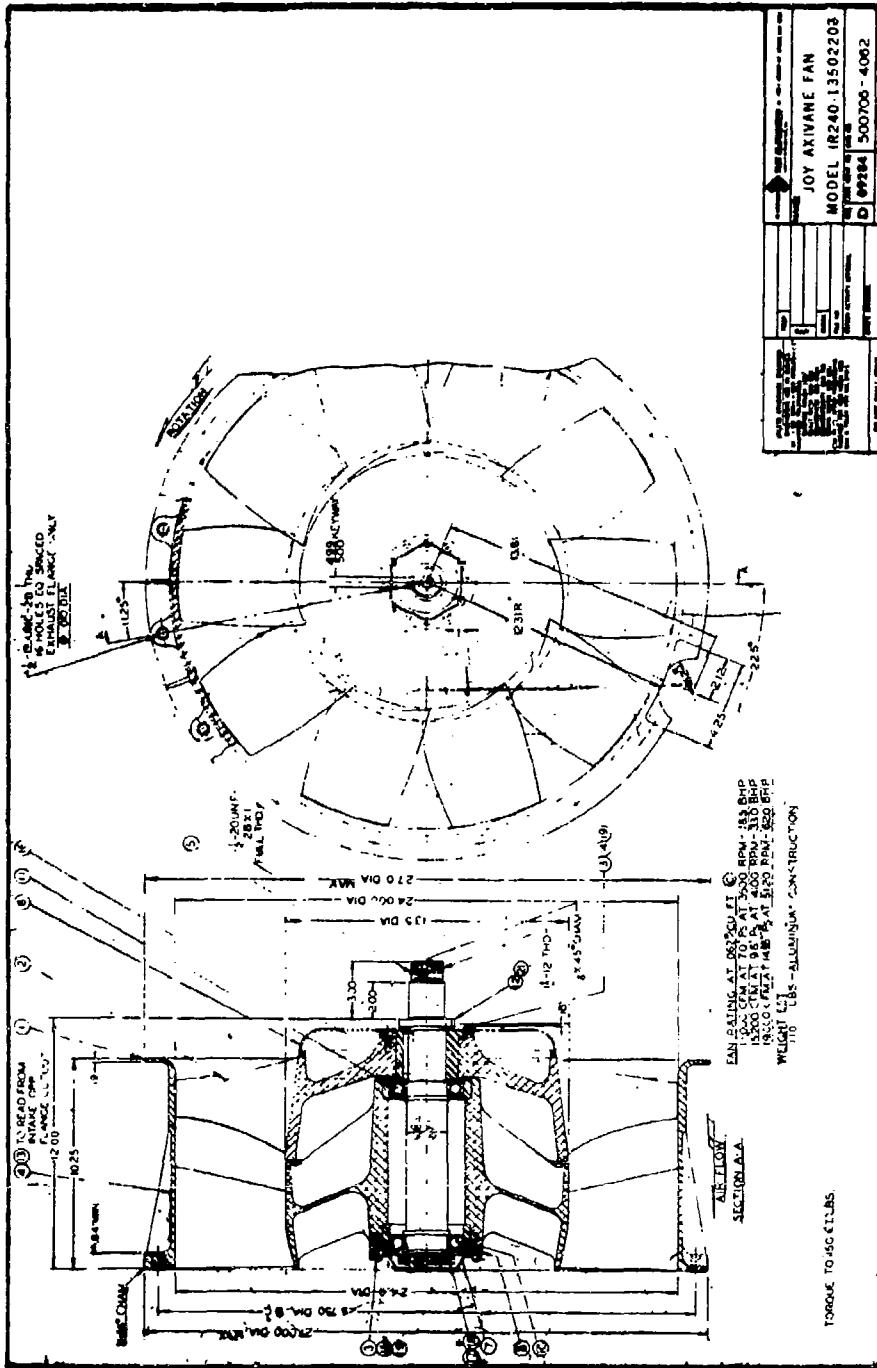

Figure B-17. Vane-axial Fan Drawing, 19,000 cfm
 (Courtesy of Joy Manufacturing Company)

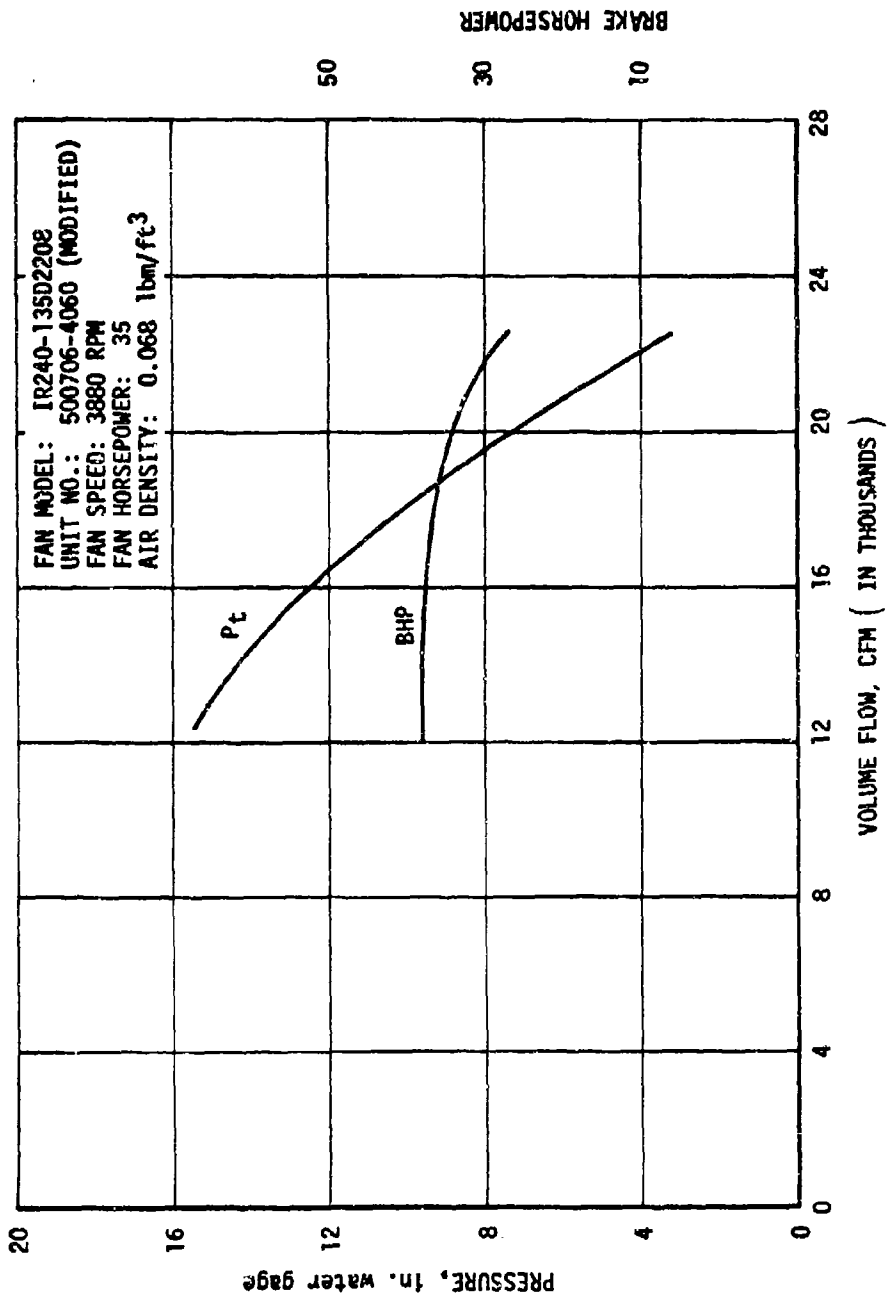

Figure B-18. Vane-axial Fan Performance Curve, 19,000 cfm
 (Courtesy of Joy Manufacturing Company)

AMCP 708-361

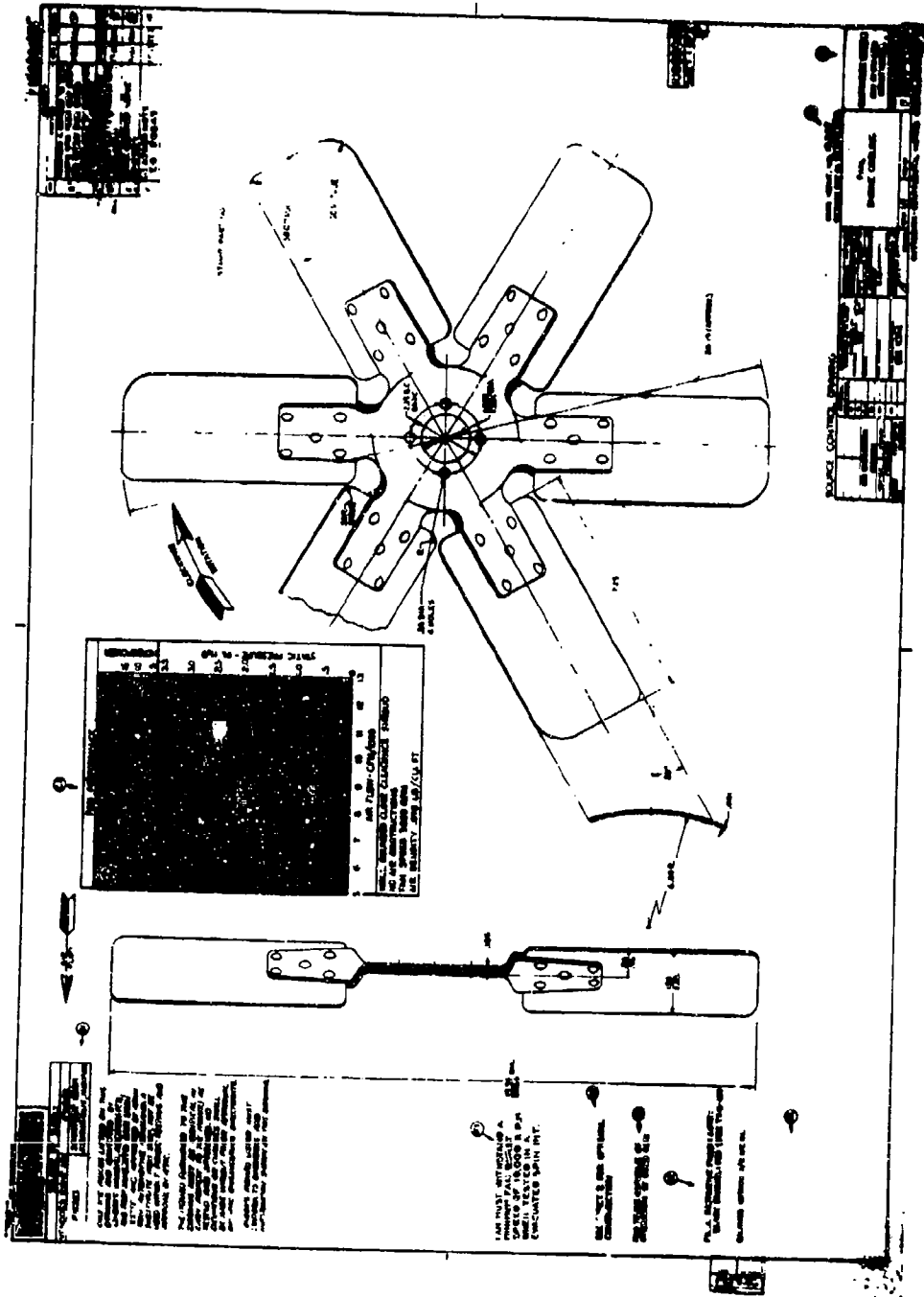

Figure B-19. Fan, Truck, Cargo, M44

B-2 MIXED FLOW FANS¹

B-2.1 OPTIMIZED SYSTEM ENGINEERING APPROACH TO THE SOLUTION OF ENGINE COOLING PROBLEMS IN MILITARY VEHICLES

Development over a number of years has proved the advantage of the engineered system approach to cooling problems. However, new techniques had to be found to obtain the maximum advantages of compact open running mixed flow fans that have characteristics of high pressure without stall and with low noise while producing relatively high volumes.

The discussion that follows briefly summarizes such an approach and give the outline of a re-engine² cooling project undertaken by Airscrew Fans in conjunction with the Detroit Diesel Allison Division of General Motors for the M47 Tank.

Two prototypes were tested thoroughly under laboratory conditions and an air-water differential of 100 deg F was achieved. The equipment operated satisfactorily in ambient temperatures of 130°F.

Noise and absorbed power were low with the possibility of further reduction by using thermostatic control of the hydraulically driven fans.

B-2.2 MIXED FLOW FANS FOR ENGINE COOLING SYSTEMS

The mixed flow fan, as its name implies, has a configuration combining the essential characteristics of both axial and centrifugal fans. These basic fan types are shown in Fig. B-20.

The pages that follow give preliminary

¹ Courtesy of AIRSCREW HOWDEN, LTD. Weybridge, Surrey, England

² Re-engine means to replace the original engine model with a different engine model, usually of higher horsepower, or to replace a spark engine with a diesel engine.

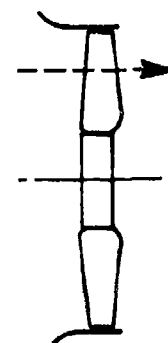

(A) AXIAL

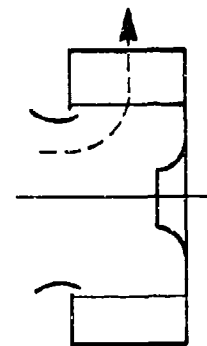

(B) CENTRIFUGAL

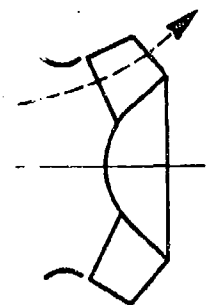

(C) MIXED FLOW

Figure B-20. Basic Fan Types

AMCP 706-381

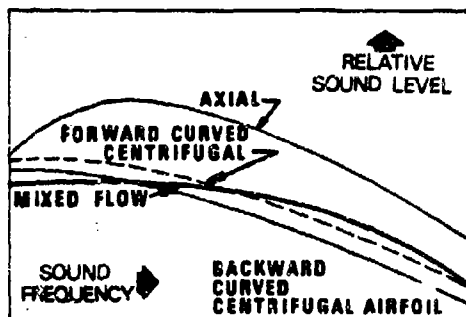

Figure B-21. Fan Sound Level Comparison

outline information on a range of hydraulically driven, open discharge, mixed flow fan units suitable for compact cooling systems on both military and commercial vehicles and equipment. The manufacturer should be contacted for current data.

The performances shown are indicative. As with any fan application, the geometry of the individual installation can modify the characteristics of the fan.

These fan units, which are designed to meet most Government defense equipment specifications, can be supplied in a form for belt or shaft drive. Special adaptations can be made depending on the complexity and quantity involved.

Typical performance charts are shown in Figs. B-30 through B-33.

For mixed flow fans, the air leaves the impeller with both axial and radial components in a conical swirling pattern. The use of guide vanes, a volute or a radial diffuser, allows recovery of the rotational kinetic energy of the air leaving the impeller and, if properly engineered, can increase the efficiency of the fan significantly. In any of the arrangements, the fan has an inherent nonstalling characteristic.

Modern design philosophy is directed

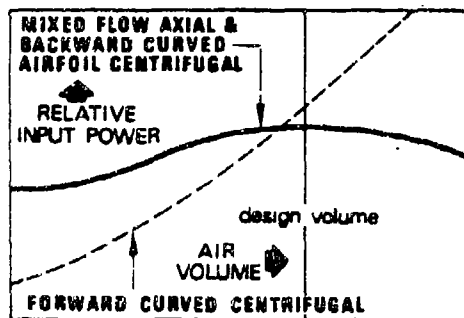

Figure B-22. Fan Power Requirement Comparison

toward high efficiency and low noise by maintaining aerodynamically clean inlet conditions and minimizing the effect of high relative velocities between the air and moving parts of the fan.

This approach, when applied to mixed flow fans, can produce high total impeller efficiencies which, when correctly arranged into casings, can maintain high overall fan static efficiencies of over 75 percent. This compares well with alternative axial flow and centrifugal types.

The comparisons shown in Figs. B-21, B-22, and B-23 indicate the characteristics of the mixed flow, axial, and centrifugal type fans from the aspects of sound level, power requirements, and stability.

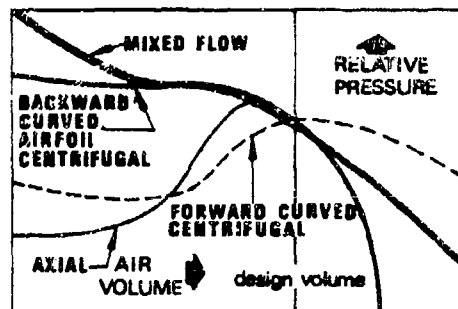

Figure B-23. Fan Stability Comparisons

Development in recent years allows the achievement of acceptable mixed flow fan efficiencies without the use of guide vanes or volute by optimization, in design, of outlet kinetic energy losses arising from the rotational and conical flows.

This type of mixed flow fan is designed to operate by taking air from one chamber or space and discharging it into a second chamber or, alternatively, directly to free air, being partition-mounted between the two. It is particularly suited to military and other engine-cooling applications where relatively large volumes of air have to be handled in very limited space against the high pressure associated with restricted entry and discharge grille arrangements, and compact radiators.

This open-running mixed flow type of fan has the ability to operate with acceptable efficiencies in installations congested with equipment. The relatively low discharge velocity coupled with the swirling and conical flow pattern allows the air leaving the fan to find its way easily around bulky components placed immediately in line with it.

The fan used in the Scorpion Tank is shown in Fig. B-24. This particular design is aimed toward higher pressure requirements and is capable of useful volumes up to 6,000 cfm at 7 in. of water static pressure, and pressures up to 15 in. of water at 3000 cfm when running at 6,000 rpm.

A range of mixed flow fans has been developed in line with this design philosophy. General technical details on typical fans are contained in Figs. B-30 through B-33.

B-2.3 INSTALLATION OF MIXED FLOW COOLING FANS IN MILITARY VEHICLES

Although careful arrangement of installation of the mixed flow fan is necessary in order to take full advantage of its potential capability, the diagrams that follow indicate

the general configuration most likely to be required in a military vehicle.

Detailed performance and dimensional data are available for a range of sizes of hydraulically-driven mixed flow fans. Fans of this type also can be supplied suitable for shaft or pulley drive either on the inlet or discharge side in addition to the variable speed hydraulic drive. Advice on the best possible arrangement for individual installations should be sought in each case.

Fig. B-25 illustrates the conventional arrangement of the open-running mixed flow fan that is designed for taking air from one chamber or space and discharging it into a second chamber or to free air. The convenience of simple partition-mounting and the possibility of arranging bulky components near the fan axis on the discharge side, without obstruction to the airflow, are illustrated. The conical path of the discharge air is shown and the only area where obstruction should be avoided is in the discharge path immediately next to the impeller. Farther from the impeller, the air tends to diffuse more easily and will tend to flow around obstructions into a more radial or more axial direction without radically affecting the fan performance.

Fig. B-26 illustrates a radial diffuser on the fan discharge. The static pressure recovery of the conical and rotational velocities leaving the impeller compensates for losses due to directional changes within the louver. This eliminates the dissipation of original fan performance which normally is experienced when conventional discharge arrangements are used. This type of radial diffuser is particularly able to incorporate proven ballistic protection louver forms or grilles into the diffuser shapes shown, and can then be situated external to the vehicle where its protrusion is locally permissible.

A further refinement is the use of an additional cowl exterior to the diffuser which

AMCP 706-381

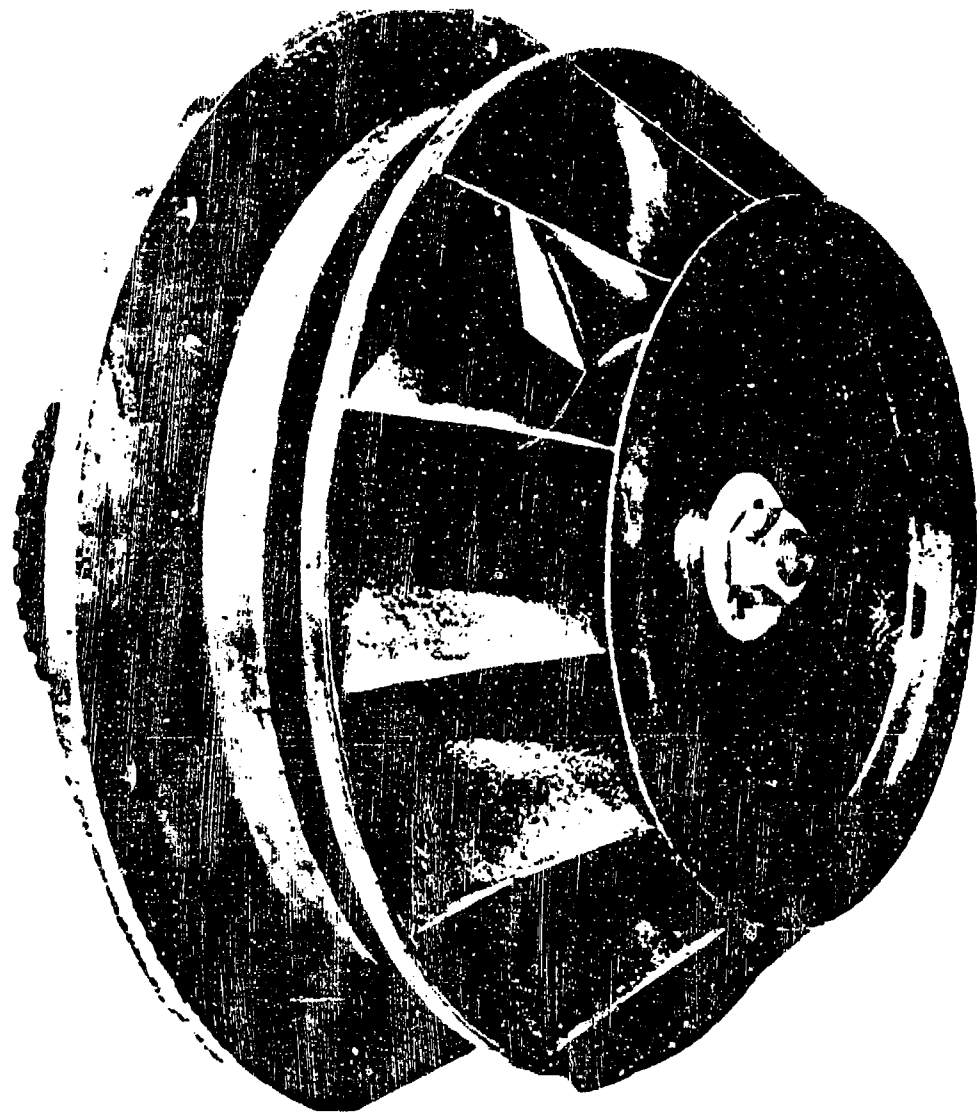

Figure B-24. 12 in. Diameter Mixed Flow Fan Used in the Scorpio Tank

directs the outgoing air in a particular direction to minimize air recirculation into the system intake.

Fig. B-27 illustrates a volute casing that can be designed and used to collect the air from the impeller efficiently and to discharge it away in a particular direction.

B-2.4 SYSTEM ENGINEERING

Considerable advantage can be gained, especially in the more extreme conditions of high heat load and limited space, by carefully engineered and optimized systems as opposed to the individual and sometimes irrelevant selection of components.

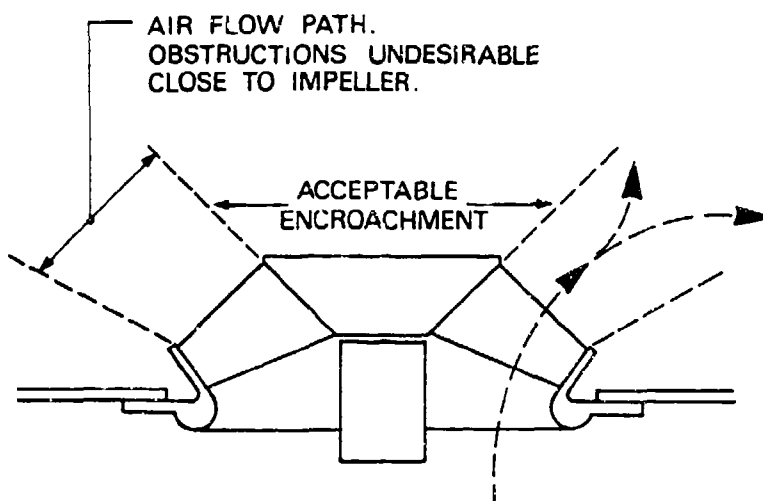

Figure B-25. Partition Mounted Open Running Mixed Flow Fan

The introduction of the mixed flow fan has facilitated a more flexible approach to system engineering. This flexibility has been found valuable in designing for the increasingly extreme conditions applicable to higher engine power and the resultant smaller space allocated for cooling systems, where conventional approaches have led to completely inadequate solutions.

The greatest factor to be faced is the conflicting requirements of compact installation with low fan power. Present vehicle designs and re-engine projects demand the

careful choice of all components, not only to achieve the lowest possible power, but also to optimize their interrelationship and relative positioning.

A particular example of the use of these techniques is illustrated by the cooling system used for the re-engine project for the M47 Tank where the acceptable solution was found only by the detailed consideration of all the components in the system and the suitable arrangement into the extremely limited space available.

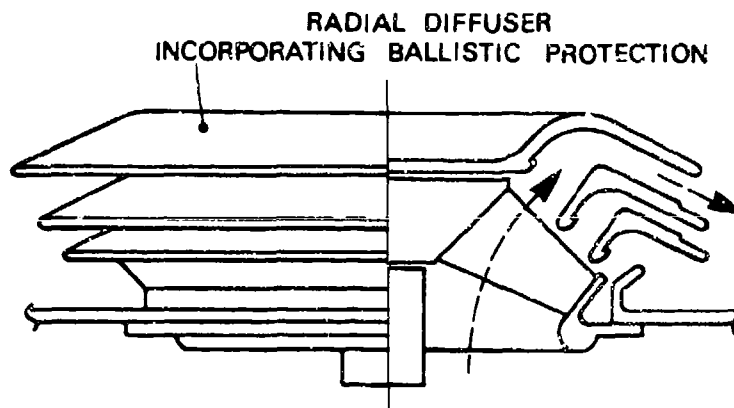

Figure B-26. Mixed Flow Fan Diffuser With Ballistic Louvers

AMCP 706-381

SCROLL CASING
WITH OUTLET LOUVER

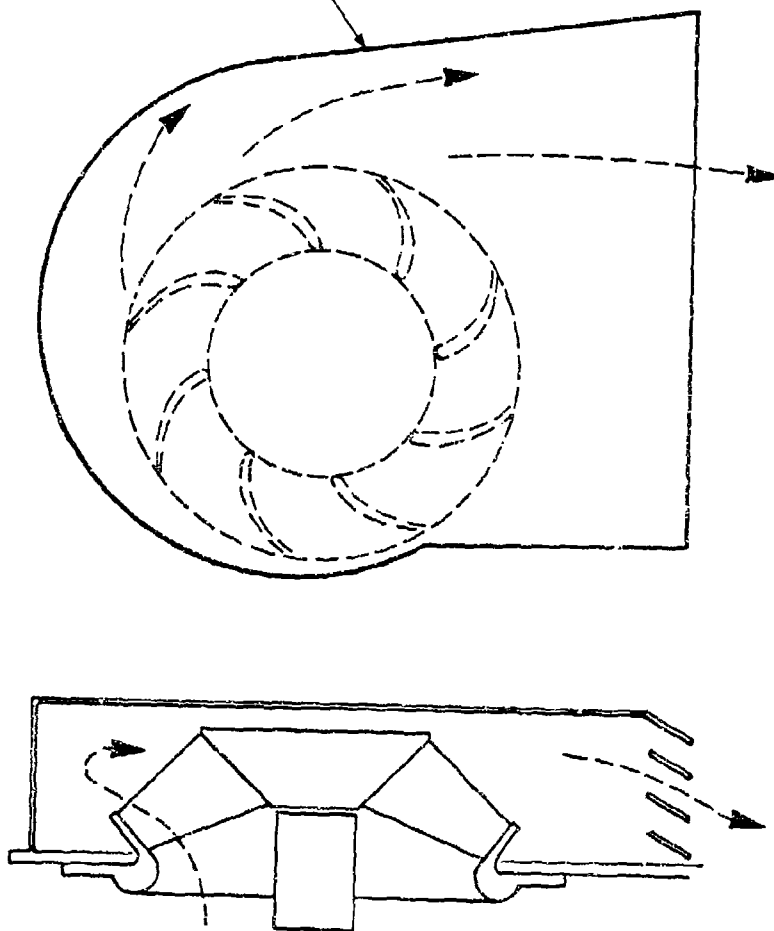

Figure B-27. Mixed Flow Fan With Valute Casing

The basic requirement at an ambient temperature of 130°F was to cool 31,000 Btu/min at maximum torque conditions using a maximum total radiator face area of 7 ft^2 and 33,000 Btu/min at maximum power condition—these figures being the combined engine and transmission heat rejection in each case.

If conventional solutions were used, this

requirement would have resulted in an unacceptable fan power considerably higher than that achieved by the optimized system.

By optimizing the opposing thermodynamic and aerodynamic factors, and considering these in relation to the shape of the space available and the entry and discharge losses, it was decided to use deep multirow and multipass radiators. As a consequence, the

savings in pressure losses in the parts of the system not directly contributing to cooling more than offset the increased radiator air resistance. This resulted in minimum fan power by reducing the airflow requirement.

Additional savings were made by further reducing the losses in the ducting and louvers by the use of turning vanes and good aerodynamic design with the result that these losses amounted to no more than a factor of six times the velocity pressure at the radiator face. Most conventional installations operate at many times this value.

Extensive field tests on the vehicle showed that the cooling performance met the specification completely and, with a maximum water temperature of 230°F (110° C) and a flow rate of 220 gal/min, an air-water differential of 100 deg F (55 deg C) was achieved at the maximum torque condition. The above design steps and results are outlined in Fig. B-27.

B-2.5 COOLING SYSTEM OPTIMIZATION

Fig. B-28 shows the relationships among the number of rows of radiator tubes, fan power, pressure drop, and airflow to meet the heat dissipation for the M47 project.

Vertical line A on these graphs shows a conventional choice of an 8-row radiator which has a high airflow requirement and, as a consequence, higher pressure losses in other parts of the air circuit, especially the inlet and exhaust grilles. Increasing the number of rows reduces the airflow with a corresponding increased pressure drop through the radiator.

Vertical line B on these graphs shows a condition of minimum pressure drop for the radiator when considered by itself.

Vertical line C on these graphs shows a condition of minimum pressure drop for the system when considered as an entity.

Vertical line D on these graphs shows the

condition where the fan power is lowest since this is dependent on the product of airflow and overall system pressure drop being a minimum. A two-pass counterflow water circuit was used in the radiator to improve further the heat dissipation to the maximum in this particular case.

It should be noted that although the deeper radiators gave the optimum in this particular case, this would not necessarily be true for all the cooling systems.

This method of approach requires accurate proven data on radiator performance characteristics and fan performance together with the environmental and commercial parameters that influence selection. With this information, use can be made of developed computer programs to obtain final selection of an optimum system. The hardware resulting from this design approach is shown in Fig. B-29.

In order to design an optimum cooling system the following criteria must be supplied:

1. Space envelope including any possible alternatives and areas of air inlet and discharge
2. Heat to be dissipated from engine and transmission related to engine operating speed
3. Maximum operational ambient temperature and normal operating range
4. Maximum engine water temperature related to maximum ambient temperature and operational range of thermostat
5. Water circulation rate against engine speed
6. Any other requirements needing special consideration.

AMCP 706-381

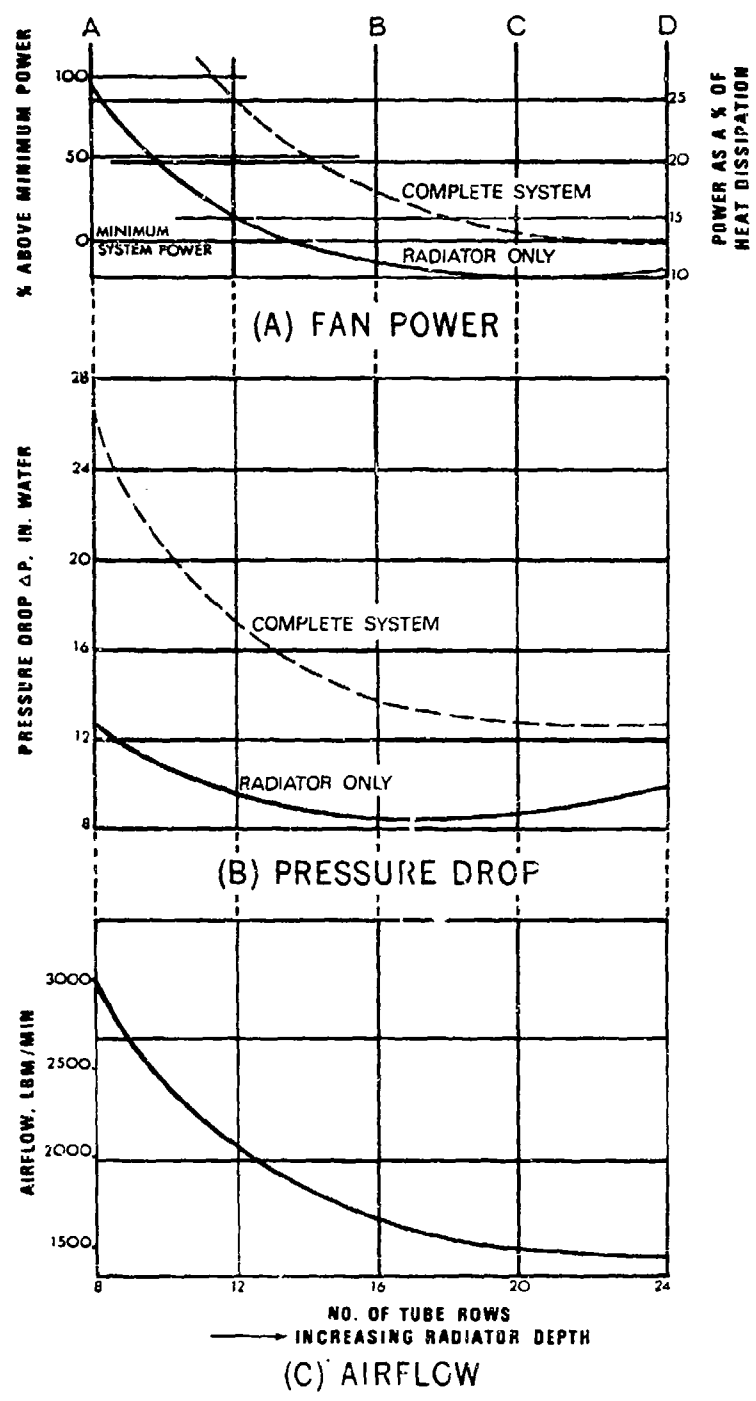
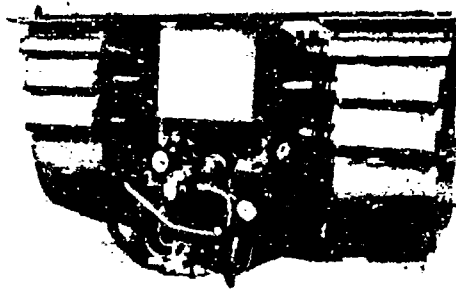

Figure B-28. Cooling System Optimization Charts



(A) POWER PACKAGE, 3/4 VIEW



(B) POWER PACKAGE, FRONT VIEW

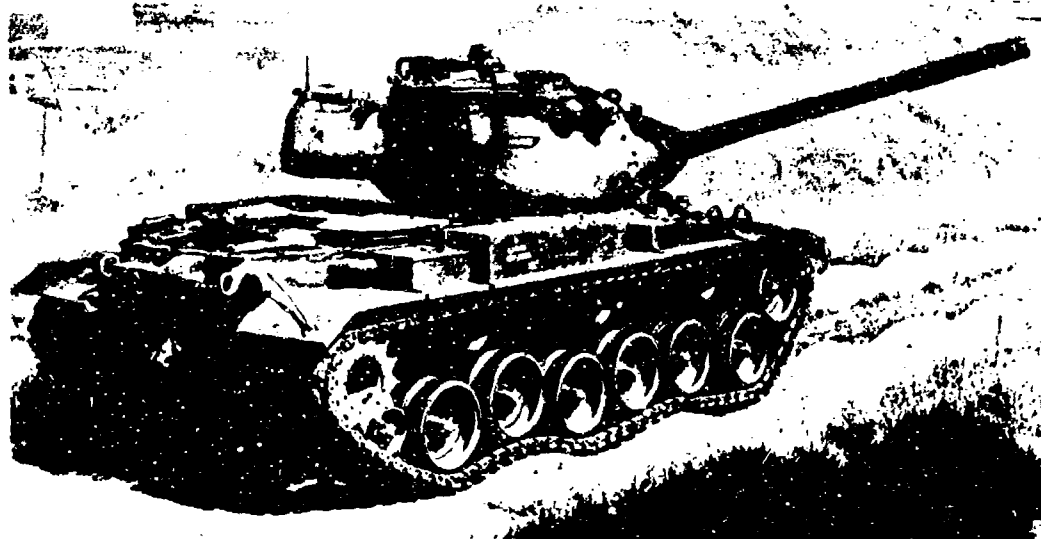

(C) POWER PACKAGE INSTALLED IN THE M47 TANK

Figure B-29. M47 Tank Power Package Cooled With Two Mixed Flow Fans

B-2.6 DEFINITIONS OF UNITS

The mixed flow fan performance charts are labeled with both English and Standard International Units (SI). The following definitions of these units are presented for reference:

<u>Name</u>	<u>SI Unit</u>	<u>English Unit</u>
Power, <i>P</i>	Watt, W	Horsepower, HP
Pressure, <i>p</i>	Newton/meter ² , N/m ²	Inch of Water, in. H ₂ O

Pound/square
inch, lb/in.²

Flowrate Volume, <i>Q</i>	Meter ³ /second, m ³ /s	Cubic feet/ minute, CFM
------------------------------	--	----------------------------

Density, <i>ρ</i>	Kilogram/meter ³ , kg/m ³	Pound mass/ cubic foot, lbm/ft ³
-------------------	--	---

Typical mixed flow fan characteristic charts are shown in Figs. B-30 through B-33.

AMCP 706-361

MODEL 305 MP3 311

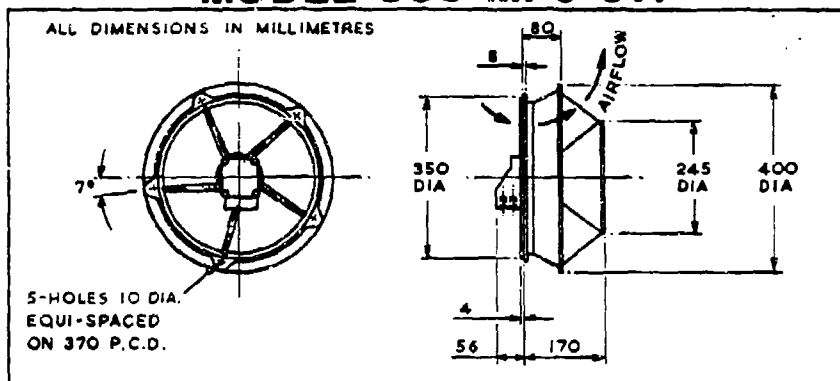

DESCRIPTION

A high output mixed flow fan unit designed for partition mounting and free discharge to a plenum or open space. The backward inclined impeller blades are self-cleaning and give non-stall, non-overloading power characteristics with low noise emission and high efficiency. Driven by a fixed displacement hydraulic motor it is capable of variable speed operation through thermostatic control.

One 305 MP3 311 fan will cool 200 h.p. with manual ear-box as on Scorpion light tank.

TECHNICAL DATA

Rated Performance:

As shown by preferred region on curve.

Hydraulic Motor:
 Displacement 4.68 cm³/rev

Mounting Attitude:
 Unrestricted.

Endurance:
 Overhaul period depends on application power requirement.

Ambient Temp. Range:
 Max. ambient temp. 100°C
 Min. operating temp. depends on hydraulic fluid used.

Weight (approx.)
 13.5 kg.

Climatic Range:
 BS.2G.100.DEF.133

Vibration Grade:
 BS.2G.100.DEF.133

Acceleration Grade:
 BS.2G.100.DEF.133

Shock & High Impact:
 BS.2G.100.DEF.133

Fireproofness:
 Fire resistant hydraulic fluids can be selected.

Noise Level at 1 m:
 98 dB at 5500 rpm.

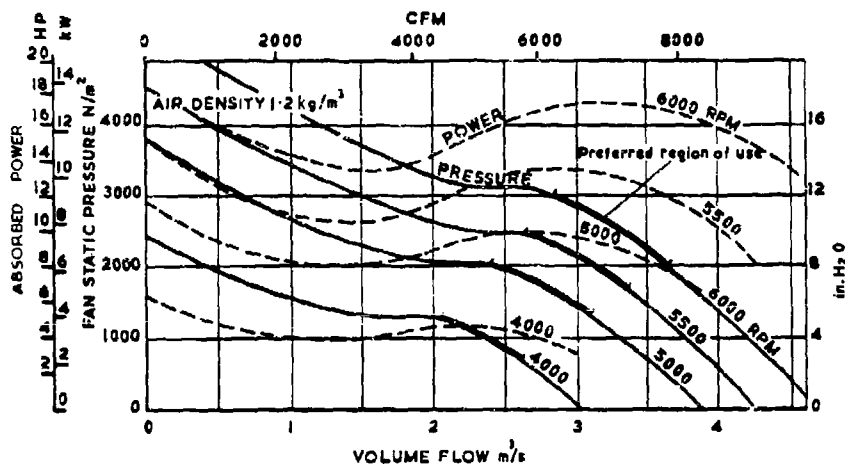
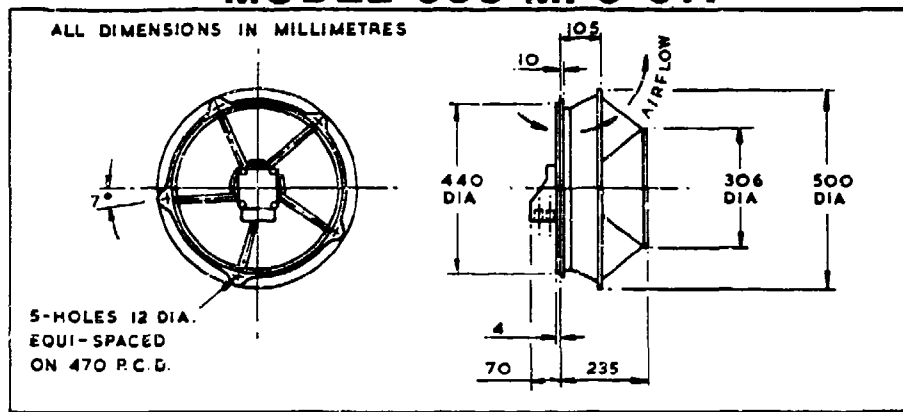

Figure B-30. Mixed Flow Fan Performance, Model 305 MP3 311
 (Courtesy of Airscrew Hawden Ltd., Weybridge, Surrey, England)

MODEL 380 MP3 311



DESCRIPTION

A high output mixed flow fan unit designed for partition mounting and free discharge to a plenum or open space. The backward inclined impeller blades are self-cleaning and give non-stall, non-overloading power characteristics with low noise emission and high efficiency. Driven by a fixed displacement hydraulic motor it is capable of variable speed operation through thermostatic control.

Two 380 MP3 311 fans will cool 750 hp with manual transmission as on Centurion tank engine retrofit.

TECHNICAL DATA

Rated Performance:
 As shown by preferred region on curve.

Hydraulic Motor:
 Displacement 9.84 cm³/rev

Mounting Attitude:
 Unrestricted.

Endurance:
 Overhaul period depends on application power requirement.

Ambient Temp. Range:
 Max. ambient temp. 100°C
 Min. operating temp. depends on hydraulic fluid used.

Weight (approx.)
 26 kg

Climatic Range:
 BS.2G.100.DEF.133

Vibration Grade:
 BS.2G.100.DEF.133

Acceleration Grade:
 BS.2G.100.DEF.133

Shock & High Impact:
 BS.2G.100.DEF.133

Fireproofness:
 Fire resistant hydraulic fluids can be selected.

Noise Level at 1 m:
 102 dB at 4800 rpm.

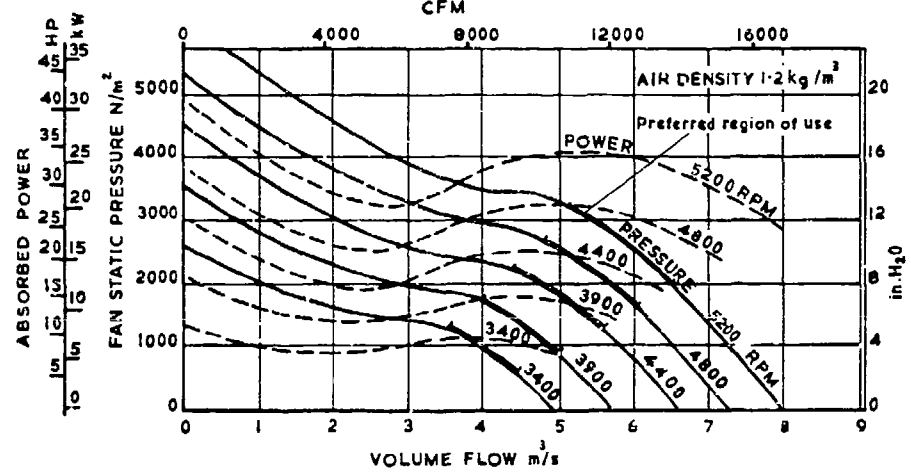
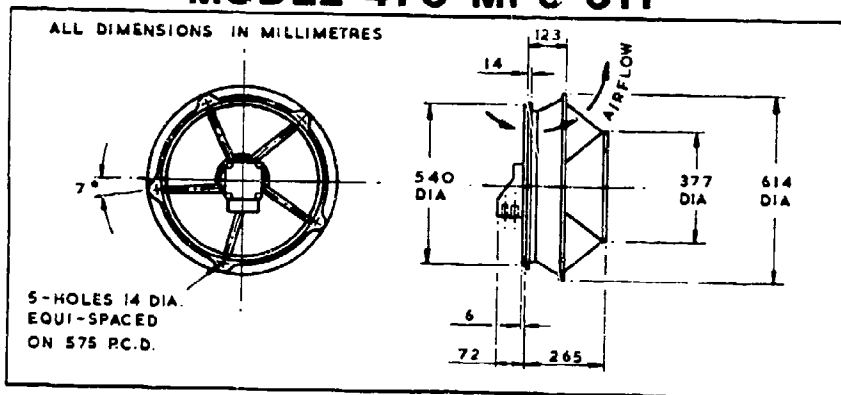

Figure B-31. Mixed Flow Fan Performance, Model 380 MP3 311
 (Courtesy of Airscrew Howden Ltd., Weybridge, Surrey, England)

AMCP 706-381

MODEL 475 MP3 311



DESCRIPTION

A high output mixed flow fan unit designed for partition mounting and free discharge to a plenum or open space. The backward inclined impeller blades are self-cleaning and give non-stall, non-overloading power characteristics with low noise emission and high efficiency. Driven by a fixed displacement hydraulic motor it is capable of variable speed operation through thermostatic control.

Two 475 MP3 311 fans will cool 700-900 h.p. with automatic transmission as on M47 engine retrofit.

TECHNICAL DATA

Rated Performance:
 As shown by preferred region on curve.

Hydraulic Motor:
 Displacement 19.0 cm³/rev

Mounting Attitude:
 Unrestricted.

Endurance:
 Overhaul period depends on application power requirement.

Ambient Temp. Range:
 Max. ambient temp. 100°C
 Min. operating temp. depends on hydraulic fluid used.

Weight (approx.):
 39 kg.

Climatic Range:
 BS.2G.100, DEF.133

Vibration Grade:
 BS.2G.100, DEF.133

Acceleration Grade:
 BS.2G.100, DEF.133

Shock & High Impact:
 BS.2G.100, DEF.133

Fireproofness:
 Fire resistant hydraulic fluids can be selected.

Noise Level at 1 m:
 102 dB at 4000 rpm.

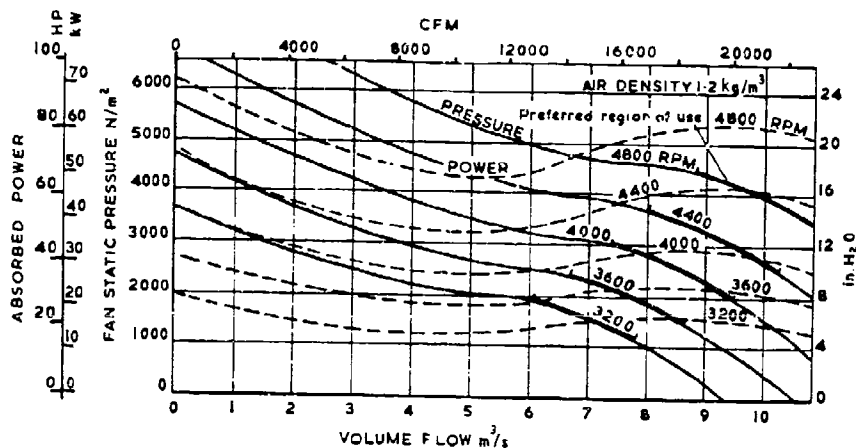
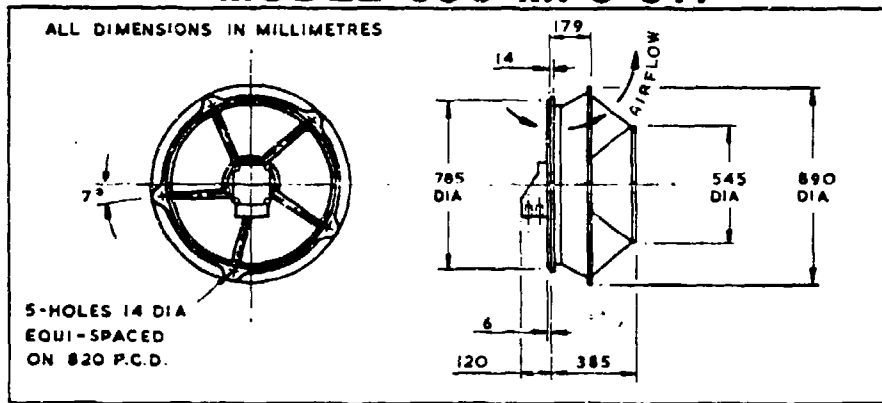

Figure B-32. Mixed Flow Fan Performance, Model 475 MP3 311
 (Courtesy of Airscrew Howden Ltd., Weybridge, Surrey, England)

MODEL 680 MP3 311



DESCRIPTION

A high output mixed flow fan unit designed for partition mounting and free discharge to a plenum or open space. The backward inclined impeller blades are self-cleaning and give non-stall, non-overloading power characteristics with low noise emission and high efficiency. Driven by a fixed displacement hydraulic motor it is capable of variable speed operation through thermostatic control.

Two or three 680 MP3 311 fans will cool 1500-2500 hp engines with automatic transmission as being considered on future main battle tanks.

TECHNICAL DATA

Rated Performance:
 As shown by preferred region on curve.

Hydraulic Motor:
 Displacement 78.2 cm³/rev

Mounting Attitude:
 Unrestricted.

Endurance:
 Overhaul period depends on application power requirement.

Ambient Temp. Range:
 Max. ambient temp. 100°C
 Min. operating temp. depends on hydraulic fluid used.

Weight (approx.)
 103 kg

Climatic Range:
 BS.2G.100.DEF.133

Vibration Grade:
 BS.2G.100.DEF.133

Acceleration Grade:
 BS.2G.100.DEF.133

Shock & High Impact:
 BS.2G.100.DEF.133

Fireproofness:
 Fire resistant hydraulic fluids can be selected.

Noise Level at 1 m:
 104 dB at 2500 rpm.

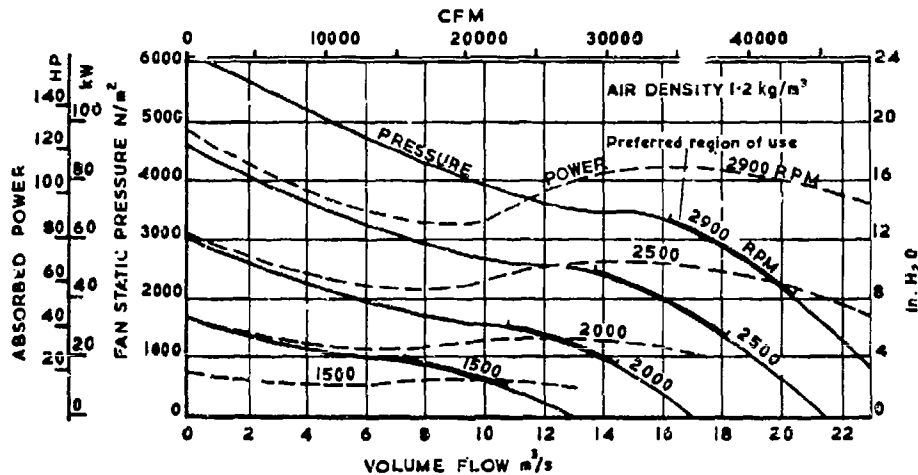

Figure B-33. Mixed Flow Fan Performance, Model 680 MP3 311
 (Courtesy of Airscrew Hawden Ltd., Weybridge, Surrey, England)

AMCP 700-381

**B-3 DETROIT DIESEL ENGINE COOLING
FANS**

A series of propeller type cooling fans are available for the Detroit Diesel Allison Division series of diesel engines. The perfor-

mance characteristics curves for these fans are shown in Figs. B-34 through B-46 for reference only. The engine manufacturer should be contacted for guidance and recommendations for each specific application. (See Table 4-2 for engine usage.)



DETROIT DIESEL ENGINE DIVISION GENERAL MOTORS CORPORATION

FAN CHARACTERISTICS
18 INCH - 5 BLADE x 2 3/16 INCH PROJECTED WIDTH

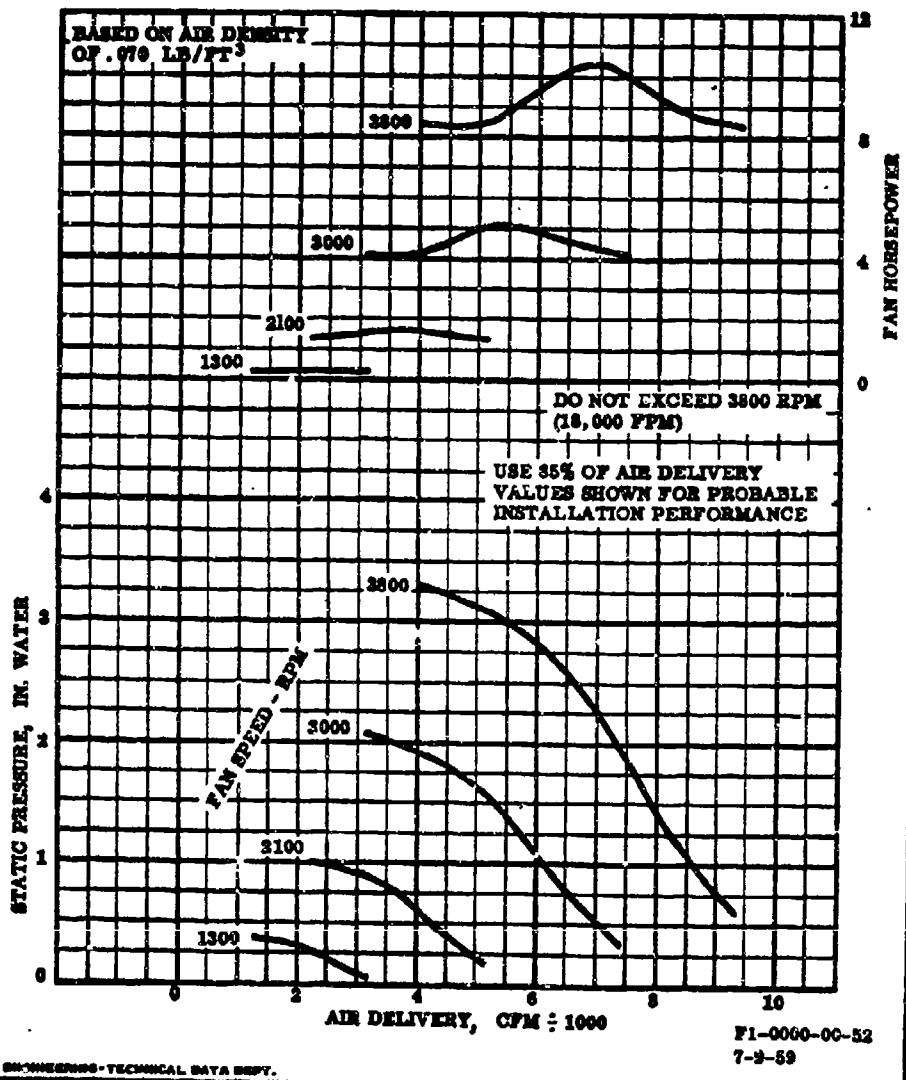

Figure B-34. Cooling Fan Performance Curve No. F1-0000-00-52

AMCP 706-361



DETROIT DIESEL ENGINE DIVISION

GENERAL MOTORS CORPORATION

FAN CHARACTERISTICS
 18 INCH - 6 BLADE x 2 3/8 INCH PROJECTED WIDTH

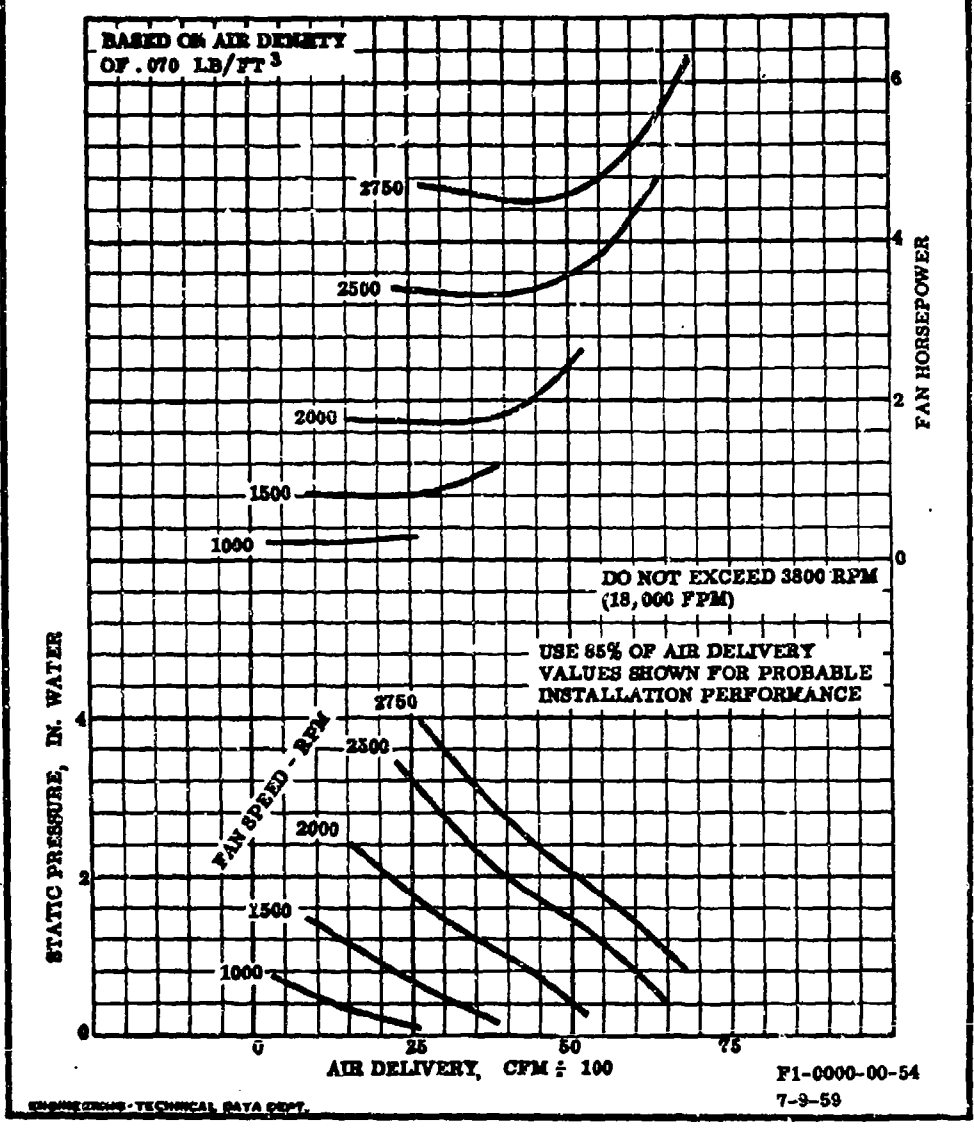

Figure B-35. Cooling Fan Performance Curve No. F1-0000-00-54



DETROIT DIESEL ENGINE DIVISION GENERAL MOTORS CORPORATION

FAN CHARACTERISTICS
22 INCH - 5 BLADE x 2 INCH PROJECTED WIDTH
PROBABLE INSTALLATION PERFORMANCE

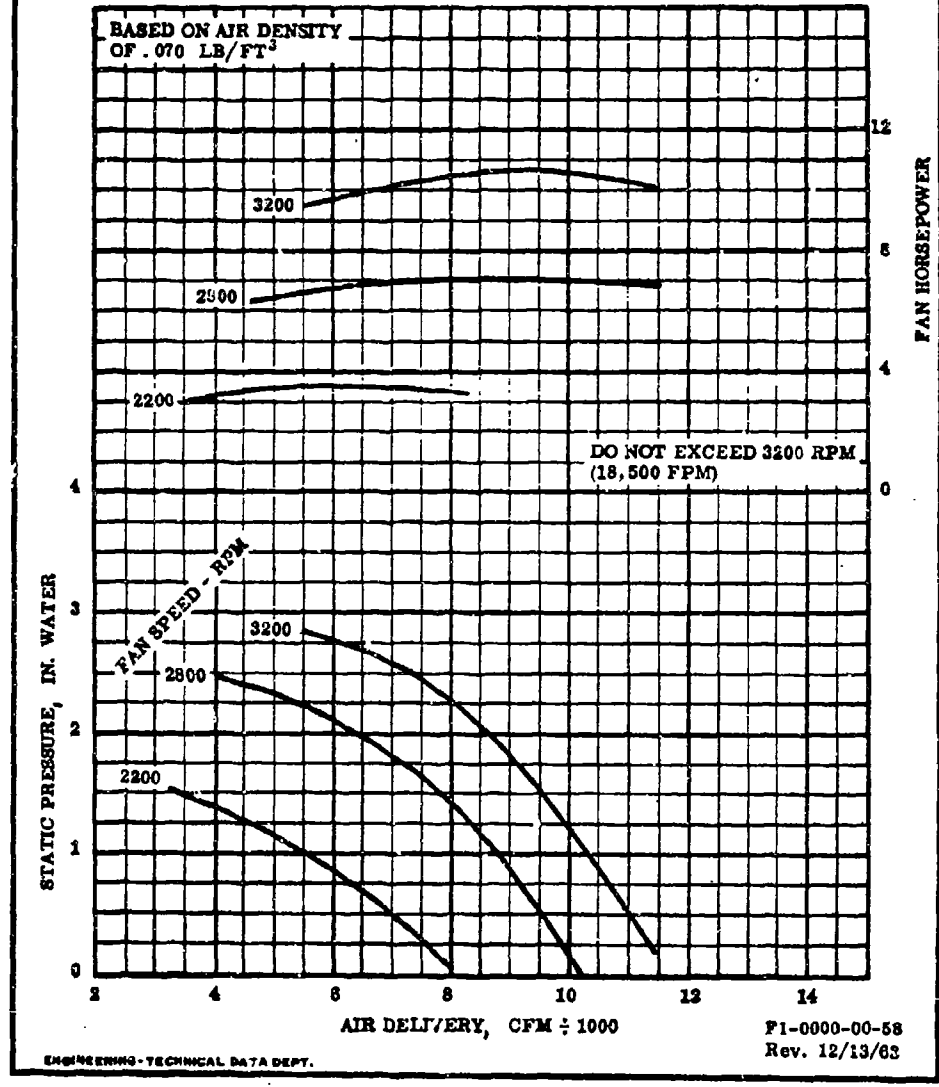

Figure B-36. Cooling Fan Performance Curve No. F1-0000-00-58

AMCP 706-381



DETROIT DIESEL ENGINE DIVISION GENERAL MOTORS CORPORATION

FAN CHARACTERISTICS
22 INCH - 6 BLADE x 2 1/4 INCH PROJECTED WIDTH

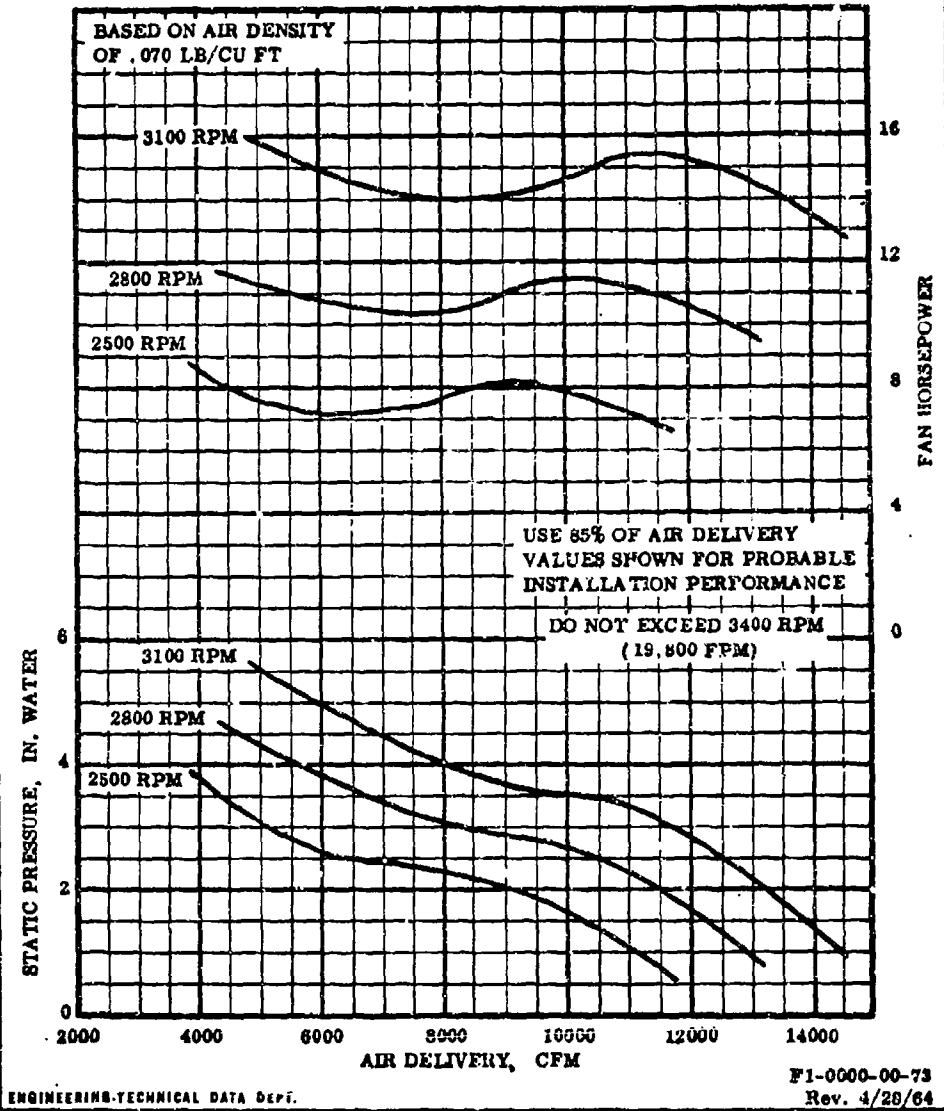

Figure B-37. Cooling Fan Performance Curve No. F1-0000-00-73



DETROIT DIESEL ENGINE DIVISION GENERAL MOTORS CORPORATION

FAN CHARACTERISTICS
34 INCH - 8 BLADE x 2 3/8 INCH PROJECTED WIDTH

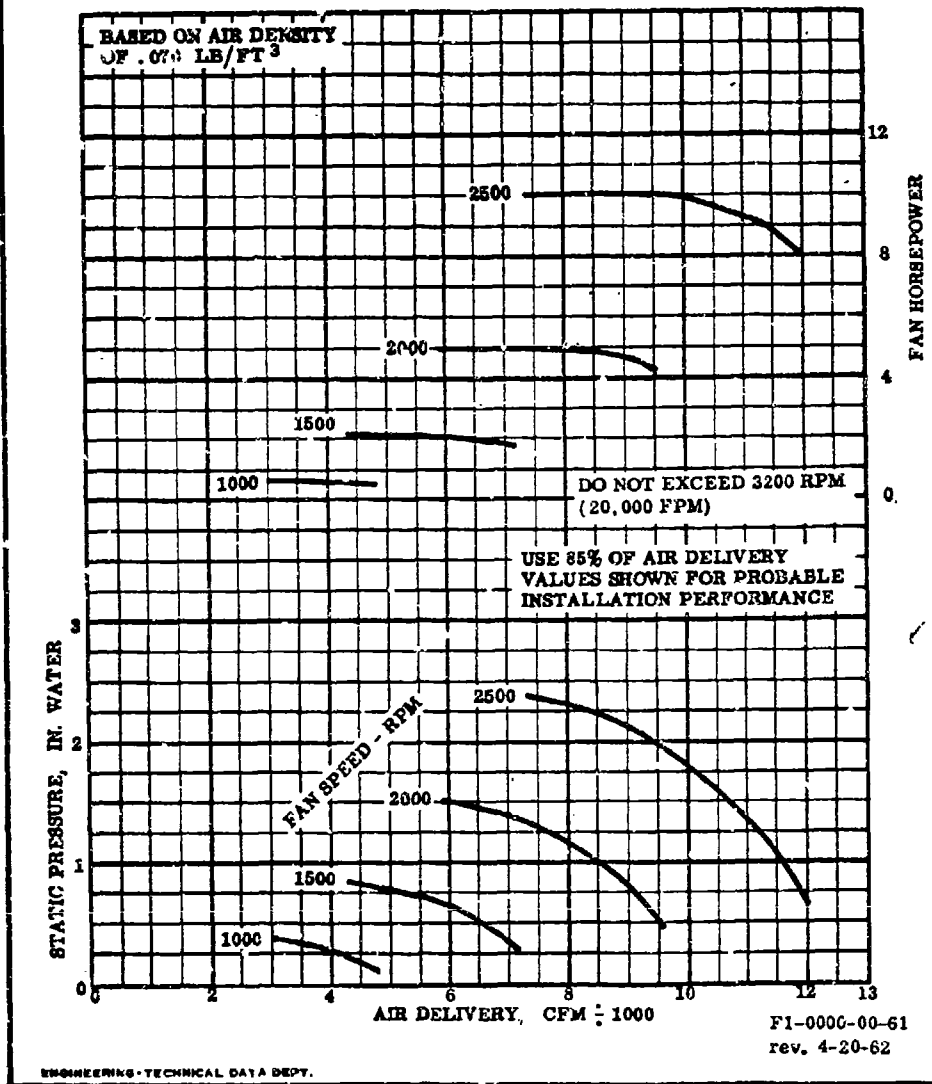

Figure B-38. Cooling Fan Performance Curve No. F1-0000-00-61

AMCP 708-361

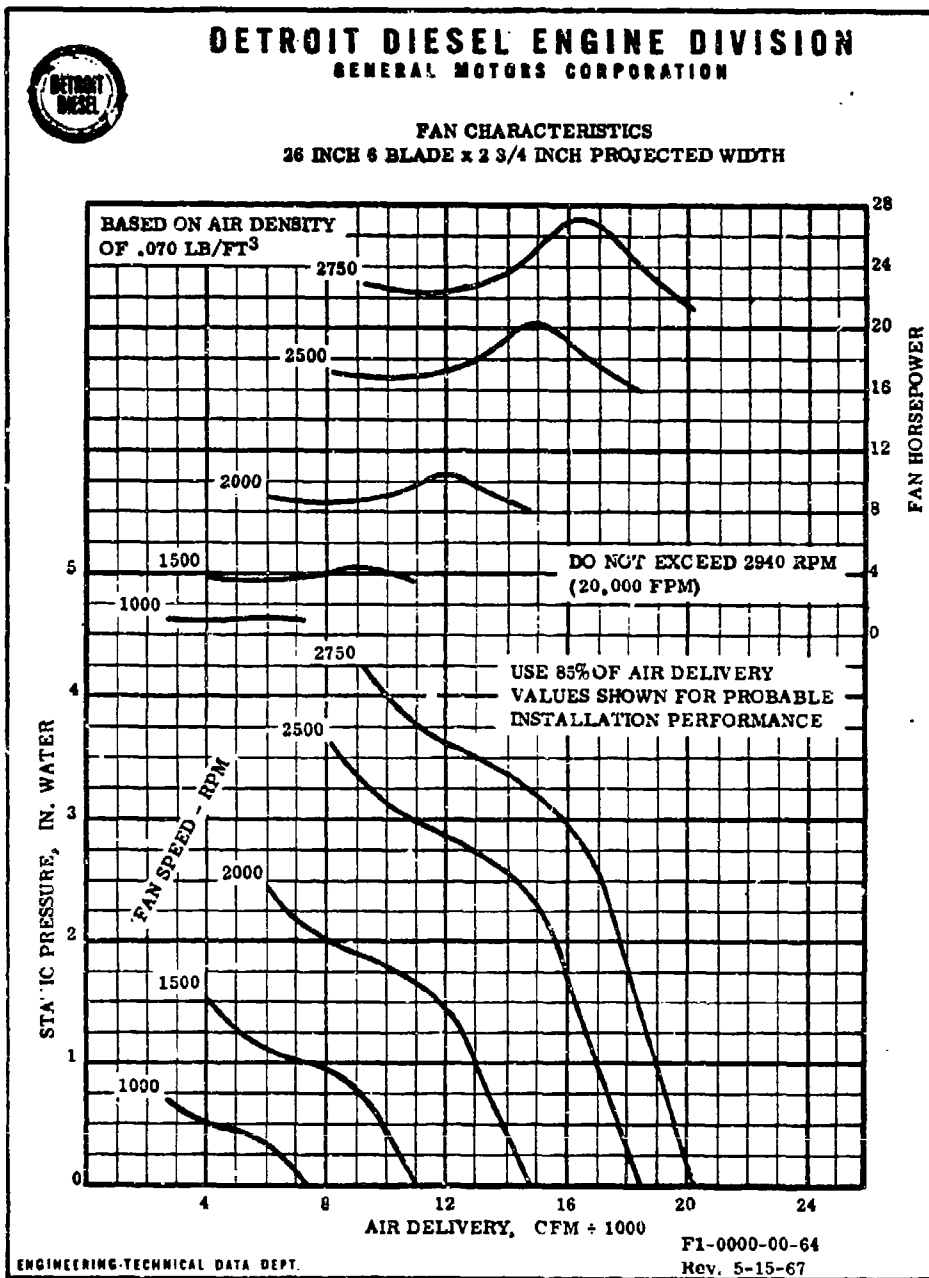

Figure B-39. Cooling Fan Performance Curve No. F1-0000-00-64



DETROIT DIESEL ENGINE DIVISION

GENERAL MOTORS CORPORATION

FAN CHARACTERISTICS
20 INCH - 6 BLADE 3 1/2 INCH PROJECTED WIDTH

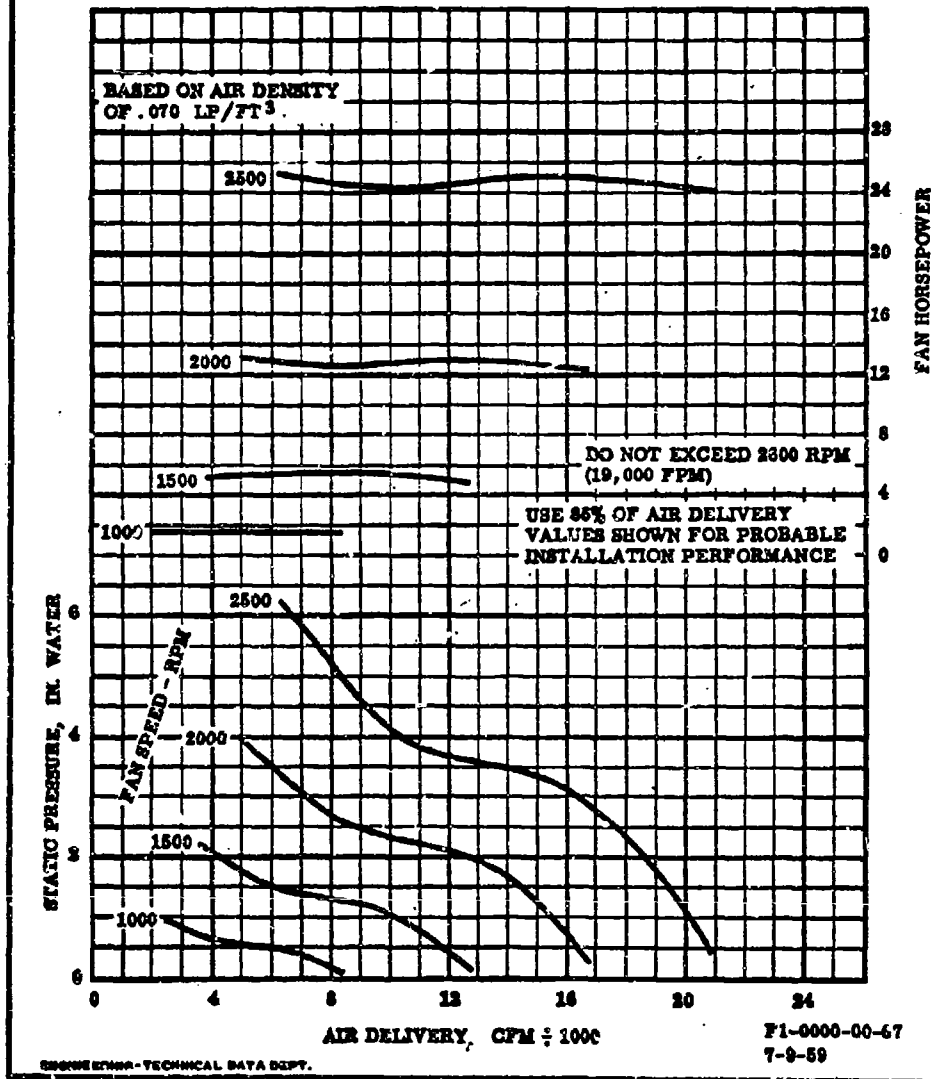

Figure B-40. Cooling Fan Performance Curve No. F1-0000-00-67



DETROIT DIESEL ENGINE DIVISION

GENERAL MOTORS CORPORATION

FAN CHARACTERISTICS
 32 INCH - 8 BLADE x 3.59 INCH PROJECTED WIDTH

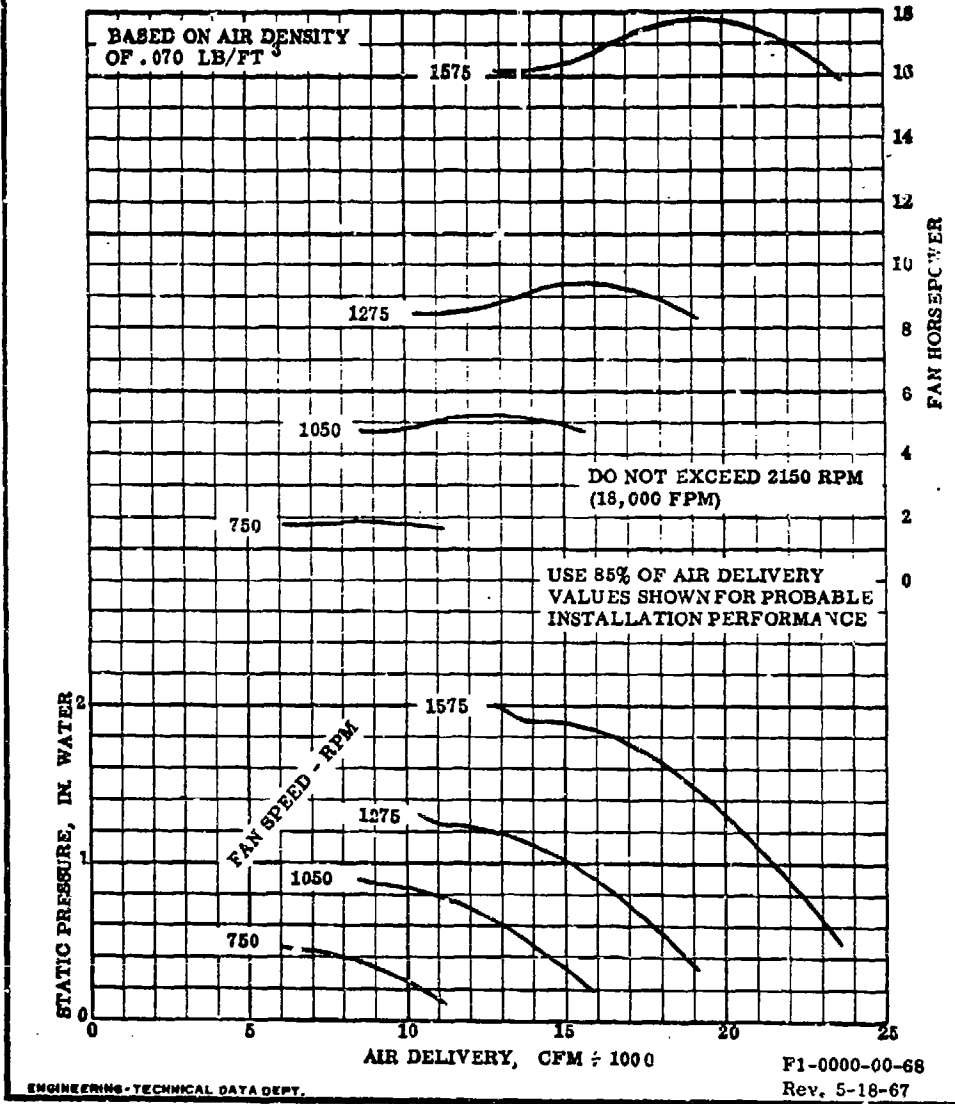

Figure B-41. Cooling Fan Performance Curve No. F1-0000-00-68



DETROIT DIESEL ENGINE DIVISION GENERAL MOTORS CORPORATION

FAN CHARACTERISTICS
32 INCH - 8 BLADE x 3 5/8 INCH PROJECTED WIDTH

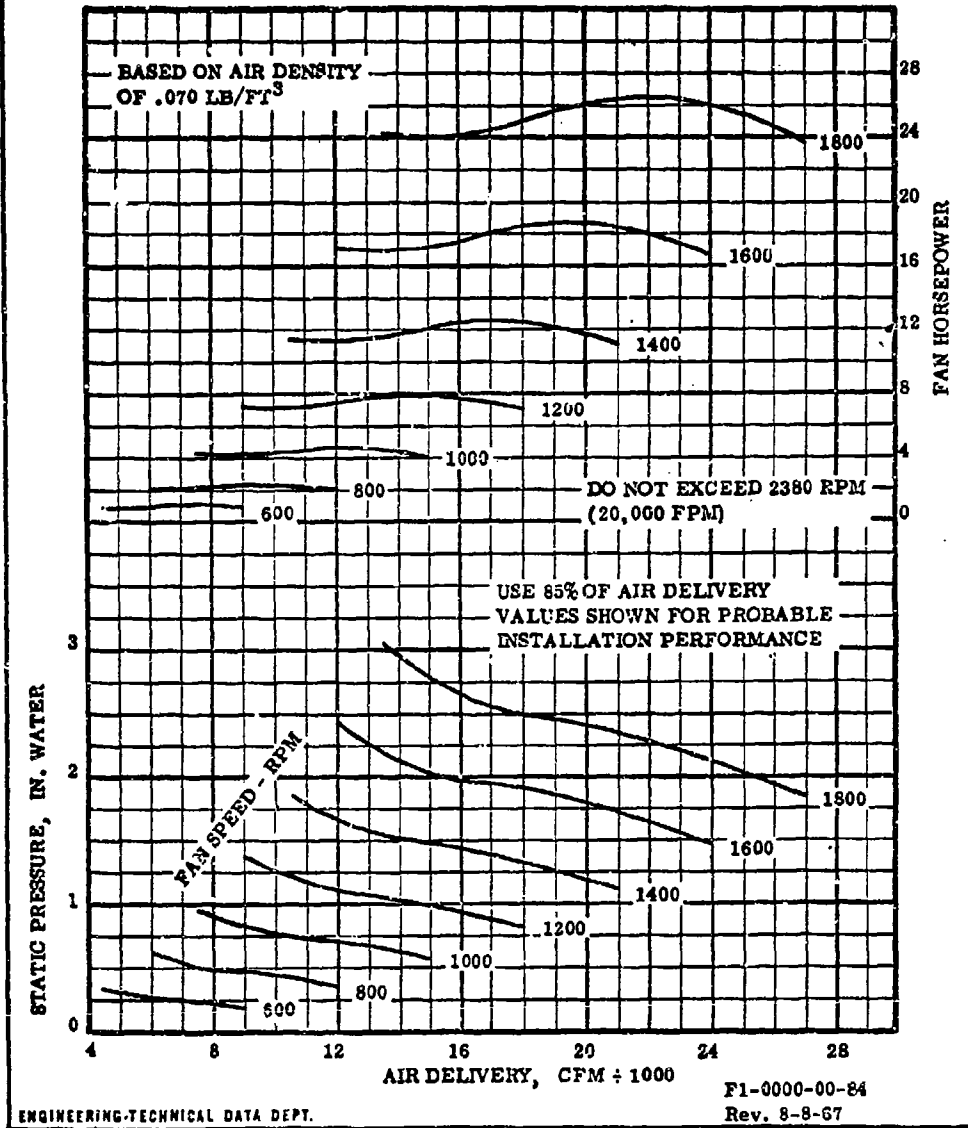

Figure B-42. Cooling Fan Performance Curve No. F1-0000-00-84

AMCP 706-381



DETROIT DIESEL ENGINE DIVISION
 GENERAL MOTORS CORPORATION

FAN CHARACTERISTICS
 32 INCH - 8 BLADE x 2.33 INCH PROJECTED WIDTH

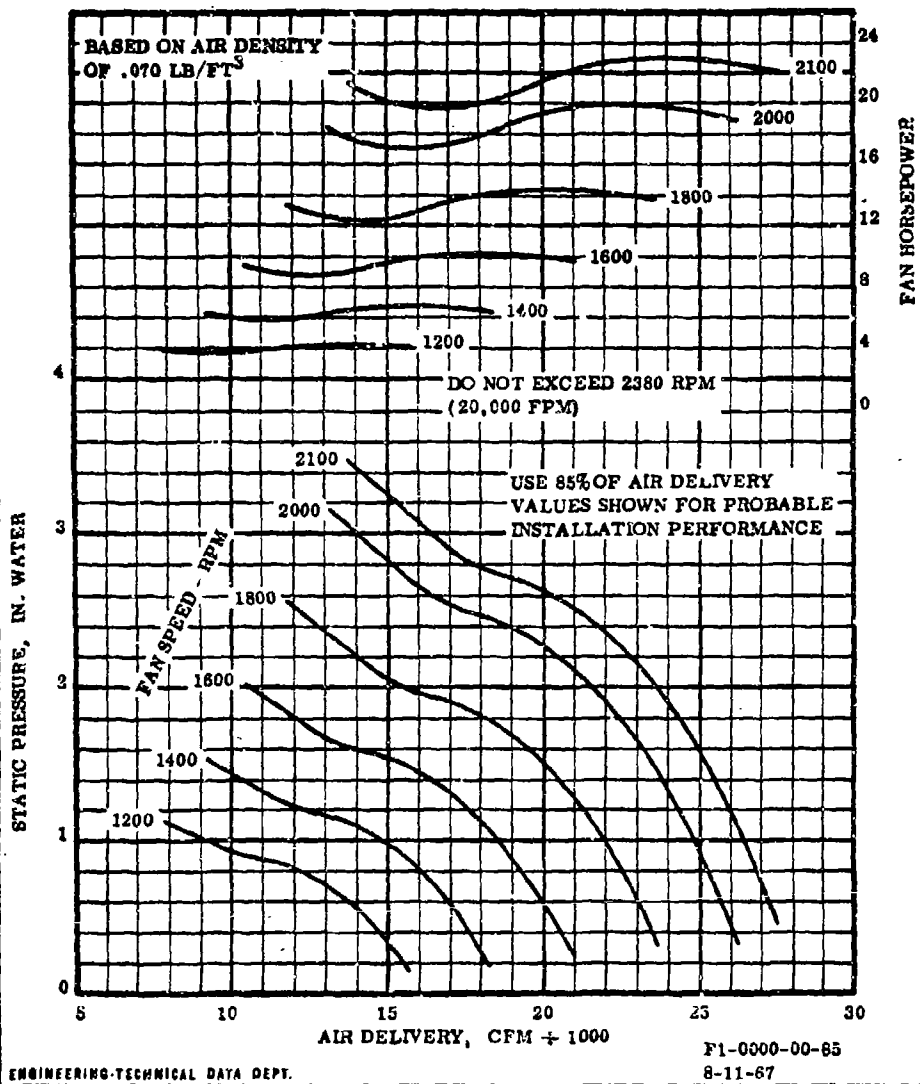

Figure B-43. Cooling Fan Performance Curve No. F1-0000-00-85



DETROIT DIESEL ENGINE DIVISION

GENERAL MOTORS CORPORATION

FAN CHARACTERISTICS
34 INCH - 8 BLADE x 3 INCH PROJECTED WIDTH

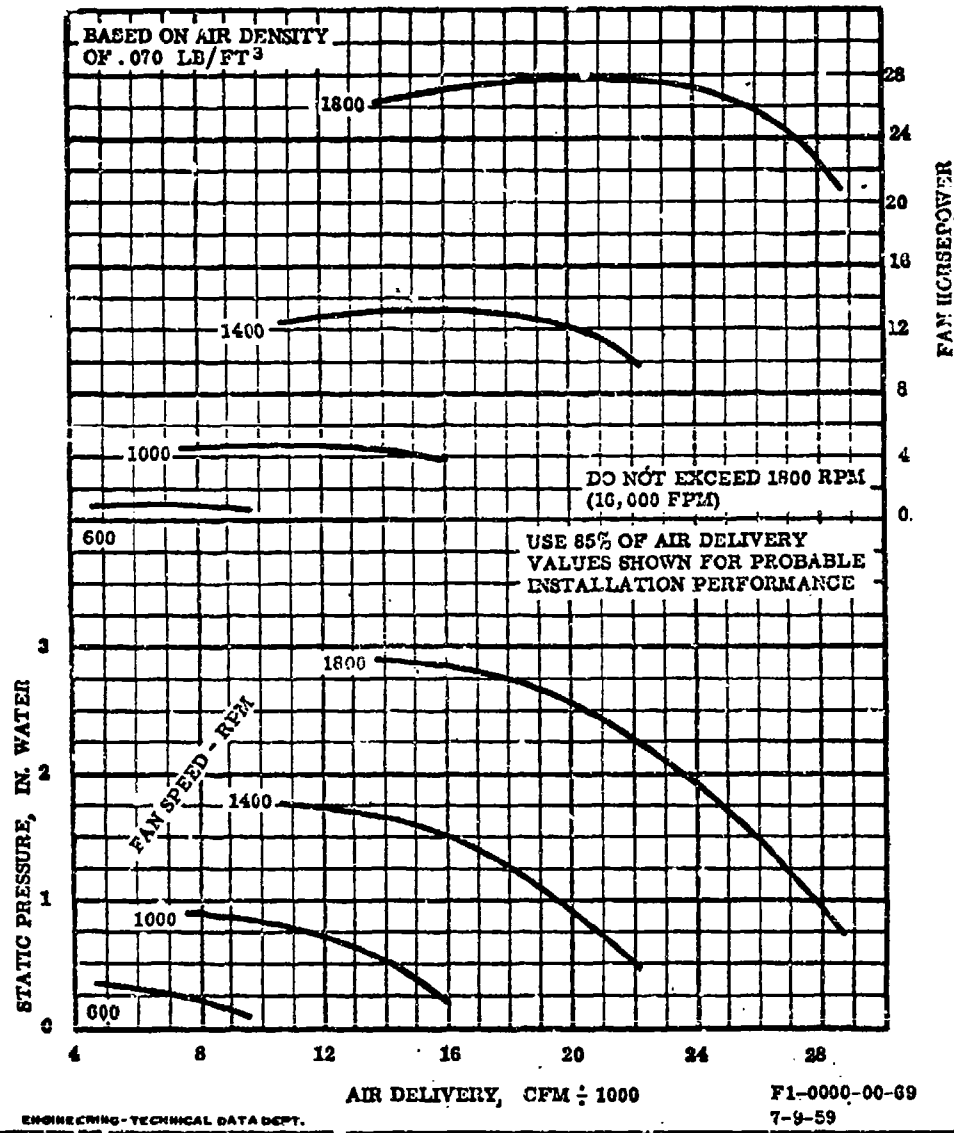

Figure B-44. Cooling Fan Performance Curve No. F1-0000-00-69



DETROIT DIESEL ENGINE DIVISION

GENERAL MOTORS CORPORATION

FAN CHARACTERISTICS
 36 INCH - 8 BLADE x 3 1/16 INCH PROJECTED WIDTH

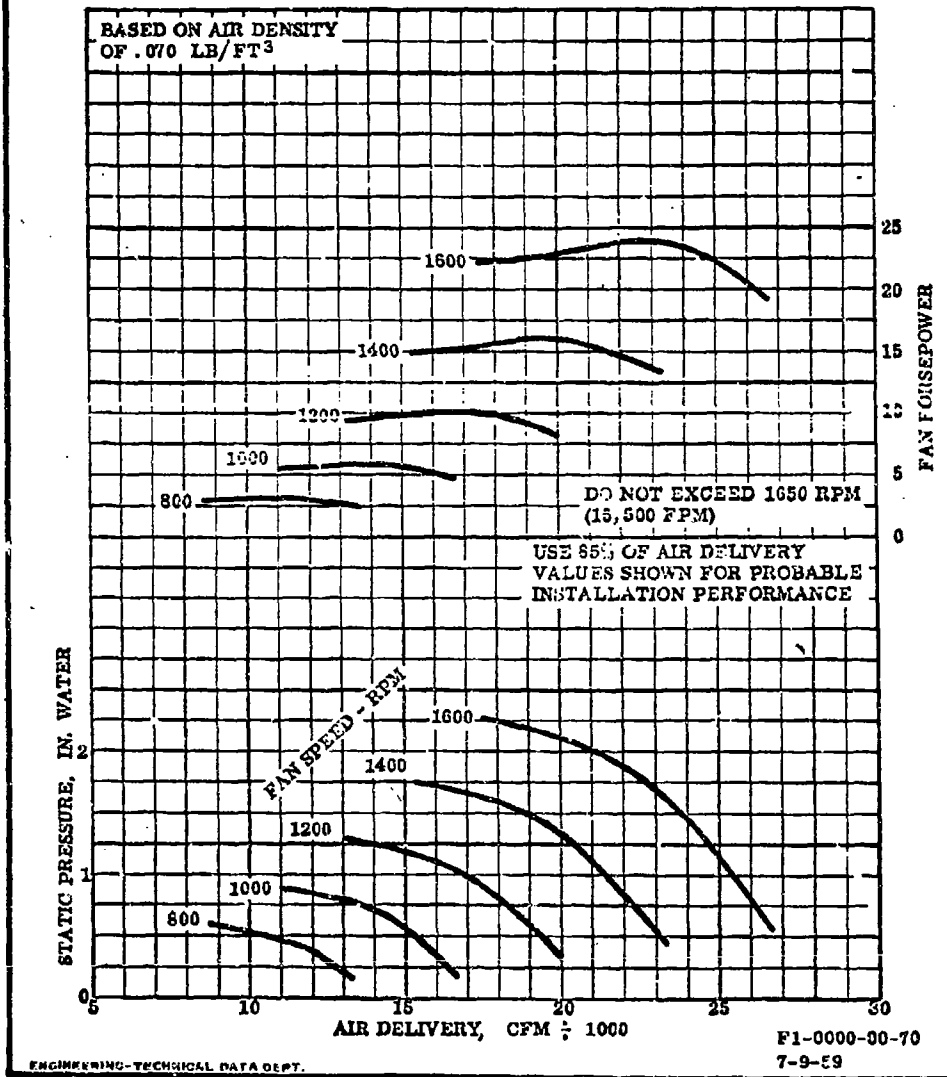

Figure B-45. Cooling Fan Performance Curve No. F1-0000-00-70



DETROIT DIESEL ENGINE DIVISION GENERAL MOTORS CORPORATION

FAN CHARACTERISTICS
48 INCH - 8 BLADE x 3 INCH PROJECTED WIDTH

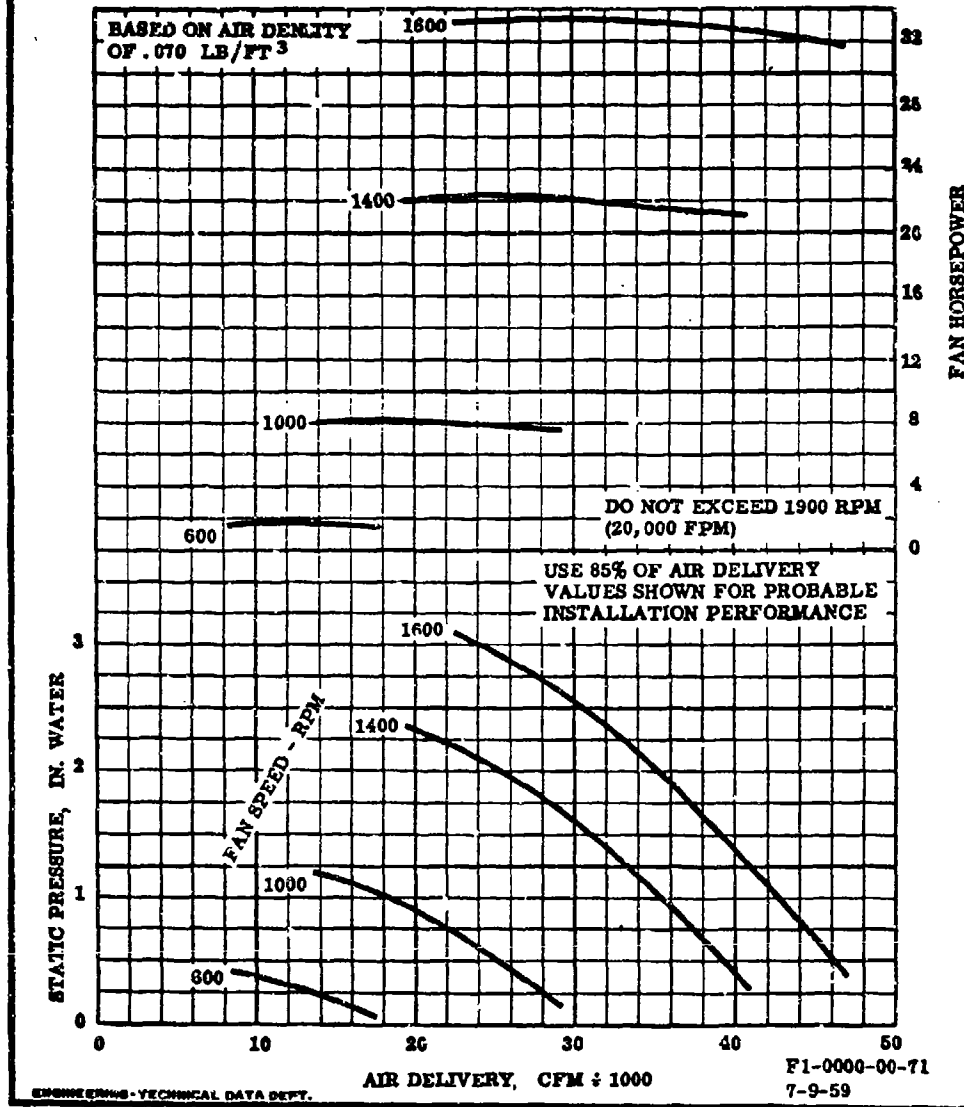

Figure B-46. Cooling Fan Performance Curve No. F1-0000-00-71

APPENDIX C

C-1 BALLISTIC GRILLE PERFORMANCE DATA

Graphs of ballistic grille airflow data are published to provide background information and assist the cooling system designer in the selection of the best grille design to satisfy particular vehicle requirements.

Graphs Figs. C-1 through C-5 provide information to aid in prediction of the grille air pressure drop when the grille area is established.

Graphs Figs. C-6 and C-7 present actual grille airflow restriction characteristics obtained by test.

AMCP 706-361

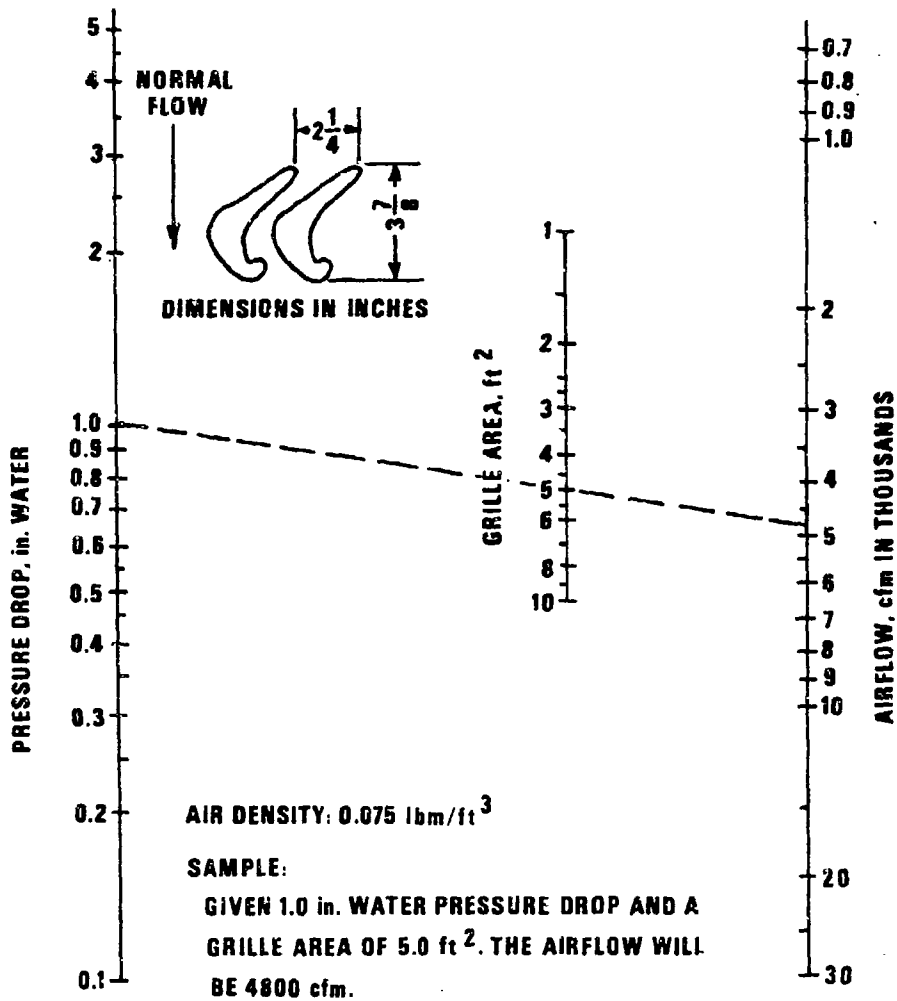

FOR CONDITIONS OTHER THAN STANDARD THE CORRECTED PRESSURE DROP ΔP_c IS

$$\Delta P_c = \Delta P \frac{\rho}{0.075} \text{ in. WATER}$$

WHERE ρ IS THE DENSITY OF THE AIR FLOWING

Figure C-1. Airflow Characteristics of No. 4 Louver Bar Grille, Full Size, Designed in WW II and Used in the M26 Tank (USATACOM)

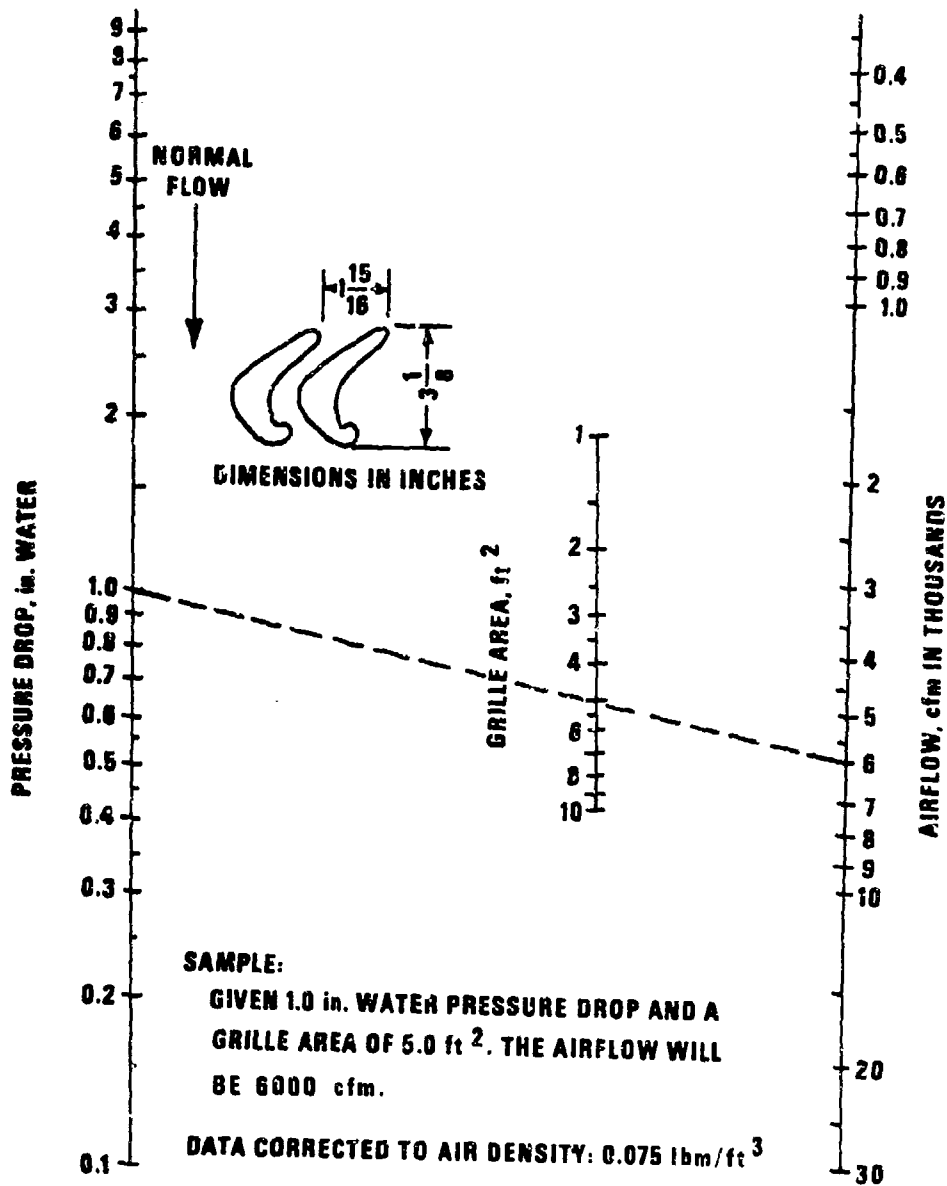

OR CONDITIONS OTHER THAN STANDARD THE CORRECTED PRESSURE DROP ΔP_c IS

$$\Delta P_c = \Delta P \frac{\rho}{0.075} \text{ in. WATER}$$

WHERE ρ IS THE DENSITY OF THE AIR FLOWING

Figure C-2. Airflow Characteristics of No. 4 Louver Bar Grille,
 3/4 Size, Used on the M103 Vehicle (USATACOM)

AMCP 706-361

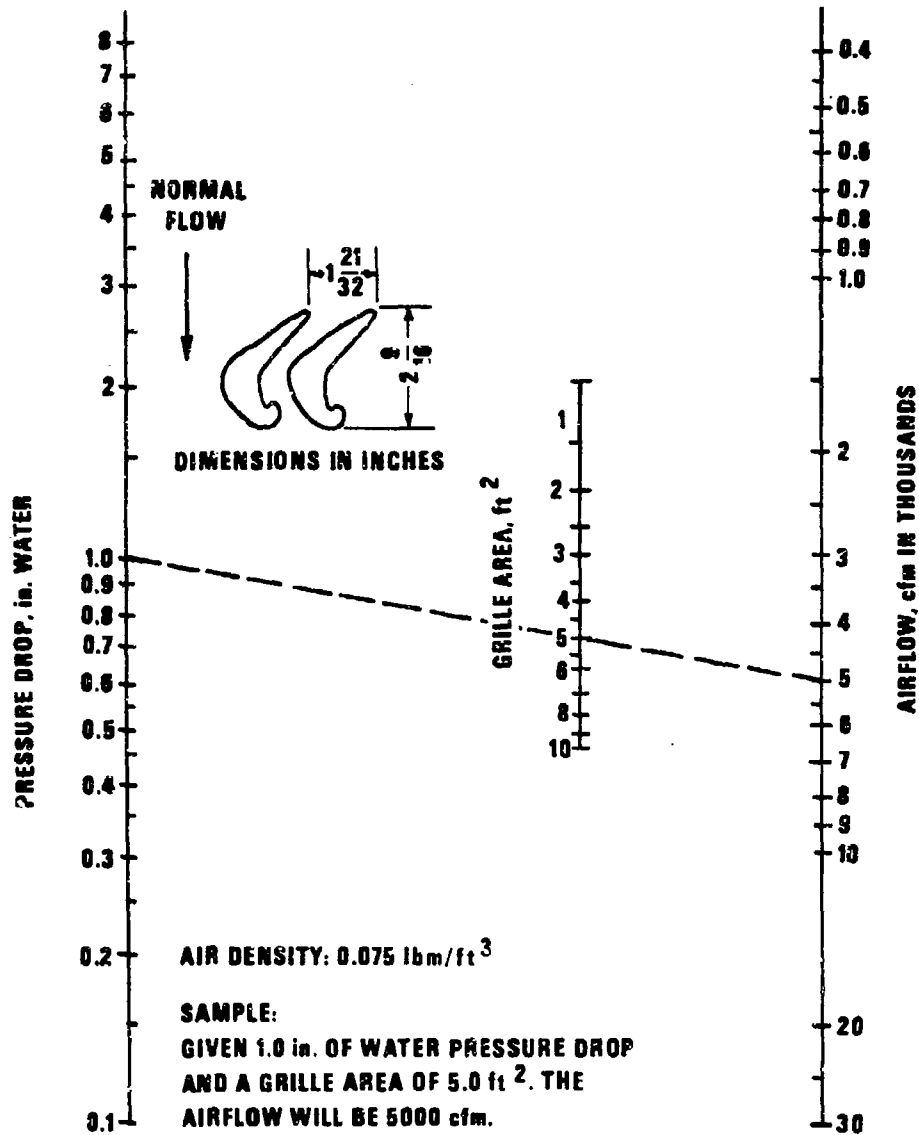

FOR CONDITIONS OTHER THAN STANDARD THE CORRECTED PRESSURE DROP ΔP_c IS

$$\Delta P_c = \Delta P \frac{\rho}{0.075} \text{ IN WATER}$$

WHERE ρ IS THE DENSITY OF THE AIR FLOWING

Figure C-3. Airflow Characteristics of No. 4 Louver Bar Grille, 2/3 Size, Used on M48 and M60 Tanks (USATACOM)

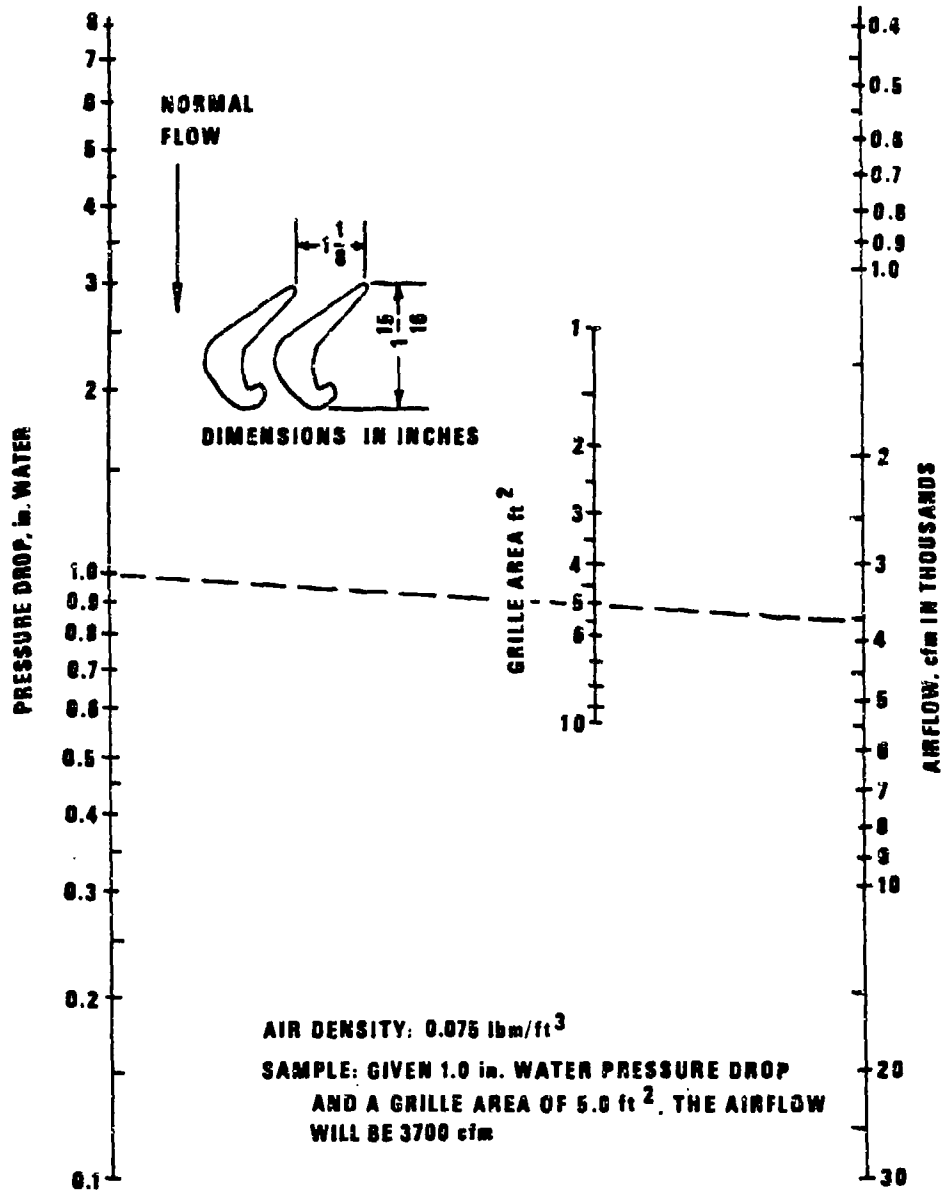

FOR CONDITIONS OTHER THAN STANDARD THE CORRECTED PRESSURE DROP ΔP_c IS

$$\Delta P_c = \Delta P \frac{\rho}{0.075} \text{ in. WATER}$$

WHERE ρ IS THE DENSITY OF THE AIR FLOWING

Figure C-4. Airflow Characteristics of No. 4 Louver Bar Grille, 1/2 Size, Used on the M41 Vehicle (USATACOM)

AMCP 706-361

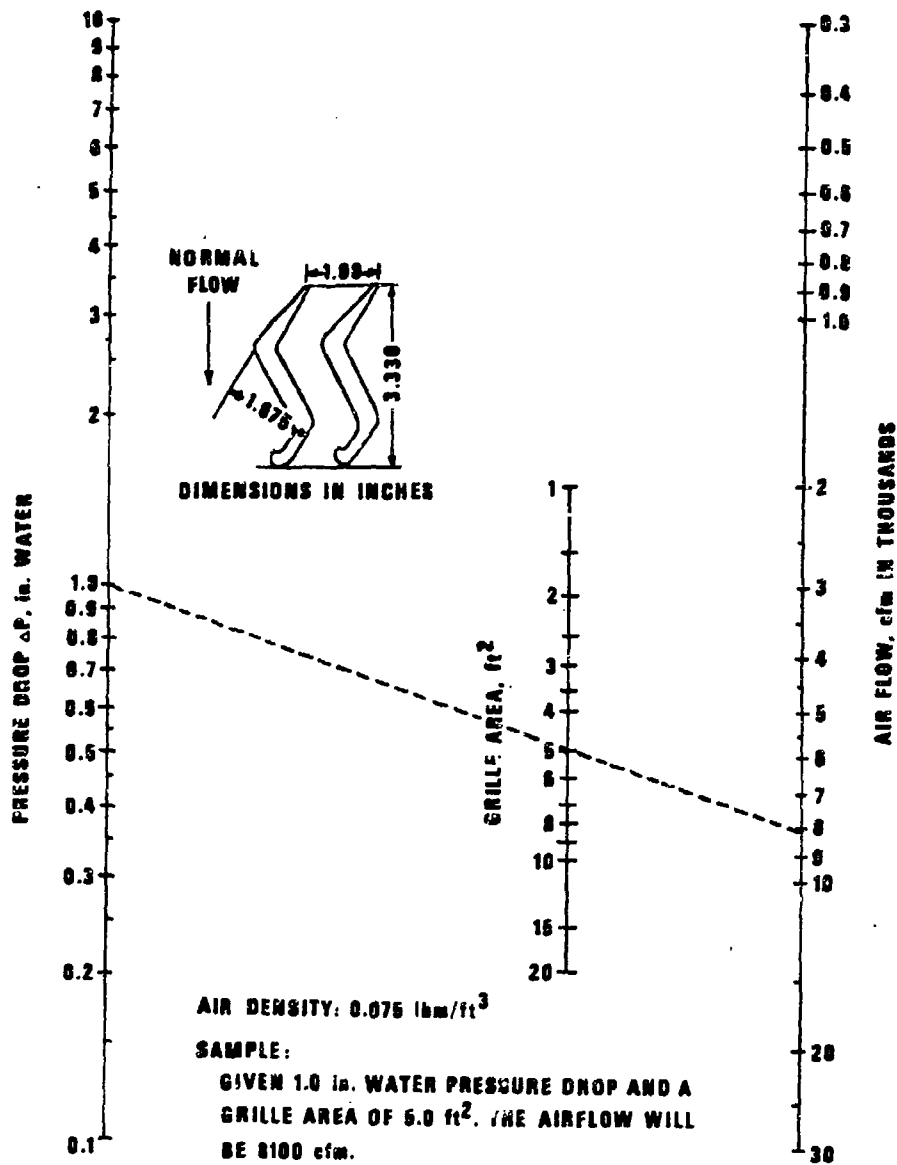

FOR CONDITIONS OTHER THAN STANDARD THE CORRECTED PRESSURE DROP ΔP_c IS

$$\Delta P_c = \Delta P \frac{D}{0.075} \text{ IN WATER}$$

WHERE D IS THE DENSITY OF THE AIR FLOWING

**Figure C-5. Airflow Characteristics of Chevron Type Grille
 (MBT70 Prototype Tank) (USATACOM)**

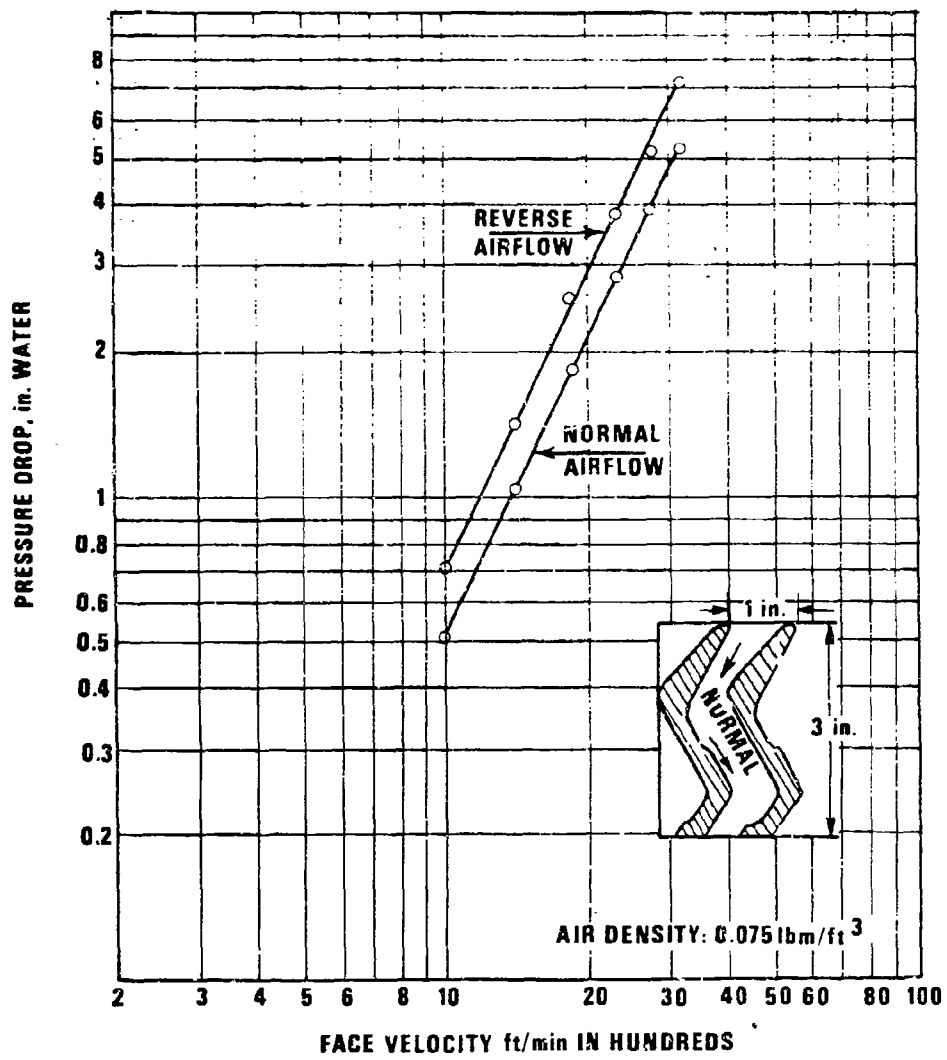

FOR CONDITIONS OTHER THAN STANDARD THE CORRECTED PRESSURE DROP ΔP_c IS

$$\Delta P_c = \Delta P \frac{\rho}{0.075} \quad \text{WATER}$$

WHERE ρ IS THE DENSITY OF THE AIR FLOWING

Figure C-3. Airflow Characteristics of M114 Grille Assembly (USATACOM)

AMCP 708-361

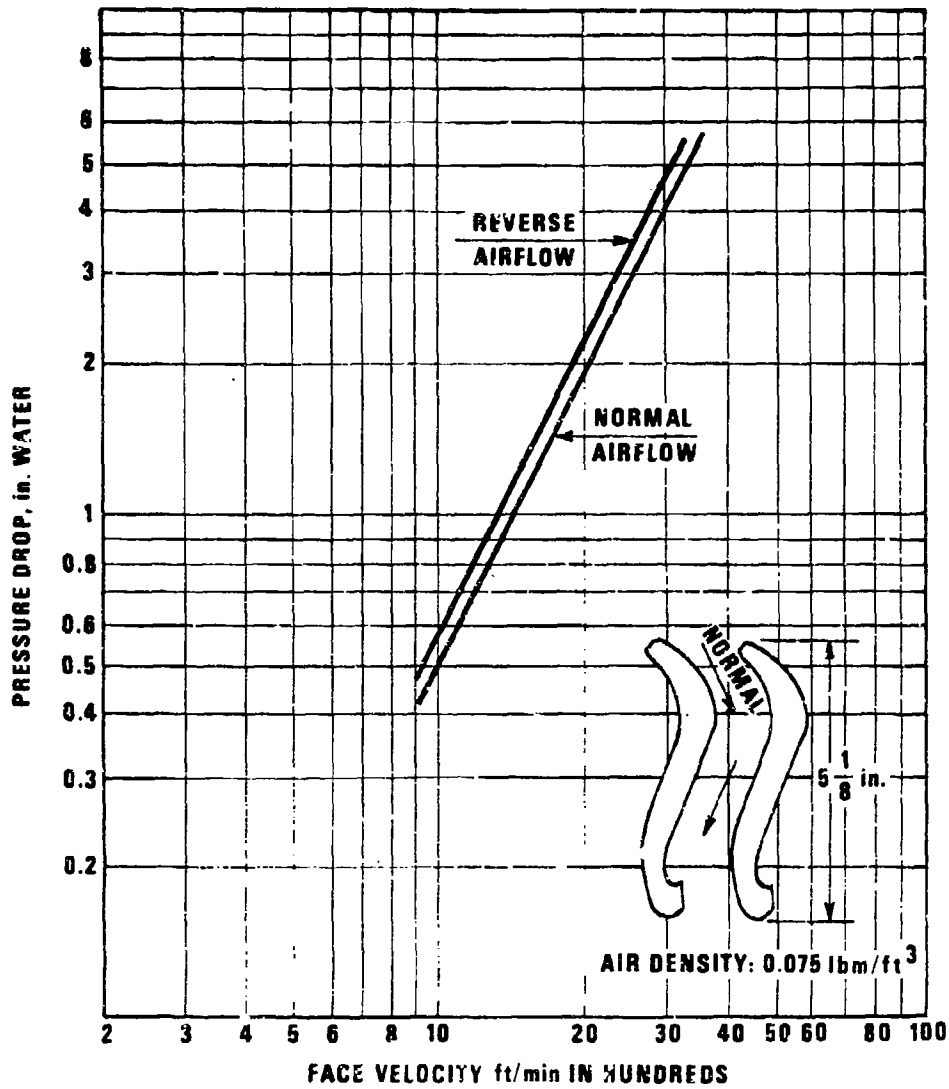

FOR CONDITIONS OTHER THAN STANDARD THE CORRECTED PRESSURE DROP ΔP_c IS

$$\Delta P_c = \Delta P \frac{\rho}{0.075} \quad \rho = \text{WATER}$$

WHERE ρ IS THE DENSITY OF THE AIR BLOWING

Figure C-7. Airflow Characteristics of M113 Grille Assembly (USATACOM)



APPENDIX D

D-1 RADIATOR TEST AND EVALUATION PROCEDURES

The radiator test and evaluation procedures that follow are taken from MIL-R-45306 (Ref. 18, Ch. 9).

D-1.1 TEST PROCEDURES

D-1.1.1 Conditions

The test conditions that follow shall apply during the tests performed in accordance with this specification on complete radiators and on radiator cores when they are furnished separately. Radiator cores tested separately shall be tested in fixtures which simulate, for test purposes, the top and bottom tanks.

D-1.1.2 Support

The radiator or core shall be supported on its normal points of support and shall not be supported on a cradle or bracket that in any way restrains the possible distortion of the radiator or core under pressure.

D-1.1.3 Equipment

The test part is mounted on a test stand. A flow pump and piping are used to provide water to the test sample from a reservoir. A circulating pump is used to maintain an even temperature in the water reservoir. A throttling valve is used to regulate the flow to the desired rate. A variable speed fan or adjustable dampers or louvers are used to regulate the airflow to the test sample.

D-1.1.4 Instrumentation

Instrumentation shall be provided to measure:

1. The temperature in the water lines of the inlet and outlet to the test sample
2. The water flow to the radiator
3. Airflow in the air duct (when an orifice is used to measure the airflow, a manometer shall be connected upstream from the orifice to indicate the static pressure in the duct)
4. The pressure drop or the resistance to airflow across the core
5. The temperature of the airflow on each side of the core.

D-1.1.5 Control Limits and Data Observations

The observed data shall be recorded. All points for each test shall be recorded only after all variables have been stabilized. The degree of stabilization and accuracy of observations are considered acceptable when the comparison between the air gain heat rejection and the water loss heat rejection does not exceed 5 percent.

D-1.1.6 Coolant

The coolant shall be water.

D-1.1.7 Coolant Temperatures

The temperature of the water entering the test section shall be between 170° and 210°F (180°F is normally used for the test).

D-1.1.8 Heat Rejection

The heat rejection test will be made using one of the following methods:

AMCP 708-381

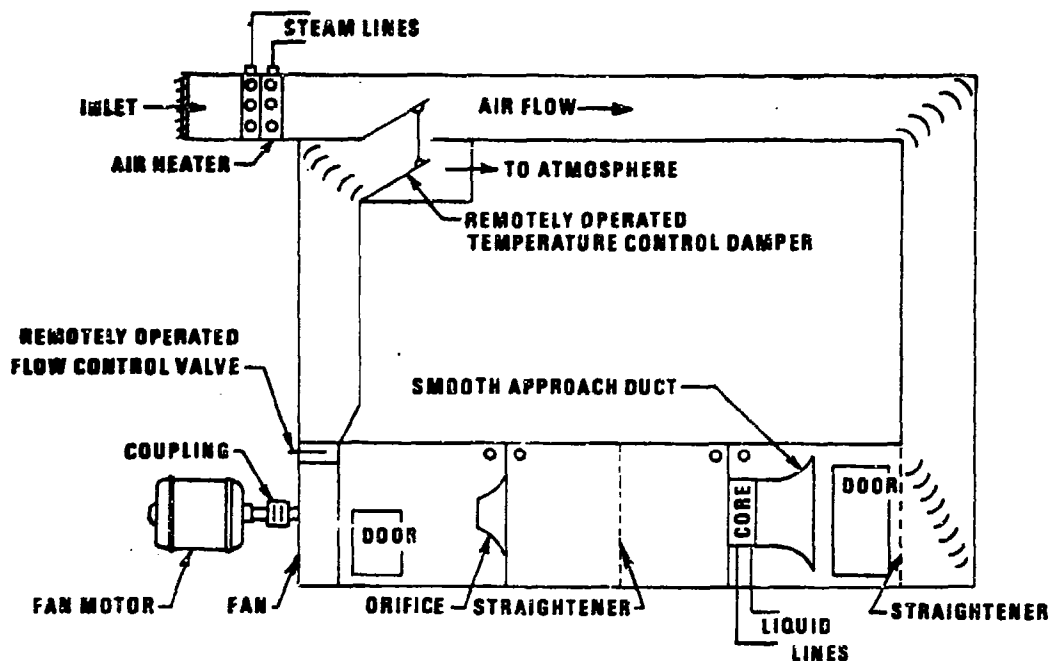

Figure D-1. Heat Exchanger Test Schematic Diagram

1. *Test Method.* The core section shall be tested in the wind tunnel as indicated in Fig. D-1, at 100 and 125 percent of the rated waterflow. If these selected values are not possible, the core shall be tested at not less than three waterflow rates within the 100 and 125 percent rate for each radiator size. At each waterflow rate, the heat rejection shall be determined at not less than four air velocities overlapping the range of 1500 to 2100 ft/min as indicated on MS35773-7. The heat rejected by the water and the heat gained by the air shall be calculated separately at each test condition. A performance curve shall be plotted. The heat rejection and core resistance values at 1500, 1800, and 2100 ft/min air velocity shall be taken from the performance curve and recorded on the qualification test data sheet. The difference between the test data and standard core data shall be checked.

2. *Alternate Test Method.* In order to

reduce the test work, and when the same core section is used for more than one radiator type and size, waterflow rates and air-velocity rates which overlap the entire range of required conditions shall be chosen for test points on the sample core. All air velocities shall be tested at each chosen waterflow rate. These results shall be plotted. The varying waterflow rates in gallons per minute can be plotted as a parameter on these curves. From these curves, a cross-plot can be made with heat rejection in Btu/minute as the ordinate, waterflow rates as the abscissa; and air velocity lines of 1500, 1800, and 2100 ft/min as the parameter. From this cross-plot, the required values can be obtained and recorded on the test data sheet. The data thus obtained shall be compared to the standard core values.

D-1.1.9 Airflow

Airflow through the test core section may be measured on either side.

D-1.1.10 Air-pressure-drop Corrections

The air-pressure-drop measurements shall be corrected to standard conditions by the following

$$\Delta P = \Delta P_m \left(\frac{\rho_o}{\rho_m} \right), \text{ in. water} \quad (D-1)$$

where

ΔP_m = measure pressure drop, in. water

ρ_m = inlet air density, lbm/ft³

ρ_o = standard air density, 0.075 lbm/ft³

D-1.1.11 Vibration

The radiator shall be filled with water for the vibration tests. The radiator shall be supported as specified in par. D-1.1.2 and securely fastened to a rigid mounting bracket that shall be bolted to the vibration table to ensure that the motion of the radiator shall be essentially the same as the motion of the platform. The radiator should be at a normal operating temperature and pressure. Means shall be provided for controlling the direction of vibration of the test machine, and for adjusting and measuring frequencies and amplitudes of vibration to keep them within prescribed limits.

D-1.2 TESTS

D-1.2.1 Heat Rejection and Core Resistance

The radiator or core shall conform to the requirements of the standard core based on rated heat rejection as defined in par. D-1.3. These values may be determined on a per square foot basis. These values shall then be corrected to the actual frontal area of the radiator.

D-1.2.2 Pressure Cycling

The complete radiator shall be tested with all outlets closed. Pressure, variable from atmospheric to 7 psig, shall be applied at the inlet using air or steam and shall be maintained at a temperature of at least 212°F during the test. When steam is used, means shall be provided to prevent the accumulation of water. The pressure cycling shall take place in 3 to 4 sec at a rate of 6 ± 1 pressure cycles/min. The radiator shall be cycled a minimum of 50,000 pressure cycles. The radiator shall be examined periodically for evidence of leakage or distortion. Only tube leaks and tube-to-header leaks, not to exceed three, shall be repaired or plugged before continuing the test. Any evidence of leakage or distortion of more than 1/8 in. shall constitute failure of this test.

D-1.2.3 Resonance Survey

The radiator which has been tested in accordance with par. D-1.2.2 may be rebuilt or another radiator may be used for this test. The radiator shall be tested for leakage prior to start of this test. The radiator shall be prepared in accordance with par. D-1.1.11 and vibrated at frequencies from 10 to 33 Hz at the displacement specified in Table D-1. If resonance occurs at any point in the specified range, the frequency of vibration at that point shall be the test conditions of par. D-1.2.4.

D-1.2.4 Vibration

This test shall be run after completion of par. D-1.2.3, if no leaks are observed. The radiator shall be vibrated for not less than 24 hr at the most critical resonant frequency. If no resonance was observed, this test shall be performed at 33 Hz at the displacement referenced in Table D-1. The radiator shall be examined periodically during the test for evidence of seepage and leakage. At the completion of the 24-hr test, any evidence of

AMCP 706-351

TABLE D-1

TABLE DISPLACEMENTS

FREQUENCY RANGE, Hz	TOTAL TABLE DISPLACEMENT, in.
10 to 15	0.060 ± 0.006
16 to 25	0.050 ± 0.005
26 to 33	0.040 ± 0.005

structural damage, seepage, or leakage shall constitute failure of this test.

D-1.3 DEFINITIONS

For the purpose of this specification, the following definitions shall apply:

1. *Rated Internal Pressure.* Shall be 7 psig for Military Standards MS35773-1 through -10.

2. *Standard Air.* Shall be at a temperature of 70°F, 29.92 in. Hg barometric pressure, and a density of 0.075 lbm/ft³.

3. *Rated Coolant Flow.* Shall be the flow listed for the particular radiator to be tested and shall be based on approximately a 10 deg F drop in coolant temperature in the radiator.

4. *Air Gain-Heat Transfer.* The air gain-heat transfer Q_a is

$$Q_a = w_a C_p \Delta T_a, \text{ Btu/min} \quad (\text{D-2})$$

where

C_p = specific heat of air, 0.24 Btu/lbm-°F (up to 215°F)

w_a = cooling airflow, lbm/min

ΔT_a = air temperature rise, °F

5. *Water Loss-Heat Transfer.* The water-

loss heat Q_w is

$$Q_w = w_w C_p \Delta T_w, \text{ Btu/min} \quad (\text{D-3})$$

where

C_p = specific heat of water, 1.0 Btu/lbm-°F (up to 215°F)

w_w = water flow, lbm/min

ΔT_w = water temperature drop, °F

6. *Average Coolant Temperature.* The sum of the coolant inlet and outlet temperatures shall be divided by 2.

7. *Rated Potential.* The average water temperature minus the entering air temperature, and shall have a value of 80 deg F.

8. *Observed Potential.* The observed average water temperature minus the observed entering air temperature during the heat rejection and core resistance test.

9. *Rated Heat Rejection.* The total observed heat rejection in Btu/min times the rated potential divided by the observed potential.

10. *Resonance.* A condition of maximum magnification of an applied vibration. It usually is manifested by visibly increased vibration of the radiator under test.

D-2 ENGINE/TRANSMISSION OIL COOLER TEST SPECIFICATION AND PROCEDURE

D-2.1 OIL-TO-AIR COOLER

D-2.1.1 Specifications

The following is an example of data taken from a detail drawing of an oil-to-air cooler and constitutes the performance and endurance specifications the component must meet:

<u>Oil Side</u>	<u>Engine</u>	<u>Trans- mission</u>
Oil Type	SAE 50	SAE 10
Heat Rejection, Btu/min	8000	10,000
Flow, lbm/min	512	608
Inlet Temperature, °F	280	300
Outlet Temperature, °F	250	268
Pressure Drop, psi	12.5	12
Working Pressure, psi	150	150
<u>Air Side</u>		
Flow, lbm/min	320	390
Flow (at 0.0683 lbm/ft ³), cfm	8052	8052
Inlet Temperature, °F	120	120
Outlet Temperature, °F	224	227
Outlet Pressure, in. Hg, Abs	29.92	29.92
Pressure Drop, in. water	6.5	6.5

Endurance Specifications. Must withstand 600 psi hydrostatic pressure for 1 min without failure. Must endure a test of 15,000

cycles at a rate of 18 – 19 cycles/min, with oil pressure varying 0 – 375 psi/cycle. The unit may be out of square 0.06 in./ft in any plane.

D-2.1.2 Test Procedure

D-2.1.2.1 Heat Rejection

The test conditions for temperature, pressure, flow rate, and grade of oil are given in par. D-2.1.1.

The oil side temperatures and pressures are measured at the cooler inlet and outlet. The thermocouples should be installed so that their measuring tips are in the center of the oil stream and do not contact the metal sides of the flow passages nor restrict the flow. The fittings for the pressure gage should not protrude beyond the inside diameter of the flow passage, i.e., should offer no resistance to the oil flow. The oil flow is measured by means of a calibrated flow orifice installed in the inlet line to the cooler.

If a thermostatic bypass is an integral part of the cooler, it should be blocked shut to eliminate any possibility of leakage occurring during the heat rejection tests.

An auxiliary oil pump supplies the required flow to the cooler. The oil then flows from the cooler to an auxiliary heat exchanger and then back to the auxiliary pump.

D-2.1.2.2 Air Side Measurements

Air side measurements are made as outlined in par. D-1 for radiator airflow. The test schematic diagram in Fig. D-1 is applicable for oil-to-air coolers.

D-2.1.2.3 Heat Balance

To calculate the heat balance, the same procedure is used for oil as air as illustrated in par. D-1.3, Items No. 4 and 5. The specific heat for oil varies with temperature. A

specific heat chart for a representative aircraft engine oil is shown in Fig. 3-45.

D-2.1.2.4 Pressure Test

The cooler hydrostatic pressure test is conducted by filling the cooler with oil, blocking off the inlet and outlet with pipe plugs, and connecting a hydraulic hand pump to the system through a pressure tap in one of the pipe plugs. The system is pumped to the required pressure and the cooler observed for leaks for the required time period. This test can be dangerous. Safety glasses must be worn when inspecting the pressurized cooler.

D-2.1.2.5 Cyclic Test

The cyclic test is conducted by using an auxiliary pump to supply the necessary oil to the cooler. The required cycle can be maintained by cycling the power supply to the auxiliary oil pump or bypassing the oil flow around the cooler through an automatic bypass system. The pressure and temperature of the oil should be monitored, and an auxiliary oil cooler added to the system as required. An oscillograph trace of a cycle pressure test is shown in Fig. D-2.

D-2.2 OIL-TO-WATER COOLER

D-2.2.1 Specifications

The following is an example of data taken from a detail drawing of an oil-to-water cooler and constitutes the performance and endurance specification the component must meet:

1. For the purpose of qualification under the specification, the prospective supplier shall submit five (5) samples of the cooler. These samples properly marked with identifying information shall be forwarded to the place designated by the procuring agency for approval. For qualification acceptance, coolers shall withstand a minimum of 500,000 hydraulic pressure cycles or from 0 to 300 psi at the rate of 13 to 20 cycles per

min with SAE No. 10 oil at 170° to 200°F without leakage. This is a destructive test.

2. Rated performance:

- a. SAE Grade 30 Oil
- b. 150°F "Oil In" temperature
- c. 42.5 psi oil pressure drop at 30 gpm
- d. 85°F "Water In" temperature
- e. Heat transfer and Pressure drops as installed in the 1161851 Housing and 11641853 Cover:

Waterflow, gpm	Oil Flow, gpm	Heat Rejection, Btu/min
50	15.0	1040
	27.5	1450
75	15.0	1110
	27.5	1570
92	15.0	1150
	27.5	1620

Coolers also shall be checked for performance requirements as listed.

3. Production Requirements. All units must be subjected to a leak test of 150 psi air pressure with the cooler immersed in liquid at 120° to 140°F to detect porosity and pin hole leaks. No leakage is permitted.

4. Production Endurance Test. Coolers selected at random from a production lot must withstand a minimum of 250,000 hydraulic pressure cycles of from 0 to 300 psi at the rate of 13 to 20 cycles per min with SAE No. 10 oil at 170° to 200°F without leakage. This is a destructive test. Coolers subjected to this test shall be scrapped after test.

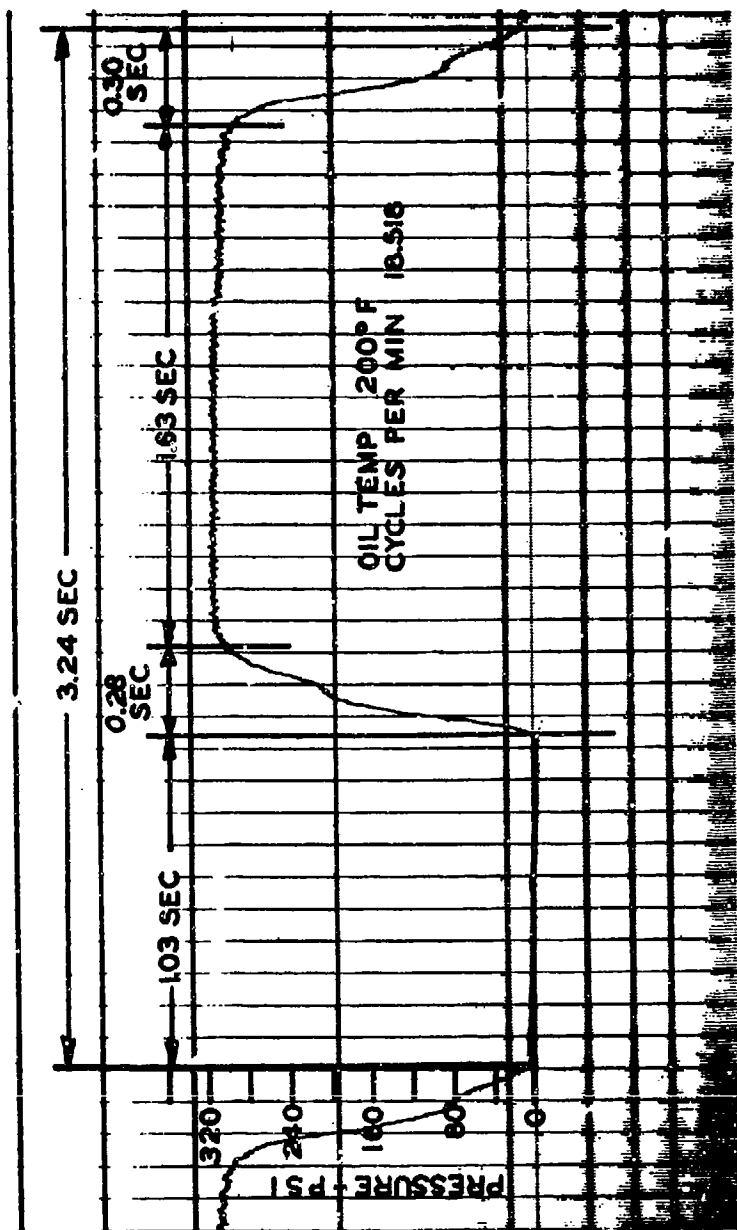

Figure D-2. Typical Pressure Cycle for Oil Cooler Test (Ref. 5)

AMCP 706-361

D-2.2.2 Test Procedure

D-2.2.2.1 Heat Rejection

1. The temperature, pressure, flow rate, and grade of oil are all given in par. D-2.2.1.
2. The procedure for oil side measurements are outlined in par. D-2.1.2.1.
3. Water side procedures are outlined in par. D-1 for radiator water flow.

D-2.2.2.2 Heat Balance

The heat balance is as discussed in par. D-2.1.2.3. The applicable values of specific heat are applied. To obtain an accurate heat balance, the water side thermocouples must be very accurately calibrated since the ΔT on the water side is small.

D-2.2.3 Pressure Test

See par. D-2.1.2.4.

D-2.2.4 Cyclic Test

See par. D-2.1.2.5.

D-3 FAN PERFORMANCE TEST PROCEDURE (Refs. 13 and 15, Chapter 9)

Fan performance tests are carried out in accordance with the Air Moving and Conditioning Association (AMCA) Standard 210-67, *Test Code for Air Moving Devices (AMD)*. Applicable portions of AMCA Standard 210-67 are contained in the paragraphs that follow.

D-3.1 TEST SET-UP AND EQUIPMENT

D-3.1.1 General

All ducts essentially shall be straight and of circular cross section except where otherwise specified. See Fig. D-3(B) for tolerances at the

traverse section for location of pitot tubes.

Some test setups employ an auxiliary fan because the fan under test may not be able to supply the pressure needed to overcome the losses in the measuring device and associated ductwork. This is particularly true whenever performance at or near free delivery is required. The auxiliary fan must have the capacity to supply the additional pressure rise required to overcome losses due to ductwork, nozzles, etc.

A plenum chamber is necessary whenever low velocity, uniform flow is required upstream of the measuring device as when multiple airflow nozzles are used (See Fig. D-4). The use of a plenum chamber as part of the test setup also is required whenever it is necessary to test without ductwork directly connected to the test fan as shown in Fig. D-5.

There shall be no draft in the test room that creates an appreciable velocity (e.g., 200 ft/min) at the test ambient measuring condition, with the test AMD not operating.

D-3.1.2 Test Instruments

D-3.1.2.1 Pressure Measuring Instruments

The standard instrument for measuring static pressure, velocity pressure, and pressure differential is the liquid-in-glass manometer. Precision grade glass tubing or precision drilled solid plastic should be used. The liquid should have low viscosity and low surface tension. Pressures below 2 in. water shall be read on an inclined manometer. The two types of manometers commonly used are described as follow:

1. *Inclined Manometer.* The slope shall be such that the distance between 0 and 1 in. on the scale shall be at least 4 in. and not more than 10 in. Scale divisions for pressures below 2 in. water shall be 0.01 in. water or finer and

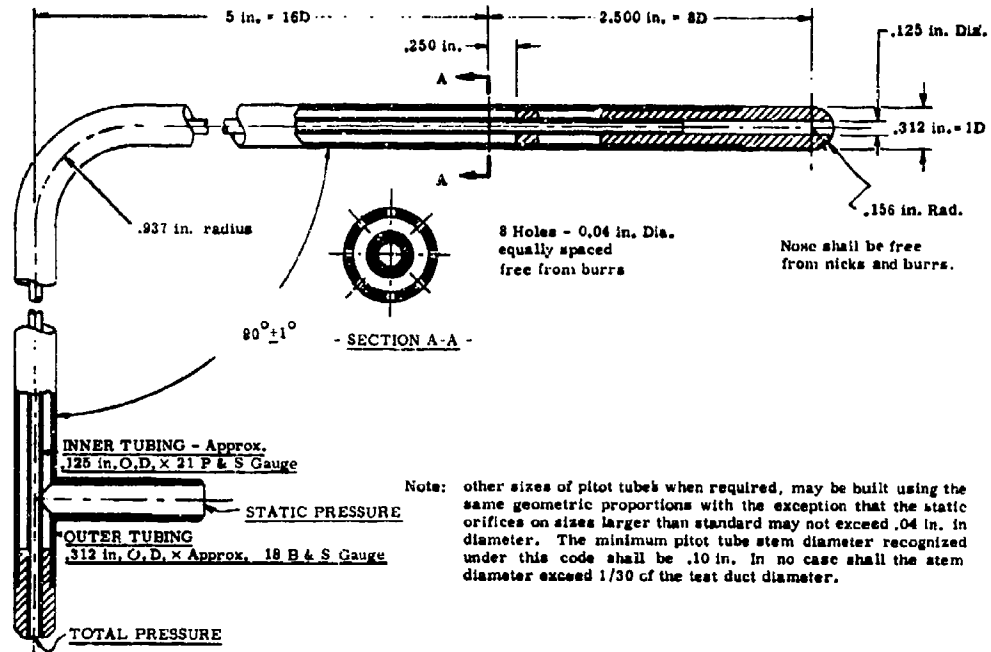

(A) AMCA STANDARD PITOT TUBE

All pitot positions $\pm \frac{1}{4}R$,
 relative to wall
 $R = \frac{D}{2}$

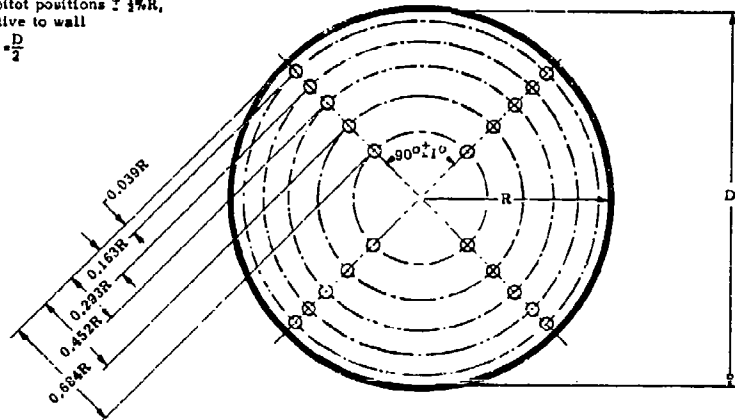

D is the average of four measurements at traverse plane at 45° angles measured to accuracy of 0.2% D. Traverse duct shall be round within $\pm \frac{1}{4}\%$ D at traverse plane and for a distance of $\frac{1}{2}$ D on either side of traverse plane.

(B) AMCA TRANSVERSE POINTS IN DUCT

*Figure D-3. Tolerances for Location of Pitot Tubes
 (Courtesy of Air Moving and Conditioning Association)*

AMCP 708-361

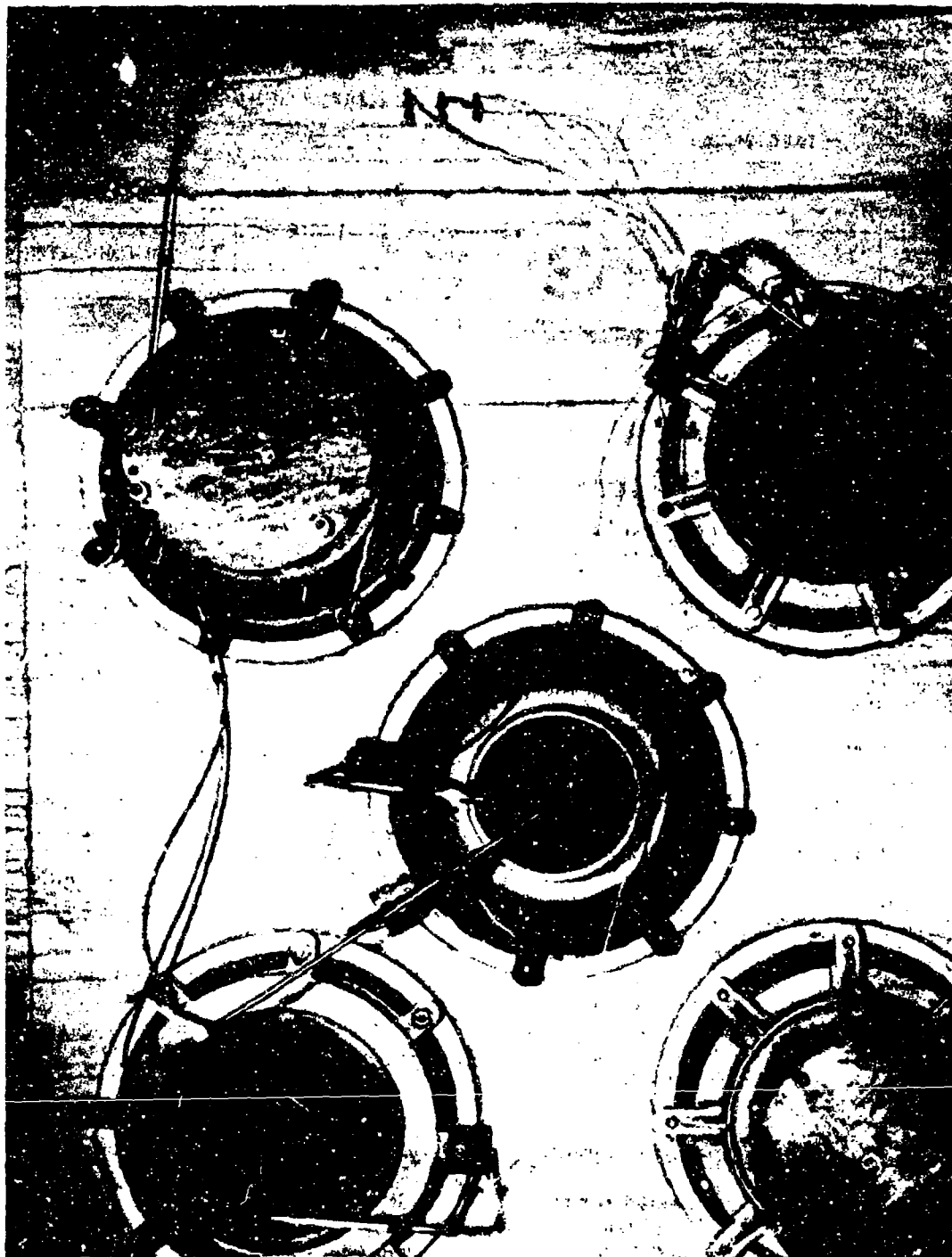

Figure D-4. Multiple Airflow Nozzles for Airflow Test Measurement (USATACOM)

D-10

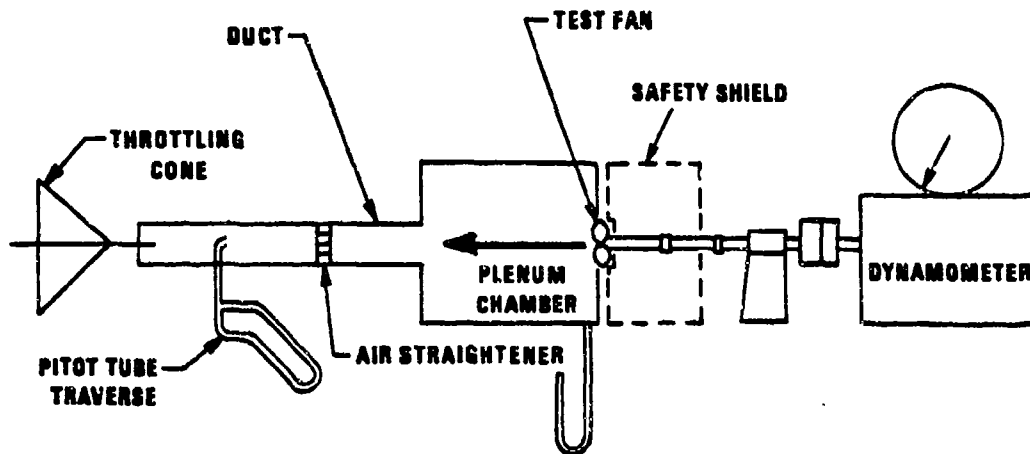

Figure D-5. Cooling Fan Performance Test Schematic Diagram

for 2 in. water or greater shall be 0.1 in. water or finer. A calibration shall be made for at least 8 points over the range from 0 to 2 in. water. A comparison shall be made with a water filled hook gage or high quality micromanometer accurate to 0.001 in. Above 2 in. water, calibration shall be made at approximately 0.5 in. water intervals

2. *Vertical Manometers.* For U-tubes, the difference in height of the two liquid columns under differential pressure shall be read. Reading only the change in one leg and multiplying by two is not acceptable. Scale divisions shall be 0.1 or finer. Water filled U-tubes need only be calibrated by checking the scale with a machine divided scale. Those filled with other liquids shall be calibrated by comparison with a water filled U-tube. A check shall be made that the legs are vertical. Reservoir type manometers shall be calibrated by comparison with a water filled U-tube, high-quality micro-manometer, or a hook gage.

D-3.1.2.2 Power Measuring Instruments

The cradle type dynamometer, motor, or torsion meter, carefully calibrated, may be

used for all power measurement. Electric meters shall be accurate to within 0.5 percent of full scale. Readings shall not be taken below a value of 20 percent of full scale. To ensure this accuracy, power measuring instruments should be recalibrated periodically. Preferably, the same meters should be used for test as for motor calibration.

D-3.1.2.3 Speed Measuring Instruments

Instruments for speed measuring shall have a demonstrated accuracy within 0.5 percent of the value being measured, or within 2 rpm, whichever is greater. Tachometers and revolution counters with chronometers are acceptable.

D-3.1.2.4 Temperature Measuring Instruments

Instruments for temperature measurements shall have a calibrated accuracy within 1 deg F and shall have scale divisions of 1 deg or finer.

D-3.1.2.5 Barometric Pressure Measuring Instruments

Mercury barometers with scale divisions of

AMCP 706-71

0.10 in., or finer, and vernier scale readable to within 0.01 in. shall be used.

D-3.1.2.6 Pitot Tube

The pitot tube shall be in accordance with Fig. D-3(A).

D-3.2 OBSERVATIONS

Readings of pressure, power input, rpm, temperatures, and barometric pressure shall be taken for each determination. Barometric pressure and temperatures shall be measured at least three times during each determination except that on airflow nozzle tests only one reading of each of the test values is required.

When successive determinations indicate a variation of less than 0.10 in. Hg and 2 deg F for barometric pressure and temperature, respectively, one set of readings at the midpoint of each determination shall suffice. The chamber pressure shall be held substantially constant during each determination for all tests. Dry-bulb and wet-bulb temperature readings shall be taken in the path of inflowing air. On multiple outlet units, readings shall be taken concurrently on all outlets.

When speed is required with ± 0.5 percent, or within 2 rpm, whichever is greater, three readings of the AMD rpm and power input shall be taken during each determination except for airflow nozzle tests where only one reading is required; otherwise, separate readings of AMD rpm and power input shall be taken simultaneously with each pressure reading. If speed variation during a determination exceeds 1 percent of the average, the determination shall be voided.

Before and after daily test observations, inclined manometers shall be checked for proper calibration by checking at zero and one representative pressure of 0.5 in. water or more using a water filled hook gage or a high-quality micromanometer accurate to

0.001 in. Vertical manometers also shall be checked before and after the test at zero and one representative pressure. The manometer shall not be moved during the test unless the same checking procedure is used before and after movement.

The velocity at the place of measurement, where airflow nozzles are used, shall not be less than 2500 ft/min (approximately 0.4 in. water pressure drop) at the maximum volume flow of test. This value also is recommended for pitot traverse methods.

D-3.3 TEST METHOD

The AMD is connected and externally sealed to a plenum chamber which is connected to a 2-ft duct 10 fan diameters long. A pitot traverse tube (see Fig. D-3) is positioned 8.5 diameters from the plenum. The power take-off is connected to a motor dynamometer. Pitot tube readings are taken at various AMD speeds along with dynamometer input horsepower and static pressure in the plenum. Temperature measurements are taken at the pressure pick-up points for density corrections. Table D-2 shows values for density of saturated and partly saturated air.

D-3.4 RESULTS

AMD performance is a statement of flow rate *CFM*, static pressure change ΔP_s , or total pressure change ΔP_t , fan *HP*, total efficiency η_t , *RPM* at a stated inlet air density ρ , and may include the calculated value of static efficiency η_s . A typical constant speed performance curve is shown in Fig. D-6.

D-4 COOLANT PUMP TEST (Ref. 17, Chapter 9)

Testing of coolant pumps to determine performance and endurance characteristics may be conducted as illustrated by the test reports that follow.

TABLE D-2

**DENSITY OF SATURATED AND PARTIALLY SATURATED AIR FOR VARIOUS
 BAROMETRIC CONDITIONS**

Dry Bulb Temp, °F	Density Of Saturated Air, lbm/ft ³					
	Barometric Pressure, in. Hg					
	28.5	29.0	29.5	30.0	30.5	31.0
30	0.0770	0.0784	0.0797	0.0811	0.0825	0.0838
35	0.0762	0.0776	0.0789	0.0802	0.0816	0.0829
40	0.0754	0.0767	0.0781	0.0794	0.0807	0.0821
45	0.0746	0.0759	0.0772	0.0786	0.0799	0.0812
50	0.0738	0.0751	0.0764	0.0777	0.0790	0.0803
55	0.0730	0.0743	0.0756	0.0769	0.0782	0.0795
60	0.0722	0.0735	0.0748	0.0761	0.0773	0.0786
65	0.0715	0.0727	0.0740	0.0753	0.0765	0.0778
70	0.0707	0.0719	0.0732	0.0744	0.0757	0.0769
75	0.0699	0.0711	0.0724	0.0736	0.0748	0.0761
80	0.0691	0.0703	0.0716	0.0728	0.0740	0.0752
85	0.0683	0.0695	0.0707	0.0719	0.0732	0.0744
90	0.0675	0.0687	0.0699	0.0711	0.0723	0.0735
95	0.0667	0.0679	0.0690	0.0702	0.0714	0.0726
100	0.0658	0.0670	0.0682	0.0694	0.0706	0.0717

NOTE: The approximate average density decrease per 0.10 deg rise in dry bulb temperature is 0.00017 lbm/ft³.
 (See Chapter 4 for density values of dry air)

AMCP 706-281

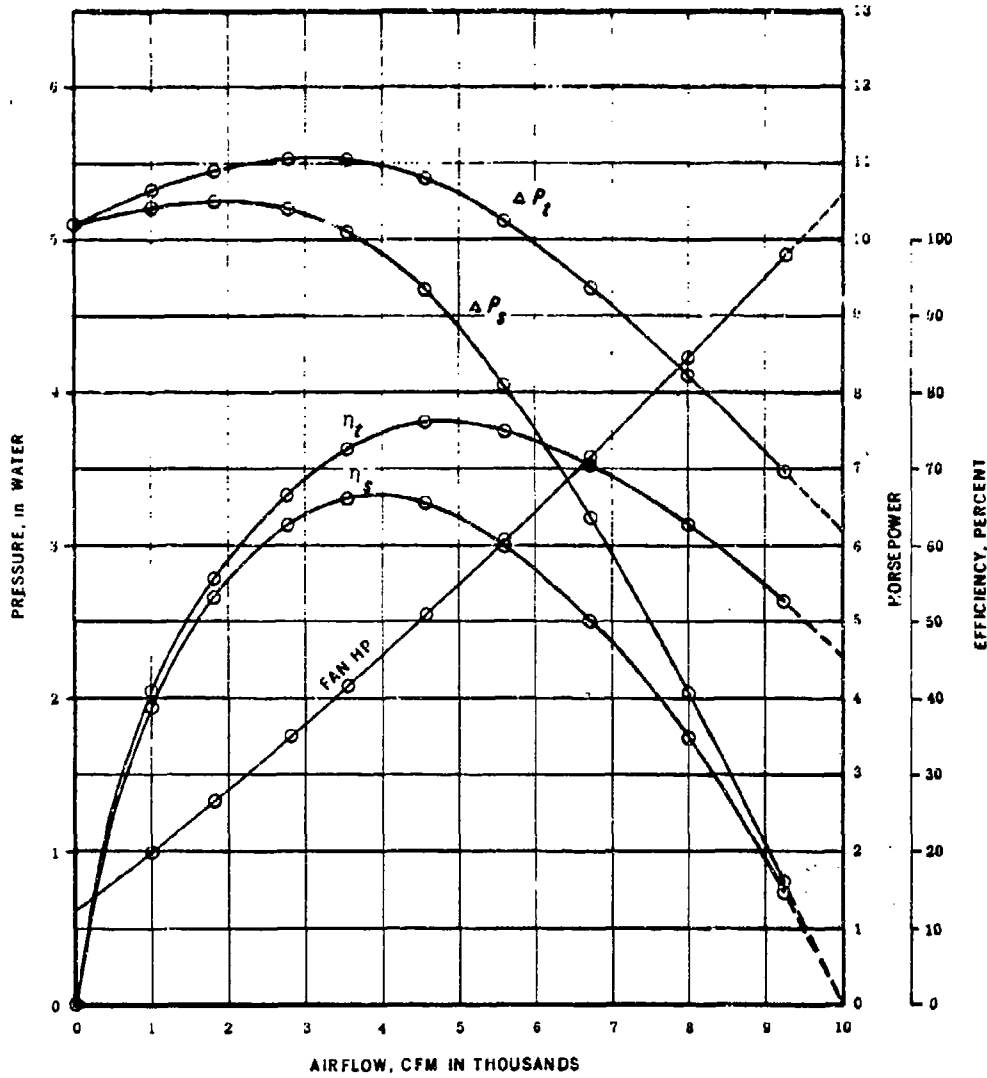

AMD Model Number Type Per Drawing No
 Wheel Diameter Outlet Area RPM Density
 AMCA Test Code Figure No Name of Lab

Figure D-6. Typical AMD Performance Curve
 (Courtesy of Air Moving and Conditioning Association)

D-4.1 OBJECTIVE

Conduct a 200-hr laboratory test to compare the performance and endurance characteristics of two Rock Island Army Arsenal coolant pumps with two Field Service coolant pumps, Part No. 7034646.

D-4.2 TEST EQUIPMENT

1. Hydraulic motor
2. Torque pickup, 0-500 lbf-in.
3. Brush analyzer
4. Brush penmotor
5. Hand tachometer, 0-4000 rpm
6. Thermometer, mercury in glass, 32°-200°F
7. Vacuum gage, 0-30 in. Hg
8. Pressure gage, 0-30 psi
9. Flowmeter.

D-4.3 TEST MATERIAL

The two Rock Island Army Arsenal coolant pumps are identified as No. 1 and No. 2, and the two Field Service coolant pumps are identified as No. 3 and No. 4.

D-4.4 TEST PROCEDURES

1. The following pump data were recorded:
 - a. Delivery, gpm
 - b. Input shaft speed, rpm
 - c. Main pulley shaft speed, rpm
 - d. Input torque, lbf-in.

- c. Water temperature, °F
- f. Inlet vacuum, in. Hg
- g. Outlet pressure, psig
- h. Bypass pressure, psig.

2. Prior to endurance testing, a performance test on each individual pump was accomplished in the following manner:

- a. Belts were removed from all pumps except the pump tested.
- b. Belt tension was adjusted to required value.
- c. Pumps were run at 2000 rpm.
- d. Data listed in test procedure were recorded.

3. Performance tests were made at the following intervals during the endurance test: 31-2/3, 52, 96, 150, and 216 hr.

4. Lubrication level in the grease cup was checked after each performance test.

5. Water temperature was maintained at 150° to 160°F.

D-4.5 RESULTS

A fluid flowmeter was installed in the test setup at 31-2/3 hr of running time. This caused a large reduction in flow due to a 100 percent increase in the discharge line restriction. The flow rates at zero hour were obtained by weighing the test fluid (water).

The running torque of pump No. 1 increased by 12.5 percent at 52 hr and by 75 percent at 216 hr. Upon completion of 216 hr, pump No. 1 was disassembled and inspected. It was discovered that the pump lacked bearing lubrication. The reason for the

AMCP 706-381

lack of lubrication at the bearing was not determined. The remaining three coolant pumps completed the 216 hr of testing without incident.

D-4.6 CONCLUSION

Except for the lubrication deficiency, performance and endurance features of the two pumps were similar.

D-5 XM803 EXPERIMENTAL TANK HOT MOCK-UP INSTRUMENTATION LIST AND SCHEMATIC DIAGRAMS

D-5.1 INDUCTION AIR

D-5.1.1 Air Temperatures and Pressures

1. Before airflow meters
2. At entrance to left vehicle air cleaner
3. At entrance to right vehicle air cleaner
4. Exit left cleaner (entrance to left turbo compressor)
5. Exit right cleaner (entrance to right turbo compressor)
6. After left compressor
7. After right compressor
8. In left bank intake manifold
9. In right bank intake manifold.

D-5.1.2 Miscellaneous

1. Left bank airflow meter
2. Right bank airflow meter.

D-5.2 LUBRICATION SYSTEM

D-5.2.1 Oil Temperatures

1. From left turbocharger.

2. From right turbocharger.

D-5.2.2 Oil Pressures

1. In main gallery
2. To left turbocharger
3. To right turbocharger
4. To oil filter
5. From oil filter.

D-5.2.3 Oil Temperatures and Pressures

1. Out of engine (oil to cooler) left bank
2. Into engine (oil from cooler) left bank
3. Out of engine (oil to cooler) right bank
4. Into engine (oil from cooler) right bank.

D-5.3 COOLING AIR SYSTEM

D-5.3.1 Temperatures

1. Before inlet grille, flywheel, and damper ends
 - a. Left bank
 - b. Right bank.
2. Before and after left oil-cooler
 - a. Bottom at flywheel end
 - b. Top at damper end.
3. Before and after right oil-cooler
 - a. Bottom at flywheel end
 - b. Top at damper end.
4. Before and after left aftercooler
 - a. Bottom at flywheel end

- b. Top at damper end.
- 5. Before and after right aftercooler
 - a. Bottom at flywheel end
 - b. Top at damper end.
- 6. Before and after cylinders 1, 3, and 6 at head barrel junction
 - a. Left
 - b. Right.
- 7. Above
 - a. Rear fan
 - b. Front fan.
- 8. In vehicle outlet duct, left and right sides
- 9. In duct after vehicle exit grille, left and right sides averaged.

D-5.3.2 Pressures

- 1. Before inlet grille, front and rear averaged
 - a. Left
 - b. Right.
- 2. After inlet grille, front and rear
 - a. Left
 - b. Right.
- 3. Before oil-cooler, at top front
 - a. Left
 - b. Right.
- 4. Before left and right aftercoolers at bottom rear

- 5. After left and right oil-coolers; top, center, and bottom
- 6. After left and right aftercoolers; top, center, and bottom
- 7. Before and after cylinders 3 and 4 left and 3 and 4 right
- 8. After cylinders 1 and 2 left and right
- 9. After cylinders 5 and 6 left and right
- 10. Under and above fan shroud
 - a. Front left and right sides
 - b. Left and right center
 - c. Left and right rear.
- 11. Vehicle exit duct, left and right sides averaged
- 12. Differential
 - a. Test cell to control room
 - b. Duct from vehicle exit grille to approximate exit plane of cooling air/exhaust duct.
- 13. In duct after vehicle exit grille, left and right sides averaged.

D-5.4 ENGINE FUEL SYSTEM

D-5.4.1 Fuel Temperatures

- 1. Before flowmeter
- 2. At final filter
- 3. Return before and after heater/cooler

D-5.4.2 Fuel Pressures

- 1. Before supply
- 2. Return before supply pump

3. After final filter.

D-5.4.3 Miscellaneous

1. Fuel flow – consumed by engine
2. Fuel return flow from pump.

D-5.5 ENGINE TEMPERATURES

1. Cylinder heads
2. No. 6 left cylinder base, top and bottom
3. No. 1 right cylinder base, top and bottom.

D-5.6 EXHAUST GAS

D-5.6.1 Temperatures

1. At each cylinder exhaust port
2. Turbine inlet 1, 2, 3, 4, 5, and 6 left cylinders
3. Turbine inlet 1, 2, 3, 4, 5, and 6 right cylinders
4. Exhaust ejector:
 - a. Before left
 - b. Before right
 - c. After.

D-5.6.2 Turbine Inlet Pressures

1. Left cylinders 1, 2, 3, 4, 5 and 6.
2. Right cylinders 1, 2, 3, 4, 5, and 6.

D-5.6.3 Instrumentation/Schematic Diagrams

Instrumentation and schematic diagrams are shown in Figs. D-7, D-8, and D-9.

D-6 COOLING SYSTEM DEAERATION TESTS

Outlined in the paragraphs that follow is a typical deaeration test procedure which, in general, is applicable only to a particular vehicle. For a specific vehicle the engine size, cooling system capacity, radiator and surge tank location, and engine thermostat characteristics must be considered before a deaeration test program can be defined. The M110 vehicle cooling test (Ref. 12, Chapter 9) provides some actual deaeration test results based on the vehicle power package size and cooling system capacity.

D-6.1 DEAERATION CAPACITY TEST

Minimum Deaeration. With the system filled with water and operating, air shall be injected at a minimum rate of 0.21 in.³/min-qt of water in the vehicle system for 60 sec to determine minimum deaeration. The water shall deaerate in 15 min or less.

Maximum Deaeration. With the system filled with water and operating, the air injection rate shall be increased by 0.1 cfm increments until 1 cfm is attained or until maximum deaeration is determined. The water shall deaerate in 15 min or less.

To determine conformance to the above deaeration capacity requirements, the radiator and surge tank (if any) shall be placed in the normal vehicle position in a tap water circulating system that has a capacity of 14-18 qt plus the capacity of the radiator and surge tank. The system shall have a minimum pumping capacity equal to the rated flow of the radiator. When the system is operating at a water temperature of $180^{\circ} \pm 10^{\circ}F$ (thermostat blocked to the hot position) and 7 ± 0.5 psi measured at the top tank, the inlet line pressure to the pump shall be sufficient to assure that the pump is not causing aeration by cavitation. Sight tubes shall be located at the radiator inlet(s) and outlet(s). The system

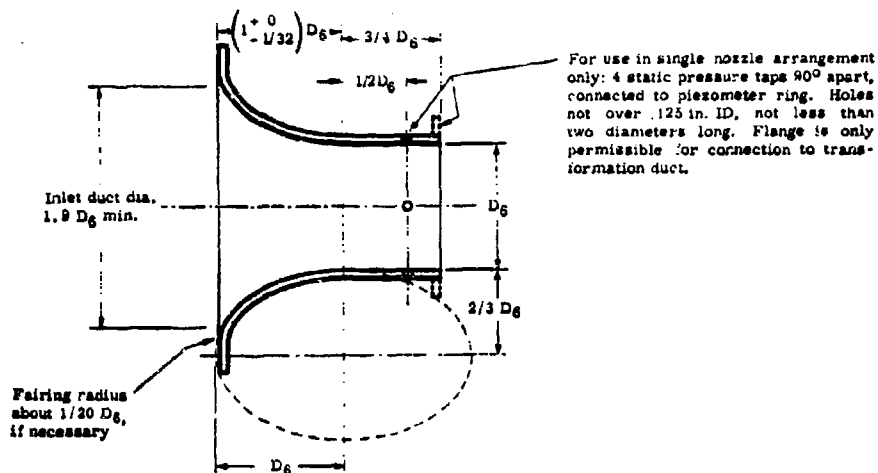

The nozzle throat shall be measured (to an accuracy of $0.001 D_g$) at the minor axis of the ellipse and the nozzle exit. At each place, four diameters — approximately 45° apart must be within $\pm 0.002 D_g$ of the mean. At the entrance to the throat the mean may be $0.002 D_g$ greater, but no less than the mean at the nozzle exit. The nozzle surface shall fair smoothly so that a straight edge may be rocked over the surface without clicking and surface waves shall not be greater than $0.001 D_g$ peak to peak.

Two and three radii approximations to the elliptical form that do not differ at any point in the normal direction more than $1\frac{1}{2}\% D_g$ from the elliptical form may be used.

When nozzles are used where outlet static pressure is the measured pressure, as in the chamber nozzle apparatus, the nozzle may terminate in the plane of the static taps.

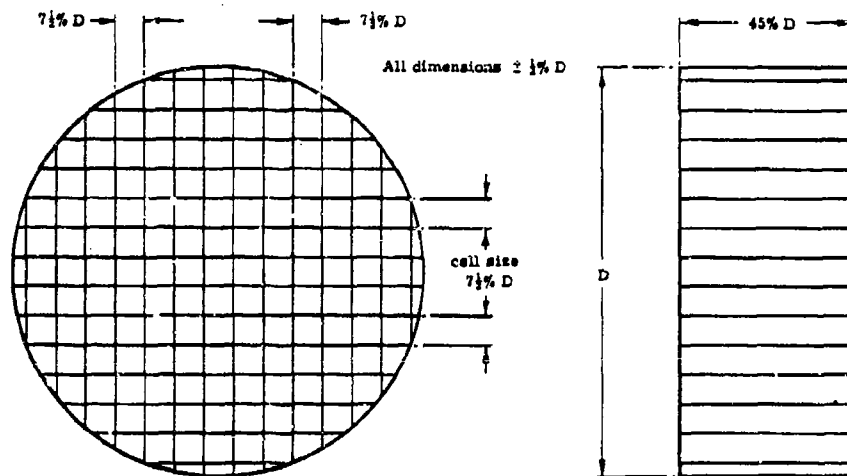

Straighteners shall be positioned so that the sides of the cells are located approximately 45° from the traverse diameters.

Figure D-7. AMC Standard Nozzle and Flow Straightener
 (Courtesy of Air Moving & Conditioning Association)

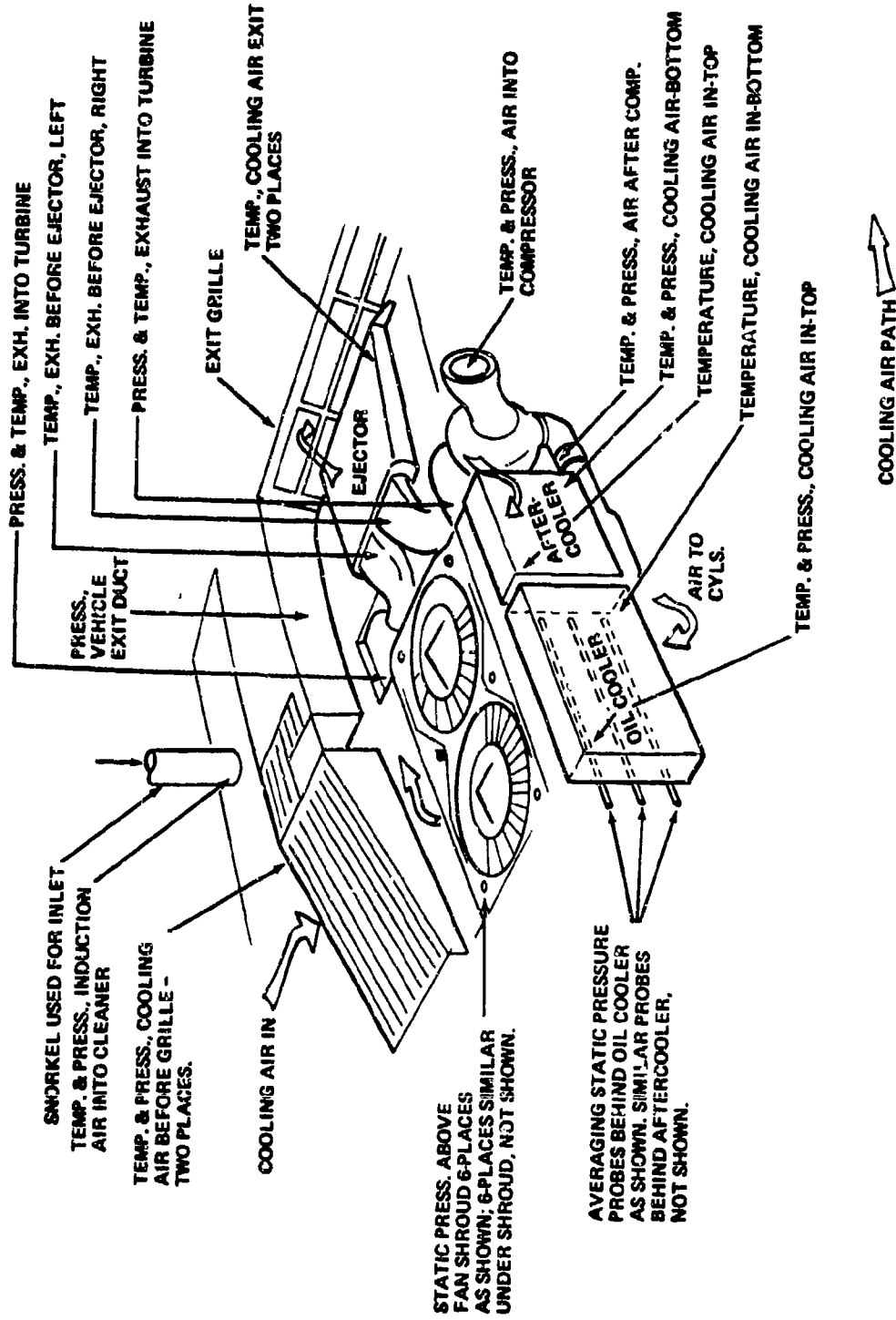

Figure D-8. XM803 Experimental Tank Hot Mock-up Schematic Diagram of Instrumentation Positions

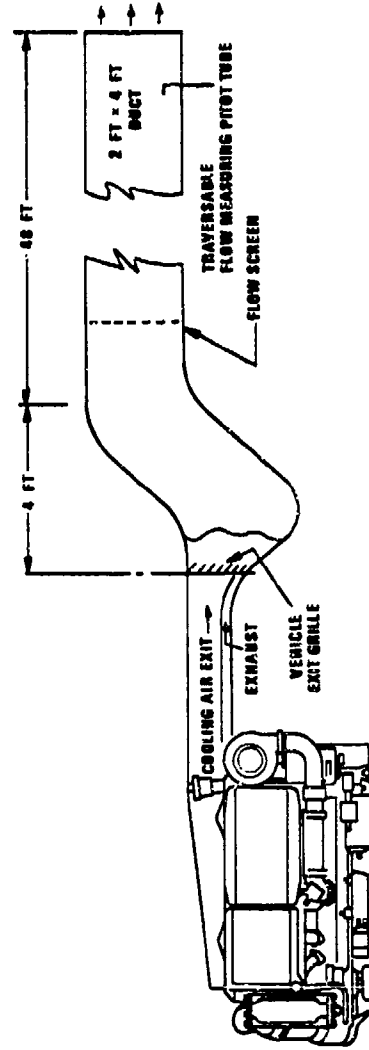

Figure D-9. XM803 Experimental Tank Hot Mock-up Schematic Diagram of Cell Exhaust System

AMCP 706-361

shall be equipped with air injection nozzle(s) located in the water stream approximately 2 ft from the radiator inlet. To ensure a full radiator inlet, the radiator shall be filled to overflow. Deaerated water in the system shall be transparent as viewed in the sight tubes. The air pressure differential shall be not less than 5 psi across the nozzle outlet to assure that the injected air pressure is greater than the system operating pressure.

To determine conformance to the maximum deaeration requirement with the filled system operating with the injection of air as specified, the time for deaeration shall not be more than that specified.

D-6.2 LOW CAPACITY TEST

The tap water circulating system shall operate at the rated water flow at full capacity and down to 0.67 capacity of the radiator and surge tank. The water shall remain clean with no indication of aeration.

To determine conformance to these requirements with the system operating as specified herein, water shall be slowly drained from the radiator and surge tank to the level specified. Make-up air shall maintain a 7.5 psi system pressure and shall be supplied at the radiator top tank above the fluid level.

D-6.3 SURGE TEST

A minimum of 12.5 in.³ of air/qt of water shall be injected into the system at 1-min intervals until the surge of air no longer forces water to drain. The overflow shall not exceed 7 percent of the radiator and surge tank capacity.

D-6.4 TYPICAL VEHICLE COOLING SYSTEM INVESTIGATION TESTS

D-6.4.1 M110 Deaeration Test With/Without Surge Tank (Ref. 12, Chapter 9)

Air was injected into the cooling system of

the M110 Vehicle with and without a surge tank installed to determine the effect of aeration on the cooling system effectiveness. Results from the test are

<u>Vehicle Cooling System</u>	<u>Engine Speed, rpm</u>	<u>Air Injected, cfm</u>	<u>Injection Time, min</u>	<u>Water Expelled, qt</u>	<u>Remarks</u>
No Surge Tank Installed	2300	0.22	3	12	Continued to expel water (aeration occurred after a 2-qt coolant loss)
Surge Tank Installed (10-qt capacity)	2300	0.22	11	11	No further expelling of water (aeration occurred after a 10-qt coolant loss)

These results demonstrate the advantage of the surge tank installation to prevent cooling system degradation.

D-6.4.2 Tractor Truck Coolant Removal Test, 2-1/2-ton M275A2 (Ref. 26, Chapter 9)

A coolant removal test was performed to determine the coolant system effectiveness at reduced coolant levels. Coolant was removed in 1-qt increments. The system was stabilized at full throttle after each coolant removal. Data in Fig. D-10 show that system degradation begins after 4 qt of coolant are removed and becomes severe after 7 qt of coolant are removed.

D-6.4.3 Vehicle Hot Shutdown Tests

The M275A2 and XM817 vehicles were subjected to hot shutdown tests. Results from

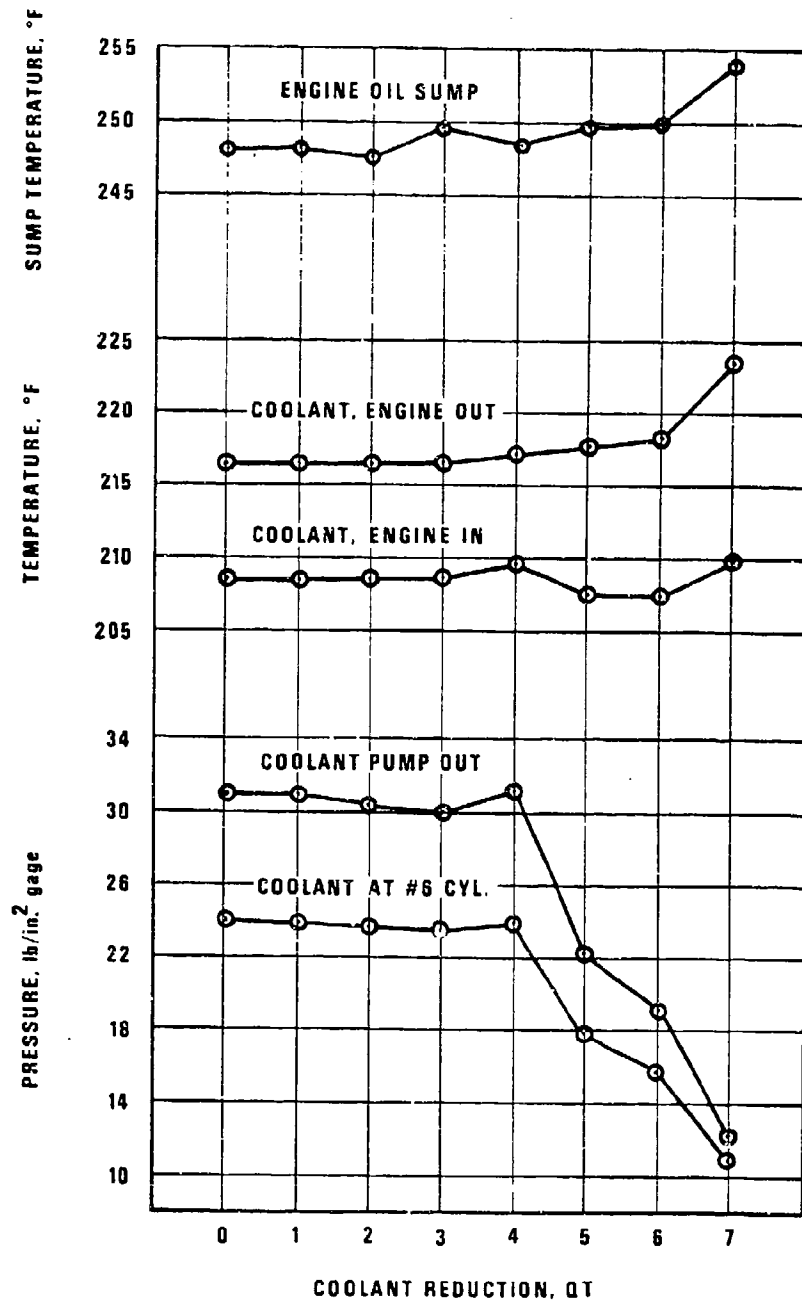

Figure D-10. M275A2 Vehicle Cooling System Performance—Coolant Removal Test at 2600 rpm Full Load and 110° F Ambient Temperature

AMCP 706-381

the tests are presented for information.

**D-8.4.3.1 Tractor Truck, 2-1/2-ton, M275A2
(Ref. 26, Chapter 9)**

Full throttle hot shutdowns were performed at 115°F ambient, with and without the thermostat. Coolant loss with the thermostat removed was 14.2 lbm after two successive shutdowns as opposed to 16.6 lbm under the same conditions with the thermostat installed. The test with the thermostat removed was to determine if the thermostat restriction contributed to the coolant loss on hot shutdown.

D-8.4.3.2 Dump Truck, 5-ton, XM817 (Ref. 27, Chapter 9)

Three different surge tank configurations were tested to evaluate the hot engine shutdown capability of the vehicle cooling system. Test results for each of the test configurations are presented in Table D-3.

Table D-3 shows that with configuration A a total of 18.2 lbm of coolant was lost after the first run and the engine coolant out temperature after engine shutdown was 230.6°F. After the fifth hot engine shutdown run, a total accumulation of 21.1 lbm of coolant had been lost and the engine coolant out temperature after engine shutdown reached a maximum of 241.1°F. In configuration A testing, an estimated 2 to 3 sec elapsed from the full load stabilization condition to engine shutdown. In configuration B a new design surge tank with the breather on the bottom of the tank was installed. In configuration B Group I tests the 2 to 3 sec full load stabilization time was maintained. Test results showed a total of 16.3 lbm of coolant were lost after two runs, and the engine coolant out temperature after engine shutdown reached a maximum of 233°F.

In configuration B Group II test, after full load stabilization conditions, the engine was idled for 2 min at 600 rpm prior to engine

shutdown. Test results under this condition showed a total accumulative coolant loss of 12.8 lbm after the third run and a maximum engine coolant out temperature after engine shutdown of 254°F.

In configuration C, the as-received vehicle surge tank was again installed. In Group I tests the surge tank was installed as in configuration A. Also in Group I, after reaching the full load stabilization test point (2100 rpm engine speed), the engine was idled for 5 sec at 600 rpm prior to engine shutdown. Under these conditions the configuration C Group I test showed that after one run 18.8 lbm of coolant was lost. In the configuration C Group II test the surge tank was installed with the breather lines connected as in configuration B. Under these conditions, test results shows a total of 29.7 lbm of coolant lost.

Since a standard cooling-off period at idle prior to engine shutdown had not been established, various time increments were used during the tests. For future engine hot shutdown tests it is believed that a more realistic test would be to employ a 15-sec cooling-off period at idle speed prior to engine shutdown. This is based on the following estimates of time:

1.	Reaction time of driver to imminent danger	1.5 sec
2.	Removal of foot from gas pedal	1.5 sec
3.	Application of brakes	2.0 sec
4.	Stopping time	7.0 sec
5.	Driver reaction time and engine shutoff	3.0 sec
	Total	15.0 sec

TABLE D-3
SURGE TANK HOT SHUTDOWN CAPABILITY (Ref. 27, Chapter 9)

TEST CODE CONFIGURATION	TEST GROUP	TEST CONDITIONS	CONFIGURATION DESCRIPTION	RUN NO	SHUTDOWN DATA FROM FULL LO-D STABILIZATION (2100 RPM ENGINE SPEED)					
					STAB. TEMP, °F		COOLANT LOSS, LBM		AFTER SHUTDOWN TEMP, °F	
					Eng Sump	Coolant Out	Per Run	Total	Eng Sump	Coolant Out
A		Shutdown Elapse Time From Full Load (2100 RPM Engine Speed) To Fuel Cut-off 2 To 3 Seconds	As-received Vehicle Surge Tank With Breather Lines on Top of Tank	1	246.2	209.1	18.2	18.2	210.6	230.6
					251.7	206.1	0.5	18.7	245.3	239.1
					252.3	210.1	0.7	19.4	248.7	241.4
					253.7	211.7	0.7	20.1	---	---
					254.0	214.3	1.0	21.1	---	---
B	I	Shutdown Elapse Time From Full Load (2100 RPM Engine Speed) To Fuel Cutoff, 2 To 3 Seconds	New Design Surge Tank With Breather Lines on Bottom of Tank	1	252	204	15	15	---	233
					252	207	1.3	16.3	---	232
C	I	After Full Load Stab. Engine Idled For Two Minutes At 600 RPM Prior To Fuel Shut Off	As-received Vehicle Surge Tank With Breather Lines on Top of Tank (Same as Configuration A)	1	247	206	2.3	2.3	---	233
					253	213	7.3	9.6	---	233
					253	213	3.2	12.8	---	254
C	II	After Full Load Stab. Engine Idled For 5 Seconds Prior To Fuel Shutoff	As-received Vehicle Surge Tank (Breather Lines Modified To Test Configuration B)	1	---	---	18.8	18.8	---	---
					---	---	29.7	29.7	---	---

NOTE: Cell ambient temperature is maintained at 120 ± 1 deg F and wind velocity is maintained at 3 mph.

J/MCF 788-361

D-7 M110 PRODUCT IMPROVEMENT TEST PLAN (USATACOM) PROPULSION SYSTEMS LABORATORY Test Program No. 699 (Ref. 12)

D-7.1 TITLE: COOLING AND PERFORMANCE TEST OF M110 VEHICLE-8V71T ENGINE

D-7.2 OBJECT

The test has the following objectives:

1. Conduct vehicle cooling and performance tests of the M110 vehicle up to 115°F ambient temperature.

2. Develop a cooling system for satisfactory full rack cooling and performance capability in high ambient temperatures.

D-7.3 OUTLINE OF PROBLEM

The vehicle will be tested for complete cooling and performance characteristics at ambient temperatures up to 115°F. If the cooling system is inadequate, tests will be conducted to obtain information for correcting the deficiencies. Full rack spro at torque, horsepower, and fuel consumption characteristics will also be determined.

D-7.4 TEST MATERIAL

The test equipment and material employed are:

<u>Item</u>	<u>Range</u>	<u>Accuracy</u>
1. Sprocket torque (torque-meters) and dynamometer a. Load cells (north) b. Load cells (south)	0-35000 lbf-ft	±20 lbf-ft
2. Sprocket Speeds	0-1000 rpm	±2 rpm
3. Engine Speed	0-3000 rpm	±5 rpm

1. M110 vehicle using a USATACOM cooling system with a surge tank

2. Fuel and Lubricants:

a. Fuel oil, diesel, conforming to Federal Specification VV-F-800, grade DF-2

b. Engine oil, grade 30, conforming to Military Specification MIL-L-2104, Government designation MB-901

c. Oil, transmission and gear boxes as per TM's.

D-7.5 TEST EQUIPMENT

Test Cell 9, Bldg. 212, Propulsion Systems Laboratory, USATACOM, with associated equipment and instrumentation was used. This cell is capable of operating at temperatures from outside ambient to 160°F with winds up to 20 mph. Power absorption is located in two rooms below the test cell. Included in the cell equipment is an automatic warning and shut-down system that will sound an alarm or stop the test if temperature or pressure becomes critical. An automatic data printout for temperature and pressure is used. As many as 400 pressure and temperature readings can be printed out in 5 min. Solar radiation can be simulated with heat lamps.

D-7.6 TEST PROCEDURE

D-7.6.1 Instrumentation

AASCP 708-361

<u># Item</u>	<u>Range</u>	<u>Accuracy</u>
4. Fan Speed (radiator)	0-5000 rpm	±5 rpm
5. Fuel flow	0-250 lbm/hr	±5 lbm/hr
6. Coolant flow (2) radiators out	0-200 gal/min	±5 gal/min
7. Cooling airflow (anemometer traverse of radiator)	0-25000 cfm	±10 cfm
8. Barometric pressure, wet and dry bulb temperatures		
9. Cell air speed	0-5 mph	±1 mph
10. Control room reference thermometer and thermocouple		±5 deg F
11. Engine torquemeter	0-1000 lbf-ft	±10 lbf-ft
12. Temperatures at the following locations, °F		
a. Air		
(1) ambient (6)	70°-150°F	±2 deg F
(2) entering inlet grille (4)	70°-150°F	±2 deg F
(3) entering radiators (8)	70°-150°F	±2 deg F
(4) leaving radiators (8)	70°-250°F	±2 deg F
(5) within engine compartment (4)	70°-200°F	±2 deg F
(6) entering air cleaner (2)	70°-200°F	±2 deg F
(7) air box (left or right) (1)	40°-250°F	±2 deg F
b. Coolant		
(1) entering radiators (2 radiators)	70°-250°F	±2 deg F
(2) leaving radiators (2)	70°-250°F	±2 deg F
(3) leaving engine oil cooler	70°-250°F	±2 deg F
c. Oil		
(1) engine sump	70°-275°F	±2 deg F
(2) entering engine cooler	70°-275°F	±2 deg F
(3) engine gallery	70°-275°F	±2 deg F
(4) engine turbine drains (2)	70°-300°F	±2 deg F
(5) transmission sump	70°-300°F	±2 deg F
(6) entering transmission	70°-300°F	±2 deg F
(7) leaving transmission	70°-300°F	±2 deg F
(8) right final drive	70°-300°F	±2 deg F
(9) left final drive	70°-300°F	±2 deg F
d. Fuel		
(1) leaving tank	70°-250°F	±2 deg F
(2) entering engine (after primary filter)	70°-250°F	±2 deg F
(3) spill	70°-250°F	±2 deg F
e. Gas, exhaust ports (8)	800°-1400°F	±10 deg F

<u>Item</u>	<u>Range</u>	<u>Accuracy</u>
13. Pressures at the following locations		
a. Air		
(1) ambient	0-5 in. water	±0.1 in. water
(2) engine compartment (low area; try for stagnant air)	0-30 in. water	±0.1 in. water
(3) before radiator (low area; try for stagnant air)	0-30 in. water	±0.1 in. water
(4) air box (1) (left or right)	0-50 in. Hg	±2 in. water
(5) crankcase	0-30 in. water	±2 in. water
(6) after turbo (do not drill turbo)	0-50 in. Hg	±2 in. water
b. Oil		
(1) engine gallery	0-100 psi	±2 psi
(2) entering engine cooler	0-100 psi	±2 psi
(3) leaving engine cooler	0-100 psi	±2 psi
(4) entering transmission cooler	0-60 psi	±2 psi
(5) leaving transmission cooler	0-60 psi	±2 psi
(5) transmission main	0-200 psi	±5 psi
c. Coolant		
(1) entering pump	0-60 psi	±2 psi
(2) leaving pump	0-60 psi	±2 psi
(3) top tank radiators (2)	0-60 psi	±2 psi
(4) leaving radiator	0-60 psi	±2 psi
(5) entering engine cooler	0-60 psi	±2 psi
(6) leaving engine cooler	0-60 psi	±2 psi
(7) leaving transmission cooler	0-60 psi	±2 psi
(8) surge tank	0-30 psi	±2 psi
d. Fuel		
(1) supply	0-30 psi	±2 psi
(2) after engine pump	0-100 psi	±2 psi

14. Warning and shutdown values will be as follows (max for temp, minimum for pressure):

	<u>Warning</u>	<u>Shutdown</u>
a. Engine oil sump temperature	260°F	275°F
b. Coolant (leaving engine) temperature	230°F	240°F
c. Exhaust gas temperatures (at ports)	1175°F	1250°F
d. Transmission oil (leaving transmission)	300°F	310°F
e. Engine gallery oil pressure (full rack)	26 psi minimum	18 psi
f. Engine gallery oil pressure (idle)	5 psi	3 psi
g. Transmission oil (main)	100 psi	80 psi

15. Block open the coolant thermostat

16. Vehicle exhaust will be connected to the cell exhaust system to prevent creating a vacuum on the vehicle exhaust

17. Gear box oil temperatures will not be allowed to exceed 300°F

18. Vehicle power will be taken from the front drive sprocket. This will require that the vehicle be backed into the cell. Air will be directed across the cell from the east
19. To install the given instrumentation will necessitate removing the power package. Route the thermocouple wire and pressure lines out of the vehicle in such a manner that the power package can be removed and operated on the floor without disconnecting any lines. When replacing the power package in the vehicle, take care to replace all air seals
20. Align the vehicle hubs (with adapters installed) with the dynamometer shafts (with flexible coupling removed). The sprocket adapter pilot diameter should be concentric within 0.030 in. Record concentricity and face parallelism and get the engineer's approval before coupling the vehicle to the dynamometer
21. Cell CO₂ local spurt system must be installed or adapted to vehicle system
22. Flow meter (coolant) radiators out (2).

D-7.6.2 Preliminary Operation

1. Bring all oil sumps, transmission, engine gear boxes, hydraulic systems (if present), and final drives up to required levels. Fill the cooling system with water. All checks will be made per TM's.
2. Start the vehicle in neutral only and shift at idle speed with the brakes fully on.
3. Start and warm-up the engine without load and make a complete instrumentation checkout. Check thoroughly for leaks.
4. Warm-up the vehicle for 15 min at part load before going into any full load testing.
5. Plug in the monitors to observe all the temperatures and pressures (except exhaust gases) that have warning and shutdown values. Mark the limits with a china marker on the monitor glass.
6. Bring the engine speed down to 1200 rpm no load whenever the panel goes into warning.
7. If the engine is shutdown accidentally at full load, immediately restart and cool off at 1200 rpm no load.

D-7.6.3 Tests

Shift the dynamometer to 1:1 ratio. Fuel will be supplied to the engine by the cell system at 115° ±5°F. Head wind velocity will be 5 ± 1 mph. Ambient air temperature will be the average of the 6 thermocouples in front of the vehicle, each of which must be within 2 deg of 115°F. During the cooling test the cell will be soaked 2 hr at 115°F before starting. It is suggested that the 115°F ambient be set at the beginning of the work shift, and all the vehicle and instrumentation checks be accomplished during the soak period. Also immediately after start-up for cooling runs and each 10-min period thereafter, record a complete column of log sheet data. Stabilization of a cooling test point will be considered as 3 consecutive 10-min data type-outs with no temperature change. A temperature drop of 1 deg F will not be considered a change. Perform the tests that follow.

D-7.6.3.1 Stall Check-Gear Setting High Range

Apply a load to stall the torque converter (use vehicle braking system) and record the maximum engine speed and oil temperature out of the converter at 5-sec intervals until

AMCP 786-381

the oil has reached 265°F (15 to 30 sec).

D-7.8.3.2 Cooling Tests

1. Third-gear Cooling Tests (Phase I) are conducted under the following conditions:

a. Ambient temperature 115° ± 2°F

(1) the average of 6 thermocouples in front of the vehicle

(2) thermocouples must be within 2 deg of 115°F

b. Headwind velocity 5 ± 1 mph

c. Engine at full rack

d. Two-hour cell soak at 115°F required

e. Fuel supplied to engine at 115° ± 5°F

f. Operate in third gear at the following speeds until stabilization (operate by engine speed in lockup and by dynamometer in speed converter):

(1) Lockup; 1700 engine rpm, dyn rpm 200 (approx)

(2) Lockup; 2000 engine rpm, dyn rpm 235 (approx)

(3) Lockup; 2300 engine rpm, dyn rpm 270 (approx)

(4) 0.7 conv; 168 dyn rpm, engine rpm 2010 (approx)

(5) 0.5 conv; 114 dyn rpm, engine rpm 1940 (approx)

(6) 0.4 conv; 92 dyn rpm, engine rpm 1930 (approx)

2. Vehicle cooling investigation tests

(Phase II). If the cooling system is inadequate, tests will be conducted to obtain information for correcting the deficiencies. The scope and direction of the tests will depend on the outcome of the basic cooling test. The tests that follow are planned.

D-7.8.3.3 Surge Tank Investigation (Phase II)

1. Install a transparent plastic tube in the engine crossover tube and the water pump cover, and connect a hose and shutoff valve to the cooling system drain to permit removal of measured quantities of coolant.

2. Drain the cooling system. With one radiator cap installed, fill the system through the other radiator without bleeding. Reinstall the fill cap, start the engine and operate for approximately 10 min. Shutdown the engine, remove both radiator caps, and fill system to capacity. The quantity of water added both initially and on the final fill should be recorded.

3. The cooling system shall be filled to its capacity by removing both radiator caps but without bleeding entrained air from the engine. With the engine running at 2000 rpm minimum and the coolant temperature above 190°F, flow through the engine crossover tube shall be monitored until aeration is no longer observed. Water shall then be drained from the system in 1-qt increments until aeration is observed in the water passing through the engine crossover tube. The total amount of water removed at this time shall be noted.

4. With the cooling system filled and the cap removed from the right hand radiator, the engine shall be run at governed speed until the coolant temperature reaches 190°F minimum. A container should be placed beneath the right hand radiator overflow tube so that the quantity of water expelled from the system can be measured. When air bubbles are no longer observed in the water flowing from the

engine to the radiator, air shall be injected into the water passage in the oil-cooler. The airflow rate gradually should be increased until 0.8 cfm is reached. Throughout this operation the coolant flow through the coolant pump and engine crossover tube should be observed for the presence of air. Also, the amount of water expelled from the overflow tube should be noted. If this amount exceeds 14 qt, the test should be terminated. After conditions have stabilized to a point where the continued presence or absence of air in the various lines is established and water is no longer being expelled from the overflow tube, air injection should be stopped. The period of time required for air to disappear from the circulating coolant should be noted. A quantitative estimate of the air observed in the engine crossover tube and the amount of water expelled from the system should be reported.

5. The test described in the preceding par. 4 should be repeated except that the water temperature should not exceed 160°F.

6. Install the revised cooling system proposed by USATACOM which incorporates a surge tank. Install transparent plastic tubes in the engine crossover tube, the thermostat housing to surge tank bleed tube, the radiator top-tank to surge tank bleed tube, the surge tank to coolant pump tube, and the coolant pump cover.

7. The tests outlined in the preceding subpars. 2, 3, and 4 (par. D-7.6.3.3) of this plan should be repeated except that the surge tank cap should be removed rather than the right hand radiator cap and, if the quantity of water expelled during aeration should exceed 9 qt, the test shall be terminated. The same air injection rate as established previously

should be used. Observe the amount of air present in the engine crossover tube during the air injection period. Report the amount in terms relating to the original results.

D-7.6.3.4 Radiator Restriction

Block the airflow through the radiator (vary the amount of radiator area covered and keep repeating the cooling tests at the most severe point).

D-7.6.3.5 Fan Belt Investigation

Repeat cooling tests at the most severe point with various numbers of belts and with various degrees of belt slip.

D-7.6.3.6 Other Tests

As funding permits.

D-7.7 TEST RESULTS

The data will be summarized by charts showing temperatures of the engine and transmission oils for each test condition with respect to output speed. Sprocket power and vehicle fuel consumption will be included. If the cooling system is inadequate, the data shall be analyzed to determine the nature of the deficiencies. All other power package deficiencies shall be reported. Pertinent miscellaneous vehicle operation also will be included in the report.

INDEX

A

Aberdeen Proving Ground, 9-37
 accessibility, 1-54
 aeration warning systems, 5-30
 after boil, 5-2
 aftercoolers, 3-55
 performance, 3-58
 air
 density, 4-28, D-13
 properties of, 3-72, 3-77
 thermodynamic properties of, 2-18
 Airborne, Electronics, and Special Warfare Board, 9-38
 air compressors, 2-51
 air conditioning systems, 2-51
 air coolers, 1-20
 induction, 8-2
 air cycle, compound, 2-8
 air drop, 1-41
 air flow
 area, 6-3
 ballistic grille, C-1
 characteristics, 8-10
 air flow resistance
 area, 6-10
 grille, 6-8
 air heat rejection rate, 8-50
 air moving devices, 4-3
 air pressure drop, D-3
 air recirculation, 8-12
 air resistance, total system, 7-21
 air standard cycle, 2-4
 air-to-boil, 3-36
 air transportability, 1-41
 allocated baseline, 9-32
 AMCA Standard 300-67 Test
 Code for Sound Rating, 9-3
 antifreeze, 1-57
 APU, 2-55, 5-6, 5-10
 AR
 70-10, 9-3, 9-33
 70-38, 1-37, 1-64, 2-55, 9-3, 9-27
 71-3, 9-33
 700-35, 9-33
 700-78, 9-33
 Arctic Test Center, 9-38

Armor and Engineering Board, 9-38
 Artillery Board, 9-38
 auxiliary engines, 2-55
 power unit, 5-14

B

ballistic grille, 1-46, 6-3, C-1
 protection, 6-12
 ballistic protection, 1-46
 batteries, 2-25
 blades, fan, 4-3
 brakes, internal, 2-31
 Brayton cycle, 2-7

C

camouflage, 1-64
 Carnot cycle, 2-6
 cavitation, 5-1
 centrifugal fans, 4-3
 centrifugal pumps, 7-31
 ceramic fibers, 3-70
 climatic categories, 1-10
 clutches, 2-29, 2-31, 8-10
 cold mock-up tests, 9-5
 component tests, 9-1
 compound air cycle, 2-8
 compressible fluids, 7-4
 conduction, thermal, 3-6
 conductivity, thermal, metals, 3-71
 controls, 5-9
 convection
 forced, 2-3
 heat, 3-6
 conventional cooling systems, 1-4
 coolant
 circulation, 1-11
 expansion, 6-15
 flow, 3-23
 flow control, 5-17
 flow rate, 3-34
 performance, 1-5
 removal test, D-24
 reserve, 3-34
 temperature, 1-5, 8-72
 coolant level indicators, 5-29

INDEX (Con't.)

- coolant pumps, 7-31, D-15
 - testing, 9-5, D-12
 - coolants, 1-55, 2-18
 - cooler
 - area, 8-70
 - engine oil, M114 vehicle, 8-33
 - oil, 3-66
 - oil, test, D-5
 - oil-to-water, D-6
 - transmission, M114, 8-33
 - transmission oil, 8-62
 - coolers, keel, 3-59
 - cooling
 - air, 1-4
 - airflow, 8-71
 - airflow tests, 7-21
 - air velocities, 7-4
 - control, 5-3
 - direct, 3-24
 - engine, XM803, Tank, 8-43
 - indirect, 3-25
 - performance evaluations, 9-3
 - requirements, 1-7
 - test, 9-31
 - test objectives, 9-15
 - test results, 9-15
 - transmissions, 8-20
 - cooling-air heater, 5-6
 - cooling air system, D-16
 - cooling fan, B-1
 - diesel engine, B-34
 - cooling subsystem, trade-off analysis, 8-14
 - cooling system
 - analysis, 8-7
 - atmosphere, 2-3
 - component arrangement, 3-68
 - control, 5-1
 - design, example, 8-15
 - design, M114 vehicle, 8-23
 - failures, 1-3
 - functions, 5-1
 - instrumentation, 5-1
 - integration, 8-14
 - optimization, 8-14, B-27
 - parametric study, 8-68
 - performance, B-27
 - performance, XM803, Tank, 8-65
 - pressure, 2-3
 - rotary engine, 1-7
 - special, 2-4
 - Tank, M47, B-25
 - testing, 9-1
 - thermo-syphon, 2-3
 - vapor-phase 2-4
 - Wankel engine, 1-8
 - core
 - design, 3-20, A-34
 - radiator, A-34
 - correction factors, fluid flow, 7-11
 - corrections, temperature, 9-9
 - crane, 20-ton, rough terrain, 1-18
 - cycles, thermodynamic, 2-4
 - cylinder, temperature, 8-45
- D
- data presentation, 9-30
 - dearation, 3-32, 9-10
 - tests, D-18
 - deflector, rock, 6-3
 - design
 - cooling systems, 8-5
 - radiator, 3-27
 - development cycle, 9-32
 - diesel
 - cycle, 2-6
 - engine, air cooled, 8-42
 - engine, cooling fans, D-13
 - diffuser, 7-11, B-24
 - drag
 - form, 7-4
 - pressure, 7-4
 - drive components, 2-26
 - drives, electric, 2-42
 - duct
 - design, 7-20
 - outlet, 7-25
 - ducting, 1-15
 - durability, 1-51
 - dynamometer, D-11

INDEX (Con't.)

E

efficiency, 1-6, 2-30
fan, 4-13
heat transfer, 3-31
electric drives, 2-42
energy balance equations, 3-18
engine
accessories, 8-9
compartment, 7-23
cooling, 8-15
exhaust, 8-10
fuel system, D-17
heat flow characteristics, 2-9
performance, 8-5
temperature, 1-4
engine oil, properties of, 3-74
engines
air-cooled, 2-3
air-cooled M274A5, 1-67
auxiliary, 2-55
AVCR-1100, 1-22
AVCR-1100-3B, 2-8
AVDS-1790, 1-30, 2-9
Chevrolet 283CID, 1-15
diesel, 1-22
dual cycle, 2-6
gas turbine, 1-6, 1-25
liquid-cooled, 2-3
liquid-cooled, installation, 8-66
Rankine cycle, 2-24
rotary, 1-6
Stirling, 2-22
Wankel, 1-9, 2-23
6V53T, 1-30
8V71T, 1-30
environment, military, 1-2
environmental
extremes, 1-36
tests, 9-27
equipment, supporting, 9-28
ethylene glycol, 1-4, 2-19
ethylene glycol-water solutions, 3-75
boiling point, 5-2
expansion of, 5-17
exhaust
ejectors, 4-3, 4-41

exhaust (continued)
engine, 8-10
gas, D-18
manifolds, 2-19
pipe, 1-61, 3-69
systems, 2-20

F

facilities, test, 9-11
failures, cooling systems, 1-3
FAMECE, 1-20
fan
airflow, 8-18
characteristics, 4-5
comparisons, 4-8
components, 4-15
design, B-1
drive, hydrostatic, M114 vehicle, 8-35
drives, 4-36
efficiency, 4-13
installation, B-23
laws, 4-15
location, 4-34
noise, 4-17
outlet velocity, 4-15
parallel operation, 4-23
performance, 4-14, 8-63
performance test, D-8
pressure differential, 4-9
selection, 4-21, 4-24, 7-25, 8-60
series operation, 4-24
specific speed, 4-28
speed modulation, 5-7
system engineering, B-24
testing, 9-3
tip speed, 4-14
fans
axial flow, 4-6
centrifugal, 4-3
cooling, B-1
diesel engines, 4-12
military vehicles, 4-11
mixed flow, B-21
variable pitch, 4-40
Field Artillery Directorate, 9-37
final drives, 2-46

INDEX (Con't.)

- fins, 3-7, A-1
 cooling, 2-19
- flow
 analysis, liquid, 7-31
 incompressible fluids, 7-3
- flow resistance
 coolant, 7-38
 liquid, 7-34
- fluid
 coupling, 2-47
 flow, 7-3
 pressure, 4-9
- fluids, compressible, 7-4
- fording, 1-68
- form drag, 7-4
- friction
 losses, 7-39
 losses, grille, 7-16
 number, 7-6
 pressure drop, 7-4
- fuel
 cells, 2-24
 injection pumps, 2-50
 tanks, 8-10
- fuels, 1-55
- functional baseline, 9-32
- G**
- General Equipment Directorate, 9-37
- generators, 2-50
- grille
 area, 7-19
 design, 6-5
 exhaust, 7-29
 friction loss, 7-16
 installation, 6-15
 testing, 9-3
- grilles, 6-3, C-1
 ballistic, 1-46
 bar type, 6-7
 chevron type, 6-15
 fish-hook type, 6-8
 table-top type, 6-15
 venturi type, 6-7
- H**
- heat
 balance, D-5, D-8
 conduction, 3-6
 convection, 3-6
 radiation, 3-5
 sources, 2-3, 2-47
- heat exchangers, 3-8, A-1, D-2
 core design, 3-20
 design, 3-18
 effectiveness, 3-19
 pressure drop, 3-23, 7-16
 selection, 3-14
 testing, 9-1
- heat rejection, 8-9, D-5, D-8
 engine, M114 vehicle, 8-23
 engine, XM803 Tank, 8-43
 estimation, 2-9
 gas turbine engine, 2-20, 2-27
 oil, XM803 Tank, 8-46
 rate, 3-30
 rate, transmission, 8-20
 reciprocating engine, 2-6
 schematic, 8-10
 test transmission, M114 vehicle, 8-27, D-1
 transmission, XM803 Tank, 8-60
- heat transfer, 2-3
 capability, 3-20, 3-30
 capacity, A-34
 devices, 3-5
 methods, 3-5
 rate, 3-18
- heaters
 air, 5-6
 coolant, 5-6
 oil, 5-6
- Howitzer, M109, 1-30
- hot mock-up tests, 9-6
- hot shutdown tests, D-22
- hydraulic
 drives, 2-32
 drives, fan 4-38
 fluid, properties of, 3-73
 retarders, 2-47
- hydraulic diameter, equivalent, 7-14
- hydromechanical transmissions, 2-41

INDEX (Con't.)

- I
- impact loads, 1-34, 1-38
 - impeller, 4-3
 - incompressible fluid flow, 7-3
 - indicator
 - cooling level, 5-29
 - temperature, 5-26
 - induction
 - air, D-16
 - system, 8-50
 - Infantry Board, 9-38
 - infrared
 - signature, 1-59
 - suppression, 1-61
 - installation
 - fan, 4-30
 - radiator, 3-29
 - instrumentation, 9-28, D-1
 - cooling systems, 5-1
 - instruments, 5-9
 - power, D-11
 - pressure, D-11
 - speed, D-11
 - temperature, D-11
 - test, D-8
 - insulation, 3-69
- K
- keel, coolers, 3-59
- L
- liquid flow analysis, 7-31
 - loss coefficient, fluid flow, 7-11
 - losses, dynamic, fluid flow, 7-11
 - low capacity test, D-22
 - lubricants, 1-89
 - viscosity, 7-37
 - lubricating oil, 1-8, 2-20, 2-20
- M
- maintenance, 1-39
 - requirements, 1-54
 - manifold, 3-69
 - manometer, D-8
 - military
 - environment, 1-2
 - fleet, 1-1
 - requirements, 1-32
 - Military Specifications
 - MIL-A-8421 (USAF), 1-41
 - MIL-A-11755, 1-57
 - MIL-G-3056, 1-57
 - MIL-I-19528, 1-56
 - MIL-L-2104, 1-8
 - MIL-R-45306, 9-2
 - MIL-T-5624, 1-57
 - Military Standards
 - MIL-STD-210, 1-37
 - MIL-STD-669, 1-44
 - MIL-STD-810, 1-46
 - MIL-STD-1472, 2-55
 - modular construction, 1-55
 - motors, electric, 2-50
 - mufflers, 1-61
- N
- noise, 6-12, B-22
 - fan, 4-17
 - fan drive, 4-40
 - nuclear energy, 2-26
- O
- observed potential, D-4
 - oil
 - flow rates, 7-36
 - temperature, 8-5
 - oil coolers, 3-40, 8-9
 - design, 3-51
 - performance, A-1
 - selection, 3-47
 - testing, 9-2, D-5
 - oil pumps, 7-32
 - operational test, 9-34
 - optimization,
 - cooling system, 8-14
 - oil cooler, 3-49
 - Otto cycle, 2-6

AMCP 700-381

INDEX (Con't.)

P

performance,
 engine, 8-5
 specifications, 8-14
 pipe size selection, 7-36
 pitot tube, D-12
 potential, D-4
 power
 measurement, D-11
 losses, 2-29
 immersed bodies, 7-13
 minimization, 7-19
 static, 8-17
 requirements, fan, B-22
 power plants, combination, 2-45
 power train, 2-38
 terms, 2-33
 power unit, auxiliary, 2-55, 5-6, 5-10
 pressure, D-17
 cycling, D-3
 differential, fan, 4-9
 drag, 7-4
 drop
 dynamic, 7-4
 fluid, 7-4
 fluid, bend, 7-6
 friction, 7-4, 7-35
 grille, 6-13, C-1
 heat exchanger, 7-16
 fluid, 4-9
 test, D-6
 pressure caps, 3-38, 5-12
 pressure cooling system, 2-3
 pressure profile graph, 7-30
 product baseline, 9-32
 product improvement
 program, 9-15
 test, D-26
 production endurance test, D-6
 Propulsion System Laboratory, 9-26, D-26
 pump
 coolant, 7-31, D-15
 gear, 5-31
 oil, 7-36

R

radiation, heat, 3-5
 radiator cap, 5-12
 pressure, 3-37
 radiator shutters, 5-4
 radiator size, M114 vehicle, 8-27
 radiators, 3-25, B-35, D-1
 air-cooled, 3-20
 core design, 3-30
 core performance 3-41, 8-67, A-34
 selection, 3-34
 size, 3-35
 testing, 9-1
 ram airflow, 4-3
 Rankine cycle, 2-7
 engine, 2-24
 rated
 coolant flow, D-4
 heat rejection, D-4
 internal pressure, D-4
 potential, D-4
 reliability, 1-50
 cooling systems, 1-51
 resonance, D-3
 retarders, 8-10
 hydraulic, 2-47
 Reynolds number, 7-6, 7-29, 7-34
 rock deflector, 6-3
 Rock Island Arsenal, D-15
 roughness, 7-6

S

screens, 6-3, 7-11
 sensors, temperature, 5-26
 shock and vibration, 1-44
 data, 1-40
 shutter, radiator, 5-4
 simulation, 9-5
 solar radiation, 2-55
 sound level, B-22
 specifications, performance, 8-14
 specific speed, fan, 4-20
 speed measuring, D-11

INDEX (Con't.)

splitter, 7-20
 standard air, D-4
 static pressure
 curve, 7-22
 drop, measurement, 9-5
 profile, 8-13
 Stefan-Boltzmann law, 3-5
 Stirling cycle, 2-7
 engine, 2-22
 storage, depot, 1-64
 supercharger, 3-55
 surge tanks
 radiation, 5-14
 test, 9-17
 surge test, D-22
 system
 development cycle, 1-2
 integration, 8-5
 resistance, cooling system, 4-22

T

tank
 cooling systems, 1-22, 7-22
 surge, 5-14
 Tanks
 M60/M48A3, 1-25
 MBT/XM803, 1-22
 XM803, 7-21; 8-42, D-16
 TB 750-651, 1-56
 temperature
 coolant, 5-1, 8-72
 corrections, 9-9
 effects, 1-6
 engine, 1-4
 engine compartment, 2-57
 indicator, 5-29
 limits, 1-4, 3-37
 maximum, operating, 3-34
 measurement, D-11
 oil, 8-5
 warning unit, 5-29
 terrain, 1-3
 test, 1-36
 agencies, 9-37
 cell, vehicular, 9-11
 conditions, 9-31

test (continued)
 equipment, D-26
 facilities, 9-11
 instruments, D-26
 objectives, 9-14
 results, 9-14, 9-27, D-31/D-32
 rig, 9-10
 testing
 components, 9-1
 coolant pump, D-12
 cooling system, 9-1
 cooling system, M114 vehicle, 8-35
 grille assemblies, 6-15
 methods, 1-45, 9-11, D-12
 procedures, 9-27, 9-31, D-1, D-5, D-8, D-26
 radiators, D-1
 surge tanks, 9-17
 total vehicle, 9-10
 vehicle, 9-1
 M110, D-26
 M551, 9-17
 M561, 9-22
 tests
 cold mock-up, 9-5
 cooling, D-30
 cooling airflow, 7-21
 cooling program, 9-11
 cyclic, D-6
 deaeration, D-18
 development, 9-27, 9-34,
 environmental, 9-27
 hot mock-up, 9-6
 hot shutdown, D-22
 investigation, D-22
 low capacity, 9-19, 9-34
 major, 9-27
 operational, 9-34
 production endurance, D-8
 production improvement, 9-14, D-26
 suitability, 9-27
 surge, D-22
 type, 9-29,
 vibration, D-3
 thermal, 3-19
 conductivity, ceramic flow, 3-70
 insulation, 3-69
 thermodynamic cycles, 2-5

AMCP 706-361

INDEX (Con't.)

thermo physical properties, 3-70
thermostats, 1-11, 5-7, 5-18
 bellows type, 5-22
 control modes, 5-24
 pellet type, 5-22
thermo syphon systems, 2-3
throttling, 5-4
torque converter, 2-33, 2-38
TRADOC, 1-2
transmissions, 8-10
 cooling, 8-20
 components, 2-26
Tropic Test Center, 9-38
truck, cooling systems, 1-3
Truck, Platform Utility, M274A5, 1-20
turning vane, 7-20

U

units, B-29
USAMC, 9-37
US Army Materiel Command, 9-27
US Army Tank-Automotive Command, 9-26
USATACOM, 1-2, 9-26, 9-37
 Propulsion Systems Division, 9-11
USATECOM, 9-27, 9-37, 9-64
USATRADOC, 9-37
USATROSCOM, 9-37

V

vane, turning, 7-20
vapor-phase cooling systems, 2-4

vehicle
 cooling, 3-24
 cooling, system characteristics, 2-18
 design, 1-1
 performance equations, 2-36
 tactical deployment, 1-50
 tracked mileage cycle, 1-52
 wheeled mileage cycle, 1-53
vehicle, types
 Armored Carrier, M114A1, 1-15
 assault SHERIDAN, M551, 1-29, 9-17
 combat, 1-22
 combat, liquid-cooled, 1-29
 M110, test, D-26
vehicle types
 M114, 8-23
 special-purpose, 1-15
 vehicular test cell, 9-11
velocity, cooling air, 7-4
ventilation, 2-55
verification tests, 9-15
viscosity, lubricants, 7-37
viscous drive, fan, 4-40

W

Wankel engine, 2-23
water, properties of, 3-73
winterization, 1-64, 5-4, 8-12

Y

Yuma Proving Ground, 9-37