

AD-A199 307

DTIC FILE COPY



AGARD-LS-157

AGARD-LS-157

AGARD

ADVISORY GROUP FOR AEROSPACE RESEARCH & DEVELOPMENT

7 RUE ANCELLE 92200 NEUILLY SUR SEINE FRANCE

AGARD LECTURE SERIES No.157

Advances in Flying Qualities

DTIC
ELECTE
JUN 22 1988
S D
CZ D

DISTRIBUTION STATEMENT A
Approved for public release
Distribution Unlimited

NORTH ATLANTIC TREATY ORGANIZATION



DISTRIBUTION AND AVAILABILITY
ON BACK COVER

88 6 22 146

AGARD-LS-157

NORTH ATLANTIC TREATY ORGANIZATION
ADVISORY GROUP FOR AEROSPACE RESEARCH AND DEVELOPMENT
(ORGANISATION DU TRAITE DE L'ATLANTIQUE NORD)

AGARD Lecture Series No.157
ADVANCES IN FLYING QUALITIES

Accession For	
NTIS CRA&I	<input checked="" type="checkbox"/>
DTIC TAB	<input type="checkbox"/>
Unannounced	<input type="checkbox"/>
Justification	
By	
Distribution/	
Availability Codes	
Dist	Avail and/or Special
A-1	



This material in this publication was assembled to support a Lecture Series under the sponsorship of the Flight Mechanics Panel of AGARD and the Consultant and Exchange Programme of AGARD presented on 26-27 May 1988 in Delft, The Netherlands, on 30-31 May 1988 in Rome, Italy and on 15-16 June 1988 in Torrance, USA.

THE MISSION OF AGARD

According to its Charter, the mission of AGARD is to bring together the leading personalities of the NATO nations in the fields of science and technology relating to aerospace for the following purposes:

- Recommending effective ways for the member nations to use their research and development capabilities for the common benefit of the NATO community;
- Providing scientific and technical advice and assistance to the Military Committee in the field of aerospace research and development (with particular regard to its military application);
- Continuously stimulating advances in the aerospace sciences relevant to strengthening the common defence posture;
- Improving the co-operation among member nations in aerospace research and development;
- Exchange of scientific and technical information;
- Providing assistance to member nations for the purpose of increasing their scientific and technical potential;
- Rendering scientific and technical assistance, as requested, to other NATO bodies and to member nations in connection with research and development problems in the aerospace field.

The highest authority within AGARD is the National Delegates Board consisting of officially appointed senior representatives from each member nation. The mission of AGARD is carried out through the Panels which are composed of experts appointed by the National Delegates, the Consultant and Exchange Programme and the Aerospace Applications Studies Programme. The results of AGARD work are reported to the member nations and the NATO Authorities through the AGARD series of publications of which this is one.

Participation in AGARD activities is by invitation only and is normally limited to citizens of the NATO nations.

The content of this publication has been reproduced directly from material supplied by AGARD or the authors.

Published May 1988
Copyright © AGARD 1988
All Rights Reserved

ISBN 92-835-0461-5



Printed by Specialised Printing Services Limited
40 Chigwell Lane, Loughton, Essex IG10 3TZ

THEME

Judging the suitability of an aircraft to safely and effectively perform its mission without undue pilot skill and discomfort is what "flying qualities" is all about. Central to such judgement, and to the design of suitable aircraft plus flight control systems, is an understanding of what the pilot can do with ease and comfort or conversely what bothers him. The Lectures are designed, collectively, to impart such understanding to both novice and seasoned practitioners in flying qualities and flight control and thereby to provide the bridge required to extend flying qualities requirements from simple "classic" response aircraft, to the much altered responses attending the use of full-time active control. It also provides a unifying connection among the empirically derived flying qualities requirements of different aircraft types, e.g. fixed- and rotary-wing.

Mathematical models of pilot control behaviour are fundamental and basic to such appreciation and interpretation, and are exposed and explained. The application of various models to flying qualities problems is discussed; and the influences regarding the generic likes and dislikes of pilots drawn from such studies are listed and catalogued. The effects of distractions due to excessive turbulence or due to secondary tasks or to required display scanning, both involving divided attention, are examined and treated.

For purposes of ready and universal "characterization", the aircraft plus flight control system (plus displays if applicable), which may be of quite high order, and have new "command" and "hold" modes of control is approximately matched by a lower order equivalent system of sufficient bandwidth to be indicative of the pilot's concerns. The fixed form representations for such equivalent systems and the "matching" considerations are described; and the experimental data base is also presented and discussed.

Finally, some of the pitfalls and benefits of using simulators for flight control system development and flying qualities research are exposed and clarified.

This Lecture Series, sponsored by the Flight Mechanics Panel of AGARD, has been implemented by the Consultant and Exchange Programme.

* * *

Le terme "Qualités de Vol" implique une évaluation de l'aptitude d'un aéronef à accomplir efficacement sa mission dans les conditions de sécurité requises, sans gêne excessive pour le pilote et sans l'obliger à dépasser les limites normales de sa compétence technique.

De même que pour l'étude d'aéronefs et de systèmes de commandes de vol adaptées, toute évaluation de ce genre passe par la compréhension de ce que le pilote est capable de faire aisément et sans gêne, ou, au contraire, de ce qui le gêne.

L'ensemble des exposés est organisé pour fournir une telle compréhension au débutants, comme aux spécialistes dans le domaine des qualités de vol et des systèmes de commandes de vol. Les conférences servent ainsi de "pont", indispensable à l'évolution des spécifications des qualités de vol des aéronefs à réponse "classique" vers une spécification qui tient compte des réactions tout à fait différentes engendrées par les commandes actives permanentes. Elles servent en même temps de lien qui permet d'intégrer les spécifications des qualités de vol obtenues empiriquement pour différents types d'aéronefs, par exemple à voilure fixe et à voilure tournante.

Les modèles mathématiques du comportement des commandes de pilotage sont fondamentaux et nécessaires pour de telles analyses et évaluations. Ils sont présentés et des explications sont données. L'application de différents modèles aux problèmes des qualités de vol est traitée. Les conséquences des préférences et des aversions des pilotes révélées par de telles études sont répertoriées. Les effets des distractions occasionnées par un excédent de turbulence, l'exécution de tâches secondaires ou par le balayage des visualisations nécessaires par le pilote, impliquant une division d'attention, sont examinés et traités.

Aux fins d'une "caractérisation" facile et universelle de l'aéronef et du système de commandes de vol (plus les visualisations, si nécessaire) qui peuvent être relativement sophistiquées et avoir des modes de commandes nouvelles du type "commande-maintien", on peut utiliser un système quasi-équivalent moins sophistiqué, dont la bande passante est suffisamment large pour être représentative des préoccupations du pilote. Les représentations de forme fixe de tels systèmes équivalents et les considérations "d'adaptation" sont décrites, et la base de données expérimentale sont également présentées et traitées.

Enfin, certains avantages et désavantages de la mise en oeuvre des simulateurs pour le développement des systèmes de commandes de vol et la recherche dans le domaine des qualités de vol sont exposés et de éclaircissements sont donnés.

Ce Cycle de conférences est présenté dans le cadre du programme des consultants et des échanges, sous l'égide du Panel AGARD de la Mécanique du Vol.

LIST OF AUTHORS/SPEAKERS

Lecture Series Director: Mr I.L. Ashkenas
Vice President
Systems Technology Inc.
13766 Hawthorne Blvd
Hawthorne, CA 90250-7083
USA

AUTHORS/SPEAKERS

Mr A.G. Barnes
Chief Simulation Engineer
British Aerospace Corporation
Warton Aerodrome
Preston PR4 1AX
United Kingdom

Mr R.H. Hoh
Principal Research Engineer
Systems Technology, Inc.
13766 Hawthorne Blvd
Hawthorne, CA 90250-7083

Dr M. Innocenti
Dept. of Aerospace Engineering
Auburn University
Alabama 36849-3501
USA

Mr D.T. McRuer
President
Systems Technology Inc.
13766 Hawthorne Blvd
Hawthorne, CA 90250-7083
USA

Dr H.A. Mooij
Head, Flight Division
National Aerospace Laboratory (NLR)
P O Box 90502
1006 BM
Amsterdam
The Netherlands

Mr R.J. Woodcock
Principal Scientist
Control Dynamics Branch
AFWAL/FIGC
Wright-Patterson AFB, OH 45433-6553
USA

CONTENTS

	Page
THEME	iii
LIST OF SPEAKERS	iv
	Reference
INTRODUCTION AND OVERVIEW by I.L.Ashkenns	1
PILOT MODELING by D.T.McRuer	2
PILOT MODELING APPLICATIONS by I.L.Ashkenns	3
LOW-SPEED LONGITUDINAL FLYING QUALITIES OF MODERN TRANSPORT AIRCRAFT by H.A.Mooij	4
ADVANCES IN FLYING QUALITIES: CONCEPTS AND CRITERIA FOR A MISSION ORIENTED FLYING QUALITIES SPECIFICATION by R.H.Hob	5
A SECOND LOOK AT MIL PRIME FLYING QUALITIES REQUIREMENTS by R.J.Woodcock	6
THE OPTIMAL CONTROL PILOT MODEL AND APPLICATIONS by M.Innocenti	7
THE ROLE OF SIMULATION IN FLYING QUALITIES AND FLIGHT CONTROL SYSTEM RELATED DEVELOPMENT by A.G.Barnes	8
BIBLIOGRAPHY	B

INTRODUCTION AND OVERVIEW

Irving L. Ashkenas
Vice President
Systems Technology, Inc.
13766 S. Hawthorne Blvd.
Hawthorne, CA 90250, USA

This lecture series is designed to offer a review of some basic flying qualities issues and concepts which can orient and enlighten newcomers to the field and enhance and simplify the transition from "old" to "new" aircraft projects for the more seasoned engineer. Such transition must recognize that the present directly-applicable flying qualities data are grossly inadequate to handle the growing dimensions of the "new" flying qualities "matrix" which continues to steadily and rapidly increase -- from classic to augmented aircraft, to full-authority command augmentation, to integrated flight, fire, propulsion control, to gust and load alleviation, to supraaugmentation, to supermaneuverability, to task-tailored flying qualities and who knows what next. Accordingly, it is not possible at this time, and probably never will be, to provide explicit experimentally-based guidance for all "new" control modes and combinations. Rather the basic idea is, and has been for a long time now (Ref. 1), to develop a viable theoretic framework and some supporting data, which can be used in a general and generic way to provide usable and useful guidance to the development of good flying qualities regardless of system structure.

So to begin with, let's define flying qualities and why they're important. There are a variety of definitions -- the lecture series abstract has one. Another is (Ref. 2), "those airplane characteristics which govern the ease or precision with which the pilot can accomplish the mission." Yet another (Ref. 1) is, "those -- properties of a vehicle that permit the pilot to fully exploit its performance and other potential in a variety of missions and roles -- (so that) limitations on the airplane do not originate in any kind of a pilot-vehicle control problem, but -- in some other design aspect." The point is, that safety, mission performance and response to auxiliary and emergency demands are all enhanced by good flying qualities, which basically embody three recognized facets:

1) Trim and Unattended Operation

The pilot must always be able to trim the airplane, hands off, so that he can, in fact, achieve an unattended state of operation in a reasonable length of time. Unattended operation relates to whether the airplane and flight control system is stable, or mildly to strongly divergent; and whether it can be left unattended while the pilot devotes some of his attention to tasks other than controlling the vehicle.

2) Large Amplitude Maneuvers

These are sometimes restricted by control power, sometimes by the nature of the response. In any case, the maneuver results from a programmed, largely open-loop, pilot input triggered by some cue or imminent danger, e.g., an attacking aircraft, gust upset, imminent collision, etc.

3) Regulation and Precision Flying

The pilot is now in closed-loop control, holding the airplane to whatever course or attitude he desires in the presence of wind and other disturbances, and furthermore, precisely maneuvering and controlling the vehicle down a given trajectory within applicable constraints.

The most difficult aspect of the first two categories is identification of the situations and circumstances to which they apply. Once this has been accomplished the analysis problem reduces to computing a response to a specified input; the pilot's role is basically as an observer or a skilled generator of open-loop, programmed commands. In the last category, however, the pilot dynamics are central and analytical treatment of the pilot-aircraft-display as a feedback system is essential; furthermore such analyses generally reveal the most critical, crucial and universal aspects of the flying qualities problem -- those that are the primary basis for pilot assessments. Accordingly, most of the lectures are devoted to explaining and elucidating use of closed-loop pilot-vehicle theory, methodology, and experimental correlates in the specification and identification of fundamental, pilot-centered flying qualities requirements.

For the benefit of some who may not be too familiar with basic closed-loop analysis we'll now identify some of the elements thereof. In the first place the Laplace-transformed, linearized, small perturbation, differential equations of motion, in matrix form, yield the input/output transfer function $G_A(s)$ of the vehicle itself. This is part of the total open-loop depicted in Fig. 1. The basic analysis problem is: given the open-loop $G(s)$ to find the closed-loop output/input transfer function $G/(1+G)$. The Fig. 2 example for $G(s) = K/s$ shows that the closed-loop characteristics are set by the open-loop (zero dB) Bode gain which in turn sets the crossover frequency, ω_c . The 90° phase margin (crossover phase +180°) results in closed-loop characteristics which are first-order. For a second order system the closed-loop damping ratio ζ_c , is related to the open-loop phase margin, ϕ_m , as depicted in Fig. 3; for these and more complex systems phase margins of about 40° yield "good" damping ratios near 0.3.

1-2

When we consider feedback systems involving more than a single loop, closure of the innermost loop proceeds as above with $G(s)$ expressed in terms of a characteristic denominator, A , and an output/input-specific numerator, i.e., referring to Fig. 1, $G(s) = N/A$. The successive additional loops each modify both the characteristic and the numerators as indicated in the Fig. 4 simple example (adapted from Ref. 3).

With these basic concepts now "refreshed," we're, hopefully, ready to listen and understand our first lecture.

REFERENCES

1. Ashkenas, I. L., "Twenty-Five Years of Handling Qualities Research," J. Aircraft, Vol. 21, No. 5, May 1984, pp. 287-301.
2. Hoh, Roger H., David G. Mitchell, Irving L. Ashkenas, Proposed MIL Standard and Handbook -- Flying Qualities of Air Vehicles Vol. I: Proposed MIL Standard, APVAL-TR-82-3081 (1), Nov. 1982.
3. McRuer, Duane T., Irving L. Ashkenas, and Dunstan Graham, Aircraft Dynamics and Automatic Control, Princeton University Press, Princeton, N.J., 1973.

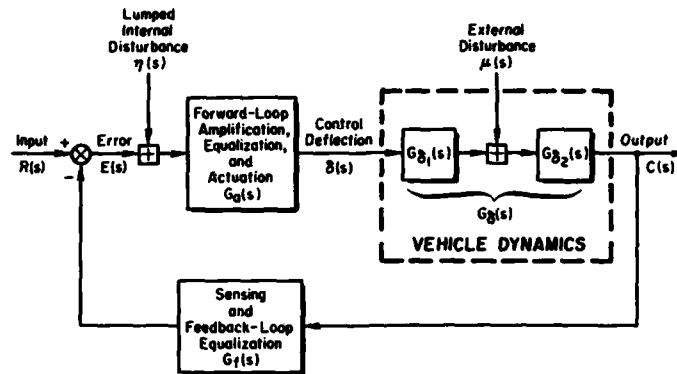

Open-Loop Transfer Function $G(s) = G_0(s)G_\beta(s)G_f(s)$

PROTOTYPE FEEDBACK SYSTEM

$$C(s) = G_0(s)G_\beta(s)R(s) + G_0(s)G_\beta(s)\eta(s) + G_{\beta_2}(s)\mu(s) - G_f(s)G_0(s)G_\beta(s)C(s)$$

or

$$C(s) = \frac{1}{G_f(s)} \left[\frac{G(s)}{1+G(s)} \right] [R(s) + \eta(s)] + \frac{G_{\beta_2}(s)}{1+G(s)} \mu(s)$$

$$E(s) = R(s) - G_f(s)C(s) = \frac{1}{1+G(s)} R(s) - \frac{G(s)}{1+G(s)} \eta(s) - \frac{G_f G_{\beta_2}(s)}{1+G(s)} \mu(s)$$

Figure 1. Elementary Feedback Control Relationships

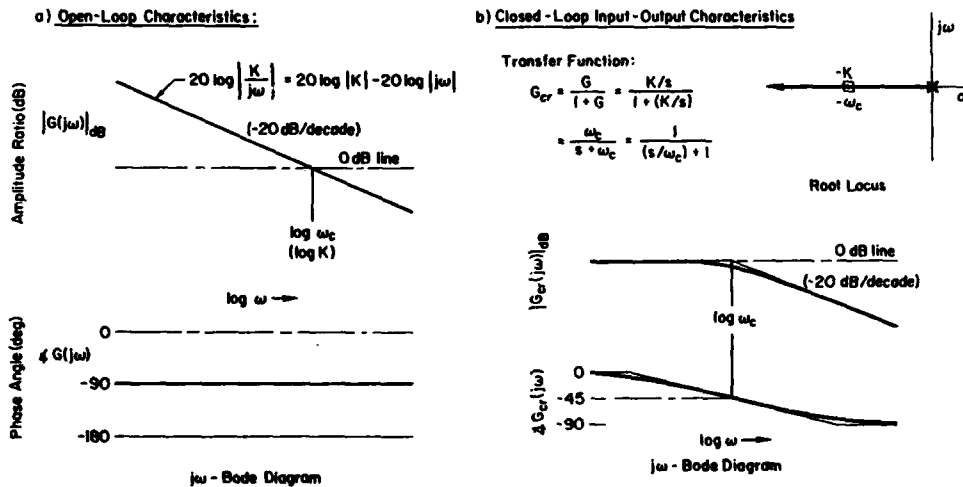

Figure 2. Open- to Closed-Loop Characteristics

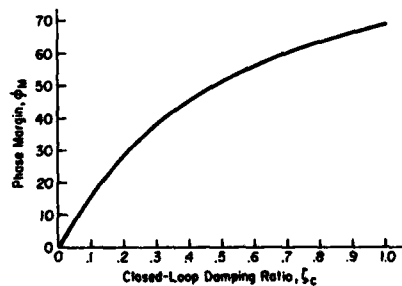

Figure 3. The relationship between the closed-loop damping ratio, ζ_c , and ϕ_M

Vehicle Equations

$$\begin{aligned} a_{11}\delta + a_{12}\phi + a_{13}r &= Y_{\delta_a}^* \delta_a + Y_{\delta_r}^* \delta_r \\ a_{21}\delta + a_{22}\phi + a_{23}r &= L_{\delta_a}^* \delta_a + L_{\delta_r}^* \delta_r \\ a_{31}\delta + a_{32}\phi + a_{33}r &= N_{\delta_a}^* \delta_a + N_{\delta_r}^* \delta_r \end{aligned}$$

Controller Equations

$$\begin{aligned} \delta_a &= f(\phi) = G_\phi(\phi_c - \phi) \\ \delta_r &= f(r) = -G_r r \end{aligned}$$

With the $f(r) \rightarrow \delta_r$ loop closed

$$\begin{aligned} a_{11}\delta + a_{12}\phi + (a_{13} + Y_{\delta_r}^* G_r)r &= Y_{\delta_a}^* \delta_a \\ a_{21}\delta + a_{22}\phi + (a_{23} + L_{\delta_r}^* G_r)r &= L_{\delta_a}^* \delta_a \\ a_{31}\delta + a_{32}\phi + (a_{33} + N_{\delta_r}^* G_r)r &= N_{\delta_a}^* \delta_a \end{aligned}$$

The ϕ/δ_a transfer function developed from this array, denoted as $(\phi/\delta_a)_{r \rightarrow \delta_r}$, is given by

$$\left(\frac{\phi}{\delta_a}\right)_{r \rightarrow \delta_r} = \frac{\begin{vmatrix} a_{11} & Y_{\delta_a}^* & a_{13} + Y_{\delta_r}^* G_r \\ a_{21} & L_{\delta_a}^* & a_{23} + L_{\delta_r}^* G_r \\ a_{31} & N_{\delta_a}^* & a_{33} + N_{\delta_r}^* G_r \end{vmatrix}}{\begin{vmatrix} a_{11} & a_{12} & a_{13} + Y_{\delta_r}^* G_r \\ a_{21} & a_{22} & a_{23} + L_{\delta_r}^* G_r \\ a_{31} & a_{32} & a_{33} + N_{\delta_r}^* G_r \end{vmatrix}}$$

After minor manipulation,

$$\phi_{\delta_a}^* \equiv \left(\frac{\phi}{\delta_a}\right)_{r \rightarrow \delta_r} = \frac{N_{\delta_a}^* \phi + G_r N_{\delta_a}^* \phi_r}{\Delta + G_r N_r \delta_r} = \phi_{\delta_a} \left[\frac{1 + G_r \frac{N_{\delta_a}^* \phi_r}{N_{\delta_a}^* \phi}}{1 + G_r R \delta_r} \right] \equiv \frac{N_{\delta_a}^* \phi}{\Delta}$$

$N_{\delta_a}^* \phi_r$ is identified as a "coupling numerator" defined by

$$\begin{aligned} N_{\delta_a}^* \phi_r &= \begin{vmatrix} a_{11} & Y_{\delta_a}^* & Y_{\delta_r}^* \\ a_{21} & L_{\delta_a}^* & L_{\delta_r}^* \\ a_{31} & N_{\delta_a}^* & N_{\delta_r}^* \end{vmatrix} = \begin{vmatrix} (s - Y_v) & Y_{\delta_a}^* & Y_{\delta_r}^* \\ -L_{\delta_a}^* & L_{\delta_a}^* & L_{\delta_r}^* \\ -N_{\delta_a}^* & N_{\delta_a}^* & N_{\delta_r}^* \end{vmatrix} \\ &= A_{\phi r} \left(s + \frac{1}{T_{\phi r}} \right) \end{aligned}$$

and is recognized as the characteristic determinant with terms in the ϕ and r columns replaced by aileron and rudder control effectiveness terms, respectively.

Figure 4. Multiple Loop Example Derivation

PILOT MODELING

Duane T. McRuer
President
Systems Technology, Inc.
13766 S. Hawthorne Blvd.
Hawthorne, CA 90250, USA

SUMMARY

The paper begins with a description of pilot control behavior in general. This is followed by emphasizing the essential features of pilot dynamics for closed-loop control of aircraft. The crossover model is presented as the simplest and most useful model for the majority of flying qualities analyses. Two models are developed in some detail: a structural-isomorphic form which accounts for some human subsystems as well as the total input-output behavior; and an algorithmic optimal control model which attempts to mimic the pilot's total response only. Both full and divided attention conditions are treated.

INTRODUCTION

The human operator in a man-machine system is the archetype hierarchical, adaptive, optimizing, decision-making controller. Control theories can also be classified using similar adjectives, so it is not surprising that almost every new advance in control theory has led to attempts to better understand additional aspects of human behavior in the perspective of this advance. Sometimes, but not always, these attempts have been fruitful, and a control theory paradigm has evolved which is useful in quantifying the human's operations. Just as theory has been used to "explain" experiment, so unexplained experimental results beget new theory. The results of this widespread synergistic activity have been documented in hundreds of research papers and in a series of summary surveys which have appeared aperiodically. (A chronological listing of surveys is given at the end of this paper, succeeding the reference list). As a consequence, much of the successful art is now mature. Furthermore, it has become a fundamental mode of thinking on the part of technical practitioners in the fields of operator/vehicle control system integration, vehicle handling qualities and, indeed, all aspects of interactive man-machine systems.

Besides the technological aspects of manual control, interdisciplinary activities between control engineers, physiologists, and experimental psychologists have led to control theory descriptions of human subsystem behavior and to the interpretation of the human's psychophysiological outputs in control engineering terms. These interdisciplinary areas have been especially productive in building psychophysiological models of those human subsystems involved in the human controller, in understanding biodynamics as affected by environmental variables, and in interpreting objectively the effects of alcohol, drugs, fatigue, etc., as operator impairments.

From this rich variety there are many aspects of man-machine control that could be addressed, but the emphasis here will be on a few examples particularly pertinent to flying qualities. Although the models treated do not represent an exhaustive cross-section of the field, they do include both classical and modern control theoretical viewpoints. We shall begin with a description of some of the ways in which humans behave as controllers and thereby introduce some of the mysterious complexities which face researchers in this field. From these starting points, the discussion will be contracted to emphasize human behavior in closed-loop compensatory systems, and the two currently predominant types of human operator modeling used to describe this behavior are discussed in some detail. The first of these is a structural model which attempts to account for many of the subsystem aspects of the human controller as well as the total input-output behavior. The second model treated is algorithmic, which primarily attempts only to mimic the human operator's total response.

THE SEVERAL NATURES OF MAN MACHINE CONTROL -- A CATALOG OF BEHAVIORAL COMPLEXITIES

The human pilot is complicated to describe quantitatively because of his enormous versatility as an information processing device. Figure 1 shows the general pathways required to describe human behavior in an interactive man-machine system wherein the human operates on visually sensed inputs and communicates with the machine via a manipulative output. This control system block diagram indicates the minimum number of the major functional signal pathways internal to the human operator needed to characterize different behavioral features of the human controller. The constituent sensing, data processing, computing, and actuating elements are connected as internal signal processing pathways which can be reconfigured as the situation changes. Functional operations on internal signals within a given pathway may also be modified. Thus, we have adaptation both of the pathways involved and of the functions performed. The specific internal signal organizational possibilities shown have been discovered by manipulating experimental situations (e.g., by changing system inputs and machine dynamics) to isolate different combinations of the specific blocks shown.

To describe the components of the figure start at the far right with the controlled element; this is the machine being controlled by the human. To its left is the actual

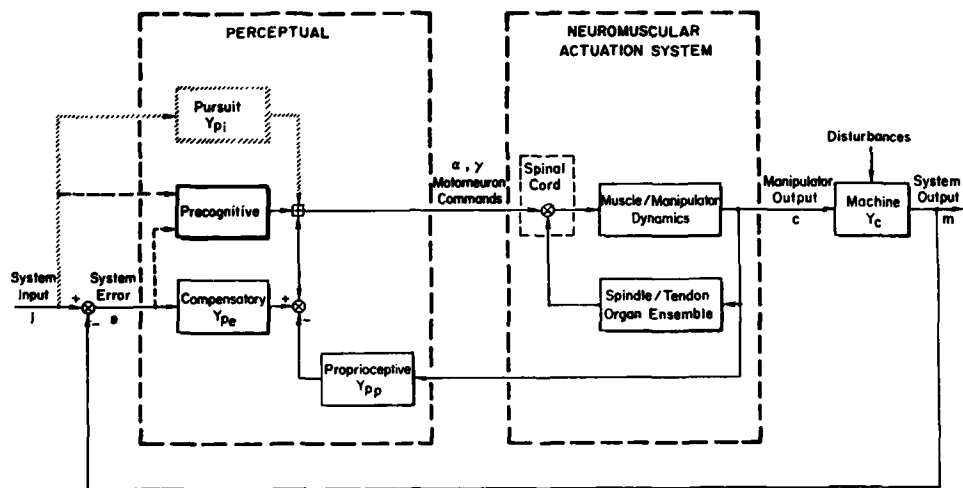

Figure 1. Major Human Pilot Pathways in a Pilot-Vehicle System

interface between the human and the machine -- the neuromuscular actuation system, which is the human's output mechanism. This in itself is a complicated feedback control system capable of operating as an open-loop or combined open-loop/closed-loop system, although that level of complication is not explicit in the simple feedback control system shown here. The neuromuscular system comprises limb, muscle, and manipulator dynamics in the forward loop and muscle spindle and tendon organ ensembles as feedback elements. All these elements operate within the human at the level from the spinal cord to the periphery.

There are other sensor sources, such as joint receptors and peripheral vision, which indicate limb output position. These operate through higher centers and are subsumed in the proprioceptive feedback loop incorporating a block at the perceptual level further to the left in the diagram. If motion cues are present these too can be associated in similar proprioceptive blocks with feedbacks from the controlled element output.

The three other pathways shown at the perceptual level correspond to three different types of control operations on the visually presented system inputs. Depending on which pathway is effectively present, the control structure of the man-machine system can appear to be open-loop, or combination open-loop/closed-loop, or totally closed-loop with respect to visual stimuli.

When the compensatory block is appropriate at the perceptual level, the human controller acts in response to errors or controlled element output quantities only. With this pathway operational, continuous closed-loop control is exerted on the machine so as to minimize system errors in the presence of commands and disturbances. Compensatory behavior will be present when the commands and disturbances are random-appearing and when the only information displayed to the human controller consists of system errors or machine outputs.

When the command inputs can be distinguished from the system outputs by virtue of the display (e.g., I and m are shown or detectable as separate entities relative to a reference) or preview (e.g., as in following a curved pathway), the pursuit pathway joins the compensatory. This new pathway provides an open-loop control in conjunction with the compensatory closed-loop error-correcting action. The quality of the overall control can, in principle, be much superior to that where compensatory acts alone.

An even higher level of control is possible. When complete familiarity with the controlled element dynamics and the entire perceptual field is achieved, the operator can generate neuromuscular commands which are left, discrete, properly timed, scaled, and sequenced so as to result in machine outputs which are exactly as desired. These neuromuscular commands are selected from a repertoire of previously learned control movements. They are conditioned responses which may be triggered by the situation and the command and control quantities, but they are not continuously dependent on these quantities. This pure open-loop programmed-control-like behavior is called precognitive. Like the pursuit pathway, it often appears in company with the compensatory operations as a dual-mode control -- a form where the control exerted is initiated and largely accomplished by the precognitive action and then may be completed with compensatory error-reduction operations.

The above description of pathways available for human control activities has emphasized the visual modality. Similar behavior patterns are present in the other modalities as well. Thus, man's interactions with machines can be even more extraordinarily varied than described here, and can range completely over the spectrum from open-loop to closed-loop in character in one or more modalities. Just what pathways of the overall system are present at a particular time depends on the detailed nature of the specific task at hand and the corresponding perceptual situation. All of the fundamental pathways are involved in various piloted-aircraft maneuvers. Thus all these features are potentially significant in vehicle flying qualities. In the sequel we shall, however, consider only the simplest form of closed-loop behavior -- compensatory operations.

COMPENSATORY OPERATION AND THE CROSSOVER MODEL

The compensatory pathways in the visual modality have been by far the most extensively studied in man-machine systems. Thousands of experiments have been performed, and most of the adaptive features of the human operator associated with these kinds of operations are well understood. Both classical control and optimal control theoretical formulations are available to predict steady-state and dynamic performance.

Figure 2 illustrates in vector block diagram form a general system configuration appropriate to closed-loop man-machine control. The diagram shows the human operating on a number of perceived quantities, $y(t)$, and exerting control over an aircraft ("controlled element") by actuating a number of controls, $u_n(t)$. The response of the controlled element to actuation of the controls and to disturbances is presented on a "display." As used here, display includes dynamic geometrical perspectives of the visual field, other visual stimuli present on physical display elements either on the aircraft or in the surround, and proprioceptive, tactile, aural, and other information impinging on the pilot. From the display the human separates the information needed for monitoring from that required for control purposes. Only the latter directly affects the human's operations as a controller, although both present attentional demands and thereby affect workload.

After receiving the displayed information the pilot internally selects and equalizes appropriate signals and sends the results on to the neuromuscular actuation subsystem for control action. The equalization and neuromuscular properties depend on the task variables (effective aircraft dynamics, display, and inputs); they in fact constitute the pilot's adaptive features whereby he attempts to offset any dynamic deficiencies of the remaining system elements. In the process of accomplishing control the human introduces observation, scanning, divided attention, equalization, and motor noises (together constituting "remnant"). These unwanted components of the operator's signals are functions of the task and the qualities of the display.

Two types of human operator models are available to handle the details in Fig. 2. The first is a multiloop, multi-modality model, based on describing functions, which is structurally isomorphic in that its component dynamics are intended to parallel the dynamics of more or less identifiable human operator subsystems. The emphasis is on cause and effect relationships having similarity in form and structural connections with those of the human operator. The second type of model is algorithmic. It uses linear-quadratic-gaussian optimal control theory, modified to permit a pure time delay and operator-induced noises to be given quantities along with the machine characteristics.

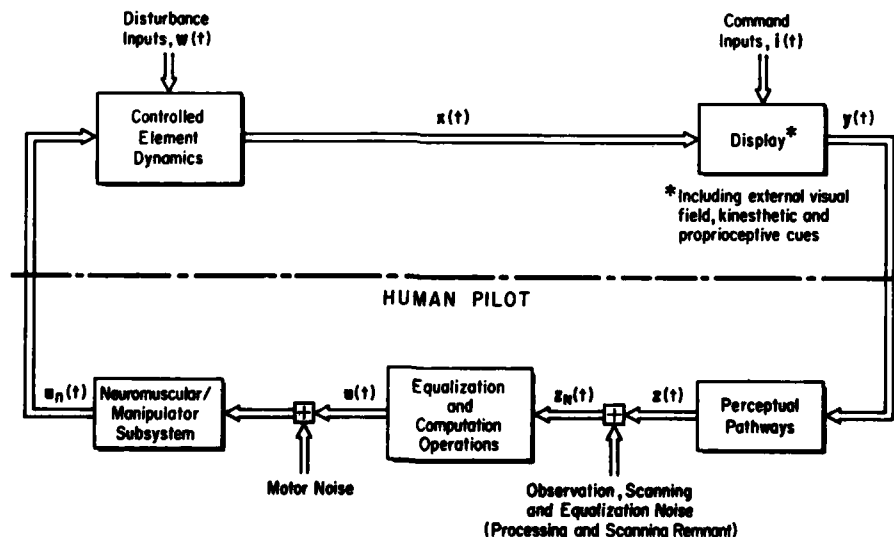

Figure 2. A Generalized Man-Machine System Structure

Both types of models represent the man-machine system as quasilinear in the sense that the response to a given input is divided into two parts -- a component which corresponds to the responses of equivalent linear elements driven by that input and a "remnant" or noise component which represents the difference between the response of the actual system and an equivalent system based on the linear element. Verbal-analytical instructions which express the adaptation of the human population to the task variables are an important formal feature of the structural isomorphic model and have counterparts, such as the specification of the performance index, in the algorithmic model form. For limited situations, both representations can be used to predict human operator dynamic behavior (in some sense), operator-induced noise (remnant), workload indices, visual scanning effects, and overall system performance such as mean-squared system errors and control activities.

The major fundamental differences between the models are their conceptual bases, i.e., causal and structural isomorphic as contrasted to algorithmic and (potentially) teleologic; the computational techniques associated with the exercise of the model; and the nature of model identification processes. At the present time there are other differences between the structural isomorphic and algorithmic models relating to their regimes of application and their validated capabilities for prediction. These latter differences are not, however, fundamental; instead, they reflect the relative maturity and extent of application.

Both the structural isomorphic and the algorithmic model approaches will be described below. As a preliminary let us first examine some of the general characteristics of human pilot dynamic response in compensatory man-machine systems by considering an elementary example. Figure 3a shows a display and functional block diagram of a simple single-loop man-machine system. The controlled element dynamics are given by:

$$Y_c = \frac{K_c}{s(Ts + 1)} \quad (1)$$

This could represent, for example, the idealized roll angle to aileron transfer function. The compensatory display presents the pilot with a visual stimulus which shows only the difference between the system forcing function and the system output. (Historically this is the definition of compensatory; modern usage applies the word compensatory to the situations wherein the human operates on errors regardless of the display details.) The pilot's task is to minimize the presented error signal by attempting to keep it superimposed on a stationary point or line on the display. This is accomplished by the manipulative control action $c(t)$ which affects the controlled element, and gives rise to the system output $w(t)$ being controlled. The usual purpose of a system of this nature is to make the system output closely resemble the system forcing function or, in other words, to make the output follow the input. The quality of the following is indicated by the system error, which is, of course, the operator's visual stimulus.

Figure 3b (Ref. 1) presents typical time histories in this system when a random-appearing forcing function is applied. The first thing to notice about the time histories is that the system output, w , does indeed follow the forcing function, i , very closely. Only a slight time lag keeps the output from being a nearly identical duplicate of the forcing function, although there are some small, random wiggles here and there on the output. On the other hand, the operator's output does not correspond at all well with the system error, even if the error is delayed. However, the operator output lagged by $(s + 1/T)$ is approximately proportional to the error signal delayed by 0.16 sec. Thus, as an approximation, the operator's transfer characteristic can be inferred to be:

$$Y_p = K_p(Ts + 1)e^{-Ts} \quad (2)$$

This result states that the operator develops a lead which is approximately equal to the first-order lag component of the controlled element dynamics and that the operator's response lags his stimulus by t sec. The open-loop man-machine transfer characteristic appears as:

$$G = Y_p Y_c = \frac{[K_p(Ts + 1)e^{-Ts}]K_c}{s(Ts + 1)} \quad (3)$$

$$= \frac{K_p K_c e^{-Ts}}{s} = \frac{\omega_c e^{-Ts}}{s} \quad (4)$$

The data of Fig. 4 illustrate how well this latter relationship is obeyed for a variety of subjects. The agreement with the amplitude ratio is excellent over a broad range of frequencies. The phase agreement is good in the region of the crossover frequency, ω_c , but departs somewhat at lower frequencies. Figure 4 also shows the extended operator model wherein a time constant, $1/\omega$, describes those phase contributions in the crossover region which arise from leads and lags (in the pilot and/or the rest of the system) which are present well below the crossover frequency band. This phase contribution is represented by $e^{-j\omega/\omega}$. It is an approximation not intended to extend to extremely low frequencies.

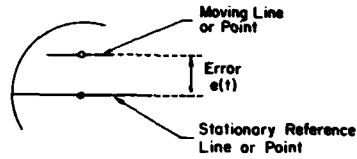

COMPENSATORY DISPLAY

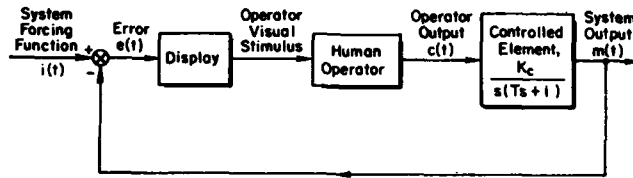

(a)

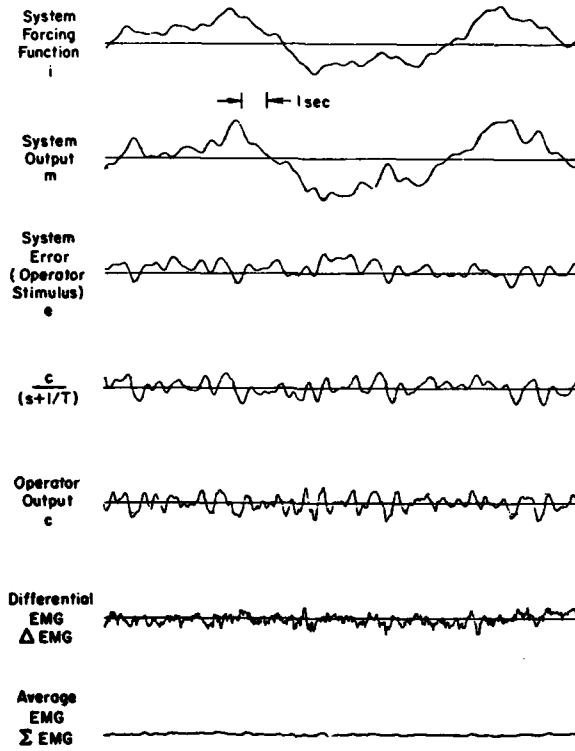

(b)

Figure 3. Simple Compensatory System and Operator Responses

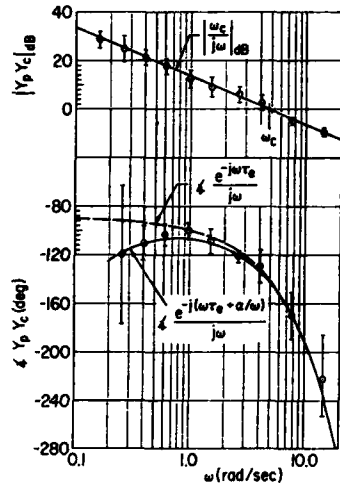

$$[\omega_c = 4.75 \text{ rad/sec}, \tau_0 = 0.18 \text{ sec}, a = 0.11 \text{ rad/sec}]$$

Figure 4. Data and Crossover Models for a Simple Rate-Control-Like Controlled Element

If now a large variety of controlled element forms are used and similar measurements are taken, the human transfer characteristics will be different for each controlled element. But, for a very wide range of controlled element dynamics, the form of the total open-loop transfer characteristic about the crossover frequency will remain substantially invariant. In other words, experiment shows that Eq. 4 has some pretension to general applicability. The effective time delay, τ , which is of course only a low-frequency approximation to all manner of high-frequency leads and lags, is not a constant. It depends primarily on the amount of lead equalization required of the operator, as shown in Fig. 5 (Ref. 1). This indicates that pilot equalization to offset controlled element dynamic deficiencies has an associated computational time penalty. With this proviso on τ , the Eq. 4 relationship becomes the well-known simplified crossover model of compensatory manual control theory. The human operator's adaptation to controlled element dynamics is implicit in the relationship, i.e., for a particular set of controlled element dynamics defined by Y_c the human will adopt a crossover region transfer characteristic $Y_p = \omega_c e^{-\tau s} / s Y_c$. The general form of the human's response would thus be determined by the specifics of Y_c , and changes in this task variable evoke changes in Y_p such that the crossover model open-loop transfer characteristic form is preserved.

The crossover model also applies when the machine dynamics are smoothly time varying (Ref. 2). The crossover frequency tends to be constant for a given set of task variables. It increases slightly as forcing function bandwidth is increased and is reduced for very small input amplitudes. This is a consequence of the operator's indifference threshold, which is the most important nonlinearity to be considered in connection with crossover model transfer characteristics.

The second component of the operator's response is operator-induced noise or remnant. This can, in principle, result from several sources, but in single-loop systems with linear manipulators the basic cause appears to be random time-varying behavior within the operator primarily associated with fluctuations in the effective time delay. This can be interpreted as a random change in phase, akin to a random frequency modulation, or to variations of internal sampling rate in a sampled data interpretation of the operator (Refs. 1, 3-6). In any event, the remnant is a continuous, relatively broadband, power spectral density which, as shown in Fig. 6, scales approximately with the mean-squared error (Refs. 4, 5).

Task variables other than the machine dynamics, as well as environmental and operator-centered variables, can change open-loop gain, effective time delay, and remnant. Accordingly ω_c and τ variations become a quantification of changes or differences in the task, environmental, and operator-centered variables expressed directly in terms of the operator's control actions. In measuring the effects of training for instance, ω_c increases with trials until stable conditions are obtained for that particular subject and set of constant task and environmental variables. Similarly, the remnant may also change as a function of the control situations. For instance, comparison of Figs. 6a and 6b shows the change in remnant bandwidth and level associated with the lead equalization required to offset controlled element lags. As another example Ref. 7 shows that operator gain is decreased and remnant is increased as a consequence of ingested alcohol.

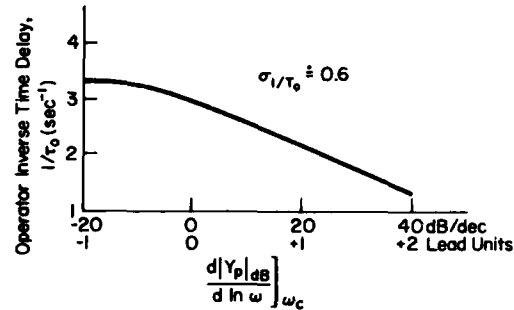

Figure 5. Variation of Crossover Model Dynamic Stimulus-Response Latency With Degree Of Operator Lead Equalization

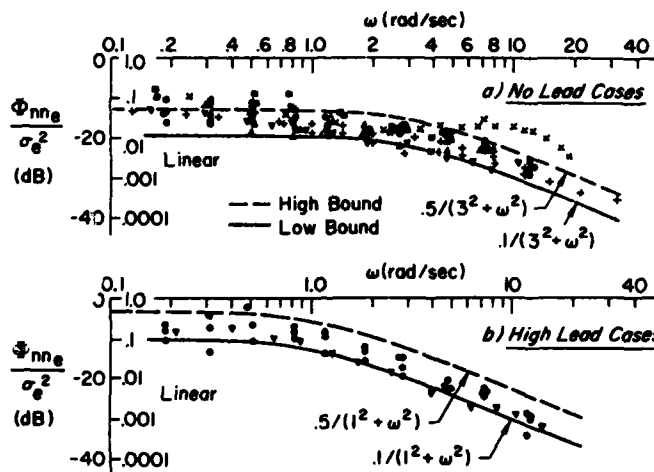

Figure 6. Normalized Remnant Spectra

To generalize these remarks, the total pilot actions can be thought of as that of an adaptive plastic sensory-motor link -- adaptive in that the pilot is task-adjusted to offset controlled element dynamic deficiencies and to respond to forcing function commands or regulate against disturbances; plastic in that the adaptive characteristics are further shaped by the external and internal (pilot-centered) environments. These behavioral features must be accounted for in either the structural isomorphic or algorithmic models. A general description of these models and some of their characteristics follows.

THE STRUCTURAL ISOMORPHIC HUMAN OPERATOR MODEL

The extensive analytical and experimental studies of closed-loop man-machine systems conducted since World War II have had as a principal goal the mathematical quantification of human dynamic behavior and the development of laws which permit this behavior to be predicted. In general, emphasis has been on the human operator as a complete entity rather than as a summation of functional subsystems.

In recent years, the precision and dynamic range of measurements taken with the total human operator have increased greatly -- to the point that certain of the measurements made over certain frequency ranges can be associated with the human subsystem dynamics. Thus, the study of the human operator as a whole has now arrived at the stage where not only must subsystem models sum up to be compatible with the total human dynamic model, but subsystem and total system studies can be directly related. Accordingly, control engineering descriptions of the overall human (see, e.g., the list of surveys), dynamical descriptions of the human motor coordination system, studies of predictive control conducted for physiological understanding, and studies of neuromuscular actuation systems, which were originally separated disciplines, now become united.

As described in Ref. 8, the adaptive and plastic properties of the operator permit the experimenter to set the stage and write a script calling for a particular form of action. Table 1 illustrates some of the experimental procedures which can be used to evoke various types of behavior.

By properly selecting combinations of these procedures and techniques, particular channels of human dynamic operations can be isolated, examined, and measured. Appropriate models which "explain" each of these varieties of behavior and which are also compatible with what is known from other views of experimental psychology and physiology can then be constructed to form a current version of the structural isomorphic model. One such construction, which is somewhat simplified, is given in Fig. 7. Here the controlled element and display blocks constitute the machine, whereas all the remaining detail reflects the man.

Starting at the far right is the neuromuscular actuation system. Because the man-machine system depicted here is operating on random-appearing signals which have essentially stationary statistics, the neuromuscular system is fluctuating about an operating point which in general corresponds to some steady-state or average tension. This is graphically illustrated by examination of the average and differential ENG signals shown

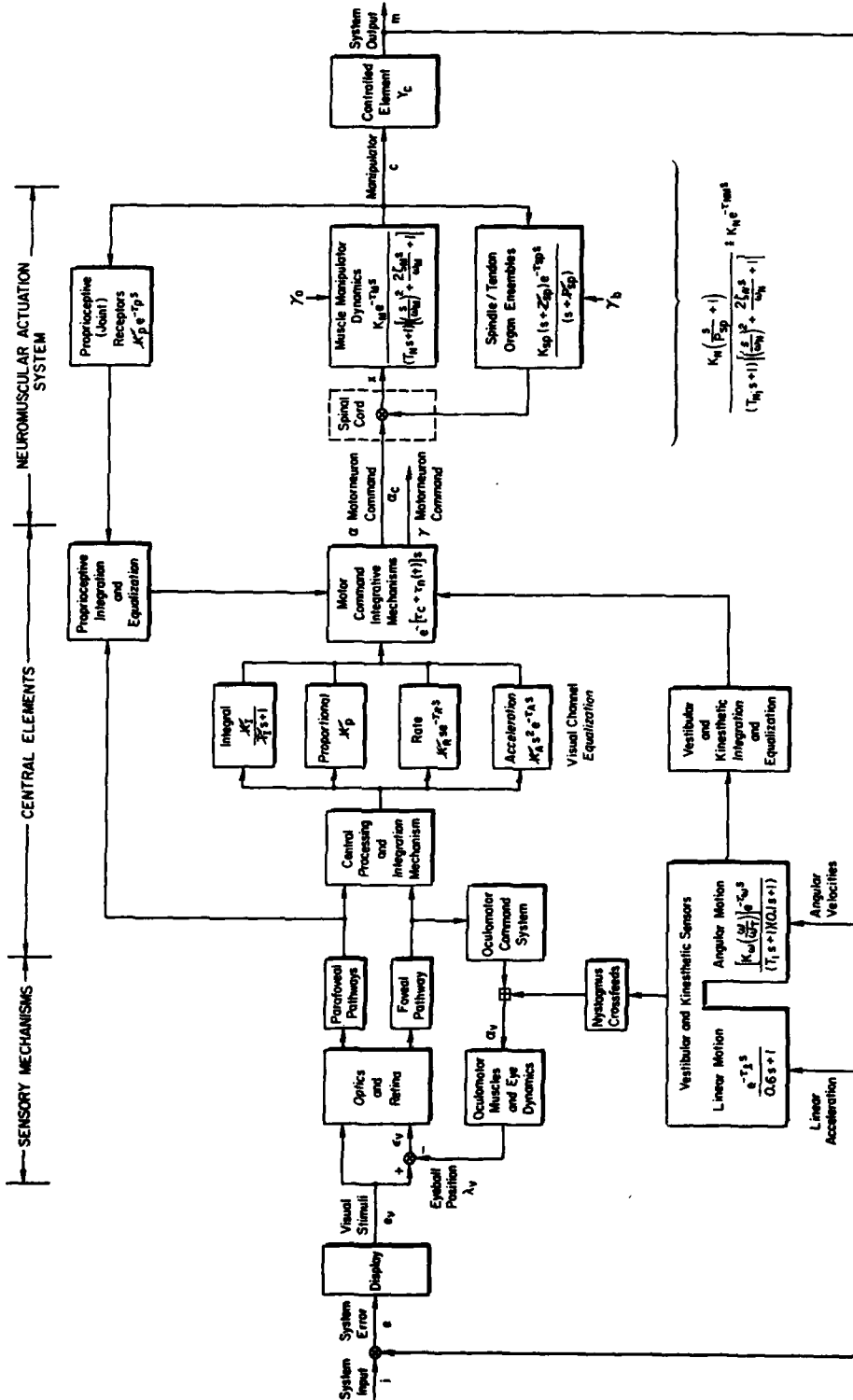

Figure 7. Structural Isomorphic Model of Man-Machine System

TABLE 1. EXPERIMENTAL PROCEDURES TO EVOKE HUMAN OPERATOR BEHAVIORAL CHANGES

PROCEDURE (EFFECTS)	BEHAVIORAL MODIFICATIONS (EXAMPLES)
Controlled Element Adjustment	Equalization changes and associated time delay increments
Manipulator Modification	Scaling of joint movement and force ranges; Activation of proprioceptive pathways
System Forcing Function Changes	
Bandwidth	Fine tune task-induced stress; Adjust average neuromuscular tension and associated time delay increments;
Amplitudes	Operator gain (for amplitudes near indifference threshold)
Additional Visual Inputs	Scanning, operator gains as affected by parafoveal and foveal viewing
Excitation of Additional Modalities	Activation of additional internal pathways (e.g., vestibular, kinesthetic) and consequent equalization changes
External Environmental Modification	Change task-induced stress; Differentially change some internal subsystem dynamics
Drugs	Modify operator-centered variables; Differentially affect various internal signal pathways

in Fig. 3b. Consequently, the dynamic operations of muscles, which can act only in contraction, can be treated as positive or negative fluctuations of many agonist/antagonist pairs about a steady tension bias value. This permits a great simplification in depicting the dynamic essentials in terms of a block diagram. The forward path of the neuromuscular system shown includes ensembles of muscles operating on coupled skeletal and manipulator dynamics. The feedback path sensors operating at the spinal level are primarily spindles and Golgi tendon organs. Because the individual actions of specific sensors are difficult to separate in the intact human the system shown has a feedback element labeled as spindle/tendon organ ensembles. The spindle characteristics may very well be predominant for the small motions and relatively light forces involved in most of the measurements thus far accomplished. The effective dynamics of the closed-loop neuromuscular system from the alpha motor neuron command signals to manipulator force can be approximated over a wide frequency range by the third-order transfer function shown. This form is also compatible with small perturbation dynamics based on experimentally verified analytical models of muscle and manipulator characteristics (Refs. 9, 10). The parameter values are strongly dependent on the steady-state neuromuscular tension, γ_0 , due to the gamma motor system. The gamma commands also affect the dynamics of the spindle ensembles and, in fact, provide another pathway (not shown) capable of actuating the neuromuscular system via the spindle ensembles. These features are pictured by the arrows indicating variation in the Z_{sp} and P_{sp} factors in the neuromuscular system feedback block and in the γ_0 and γ_0 inputs.

This rudimentary level of neuromuscular actuation system description is a minimum to have value even in gross physiological descriptions. It is an essential feature in the study of human pilot characteristics in vibratory environments (Ref. 11) and is also often needed for the study of limb/manipulator system dynamics in aircraft control (e.g., Refs. 12, 13). For many other man-machine system applications, however, the neuromuscular actuation dynamics are so high in frequency as to be relatively unimportant in their details. In these cases, a pure time delay, t_{nn} , or a first-order lag can be used as a low-frequency approximation.

The neuromuscular actuation system described thus far is appropriate when the manipulator is restrained by a stiff spring and the control actions involve very little joint movement. When significant joint movements are present, proprioceptive pathway elements enter into the neuromuscular actuation system dynamics. These derive from several sources, the most important being peripheral vision and joint receptors in the limb. These feedbacks act through higher centers and thereby exhibit larger response time delays. When they are present, the neuromuscular actuation system bandwidth may be reduced significantly.

Proceed now to the sensory mechanisms at the far left of the human operator. A good deal of the detail in the visual pathway is intended to emphasize the parallel operations of parafoveal and foveal vision and the control of eye movements. An important feature of the visual pathways is that essentially continuous signals from a particular display element can be available to the operator, by virtue of the parallel foveal and parafoveal pathways, even when the eye is scanning. The essence of past work in man-machine systems involving many displays (Refs. 1, 14-18) shows that:

1. A fairly stationary scanning strategy evolves for a given task and display array.
2. The operator's output control motions are much more continuous than a discrete sampling of input signals coincident with foveal eye fixations would imply.
3. The first-order effects of scanning are to reduce gain and increase remnant in the scanned channels.

The degree of gain reduction depends on parafoveal viewing angle and relative parafoveal to foveal dwell times.

The other sensory elements are vestibular and kinesthetic (Refs. 19-23), which are present when the pilot is moving, as in a maneuvering airplane or a moving base simulator. The pilot contains neurological elements capable of sensing rotary and linear accelerations. These are primarily in the vestibular apparatus, although other sensors and pathways can also be involved. The rotary motion feedbacks usually associated with the semicircular canals act like signals from a highly overdamped angular accelerometer. Over the frequency range from about 0.2 to 10 rad/sec the output signal is proportional to angular rate, so the sensor can function as a rate gyro. For prolonged steady turning the sensor washes out; thus, spurious sensations occur in steady rotations or when the turning motion stops. This pathway has a threshold on the order of 1-2 deg/sec. Because the rotary motion sensing apparatus gives rise to an angular-rate-like cue directly, any need for generating angular rate information by means of a lead equalized visual cue may be reduced. This feedback can also be thought of as an inner loop which tends to reduce the effective operator time delay in the visual pathway. For instance, in terms of crossover model characteristics, the presence of rotary motion can reduce the effective time delay for otherwise visual tasks by as much as 0.1 sec.

The other functional operation of the vestibular and kinesthetic pathways is the provision of the "nystagmus crossfeeds" to the oculomotor system. These produce involuntary eye motions as a function of the excitation of the vestibular apparatus. These eye movements can be helpful in properly directing the gaze, although many of their most interesting properties involve their effects in disorientation and illusions. The motion effects which conflict with the visual modality can seriously distort the operator's perception of the state of affairs and can be so severe as to affect the human's control capacity.

Turn now to the central elements. As shown there, the operator can develop a neuromuscular system input command which is the summation of a lag, proportional, lead, and double-lead function of the system error. The lag and proportional channels have a basic time delay, τ_c , associated with them. The higher derivative channels have additional incremental delays. These incremental time delays constitute the dynamic cost of lead generation. They are about 1/3 sec for rate, τ_r , and greater than 1/2 sec for the acceleration channel, τ_A . The proportional, rate, and acceleration equalization is shown as separate parallel channels primarily because of their respective latency differences. This independence of these channels is oversimplified, for common neurological apparatus is undoubtedly present for each function. These common elements are modeled here by the central processing and integration block preceding the visual channel and the motor command integrative mechanisms succeeding it. Besides the different time delays, the other evidence for parallel channels is the difference in response quality as a function of the low-frequency equalization supplied by the operator. For example, when very-low-frequency leads are present, as if operations were through the rate or acceleration channels, the operator's output tends to be more discrete and pulse-like than when little or no lead is required.

The channel gains and the time constant T_1 are all shown as variable quantities. These, in conjunction with the neuromuscular system variations with γ_0 , constitute the principal adaptive changes in the operator characteristics as display, controlled element, and environmental conditions change. For a given controlled element, these are of course adjusted such that the crossover model applies over its frequency range of validity. Thus, the extremely complicated structural isomorphic model reduces to the visual and/or vestibular equalization actually present and with neuromuscular dynamics as pertinent to the task. When a higher degree of exactitude is required, the structural isomorphic model is adjusted via a series of analytical/verbal rules which take into account the details of the task variables. A version of these rules is summarized below.

Equalization Selection and Adjustment

For aircraft applications a particular equalization is selected from the general form

$$\frac{K(T_1 j\omega + 1)}{(T_1 j\omega + 1)}$$

such that the following properties obtain:

- (a) The system can be stabilized by proper selection of gain, preferably over a very broad region.
- (b) Over a considerable frequency range in the unit gain crossover region (that frequency band centered on the crossover frequency, ω_c), the open-loop describing function $|T_p T_c(j\omega)|_{dB}$ has approximately a -20 dB/decade slope.

(c) $|Y_c Y_c(j\omega)| \gg 1$ at low frequencies to provide good low-frequency closed-loop response to system forcing functions (commands).

Examples of form selection and basic adjustment are provided in Table 2.

Time Delay Adjustment

Examples of time delay adjustment appropriate for aircraft are listed in Table 3. The visual lag and proportional channels have a basic (minimum) time delay, τ_v , of 0.1 sec associated with either or both of them when all other effects (e.g., motion sensing, full limb/manipulator neuromuscular system, and display computational lags) are represented separately; τ_v should be increased to 0.2 sec, if fixed-base operations are being considered with visual lag and/or proportional equalization, full neuromuscular system and separate display effects. If the neuromuscular system can be approximated by a pure delay, add T_{NM} to τ_v , where examples of values for T_{NM} are given in Table 3. The visual lead equalization has an additional incremental delay. This incremental time delay constitutes the dynamic cost of pilot lead generation in the visual modality.

Crossover Frequency with Full Attention

The factors involved in estimating crossover frequency, ω_c , with full attention to control activity consist of the following:

(a) Rectangular and quasi-rectangular forcing function spectra (discrete power-spectral densities that are essentially rectangular and low-pass continuous spectra with a high-frequency cutoff equivalent to a third- or higher-order lag filter).

(1) Basic crossover frequency, ω_{c_0} . The basic crossover frequency for quasi-rectangular forcing function spectra is found by adding the phase angle, $-\omega\tau_0$, due to the base effective time delay, to the phase angles of the controlled element and the previously estimated Y_p equalizer characteristics. Estimates for ω_c and the associated pilot gain are then made from the conditions for neutral stability,

$$\omega_{c_0} = \frac{\pi}{2\tau_0} \tag{5}$$

(2) Phase margin, ϕ_M . The phase margin for this forcing function category corresponds to an incremental time delay, $\Delta\tau_0(\omega_{c_0})$.

$$\phi_M = (0.08 \omega_{c_0}) \omega_{c_0} \tag{6}$$

(b) Low-pass with a roll-off of less than third-order and augmented (shelf-type) continuous input spectra.

(1) Continuous attention remnant. Approximations to the forms of injected remnant, ϕ_{nn} , when reflected to the pilot's input signal under conditions of continuous attention were shown in Fig. 6.

$$\frac{\phi_{nn}}{\sigma_e^2} = \begin{cases} \frac{(0.1 \text{ to } 0.5)}{(\omega^2 + 3^2)} & \text{where integral and/or proportional equalization are used} \\ \frac{(0.1 \text{ to } 0.5)}{(\omega^2 + 1)} & \text{where lead equalization is used} \end{cases} \tag{7}$$

$$\text{where } \sigma_e^2 = \int_0^\infty \phi_{nn}(\omega) d\omega$$

(2) Nominal crossover frequency, ω_n . With equalization and effective time delay, τ_0 , selected as above, the nominal crossover frequency, ω_c , and associated pilot gain is estimated from the condition to provide minimum mean-squared error in the presence of the appropriate form of continuous attention remnant in Item (b)(1) above. The nominal cases (continuous remnant magnitude set to the geometric mean of the values cited above) are:

	ω_c / ω_n
<u>No Pilot Lead:</u>	0.783
<u>Low-Frequency Pilot Lead:</u>	0.662

where ω_n is the maximum full attention crossover frequency at the dynamic stability limit corresponding to zero phase margin ($\phi_M = 0$). Thus $\omega_n = \pi/2\tau_0$.

TABLE 2. TYPICAL PILOT EQUALIZATION CHARACTERISTICS

EXAMPLE OF CONTROLLED ELEMENT	CONTROLLED ELEMENT APPROXIMATE TRANSFER FUNCTION IN CROSSOVER REGION	PILOT EQUALIZER FORM	EQUALIZER ADJUSTMENT		
			LOW-FREQUENCY ($\omega \ll \omega_c$)	MID-FREQUENCY (ω_c REGION)	HIGH-FREQUENCY ($\omega > \omega_c$)
Perfect ACAR	K_c	Lag-Lead	$1/T_L$	--	T_L to partially offset $\tau + T_{NM}$
Rate Command	$K_c/j\omega$	High-Frequency Lead	--	--	T_L to partially offset $\tau + T_{NM}$ ($T_L \omega_c < 1$)
Lateral Course Displacement	$K_c/(j\omega)^2$	Low-Frequency Lead	$1/T_L$	--	T_L not available to offset $\tau + T_{NM}$
Roll Control	$K_c/j\omega(Tj\omega + 1)$	Mid-Frequency Lead	--	$T_L = T$	--
		High-Frequency Lead	--	--	T_L to partially offset $\tau + T_{NM} + T$
Practical ACAR	$\frac{K_c}{(\frac{j\omega}{\omega_n})^2 + \frac{2\zeta}{\omega_n} j\omega + 1}$	Low-Frequency Lead $\omega_n \ll 1/\tau$	$1/T_L$	--	--
		Lag-Lead $\omega_n \gg 1/\tau$	$1/T_L$	--	T_L to partially offset $\tau + T_{NM}$

TABLE 3. TIME DELAY ADJUSTMENT

Effective Visual Delay, τ_v	Qualifications
$\tau_{v\text{minimum}} = 0.1$ sec Add T_{NM} to τ_v Add 0.1 sec to τ_v Add another increment to τ_v as a function of the lead equalization, T_L	Other effects (e.g., motion sensing, limb-manipulator-neuromuscular system, display computations) are represented by their separate dynamics in Fig. 5 If neuromuscular system dynamics are not represented -- where $T_{NM} = 0.1$ sec, if manipulator is stiff (isometric) or $T_{NM} = 0.2$ sec, if manipulator is freely moving (isotonic) If fixed base operations are being considered Refer to figure below for first-order and add $\Delta\tau_v = \frac{1}{2.5 + 0.206/T_L} - 0.25 \text{ sec}$
<div style="text-align: center;"> ○ Moving Base Data × T-33 Flight Data </div> <p style="text-align: center;">$\frac{1}{\tau_e} = 2.5 + \frac{0.206}{T_L} \text{ (1/sec)}$</p>	

- (c) **Nominal crossover frequency regression.** When ω_1 nears or becomes greater than $0.8 \omega_c$ for the quasi-rectangular forcing function case or when ω_1/ω_c is greater than 1 for the low-pass and augmented low-pass spectra, then the crossover frequency regresses to values much lower than ω_{c0} and ω_c , respectively.
- (d) **Nominal crossover frequency invariance properties.**
 - (1) $\omega_c - K_c$ independence. After initial adjustment, changes in controlled element gain, K_c , are offset by changes in pilot gain, K_p , i.e., nominal crossover frequency, ω_c , is invariant with K_c .
 - (2) $\omega_c - \omega_1$ independence. Nominal crossover frequency increases only slightly with forcing function bandwidth until crossover frequency regression occurs.
- (e) **Threshold properties.** With very low stimulus amplitudes, a threshold characteristic should be included in series with the pilot's describing function. Also, when full-attention, nearly continuous control actions are not required, an indifference threshold is likely to be present. Both of these lower ω_c from what would be estimated using the above adjustment rules.

The ω_c regression phenomenon mentioned in the adjustment rules refers to a reduction of pilot gain and, hence, of crossover frequency when the forcing function bandwidth becomes too large. The reason for this is best described by referring to the relative mean-squared error plotted in Fig. 8 for the crossover model subjected to a rectangular forcing function spectrum. If the ratio ω_1/ω_c is less than about 0.8, an increase in normalized gain ($\tau_c \omega_c$) will result in a decrease in normalized mean-squared error. When this approximate inequality is reversed, the normalized mean-squared error can become greater than 1 as gain is increased. The trend, therefore, for high forcing function bandwidths is to reduce gain. This regression effect has practical consequences whenever the pilot is required to track broadband signals.

The adjustment rules given above are generally adequate for the pilot's lower-frequency dynamics in tasks with spring-restrained manipulators. The higher-frequency properties due primarily to the neuromuscular actuation system are included only to the extent that T_{NM} is a component of τ_c .

The neuromuscular system dynamics will change markedly as the manipulator load dynamics are modified. One of the most important of these possible modifications is reduction in stiffness of the spring restraints. This is a common feature of aileron controls, as opposed to elevator and rudder controls. When the spring forces are light, the manipulator approaches the free-moving (isotonic) extreme. In these cases, the pilot must supply proprioceptive feedbacks that introduce into the neuromuscular system dynamics additional delays that are not present with the isometric situation. Available data from Refs. 10, 24, 25 indicate that the effect of this proprioceptive feedback required of the pilot when the manipulator is free-moving is to increase the effective time delay by approximately 0.1 sec. This can be added directly to the previously discussed time delay, τ_c . It amounts to an additional time delay cost incurred by forcing the pilot to close a positional loop about the manipulator.

For some configurations of manipulator and effective vehicle dynamics, the higher frequency characteristics of the neuromuscular system can be important. In particular, the peaking tendency associated with the second-order mode in the limb/manipulator block of Fig. 7 can be sufficiently large to make a higher frequency gain margin (in the frequency range from 2 to 3 Hz) negligible or even negative. Whether this will lead to an instability will depend on the accompanying phase. Such very high frequency pilot-effective vehicle oscillations as "roll ratchet" can be caused by this coupling. The detailed nature of the peaking tendency is a very strong function of the manipulator and the rest of the controlled element dynamics. The peak can be "tuned" to a maximum or minimum by the presence of just the right amount of controlled element lag. Thus, for example, a pure $Y_c = K/s$ will have little if any peaking while a $Y_c = K/s(Ts + 1)$, with T about 0.1 sec, will have a great deal. The known connections are all empirical; therefore, the reader is referred to Refs. 12 and 13, which present all of the available data.

Another "structural model" of the human pilot has been fruitfully applied to flying qualities problems (Refs. 26-29). This model makes most of the adjustments of the pilot equalization via feedback pathways instead of in the forward loop, and the "isomorphic" features are not modeled. A good deal of effort has been spent on validation with the existing data base, and with developing connections with pilot ratings via the theory of Ref. 29.

Having completed this review of the structural-isomorphic and crossover pilot models for full attention situations, we next examine relationships between pilot workload and pilot dynamics which will help to treat divided attention situations involving control operations.

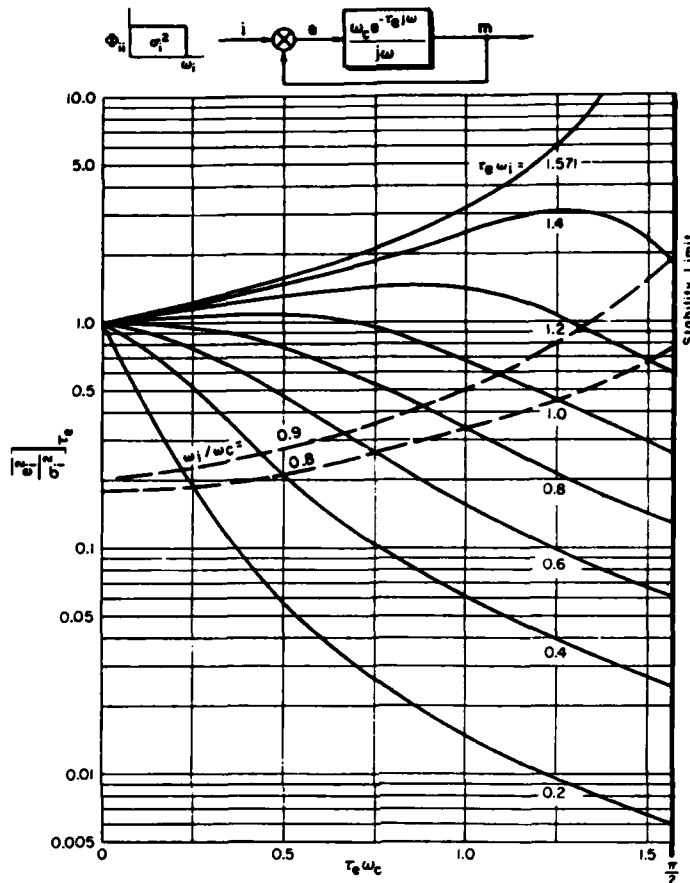

Figure 8. Mean-Squared Error Based on Crossover Model

DIVIDED ATTENTION PILOT-VEHICLE-TASK MODEL

The pilot is, in general, involved in two types of operations -- control tasks and a diverse combination of monitoring/supervising/communicating/data-gathering/decision-making activities referred to as "managerial" tasks. While the pilot's attention is "divided" between the "control" and "managerial" tasks, these are often performed nearly simultaneously as parallel processing operations. Neither type of task is necessarily primary or secondary.

In the most complex or demanding mission phases, the two task categories may require all of the pilot's available attention. These high workload mission phases have a major impact in design, because, as tasks that are critical for either control, decision making, or human error potential, they provide the context in which system roles are established and human and equipment resources are allocated.

The managerial tasks often result in discrete action sequences. For many of these, the skilled and experienced pilot has developed a nearly routine, highly rehearsed, response repertoire to meet normal and many unusual demands. These types of nearly automatic action sequences are subject to "slips" of intention or execution, also referred to as "absent-minded errors." A commonly-cited example of a slip is the pilot's failure to lower the landing gear or flaps due to distractions like voice communications and in-cockpit warning alarms. Current studies of cognitive behavior, associated with human error (e.g., Ref. 30), emphasize that slips are most likely to occur under divided attention conditions.

For a given situation, the minimum divided attention level will be established by the control tasks. Consequently, we need a divided attention model for control operations. The model should provide such results as:

- The nature of control task performance degradation due to divided attention
- An indication of the attentional demands required for various levels of control activity and the excess capacity left for managerial tasks.

An elementary model suitable for such purposes is summarized below. It places heavy emphasis on both the attentional demands for control tasks and the excess capacity left for managerial tasks. These are quantitative indices. The attentional demand for control is equal to the average "control dwell fraction" ($0 < n < 1$), while the "excess capacity" left over for other operations is the average "control interrupt fraction" ($1-n$). The control interrupt fraction is therefore also termed the "managerial dwell fraction."

The theory of divided attention operations can be considered as an extension to the well-established theory of display scanning and signal sampling/reconstruction (Refs. 1, 15, and 31). In the control task, the human pilot's behavior can again be characterized in mathematical terms by describing functions that depend on the effective dynamics of the aircraft being controlled, the dynamics of the pilot-vehicle interfaces (displays and controllers), and a "remnant." These two components are depicted in the block diagram of Fig. 9, wherein the dynamics of the effective pilot-vehicle system are characterized by the crossover model described previously. Far more elaborate models of the pilot are possible, but the crossover model is quite adequate to characterize matters at the level needed here.

Recall that, when the pilot's full attention is focused on the control task, the crossover frequency, ω_c , of the pilot-vehicle system is maximized consistent with near minimum mean-squared error. The closed-loop performance issue is handled by a minimization process that arises from a compromise in following the command input while reducing the relative influence of the remnant. The remnant in full attention operations is a broadband random process that can be considered as a pilot-induced noise.

When managerial tasks are also considered, both the describing function and the remnant characterizing the pilot's control behavior will be affected by the divided attention nature of the pilot's total operations. The describing function and remnant will be modified to account for the additional signal processing or supplementary parallel sensing needed to continue control operations while the pilot is attending to the managerial tasks. Depending on the specific details, these modifications may reduce the effective pilot gain, add to the effective time delay, and/or increase the injected noise. Thus the system crossover frequency will be reduced simultaneously with an increased contribution of noise to the uncorrelated system error. Both effects will cause the precision of control task performance to be reduced from a full attention baseline. Similar modifications to the pilot-vehicle dynamics are made even with full-attention control operations when the visual cues are modified to call for divided visual attention, for example, in changing from head-up visual meteorological conditions (VMC) to the head-down instrument panel scanning needed for manual approach in IMC operations.

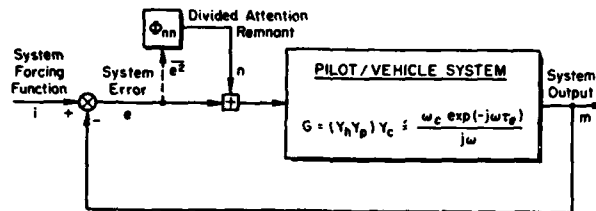

- Y_c = Effective dynamics of vehicle (e.g., aircraft plus stability augmentation plus displays)
- Y_p = Full attention pilot describing function
- Y_n = Perceptual describing function to account for divided attention
- ω_c = System crossover frequency
- τ_e = Overall pilot-vehicle system effective latency
- ϕ_m = System phase margin ($\pi/2 - \tau_e \omega_c$)
- Φ_{nm} = Processing remnant spectrum ($n^2 \sim e^2$)
- e^2 = Mean squared system error

Note: $e(t)$ is "error" and subscript "e" in τ_e is "effective"

Figure 9. Pilot-Vehicle System for Divided Attention Control Task

In the divided attention situations of primary interest, it is assumed that the pilot has been well trained in the control and managerial tasks involved. His attention is allocated among control and managerial tasks in which information is simultaneously gathered from several "perceptual fields." These fields may include:

- | | |
|---------------------------|---|
| Visual "Segments" | |
| Foveal | } |
| Parafoveal | |
| Peripheral | |
| Proprioceptive "Segments" | |
| Vestibular | } |
| Joint receptors | |
| Stretch receptors | |
| Pressure receptors | |
| Etc. | |
| Aural "Segments" | |
| Tactile "Segments" | |

and others. The word "segment" is intended to convey the properties of extent, thresholds, input/output dynamics, etc., that characterize the particular sensory modalities involved as they are integrated into useful perceptual signal sources. The easiest to describe are the visual perceptual field segments, which can be divided on a physiological basis into foveal, parafoveal, and peripheral pathways. Besides the differing spatial (geometric) extent of these segments there are also differences in threshold, dynamic properties, contrast background, etc.--all the bewildering complexities associated with vision in its myriad details. For our purposes here, the key point to understand is that a visual "display" can be attended to not only with the foveal segment but also with the parafoveal. Thus a control task not requiring the high acuity property of foveal vision could involve sharing between the foveal and parafoveal pathways for control, with attentional adjustments of the foveal pathways between the control operations and elsewhere (e.g., reading information, conducting visual search, etc.). The "perceptual scanning" process in this case is the "switching" of the input signals for the pilot's control task from the foveal plus parafoveal to the parafoveal alone pathways.

"Perceptual scanning" is, of course, more general than the simple shifts between foveal and parafoveal visual pathways serving to provide continuous information to the pilot from a visual display. All of the other perceptual fields for each input modality are also operating more or less continuously and providing signals that impinge on the pilot's sensorium. Although all of these data inputs are present, they are not necessarily acted upon simultaneously. However, in the highly trained, unimpaired pilot, the inputs delivered from several perceptual fields may be, in some sense, "operated on" in parallel all of the time. One feature of "impairment" is a reduction in this capacity of parallel or nearly simultaneous operations in different input channels.

A related concept needed here is that of "attention," adding to the ability to sense and perceive stimuli a readiness to respond to selected stimuli. By analogy with visual perception, we can conceive of an attentional field having a principal focus and borders. Attentional fields have both spatial and intensive aspects. Thus inattention or impaired attention can result in a narrowing of the spatial borders, an increase in the minimum stimulus needed to cause an operator output, or both. A common example is "tunneling" of vision ("gunsight vision") wherein, under highly stressful conditions, the visual perceptual field is narrowed. As far as active pilot control processes are concerned, the perceptual scanning and attentional field features are joined; that is, all manner of perceptual inputs are impinging on the pilot at any one time, but the attentional foci serve to activate selected perceptual fields as sources of control or managerial task "signals."

The pilot's primary attention may be shifted from one signal source to another in the course of conducting a particular mission phase. Yet, when a control task is involved, it must be attended to from time to time. So, too, for the managerial tasks. In the course of operational training, the pilot learns to switch primary attention from one task element and/or perceptual segment to another, and then another, and back to the first, etc. This is conveniently thought of as a perceptual scanning process. When the pilot finally becomes skilled in the operational scenario, the scanning behavior over the task duration exhibits certain stable properties in a statistical sense. For instance, the proportion of the time spent on a particular input-gathering chore, the dwell times on certain instruments, and the total time before prominent features of the scanning process are repeated tend to develop stable probabilities. This is not to say that the scanning is either periodic or uniformly sequential (i.e., from "A" to "B" to "C" and back every time) but rather that cyclical activity is present in the perceptual scanning process.

Control tasks conducted under divided attention conditions both in flight and laboratory research have shown that the coverage of elements (e.g., instruments or perceptual fields) in a given array of input sources has a definite average frequency and corresponding mean sampling interval, T_s , albeit with appreciable variance. The mean "control dwell time," T_d , is the time spent on information sources needed for control purposes. Its duration depends on what information has to be extracted. The ratio of these two times gives the "control dwell fraction," $n = T_d/T_s$, which indicates, on the average, the proportion of the total control plus managerial task scanning time interval required by the control task.

The information transfer characteristics of the divided attention attributes of the human controller may be modeled as a quasi-linear, random-input "perceptual describing function," Y_h . This multiplies the full-attention (continuous control) human describing function(s), Y_p , to provide the describing function(s) for the human pilot's control activities.

The simplest way to develop an internal signal from a finite duration sampled input is to act proportionally to the sampled signal. Then, during the fixation period, T_d , the pilot's output would be proportional to the perceptual input being sampled, while outside the fixation period, it will be zero (see Fig. 10, lines a and b). The describing function is based on the best linear fit of the output, in the mean-squared sense. For this simple finite dwell time sampling, the perceptual describing function is just the dwell fraction itself, $Y_h = n$. The "remnant" accounts for all of the pilot's higher frequency power not linearly connected with the input. The describing function and remnant are shown on line c of Fig. 10 (Ref. 15). [It is important to emphasize that the signals shown in Fig. 10 are highly idealized for clarity. Everything is really much more random: the signals themselves, the dwell times (T_d), and the sampling intervals (T_s).]

From Fig. 10 it is easy to see, as the divided attention level is changed to reduce the control dwell fraction, n , that

- The describing function, Y_h , is reduced
- The remnant is increased

The crossover model in Fig. 9 shows that a reduction in Y_h will cause a concomitant reduction in the pilot-vehicle system crossover frequency, ω_c . For the crossover model, ω_c is also the pilot-vehicle system loop gain. This is directly related to the system phase margin, ϕ_M , by

$$\phi_M = \frac{\pi}{2} - \tau_e \omega_c \quad (8)$$

where τ_e is the overall pilot-vehicle system latency, so the reduction in ω_c will be reflected in increased phase margin.

As can readily be appreciated from the above discussion, the effects of divided attention can have profound consequences on the pilot-vehicle system performance in control activities. These can be conveniently summarized by the illustrative case sketched in Fig. 11. As already noted, divided attention results in lower crossover frequency and associated increased phase margin. As far as the pilot-vehicle system dynamics are concerned, a major consequence is a significantly increased error in control activities. As shown in Fig. 11, divided attention penalizes the error performance in two ways:

- By reduction of the permissible crossover gain, and
- By a major increase in the remnant due to the divided attention (i.e., lack of attention to the control tasks).

Figure 11 shows that the full attention pilot-vehicle system error begins to increase only as the dynamic stability limit is approached; at lower gains, error is reduced as gain increases. While a similar trend is shown for divided attention, the error may still increase without bound for circumstances where there is still a large dynamic stability margin. This is because the closed-loop effect of divided attention remnant, the power level of which scales with mean-squared error as in Weber-law noise, causes error signal instability in the mean-squared sense (Refs. 15 and 32). From the analyst's point of view, this property of control tasks with divided attention requires a larger phase margin (even more stable operation of the control task than with full attention) as the control dwell fraction is decreased.

A Weber-law model of divided attention remnant has been applied to the error signal in the "crossover law model" shown in Fig. 9 (Refs. 15, 33 through 36). The model of divided attention remnant includes factors representing average attentional dwell time fraction (on the control task) and variability thereabout. A quantitative example of the effects of divided attention on performance is presented in Fig. 12. In Fig. 12a, the abscissa is normalized crossover frequency (analogous to Fig. 11), while Fig. 12b provides the same data plotted with phase margin as the abscissa. The forcing function is white noise passed through a third-order Butterworth filter with normalized break-point $\omega_1 \tau_e = 0.25$. The full attention condition is the lowest curve in both portions of Fig. 12. The divided attention conditions that govern the remnant are shown as families with control task dwell fraction, n , as the parameter. In this example, the normalized

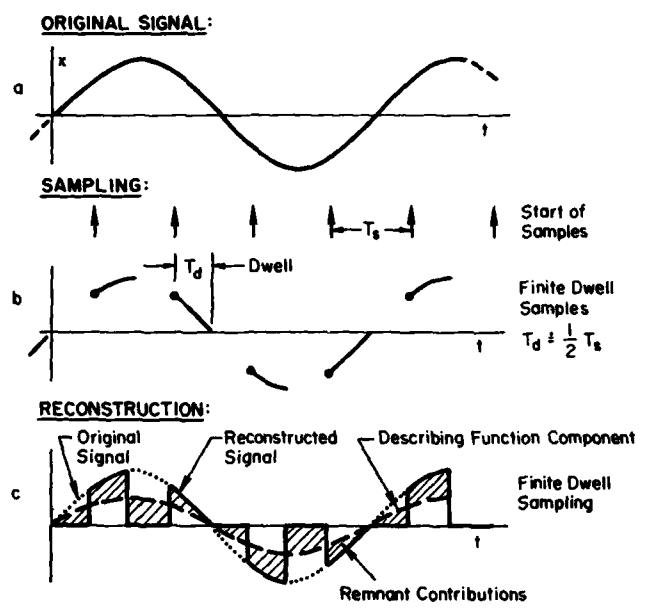

Figure 10. Features of Finite Dwell Sampling

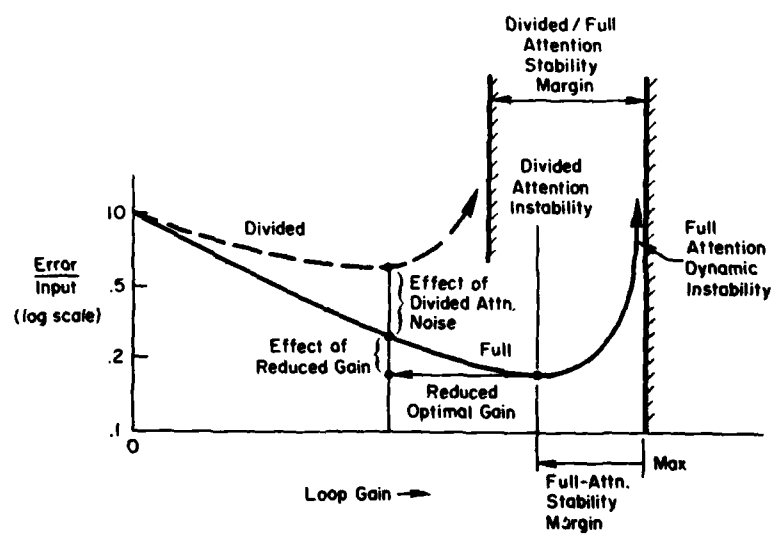

Figure 11. Consequences of Divided Attention

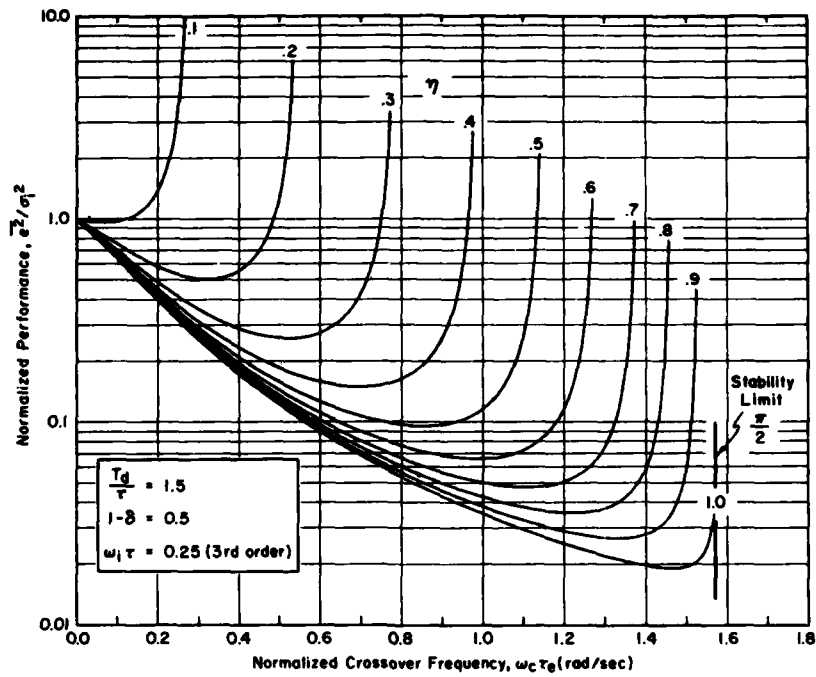

Figure 12a. Effect of Divided Attention Remnant on System Performance as a Function of Normalized Crossover Frequency

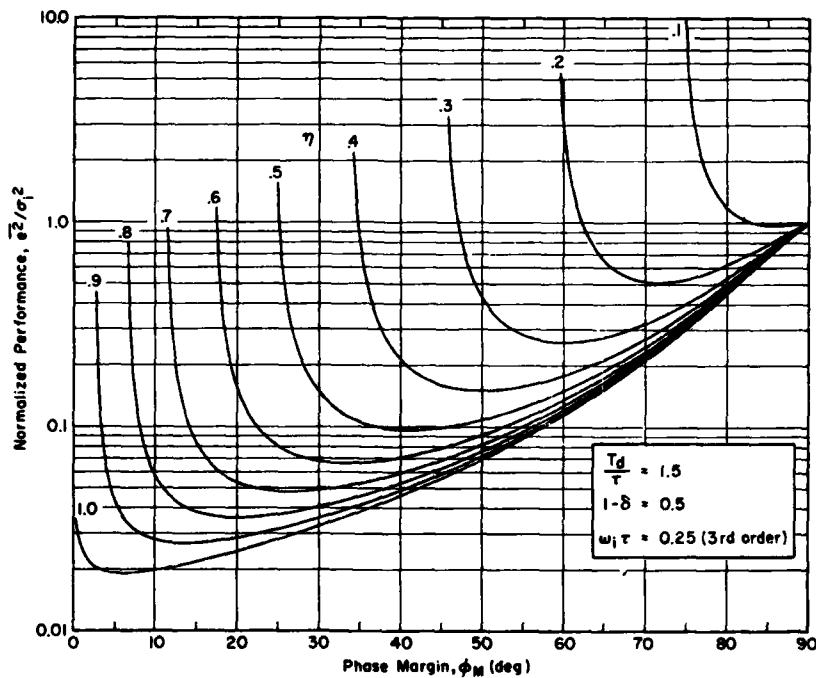

Figure 12b. Effect of Divided Attention Remnant on System Performance as a Function of Phase Margin

control dwell interval is set at $T_d/\tau_e = 1.5$, and the normalized lower bound on the scanning interval, $\delta = 0.5$.

Figures 11 and 12 show the profound effects of divided attention on control system performance particularly emphasizing the two "stability limits." The first is the full attention limit given by $\omega_n = \omega/2\tau_e$, which is approached by the full attention, $\eta = 1$, curve. The second is the "instability in the mean square." This is associated with the inequality constraint

$$F = 1 - \rho_e^2 = \frac{\frac{\sqrt{2}}{n}}{e^2} < 1 \quad (9)$$

The bases for this phenomenon and other divided attention analytical relationships will be summarized below.

Note that mean-square error instability occurs at progressively increasing phase margins as the attentional dwell fraction on the control task decreases. Furthermore, the phase margins for minima in normalized error variance are even greater, and the minima are broad. Typically, the "blow up" phase margin is less than the phase margin for best performance by 10 to 16 deg. Figure 13 puts these points into context by showing the phase margins for the blow up condition ($F = 1$), the phase margin for the minima (from Fig. 12), and the phase margins for a value of error coherence, ρ_e^2 , of 1/2 (corresponding to $F = 0.5$). This curve coincides almost exactly with the minimum mean-squared error curve when the control dwell fraction is less than 1/2. For larger control dwell fractions, say from 1/2 to 1, the phase margin for minimum mean-squared error is essentially a linear function of dwell fraction, as indicated by the fit on Fig. 13.

Analytical formulas (derived in Ref. 34), on which constructions such as Figs. 12 and 13 are based, are summarized in Table 4. The phase margin-dependent function $\bar{K}(\phi_M, \tau_e/T_d)$ [or normalized crossover frequency-dependent function $\bar{K}(\tau_e \omega_c, \tau_e/T_d)$] is shown in Fig. 14. The curves are given as families with two parameters: (a) the normalized control dwell time T_d/τ_e , and (b) the nondimensional variable $\delta\tau_e$, where $\delta = 2/T_d$. The $T_d/\tau_e = 0$ ($\delta\tau_e = \infty$) curve is the simplified function $A(\phi_M)$. As phase margin increases, this becomes a reasonable approximate bound for the more complete function.

One of the most interesting features provided by the formulas is the limit associated with the fundamental constraint.

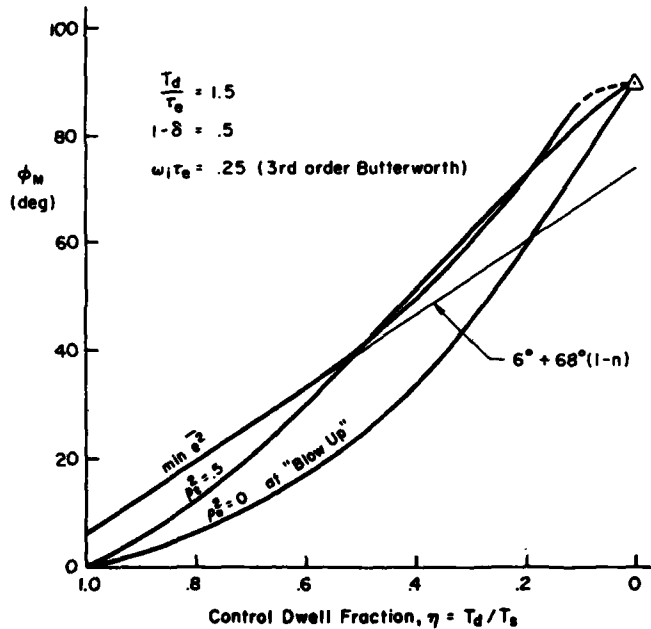

Figure 13. Effect of Divided Attention on Phase Margins for Minimum Mean-Squared Error

TABLE 4. BASIC DIVIDED ATTENTION RELATIONSHIPS

DIVIDED ATTENTION REMNANT POWER SPECTRAL DENSITY

$$\phi_{nn}(\omega) = \frac{T_o(1-\eta)(1-\delta)}{v \left[1 + \left(\frac{\omega T_d}{2} \right)^2 \right]} \frac{1}{e^2}, \quad 0 < \delta = T_o/T_s < 1$$

$$0 < \eta = T_d/T_s < 1$$

where $\bar{e}^2 = \int_0^\infty \phi_{ee}(\omega) d\omega$

T_o is the lower bound on the attentional scanning or sampling interval
 T_s is the mean value of the attentional scanning or sampling interval
 T_d is the mean value of the attentional dwell interval
 $\phi_{ee}(\omega)$ is the error power spectral density, (units of error)²/(rad/sec)

SYSTEM PERFORMANCE

<u>Total System Mean-Squared Error</u>	<u>Input-and Disturbance-Correlated Mean-Squared-Error</u>	<u>Uncorrelated Mean-Squared-Error Caused by Divided Attention</u>
$\frac{\bar{e}^2}{e^2}$	$\frac{\bar{e}_i^2}{e^2}$	$\frac{\bar{e}_n^2}{e^2}$
=		
$\int_0^\infty \left \frac{1}{1+G} \right ^2 \phi_{ii} d\omega + \frac{T_o \bar{e}^2 (1-\eta)(1-\delta)}{v} \int_0^\infty \left \frac{G}{1+G} \right ^2 \frac{d\omega}{\left[1 + \left(\frac{\omega T_d}{2} \right)^2 \right]}$		

where G is the open-loop describing function of the pilot vehicle system (Fig. 9)

$$\frac{\bar{e}_i^2}{e^2} = 1/1 - F$$

$$F = \frac{\bar{e}_n^2}{e^2} = 1 - \rho_e^2 = \frac{T_o(1-\eta)(1-\delta)}{v} \int_0^\infty \left| \frac{G}{1+G} \right|^2 \frac{d\omega}{\left[1 + \left(\frac{\omega T_d}{2} \right)^2 \right]}$$

FUNDAMENTAL CONSTRAINTS

$$\tau_e \omega_u = \pi/2 \quad \text{(Full Attention)}$$

$$F = \bar{e}_n^2 / \bar{e}^2 < 1 \quad \text{(Divided Attention)}$$

BASIC RELATIONSHIPS FOR ERROR INCOHERENCE IN TERMS OF THE CROSSOVER MODEL FOR G

$$F = \frac{\bar{e}_n^2}{e^2} = \frac{(T_o - T_d)}{T_o} (1 - \delta) \mathcal{K}(\phi_M, T_d/\tau_e)$$

$$\mathcal{K}(\phi_M, T_d/\tau_e) = A(\phi_M) \left\{ \frac{A(\phi_M) + \gamma(\phi_M)(T_d/4\tau_e)}{A(\phi_M)[1 + \gamma(\phi_M)(T_d/2\tau_e)^2] + \gamma(\phi_M)(T_d/4\tau_e)} \right\}$$

$$A(\phi_M) = \frac{\ln(\tau_e/2)}{4} \frac{\{(\pi/2)[1 - (\phi_M/(\pi/2))]^2\} [(\ln \pi/2)/(\ln \pi e/2)]}{-\ln|1 - (\phi_M/(\pi/2))|}$$

$$= 0.676 [(\tau_e - \phi_M)^{0.622}] / [-\ln|1 - \phi_M/(\pi/2)|]$$

$$\gamma(\phi_M) = [\pi/2 (1 - \phi_M/(\pi/2))]^2 [(\ln \pi/2)/(\ln \pi e/2)]$$

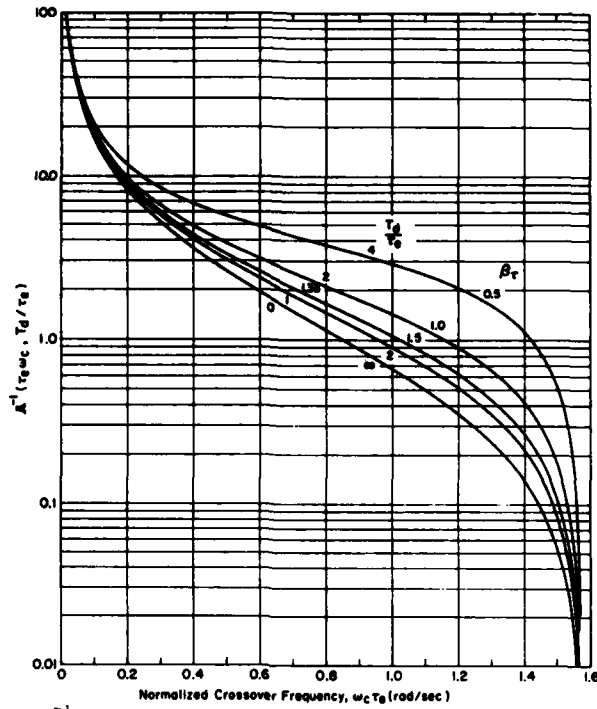

Figure 14a. $\Delta^{-1}(\phi_M, \tau_e/T_d)$ as a Function of Normalized Crossover Frequency

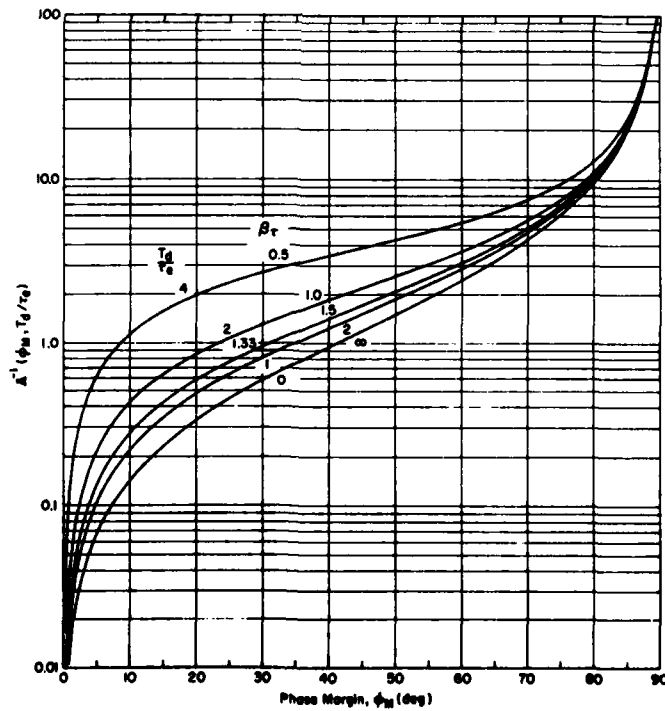

Figure 14b. $\Delta^{-1}(\phi_M, \tau_e/T_d)$ as a Function of Phase Margin

Divided Attention Error Stability Limit

$$F = \frac{e^{-\frac{\pi}{2}}}{e^{\frac{\pi}{2}}} < 1, \quad \text{or}$$

$$\frac{1}{X(\phi_M, \frac{T_d}{\tau_e})} > \frac{(T_s - T_d)(1 - \delta)}{\tau_e} \quad (10)$$

The curves of Fig. 14 can be used directly in conjunction with Eq. (10) to determine the minimum phase margin or maximum normalized crossover frequency available for a given level of divided attention. The maximum value of $X(\phi_M, T_d/\tau_e)$ must be less than $\tau_e/(T_s - T_d)(1 - \delta)$. With an appropriate change of labeling on the ordinate, the curves then become boundaries for stability in the mean-square, with locations below the curves corresponding to allowable phase margins.

For some purposes, the inequality of Eq. 10 may be awkward to work with because of the dependence of both sides on T_d . The simpler, more approximate form using the $A(\phi_M)$ may therefore be more useful. With this approximation, the Eq. 10 condition becomes

$$\frac{1}{A(\phi_M)} > \frac{(T_s - T_d)(1 - \delta)}{\tau_e} = \frac{T_d}{\tau_e} (1 - \delta) \left(\frac{1-n}{n} \right) \quad (11)$$

These last relationships emphasize the need to constrain the system phase margin to keep the error in divided attention operations within bounds. This follows because $(1-n)/n$ increases as the managerial demands increase. [For a given control task, the overall system latency is the sum of the net high-frequency system lag and the pilot's effective delay. The control task dwell time, T_d , defines how long the pilot must fixate on various "display" elements to assimilate the information needed for control. Thus T_d/τ_e is approximately constant for a given control-display task, and $(1-n)/n$ governs the inequality]. Then, as the maximum allowable value of $X(\phi_M, \tau_e/T_d)$ is reduced to maintain the inequality, Fig. 14 indicates that the divided attention control task phase margin must be increased. Because the normalized crossover frequency, $\tau_e \omega_c$, is directly related to the phase margin by $\phi_M = (\pi/2) - \tau_e \omega_c$, this can also be interpreted as indicating that the control task crossover frequency is reduced.

The implications of these statements include:

- The control task error has an extremely strong dependence on the control task dwell fraction. (The pilot-vehicle system gain is reduced and the system "remnant" or effective uncorrelated input due to lack of attention to the control task is increased as control task attention decreases).
- If the task complex requires significant division of pilot attention between managerial and control tasks, the dynamics of the system being controlled by the pilot must be able to support very large pilot-vehicle system phase margins. As a corollary, the controlled system must possess dynamic properties that require little attention to control.

These implications are, of course, consistent with the conventional wisdom that attitude control and path control functions are among the highest priorities for automation. Steps in this direction cut down the control dwell fraction directly, and increase the fraction of attention that can be devoted to managerial task sequences.

ALGORITHMIC HUMAN PILOT MODEL

An alternative approach to the estimation and description of human control behavior has been the application of modern optimal control theory. The starting points in this process are the well-founded theory of the linear-quadratic-gaussian stochastic control problem and manual control theory and data. To successfully marry these two elements is not easy, yet progress has been made (e.g., Refs. 37-46). Some notable applications to flying qualities problems have also been published (e.g., Refs. 47-49). The concept rests on the presumption that human operator responses can be emulated by an analogous optimal control system. The optimal system operates to minimize a quadratic performance index in the presence of various system inputs and noises. In doing so it provides a representation for at least some of the adaptive characteristics of the human operator. The basic consideration in this algorithmic approach is provision of techniques for imposing those characteristics of the human which represent both favorable (e.g., adaptation) and unfavorable (e.g., time delay and remnant) features so they are consonant with experiment. Related techniques must account for certain very fundamental human characteristics, such as the effective time delay and neuromuscular delays.

The general model is shown in Fig. 15. At the top are the machine properties involving the controlled element and display as acted on by disturbances. These are represented by linear state vector and display vector-matrix equations. The disturbance, $w(t)$, is a vector of white gaussian noise processes. If the forcing functions are colored, they are represented by filtered white gaussian noise. The additional states required to represent the filter dynamics are appended to the controlled element

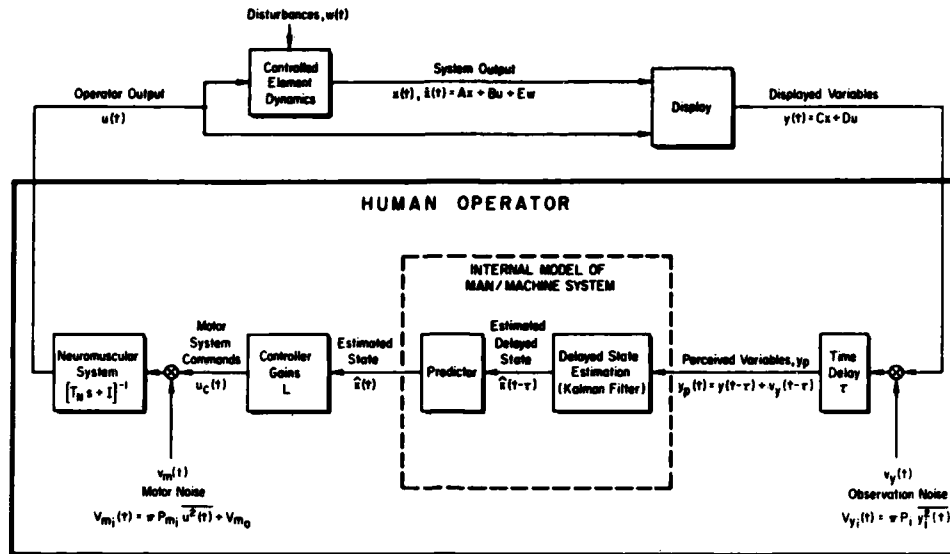

Figure 15. Algorithmic (Linear Optimal Control) Model of Man-Machine System

state vector and result in expanded A, B, C, and E matrices. Deterministic disturbances can be modeled by adding non-zero mean components to the disturbance vector, with the addition of still more elements to the state vector and associated matrices. The display variables are linear combinations of the system states and the pilot output.

In the optimal control formulation the human pilot's characteristics can be divided into two categories -- those which represent intrinsic human limitations, and thus which are not subject to optimization, and those properties which are subject to adaptation and thus optimization. In the first category are the effective time delay and the remnant. To some extent the neuromuscular system properties and/or the pilot-vehicle system crossover form and bandwidth also fall into this category, although their connections in the OCM formulation are somewhat obscure. (This will be illustrated later.) In the optimal control model the remnant is accounted for by observation noise and motor noise, shown respectively at the pilot's input and neuromuscular command output points. The observation noise vector is added to the display output $y(t)$. A separate noise component, $v_y(t)$ is associated with each display output component, $y_i(t)$. As noted in Fig. 6a, the remnant added at the operator's input is relatively wideband, so each component is assumed to be an independent gaussian white noise process. The spectral density is proportional to the mean-squared value of the displayed component, with a proportionality factor P_1 , which is a noise-to-signal ratio. In general, the human operator is presumed to obtain both displacement and rate information from a single display variable, and good results have been obtained by assuming that P_1 for the position and rate variables is the same. In single-loop control situations numerical values of P_1 of about 0.01 are typical. As can be appreciated from Fig. 6a, this is relatively invariant over a wide range of system dynamics and input spectra. To the extent that this is so, the normalized observation noise can be considered to be primarily operator-dependent.

The many internal time delays associated with visual, central processing, integrative, and other operations are combined into a lumped perceptual delay, τ . For simplicity, it is assumed in the current optimal control model that all outputs are delayed by the same amount. (We have noted in connection with the structural isomorphic model that there is a delay increment associated with rate perception.)

The "motor noise," like the observation noise, is assumed to be a zero-mean gaussian white noise with spectral density proportional to the mean-squared operator output. An additional component, v_{m0} , is sometimes included to account for the fact that the human operator introduces noise into an undisturbed system. A motor noise/signal ratio, P_{m1} , of 0.003 has been found to provide a good match to some experimental data.

The neuromuscular system is represented by a lag matrix, T_m . This is not explicitly modeled as an inherent limitation. Instead, it is imposed by weighting control rate terms in the cost function used to generate the optimal control. For single-loop control problems with linear, wide bandwidth manipulators, this weighting is purposely selected to yield T_m of approximately 0.1 sec to represent this inherent limitation. As

will be seen later, this weighting tends to set the frequency range over which the pilot-vehicle system may approximate the crossover model in a single input, single output system. When everything is taken into account in an effective pilot describing function Y_p , the direct neuromuscular lag represented by T_N will be cancelled by other quantities, although the total effective time delay may reflect some neuromuscular lag.

The remaining elements of the human operator are adaptive to the system characteristics and to changes in the explicit human operator limitations described above. Estimation of the delayed state vector is accomplished via a Kalman filter. This delayed state estimate is fed to a least-mean-squared predictor to yield the estimated state vector, $\hat{x}(t)$. The optimal gain matrix, L , is generated by solving the optimal regulator problem for a quadratic cost function of the form

$$J(u) = E \left\{ \lim_{T \rightarrow \infty} \frac{1}{T} \int_0^T (y'Qy + u'Ru + \dot{u}'G\dot{u}) dt \right\} \quad (12)$$

Because the cost functional weightings preordain the details of the controller gain matrix, L , the selection of weightings is critical to the model's success. This is particularly the case when the model's purpose is to simulate human operator responses. For simple single-loop control situations, excellent agreement with experimental measurements has been obtained with a cost functional of the extremely simple form:

$$J(u) = E \left\{ \lim_{T \rightarrow \infty} \frac{1}{T} \int_0^T (e^2 + g\dot{c}^2) dt \right\} \quad (13)$$

where e is the compensatory system error and $\dot{c} = \dot{u}$ is the operator's control rate. The value of g is selected as described above to yield an appropriate neuromuscular delay, T_N . For more complex situations, the relative weights are determined based either on maximum allowable deviations or limits, or from a knowledge of human preferences and capabilities. This is similar to the technique suggested by Ref. 50, wherein the weighting on each quadratic term is simply the inverse of the square of the corresponding allowable deviation. The solutions for this modified Kalman filtering prediction and optimal control problem are given by, for example, Ref. 38, 39, 42, and 51.

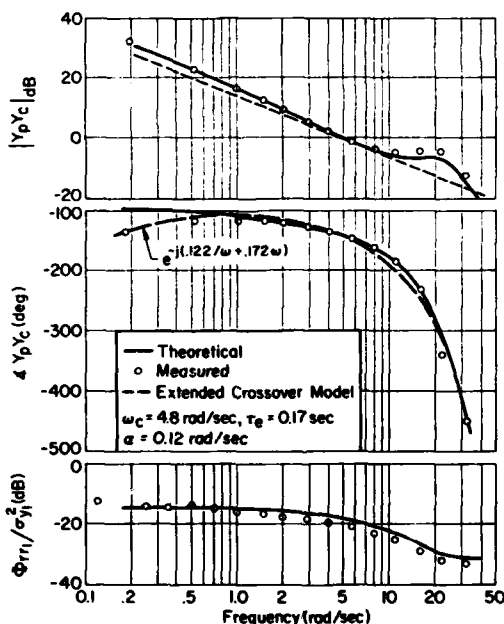

Figure 16. Measured and Predicted System Dynamics and Remnant for a Path Controlled Element (Adapted from Ref. 44)

Some appreciation of the degree with which actual human operator data can be characterized by the optimal control model can be gleaned from Fig. 16. Theoretical and measured frequency responses for an elementary single-loop system with a rate ($Y_c = K_c/s$) controlled element (Ref. 44) are compared. These frequency response data indicate that the model reproduces the essential characteristics of the human controller with excellent fidelity. Perhaps more important, the parameter values for other simple controlled elements, such as $Y_c = K_c$ and K_c/s^2 (Ref. 44) are very consistent, although the time delay needed to match the operator characteristics for K_c/s^2 dynamics was somewhat longer. This, of course, is to be expected from considerations described earlier and does not constitute a defect in the model.

The optimal control model results, of course, in a very high order describing function form when the various matrices are developed into transfer functions. Consequently, the fact that the OCM results presented in Fig. 16 are very similar to the extremely simple crossover model is a matter of great interest. Reference 51 reduces the OCM calculations involved to applications on a PC and also provides for the generation of transfer function data in factored form. This step is very helpful to indicate what is taking place inside the otherwise obscure OCM calculations. For the simple $Y_c = K_c/s$ case discussed above, the total Y_p is given by (Ref. 51)

$$Y_p = \frac{\{131(3.10)(5.45)(10.1)[-0.866, 32.1]\}}{\{(1.98)(5.44)(9.94)[.428, 21.9](39.1)\}} \frac{\{(0)(2)(9.94)\}}{\{(0)(2)(9.94)\}} \quad (14)$$

$$\text{where } (s + a) = (a) \text{ and } [s^2 + 2\zeta\omega_n s + \omega_n^2] = [c, \omega_n]$$

Thus, for the simple K_c/s controlled element the pilot model is an eighth degree over ninth degree transfer function! However, this is immediately reduced by three degrees because of the exact cancellations given in the second bracketed quantity. Notice here that the neuromuscular system pole given by (9.94) is exactly cancelled by a zero. The remaining bracketed quantity also has a number of nearly cancelling terms, i.e., (5.45)/(5.44) and another appearance of the neuromuscular mode, (10.1)/(9.94). Finally, when the high frequency terms $[-0.866, 23.1]/[0.428, 21.9]$, which are the result of using second-order Pade approximates for the pure time delay, together with the pole at 39.1, are converted to an effective time delay, the pilot model becomes,

$$Y_p = \frac{3.80(3.10)}{(1.98)} e^{-0.14s} \quad (15)$$

This is, at last, the simple Y_p sought. The frequency response data from very low frequencies to well beyond the crossover region is described very well by this much reduced model.

This set of calculations is very revealing. The most interesting aspects are the exact and nearly exact cancellations of dynamics which were initially put into the model formulation as a representation of the neuromuscular system. Further, the peaking tendency present at higher frequencies beyond the crossover region is due (in the case of Ref. 51) to a shift, as a consequence of closing the loop, of the denominator term associated with the Pade approximate for the pure time delay in the open-loop pilot. Clearly it is essential to resolve the OCM data into a Y_p factored form if one is to really understand the results in their most fundamental sense.

The algorithmic and computational advantages of the optimal control model make it extremely valuable as a means to make quantitative estimates of the human operator's dynamic response in control tasks for which the model is appropriate. Besides the need to simplify, as illustrated above, there are three other aspects which give some difficulty. The first is philosophical and relates to the explicit requirement that the human operator description contain a complete internal model of the human's intrinsic characteristics and the system dynamics and disturbances. Thus, for the state estimation to be accomplished, the A, B, C, D, and E matrices plus the system disturbances and the human time delay, observation noise, and motor noise must all be known. Further, for the controller equalization adjustments, the A and B matrices plus the weights in the cost functional are needed. All of this amounts to an essentially complete "knowledge" by the human of the man-machine system characteristics. Internal models have a long history in psychology for several purposes. For instance, their elaboration and refinement have served as a useful construct for the development of skill by dint of training. In fact, even the simple crossover model can be interpreted as an implicit internal model of the human and controlled element dynamic characteristics in the crossover region. The key problem is thus not with the concept of an internal model, but rather its degree of perfection, especially in extremely complex systems where the required internal model is equally complicated.

The second difficulty is that of attempting to identify the underlying model parameters from experimental data. Not only is this inverse problem fundamentally difficult, but the optimal control model reviewed here suffers from overparameterization. Thus, from an identification viewpoint, the observation and motor noises are not resolvable, and the feedback matrix and the observer gain matrix can only be determined up to a similarity transformation of the model (Ref. 52).

The third problem area is specification of the cost function. The teleological character of the linear quadratic optimal model is imperfect because the performance criterion must be shaped to the task. As a practical matter, this has seldom posed a serious problem when the model has been applied by an experienced practitioner. Nonetheless, an aura of artistry is present in this requirement.

In the structural isomorphic model, a very large number of experimentally observed phenomena are accounted for. Since its inception, a great deal of effort has been devoted to similarly account for human operator behavior with the algorithmic model. This has required, in the main, adjustments in the cost function or in those properties associated with the human operator's limitations, such as normalized observation or motor noise. The model has proved to be quite flexible in accommodating most of the many behavior changes desired. Table 5 summarizes some procedures and techniques which have been found suitable to accomplish this accommodation (Refs. 36-38, 41-45). Thus advanced modeling features, such as divided attention operations, can be handled with the OCM. Consequently both the structural and algorithmic forms of pilot model are now quite mature and can be used in a complementary fashion to solve pilot-vehicle analysis problems and to help resolve data interpretation issues.

TABLE 5. PROCEDURES FOR ADJUSTMENT OF THE ALGORITHMIC MODEL

FEATURES TO BE MODELED	SUITABLE PROCEDURES AND MEANS
Effective time delay accommodation	Least squares prediction applied to output of Kalman estimate of delayed states
Basic crossover behavior	Use of control rate weighting in distinction to control weighting in cost function
Effective neuromuscular lag T_N	Select ratio of control weighting to control rate weighting (e.g., "g") in cost function
Selection of cost function weights on states and control	Choose weights to be inverse of squares of the respective maximum allowable values
Remnant	Observation noise covariances scaled with mean-squared state. Residual (non-scaled) observation noise component to account for imprecision due to lack of references. Motor noise to reflect inability to generate control motions precisely. Residual motor noise to reflect human's introduction of noise into an undisturbed system.
Low-frequency phase lag	Use larger motor noise level than actually present in determining Kalman filter gains
Perceptual and indifference thresholds	Scale observation noise inversely with equivalent gain (random input describing function for threshold)
Scanning effects	Scale observation noise inversely with attentional fraction (f_i) of each display, subject to the constraint that $(\sum f_i) + f_{\text{margin}} < 1$, $f_i > 0$. Different noise levels for foveal and parafoveal viewing.
Workload (attentional)	Attentional workload effects evaluated by examining performance as a function of the reserved workload margin, f_{margin}
Motion cues	Add model of human motion sensory apparatus (e.g., vestibular system, proprioception) to state and output equations.

REFERENCES

1. McRuer, D. T., and E. S. Krendel, Mathematical Models of Human Pilot Behavior, AGARDograph No. 188, Jan. 1974.
2. McRuer, D. T., D. Graham, E. S. Krendel, et al, "System Performance and Operator Stationarity in Manual Control Systems," Third IFAC Congress, London, Feb. 1965.
3. Bekey, G. A., and J. M. Biddle, "The Effect of a Random-Sampling Interval on a Sampled-Data Model of the Human Operator," Third Annual NASA-University Conference on Manual Control, NASA SP-144, Mar. 1967, pp. 247-258.
4. Jex, H. R., and R. E. Magdaleno, "Corroborative Data on Normalization of Human Operator Remnant," IEEE Trans. Man-Machine Syst., Vol. 10, No. 4, Dec. 1969, pp. 137-140.
5. Levison, W. H., S. Baron, and D. L. Kleinman, "A Model for Controller Remnant," IEEE Trans. Man-Machine Syst., Vol. 10, No. 4, Oct. 1969, pp. 101-108. (Also, Bolt, Beranek, and Newman, Inc., Rept. 1731, Oct. 1968.)
6. Schweizer, G., "Some Contributions to the Theory of Linear Models Describing the Control Behavior of the Human Operator," R. K. Bernotat and K. P. Gartner (Eds.), Displays and Controls, Swets and Zeitlinger N.V., Amsterdam, 1972, pp. 327-348.
7. Allen, R. W., H. R. Jex, D. T. McRuer, et al, "Alcohol Effects on Driving Behavior and Performance in a Car Simulator," IEEE Trans. Syst., Man & Cybern., Vol. SMC-5, No. 5, Sept. 1975, pp. 498-505.
8. McRuer, D. T., "Human Operator System and Subsystem Dynamic Characteristics," A. S. Iberall and A. C. Guyton (Eds.), Regulation and Control in Physiological Systems, Instrument Society of America, Pittsburgh, PA, May 1973, pp. 230-235.
9. Magdaleno, R. E., D. T. McRuer, and G. P. Moore, Small Perturbation Dynamics of the Neuromuscular System in Tracking Tasks, NASA CR-1212, Dec. 1968. (Also, "A Neuromuscular Actuation System Model," IEEE Trans. Man-Machine Syst., Vol. 9, No. 3, Sept. 1968, pp. 61-71.)
10. Magdaleno, R. E., and D. T. McRuer, Experimental Validation and Analytical Elaboration for Models of the Pilot's Neuromuscular Subsystem in Tracking Tasks, NASA CR-1757, April 1971.
11. Jex, H. R., and R. E. Magdaleno, "Biomechanical Models for Vibration Feedthrough to Hands and Head for a Semisupine Pilot," Aviat., Space and Environ. Med., Vol. 49, No. 1, Jan. 1978, pp. 304-316.
12. Johnston, D. E., and D. T. McRuer, Investigation of Interactions Between Limb-Manipulator Dynamics and Effective Vehicle Roll Control Characteristics, NASA CR-3983, May 1986.
13. Johnston, D. E., and E. L. Aponso, Design Considerations of Manipulator and Feel System Characteristics in Roll Tracking, Systems Technology, Inc., TR-1217-1, Mar. 1987.
14. McRuer, D. T., H. R. Jex, W. F. Clement, et al, A Systems Analysis Theory for Displays in Manual Control, Systems Technology, Inc., TR-163-1, June 1967.
15. Allen, R. W., W. F. Clement, and H. R. Jex, Research on Display Scanning, Sampling, and Reconstruction Using Separate Main and Secondary Tracking Tasks, NASA CR-1569, July 1970.
16. Levison, W. H., and J. I. Elkind, Studies of Multivariable Manual Control Systems: Two-Axis Compensatory Systems with Separated Displays and Controls, NASA CR-875, Oct. 1967.
17. Levison, W. H., and J. I. Elkind, Studies of Multivariable Manual Control Systems: Four-Axis Compensatory Systems with Separated Displays and Controls, Bolt Beranek and Newman, Inc., Rept. No. 1695, Mar. 1969.
18. Weir, D. H., and R. H. Klein, The Measurement and Analysis of Pilot Scanning and Control Behavior During Simulated Instrument Approaches, NASA CR-1535, June 1970.
19. Meiry, J. L., The Vestibular System and Human Dynamic Space Orientation, MIT, Man-Vehicle Control Lab., Thesis T-65-1, June 1965.
20. Peters, R. A., Dynamic of the Vestibular System and Their Relation to Motion Perception, Spatial Disorientation, and Illusions, NASA CR-1309, April 1969.
21. Ringland, R. F., and R. L. Stapleford, Experimental Measurements of Motion Cue Effects on STOL Approach Tasks, NASA CR-114458, April 1972.

22. Shirley, R. S., Motion Cues in Man-Vehicle Control, MIT, ScD Thesis, MVT68-1, 1968. (Also R. S. Shirley and L. R. Young, Motion Cues in Man-Vehicle Control: Effects of Roll-Motion Cues on Human Operator's Behavior in Compensatory Systems with Disturbance Inputs, IEEE Trans., Vol. MMS-9, No. 4, Dec. 1968, pp. 121-128.)
23. Stapleford, R. L., R. A. Peters, and F. R. Alex, Experiments and a Model for Pilot Dynamics with Visual and Motion Inputs, NASA CR-1325, May 1969.
24. McRuer, D. T., and R. E. Magdaleno, Human Pilot Dynamics with Various Manipulators, AFFDL-TR-66-138, Dec. 1966.
25. Gordon-Smith, M., "An Investigation into Some Aspects of the Human Describing Function While Controlling a Single Degree of Freedom," 5th Annual NASA-University Conference on Manual Control, NASA SP-215, 1970, pp. 203-240. (Also An Investigation into Certain Aspects of the Describing Function of a Human Operator Controlling a System of One Degree of Freedom, University of Toronto, Institute for Aerospace Studies, Toronto, Canada, Rept. No. 149, Feb. 1970.)
26. Hess, R. A., "Structural Model of the Adaptive Human Pilot," J. Guidance and Control, Vol. 3, No. 5, Oct. 1980, pp. 416-423.
27. Hess, R. A., "A Model-Based Investigation of Manipulator Characteristics and Pilot/Vehicle Performance," J. Guidance, Vol. 6, No. 5, Oct. 1983.
28. Hess, R. A., "Investigating Aircraft Handling Qualities Using a Structural Model of the Human Pilot," AIAA GMC Guidance, Navigation and Control Conference Proceedings, AIAA-87-2537-CP, Monterey, CA, Aug. 1987.
29. Smith, R. H., "A Unifying Theory for Pilot Opinion Rating," Proceedings of the 12th Annual Conference on Manual Control, May 1976, pp. 542-554.
30. Reason, J., and K. Mycielska, Absent-Minded? The Study of Mental Lapses and Everyday Errors, Prentice-Hall, Inc., Englewood Cliffs, NJ, 1982.
31. McRuer, D. T., H. R. Jex, W. F. Clement, et al, Development of a Systems Analysis Theory of Manual Control Displays, Systems Technology, Inc., TR 163-1, Oct. 1967.
32. Jex, H. R., R. W. Allen, and R. E. Magdaleno, Display Format Effects on Precision Tracking Performance, AMRL-TR-71-63, Aug. 1971.
33. Clement, W. F., "A Theory for the Human Operator's Remnant tiloop Display-Control Tasks," Fifth NASA-University Conference on Manual Control, NASA SP-215, 1970, pp. 637-654.
34. McRuer, D. T., W. F. Clement, and R. E. Magdaleno, Simplified Pilot-Modeling for Divided Attention Operations, Systems Technology, Inc., TR-1219-1, Vol. II, May 1987.
35. McRuer, D. T., Chapter 2.0 of "Improved Guidance and Control Automation at the Man-Machine Interface;" Allocation of Human and Automatic Resources in the Cockpit, AGARD Advisory Report AR-228, Dec. 1986.
36. Allen, R. W., D. T. McRuer, R. E. Magdaleno, and H. R. Jex, "Computer Aided Procedures for Analyzing Pilot/Vehicle/System Interactions," NAECON, 1986, Dayton, Ohio, Systems Technology, Inc., P-385, May 1986.
37. Baron, S., and D. L. Kleinman, The Human As An Optimal Controller and Information Processor, NASA CR-1151. (Also IEEE Trans. Man-Machine Syst., Vol. 10, No. 1, Mar. 1969, pp. 9-17.)
38. Baron, S., D. L. Kleinman, D. C. Miller, et al, Application of Optimal Control Theory to the Prediction of Human Performance in a Complex Task, AFFDL-TR-69-81, Mar. 1970.
39. Curry, R. E., W. C. Hoffman, and L. R. Young, Pilot Modeling for Manned Simulation, AFFDL-TR-76-124, Vol. 1, Dec 1976.
40. Elkind, J. E., P. L. Falb, D. Kleinman, et al., An Optimal Control Method for Predicting Control Characteristics and Display Requirements of Manned-Vehicle Systems, AFFDL-TR-67-187, June 1968.
41. Kleinman, D. L., "Optimal Control of Linear Systems With Time-Delay and Observation Noise," IEEE Trans. Autom. Control, Vol. 14, Oct. 1969, pp. 524-527.
42. Kleinman, D. L., and S. Baron, Manned Vehicle Systems Analysis by Means of Modern Control Theory, NASA CR-1753, June 1971.
43. Kleinman, D. L., and S. Baron, "A Control Theoretic Model for Piloted Approach to Landing," Automatica, Vol. 9, No. 3, May 1973, pp. 339.
44. Kleinman, D. L., S. Baron, and W. H. Levison, "An Optimal Control Model of Human Response," Parts 1 and 2, Automatica, Vol. 6, May 1970, pp. 357-383.

2-30

45. Kleinman, D. L., S. Baron, and W. H. Levison, "A Control Theoretic Approach to Manned-Vehicle Systems Analysis," IEEE Trans., Vol. AC-16, No. 6, Dec. 1971, pp. 824-832.
46. Kleinman, D. L., and T. Perkins, "Modeling the Human in a Time-Varying Anti-Aircraft Tracking Loop", IEEE Trans., Vol. AC-19, No. 4, Aug. 1974, pp. 297-306.
47. Hess, R. A., "Aircraft Control-Display Analysis and Design Using the Optimal Control Model of the Human Pilot", IEEE Trans. on Systems, Man, and Cybernetics, Vol. SMC-11, No. 7, July 1981, pp. 465-480.
48. Schmidt, D. K., "Optimal Flight Control Synthesis via Pilot Modeling," J. Guidance and Control, Vol. 2, Aug. 1979, pp. 308-312.
49. Bacon, B. J., and D. K. Schmidt, "An Optimal Control Approach to Pilot/Vehicle Analysis and the Neal-Smith Criteria," J. Guidance, Vol. 6, No. 5, Sept-Oct. 1983, pp. 339-347.
50. Bryson, A. E., and Y. C. Ho, Applied Optimal Control, Blaisdell, Waltham, MA., 1969.
51. Thompson, P. M., "Program CC's Implementation of the Human Optimal Control Model," AIAA Guidance, Navigation and Control Conference, Monterey, CA, Systems Technology, Inc., Paper No. 411, Aug. 1987.
52. van Wyk, R. A., and J. J. Kok, "Theoretic Aspects of the Identification of the Parameters in the Optimal Control Model," 13th Annual Conference on Manual Control, MIT, Cambridge, MA, NASA CR-158107, 1977, pp. 27-34.

SURVEYS

1. Tustin, A., "The Nature of the Operator's Response in Manual Control, and Its Implications for Controller Design," J. IEE, Vol. 94, Part IIA, No. 2, 1947, pp. 190-207.
2. McRuer, D. T., and E. S. Krendel, Dynamic Response of Human Operators, WADC-TR-56-524, Oct. 1957. (Also, "The Human Operator as a Servo System Element," J. Franklin Inst., Vol. 267, No. 5, May 1959, pp. 381-403 and No. 6, June 1959, pp. 511-536.
3. Licklider, J. C. R., "Quasi-linear Operator Models in the Study of Manual Tracking," 1st Edition, R. D. Luce (Ed.), Developments in Mathematical Psychology, Free Press of Glencoe, Ill., 1960, pp. 169-279.
4. Sheridan, T. B., "The Human Operator in Control Instrumentation," R. H. MacMillan, T. J. Higgins, and P. Naslin (Eds.), Progress in Control Engineering, Vol. 1, Academic Press, New York, 1962, pp. 141-187.
5. Elkind, J. I., "A Survey of the Development of Models for the Human Controller, R. C. Langford and C. J. Mundo (Eds.), Guidance and Control-II, Vol. 13 of Progress in Astronautics and Aeronautics, Academic Press, New York, 1964, pp. 623-643.
6. Summers, L. G., and K. Ziedman, A Study of Manual Control Methodology with Annotated Bibliography, NASA CR-125, Nov. 1964.
7. Young, L. R., and L. Stark, Biological Control Systems - A Critical Review and Evaluation, NASA CR-190, 1965.
8. Costello, R. G., and T. J. Higgins, "An Inclusive Classified Bibliography Pertaining to Modeling the Human Operator as an Element in an Automatic Control System," IEEE Trans. Human Factors in Elect., Vol. 7, No. 4, Dec. 1966, pp. 174-181.
9. McRuer, D. T., and H. R. Jex, "A Review of Quasi-Linear Pilot Models," IEEE Trans. Human Factors in Elect., Vol. HFE-8, No. 3, Sept. 1967, pp. 231-249.
10. Young, L. R., "Human Control Capabilities," J. F. Parker, Jr., and V. R. West (Eds.), 2nd Edition, Bioastronautics Data Book, Chap. 16, NASA SP-3006, 1973, pp. 751-806.
11. Sheridan, T. B., and W. R. Ferrell, "Man-Machine Systems: Information, Control, and Decision Models of Human Performance," MIT Press, Cambridge, 1974.
12. McRuer, D. T., and E. S. Krendel, Mathematical Models of Human Pilot behavior, AGARDograph 188, Jan. 1974.
13. McRuer, D. T., "Human Dynamics in Man-Machine Systems," Automation, Vol. 16, No. 3, May 1980, pp. 237-253.

PILOT MODELING APPLICATIONS

Irving L. Ashkenas
 Vice President
 Systems Technology, Inc.
 13766 S. Hawthorne Blvd.
 Hawthorne, CA. 90250, USA

SUMMARY

The role of pilot opinion and rating in defining flying qualities, and the pilot-adapted control behavior that impinges on such ratings are delineated and discussed. This is preparatory to the exemplary application of frequency domain pilot-models to the examination and elucidation of a variety of flying qualities situations/problems. This examination starts with single-loop situations which progress in complexity; and then shifts to multiple-loop cases, which also progress in complexity.

This succession is designed to increasingly reveal the basic pilot-centered requirements for good flying qualities. Such requirements, which stem from easily achieved pilot adaption and good resulting closed-loop responses, are more generally applicable to "new" unknown situations than are classical requirements on the open-loop controlled element dynamic parameters. However, the latter do in fact influence the ease of piloted closure and the resulting closed-loop responses so, when properly expressed in terms of characteristics in the projected crossover frequency region, may also achieve a degree of generality.

The pilot-centered requirements illustrated by the examples, and others found in the literature, are collected and briefly discussed to conclude the lecture.

INTRODUCTION -- PILOT RATING CONSIDERATIONS

Before we consider applications of pilot-vehicle analysis we have to recognize that flying qualities are based on judgements delivered by pilots and reflected in recorded opinion/commentary; and also (usually) by a rating number which is arrived at through a rating system in a well-defined and hopefully universal manner. The most favored system currently in use is the Cooper-Harper scale (Ref. 1) which is reproduced in Fig. 1. We can see, from the widespread appearance of the words "pilot compensation," that closed-loop operation is an important rating consideration. In fact, ratings of closed-loop operation (usually the most demanding task) are generally indicative of overall rating.

Of course, for a given set of aircraft characteristics, including cockpit controls and manipulators, the ratings depend on the intended mission; and on the mission-related tasks and task variables, environment including visibility and disturbances, and display quantities and arrangement. The rating numbers are not objective, but rather are subjective, and are ordinal rather than interval, meaning that differences between numbers are not necessarily the same. Nevertheless, such subjective ratings are related to measures of pilot workload in a regular way, as shown (Ref. 2) in Fig. 2. Here pilot ratings for a series of primary single-loop tasks are plotted versus the steady-state maximum first-order divergences ($s-\lambda_p$) controllable by the pilot at the same time in a secondary task. The value of λ_p achieved, normalized by the value achievable when controlling only the divergence, is a measure of the attention or capacity the pilot can divert from the main, primary task; i.e., his excess available capacity for other control while performing the primary task -- so labeled in Fig. 2. The division of the rating scale into flying qualities "levels" is in accordance with MIL-SPEC-8785 usage. Pilot rating is thus an indirect indication of task attentional demand and perhaps, therefore, more quantitative than expected from the ordinal nature of the rating scale.

More direct indications of workload are the quantitative lead (compensation) required, as measured by the $|Y_p|$ slope at the crossover frequency; and the departure of gain from a near-optimum value. Thus for Level 1 pilot ratings:

The pilot lead (anticipation, compensation) $d|Y_p|_{dB}/d(\ln \omega) \omega_c$ must be less than 20 dB/dec, corresponding to an effective lead time constant, $T_L < 1$ sec

The effective controlled element gain (e.g., stick sensitivity) must be adjusted to near optimum values.

The control dwell fraction must be less than 1/3.

The last stems from the attentional workload associated with the Fig. 2 Level 1 boundary; the first two from the Fig. 3 results (Ref. 3).

We've already mentioned the potential influence of disturbance inputs and Table 1, (from Ref. 4) illustrates the allowable degradations in rating with atmospheric turbulence. The turbulence levels themselves, when not measured quantitatively, are defined in Refs. 1, 4, by descriptions of the effects on the aircraft and occupant: e.g., severe turbulence "-- causes large, abrupt changes in altitude and/or the altitude -- and large variations in airspeed;" and "Occupants are forced violently against seat belts or shoulder straps. Unsecured objects are tossed about." When known, as in simulation, or measured for certain flight situations, light, moderate, and severe turbulence levels are quantitatively defined below in terms of rms horizontal gust (σ_{u_g}):

MAGNITUDE	σ_{u_g} (ft/sec)
Light	0-3
Moderate	5
Severe	10
Extreme	24

The differences in ratings, due to atmospheric disturbances, shown in Table 1 are those that are allowable not necessarily those that will occur. In fact the susceptibility to gusts and turbulence is strongly affected by the stability and windproofing afforded by the flight-control-augmented configuration under test. For example in the Ref. 5 flight-tests where light to moderate turbulence from 1.0 to 4.0 ft/sec rms was encountered, the pilot rating increased by about 2 1/2 points for the basic control system, but not at all for either the rate- or attitude-command control systems. Also the Ref. 6 flight results show that the flying qualities of stable aircraft are not as much affected by increasing turbulence level as are unstable aircraft.

Additional Applications Literature

Having thus furnished some additional background on the meaning and significance of pilot rating and its general closed-loop and pilot model correlates, we are now in position to pursue the subject application studies. However, before we go into specific example applications it is very pertinent to point out the existence of Ref. 7 which catalogues a large number of application studies and contains close to 250 references. Many of these references are mostly assigned to one or the other of the categories shown in the "Applications" Table 2. Note that the reference numbers in Table 2 are those for the Ref. 7 listings.

SINGLE-LOOP ROLL CONTROL

(Example 1)

In general, before we can pursue a viable closed-loop analysis of human control we have to be sure that the loop(s) we select for closure correspond to those the pilot is really controlling. This isn't always easy to do because even for a single input/single output case it may not be clear which response the pilot is really concerned with especially when the "task" is relatively unstructured. A case in point is the uncertainty sometimes voiced relative to the motions of most significance in characterizing short period stable and sometimes unstable (PIO) oscillations. The choices are between θ , α , n_z and there have been advocates of each.

However, for the lateral case the situation is not as obtuse and there seems universal agreement that closure of the single ϕ -loop is a basic flying task which reveals some key closed-loop flying qualities considerations. More specifically, control and regulation of bank angle using ailerons is a fundamental lateral control task, either for its own sake or as an inner loop for heading or flight path control.

The complete aircraft-alone roll dynamics usually has the form

$$\frac{\phi}{\delta_a} = \frac{L'_{\delta_a} (s^2 + 2\tau_{\phi} \omega_{\phi} s + \omega_{\phi}^2)}{\underbrace{(s + 1/T_S)}_{\text{Spiral}} \underbrace{(s + 1/T_R)}_{\text{Roll Subsidence}} \underbrace{(s^2 + 2\delta_d \omega_d s + \omega_d^2)}_{\text{Dutch roll}}} \tag{1}$$

The roll subsidence idealization which neglects the spiral, Dutch roll and numerator dynamics is given by

$$\frac{\phi}{\delta_a} \approx \frac{L'_{\delta_a} (\omega_\phi / \omega_d)^2}{s(s + 1/T_R)} \quad (2)$$

and the appropriate approximate Y_p for this Y_c , is

$$Y_p \approx K_p (T_L s + 1) e^{-j\omega[\tau_o(T_L) - \Delta\tau_e(\omega_1)]} \quad (3)$$

with $T_L = T_R$

So, the open-loop describing function ($G = Y_p Y_c$) becomes

$$G \approx \frac{K_p L'_{\delta_a} (\omega_\phi / \omega_d)^2}{j\omega} e^{-j\omega[\tau_o(T_R) - \Delta\tau_e(\omega_1)]} \quad (4)$$

The closed-loop system accordingly has the familiar crossover-model form $\omega_c e^{-\tau s}/s$ with $\omega_c = K_p L'_{\delta_a} (\omega_\phi / \omega_d)^2$ and $\tau = \tau_o(T_R) - \Delta\tau_e(\omega_1)$. In addition to good closed-loop performance, satisfactory pilot ratings will require proper adjustment of manipulator gains and a comfortable level of pilot lead, $T_L = T_R$. For Level 1 ratings this pilot lead (anticipation, compensation) must correspond to $T_L < 1$ which is equivalent to $d|Y_p|_{dB}/d(\ln \omega) |_{\omega_c}$ less than 20 dB/decade as shown earlier. This requirement on T_L is really the basis for the usual limitations of T_R to values no smaller than about one, for satisfactory flying qualities.

Now considering the complete model dynamics, the simplest measure of the deviation from the simplified roll subsidence representation is given by the ω_ϕ / ω_d ratio.

$$\left(\frac{\omega_\phi}{\omega_d}\right)^2 \approx 1 - \frac{N'_{\delta_a} L'_{\beta}}{L'_{\delta_a} N'_{\beta}} \approx 1 - \frac{\left(\frac{C_{\eta\delta_a}}{C_{l\delta_a}} + \frac{I_{xz}}{I_x}\right) \left(\frac{C_{l\beta}}{C_{\eta\beta}} + \frac{I_{xz}}{I_z}\right)}{1 + \frac{I_{xz}}{I_x} \frac{C_{l\beta}}{C_{\eta\beta}}} \quad (5)$$

$\left(\frac{\omega_\phi}{\omega_d}\right)^2$ can range from negative values to positive values > 1

For $C_{l\beta} < 0$ (positive effective dihedral) and a stable Dutch roll ($N'_{\beta} > 0$), the key parameter is $N'_{\delta_a} = 1$, i.e., for $N'_{\delta_a} < 0$ = "adverse" aileron yaw, $(\omega_\phi / \omega_d)^2 < 1$; and for $N'_{\delta_a} > 0$ = "favorable" yaw, $(\omega_\phi / \omega_d)^2 > 1$. These approximate relationships are given graphic interpretation in Fig. 4.

The closed-loop pilot-aircraft system analysis, reflecting the same pilot describing function characteristics as for the idealized roll case, would then involve the open-loop transfer function

$$G \approx \frac{K_p T_L e^{-\tau_e s} (s + 1/T_L) (s^2 + 2\zeta_d \omega_d s + \omega_d^2)}{(s + 1/T_a) (s + 1/T_R) (s^2 + 2\zeta_d \omega_d s + \omega_d^2)} \quad (6)$$

Bode and root locus plots of this system for $T_L = T_R$, $e^{-\tau_e s} = \frac{e^{-\tau_e s/2}}{1 + \tau_e^2 s^2/4}$ (the Pade' approximant), ζ_d and τ_e small, and the relative magnitude of the key factor $\frac{\omega_\phi}{\omega_d}$ given by $\omega_d < \omega_\phi < 1/T_R < 2/\tau_e$ are presented in Fig. 5.

The most obvious feature of the pilot-aircraft system closure depicted is the closed-loop dutch roll instability at moderate values of gain. In effect, the pilot's actions in controlling bank angle with proportional aileron rolling moments incurs aileron yawing moments, roughly proportional to $r = g\phi/U_0$, which reduce the dutch roll damping.

This an early example of significant closed-loop flying qualities effects attributable to numerator parameters. In fact ω_d^2 can become negative resulting in a directionally divergent characteristic for the wings-held-level condition. Incidentally ω_d^2 in the guise of a non-dimensional LCDP (lateral control divergence parameter) $\equiv C_{ng} - C_{lg} \cdot C_n/C_{Lg}$ is used to characterize spin susceptibility (Ref. 8).

TURN COORDINATION

(Example 2)

The ω_d/ω_d effects of the foregoing simple example are only of real significance when the yaw damping is small as for most unaugmented aircraft at high altitude. Modern flight-control augmentation invariably adds sufficient directional damping so that incipient (conditional) instability due to $\omega_d/\omega_d > 1$ is not a problem. However, the basic roll-yaw coupling is still there and can present a turn coordination problem to the pilot. One way of achieving such coordination is through the pilot's use of a learned (programmed) rudder response to a given aileron (or roll command) input: in effect a crossfeed of aileron to rudder.

Pilot-adapted crossfeeds in multi-output/input conditions have not been systematically measured. For one thing such behavior is, as indicated above, a programmed, timed response and has difficult-to-define statistical properties. However, the required crossfeed to perfectly coordinate a turn can be easily computed and taken as a measure of the difficulty of the piloting task. This notion was used in Ref. 9 to identify parameters related to both the magnitude and the dynamic time-history, or "phasing" of the required "ideal" rudder response to a step aileron input.

These parameters, $N\delta_a/L\delta_a$ and μ respectively, are shown in Fig. 6 to define isopinion regions indicative of the task difficulty. The broadest region around $\mu = -1.0$ is associated with relatively simple crossfeed dynamics: an initial input which falls to a required steady state rudder of zero degrees. By contrast the $\mu = +1.0$ region requires steady rudder values equal to twice the initial value. According to the assumptions and simplifications leading to these results, the effective values of $N\delta_w$ and $L\delta_w$ for augmented aircraft (including possible imperfect crossfeeds) are the yawing and rolling accelerations due to a wheel (or stick) input at frequencies above 6.0 rad/sec.

WINGS LEVEL TURNING

(Example 3)

As noted, the above example does not, strictly speaking, follow from closed-loop considerations; although crossfeeds may be an important aspect of closed-loop operations. A better example of cross coupling effects, in this case reflecting closed-loop control problems, is afforded by the Ref. 10 study of direct force control (DFC) systems which theoretically give the possibility of independent control of the six motion degrees of freedom. However, realistically, practical mechanization of a DFC mode must recognize the departures of the feedback and crossfeed equalization from the ideal (completely decoupled) values. Establishing acceptable, less than ideal, response is an important aspect of the flying qualities requirements picture.

We must also recognize in such non-ideal cases, that the use of secondary controls by the pilot to improve the response to the primary control (such as using rudder to eliminate adverse yaw as in the last example) is specifically prohibited. This follows inasmuch as the sole purpose of independent control over six degrees of freedom is to simplify the piloting task; it is therefore fundamentally inconsistent to require secondary control usage. Some experimental verification of this was obtained during the flight tests (later discussed) where the pilots objected to using lateral stick to counter the effects of adverse roll coupling in the wings level turn mode.

Bandwidth Hypothesis

Another fundamental is that the basic reason for the extra complication of independent control is to allow improved performance in some specified task, nearly always entailing faster closed-loop responses. The increased closed-loop response is desired and necessary whether the loop is closed via an automatic system or by the human pilot, i.e., there is a minimum guidance and control, as well as a possible pilot-centered, requirement.

Accordingly, it was hypothesized that the achievable piloted system bandwidth, would be indicative not only of closed-loop speed of response, but also of pilot rating. Furthermore, the open-loop "bandwidth" defined by amplitude and gain margins similar to those characterizing $1/T_R$ as the roll-control time/frequency response parameter of most direct interest, would be related to and could be substituted, for the real closed-loop bandwidth, as a correlating parameter. The selected "bandwidth" definition, consistent with such usages, is the minimum frequency for which there is a gain margin of 6 dB or a phase margin of 45°.

Dynamic Considerations

The available bandwidth which can be obtained from any particular direct force control mode is related to its limiting (Numerator) response, corresponding to infinitely tight feedbacks, as listed below (tight feedbacks and limiting response in that order):

$$s + \delta_r, \phi + \delta_a \quad \text{for wings-level turn,} \quad s_y / \delta_{sf} + Y_{\delta sf}$$

$$s_y + \delta_{sf}, \phi + \delta_a \quad \text{for yaw pointing,} \quad \psi / \delta_r + N'_\delta / (s^2 - N'_rs + N'_\beta)$$

$$\psi + \delta_r, \phi + \delta_a \quad \text{for lateral translation,} \quad v / \delta_{sf} + Y_{\delta sf} / (s - Y_v)$$

The longitudinal degree of freedom, s_x, θ, w , have analogous feedbacks and limiting forms with $Y_{\delta sf}$ replaced by $Z_{\delta L}$, N'_δ by $M_{\delta e}$, N'_r by M_q , N'_β by $-M_\alpha$ and Y_v by Z_w .

Whereas the responses of the pointing and translation modes are inherently circumscribed by the limiting-form dynamics shown above, those of the normal acceleration and wings-level turn modes are basically infinite (open-loop phase > -90 deg), assuming a pure DFC response. The implication of this is that in the normal acceleration and wings-level turn mode the inherent closed-loop response limitations will not be due to basic loop dynamics but rather to coupling and or imperfect cancellations in the DFC feedback and crossfeed mechanizations.

Flight Test Results

Based partially on this last observation, most of the rather limited flight test program, conducted to test the bandwidth hypothesis, was accomplished using the wings-level turn (WLT) as a representative mode of control; it also showed considerable potential operational utility in the YF-16 flight tests (Ref. 11). The selected task was air-to-air tracking using the OSF Princeton Navion against a target aircraft maneuvering through a random series of bank angle reversals. The primary objective was to establish whether bandwidth is indeed the appropriate handling qualities parameter to separate satisfactory, acceptable, and unacceptable flying qualities for DFC modes. The configurations tested included one with minimal coupling (WLT1), two each with favorable roll (10, 12) and yaw (2, 5) coupling, and three each with unfavorable roll (11, 13, 14) and yaw (3, 4, 15) coupling. Selected examples of the flight test Fourier transformed heading responses are shown in Fig. 7.

Figure 8 shows the Cooper-Harper pilot ratings, for the air-to-air tracking task using the wings-level turn mode, plotted versus heading bandwidth. The open symbols indicate that the variations in heading bandwidth were achieved via yaw coupling. That is, the crossfeed gain from DFC control to the rudder was increased above its nominal value to achieve favorable yaw coupling and reduced below its nominal value to achieve unfavorable yaw coupling. The closed symbols indicate that the heading bandwidth was varied via changes in roll coupling, i.e., the DFC control to aileron gain. To the pilot, favorable yaw coupling appears as a tendency for the nose to move in the direction of the commanded turn, whereas unfavorable yaw coupling appears as a tendency for the nose initially to swing away from the commanded turn. When flying a configuration with favorable roll coupling, the pilot will observe a tendency for the aircraft to roll in the direction of the commanded wings-level turn, thereby improving the basic response characteristics (provided roll is not too large). Finally, adverse roll coupling appears to the pilot as a tendency for the aircraft to bank away from the commanded wings-level turn.

If the bandwidth hypothesis is valid, the pilot ratings and commentary should be similar for aircraft with approximately equal values of heading bandwidth, regardless of the secondary aircraft motions. The results shown in Fig. 8 confirm that this is indeed the case; more specifically:

- The pilot rating for Configurations WLT4 and WLT15 (adverse yaw coupling) are approximately the same as the pilot rating for Configuration WLT13 (adverse roll coupling). As can be seen from Fig. 8, all of these configurations have approximately the same heading bandwidth of between 0.7 and 0.8 rad/sec.
- Configuration WLT3 (slight adverse yaw coupling) has approximately the same pilot rating as Configuration WLT14 (slight adverse roll coupling). The bandwidth of these configurations are both approximately 1.1 rad/sec.
- Configurations WLT10 and WLT12 have significant favorable roll coupling and correspondingly high values of heading bandwidth. Configuration WLT5 also has a large value of heading bandwidth (4.1 rad/sec) by virtue of its highly proverse yaw coupling. Figure 8 indicates that these configurations are all rated approximately the same.

Conclusions

The above examples provide strong evidence to indicate that satisfactory DFC flying qualities depend primarily on the ability of the pilot to increase his tracking bandwidth to some established level by tightening up on the controls.

The rating data in Fig. 8 indicate that even the best wings-level turn configurations barely meet the classical definition of Level 1 flying qualities (e.g., Cooper-Harper pilot rating equal to or better than 3.5). However, when one considers that the task involves tracking a target undergoing large and rapid bank angle reversals, it is difficult to conceive of any configuration that would correspond to the adjectival descriptions of a pilot rating of 3 (i.e., "minimal pilot compensation required for desired performance"). The pilot commentary indicates that the WLT1 configuration had very acceptable flying qualities and that the desired performance in tracking task was "easily" attained (but apparently involved more than "minimal compensation"). Hence, the inability to attain average pilot ratings better than 3 is not attributable to the configuration per se, but rather to the difficulty of the task involved. Pilot ratings of 2 for the wings level turn mode were, in fact, obtained for a task requiring tracking of a ground target which performed a discrete step change in position, a significantly less demanding task than the air-to-air tracking utilized in this program.

LIMB-SIDESTICK DYNAMIC INTERACTION WITH ROLL CONTROL

(Example 4)

The next example addresses the fact that a great many recent new aircraft with fly-by-wire or command augmentation in the roll axis (Fig. 9) have encountered either Pilot-Induced Oscillations (PIO) or roll "ratcheting" (or both) in early flight phases. PIO has typically been associated with high gain, neutrally stable closed-loop pilot-vehicle control oscillations with a frequency of about 1/2 Hz. The "roll ratchet" is somewhat more obscure, appearing most often in rapid rolling maneuvers with typical frequencies of 2-3 Hz, as illustrated in the flight traces of Fig. 10. The frequency difference alone indicates that PIO and ratchet are different phenomena, yet both clearly involve the closed-loop pilot vehicle system.

The preceding lecture on the pilot model notes the presence of a neuromuscular system limb-manipulator dynamic resonance peak at 14-19 rad/sec and such characteristics are known to be important and critically limiting even though this frequency range of major activity may be well above the bandwidth associated with the "usual" control task.

It is more and more apparent that modern, high performance, high gain, response command flight control system bandwidths may be encroaching on the neuromuscular system. Furthermore, we know that the *neuromuscular system/limb dynamics* differ when the manipulator restraints change; and force sensitive side-sticks and new levels of breakouts, thresholds, and nonlinear force/gradients have drastically changed the conventional manipulator picture. Accordingly, attempts to alleviate roll ratchet, PIO and other roll flying qualities problems have involved adjustments in stick force gradients, filtering, and sensitivity; and have included introduction of various nonlinear elements such as command gain reduction with pilot input amplitude or frequency, filter time constant changes with sense of input (increase versus decrease), and different force gradients for right and left roll commands. These adjustments have generally involved ad hoc empirical modifications in the course of the aircraft development, much of it accomplished in flight test with correspondingly large cost.

The purposes of the Ref. 12 work, were to

- explore the origins of the roll ratchet phenomenon;
- develop insights about the tradeoffs involved in adjusting the properties of force sensing sidesticks;
- present guidelines to minimize roll control problems.

Pilot-Dynamic System Considerations

To begin with, using the detailed model of the neuromuscular system (instead of only approximating its phase lag contribution) and superimposing it on a K/s controlled element for the low frequency approximation as in Fig. 11, we see an open-loop resonant peak in the 2 to 3 Hz. frequency range due to the neuromuscular system. The correspondence of this frequency range and observed roll ratchet frequencies is very unlikely to be a coincidence; so, at observed roll ratchet frequencies the neuromuscular/limb mode clearly should be taken into account.

Accordingly an experiment was designed to investigate and quantify limb/manipulator dynamics and interactions between the neuromuscular subsystem, force sensing side-stick configuration, high gain command augmentation, and command filtering; and to investigate possible relationships between these interactions and the roll ratchet phenomenon. A longer range goal was to provide and enhance guidelines for manipulator-system design.

The experimental setup used a fixed base simulation of a roll tracking task in which the pilot matched his bank angle with that of a "target" having pseudo-random rolling motions obtained via a computer generated sum of sine waves. The tracking airplane (controlled element) approximated a high gain roll rate command system with an effective roll subsidence or flight control system prefilter time constant, T , whichever is larger. It also included a pure time delay, τ , which for very small values of τ may be a realistic approximation to digital flight control system sample and hold dynamics. The parameter values for T and τ used in the experiment were generally consistent with those for a modern flight control system designed to have Level 1 flying qualities. Thus, they should produce excellent effective controlled elements providing the gain is appropriately adjusted.

The sidestick manipulator variables included three stick displacement configurations: fixed (no displacement), as in the F-16 (Ref. 13); 0.77deg/lb (small) stick motion; and 1.43 deg/lb (large) stick motion. The latter two matched the displacement/force characteristics employed in an NT-33 flight test (Ref. 14). Analog signals from the manipulator force sensor and the resulting roll response ϕ were passed through an A to D converter to a digital computer where $Y_p Y_c$ describing functions and various performance measures were computed. The computations were essentially on-line and printed out at the conclusion of each run. Some 530 data runs were accomplished which provided a tremendous data base from which to determine or identify the various interactions of interest.

Since roll ratchet had not previously been observed or recognized in fixed- or moving-base simulations, the first objective of the experiment was to tune the controlled element, manipulator, and command/force gradients to try to achieve roll ratchet, or at least maximize roll ratchet tendencies, in the fixed-base simulation. A key factor based on pre-experiment analysis was that describing function measurements must cover the limb neuromuscular peaking frequency region, and forcing functions should be adjusted to emphasize good data in the neuromuscular subsystem region.

Experimental Neuromuscular Peaking Tendencies

Figure 12 presents example describing function measurements for 3 runs using the fixed force stick and a controlled element having a command/force gradient of 4 deg/sec/lb, no time lag, T , and a time delay of about 70 ms. Amplitude departures from the expected ω_c/s crossover characteristics are the contributions of the pilot's neuromuscular system at high frequency and his trim lag-lead at low frequency. The highest 3 frequencies show a peaking in the vicinity of 14 rad/sec for 2 of the 3 runs; and there is remarkable consistency in both amplitude and phase measurements across all frequencies for all 3 runs. Two of the amplitude data points at 14 rad/sec lie slightly above the 0 dB line. This represents a neutral or slightly unstable dynamic mode if the phase angle is near -180 deg at this frequency. This then could be interpreted as affecting roll ratchet.

The peaking tendency shown is representative of a large amount of the data obtained; and this frequency is consistent with the roll ratchet frequencies observed in the flight traces.

Additional measurements and correlations show that a time delay of approximately 0.065 to 0.07 tends to maximize the neuromuscular system peaking. At time delays either below or above these values, the peaking tendency decreases. Of all the controlled elements examined, K_c/s shows the minimum tendency for a peak. Interestingly, the time delays which maximize the neuromuscular peaking would be considered good from the MIL-8785 flying quality specification standpoint. In essence, these data show that the tendency to peaking can be "tuned" by the adjustment of the controlled element effective delay, with a maximum effect near 0.07 sec.

Also, the peaking sensitivity to command/force gradients ranging from 3 deg/sec/lb (slightly lower than on the F-16) up through 15 deg/sec/lb (utilized in the NT-33), is only slightly increased in the vicinity of 7.5 deg/sec/lb command force gradient for a fixed stick and a time delay of 0.067 sec. This is about the same value as the response/force ratio for the flight encountered ratcheting. This may or may not be coincidental. However, it is significant that there is appreciable peaking of the neuromuscular system across the entire gain range investigated in these experiments.

There is relatively little difference between the fixed and small deflection force-stick. Both show an increase in neuromuscular peaking tendency for the 0.067 and 0.1 sec time delays, a tendency to maximum peaking in the vicinity of 14 rad/sec and considerably less peaking for the zero time delay cases. The large deflection stick, on the other hand, shows little peaking across the 11 to 19 rad/sec frequency band and a lack of sensitivity to the controlled element time delay.

Adjustment of Pilot Lead

Comparison of the phase angle data points in the Fig. 12 and 13 examples indicates that the pilot has introduced lead in the Fig. 13 case which essentially cancels the time lag at 0.2 secs, so that the amplitude ratio is ω_c/s -like in the vicinity of the crossover. However, there is now considerable scatter in the data points in the region of the neuromuscular system peaking dynamics. In only one of the three runs shown in Fig. 13 was there a peaking tendency for the neuromuscular system; in the other two runs, the amplitude data points lie quite close to the $Y_p Y_c$ asymptote.

For the Fig. 14 lag time constant of 0.4 sec., the phase plots show that the pilot has now moved his lead to precisely cancel the controlled element time lag so the resulting $Y_p Y_c \rightarrow \omega_c/s$ throughout the frequency region of interest. The peaking tendency of the neuromuscular system is no longer evident and there should be little chance of roll ratchet. However, the roll control bandwidth has now been reduced to approximately 2.5 rad/sec whereas it was approximately 4.5 rad/sec for the smaller time constants. If the pilot were to attempt a 4.5 rad/sec bandwidth in the presence of the lag characteristics shown in Fig. 14, a PIO would occur at roughly that frequency (4 rad/sec). Thus in reducing or eliminating the roll ratchet tendency, we may have substituted a tendency for the lower-frequency PIO.

The direct experimental evidence for actual roll ratchet in the fixed base simulation was not very solid. However, considering the possible 0.1 sec reduction in the pilot time delay due to motion, it can be concluded that the fixed-base neuromuscular peaking examples which show negative gain margins of the amplitude ratio peak are quite likely to result in oscillations in the flight situation.

Comparisons with Flight Data

Certain of the experimental controlled elements essentially duplicate the F-16 configurations tested in Flight (Ref. 13), and the qualitative results and trends are the same. The compromise prefilter for the F-16 had a time constant of 0.2 rad/sec which is shown in Fig. 13 to allow a comfortable bandwidth slightly above 3 rad/sec and having 30 to 35 deg of phase margin and a much reduced neuromuscular peaking tendency. Thus there should be minimum tendency for either low or high frequency PIO although the data scatter in the higher frequency range of Fig. 13 show that conditions favorable to roll ratchet could pop up from time to time.

Another comparison between simulation results and flight data can be drawn from the investigation of roll ratchet and various prefilter configurations flown in the NT-33 (Ref. 15). However, a major difference was the use of a center-stick in the NT-33. The roll ratchet encountered in this flight test was at approximately 16 rad/sec.

Figure 15 includes these and other data in a plot of command/force gradient versus the roll time constant, T_R . The circles identify configurations flown; the open symbols reflect no ratchet obtained, the shaded symbols reflect roll ratchet observed by one or more of the evaluation pilots over the range of time delays investigated. (In almost every case, the ratchet only occurred with non-zero τ as in the lab simulation.)

The square symbols in Fig. 15 are configurations investigated in the fixed-base simulation. The open symbols identify configurations for which the $Y_p Y_c$ zero dB line did not pass through the neuromuscular peak (no ratchet possibility). The shaded squares identify configurations for which the zero dB line passed through the peak (ratchet possibility). The letters F, S, L reflect the displacement of the simulator side-stick. It is likely that the L side-stick most closely matched the NT-33 center-stick characteristics.

There is very good correlation between the flight and lab simulation ratchet tendencies shown in Fig. 15. The dashed line appears to separate the non-ratchet from the ratchet configurations except for the two or three lowest command/force gradient configurations at $T_R = 0.2$ sec. It is possible that this difference may be related to wrist (simulation side-stick) versus arm (flight center-stick) neuromuscular subsystem contributions at the lower command (higher force) configurations. The good agreement between flight and simulator results is interpreted as an encouraging validation of the simulator definition of ratchet potential -- i.e., neuromuscular peaking cut by the $Y_p Y_c$ zero dB line.

Conclusions

Crossover Model Refinements

- The property $\omega_c(Y_c) = \text{constant}$ extends over an order of magnitude variations in K_c changes in force gradient. ω_c begins to fall off as very small K_c demands great pilot effort (large K_p) to keep ω_c constant.
- Controller element lags for $Y_c = K_c/(Ts + 1)$ are:
 - almost exactly cancelled by pilot lead when $T > 0.2$ second (lag breakpoint of 5 rad/sec);
 - partly offset by pilot lead of approximately 1/8 second when $T < 0.2$ second.
 Thus the adjustment rule indicating that pilot lead will offset controlled element lags by nearly exact cancellation now has a lower limit at about 1/8 second.

Human Pilot Limb-Manipulator Dynamics

- The classical third-order system approximation for the limb-manipulator portion of the human neuromuscular system is both adequate and an essential minimum form needed to consider pilot-aircraft system dynamic interactions in the frequency range from 8-20+ rad/sec.

- The peaking tendency (damping ratio, ζ_N) of the quadratic component of the third-order approximation is a very strong function of the controlled element dynamics -- in essence this feature can be "tuned" by adjusting controlled element properties.
- For all stick force/displacement characteristics investigated the highest ζ_N (smallest peaking tendency) occurred for $Y_C = K_C/s$ controlled elements.
- Pure time delay induces a greater peaking tendency than an equivalent time lag.
- Distinct peaking tendencies occurred for fixed and small stick deflections for $\tau = 0.07$ and 0.1 second.
- The controlled element form which exhibited the maximum peaking tendency ($\Delta AR = 7$ dB) was $Y_C = K_{ce} - \tau^2/s$, for $\tau = 0.07$ sec. Higher and lower values of τ resulted in less peaking.
- For large stick deflections the peaking tendency is minimized or non-existent.

Roll Ratchet Connections

- The data strongly support the suggestion that the roll ratchet phenomenon is a closed-loop pilot-vehicle system interaction in which the pilot's neuromuscular dynamics play a central role.
- Ratchet tendencies can be detected in fixed-base simulations by careful tailoring of the forcing function and examination of particular stretches of data. Unlike the case in flight, the pilot may not be aware of the occasional ratchet.
- The ratchet potential of a given configuration is associated with the degree of neuromuscular system peaking. This peaking tendency can be "tuned" or "detuned" by controlled adjustments in the effective vehicle dynamics.
- This is readily assessed in a fixed-base simulation by describing function measurements in tracking tasks conducted with an appropriate forcing function. Such procedures are recommended as pre-flight development tests with modern fly-by-wire command augmentation systems.
- Ratchet tendencies are most severe on force sensing sidestick manipulators with small stick deflections.

LATERAL FLIGHT DIRECTOR DESIGN

(Example 5)

The purpose of this example is to apply the theory of manual control displays to develop design principles for advanced flight director systems and to illustrate some of these principles with modern lateral flight director design (Ref. 16).

In general, a flight director system includes the display elements, the pilot, and the effective (augmented) vehicle in a feedback control system, with the flight director display presenting both command and status information. The command elements provide steering signals combining desired path and aircraft motion quantities. These are shaped, filtered and appropriately mixed to permit the pilot to close the combined system loop with ease and efficiency.

The status information indicates the aircraft state relative to the external world; for example, localizer and glide path signals, and altitude and airspeed error.

The nub of the dynamic design problem for flight director systems is the selection of the appropriate mix of signals to make up the steering commands. This mix must recognize that when flight director control is contrasted with pilot operation on raw, full panel data, the primary advantage of the flight director is that it can be designed to satisfy pilot-centered needs and desires. Consequently, these advantages should be considered in terms of the relevant pilot properties and available theory from the very outset of design, instead of as a final ad hoc tuning up procedure which makes do with what is available.

A summary of all requirements central to design of such systems (evolved e.g., in Refs. 17-19) is given in Table 3.

Guidance and Control Requirements

Guidance and Control Requirements are independent of the type of controller, manual or automatic. In general, they are such to establish the aircraft on a commanded path/speed profiles, and to reduce any path errors and disturbance effects to zero in a stable, well-damped manner. They lead to outer-loop feedbacks and command feed forwards which are required to accomplish the mission. Additional inner-loop feedbacks are needed to permit the first set of feedbacks to function.

3-10

Pilot-Centered Requirements

Pilot-centered requirements stem from the presence of a human pilot in the control loop which places additional requirements on the specification of the guidance and control laws, as follows, from Table 3.

Minimum Pilot Compensation

As noted in the preceding lecture, when low-frequency lead is required of the pilot, his dynamic capacity is reduced by increased time delay and resulting degraded system performance. Pilot ratings also suffer, and may deteriorate further if the gains are in a non-optimum region (too sensitive or too sluggish). Accordingly, the effective controlled element should be constructed to:

- Require no low-frequency lead equalization.
- Permit pilot loop closure over a wide range of gains.

This can best be achieved when the effective controlled element (airplane plus SAS plus flight director) approximates a pure integration, K/s, over a fairly broad region centered about the piloted system crossover frequency.

Finally, the display/controlled-element dynamics should be approximately time invariant, implying that the beam error be range compensated. The pilot can adjust to non-stationary situations, but this involves adaptation and learning which increases task difficulty and degrades performance.

Response Quality

Response quality refers to certain aspects of the display, and path, responses which directly affect the pilot's subjective opinion of the system. The display response qualities are:

- Command bar consistency -- Correspondence between the command signal and the vehicle or control motions in each of several frequency bands. At low frequency the command should be consistent with path deviation and aircraft heading. The mid-frequency response should be consistent with vehicle attitude motions and at high frequency with attitude rate or control displacement.
- Face validity -- The command bar motions must be consistent with the status information without discontinuities or step commands that require large sudden control inputs (and/or result in attitude overshoots).
- Response compatibility -- The command bar response should not require aggressive control activity nor should it appear "busy" to the pilot.

Aircraft motion response qualities for a centered flight director are:

- Modal interactions -- The closed-loop system response should be rapid and well damped with minimum coupling between the modes of motion. The path and attitude modes should be well separated in frequency; and loop closure should not drive the system modes into near proximity.
- Path mode consistency -- The system response to an offset initial condition (due to an external disturbance, pilot inattention, etc.) should not result in "long tails," steady offsets, overshoots, or abrupt large attitude changes. The latter, overdriving of bank or pitch, is not consistent with normal IFR piloting technique and results in degraded pilot opinion and passenger comfort.

Frequency Separation of Controls

The lower frequency range of control for each director bar (e.g., throttle and column) should also be separated. In this way one director is primary, e.g., for path regulation; and the other is for lower-frequency trim, thus reducing the scanning workload between the two directors to an acceptable level.

Non-Interacting Controls

Each director should be essentially non-interacting, meaning that closure of one director loop will not produce an undesirable response on another director.

Insensitivity to Pilot Response

This implies a broad region of K/s where the pilot can close the loop with an acceptable phase margin. Additionally, there should be no problems with inattention such as would occur if beam integral were fed back to the flight director. In this case, when the pilot is not responding to the director, small localizer deviations will integrate, to large director commands. When the pilot then centers the bar, he drives the aircraft off the beam until the integrator output cancels the localizer. The return to the beam is then very slow with a time constant near that of the integral term.

Remnant Suppression

Pilot remnant may be of three kinds -- residual, scanning, and processing remnants. A basic reason for having a flight director in the first place is to decrease the number of displays and thereby the scanning remnant. The basic trade-off here is to maximize the information on the flight director while keeping the display uncomplicated. High-frequency control motions, characteristic of pilot remnant, should not show up when flying the flight director display. This follows, in part, from making the effective controlled element a K/s i.e., high-frequency signals are filtered. Pure gain effective controlled elements which do not attenuate high-frequency components tend to look very busy because of pilot remnant.

Design Analysis Procedure

With these fundamental requirements established we can now turn to specific consideration of an example of lateral flight director design for curved path following. To begin with we consider the effects of various possible feedbacks on the pilot/vehicle system requirements, as given in Table 4. Two basic design concepts show considerable promise in achieving curved path tracking; first, "conventional" feed-forward of certain trajectory-dependent parameters (Flight Director A) and, second, less conventional, trajectory-independent washed-out bank angle feedback (Flight Director B). A generalized system for lateral control is shown in the Fig. 16 block diagram which assumes that: 1) the beam is range compensated; 2) all turns are coordinated; and 3) localizer noise is zero.

Dynamic Requirements

The characteristic equation of the Fig. 16 closed-loop system is given by:

$$\Delta_{CL} = \Delta + Y_p N_{\delta w}^{\text{FD}} \left[G_{\phi} + \frac{K}{s} \left(\frac{G_y}{U_0} + G_{\dot{y}} \right) + \frac{K}{s^2} G_y \right] \tag{7}$$

$$= \Delta + Y_p N_{\delta w}^{\text{FD}}$$

Closure of the flight director loop via human (or automatic) pilot drives the system poles into the flight director zeros, $N_{\delta w}^{\text{FD}}$ which are defined by the shaping, and relative weighting of the feedbacks and feedforwards, G_{ϕ} , $N_{\delta w}^{\text{FD}}$ and Δ in Eq. 7 represent the roll numerator and characteristic equation of the augmented airplane which generally has the following form:

$$\frac{N_{\delta w}^{\text{FD}}}{\Delta} = \frac{L_{\delta w \text{aug}}}{s(s + 1/T_{R \text{aug}})} \tag{8}$$

Generically, the dominant roots of the augmented airplane consist of a roll subsidence mode and a spiral mode at (or near) the origin. Then, open-loop transfer function which defines the effective flight director to wheel response (obtained from Fig. 16 and Eqs. 7, 8) follows:

$$\frac{FD}{\delta_w} = \frac{L_{\delta w \text{aug}} [s^2 G_{\phi} + g_s (G_{\dot{y}}/U_0 + G_{\dot{y}}) + g G_y]}{s^3 (s + 1/T_{R \text{aug}})} \tag{9}$$

The generic root locus and Bode (frequency) characteristics of a typical piloted closure are given in Fig. 17 where the closed-loop characteristic modes may be optimized by adjusting the numerator zeros through manipulation of the feedback transfer functions in Eq. 9. The following requirements result directly from these considerations.

- a. The numerator must be at least a second order at frequencies well below the roll mode ($\omega_p \ll 1/T_R$) for system stability and to maximize the region of K/s. Among other things, this implies $G_{\phi} \neq 0$
- b. Heading feedback, G_{ϕ} and/or beam rate feedback, $G_{\dot{y}}$, is necessary for system damping.
- c. The frequency of the $N_{\delta w}^{\text{FD}}$ numerator zeros (ω_p) determines the maximum achievable closed-loop system bandwidth. As such, it must be large enough to allow good command following and disturbance regulation.

Note that a and c, above, are in conflict and involve a fundamental tradeoff between command following/disturbance regulation and system stability.

Steady-State Requirements

The above analysis provides certain insights as to the necessary form of the feedbacks to obtain desirable system dynamic response. To complete the picture, we have to

also consider the steady-state requirements, which relate to degrees of command-following (straight and curved courses) and disturbance regulation (wind and wind shear). Such analyses, detailed in Ref. 16, show that, considering all possible combinations and simple dynamic forms for the G operators in Fig. 16 (except integral equalization on G_ϕ and G_ψ which could force localizer standoff), the practical possibilities yielding zero path error to curved paths and wind shears are:

- Beam (k_y) and beam rate ($k_{\dot{y}}$), without beam integral, along with washed-out roll angle.
- The use of feedforward commands deserves consideration.

Both alternatives were considered in the present design exercise, FD A with a feedforward and FD B with washed-out feedback.

Parameter Adjustment (FD A)

In general, the analytical design procedure to set the final system gains, feedback transfer functions and limiters was formulated so that the system requirements expressed earlier could be interpreted directly in terms of certain quantitative criteria. For FD A, the flight director to δ_w numerator takes the following generic form:

$$N_{\delta_w}^{FD} = \frac{K_p K_D L \delta_w}{s^2} \left(s^3 + \frac{K_\phi}{K_p} s^2 + g \frac{K_{\dot{y}}}{K_p} s + g \frac{K_y}{K_p} \right) \quad (10)$$

The zeros of this numerator represent the limiting characteristics of the system closed-loop modes as the pilot increases his gain, K_p . Comparison of Eq. 10 with Eq. 9 reveals that the addition of roll rate feedback, i.e., $G_\phi = K_\phi + K_{\dot{p}}$, increases the order of $N_{\delta_w}^{FD}$ from two to three, making the effective controlled element ($N_{\delta_w}^{FD}/\Delta$) K/s-like out to infinite frequency. The coefficients of Eq. 10 were adjusted in accordance with the pilot/vehicle requirements discussed earlier, resulting in the system survey shown in Fig. 18. This is valid for all flight conditions because the augmented lateral airplane transfer function is essentially invariant with speed.

The root locus in Fig. 18 indicates that the dominant system response is third order with the second-order closed-loop flight director mode, ω_{FD} , occurring at slightly higher frequency than the first-order subsidence, $1/T_{FD}$, in the region of crossover. One of the primary goals in the design was to make the effective controlled element, FD/δ_w , K/s-like over a broad range of frequencies, and this is reflected in the Bode amplitude plot. The gain crossover, estimated from the results of several simulator programs, is in the K/s region and very near the frequency for maximum phase margin. Notice that deviations in pilot gain from the (assumed) nominal by, say, ± 6 dB do not greatly affect the resulting closed-loop modes (see Bode).

There was some initial concern over the (conditionally) unstable root locus at low frequency (near the origin) and the effect this might have during periods of unattended operation. However, this was not a problem, and the pilots were totally unaware of any conditional stability aspects of the flight director.

The third-order nature of the response (two modes at nearly the same frequency) prompted consideration of the response qualities requirement, discussed above. For example, increasing the rate gain, $K_{\dot{y}}$, tends to drive $1/T_{FD}$ and $1/T_{FD}$ towards the origin, and results in a higher-order-looking response, characterized by a localizer bug that initially moves toward the center and then seems to stand off.

Figure 19 shows the (time response) disturbance regulation properties in response to a crosswind, and an initial offset of 122 m (400 ft) for the closed-loop airplane/display/pilot system. For both positive and negative crosswinds of 25 kt the disturbance regulation characteristics are seen to be quite good with the aircraft on course at an established crab angle within 20 sec. For left crosswind, the bank angle limiter is saturated until course convergence is established, resulting in a discontinuity in the flight director signal at about 5 seconds as the signal comes off the limiter. What this amounts to is a sudden change in the effective flight director law from $FD_w = (\dot{\phi} \lim - \dot{\phi})$ to $FD_w = f(\gamma, \dot{\gamma}_D, \phi, p)$. While this violates the pilot-centered requirements for "face validity," it is difficult to avoid since the bank angle limiter is necessary to satisfy other pilot-centered requirements. Piloted simulation results indicated that this problem was not objectionable enough to downrate the system, especially since it occurred only after a large abuse, (400 ft offset in a 25 kt crosswind).

Parameter Adjustment (FD B)

As noted earlier, Flight Director B does not require feedforward signals and will track any arbitrary path without external inputs. The design is less straightforward than FD A, requiring additional tradeoffs and some performance compromises. As shown in Ref. 16, the system limitations are of practical interest only when a small turn radius is required ($R_c < 1219$ m (4000 ft)). For such cases, a washed-out ($s/s + 1/T_{w0}$) step bank angle command must be added to allow the aircraft to "blend in" to the curved path prior to reaching the point of tangency.

This increases FD B from a third-order numerator (FD A) to a fifth-order numerator due to the bank angle washout circuit, and a lag in G_y required to filter beam noise, which was effectively eliminated in Flight Director A by complementary filtering. The design of Flight Director B is predicated on being able to follow any beam shape (within system limits) without prior knowledge of the beam geometry. Some of the considerations relative to parameter adjustments are shown in Table 5.

The final adjustments involved setting the roll rate feedback, K_p , to maximize the region of K/s in the effective controlled element. It was determined by auxiliary analyses that as K_p is increased, the effective feedback becomes the derivative of cross-track acceleration, \dot{y} ($\dot{y} = g\phi$), and the path zeros decrease in frequency. As a result, it is necessary to strike a compromise between the pilot-centered requirement for K/s at high frequencies and path mode stability.

With the above considerations in mind, the system parameters were adjusted to give the controlled element characteristics shown in Fig. 20. The crossover frequency shown, estimated from simulator time responses, corresponds to near-maximum phase margin. The compromise involved in setting the p feedback gain is evident from the region of K/s^2 between $1/r$ and $1/TFD_2$ in the Bode asymptotes.

The Bode amplitude of FD B is down by a factor of 1.5 from FD A in the region of crossover. Piloted simulator experiments indicated that this was too low and the display gain was therefore set to 1.5.

As in FD A, the low-frequency conditional instability was found to have no effect on pilot opinion.

Figure 21 shows FD B responses to a lateral offset in the presence of a negative crosswind. Note that most of the lateral offset is removed in 15 seconds and that the last 10 percent seems to stand off, but in fact goes to zero in $3T_s = 43$ sec. This effect is inherent to the washed-out system and is attributable to the residual output of the washout circuit which causes an effective standoff with y_c . Such residual lateral offset was found to be negligible during the simulator evaluations of FD B.

On the other hand, the regulation characteristics to crosswind shear (not shown) is considerably improved by FD B reducing the cross-track error (to a 2.23 ft/sec^2 crosswind shear) from $30'$ (FD A) to about $5'$.

The fundamental advantage of the washed-out bank angle director lies in its ability to track an arbitrary course (within design limits) without the benefit of external guidance inputs in the form of feedforward commands. The time response characteristics of a curved course intercept from a straight course are shown in Fig. 22 in calm air and with a 25 kt tailwind. These results are for a 1219 m (4000 ft) turn radius and a true airspeed of 90 kt. Course transients at the intercept point are inherent due to the lack of an advanced bank angle command and are sensitive to the commanded turn radius, true airspeed, and wind.

Conclusions

Application of the system requirements produce viable and workable flight director laws.

MULTIPLE LOOP EXAMPLES

We depart now from the single-loop situations so far examined to consider the more complex multiple-loop situations, which are mostly associated with longitudinal control.

In the first place we recognize the existence of experimental evidence (Ref. 3) that the Pilot Model is applicable; and identify in general how it is to be applied in Table 6.

An important feature of such application is the selection of the loop structure to be used, which is not always readily apparent. Instead, the possible feedbacks, and their flight control consequences, must sometimes be carefully compared to ascertain those that would be preferred/selected by a skilled controls designer (such as for the lateral flight director example). A good test pilot will "find" these preferred structures and develop the same vehicle-appropriate control techniques.

A case in point is the two representative piloting techniques depicted in Fig. 23. The "STOL" technique using throttle to control altitude is appropriate for aircraft operation on the "backside" of the drag or power curve where rate of climb decreases with decreasing speed and control of altitude with elevator is unstable, causing divergence to stall. The "CTOL" technique is appropriate to "frontside" operation where decreasing speed increases climb-rate and altitude control with elevator is stable. These now-apparent differences and assigned applicabilities were not always so evident and accepted. In fact one of the very first problems studied by multiple-loop pilot-vehicle analysis involved a good deal of preliminary loop closures and comparisons before it was decided that (a variant of) the STOL technique was the appropriate, closed-loop system for the carrier approach situation (Refs. 20, 21).

CARRIER AIRCRAFT APPROACH SPEED SELECTION

(Example 6)

The subject situation involved piloted control of approach along an optical beam and analysis of those flight conditions, on a variety of US Navy aircraft, where the pilots reported "inability to control altitude or arrest rate of sink," not covered by any then-known approach-speed limiting parameters. The very complete analysis of Ref. 20 considered both of the basic Fig. 23 loop structures as well as low frequency (filtered) angle of attack feedbacks to throttle or stick. Control of altitude with stick (CTOL technique) was shown to give fast-response altitude control, but to require airspeed control with throttle for stability. On the other hand, throttle control of altitude has inherent low bandwidth capability (but adequate for carrier wake-induced turbulence) yet is stable without auxiliary speed (or alpha) control. Also, application of the latter technique was successful in explaining the causes of the above-noted flying qualities problem whereas the former was not; accordingly the STOL technique was selected as most appropriate.

Later extensions of this study (Ref. 21) showed that for contemporary Navy aircraft, two-loop control of attitude with elevator and altitude with throttle (without $u + \delta_a$) caused only small perturbations in airspeed. These were, in fact, considerably smaller than those for the complete three-loop CTOL mode ($h, \theta + \delta_a; u + \delta_T$). Thus, despite the CTOL mode's potentially superior altitude control, it suffers by comparison with the STOL mode (for backside operation) on two counts: speed dispersions are increased and three loops rather than two must be closed. In the latter sense, the CTOL structure violates the pilot's desire for control economy.

Now that we've established the pertinent piloting technique, let's examine the problem. The Fig. 24 root loci illustrate the effects of the successive loop closures on the closed-loop phugoid characteristics - those most significant for path control. The first closure ($\theta + \delta_a$) yields the single prime poles; the second closure modifies the single prime to the double prime (final) characteristics. In these example generic closures, the pilot "model" is a simple gain in each loop since the frequencies are so low that "comfortable" pilot equalization is not possible and τ effects are negligible (Δ phase = $\tau\omega$).

If $1/T\theta_1$ decreases on the backside from the value sketched) in Fig. 24 (it can actually become negative) so that $1/T\theta_1 T\theta_2 < \omega_p^2$ then $(\omega_p)^2$ decreases as the (K_0) gain is increased. This sets the stage for a condition (including both loops) where increased pilot's θ -loop gain first becomes less effective in increasing the outer loop, altitude control, bandwidth; and eventually an increasing θ -loop gain results in a decrease in bandwidth and altitude control performance.

The speed at which reversal occurs (i.e., where the bandwidth variation with K_0 is zero), was postulated as corresponding to incipient "inability to control altitude ...". For lower speeds the harder the pilot tries, by tightening attitude control (normally effective), the more he degrades his altitude performance. Such "performance reversal" speeds were computed for seven Navy carrier aircraft and shown to compare favorably with pilot-selected approach speeds for five of the seven; the remaining two had other identified limiting problems. Additional successful correlations with simulation (Ref. 21) and experimental aircraft flight results (Ref. 22) further confirmed the validity and applicability of the "reversal" condition as a flying qualities metric.

SHUTTLE ORBITER PIO

(Example 7)

The shuttle orbiter landing is a non-powered maneuver involving only column control. For the longitudinal axis this means elevator control of pitch and altitude as for the CTOL mode. The orbiter digital flight control system is an example of fairly modern technology which, in common with other modern systems, has had early development problems. One of these involved certain early (ALT [Approach and Landing Test] FF5 flight) PIO-like flight deficiencies as depicted in Fig. 25. To determine the possible cause and cure for such behavior, the quasilinear human pilot model (Ref. 3) was applied to the ALT-FF5 approach and landing flight condition (Ref. 23).

Aircraft Characteristics

The pertinent aircraft characteristics are represented by:

- θ'/δ_a The augmented pitch attitude transfer function for control inputs
- h_p/θ The aircraft's path response at pilot's station, to attitude changes for pilot control inputs

The pitch attitude transfer function and frequency response are given in Fig. 26. Also given in the figure are the transfer function and frequency response of a low-order "equivalent" system model of the form,

$$\left. \frac{\theta}{\delta_a} \right|_{eq} = \frac{K_0 - \tau_e s^2}{s(T_{\theta} s + 1)} \quad (11)$$

and parameter values ($K = 0.4$ deg/sec/deg, $1/T_p = 3.5$ rad/sec, and $\tau_e = 0.264$ sec) giving a best fit to the complete frequency response of the ALT. The equivalent system is useful for selecting pilot model parameter values and for making comparisons with other aircraft. The actual PIO analysis used the complete ALT transfer function as given in Fig. 26.

The path to attitude transfer function and frequency response for elevator inputs is given below.

$$\frac{h_p}{\theta} = \frac{N_{\delta_e}^h}{N_{\delta_e}^{\theta}} = \frac{K_{h_p \delta_e} (s + 1/T_{r_1})(s + 1/T_{h_2})(s + 1/T_{h_3})}{K_{\theta \delta_e} (s + 1/T_{\theta_1})(s + 1/T_{\theta_2})}$$

$$= \frac{-2.25(s + 0.026)(s + 4.45)(s - 4.91)}{s(s + 0.042)(s + 0.72)}$$

It should be recognized that these characteristics, being the ratio of numerators, are identical to the unaugmented airframe and cannot be modified by feedbacks or feed-forwards to the elevator.

Only the higher frequency roots, above, (i.e., $1/T_{\theta_2}$, $1/T_{h_2}$, and $1/T_{h_3}$) are of concern to the PIO problem. Their values are set by basic airframe characteristics. T_{θ_2} , the flight path lag, is due to wing loading and CL_{α} ; T_{h_2} and T_{h_3} are set primarily by the pilot's location relative to the center of instantaneous rotation (CIR) for elevator inputs. For a pilot location aft of the CIR, as in the Orbiter, $1/T_{h_2}$ and $1/T_{h_3}$ are two distinct first-order roots approximately the same magnitude but of opposite sign. In aircraft where the pilot is located forward of the CIR, the more common case, these two roots will couple into a second-order pair ω_h . For a more complete discussion of these transfer functions and approximations for the values of their roots, see Ref. 23.

Pilot Characteristics

$Y_{p\theta}$ accounts for the pilot's action in closing the inner attitude-to-elevator loop; Y_{ph} for his closure of the outer path-to-attitude loop. The pilot model forms used in the analysis are:

$$Y_{p\theta} = K_{p\theta} (T_{L\theta} s + 1) e^{-\tau_{\theta} s}$$

$$Y_{ph} = K_{ph}$$

Setting the lead $T_{L\theta}$, equal to the Fig. 26 equivalent system lag achieves the desired K/s result.

The pilot's time delay, τ_{θ} , is given by the relationship:

$$\tau_{\theta} = \tau_e - 0.1$$

to account for inflight motion cues, and

$$1/\tau_e = 0.24 + 0.214 (1/T_{L\theta}) \tag{12}$$

to account for the lead effect on time delay. The use of a low frequency pure gain pilot model (K_{ph}) in the outer attitude loop is consistent with experimental results.

Pilot/Vehicle Closed-Loop Characteristics

For pilot attitude gains corresponding to crossover frequencies from 2.5 to 4.0 rad/sec, the location of the closed-loop attitude mode, ω_{ap} , is shown (as diamonds) in the root locus plot of Fig. 27. As can be seen, the maximum stable crossover frequency is slightly less than 3.5 rad/sec. The other critical mode shown in this plot is the path mode, $1/T_{\theta_2}$, which for the above range of pilot gains is very close to the basic aircraft flight path lag, $1/T_{\theta_2}$.

These two inner-loop characteristics, ω_{ap} and $1/T_{\theta_2}$, limit outer-loop performance, as illustrated by the Fig. 28 root locus plots for pilot closure of the path loop. (Successive sets of diamond symbols along the three loci in each plot correspond to given increasing attitude gains.) These plots are for the two indicated levels of inner-loop crossover frequency. The left plot, for medium inner-loop gain, shows the slightly unstable attitude mode, ω_{ap} , being stabilized with increasing outer-loop gain resulting in the final closed-loop attitude mode designated by ω_{ap} . The closed-loop path mode, ω_h , results from the coupling of the $1/T_{\theta_2}$ path mode and the kinematic attitude integration. This plot also shows that, for medium inner-loop gain, the maximum

stable path mode frequency is limited to about 1.8 rad/sec. For reference, the observed ALT-FF5 PIO frequencies are noted in this plot. The right plot illustrates that for higher inner-loop gain a minimum level of outer-loop gain is necessary to stabilize the attitude mode, but the potential improvement in path bandwidth is minimal.

The tradeoff between performance and stability is illustrated by the closed-loop path/attitude stability boundaries shown in Fig. 29. The figure shows the closed-loop stability limits as a function of combinations of attitude and path gain. Within the stable region, lines of constant closed-loop mode frequency are also shown. At lower attitude gains a path mode instability will result at the limiting path gain. Since the (right-hand) path mode boundary is sloping upward to the right, higher path gains resulting in better performance (higher ω_n) can be achieved by increasing inner-loop attitude gain. This is true for attitude gains up to about 18 dB, which corresponds to an inner-loop crossover frequency of $\omega_{c\theta} = 3.5$ rad/sec (the left Fig. 28 plot). As attitude gains increase beyond 18 dB, increasing levels of path gain are required to stabilize the attitude mode.

For maximum performance, the pilot is drawn into the tip of the plot where the PIO region has been noted. At a stable operating point within this region, the system is very sensitive to both attitude and path gains. At a fixed attitude gain, lower path gain will result in an attitude mode instability, while a higher path gain results in a path mode instability. The range of stable path gains is only about 1.2 dB. A similar situation exists for fixed path gain. A higher attitude gain will result in an attitude mode instability and lower attitude gain in an unstable path mode. The only way to back out of this region in a stable manner is by a judicious, simultaneous and peculiarly proportional reduction in both attitude and path gains, a very difficult if not impossible piloting task for an unexpectedly encountered PIO. This extreme sensitivity to small increases or decreases in individual pilot control characteristics is the essence of this particular PIO situation. Nonlinearities, e.g., due to elevator surface rate limiting, will accentuate but not otherwise alter this essential character. The existence in the ALT-FF5 flight test data of both neutrally stable modes at very nearly the same frequencies indicated by the analyses is strong evidence that the PIO conditions have been analytically reproduced.

STOL APPROACH PATH CONTROL

(Example 8)

This example (from Ref. 25) provides a further exposition of the Fig. 23 "STOL" technique but certain aspects of the "CTOL" technique are invoked. In any event, for simplicity and improved clarity, we'll assume that the inner, θ , loop is tightly closed so that the pertinent dynamics of the aircraft's motions are given by the attitude numerator, i.e., the closed, inner-loop denominator, Δ' , given in general by:

$$\Delta' = \Delta + Y_{p\theta} N_{\delta e}^0$$

approaches $Y_{p\theta} N_{\delta e}^0$ for large $Y_{p\theta}$. Similar effects occur for all the usual control transfer function numerators. The net result is that the pertinent path control transfer functions are given rather simply in terms of the following forms and factors (for $\gamma_0 = 0^*$):

Characteristic $\Delta = Y_{p\theta} N_{\delta e}^0 = [(s^2 + (-Z_w - X_u)s + (Z_w X_u - X_w Z_u)]$ (13)
 $= s^2 + 2\zeta_{\theta}\omega_{\theta}s + \omega_{\theta}^2$
 or $(s + 1/T_{\theta 1})(s + 1/T_{\theta 2})$

Attitude Input Responses, assuming $X_{\delta e} = Z_{\delta e} = 0$, are correspondingly given by:

$$\frac{u}{\theta_c} = \frac{1}{\Delta}(X_a - g)(s + \frac{gZ_w}{X_a - g})$$
 (14)
 $= \frac{1}{\Delta}(X_a - g)(s + \frac{1}{T_{u1}})$

$$\frac{\dot{h}}{\theta_c} = \frac{Z_a}{\Delta}[s - X_u + \frac{Z_u}{Z_w}(X_w - \frac{g}{U_0})]$$
 (15)
 $= \frac{Z_a}{\Delta}(s + \frac{1}{T_{h1}})$

*The $\gamma_0 = 0$ initial condition does not detract from the general applicability of these small perturbation relations. Basically, the h responses so computed are equivalent to deviations normal to the flight path stability axis for the usually small values of γ_0 pertinent to approach conditions.

Throttle Input Responses** with $M_{\delta_T} = 0$ become:

$$\begin{aligned} \frac{u}{\delta_T} &= \frac{X_{\delta_T}}{\Delta} \left[s - Z_w + X_w \left(\frac{X_{\delta_T}}{Z_{\delta_T}} \right) \right] \\ &= \frac{X_{\delta_T}}{\Delta} \left(s + \frac{1}{T_{u\theta}} \right) \end{aligned} \quad (16)$$

$$\begin{aligned} \frac{\dot{h}}{\delta_T} &= -\frac{Z_{\delta_T}}{\Delta} \left[s - X_u + Z_u \left(\frac{X_{\delta_T}}{Z_{\delta_T}} \right) \right] \\ &= -\frac{Z_{\delta_T}}{\Delta} \left(s + \frac{1}{T_{h\theta}} \right) \end{aligned} \quad (17)$$

Notice that the characteristic Δ path mode roots are defined by the basic lift and drag terms, Z_w and X_u , plus the coupling terms, X_w and Z_u . The latter derivatives couple the speed and flight path modes. That is, the drag change with vertical motion, X_w , establishes how speed will vary with path rate of climb (i.e., w) and vice versa for the Z_u term. When their product is large and negative the path mode is oscillatory (ω_0^2); when small, the path modes are two first-order subsidences ($1/T_{\theta 1}$, $1/T_{\theta 2}$). Because the input numerators Eqs. 13-17 are all first order, there can be no cancellation of (selective) poles and zeros (as for the $T_{\theta 1}$, $T_{\theta 2}$ form) when the path mode is oscillatory. The result is that u and h motions then occur with the same dynamics and are therefore inherently coupled. However, the relative magnitudes of u and h are also important; and these are governed, for the throttle inputs, by the thrust-inclination, θ_T , and associated values of $X_{\delta_T}/Z_{\delta_T}$.

The consequences of coupled u and h responses are best illustrated by the control actions and responses associated with the two piloting techniques for a level of $X_w Z_u$ coupling which produces an oscillatory characteristic (ω_0). Considering the CTOL technique, $h \rightarrow \theta$ and $u \rightarrow \delta_T$, the time-history sketch (Fig. 30) shows that for a near step attitude input the \dot{h} response is more rapid and proportionately much greater than the corresponding u response (both are sketched to the same scale). In fact, there is essentially no u response in the first 3 to 4 sec, implying a very speed stable situation (due to the positive X_w required to produce the coupled, ω_0 , conditions). The final value of the speed change is conventional in that there is a reasonably small reduction for a nose-up attitude. Thus, from the standpoint of flight path control, $\dot{h} \rightarrow \theta_c$ appears direct and adequate. That is, u responses are decoupled from h responses, despite their oscillatory similarity, because of magnitude differences. Accordingly, provided speed error remains acceptably small, there are no anticipated control problems. However, because of its delayed response characteristics, precise u control with attitude (e.g., to correct for winds) would be difficult; furthermore, such corrections will introduce large flight path errors.

For speed control with throttle, we see that except for the short delay in h responses, the \dot{h} and u traces are very similar. That is, there is essentially no way of making a throttle-controlled speed correction without introducing altitude rate errors of equal magnitude. Physically, this interaction or coupling between u and h is obvious, since for $\theta_T = 0^\circ$, an h change is produced by a normal force change due to Z_u (i.e., $h = Z_u u$).

Changing techniques, i.e., controlling h with throttle and u with θ , only makes the situation more difficult because of the very poor u and associated large secondary h response. The pilot effectively has no direct measure of speed regulation for either technique.

To illustrate the other extreme, consider the inherently decoupled path mode condition ($1/T_{\theta 1}$, $1/T_{\theta 2}$). The purity of the individual transient response to throttle inputs is governed additionally by the values of $1/T_{u\theta}$ and $1/T_{h\theta}$. These zeros are affected by the inherent coupling derivatives, X_w and Z_u , and also by the ratio of the control force derivatives as shown specifically by Eqs. 16 and 17. Without the corrupting effect of these coupling terms on the dynamics (i.e., for $X_w = X_{\delta_T}/Z_{\delta_T} = 0$), the h path response to a throttle input, as previously given (Eqs. 13 and 16), is:

$$\frac{\dot{h}}{\delta_T} = \frac{-Z_{\delta_T}(s + 1/T_{h\theta})}{(s + 1/T_{\theta 1})(s + 1/T_{\theta 2})}$$

**Because of the constrained attitude effect, the u and h throttle-response numerators are not the usual simple δ_T numerators but rather the coupling numerators which apply when two (or more) control inputs are involved, hence the modified notation which reflects conventional multiloop practice.

3-18

where, now,

$$\frac{1}{T_{h0}} = -X_u = \frac{1}{T_{01}} \quad (18)$$

thus

$$\frac{\dot{h}}{\delta_T} = \frac{-Z_{\delta_T}}{s + 1/T_{02}}$$

For the assumed zero X_{δ_T} the corresponding u/δ_T is, of course, identically zero; however, for finite (but small) X_{δ_T} , $u/\delta_T \approx X_{\delta_T}/(s + 1/T_{01})$. The point is both responses are of different magnitude and frequency content, and this desirable feature of uncoupled path modes depends strongly on near-cancellation of certain numerator and denominator factors.

Such incomplete cancellation but good separation of u and \dot{h} responses occurs for stick inputs and the above-postulated conditions; i.e., for $X_w = 0$, $1/T_{u1} = -Z_w = 1/T_{02}$ and $1/T_{h1} = -X_u - (g/U_0)(Z_u/Z_w) = 1/T_{01} - (g/U_0)(Z_u/Z_w)$. Accordingly:

$$\frac{u}{\delta_c} = \frac{X_u - g}{s + 1/T_{01}}$$

$$\frac{\dot{h}}{\delta_c} = \frac{Z_u(s + 1/T_{h1})}{(s - 1/T_{01})(s + 1/T_{02})} \quad (19)$$

where

$$\frac{1}{T_{h1}} = \frac{1}{T_{01}} - \frac{g}{U_0} \left(\frac{Z_u}{Z_w} \right)$$

Although the u response is pure and slowly subsident ($1/T_{01}$), the \dot{h} response while basically fast ($1/T_{02}$) can also exhibit the same slow subsidence, depending on the ratio $1/T_{h1}$ and $1/T_{01}$. If they are both small and positive, the slow subsidence is essentially eliminated, and the \dot{h} response is then similar to that for throttle input (Eq. 15). If $1/T_{h1}$ is negative ("backside" operation), the subsident contribution is increased and the speed bleedoff eventually reverses the sign of the \dot{h} response. Notice too (Eq. 19) that the initial h/u response ratio is given by Z_u/g , a parameter most often used to characterize short-period response (Ref. 26); thus, path control may be an underlying factor in the current short-period dynamic requirements. Finally, we should note (Eqs. 13 and 15) that $1/T_{h1}$ and $1/T_{01}$ cannot be varied independently without also modifying the inherent attitude numerator; i.e., the basic derivatives, X_u , Z_u , X_w , Z_w , all appear in both ω_{θ}^2 and $1/T_{h1}$.

Closed-Loop Analyses

The foregoing qualitative discussion provides a physical feeling for two multiloop path control techniques. A more quantitative appreciation has been gained by closed-loop pilot/vehicle analysis applications (Refs. 27, 28). For example, Figs. 31 and 32, show the effect of thrust inclination, $X_{\delta_T}/Z_{\delta_T}$, and dynamic coupling, X_w , for a fixed value of Z_u , on the effective attitude closure bandwidth, ω_h , and gain, A_h . The two values of $X_w = 0$ and 0.1 correspond respectively to backside conditions of $1/T_{h1} = -0.09$ and -0.03 . The detailed aspects of these closures are described in Ref. 27; however, for each condition the bandwidth and gain were computed assuming that the pilot closed the $h + \delta_T$ loop with an ideal (constant) crossfeed to maintain effectively zero speed error; and the closed-loop bandwidth was defined by 45° of phase margin.

Without dwelling on the closure details, since our prime concern is closed-loop performance, notice that thrust angles between 90° and 0° show a progressive reduction in ω_h while the gain A_h , in general, increases. An increase in bandwidth would be expected to improve performance; however, an excessive increase in gain (i.e., sensitivity) tends to degrade performance. In fact, a high gain condition in combination with a low bandwidth is a rather poor control situation, reflecting the undesirable features of a sluggish response with a highly sensitive control. The vehicle doesn't respond rapidly enough for good regulation (e.g., suppression of disturbances), and with high sensitivity there is a strong tendency for a PIO (i.e., pilot-induced oscillation). The above considerations imply that the best pilot ratings occur at the higher inclinations as shown by the predicted trends in Figs. 31, 32. Note also that for $1/T_{h1} = -0.09$, the extreme backside condition, the variation in rating is more severe, with the best rating occurring at 90°.

The conditions analyzed above, plus a third set involving a second order (Eq. 13) ζ_{θ} , ω_{θ} , were tested using a simulated straight-in instrument (ILS) landing approach initiated on the localizer beam from an off-nominal glide slope situation and an initial trim speed of 60 knot. The attitude control response was held constant by using a rate-command attitude-hold augmentation scheme. The pilots were requested to correct the indicated off-condition (100 ft low) as quickly as possible; and they also generally introduced their own disturbances, offsets, and abuses to aid evaluation. The lateral ILS task was simply to maintain the localizer beam.

The matrix of test configurations examined in this experiment is given in Table 7. The basic dynamics of configurations 1-6 are typical of a tilt wing propeller STOL, configurations 7-12 are more representative of current thrust augmented vehicles (e.g., augmentor wing concept or deflected thrust arrangement), and configurations 13-18 represent an extreme of the trend established by the first two sets. Notice also that the "odd" thrust inclination of 63.5° was deliberately chosen to make the $1/T_{\theta}$ zeros cancel an appropriate pole. Also, since the path coupling and backside parameters are not independent, they were set to oppose each other. That is, the decoupled denominator dynamics ($1/T_{\theta 2} > 1/T_{\theta 1}$ and $X_w = 0$) were tested for an extreme backside condition, $1/T_{h1} = -0.09$, and conversely, the coupled denominator was tested at an extreme front-side configuration, $1/T_{h1} = 0.21$. This allowed assessment of whether the coupling or backside was governing, as well as the degree to which favorable thrust inclination could overcome either of these primary path control deficiencies.

Each of four experienced test pilots was instructed to fly first one technique, $h + \delta_T$ (STOL), then the other, $h + \theta$ (CTOL); however, they were free to consider other methods of control also.

Test Results and Discussion

The pilot ratings for each of the configurations tested are summarized in Fig. 33 as a function of thrust inclination and control technique. Both factors have significant effect on path control as evident by the rating trends.

Note the so-called backside (STOL) technique is increasingly superior to the conventional control technique as $1/T_{h1}$ becomes more negative. The implication is that the throttle is then used exclusively as a means of controlling path, and that attitude is used only as necessary to regulate speed errors. In fact, some comments show (as noted earlier for carrier approach) that at these backside situations the pilots do not attempt to control speed with the throttle; instead, they employ stable $h + T$ and avoid the more demanding task of controlling the speed divergence associated with the backside condition.

Returning to specific consideration of the data relative to the predictions of Figs. 31 and 32 for the various backside situations, we see that they are reasonably well confirmed. In particular, the predicted pilot rating trends based on the combined effects of the closed-loop performance parameters are essentially the same as those shown in Figs. 33a and 33b. The major pilot criticism directed at thrust angles beyond 90° was the aircraft's tendency to slow down for positive throttle inputs (e.g., when arresting sink rate). To regain the speed loss resulting from a positive flight path correction required the pilot to pitch over, increasing speed but at the same time canceling part of the desired flight path correction; in effect, reducing the gain as predicted.

For the extreme backside case at 0° thrust angle, another kind of complication revealed by the analysis of Ref. 27 is the predicted airspeed bandwidth $\omega_{ab} = 0.28$ which is greater than the altitude bandwidth $\omega_{hb} = 0.19$ (Fig. 31). Thus not only is the primary altitude response itself deficient but the normally expected primary: secondary response frequencies are reversed. For all other cases the ratio of $(\omega_a/\omega_h)_b$ runs from about 0.2 to 0.5 as thrust inclination is reduced from -90° toward zero.

For the highly-coupled situation given in Fig. 33c, only the single-loop control [$h + \theta(\delta)$] was considered nearly satisfactory by the pilots. In this case thrust inclination had little effect since the throttle was not used. However, some of the pilots experienced a strong tendency to oscillate along the path using only stick; and one pilot, in particular, noted the resemblance to pilot-induced oscillation (PIO). Although he attributed these tendencies to problems with pitch attitude control, they are more accurately a reflection of the flight path control and sensitivity between flight path response and attitude. Similar problems encountered with conventional angle of attack auto throttles (which modify X_w as here) are discussed in Ref. 28.

CONCLUSIONS

The foregoing examples, which are only a sampling of many in the literature (e.g., Ref. 7) illustrate the power and applicability of closed-loop man/machine analysis to the revelation, understanding, and simulation of handling related design problems. Deriving from this improved understanding and the presented, and other, applications are a number of observations and catalogues of desirable or undesirable closed-loop quantities. Tables 8-10 list some generally desirable closed-loop features, good path regulation properties, and pilot centered path regulation problems, in that order

Relative to the first item in Table 8; for multiple-loop problems, where a single control is being utilized, the leads developed in the inner loop of a series loop structure are propagated to, and are very helpful in effecting a good, outer-loop closure.

The point of the second item is that, where a crossfeed is helpful in "purifying" the effective control, the trained pilot will adapt one.

By closed-loop, low-frequency performance optimum in some sense corresponding to the minimization of rms error, is meant that the gain, crossover frequency, phase margin, etc., adapted are reasonably close to those required to effect minima among a

variety of errors - control usage, primary response, and secondary responses as well.

The fact that the pilot adapts to make the complete open-loop transfer function from input to output look like K/s in the crossover-frequency region is an observable experimental fact.

If the lead required to effect such K/s -ness is greater than one second, the pilot's opinion will be degraded, as will his workload capacity.

In a multiple-loop situation, the inner loop crossover is generally about three to four times that of the outer loops, so there is a distinct frequency separation. There is even a further distinction among trajectory responses where the frequency progression is from attitude to altitude to speed.

In all cases it appears that an adequate closed-loop damping ratio is in the range of 0.35-0.5.

Good performance requires low midfrequency droop (closed-loop gain 3 dB or so less than unity in the region below crossover frequency). This, along with others of the above, may be recognized as the basis for the original Neal-Smith criterion for short period control (Ref. 30).

Increasing the gain or pilot lead should produce a favorable effect on performance and bandwidth and damping.

To be more specific, and detailed, the "good" path regulation properties listed in Table 9 are clarified below:

The inner, attitude loop, fundamental to path control regardless of technique, should have response characteristics generally faster, better damped, etc., than the primary path loop. A minimum crossover frequency is about 2 rad/sec (Ref. 31) with adequate gain and phase margins. Closing the inner loop should improve phugoid damping and provide overall path mode equalization, insensitive to and tolerant of the "tightness" or "looseness" of attitude control.

The h-loop (with θ closed) should have faster response than the u-loop by at least a factor of 3; its minimum crossover, with adequate gain and phase margins and without equalization, should be of the order of 0.5 rad/sec (Ref. 32).

It should be possible to control \dot{h} without exciting excessive excursion in u ; and vice versa. If some degree of coupling exists, it should be complementary, i.e., control to regulate one path variable helps in regulating the other.

During path regulation and control, limits due to stall, buffet, control, comfort, etc., must never be exceeded, and excursions into the available margins should be minimized.

The pilot desires to use the minimum number of nonsensitive feedback loops with little or no equalization and/or crossfeeds. Such "economical" control allows him sufficient excess capacity for other functions.

An otherwise dynamically good airplane can be seriously degraded if control sensitivities are too high or too low, and/or if the relative sensitivities are disproportionate.

Some specific pilot-centered path regulation "problems" as listed in Table 10, are useful in pinpointing known sources of pilot complaints or in suggesting aircraft and/or flight control system modifications to improve pilot acceptance.

Inadequate bandwidth problems are often associated with low short-period stiffness where the attitude response is dominated by the phugoid mode. These situations require excessive pilot lead compensation (Refs. 31 and 33).

Inner-outer-loop equalization conflict results when pilot lag is required in the attitude loop, (Ref. 31), thereby restricting the path mode bandwidth.

Low static attitude gain is another manifestation of backside-ness. Sufficiently low values of static gain limit the pilot's ability to separate u and \dot{h} responses. Also, attitude trimmability and the use of attitude as a speed reference are degraded, resulting in increased attentional demands on the pilot (Refs. 34, 35).

Attitude gain (Ref. 20) and lead-equalization (Ref. 35) sensitivity are underlying control problems affecting path regulation.

Performance reversals occur when increased pilot gain and/or lead, cause a net loss in performance. Other "boxed-in" reversal situations (Ref. 35) constrain the pilot control strategy, narrowly confined his gain and/or lead. Increasing or decreasing gain equalization causes an undesirable performance degradation.

Inadequate bandwidth is primarily an altitude loop (with attitude closed) problem. When the loop crossover frequency is less than about 0.3 to 0.4 rad/sec (Ref. 32) the pilot rating will be unsatisfactory.

Inadequate response separation refers to undesirable "mixing" of u and h response. If u is faster than h, the "mixing" is especially bad; in general, u responses faster than about half the h response (assuming the latter is adequate, as above) are undesirable.

Additional crossfeed difficulties arise when the necessary or required control actions are too large, are unnatural (e.g., reversed sign), or when they limit regulation performance (e.g., by reducing effective gain or bandwidth).

Excessive depletion of safety margins can be caused by any combination of the above deficiencies. The type and smallness of the available margin may dictate the control strategy, e.g., if stall margin is small, control h with throttle rather than with elevator.

Departures from desirable path gain levels result in degraded ratings and poorer pilot acceptance. Analysis in terms of rms control deflections or forces can sometimes provide a clue to degrading gain levels (Refs. 36, 37).

Recognize that, although not exactly short, this is a much abbreviated list of pilot centered requirements and problems as opposed to an airplane or systems centered set, which would be much more diverse and diffused. Also, as already mentioned, some of these desirable qualities have been translated directly into flying qualities requirement terms which will be the subject of subsequent lectures.

REFERENCES

1. Cooper, George E., and Robert P. Harper, Jr., The Use of Pilot Rating in the Evaluation of Aircraft Handling Qualities, NASA TN D-5153, Apr. 1969.
2. McDonnell, John D., Pilot Rating Techniques for the Estimation and Evaluation of Handling Qualities, AFFDL-TR-68-76.
3. McRuer, D. T., and E. S. Krendel, Mathematical Models of Human Pilot Behavior, AGARDograph No. 188, Jan. 1974.
4. Hoh, Roger H., David G. Mitchell, Irving L. Ashkenas, et al., Proposed MIL Standard and Handbook -- Flying Qualities of Air Vehicles, Vol. II: Proposed MIL Handbook, AFWAL-TR-82-3081, Nov. 1982.
5. Loschke, Paul C., Marvin R. Barber, Einar K. Enevoldson, et al., Flight Evaluation of Advanced Control Systems and Displays on a General Aviation Airplane, NASA TN D-7703, June 1974.
6. Wilhelm, K., and D. Schafranek, "Landing Approach Handling Qualities of Transport Aircraft with Relaxed Static Stability," J. Aircraft, Vol. 23, No. 10, Oct. 1986, pp. 756-762.
7. Ashkenas, I. L., "Twenty-Five Years of Handling Qualities Research," J. Aircraft, Vol. 21, No. 5, May. 1984, pp. 287-301.
8. Weissman, Robert, "Criteria for Predicting Spin Susceptibility of Fighter-Type Aircraft," ASD-TR-72-48, June 1972.
9. Hoh, Roger, H., and Irving L. Ashkenas, "Handling Qualities Criterion for Heading Control," J. Aircraft, Vol. 14, No. 2, Feb. 1977.
10. Hoh, R. H., T. T. Myers, I. L. Ashkenas, et al., Development of Handling Quality Criteria for Aircraft with Independent Control of Six Degrees of Freedom, AFWAL-TR-81-3027, Apr. 1981.
11. Watson, John, W., and Jack D. McAllister, "Direct Force Flight-Path Control -- The New Way to Fly," AIAA Paper No. 77-1119, Aug. 1977.
12. Johnston, Donald J., and D. T. McRuer, "Investigation of Limb-Sidestick Dynamic Interaction with Roll Control," J. Aircraft, Vol. 10, No. 2, Mar. 1977, pp. 178-186.
13. Garland, Michael P., Michael K. Nelson, and Richard C. Patterson, F-16 Flying Qualities with External Stores, AFPTC-TR-80-29, Feb. 1981.
14. Hall, G. Warren, and Rogers E. Smith, Flight Investigation of Fighter Wide Stick Force-Deflection Characteristics, AFFDL-TR-75-39, May 1975.
15. Monagan, Stephen J., Rogers E. Smith, and Randall E. Bailey, Lateral Flying Qualities of Highly Augmented Fighter Aircraft, Vols. I and II, AFWAL-TR-81-3171, Mar. 1982.

3-22

16. Hoh, Roger H., Richard H. Klein, and Walter A. Johnson, Development of An Integrated Configuration Management/Flight Director System for Piloted STOL Approaches, NASA CR-2883, Aug. 1977.
17. Weir, D. H., R. H. Klein, and D. T. McRuer, Principals for the Design of Advanced Flight Director Systems Based on the Theory of Manual Control Displays, NASA CR-1748, Mar. 1971.
18. Johnson, Walter A., and Samuel J. Craig, "Configuration Management During Transition for a Powerad-Lift STOL Aircraft," J. Aircraft, Vol. 13, No. 2, Feb. 1976., pp. 119-122.
19. Klein, Richard H., and Warren F. Clewett, Application of Manual Control Display Theory to the Development of Flight Director Systems for STOL Aircraft, AFFDL-TR-72-152, Jan. 1973.
20. Crowell, C. H., and I. L. Ashkenas, A Systems Analysis of Longitudinal Piloted Control in Carrier Approach, Systems Technology, Inc., TR-124-1, June 1962.
21. Ashkenas, I. L., and T. S. Durand, "Simulator and Analytical Studies of Fundamental Longitudinal Control Problems in Carrier Approach," AIAA Simulation for Aerospace Flight Conf., Aug. 1963, pp. 16-34.
22. Wasicko, Richard J., Application of Approach Speed Criteria Derived from Closed-Loop Pilot-Vehicle Systems Analyses to an Ogee Wing Aircraft, NASA CR-579, Sept. 1966.
23. Ashkenas, Irving L., Roger H. Hoh, and Gary L. Teper, "Analyses of Shuttle Orbiter Approach and Landing," Guidance, Control, and Dynamics, Vol. 6, No. 6, Nov./Dec. 1983, pp. 448-455.
24. McRuer, Duane T., Irving L. Ashkenas, and Dunston Graham, Aircraft Dynamics and Automatic Control, Princeton University Press, Princeton, NJ, 1973.
25. Craig, S. J., and R. K. Heffley, "Factors Governing Control in a STOL Landing Approach," J. Aircraft, Vol. 10, No. 8, Aug. 1973.
26. Anon, Military Specification, Flying Qualities of Piloted Airplanes, MIL-F-8785C, Nov. 1980.
27. Ashkenas, I. L., and S. J. Craig, "Multiloop Piloting Aspects of Longitudinal Approach Path Control," ICAS Paper No. 72-46, 8th Congress of the ICAS, 28 Aug. -- 2 Sept. 1972.
28. Craig, S. J., R. P. Ringland, and I. L. Ashkenas, An Analysis of Navy Approach Power Compensator Problems and Requirements, AD 722 023, PC A13, Mar. 1971.
29. Franklin, James A., Robert C. Innis, Gordon H. Hardy, et al., Design Criteria for Flight Path and Airspeed Control for the Approach and Landing of STOL Aircraft, NASA TP-1911, Mar. 1982.
30. Neal, T. P., and R. E. Smith, An In-Flight Investigation to Develop Control System Design Criteria for Fighter Airplanes, AFFDL-TR-70-74, Dec. 1970.
31. Stapleford, Robert L., and Irving L. Ashkenas, "Effects of Manual Altitude Control and Other Factors on Short-Period Handling Quality Requirement," J. Aircraft, Vol. 5, No. 1, Jan.-Feb. 1968, pp. 41-48.
32. Ashkenas, I. L., "Summary and Interpretation of Recent Longitudinal Flying Qualities Results," J. Aircraft, Vol. 8, No. 5, May 1971, pp. 324-328.
33. Craig, S. J., and I. L. Ashkenas, Background Data and Recommended Revisions for MIL-F-8785B(ASG), "Military Specification -- Flying Qualities of Piloted Airplanes", Systems Technology, Inc., TR-189-1, June 1970.
34. Teper, Gary L., An Assessment of the "Paper Pilot" -- An Analytical Approach to the Specification and Evaluation of Flying Qualities, AFFDL-TR-71-174, Nov. 1971.
35. Craig, Samuel J., and Anthony Campbell, Analysis of VTOL Handling Qualities Requirements, Part I: Longitudinal Hover and Transition, AFFDL TR-67-179, Part I, Oct. 1968.
 Craig, Samuel J., Anthony Campbell, and R. H. Klein, Analysis of VTOL Handling Qualities Requirements, Part II: Lateral-Directional Hover and Transition, AFFDL-TR-67-179, Part II, Feb. 1970.
36. McRuer, D. T., and H. R. Jex, "A Review of Quasi-Linear Pilot Models," IEEE Trans., Vol. HFK-8, No. 3, Sept. 1967, pp. 231-249.
37. Walton, R. P., I. L. Ashkenas, and C. P. Shortwell, Analytical Review of Military Helicopter Flying Qualities, Systems Technology, Inc., TR-143-1, Nov. 1963.

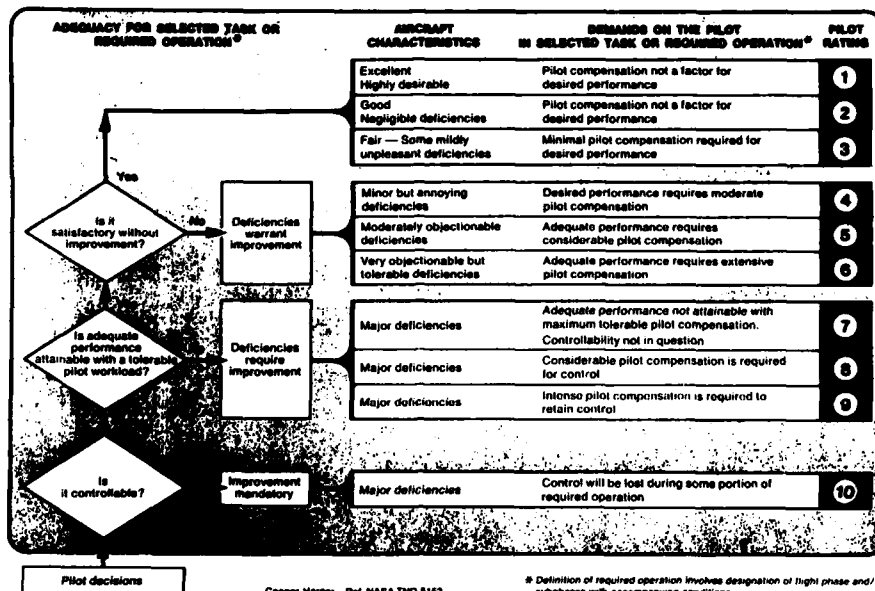

Figure 1. Cooper-Harper Handling Qualities Rating Scale

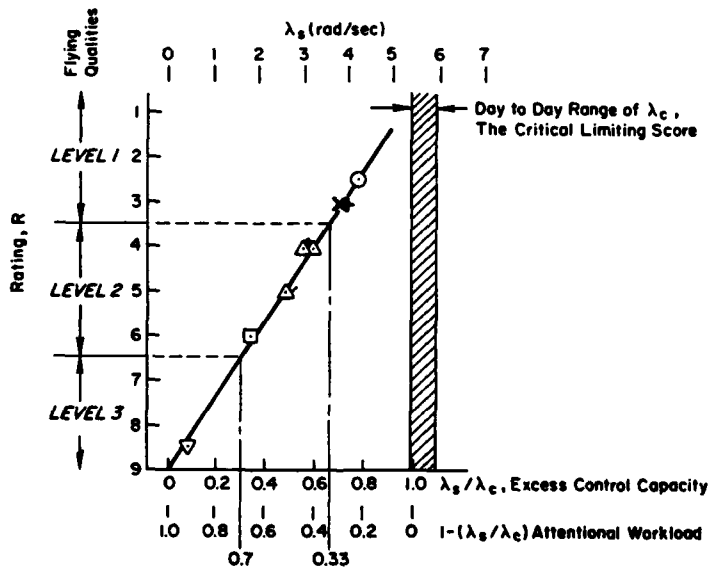

Figure 2. Subjective Pilot Rating Versus First-Order Cross-Coupled Instability Score

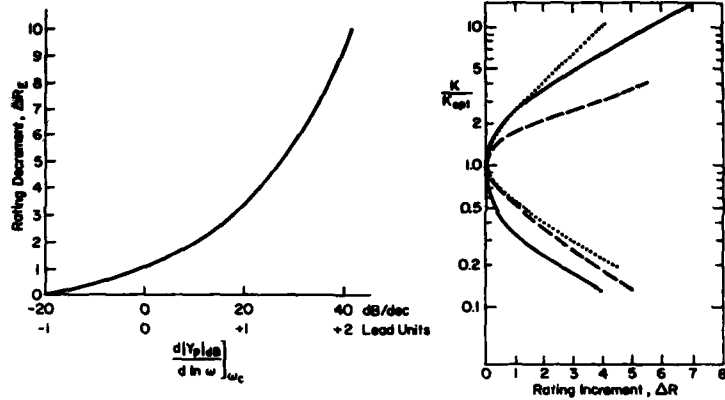

Figure 3. Pilot Rating Decrements as Functions of Lead Equalization and Gain

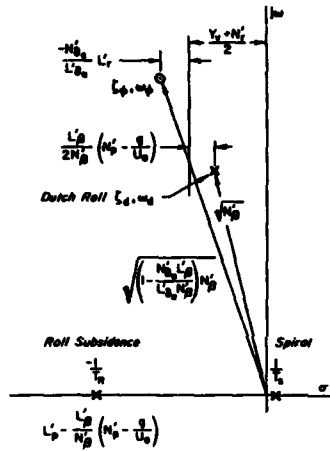
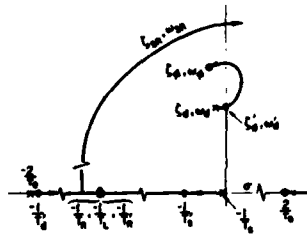
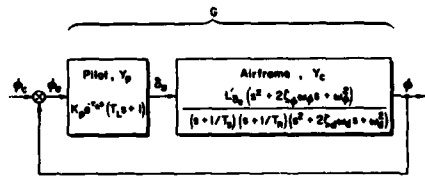
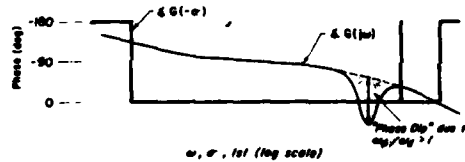
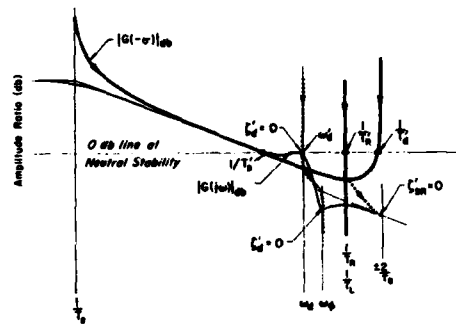

Figure 4. Root Plot of Roll Angle/Aileron Transfer Function and Approximate Factors



(b) Root Locus



(a) Bode $G(j\omega)$, $G(-\sigma)$ Diagrams and Bode-Root Locus

Figure 5. System Survey of Pilot Control of Roll Attitude ($\phi \rightarrow \delta$)

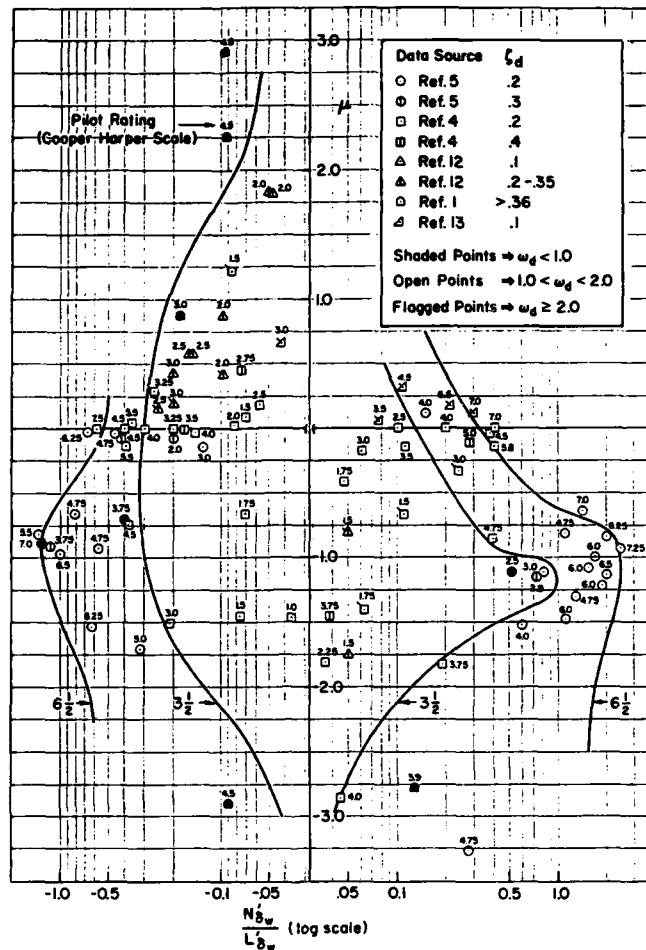

Figure 6. Pilot Rating Correlation with Crossfeed Parameters

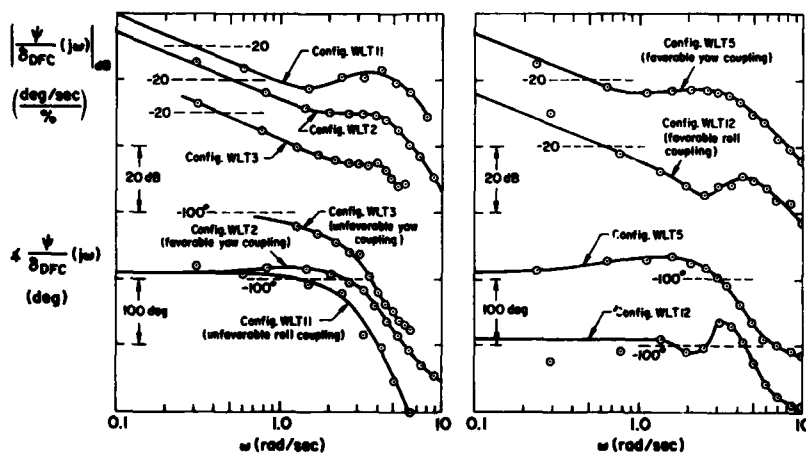

Figure 7. Fourier Transformed Heading Responses

3-26

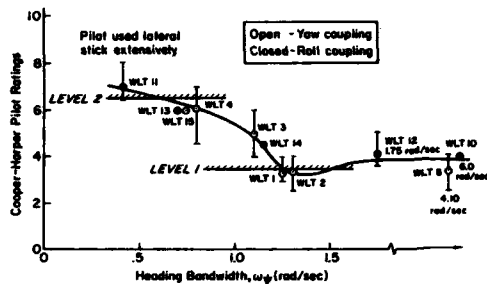

Figure 8. Correlation of Pilot Ratings with Heading Bandwidth; Wings-Level Turn Mode; Air-to-Air Tracking Task

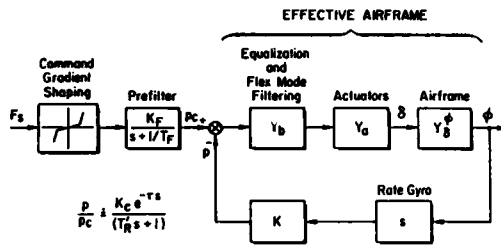

Figure 9. Typical fly-by-wire roll control system

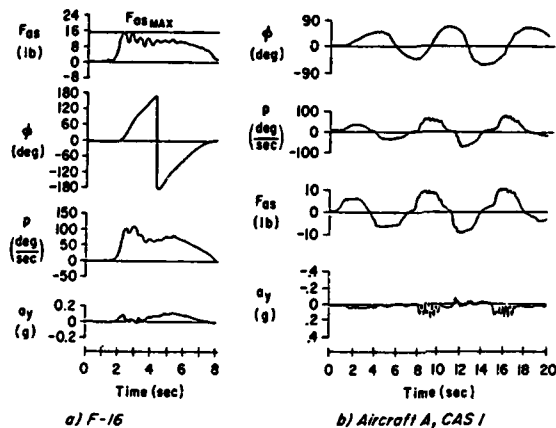

Figure 10. Roll Ratchet During Banking Maneuver

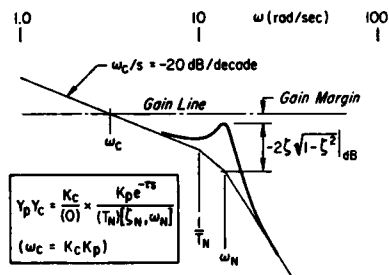

Figure 11. Bode Amplitude Ratio Plot For Neuromuscular System Contribution To Roll Ratchet Potential

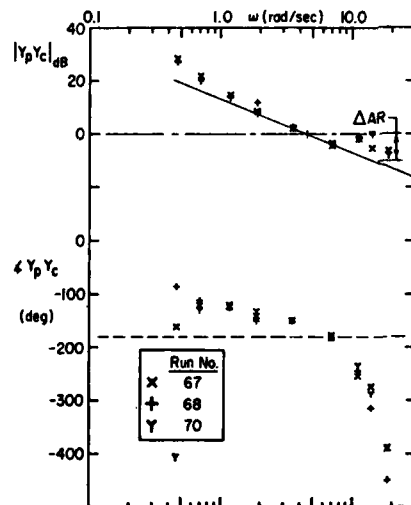

Figure 12. $Y_p Y_c$ Describing Function Amplitude and Phase Plot for $Y_c = 4/s e^{-0.067s}$

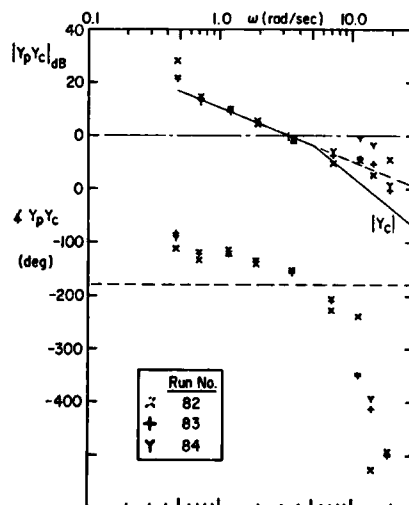

Figure 13. $Y_p Y_c$ Describing Function Amplitude and Phase Plot for $Y_c = \frac{4e^{-0.067s}}{s(0.2s+1)}$

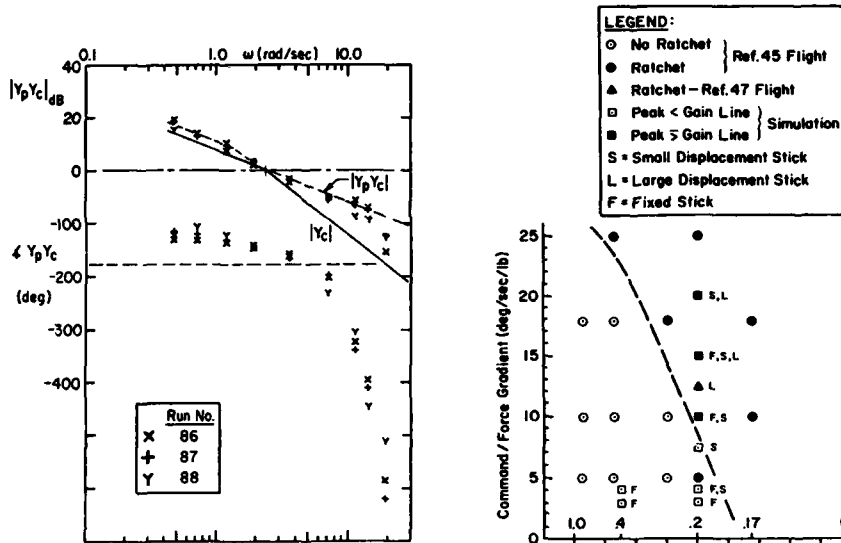

Figure 14. $Y_p Y_c$ Describing Function Amplitude and Phase Plot for $\frac{4e^{-0.067s}}{s(0.4s+1)}$

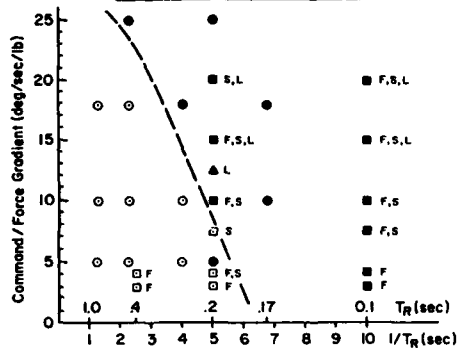

Figure 15. Roll Ratchet Comparison, Flight and Simulator

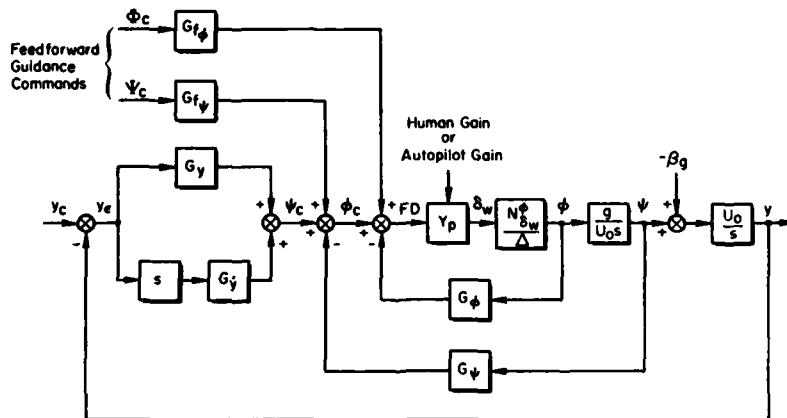

Figure 16. General Block Diagram for Lateral Flight Director

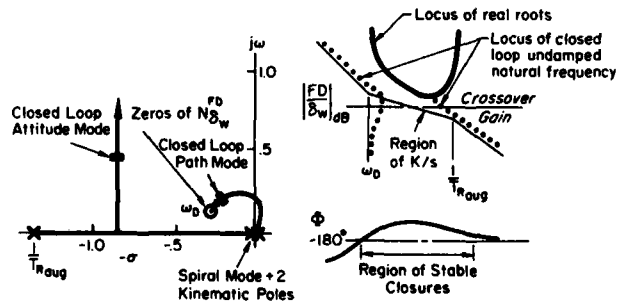

Figure 17. Generic System Survey of Piloted or Automatic System Closure of Lateral Flight Director Loop

3-28

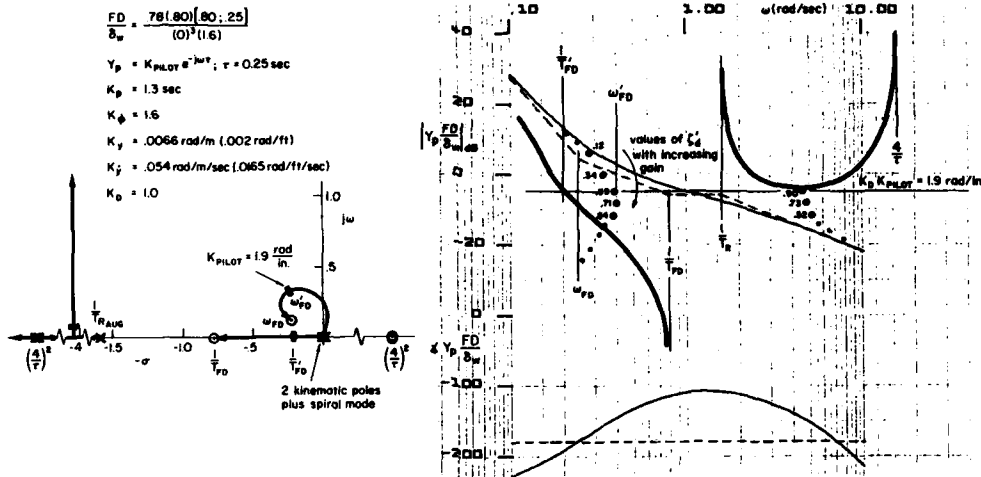

Figure 18. System Survey for Flight Director A, $Y_p(FD/\delta_w)$

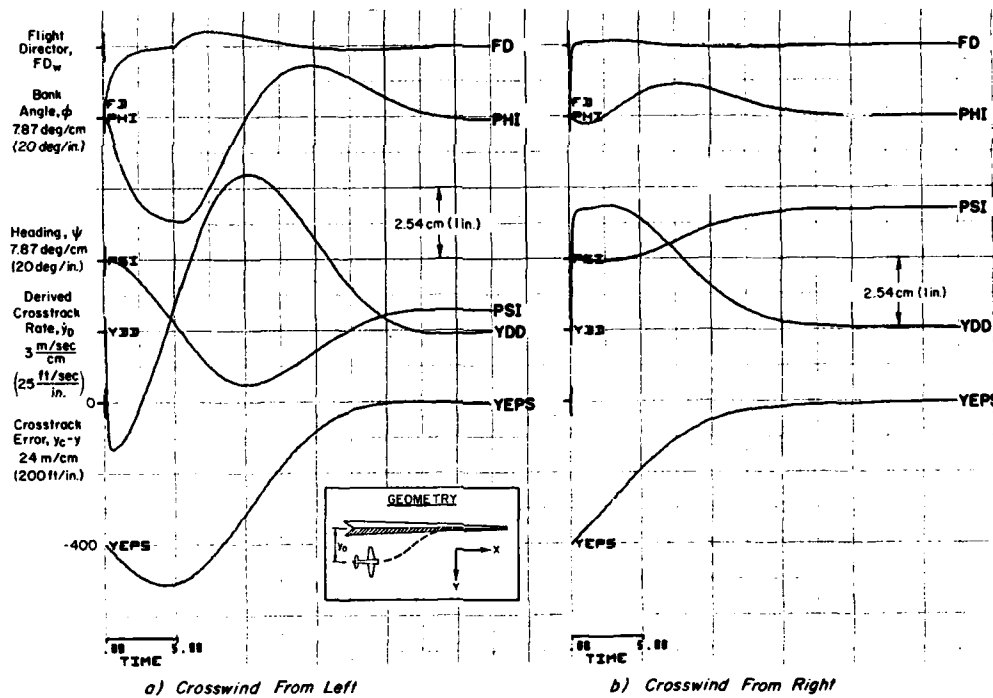

Figure 19. Flight Director A Response to Initial Condition Offset with a 25 kt Crosswind at an IAS of 90 kt

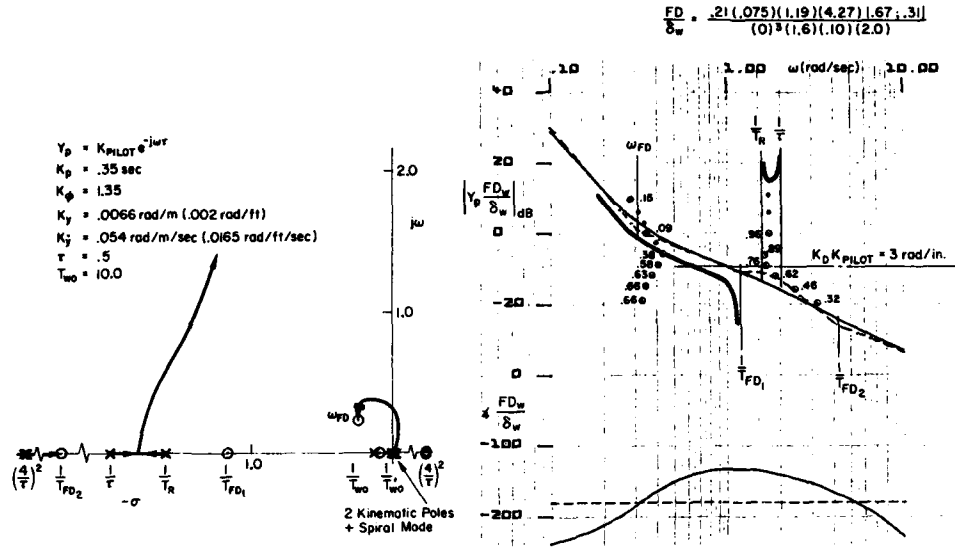

Figure 20. System Survey for Flight Director B, $Y_p(FD/\delta_w)$

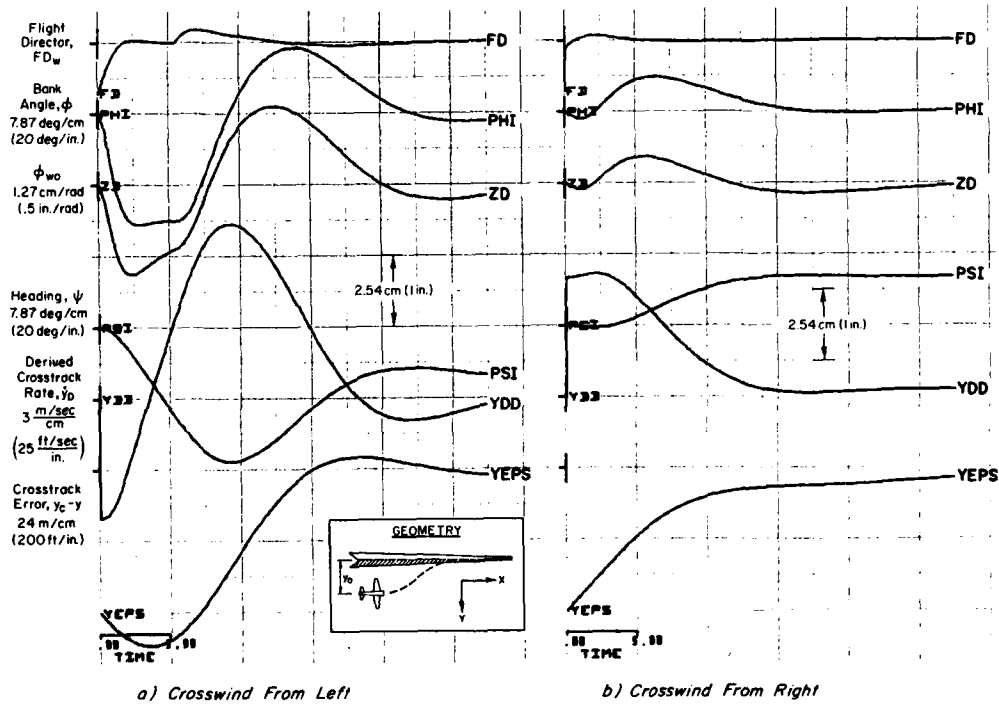

Figure 21. FD B Response to an Initial Condition Offset with a 25 kt Crosswind

3-30

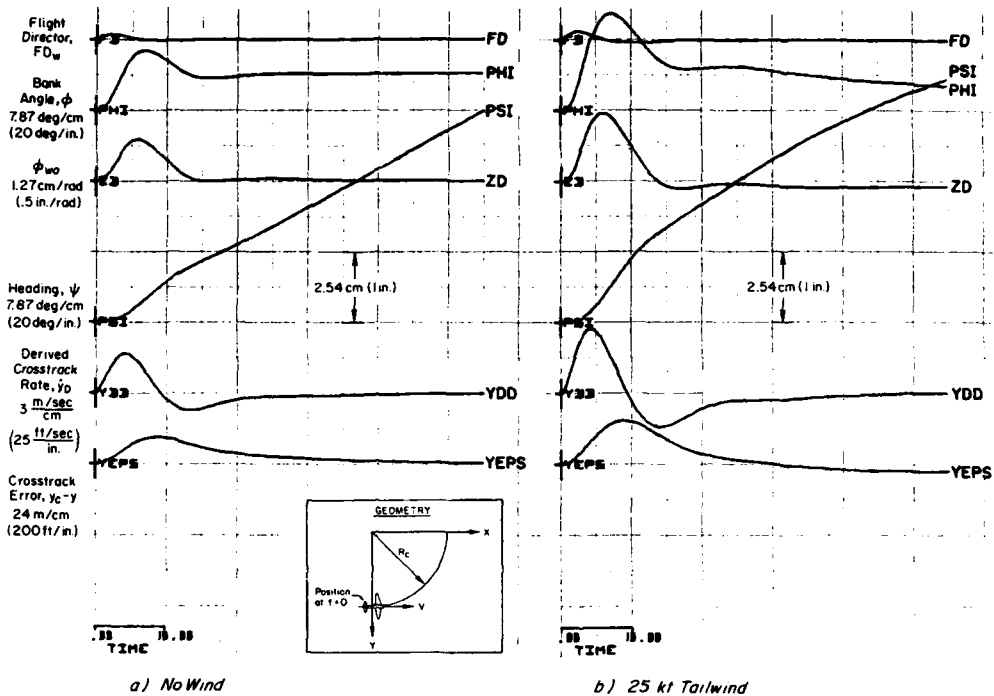

Figure 22. Flight Director B Curved Course Intercept, $R_c = 1219m$ (4000 ft), $v = 90$ kt

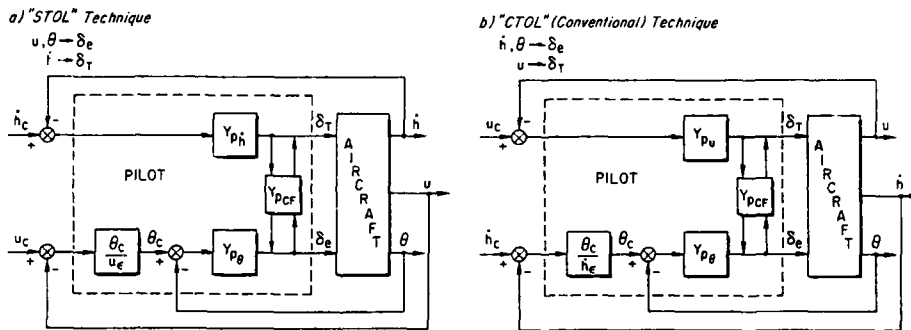

Figure 23. Two Representative Piloting Techniques

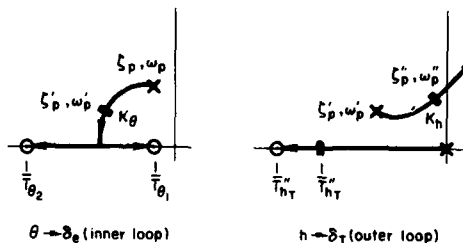

Figure 24. Root Locus Illustration of Successive Loop Closures

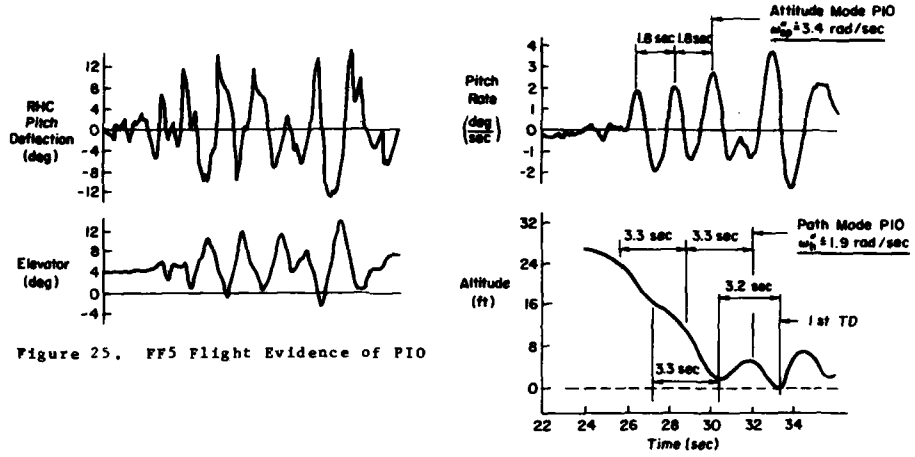

Figure 25. FF5 Flight Evidence of PIO

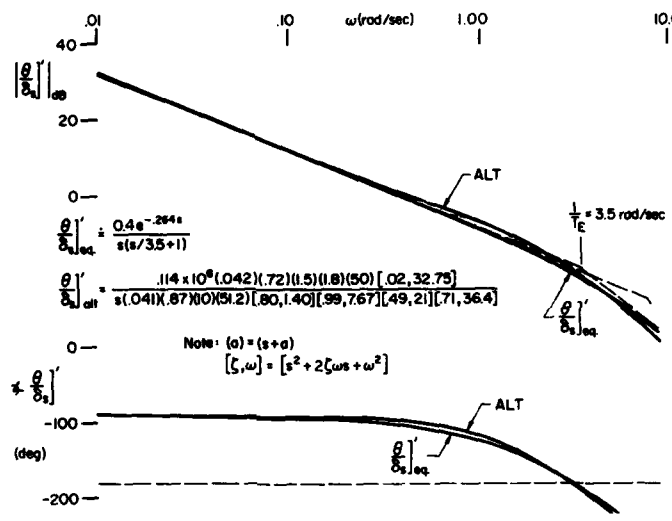

Figure 26. Orbiter Attitude Response; ALT-FF5 PIO Conditions

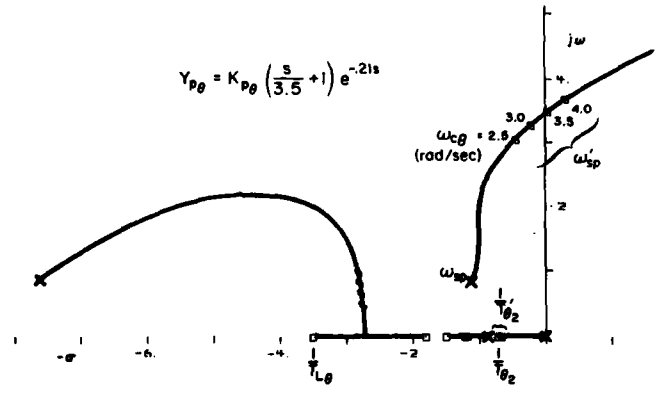

Figure 27. Root Locus for Pilot Closure of Attitude Loop, Orbiter ALT Configuration

3-32

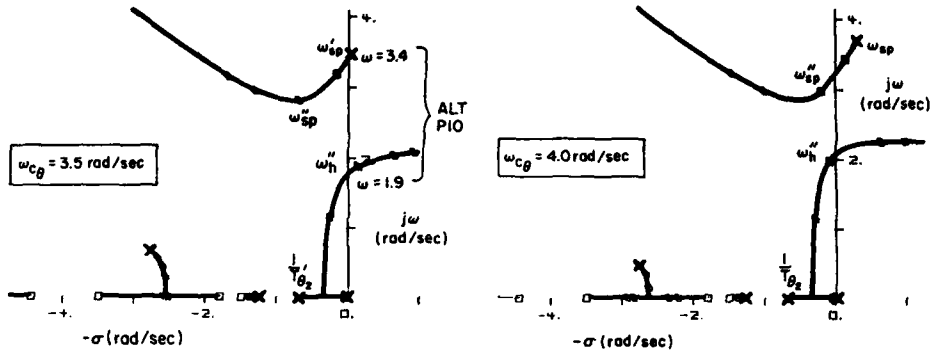

Figure 28. Pilot Closure of Path Loop, Orbiter ALT Configuration

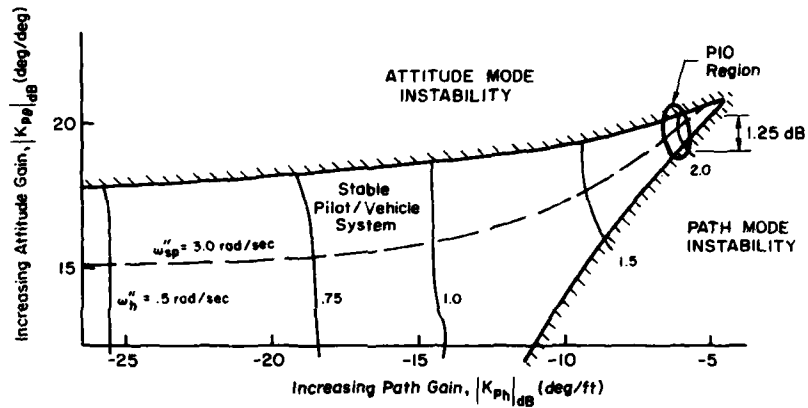

Figure 29. Closed-Loop Path/Attitude Stability Boundaries, Pilot/ALT System

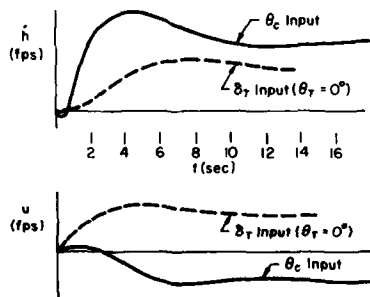

Figure 30. Speed and Altitude Rate Response to Step Attitudes and Throttle Inputs

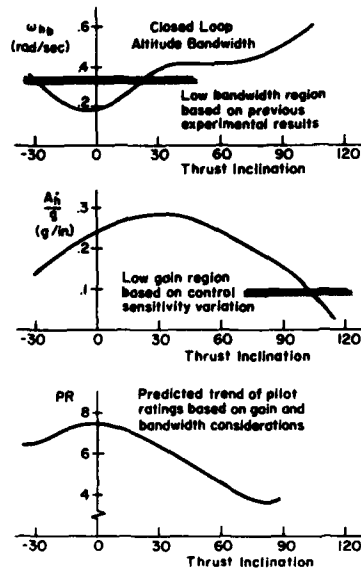

Figure 31. Closed-Loop Analysis of Path Control; $X_w = 0$ ($1/T_{h1} = -0.09$)

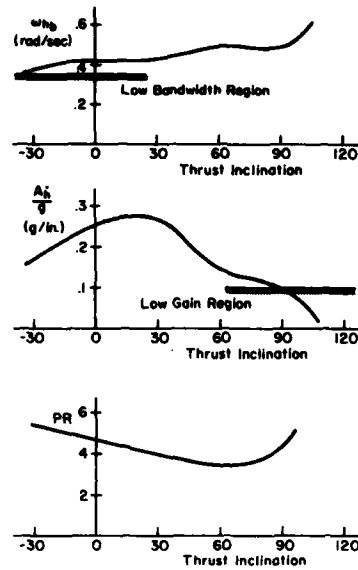

Figure 32. Closed-Loop Analysis of Path Control; $X_w = 0.01$ ($1/T_{h1} = -0.03$)

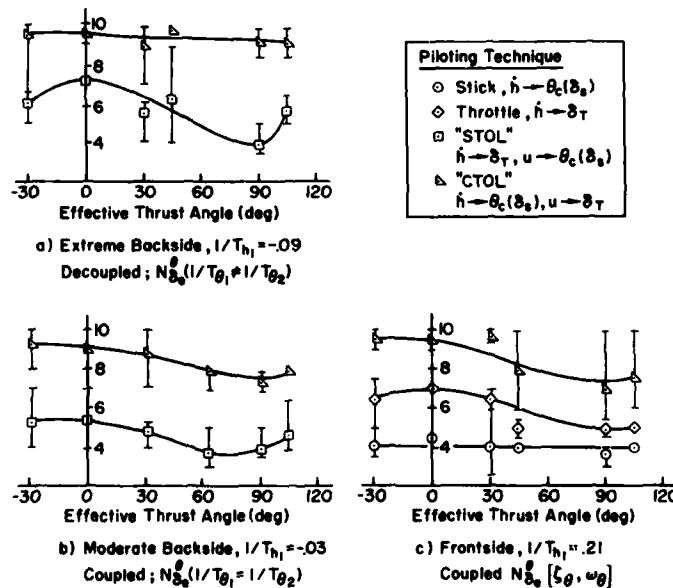

Figure 33. Effect of Thrust inclination and Control Technique on Handling Qualities (Pilot Rating)

TABLE 1. INFLUENCE OF ATMOSPHERIC DISTURBANCE ON PILOT RATING DEFINITION OF FLYING QUALITIES

LEVEL	ATMOSPHERIC DISTURBANCES			
	LIGHT	MODERATE	SEVERE	EXTREME
1	3-1/2	5-1/2	7-1/2	Flying qualities such that control can be maintained long enough to fly out of the disturbance
2	6-1/2	7-1/2	Flying qualities such that control can be maintained long enough to fly out of the disturbance	Flying qualities such that pilot can regain control after being upset
3	9-1/2	Flying qualities such that control can be maintained long enough to fly out of the disturbance	Flying qualities such that pilot can regain control after being upset	No requirement

TABLE 2. SOME PAST APPLICATIONS OF PILOT-VEHICLE-DISPLAY SYSTEM ANALYSES TO

a) DESIGN

SITUATION	ANALYSIS RESULTS	REFERENCES
Basic Airframe and Primary Control System	Predict multiple, closed-loop pilot-vehicle system problem areas and assess possible solutions	12-16 21-48
Limits of Dynamic Control	Strongly depends on pilot time delay	12, 33 49-63
Stability Augmentation Tradeoffs	Carry out stability augmentation systems, pilot behavior and workload, system performance and compromises, reliability, redundancy, etc.	64-72
SAS Failure Effects	Pilot actions and resulting aircraft excursions	73-79
Competing Pilot Display Formats Manual Control AFCS Monitoring	Information requirements, scan patterns, workload, assessment factors and criteria	80-94
Flight Director	Command display laws, status information requirements, flight director/pilot stability augmentation tradeoffs	95-107
Carrier Landing Aids	Optimum FLOCS control and stabilization	12 108-114
Categories II and III Landing System	Probability of approach success, decision "state windows," touchdown statistics, manual/automatic trade-offs, guidance sampling	115-118
Energy-Trim Management	Simplified controls/displays	119-122
Actuation Systems	Permissible lags, non-linearities rate limits	123-125

b) FLIGHT ENCOUNTERED PROBLEMS

SITUATION	CONTROL PROBLEM	CAUSES	REFERENCES
Pilot-Induced Oscillations	Pitch (Single Loop) Roll (Single Loop) Pitch and Altitude (2 Loops)	Sensitivity; Bobweight/Feel Spring; Loss of Pilot Lag; Elevator Rate Limiting Yawing Effect; Lateral Bobweight Excess Time Delay in Control Loop; Adverse Pilot Location	126-133
Weapon Delivery	Heading Aim Wander (2 Loops)	Loss of Roll Loop; Lateral-Directional MultiLoop Cross Coupling	134-137
Carrier Landing	Path Control-Inability to Arrest Rate of Sink (2 and 3 Loops)	Dynamic Reversal in Path	28, 138-144
Altitude Control	Pitch (Single Loop)	Improper Pilot/ Stability Augmenter Matching; High Control Sensitivity	144-147
High α Departures	Pitch and Roll (2 Loops)	Adverse Pitch-Roll (Coupling) Numerator	148-154
6 DOF Control	Adverse Control Coupling	Reduction in Effective System Bandwidth	155-156

c) SIMULATION

SITUATION	ANALYSIS RESULTS	REFERENCES
Pre-Experimental Analysis	Predict critical areas and parameters, guidance for experimental design, pilot briefing, questionnaire	142, 157-160 163-166
Post-Experimental Analysis	Interpretation and generalization of results	157-167
Competing Piloting Techniques	Pilot control procedures, system performance and safety margin differences. Control system refinements to simplify piloting technique.	157-162 167
Motion-Cue Simulation	Task-dependent motion sensitivity, optimum washout design	168-182

TABLE 3. PILOT/VEHICLE SYSTEM REQUIREMENTS FOR FLIGHT DIRECTOR DESIGN

Guidance and Control

- Command Following
- Disturbance Regulation
- Stability and Damping

Pilot-Centered

- Minimum Pilot Compensation
 - Feedbacks
 - Equalization
- Response Quality
- Command Bar Consistency
- Frequency Separation of Controls
- Non-Interacting Controls
- Insensitivity to Pilot Response Variations
- Remnant Suppression

For disturbance regulation, the system must regulate against:

- Steady winds
- Random turbulence and gusts
- Horizontal wind shears

TABLE 4. EFFECT OF FEEDBACKS ON SYSTEM REQUIREMENTS

FEEDBACKS	GUIDANCE AND CONTROL REQUIREMENTS		PILOT CENTERED REQUIREMENTS	
	PRIMARY REQUIREMENT	COMMENTS	PRIMARY REQUIREMENT	COMMENTS
Bank Angle, ϕ	Stability	Requires feedforward for curved paths (See Appendix C)	Command bar consistency	Mid-frequency flight director motions should look like bank angle
Washed Out Bank Angle, ϕ	Stability	Washout time constant must be high enough to satisfy stability requirement yet low enough to insure good path following and disturbance regulation characteristics	Command bar consistency	Mid-frequency flight director motions should look like bank angle Washout must be high enough to maintain face validity
Roll Rate, p	None	Tends to reduce path damping	Minimum pilot compensation Remnant suppression	Provides K/s-like response at frequencies beyond the roll mode Provides good flight director response at curved path intercept point
Heading, ψ	Path Damping	Requires feedforward for curved path and for disturbance regulation on curved path— not practical	Minimum pilot compensation Path mode consistency Remnant suppression	Determines localizer capture rate
Washed Out Heading, ψ_{wo}	Path Damping	Requires feedforward for curved path and wind shear on straight path	Same as above	Same as above
Course Angle, λ	Path Damping	Requires feedforward for curved path Requires inertial navigation system or equivalent for measurement	Same as above	Same as above
Crosstrack Rate, \dot{y}	Path Damping	Does not require feedforward Beam noise problems due to differentiation of crosstrack deviation	Same as above	Same as above
Crosstrack Error, y_e	Path Command and Disturbance Regulation		Path mode consistency	Should be compatible with localizer errors High sensitivity at long distances from touchdown are not desirable
Localizer Error, ϵ	Path Command and Disturbance Regulation	Stability problems due to constantly varying crosstrack deviation sensitivity with range	Same as above	
Beam Integral	Disturbance Regulation	Long time constant required for stability reduces regulation effectiveness	Same as above	Results in inconsistencies between command and localizer errors after periods of unattended operation

TABLE 5. PARAMETER ADJUSTMENT TRADEOFFS

REQUIRED FOR "DESIRABLE LOCUS"	OTHER SYSTEM CONSIDERATIONS
Minimize $K_y/K_{\dot{y}}$	Very low values of $K_y/K_{\dot{y}}$ result in poor response quality due to "long tails" during capture. $e^{-K_y/K_{\dot{y}}t}$ is the dominant mode at low frequency
Maximize T_{w0}	Bank angle must wash out faster than the dominant path mode (ω_{PD}) to minimize residual feedback which will result in standoffs with y_c .
Minimize τ	The break frequency of the beam rate filter is $1/\tau$, and as such, requires τ be kept large enough for adequate noise rejection.

TABLE 6. MULTI-LOOP PILOT MODEL

Uses Available Feedbacks

- Directly sensed in general visual field
- Observable via visual displays
- Directly sensed using modalities other than vision

Preferred Feedback Loops

- Can be closed with minimum pilot equalization
- Require minimum scanning
- Permit wide latitude in pilots characteristics
- Correspond to good flight control theory and practice

Crossover Model

- Is directly applicable to closure of inner-loops (higher bandwidth) and outer-loops (lower bandwidth) which include effects of all inner-loop closures
- Gain adjustments of loops akin to those used by skilled control designer

Remnant

For undivided attention (no scanning) is essentially same as for a single loop equivalent to the inner-loop alone

TABLE 7. TEST CONFIGURATIONS AND RANGE OF VARIABLES^a

CONDITION No.	PATH MODE DENOMINATOR		ALTITUDE RATE NUMERATOR		SPEED NUMERATOR ^b		THROTTLE SENSITIVITY $Z_{\delta_T}/X_{\delta_T}$ g/in	THRUST ANGLE Arc Tan $-Z_{\delta T}/X_{\delta T}$	X_w
	$1/T_{\theta 1}$ (C_{θ})	$1/T_{\theta 2}$ (ω_{θ})	Attitude $1/T_{h1}$	Throttle $1/T_{h0}$	Attitude $1/T_{u1}$	Throttle $1/T_{u0}$			
1	0.1	0.5	-0.09	0	0.5	0.5	-0.146/-0.0363	104	0
2				0.1		NA	-0.13/0	90	
3				0.5		0.5	00.106/0.106	45	
4				0.79			-0.075/0.13	30	
5				NA			0/0.15	0	
6				0.59			0.075/0.13	-30	
7	0.3	0.3	-0.03	0	-0.73	0.9	-0.146/-0.0363	104	0.1
8				0.1		NA	0.15/0	90	
9				0.3		0.3	0.134/0.067	63.5	
10				0.79		0.44	0.075/0.130	30	
11				NA		0.50	0/0.150	0	
12				-0.59		0.56	0.075/0.13	-30	
13	(0.6)	(0.5)	0.21	0	-0.86	2.5	-0.146/-0.0363	104	0.5
14				0.1		NA	-0.13/0	90	
15				0.5		0	-0.106/0.106	45	
16				0.79		0.79	-0.075/0.13	30	
17				NA		0.5	0.0.150	0	
18				-0.59		0	0.075/0.13	-30	

^aDynamic characteristics valid for perturbation about 60 knot trim condition.

^bNA in the limit when either X_{δ} or Z_{δ} are zero and the time constant is undefined, i.e., for $\delta_T = 90^\circ$, $N_{\delta T} = X_{\delta T} [s + (1/T_{u0})] = X_w^2 \delta T$; for 0° , $N_{\delta T} = -Z_{\delta T} [s + (1/T_{h0})] = -Z_u X_{\delta T}$.

TABLE 8. DESIRABLE CLOSED LOOP FEATURES

- Series Loop Structure for Single Control
- Crossfeeds to Directly Negate Subsidiary Responses
- Closed-Loop Low Frequency Performance Optimum ~ Minimum RMS Error
- Pilot Adaptation to Make $Y_p Y_c$ ---> K/s in the Crossover Frequency Region
- Pilot Lead, $T_L < 1$ to Avoid Degraded Opinion, Workload Capacity
- Frequency Separation of Inner, Outer Loops, e.g., $\omega_{c1} = 2.3 \omega_{c0} - 0.5-1.0$
- Adequate Closed-Loop Damping, $\zeta_{CL} > 0.35-0.50$
- Avoid Closed-Loop Mid-Frequency Droop for Good Opinion
- Favorable Sensitivity to Increasing K_p, T_L

TABLE 9. GOOD PATH REGULATION PROPERTIES

- Inner Loop (e.g., Attitude) Control Integrity and Equalization Potential
- Adequacy and Ordering of Path Control Loop Bandwidths
- Uncoupled or Complementary Control Responses
- Minimum Depletion of Safety Margins
- Control Economy
- Control Harmony

TABLE 10. PILOT CENTERED PATH REGULATION PROBLEMS

ATTITUDE CONTROL

- Inadequate Bandwidth
- Inner-Outer Loop Equalization Conflict
- Low Static Gain
- Over-Sensitivity to Gain/Equalization

PATH CONTROL

- Performance Reversals
- Inadequate Bandwidth
- Inadequate Response Separation
- Difficult or Conflicting Crossfeeds
- Excessive Depletion of Safety margins
- Low (High) Effective Path Gains

LOW-SPEED LONGITUDINAL FLYING QUALITIES OF MODERN
TRANSPORT AIRCRAFT

by

H.A. Mooij

National Aerospace Laboratory NLR
Anthony Fokkerweg 2, 1059 CM AMSTERDAM
The Netherlands

SUMMARY

The suitability of an aircraft with respect to human control is determined by its so-called handling qualities. In modern transport aircraft the handling qualities are determined to a high degree by the flight control system.

An introduction to the following aspects of closed-loop flight control systems for modern transport aircraft is given: stabilisation and manoeuvring functions, candidate implementation forms, (mini-size) manipulators for flight control, and mathematical representations of the airframe/flight control system combination required for prediction and evaluation purposes.

Regarding criteria for good handling qualities of transport aircraft the "terminal flight phases" (take-off, initial climb, final approach and landing) are of prime interest. A treatise on a number of promising quantitative criteria for transport aircraft equipped with advanced flight control systems is given.

Two groups of criteria are distinguished: criteria based on the dynamic characteristics of the aircraft alone (six criteria) and criteria based on the dynamic characteristics of the pilot/aircraft closed-loop system (two criteria). In the latter case a quasi-linear describing function for the human controller behaviour is used.

1. INTRODUCTION

The suitability of an aircraft with respect to human pilot control is determined by its so-called *handling qualities*. The handling qualities of an aircraft are those qualities or characteristics that govern the ease and precision with which a pilot is able to perform his control task.

The handling qualities of the next generations of (large) transport aircraft will be different from those of contemporary aircraft as a result of the flight control systems applied. The developments in digital flight control technology lead to implementation forms which incorporate *full-time stabilisation* (closed-loop flight control system).

One implication is that the pilot will control most of the time through intermittent "trim-type" inputs and that the relationship between these inputs and certain aircraft response parameters will be clearly observable. During landing (flare and touchdown), however, the control task incorporates a strong element of compensatory error-reduction operation. [The present criteria for adequate handling qualities assume that the pilot is actively engaged in the stabilising function]. Therefore a timely question is whether the existing requirements for adequate handling qualities should be maintained unaltered for the new situation. If they are found to be not applicable, then a new question arises: which new criteria would be needed to assure adequate and safe handling qualities of aircraft possessing closed-loop flight control systems?

Between 1972 and 1981 a series of experiments was performed at the National Aerospace Laboratory NLR as part of a study of longitudinal handling characteristics of future transport aircraft with closed-loop flight control systems. In anticipation of expected developments, the study was aimed specifically at the establishment of *quantitative handling qualities criteria* to be used by anyone interested in the design of flight control systems for future transport aircraft. Special emphasis was given to the *landing* (flare and touchdown) flight phase.

A thorough review of the extensive and valuable data for longitudinal handling qualities gathered was performed between 1981 and 1984. The result has been published in 1985 as: "CRITERIA FOR LOW-SPEED LONGITUDINAL HANDLING QUALITIES OF TRANSPORT AIRCRAFT WITH CLOSED-LOOP FLIGHT CONTROL SYSTEMS" (Martinus Nyhoff Publishers, Dordrecht; ISBN 90-247-3098-8), reference 1 in this text.

Because the level of detail of the material presented in this lecture had to be limited, the interested reader is referred to the above-mentioned book. At places where the corresponding text in this book is considered enlightening the related page-numbers are indicated.

2. CLOSED-LOOP FLIGHT CONTROL SYSTEMS

2.1 General

The first demonstration of manually controlled powered flight by the Wright Brothers in 1903, and their successes thereafter, were primarily successful due to their philosophy of developing neutrally stable or even slightly unstable machines of which the flight condition had to be stabilized by continuous application of powerful controls by the pilot (Ref. 2).

The more or less unstable behaviour of the flying machines of the Wright Brothers was a peculiar characteristic, which had to be improved. Two axis pitch and roll stabilizers were developed from 1914 onwards (Ref. 3). In reference 4 a comprehensive overview of the development of automatic flight controls is given.

It is noteworthy that nearly all these systems (pitch- and roll-angle stabilizers and autopilots) were designed without almost any theoretical research. This situation changed when a new generation of jet-propelled aircraft was developed around 1950.

In the new aircraft generation, stability augmentation was required because of the weakly damped or slightly unstable "short-period" motions. The longitudinal short-period oscillation and the Dutch-roll oscillation were the most important "modes" causing difficulties.



Fig. 2.1 Mechanical primary flight control system.

Power-boosted (hydraulic) control systems came into use in order to handle the large hinge moments of the control surfaces. In the earlier aircraft there was a direct mechanical link between the pilot's manipulator and the aerodynamic control surfaces, figure 2.1. This was no longer the case when fully powered hydraulic actuation of the control surface was introduced. As a consequence, the control forces the pilot had to exert had no longer a direct relation with the aerodynamic forces acting on the control surfaces. This led to the development and introduction of "artificial feel units", which provided the pilot with the proper force and position cues to assist him in performing the required control function. The primary flight control system had taken the form illustrated in figure 2.2.

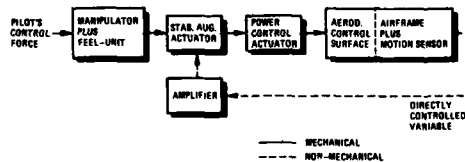

Fig. 2.2 Fully powered primary flight control system including stability augmentation.

The key feature of stability augmentation is the possibility of modifying the characteristics of the physical system. By imposing aerodynamic forces or moments through the actuation of the controls in response to motion variables, the various modes of motion can be changed as desired. To this end, either an actuator has to be installed in series with the mechanical signal transmission system for the pilot inputs, or an actuator has to be installed serving a separate control surface. In figure 2.2, the first solution is illustrated. As can be derived from the figure, the aerodynamic surface is deflected according to the combination of the pilot's manipulator deflection signal and the signal generated in the motion sensor.

As the result of the search for the best obtainable aerodynamic efficiency of the aircraft over a "wide" flight envelope, the concept of *full-time stabilization* has been developed. The dynamics of the unaugmented aircraft are then mostly such that stabilization by the pilot is not always possible (due to the level of instability of certain "modes"). A practical consequence of the application of this concept is, that the safety of flight is now directly related to the reliability of the system performing the stabilizing function.

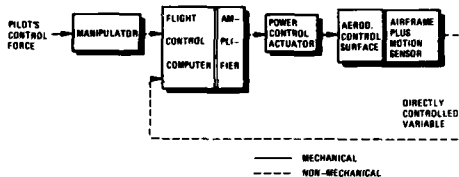

Fig. 2.3 Closed-loop (FBW) primary flight control system.

A flight control system which fulfils the full-time stabilization function and thus incorporates essential feedback loops (see figure 2.3) is called as a *closed-loop flight control system*. The flight control system is implemented such that non-mechanical elements (e.g. flight control computer) are incorporated in the link between the pilot's manipulator and the aerodynamic control surfaces. Stabilization of the aircraft rotational motions is automatically taken care of by such a flight control system.

2.2 Functions

In view of the efforts to maximize the overall aircraft efficiency (in particular in terms of reduced weight and drag) closed-loop flight control systems with non-mechanical signal transmission are applied in modern transport aircraft. This means that the need for stabilization, as one of the control functions performed by the pilot, will be greatly diminished.

In a feedback control system around a multivariable element, such as an aircraft, several (state) variables can be selected as the controlled variables. For an aircraft in "longitudinal" motion the following three motion variables, or rather their deviations from reference values, should be considered:

- pitch angle (θ),
- angle-of-attack (α)
- airspeed (u).

With respect to the control elements, the following three are available in principle:

- pitching-moment control element, effected by moment-producing aerodynamic surfaces,
- normal-force control elements, effected by lift-producing aerodynamic surfaces,
- longitudinal-force control element, effected by thrust-producing power plants (engines).

In a closed-loop flight control system, the selection of a controlled aircraft variable and a control element must be based on the following two functions of the flight control system:

- A) stabilizing the aircraft (automatically)
- B) providing the means for manoeuvring by the pilot.

First, the desirable system characteristics from the point of view of *stabilization* are discussed.

Closed-loop systems based on pitch angle (θ) or angle-of-attack (α) and elevator (δ_e), "stabilize" the aircraft *angular motions*. The orientation of the reference for stabilization, however, is fundamentally different for these two controlled variables:

- the vertical, for the system based on pitch angle (θ),
- the airflow direction relative to the aircraft, for the system based on angle-of-attack (α).

For *stabilization of the angular motion*, a system based on pitch angle and elevator (θ, δ_e) can provide both the stability for an unstable aircraft and the reduction of pitch-angle response to gust inputs. In addition, such a system is desirable from the point of view of the pilot, since his primary input signal (pitch angle) is stabilized during unattended operation. He is therefore relieved from one of his primary control tasks, viz. stabilizing the aircraft. An additional closed-loop system based on speed as the controlled aircraft variable and the engine thrust as the longitudinal-force control element (u, δ_T) can

stabilize airspeed during the approach flight phase.

Next, the desirable system characteristics from the point of view of *manoeuvring* during terminal flight phases are discussed.

Longitudinal manoeuvring implies changing the aircraft *pitch angle* and as a consequence changing the *flight-path angle* (γ , direction of the velocity vector) in the plane of symmetry of the aircraft and/or changing the *airspeed* (V , magnitude of the velocity vector).

The controlled (such as θ) or indirectly controlled (such as γ or V) motion variables being of immediate concern for manoeuvring are, depending on the flight phase:

- *pitch angle* for take-off followed by *airspeed* (at "maximum" thrust) for initial climb,
- *flight-path angle* and *airspeed* simultaneously during final approach followed by *flight-path angle* and *pitch angle* for landing.

With regard to *manoeuvring*, a system based on pitch angle and elevator (θ, δ_e) is appropriate for effecting changes in pitch angle (take-off and landing), airspeed (initial climb), and flight-path angle (approach).

When combining the above two control functions of stabilizing and manoeuvring, it is stated that the so-called *pitch-rate-command/pitch-angle-hold* flight control system forms the most promising form of system implementation.

A comprehensive treatise on the fundamental and the implementation dependent side-effects on flying qualities of the different options for a closed-loop flight control system is presented in reference 5. In the reference it is concluded that the *pitch-rate-command/pitch-angle-hold* category will probably prevail in future mechanizations.

For aircraft with shortcomings with respect to flight-path control, "manoeuvre enhancement" systems (systems which affect the lift force directly by applying "direct-lift" aerodynamic surfaces on the wing) must be taken into consideration as well (see Section 5.2). Such a system must, however, must be "selectable", i.e. it must be switched on only during particular flight phases (e.g. final approach and landing).

Systems indicated as "flight-path angle-rate-command/flight-path angle-hold" are under consideration at the moment. There are indications at present that these systems will not be used below a certain altitude (e.g. 100 ft) above the runway.

2.3 Manipulators

The output of the pilot, namely the "commands" given to the closed-loop flight control system, are transmitted to the aircraft through a manipulator. As such the manipulator is an element of the pilot/aircraft combination and its

characteristics play therefore a role in the pilot's opinion on the handling qualities of the aircraft.

Three types of manipulators can be distinguished:

- column-wheel combination (which is the standard mechanization in contemporary transport aircraft),
- centre-stick,
- (mini-size) side-stick.

The most appropriate choice between these types lies basically in the realm of human factors and depends heavily on the desired organization of displays and controls in the cockpit.

A few introductory remarks with respect to the side-stick are in order here, because of some unmistakable indications that in future aircraft with closed-loop flight control systems such a manipulator may become the favourite choice (see e.g. Ref. 6).

Side-sticks enhance the benefits of systems with non-mechanical signal transmission because of their reduced mass relative to the classical manipulator, smaller size, and favourable location. The last two characteristics are important with respect to optimal flight deck lay-out (visibility of primary flight instruments).

Basically two mechanization forms of manipulators with electric output can be considered for flight control purposes:

- the pressure manipulator (with hardly any displacement),
- the compliant manipulator.

In all available sources on flight tests with pressure and compliant side-sticks, it is concluded that the compliant type is to be preferred over the pressure type (Refs. 7 and 8). More details and valuable suggestions concerning the design of compliant side-stick manipulators have been described by Miller and Emfinger (Ref. 8). When the characteristics of such

a manipulator are considered, two elements deserve serious consideration, figura 2.4:

- the mechanical element, which transforms the pilot's input to the manipulator into an electric signal,
- the electric element, in which this signal is transformed into a "command" signal; the input/output relation is called the "command shaping".

It is assumed that, in order to strike a (correct) balance between the force levels required for small values of commanded motions and those for larger values, a non-linear relation between pilot's force input and the "commanded" signal is favourable (multi-gradient command shaping).

3. HANDLING QUALITIES CRITERIA

3.1 General

In this lecture the criteria for handling qualities of transport aircraft with closed-loop flight control systems as mentioned in Chapter 2 are restricted to longitudinal manoeuvring during low-speed flight, including *flare* and *touchdown*.

The areas of application of the criteria are *prediction* of handling qualities during the design and development phase of aircraft, and *evaluation* of handling qualities as part of the "certification" in the case of civil aircraft, or "proving compliance with a procurement specification" in the case of military aircraft.

During the design and development phase, the handling qualities of an aircraft are *predicted* on the basis of numerical measures calculated from an estimated mathematical model describing the dynamic characteristics of the combination of the airframe, the flight control system, and the propulsion system. Preferably, the criteria used for prediction should permit the designer to explore the effects of proposed changes in flight control system lay-out, including various combinations of feedback and feed-forward paths, compensation networks and filters, in his attempts to achieve the desired handling qualities.

The *evaluation* of the handling qualities of aircraft in existence can be broken down in analytic evaluation, evaluation through simulation, and evaluation through flight tests.

Because of the more stringent requirements for handling qualities of military aircraft as compared to civil aircraft, it is observed that in the (US) Military Specification compliance with all requirements of the specification has to be demonstrated through analysis. [This type of (analytic) evaluation does not differ from the type of activity performed during the design and development phase of

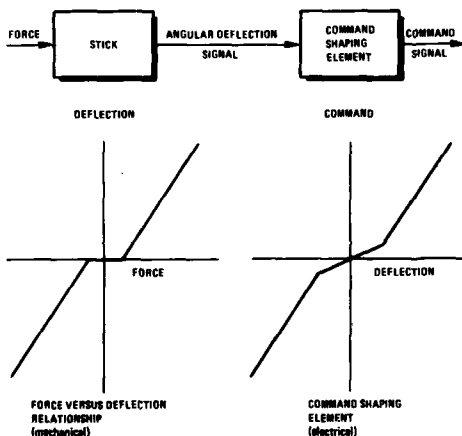

Fig. 2.4 Two elements between pilot's control force and command signal.

the aircraft as described above). In addition, compliance with many of the requirements of the (US) Military Specification has to be demonstrated by simulation, flight test or both. The selection of these requirements is made jointly by the procuring agency, the test agency, and the manufacturer. It is of interest to observe that "where simulation is the ultimate method of demonstrating compliance with a requirement, the simulation model shall be validated with flight test data and approved by the procuring agency".

The criteria used for assessing the handling qualities of an existing aircraft should preferably be expressed in measures (e.g. time histories of motion variables to a step-type manipulator input) that can be determined directly from flight test results (*objective data*) or determined indirectly using a mathematical model established on the basis of flight test results (*analytical data*). In both cases it is important that the in-flight test technique is not unduly complex.

In principle, the limit values or boundaries in the requirements of the (US) Military Specification are associated with one of three "Levels" of acceptability. There is a direct relationship between the three Levels and pilot ratings given according to the *Handling Qualities Rating Scale* (sometimes referred to as the Cooper-Harper (CH) Scale) presented in figure 3.1 (Ref. 9), as indicated in the Background Information and User Guide of MIL-F-8785 B (Ref. 10). The overall relationships are:

Level 1, pilot ratings 1, 2 and 3(CH);
descriptor used here: *clearly-adequate*;

Level 2, pilot ratings 4, 5 and 6(CH);
descriptor used here: *adequate*;
Level 3, pilot ratings 7, 8 and 9(CH);
descriptor used here: *inadequate*.

Only the criteria for *clearly-adequate* handling qualities are treated in Chapters 4 and 5, because the attention will be focussed on establishing the *clearly-adequate/adequate* boundary (Level 1/-Level 2).

The handling quality criteria are divided into two groups:

- criteria based on the dynamic characteristics of the aircraft only, and
- criteria based on the dynamic characteristics of the pilot/aircraft closedloop system.

The criteria, based on the *dynamic characteristics of the aircraft only*, are related to:

- the parameters of the transfer functions,
- the frequency responses,
- the time histories for a step-type or block-type manipulator input.

The criteria, based on the *dynamic characteristics of the pilot/aircraft closed-loop system*, are based on calculations concerning the pilot/aircraft closed-loop control structure. They are related to frequency domain measures such as:

- pilot compensation, e.g. magnitude of certain parameters in a model for the control behaviour of the pilot,
- closed-loop resonance.

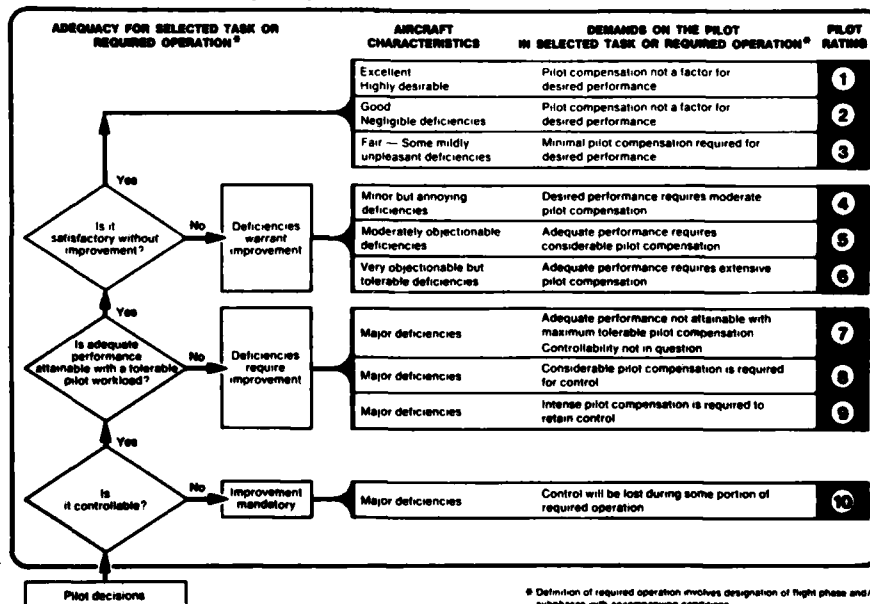

Fig. 3.1 The handling qualities rating scale.

In both above-mentioned groups of criteria, the transfer functions of aircraft motion variables to manipulator input have to be available. These transfer functions can be calculated by combining the appropriate control-input transfer functions of the aircraft, with all elements forming the flight control system. Where simulators are used in the generation of subjective data, their dynamics have to be included in the transfer functions as well. For the second group a model for the control behaviour of the pilot is required; in Section 3.3 such a model will be introduced.

The aircraft types envisaged in the discussion of criteria (Chapters 4 and 5) are "large; heavy; low-to-medium manoeuvrability" (MIL-F-8785 C: Class III aircraft). The flight phases considered are categorized as "terminal flight phases using gradual manoeuvres and requiring accurate flight-path control"; take-off, initial climb, final approach and landing are comprised (MIL-F-8785 C: Category C flight phases).

3.2 Mathematical representation of the aircraft

For the application of a number of the criteria discussed in Sections 4.2 and 5.2, the complete form for the mathematical representation (model) of the dynamic characteristics of the (simulated) aircraft can be used. However, for the application of several of the criteria certain specific features of the mathematical representation are required. These features are:

- a. a well-defined *quasi-steady-state* value of the time response of certain aircraft variables after a step-type manipulator input;
- b. an approximation of the aircraft dynamic characteristics by a transfer function containing a *limited number of parameters*.

Sub a) A *quasi-steady-state* value of the time response

The "constant-speed equations of motion" are used here, instead of the "complete equations of motion", for the determination of the manipulator-input transfer functions. The "constant-speed equations of motion" is a subset of the perturbation equations of motion obtained by deleting the force equation along the body-fixed X-axis and putting the speed-perturbation equal to zero. In the following, a transfer function concerning the combination of airframe and flight control system based on the "constant-speed equations of motion", will be called the *constant-speed transfer function*, while the transfer function based on the "complete equations of motion" will be called the *complete transfer function*.

Sub b) A transfer function containing a *limited number of parameters*

One way to describe aircraft with elaborate flight control system structures using only the constant-speed equations of motion for the basic airframe is by means of a low-order equivalent transfer function.

A low-order equivalent transfer function can be determined by means of a fitting procedure of the frequency response over a certain frequency range. Often the amplitude and phase differences are computed at 20 discrete frequencies between 0.1 and 10 rad/s, evenly spaced on a logarithmic scale.

One (by feedback-loop) controlled variable of importance for further consideration is pitch-rate response. The expression for the low-order equivalent transfer function for pitch-rate response (q) to manipulator input (s_e) is:

$$\frac{q(s)}{s_e(s)} = \frac{K e^{-T_q s} (s + 1/\tau_q)}{(s^2 + 2\zeta_q \omega_q s + \omega_q^2)} \quad (3.1)$$

The terms τ_q , ω_q , and ζ_q are the parameters which can be related to τ_{θ_2} ,

ω_{sp} and ζ_{sp} in the transfer function based on the "constant-speed equations of motion" of the unaugmented aircraft. The term T_q is the total effective time delay resulting from the addition of the delays due to: high frequency flight control system modes (actuators, compensation, etc.), digital sampling, computation times, etc.

3.3 Mathematical representation of the pilot/aircraft system

One type of model which is applicable to the stability and performance aspects of the pilot/aircraft system is presented here. It is the manual single-loop control situation classified as the compensatory control structure. The relevant structure for visual inputs to the human controller is presented in figure 3.2. Concerning the *flare manoeuvre* (an important aspect in the present discussion) it is assumed that compensatory operation and so-called

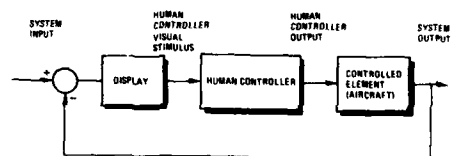

Fig. 3.2 Compensatory control structure for visual inputs.

precognitive operation occur in a "dual-mode" control situation. The flare may very well be initiated and largely accomplished by the precognitive action and then completed with compensatory error-reduction operations (Ref. 11).

A model for the control behaviour of the pilot, applicable to the stability and performance aspects of the pilot/aircraft closed-loop system is:

$$H_p(j\omega) = \frac{K_p e^{-j\omega T} (j\omega + 1/\tau_L)}{(j\omega + 1/\tau_T)} \quad (3.2)$$

This model forms one of the two factors in the "Crossover Model", introduced by McRuer and co-workers (Ref. 12):

$$H_p(j\omega)H_c(j\omega) \approx \frac{1}{j\omega} \omega_o e^{-j\omega T} \quad (3.3)$$

The parameters of $H_p(j\omega)$ can be determined by a fitting procedure using the measured describing function of the human controller. The other factor, $H_c(j\omega)$, indicates the frequency response of the controlled element (aircraft). A model for the more complex control situation in which the pilot controls two system outputs simultaneously will be introduced in Section 5.2.

4. CRITERIA EXPRESSED IN THE DYNAMIC CHARACTERISTICS OF THE AIRCRAFT

4.1 General

The handling qualities of an aircraft can be judged by test pilots who have the proper background. Their opinions are reasonable reproducible and therefore of great value in experimental research. A valuable description of the historical development of the test pilot profession has been given in reference 13.

A milestone in the development of handling quality criteria was reached when NACA Report 927 (Ref. 14) was issued in 1949. This document of singular value presents a complete set of requirements together with a discussion on the reasons for each individual requirement. The requirements are based on results of flight tests with about sixty different aircraft.

The extension of this handling qualities data base started in the mid-1950's with results of tests using *variable-stability aircraft* (essentially the first aircraft with closed-loop flight control systems) followed later by *in-flight simulators*. For an overview of the historical development of handling

quality criteria one is referred to reference 1 (Ref. 1; p.47-48)

The military requirements are as far as possible quantitative; the purpose of military requirements is to ensure a certain level of *mission performance* as well as safety of operation.

The well-known series of (US) Military Specifications started 40 years ago while its latest issue dates from 1980 (Ref. 15 through 20).

The civil requirements are essentially qualitative; the purpose of civil requirements is to ensure *safety of operation* rather than the effectiveness of the mission.

In the United States, the Federal Aviation issues regularly updated versions of the Federal Aviation Regulations (FAR) (e.g. Ref. 21) while in Europe the so-called Joint Airworthiness Requirements (JAR) (e.g. Ref. 22) have been issued.

The following section is written in the light of relevant experiments using a ground-based and an in-flight simulator (Ref. 1).

4.2 Criteria

1 LOW-ORDER EQUIVALENT TRANSFER FUNCTION CRITERION

The (US) Military Specification, Flying Qualities of Piloted Airplanes (Ref. 20), provides a short-period response criterion. Its application is aimed at aircraft with open-loop flight control systems and is expressed in terms of the undamped natural frequency and the damping ratio in the constant-speed transfer function (ω_{sp} , ζ_{sp}) and the normal acceleration sensitivity (n_a).

It seems attractive to apply the criterion also to aircraft with closed-loop flight control systems and thus to parameters of the low-order equivalent transfer function (equation 3.1).

Criterion

The parameters for the low-order equivalent transfer function for pitch-rate response to manipulator input, equation (3.1), shall not exceed the following limits:

- a) The values for ω_q (ω_{sp}) and n_{ae} (n_a)

shall lie within the boundaries depicted in figure 4.1.

- b) With respect to the equivalent (short-period) damping ratio:

$$0.35 < \zeta_q (\zeta_{sp}) < 1.30$$

- c) With respect to the equivalent time delay:

$$T_q < 0.1 \text{ s}$$

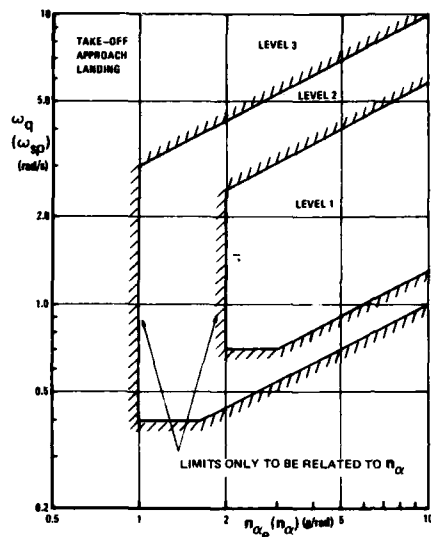

Fig. 4.1 Equivalent (short-period) undamped natural frequency versus normal acceleration sensitivity.

Remarks

Sub a) The original boundaries of ω_{sp} as a function of n_α (the set of four ω_{sp} parallel lines) are based on the Control Anticipation Parameter (CAP) established by Bihrie (Ref. 23). He demonstrated a strong correlation between pilot ratings and the value of the ratio of the initial pitch acceleration and the steady-state load factor after a step-type manipulator input. By assuming constant-speed equations of motion the expression for the CAP (for an unaugmented aircraft) can be written as:

$$CAP \approx \frac{\omega_{sp}^2}{n_\alpha} \quad (4.1)$$

The two parallel lines of the Level 1/-Level 2 distinction correspond to $0.16 \text{ rad.s}^{-2}/g$ (lower boundary) and $3.6 \text{ rad.s}^{-2}/g$ (upper boundary).

In figure 4.1 also two absolute boundaries are present. The original lower (absolute) limit on ω_{sp} is based on the assumption that a lowest value of ω_{sp} exists below which satisfactory manoeuvring is not possible. The original lower (absolute) limit on n_α is based on the assumption that the lag between pitch angle and flight path angle change should be restricted in the final approach and landing of an aircraft. The following expression exists for this relationship:

$$\frac{\gamma(s)}{\theta(s)} = \frac{\frac{g}{V} n_\alpha}{s + \frac{g}{V} n_\alpha} \quad (4.2)$$

Sub b) The limit values of ζ_{sp} are based on the consideration that, when the damping ratio is too low, the aircraft short-period response overshoots and oscillates, while, when the damping ratio is too high, the response may become "sluggish". The latter holds in particular for high damping combined with a relatively low value of ω_{sp} .

Sub c) Experience has shown that the time delay, T_q in the low-order equivalent transfer function for pitch-rate response to manipulator input, is potentially significant for "augmented" aircraft. The equivalent time delay comprises the delays contributed by the flight control system.

Discussion

It is observed that Part a) of the criterion is prone to difficulties in interpretation. If the criterion is interpreted in accordance with the background of MIL-F-8785 C (pitch angle control characteristics only; CAP-based philosophy) an "equivalent n_α " has to be used instead of n_α . This parameter, indicated as n_{α_e} , is related to τ_q by:

$$n_{\alpha_e} = V/(g\tau_q) \quad \text{(Ref. 1;p. 13).}$$

The reason for this is that the criterion does not make a distinction between configurations with different values of the CAP if n_α is used.

From experimental evidence {Ref. 1; p. 104-107} it appears that the lower oblique boundary of the criterion (Fig. 4.1) is slightly too lenient with respect to sluggish behaviour.

Concerning Part c) of the criterion it can be observed that the limit value on T_q is too limiting {Ref. 1;p. 104-107}.

Especially in the area of relatively low equivalent undamped natural frequencies (vicinity of the lower oblique boundary), the effects of all four parameters τ_q , ω_q , ζ_q and T_q should be considered simultaneously. This aspect will be discussed further when the NLR RISE-TIME AND SETTLING-TIME CRITERION is introduced.

2 NLR-MODIFIED COMPATIBILITY OF MANIPULATOR FORCES CRITERION.

Introduction

An aircraft has several degrees of freedom and thus a number of variables exists which respond to manipulator inputs (e.g. pitch angle, normal acceleration).

The "gain" for one aircraft response variable to a manipulator input should, from a piloting standpoint, not be "incompatible" with the "gain" for another variable to that input. The frequency region for which "gains" (amplitude ratios) are of importance moreover differ for the various response variables.

Criterion

The product of the manipulator force per unit load factor, dF_e/dn , and the maximum of the amplitude ratio of pitch acceleration to manipulator control force, $|\ddot{\theta}/F_e|_{\max}$, shall not exceed the following limit:

$$\frac{dF_e}{dn} \cdot \left| \frac{\ddot{\theta}}{F_e} \right|_{\max} < 0.45 \text{ rad.s}^{-2}/g$$

Remarks

In the above criterion two parameters related to the manipulator input are combined:

- the manipulator force per unit load factor, dF_e/dn , with reference to the quasi-steady-state condition (constant-speed approximation);
- the maximum pitch acceleration amplitude ratio $|\ddot{\theta}/F_e|_{\max}$, occurring at the equivalent undamped natural frequency or, if there are lightly-damped control system modes, at the frequency which has the largest amplitude ratio.

These two parameters can become incompatible in the sense that the maximum pitch acceleration amplitude ratio $|\ddot{\theta}/F_e|_{\max}$ is too high relative to the manipulator force per unit load factor (dF_e/dn).

The above-mentioned requirement has been primarily developed to limit various handling qualities problems, such as those caused by very high equivalent undamped natural frequencies, high equivalent undamped natural frequency combined with low damping ratio, large lead in the flight control system, and poorly designed bobweight systems (mechanical primary flight control systems).

Discussion

The criterion is based on work by Calspan (Ref. 24). In this reference a limit value of $2.5 \text{ rad.s}^{-2}/g$ is proposed; no background information for this value is given. Based on experimental evidence (Ref. 1; p. 108) the limit value in the above mentioned criterion is proposed.

It should be realized that this criterion is not related to a particular type of pilot's manipulator for pitch-angle control.

3 LARGE SUPERSONIC AIRCRAFT CRITERION

Introduction

For flight at low airspeeds with large supersonic aircraft, Boeing presented in 1975 (Ref. 25) a criterion for longitudinal manoeuvring. A combination of limitations in the time domain and in the transfer-function parameter domain has been proposed.

Criterion

- a) The pitch-rate time history (quasi-steady-state) in response to a step-type manipulator input, in normalized form, shall lie within the boundaries depicted in figure 4.2.
- b) With respect to the time required to reach maximum pitch rate, $T_{q-\max}$, the following shall be observed:

$$1.1 \text{ s} < T_{q-\max} < 1.8 \text{ s}$$

- c) With respect to the total damping of the denominator of the low-order equivalent transfer function for pitch rate to manipulator input (equation (3.1)), the following shall be observed:

$$0.5 \text{ rad/s} < \tau_{q\omega_q} (\xi_{sp} \omega_{sp}) < 1.05 \text{ rad/s}$$

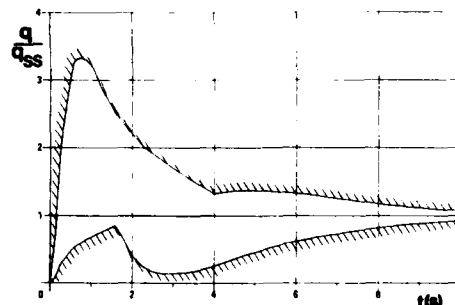

Fig. 4.2 Part a) of Large Supersonic Aircraft Criterion; pitch-rate time-history envelope.

Remarks

It is remarked that the constant-speed equations of motion (constant-speed transfer function) should be used in the generation of the time response.

The criterion is included here because it is one of the few time-response envelope criteria proposed for advanced aircraft development programs (in this case the (US) National SuperSonic Transport Program).

Discussion

Two distinct observations can be made on the basis of experimental evidence (Ref. 1; p. 109, 110). Concerning Part a) of the criterion, it is noted that the

lower boundary (Fig. 4.2) up to 1.5 seconds is too stringent. This is among others attributed to the fact that in this time-history envelope criterion no allowance is made for a time delay. Concerning Part b) of the criterion, it is noted that the limit on \dot{q}_{max} is too stringent on the maximum-side.

4 SPACE SHUTTLE ORBITER CRITERION

Introduction

As one of the attempts to specify the flying qualities for an aircraft with a closed-loop flight control system, the work performed for the Space Shuttle Orbiter of the US Space Transportation System (STS) should certainly be mentioned. The original specification for flying qualities was especially related to pitch-angle control (Ref. 26). The flight control system had to provide a pitch-rate output proportional to the pilot's input, while the transient pitch-rate response to a step-type manipulator deflection was bounded by a time-history envelope. The (final) specification presented here is based on work by Rockwell (Ref. 27).

Criterion

The value of the pitch-rate time history in response to a step-type manipulator input in normalized form shall lie within the boundaries depicted in figure 4.3.

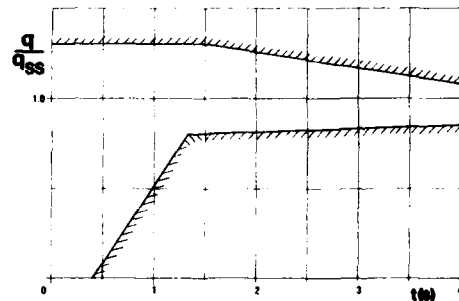

Fig. 4.3 Space Shuttle Orbiter Criterion; pitch-rate time-history envelope.

Remarks

The constant-speed equations of motion (constant-speed transfer function) should be used in the generation of the time response.

Discussion

Based on experimental evidence (Ref. 1; p. 110,111) the following two observations are made:

- The upper boundary (Fig. 4.3) is somewhat too limiting,
- The position of the lower boundary would permit somewhat more sluggish response of pitch rate that what is thought to be required to obtain clearly-adequate handling qualities.

5 NLR-MODIFIED GIBSON CRITERION

Introduction

Successful precognitive, i.e. open-loop, operation depends to a great extent on the predictability of the final value of the response after a (corrective) input.

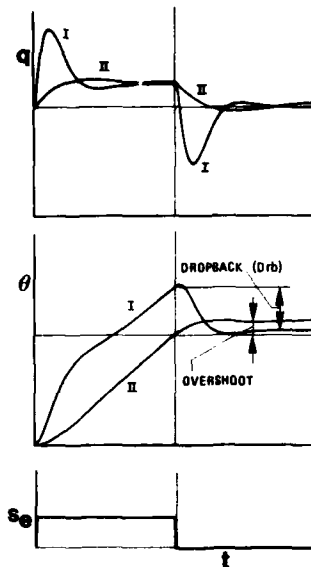

Fig. 4.4 Pitch-rate and pitch-angle responses to a block-type manipulator command signal.

Figure 4.4 shows the pitch-angle response to a block-type manipulator input in generalized form. "Dropback" (Curve I) or "overshoot" (Curve II) of pitch angle occurring after the input is removed, are important characteristics in this respect. These characteristics are especially observable by the pilot of aircraft equipped with a flight control system featuring (high-quality) pitch-angle stabilization.

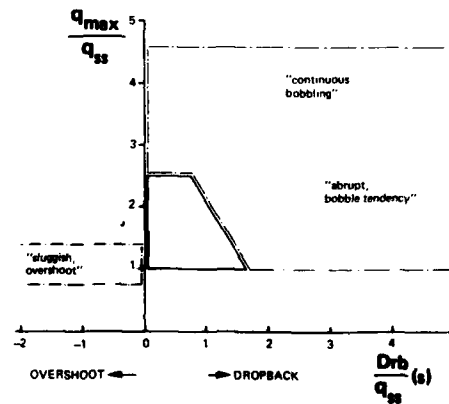

Fig. 4.5 NLR-modified Gibson criterion

Criterion
 Normalized "dropback", Drb/q_{ss} , and pitch-rate overshoot ratio q_{max}/q_{ss} , shall lie within the boundaries indicated in figure 4.5.

Remarks
 The complete equations of motion (complete transfer function) should be used when applying this criterion (Ref. 1; p. 111).

Discussion
 In the development of the NLR-MODIFIED GIBSON CRITERION on "dropback" for large transport aircraft, the structure as formulated by Gibson for the *fighter combat manoeuvring task* (Ref. 28) has been used. In reference 28 it is stated that for this aircraft type in the landing approach values for Drb/q_{ss} up to at least 1.0 s are allowable for satisfactory handling qualities. Experimental evidence (Ref. 1; p. 111, 112) indicates that:
 - aircraft with negative values of Drb/q_{ss} indeed fall in the area of the original criterion indicated as "sluggish", "overshoot",
 - positive values of Drb/q_{ss} in excess of about 1.0 s were associated with pilot expressions as "abrupt", "bobble tendency",
 - the upper horizontal cut-off has been established on the basis of overall-insight (experiments and the SPACE SHUTTLE ORBITER CRITERION).

6 NLR RISE-TIME AND SETTLING-TIME CRITERION

Introduction
 A fundamental drawback of the in various quarters recommended LOW-ORDER EQUIVALENT TRANSFER FUNCTION CRITERION (Criterion 1) is the independent specification of the combination of ω_q and n_a on the one hand and ζ_q on the other hand. Part of the problem is the detrimental effect of combined values of two parameters, both approaching their individual limit values. NLR developed a criterion aimed at expressing the combined effects of ω_q , n_a and ζ_q on the time

response (Ref. 1; p. 112-114). A *rise-time* parameter was defined to this end:
Rise time, T_{rise} : the time required, following the initiation of a step-type manipulator input, for the pitch rate to reach 90 percent of the quasi-steady-state value.

A second parameter, *settling time*, to guard against a too low damping of the "short-term" response has been defined as well:

Settling time, T_{settle} : the time required, following the initiation of a step-type manipulator input, for the pitch rate to enter and remain within a band from 90 percent to 110 percent of the quasi-steady-state value.

Criterion
 Rise time (T_{rise}) and Settling time (T_{settle}) of the pitch rate response following a step-type manipulator input, as defined in figure 4.6, shall not exceed the following limits:

$$T_{rise} < 1.1 \text{ s} \quad \text{and} \quad T_{settle} < 4.4 \text{ s}$$

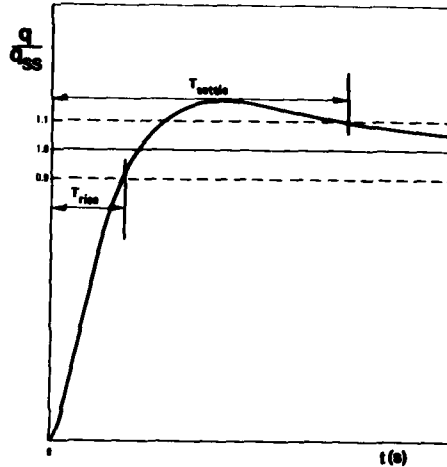

Fig. 4.6 Definition of T_{rise} and T_{settle}

Remarks
 It is concluded that the differences between the criterion under discussion and the SPACE SHUTTLE ORBITER CRITERION (Criterion 4) are reasonably small.

Discussion
 Besides a maximum *rise time*, a maximum for a time delay as part of the *rise time* should be defined as well. It is expected that the limit value of such a time delay could be at least 0.25 s.

5. CRITERIA EXPRESSED IN THE DYNAMIC CHARACTERISTICS OF THE PILOT/AIRCRAFT SYSTEM

5.1 General

In Chapter 4, six criteria have been introduced which are based on the use of the description of the dynamic characteristics of the aircraft only. In the present chapter two additional criteria will be introduced which are

based on the results of calculations concerning the pilot/aircraft closed-loop control structure. They require mathematical models of the aircraft as well as of the pilot.

It is postulated that in the final phase of the landing flare the pilot control behaviour is characterized by (continuous) compensatory error-reduction operation.

5.2 Criteria

7 NLR-MODIFIED NEAL-SMITH CRITERION

Introduction

For the final approach and landing flight phases of the mission of a transport aircraft, acceptable dynamic characteristics of the pilot/aircraft closed-loop system for pitch-angle control are required.

In the development of the NLR-MODIFIED NEAL-SMITH CRITERION for large transport aircraft, the concept of the Neal-Smith criterion for fighter aircraft (Refs. 29-32) has been used [Ref. 1; p. 117-122]. In that criterion the acceptability of the characteristics concerning pitch-angle control is linked to pilot compensation required and closed-loop resonance occurring when some standard of performance is to be obtained.

The standard of performance can be expressed in maximum permissible droop and minimum required bandwidth, $\omega_{BW-\theta}$.

Figure 5.1 shows the structure of the pitch-angle control loop as well as a definition of the performance parameters

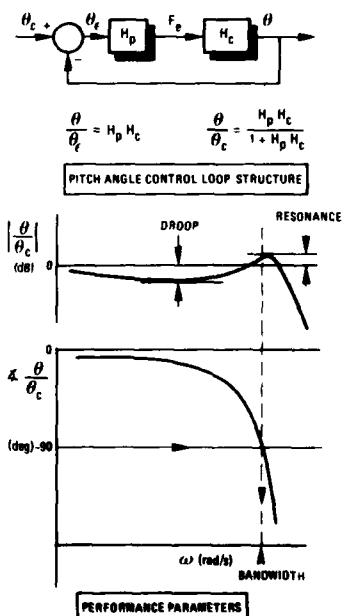

Fig. 5.1 Pitch-angle control loop structure and performance parameters.

droop and (closed-loop) resonance. The pilot model, H_p , in this structure is the model discussed in Section 3.3.

A measure to describe pilot compensation, \angle_{pc} , to be used as a criterion is:

$$\angle_{pc} = \angle \left(\frac{j\omega + 1/\tau_L}{j\omega + 1/\tau_I} \right)_{\omega_{BW-\theta}} \quad (5.1)$$

Criterion

For configurations not leading to closed-loop resonance, the pilot compensation, \angle_{pc} , shall not exceed the following limit:

$$\angle_{pc} < 50 \text{ deg}$$

For configurations not requiring appreciable lead or lag compensation by the pilot, ($|\angle_{pc}| < 25 \text{ deg}$), the closed-loop resonance, $|\theta/\theta_c|_{\max}$, shall not exceed the following limit:

$$|\theta/\theta_c|_{\max} < 0 \text{ dB}$$

The limits mentioned above are depicted in figure 5.2.

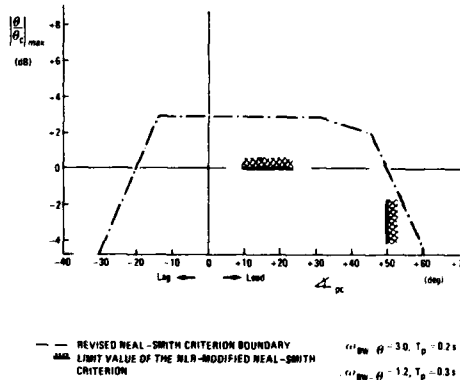

Fig. 5.2 NLR-Modified Neal-Smith Criterion limits in the $|\theta/\theta_c|_{\max} - \angle_{pc}$ domain.

The performance standard is:

- maximum permissible droop: - 3 dB
- minimum required bandwidth, $\omega_{BW-\theta}$: 1.2 rad/s

As an integral part of this criterion, the resonance has to be calculated also for assumed values for minimum required bandwidth, $\omega_{BW-\theta}$, that are lower and higher than the value of 1.2 rad/s assumed here (e.g. 1.1 and 1.4 rad/s). An appreciable variation in resonance is considered

to be an indication that the dynamic characteristics of the pilot/aircraft closed-loop system for the particular configuration are strongly dependent on piloting technique. This may indicate that handling qualities problems may be present and that application of the criterion might very well give unreliable results.

Remarks

For a detailed discussion of the development of the criterion the reader is referred to reference 1 (Ref. 1; p. 117-122). The pilot time delay (0.3 s) in the pilot model, H_p , has been selected on the basis of a ground-based and in-flight validation of a model for the control behaviour of the pilot during the execution of a pitch-angle tracking task with a simulated transport aircraft (Ref. 33).

Discussion

The experimental data base is limited. More experimental data are needed to cover the $|\theta/\theta_c|_{\max} - \Delta_{pc}$ domain over a wider area.

8 NLR PRECISION FLIGHT-PATH CONTROL CRITERION

Introduction

Acceptable characteristics of the pilot/aircraft closed-loop system for pitch-angle control are a necessary but not sufficient condition to perform the *final approach and landing* task in the proper fashion. Besides acceptable characteristics concerning pitch-angle control, acceptable characteristics of the pilot/aircraft closed-loop system for flight-path control should exist as well. Two factors are mentioned which are related to flight-path control.

Aircraft with shortcomings with respect to flight-path control (aircraft with a "too low" n_a ; boundary-value estimated between 4.7 and 3.4 g/rad, Ref. 34) can be improved by means of a *manoeuvre enhancement* system. Such a system may be based on "direct-lift" aerodynamic control surfaces on the wing.

The introduction of *controllable canards* (as part of the pitch-angle control system) is contemplated in some design studies.

In both cases the character of the normal acceleration response to manipulator inputs will be different from the character of the response for aircraft types presently in operation.

A criterion has been developed by NLR in which the acceptability of the characteristics concerning flight-path control is linked to the calculated bandwidth (evaluation measure) of the flight-path control loop, determined on the basis of a series-closure control structure as depicted in figure 5.3. In order to

perform the outer-loop (flight-path control loop) closure, use is made of the pilot compensation for the inner loop as obtained from the procedure which is part of the NLR MODIFIED NEAL-SMITH CRITERION (Criterion 7 in this text).

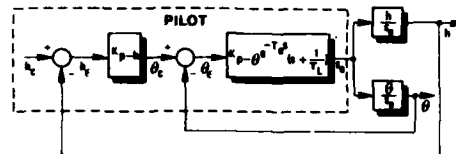

Fig. 5.3 Closed-loop pilot/aircraft system for precision flight-path control.

Criterion

The bandwidth of the pilot/aircraft system for flight-path control, ω_{BW-h} , shall be governed by the following limit:

$$\omega_{BW-h} > 0.5 \text{ rad/s (Fig. 5.4)}$$

The evaluation measure ω_{BW-h} is determined as follows:

- Apply the procedure of the NLR-MODIFIED NEAL-SMITH CRITERION.
- Use the outcome (*pilot gain and pilot compensation*) to formulate the open-loop transfer function of the pilot/aircraft system for flight-path control.
- Determine the pilot gain for the outer-loop closure on the basis of a phase margin of 30 deg, and calculate the closed-loop frequency response.
- Determine the bandwidth of the pilot/aircraft system for flight-path control, ω_{BW-h} , from the closed-loop frequency response.

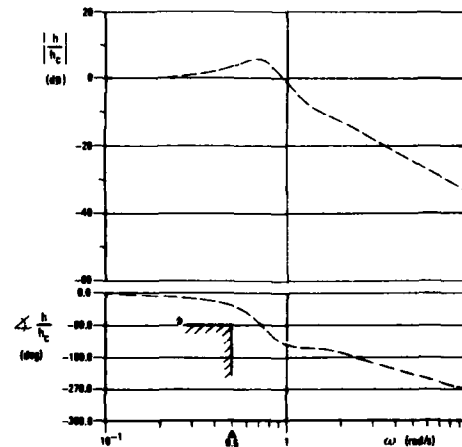

Fig. 5.4 NLR Precision Flight-Path Control Criterion limit in the $\Delta h/h_c - \omega$ domain.

Remarks

No space is available here for a detailed discussion of the development of the criterion (Ref. 1, p. 122-126).

Discussion

The criterion presented above requires a minimum value of ω_{BW-h} . In-flight experiments related to aircraft with *manoeuvre enhancement* or *controlled canards* configurations have indicated that too much initial normal acceleration at the pilot station following step-type manipulator inputs has a degrading effect on pilot opinion (Ref. 35). Two factors are of particular relevance here:

- 1) The level of initial normal acceleration may be so high that the pilot considers the motion disturbing.
- 2) A high bandwidth for the flight-path control loop, ω_{BW-h} , reduces the separation between ω_{BW-h} and $\omega_{BW-\theta}$.

One way of reducing the above observed negative factors is to put an upper limit on ω_{BW-h} as well; or in other words, to minimize the ratio of $\omega_{BW-\theta}/\omega_{BW-h}$. Further research is needed to substantiate this suggestion. High fidelity motion cueing during in-flight and ground-based simulations is a prerequisite for meaningful experimental results in this area (Ref. 1; p. 92)

6. CONCLUDING REMARKS

The main purpose of this paper is to serve as an introduction to the low-speed longitudinal handling qualities of modern transport aircraft equipped with fly-by-wire (closed-loop) flight control systems. There are many criteria that supposedly can predict handling qualities. It is emphasized that one cannot use a single criterion to determine the distinction between *clearly-adequate* (Level 1) and *adequate* (Level 2) handling qualities. Engineering judgement is required in the selection and application of the criteria. For systems based on pitch-angle control the following observations based on experience at the National Aerospace Laboratory NLR can be made.

The NLR RISE-TIME-AND-SETTLING-TIME CRITERION (Criterion 6) is recommended to predict/evaluate in particular the handling qualities that are of importance in the final approach and in the take-off. It has the advantage of simplicity of application and it retains its validity in cases where the pilot uses an intermittent control behaviour. Pitch-rate overshoot is however not limited by this criterion. Non-adequate system behaviour in this respect is strongly related to the "dropback" phenomenon after a block-type manipulator input. Therefore, in addition, the application of the NLR-MODIFIED GIBSON

CRITERION (Criterion 5) is recommended.

It is postulated that even for future fly-by-wire transport aircraft the control behaviour of the pilot during the landing (flare and touchdown) is characterized as a (high gain) compensatory error-reduction operation. The NLR-MODIFIED NEAL-SMITH CRITERION (Criterion 7) is considered the best evaluation tool here. In order to judge the handling qualities more completely, the application of the NLR PRECISION FLIGHT-PATH CONTROL CRITERION (Criterion 8) also is recommended.

These recommendations remain valid for future systems based on flight-path angle control, because strong indications exist that below a certain height above the runway these systems will be reconfigured to systems based on pitch angle control.

7. REFERENCES

- 1 Mooij, H.A.; "Criteria for low-speed longitudinal handling qualities of transport aircraft with closed-loop flight control systems"; Martinus Nijhoff Publishers, Dordrecht (1985).
- 2 Culick, F.E.C.; "The origins of the first powered, mancarrying airplane" in Scientific American, Vol. 241 (July 1979) pp. 76-88.
- 3 Hughes, Th.P.; "Elmer Sperry, Inventor and Engineer"; The John Hopkins University Press, Baltimore (1971).
- 4 Howard, R.W.; "Automatic flight controls in fixed wing aircraft: the first 100 years" in Aeronautical Journal, Vol. 77 (November 1973) pp. 540.
- 5 McRuer, D. and Meyers, T.T.; "Flying qualities of relaxed static stability aircraft - Volume II: Ramifications of flight-essential/critical heavily-augmented airplane characteristics on flying qualities"; DOT/FAA/CT-82/130-11 (1982).
- 6 Wall, R.L., Tate, J.L., and Moss, M.J.; "Advanced flight deck/crew system simulator functional requirements"; NASA CR 159331 (December 1980).
- 7 Black, G.T. and Moorhouse, D.J.; "Flying qualities design requirements for side-stick controllers"; AFFDL-TR-3126 (1979).
- 8 Miller, F.L. and Emfinger, J.E.; "Fly-by-wire techniques"; AFFDL-TR-67-53 (1967).
- 9 Cooper, G.E. and Harper, R.P.; "The use of pilot rating in the evaluation of aircraft handling qualities"; AGARD-R-567 (1969); also NASA TN D-5153 (1969).

- 10 Chalk, C.R., Neal, T.P., Harris, T.M., Pritchard, F.E., and Woodcock, C.J.; "Background information and user guide for MIL-F-8785 B (ASG), Military Specification-Flying Qualities of Piloted Airplanes"; AFFDL-TR-69-72 (1969).
- 11 McKuer, D.; "Human dynamics in man-machine systems" in *Automatica*, Vol. 16 (1980) pp. 237-253.
- 12 McKuer, D., Graham, D., Krendel, E., and Reisener, W.; "Human pilot dynamics in compensatory systems - Theory, models and experiments with controlled elements and forcing function variations"; AFFDL-TR-65-15 (1965).
- 13 Hallion, R.P.; "Test Pilots"; Doubleday and Company, Inc., Garden City (1981).
- 14 Phillips, W.H.; "Appreciation and prediction of flying qualities"; NACA Report No. 927 (1949).
- 15 Anon. "Stability and control requirements of airplanes"; Army Air forces Specification No. C-1815 (August, 1943); also Navy BuAer SR-119 (August 1943).
- 16 Anon. "Stability and Control Characteristics of Airplanes"; Army Air forces Specification No. R-1815-A (April 1945); also Navy Bur. Aero., SR-119 A (April 1945).
- 17 Anon. "Flying Qualities of Piloted Airplanes"; US Air Force Specification No. 1815-B (June 1948); also US Navy NAVAER SR-199 B (June 1948).
- 18 Anon. "Flying Qualities of Piloted Airplanes"; MIL-F-8785 (ASG) (September 1954).
- 19 Anon. "Military Specification - Flying Qualities of Piloted Airplanes"; MIL-F-8785 B (ASG) (August 1969).
- 20 Anon. "Military Specification, Flying Qualities of Piloted Airplanes"; MIL-F-8785 C (November 1980).
- 21 Anon. "Airworthiness standards: transport category airplanes"; FAR, Vol. III, Part 25 (March 1974).
- 22 Anon. "Joint Airworthiness Requirements, JAR-25, Large Aeroplanes"; Civil Aviation Authority, UK (July 1978).
- 23 Bihrls, W.; "A handling qualities theory for precise flight path control"; AFFDL-TR-65-198 (1966).
- 24 Chalk, C.R.; "Calpan recommendations for SCR flying qualities design criteria"; NASA-CR-159236 (1980).
- 25 Sudderth, R.W., Bohn, J.G., Caniff, M.A., and Bennett, G.R.; "Development of longitudinal handling qualities for large advanced supersonic aircraft"; NASA CR-137635 (1975).
- 26 Klinar, W.J. and Gilbert, D.W.; "Flying qualities requirements for the Orbiter utilizing closed-loop fly-by-wire control of vehicle response parameters"; NASA MCS-07151, Rev. 1 (December 1973).
- 27 Anon. "Requirements/Definition Document; Flight control, part 1: configuration, performance and functional requirements"; Rockwell International Space Division, Report SD 72-SH-0105, Vol. 1, Book 2, Part 1A (July 1977).
- 28 Gibson, J.C.; "Piloted handling qualities design criteria for high order flight control systems" in AGARD-CP-333 on "Criteria for handling qualities of military aircraft" (1982), pp. 4.1-4.15.
- 29 Neal, T.P. and Smith, R.E.; "An in-flight investigation to develop control system design criteria for fighter airplanes, Vol. I and II"; AFFDL-TR-70-74 (1970).
- 30 DiFranco, D.A.; "In-flight investigation of the effects of higher-order system dynamics on longitudinal handling qualities"; AFFDL-TR-68-90 (1968).
- 31 Smith, R.E.; "Effects of control system dynamics on fighter approach and landing longitudinal flying qualities, Vol. I"; AFFDL-TR-78-122-Vol. I (1978).
- 32 Radford, R.C., Smith, R.E., and Bailey, R.E.; "Landing flying qualities evaluation criteria for augmented aircraft"; NASA CR 163097 (1980).
- 33 Van Gool, M.F.C. and Mooij, H.A.; "Human pilot describing function, remnant and associated information for pitch attitude control: Results from in-flight and ground-based tracking experiments"; NLR TR 75062 U (1975).
- 34 Mooij, H.A.; "Handling quality criteria development for transport aircraft with fly-by-wire primary flight control systems"; NLR TR 74141 U (1976).
- 35 Weingarten, N.C. and Chalk, C.R.; "In-flight investigation of large airplane flying qualities for approach and landing"; AFWAL-TR-81-3118 (1981). Also published in abbreviated form as AIAA Paper 82-1296 (1982).

4-16

ACKNOWLEDGEMENT

The author wishes to express his gratitude to M.F.C. van Gool, J.A.J. van Engelen, H.A.J.N. Offerman and R.C. Cadée of the National Aerospace Laboratory NLR for their review of the paper in draft form. The critical review by and ensuing discussions with Prof. J.H. de Leeuw of Toronto University, on leave at NLR, are acknowledged in particular.

ADVANCES IN FLYING QUALITIES
Concepts and Criteria for a Mission Oriented Flying Qualities Specification

Roger H. Hoh
Principal Research Engineer
Systems Technology Inc.
Hawthorne, California USA

SUMMARY

There has been considerable activity during the past 8 years to upgrade the military flying qualities specifications for conventional aircraft, as well as for V/STOLs and helicopters. The primary objectives of these upgrades has been to account for the use of high gain, high authority augmentation, and to more directly reflect the requirements of the intended missions into the specifications. The methodologies developed to accomplish the latter objective is summarized in the first part of this lecture. This is followed by a brief overview of the Lower Order Equivalent Systems and Bandwidth criteria. Problems with the specification of control sensitivity, and potential solutions are then discussed, followed by a brief presentation of the use of time vs frequency domain criteria. An empirical method to combine the Cooper-Harper Handling Qualities Ratings (HQRs) from each axis of control into an overall rating is then presented. Finally a proposed specification for precision flare and landing is given, followed by an example application of the method.

ELEMENTS OF A MISSION ORIENTED FLYING QUALITIES SPECIFICATION

There are military flying qualities specifications for three types of aircraft in the United States. Flying qualities of conventional aircraft are covered by Mil-F-8785C (Ref. 1), a proposed revision some years ago (Ref. 2) and following an extended review cycle, the Mil-Std-1797 (USAF) (Ref. 3). The Mil-Std-1797 (USAF) specification is discussed in some detail by Mr. Woodcock in this lecture series. VSTOL aircraft handling is specified in Mil-F-83300 (Ref. 4). A complete revision of this specification was proposed in 1984 (Ref. 5), but there has been little activity since that time except for some isolated industry and government review. Finally, rotorcraft handling qualities are specified in Mil-H-8501A. The U.S Army has been supporting a much needed major revision effort to this specification, including several in-flight and ground-based simulation programs, since 1982, and a final proposed version is currently in publications. (Ref. 6 or see Ref. 7 for an overview). It represents the most advanced thinking in the area of mission oriented specifications by virtue of the fact that it was the last specification to be revised, and was able to build on the groundwork established by previous spec revision efforts (e.g., Refs. 2 and 5). All of the concepts discussed herein are contained in the new helicopter specification, some are included in the proposed VSTOL spec, and only a few are in the Mil-Std-1797 (USAF) since the original draft of that document was completed in 1982, and application of a number of these concepts to fixed wing aircraft has not yet been pursued.

With that background, we shall briefly consider the elements of a mission oriented flying qualities specification, as we see them today, using the proposed rotorcraft spec ("update 8501") as a model. A schematic diagram of the specification is given in Fig. 1, taken from Ref. 7. Here it can be seen that new terminology has been added to the "specification jargon." These new terms are discussed below.

- Mission-Task-Element (MTE) -- All of the proposed missions are subdivided into specific handling qualities tasks. This allows requirements to be written in terms of the task that must be accomplished.
- Response-Type -- The response of highly augmented airplanes depends on the nature of the feedbacks and feedforwards used in the stability command augmentation system (SCAS). For example some common Response-Types are Attitude-Command-Attitude-Hold (ACAH), and Rate-Command-Attitude-Hold (RCAH), Rate augmentation, etc.
- Divided Attention Operations -- The required stabilization for an acceptable level of workload increases as the pilot is tasked with additional nonflying duties. The mission oriented flying qualities specification, update 8501, accounts for this by requiring increased mid-term stability.
- Usable Cue Environment (UCE) -- The required stabilization for an acceptable level of workload increases as the pilots usable cue environment (UCE) is degraded. The UCE consists of the outside world plus cockpit displays and or vision aids. A methodology has been developed to account for this in update 8501 via the scales shown in Fig. 2. The VCR scale allows the pilot to rate the visual environment, while the UCE values determine the appropriate Response-Type, or in some cases, define a need for a different level of dynamics within a Response-Type category (see Refs. 8 or 9 for details).

An example of how the proper Response-Type is defined in terms of the task (Mission-Task-Element), and the visual cues including displays (Usable Cue Environment) is given in Table 1, taken from the proposed 8501 update. This table incorporates an important concept that is frequently overlooked; every task (MTE), has a Response-Type that is most compatible to the human pilot. Conversely, there are MTEs and Response-Types that

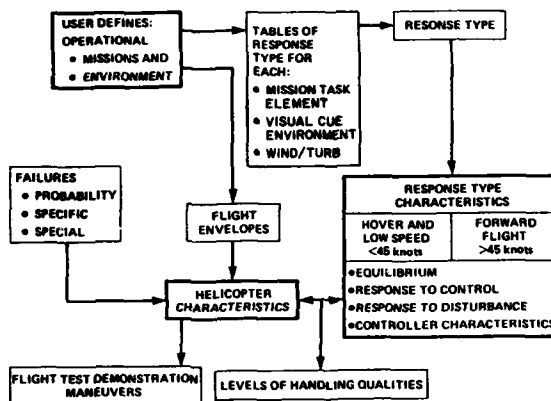
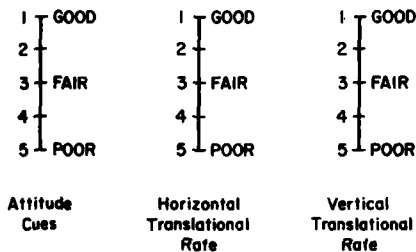

Figure 1. Schematic Diagram for Update 8501



Definitions of Cues

X = Pitch or roll attitude and lateral longitudinal, or vertical translational rate.

Good X Cues: Can make aggressive and precise X corrections with confidence and precision is good.

Fair X Cues: Can make only moderate X corrections with confidence and precision is only fair.

Poor X Cues: Only small and gentle corrections in X are possible, and consistent precision is not attainable.

Figure 2a. Visual Cue Rating (VCR) Scale to be Used When Making UCE Determinations

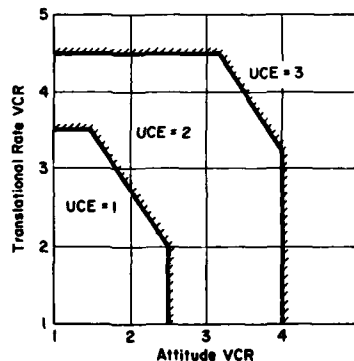

Figure 2b. Definition of Usable Cue Environments

TABLE 1. REQUIRED RESPONSE-TYPE FOR HOVER AND LOW SPEED -- NEAR EARTH

	UCE=1		UCE=2		UCE=3	
	LEVEL 1	LEVEL 2	LEVEL 1	LEVEL 2	LEVEL 1	LEVEL 2
Stationary MTEs						
precision hover (4.1.1, 4.1.2.) [*] suspended load pickup and delivery rapid vertical landing (4.1.5) shipboard landing RAST recovery vertical takeoff slope landing (4.1.6) rapid hovering turn sonar dunking	Rate ↓	Rate ↓	ACAR + RCDH + RCHH ↓	Rate + RCDH ↓	NA ↓	ACAR + RCDH + RCHH ↓
bob up/down (4.2.3)	↓		ACAR + RCDH + PH + RCHH			Rate + RCDH + RCHH + PH
hovering tasks involving divided attention operation (see 1.4.5.2) ^{**}	Rate + RCDH + RCHH + PH		ACAR + RCDH + PH + RCHH			
Translating MTEs						
mine sweeping	ACAR + RCDH		TRC + PH + RCDH + RCHH			
approach to hover shipboard stationkeeping target acquisition and tracking assault landing evasive action lateral sidestep (4.2.2) rapid accel/decel (4.2.1) slalom (4.2.5) dolphin (4.2.4)	Rate ↓	↓	↓	↓	↓	↓

* Numbers in parentheses refer to maneuvers in Section 4 which represent a flight test version of these Mission-Elements

** Important consideration for single pilot

Notes:

1. A requirement for RCHH may be deleted if the vertical translation cue rating is 2 or better, and divided attention operation is not required.
2. Turn Coordination (TC) is always required as an available Response-Type for the slalom MTE in the Low Speed flight range as defined in Paragraph 1.4.6.2. However, TC is not required at airspeeds less than 15 knots.
3. A specified Response-Type may be replaced with a higher level of stabilization providing that the moderate and large amplitude maneuvering requirements may still be met.

The rank-ordering of Combinations of Response-Types from least to most stabilization is defined as:

1. Rate
2. ACAR + RCDH
3. ACAR + RCDH + RCHH
4. Rate + RCDH + RCHH + PH
5. ACAR + RCDH + RCHH + PH
6. TRC + RCDH + RCHH + PH

Definitions:

- Rate => Rate or Rate Command Attitude Hold (RCAR) Response-Type (Paragraph 3.2.5, 3.2.6, and 3.2.8).
- TC => Turn Coordination (Paragraph 3.2.10.1).
- ACAR => Attitude Command Attitude Hold Response-Type (Paragraph 3.2.7).
- RCHH => Vertical Rate Command with Altitude (Height) Hold Response-Type (Paragraph 3.2.8.1).
- PH => Position Hold Response-Type (Paragraph 3.3.11).
- TRC => Translational Rate Command Response-Type (Paragraph 3.2.8).

are totally incompatible. Therefore, before applying any criterion, the user must insure that the Response-Type is compatible with the task. For example, Table 1 shows that for helicopters operating in the low speed and hover flight regime, increased stabilization is necessary for MTEs that require divided attention, or when the visual cues are degraded (UCE>1). Such a table does not exist for the Mil-Std-1797 (USAF), but research has shown that certain Response-Types are necessary for consistent performance, and Level 1 pilot ratings for precision flare and landing (See Refs. 10 or 11). Specifically Rate or RCAM Response Types require certain specific flight path characteristics, whereas an Attitude Response-Type virtually guarantees good pilot ratings and performance for flare and landing. This is discussed in greater detail later in the lecture.

Another important feature of the mission oriented specification is that the requirements on attitude control are a function of the amplitude required by the task, e.g., precision closed loop tracking, pursuit tracking, and full-control open loop maneuvers. Three separate criteria are provided in update 8501 - small amplitude, moderate amplitude, and large amplitude attitude changes. This is discussed further under the Bandwidth criterion presented in the next section.

DISCUSSION OF CRITERION PARAMETERS

The following discussion is intended to highlight certain features of the flying qualities criteria most commonly utilized in the specifications discussed above, Lower Order Equivalent Systems, and Bandwidth.

Lower Order Equivalent Systems

Lower order equivalent systems were developed as a methodology in the early 1970s as part of a flying qualities assurance program in support of the F-14, prior to first flight. This methodology was refined to the point where it could be utilized as a flying qualities criterion in Ref 2.

1. Brief Overview of Lower Order Equivalent Systems

Conceptually, the LOES method assumes that a highly augmented airplane will have an attitude and flight path response to control that looks like a conventional unaugmented airplane, even though the characteristic equation of a highly augmented aircraft typically includes as many as 55 separate modes. Most of these modes are at high frequency, and result from the necessary filtering that goes with high gain high authority augmentation. If these modes cause the response to look nonconventional, the theory goes, the pilots will not like it, and the match between the assumed conventional form and the actual response will be poor. An obvious choice for a lower order form to represent a conventional unaugmented airplane is the short period approximation with the addition of a time delay to account for the high frequency lags noted above.

$$\frac{\theta}{\delta_e} = \frac{M_{\theta_e} (s + \frac{1}{T_{\theta_2}}) e^{-\tau s}}{s (s^2 + 2\zeta_{sp} \omega_{sp} s + \omega_{sp}^2)} \quad (1)$$

Given a higher order aircraft, four parameters are available to accomplish the match ω_{sp} , ζ_{sp} , $1/T_{\theta_2}$, and τ . The match is accomplished using a steepest descent method known as the Rosenbröck search routine which minimizes the difference between gain and phase of the higher and lower order systems (ΔG and $\Delta \phi$ respectively). The match is accomplished at 20 frequencies between 0.10 and 10.0 rad/sec and, the following function is minimized.

$$M = \int (\Delta G)^2 + K(\Delta \phi)^2 \quad (2)$$

The resulting "equivalent" values of the four parameters of the short period approximation are used for plotting on the existing CAP boundaries (Fig. 3), noting that $1/T_{\theta_2} = g/U_0$ n/s. Hence the database and criterion boundaries generated for conventional unaugmented airplanes is preserved.

The boundaries in Fig. 3 are generally referred to as the control anticipation parameter (CAP) which has several physical interpretations. These are summarized in Fig. 4. Note that these interpretations all involve the relationship between an aircraft pitch attitude change and the resulting flight path change (normal load factor). In fact, CAP is shown to be proportional to the maneuver margin, and to stick force per g for a conventional unaugmented aircraft (see Fig. 4). Therefore it is necessary to preserve the relationship between pitch and flight path in the equivalent system match.

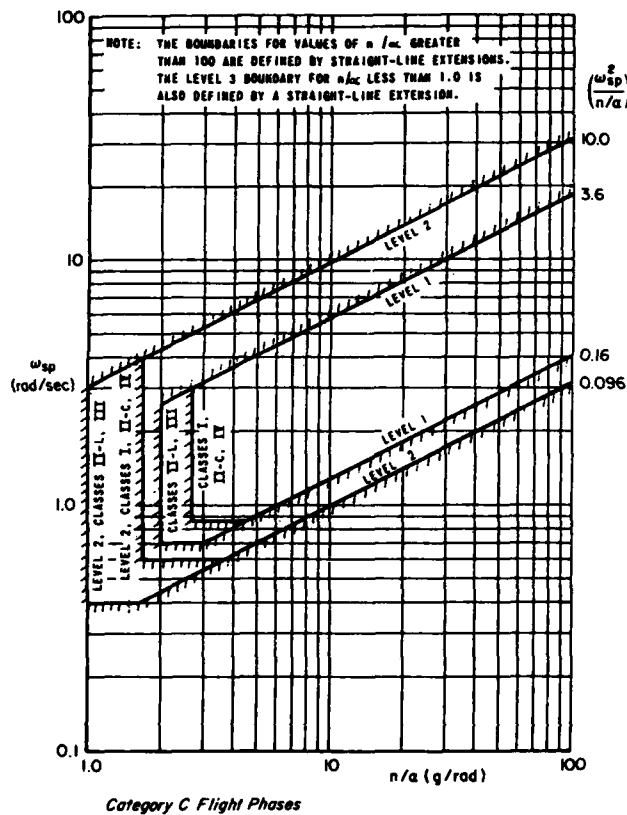

Figure 3. Typical CAP Boundaries From Ref. 3

$$CAP \equiv \frac{\delta_0}{n_{gaa}} = \frac{u_0^2}{n/a} = \frac{u_0^2}{\frac{v_0}{g} 1/T_{\theta_2}}$$

Interpretations

- Initial and final responses must be neither too sensitive or too insensitive to commanded flight changes. (Bihrie)
- $\frac{F_a}{n_{gaa}} \cdot \frac{\delta_0}{F_p} = \frac{u_0^2}{n/a}$ - i.e., it is a measure of initial pitch acceleration per pound of stick force (classical definition of stick sensitivity) times the quasi steady normal acceleration per pound of force (stick force per g).
- It represents the frequency separation between the pitch attitude response (u_{sp}) and the flight path response ($1/T_{\theta_2}$) e.g., "path-to-attitude consonance"
- It is a measure of maneuver margin

$$CAP = \frac{u_0^2}{n/a} = \frac{\partial W}{\partial Y} \left[\underbrace{-\frac{dC_H}{dC_L} - \frac{\rho a C}{2m} C_{mq}}_{\text{maneuver margin}} \right]$$

Figure 4. Physical Interpretations of the Control Anticipation Parameter (CAP)

This is accomplished in the Mil-Std-1797 (USAF) by requiring a simultaneous match of pitch attitude and normal acceleration as follows.

$$\frac{\delta}{F_e} = \frac{K_1 (s + 1/T_{\theta_2}) e^{-\tau_e s}}{s^2 + 2\zeta_{sp} \omega_{sp} s + \omega_{sp}^2} \quad (3)$$

$$\frac{n_z}{F_e} = \frac{K_2 e^{-\tau_e s}}{s^2 + 2\zeta_{sp} \omega_{sp} s + \omega_{sp}^2} \quad (4)$$

where n_z refers to the normal acceleration at the instantaneous center of rotation (at $x_{zr} = Z_{sp}/M_{sp}$). The instantaneous center of rotation is picked as the reference point because there n_z is unaffected by the location of the control surfaces, so that the relationship between flight path and attitude is very closely approximated by,¹

$$\frac{y}{\delta} = \frac{1}{T_{\theta_2} s + 1} \quad (5)$$

The simultaneous matching defined by equations 3 and 4 will insure that $1/T_{\theta_2}$ will not "gallop" to unreasonably large values during the fitting process, since it insures that Eq. 5 must remain satisfied. It is incorrect to use a value of $1/T_{\theta_2}$ obtained from a match using only Eq. 3 (i.e., nonsimultaneous match) with $1/T_{\theta_2}$ allowed to be free. Such a value of $1/T_{\theta_2}$ results in a value of n/a which assumes that CAP is based only on attitude, and that flight path (normal load factor) is not a consideration. This is simply not correct (see Fig. 4). This point is emphasized because many researchers continue to allow $1/T_{\theta_2}$ to be free, or attempt interpretations with $1/T_{\theta_2}$ fixed and with it free. Note that a simultaneous match as required by the Mil-Std-1797 (USAF) always yields the same value of $1/T_{\theta_2}$, as would be obtained with a match of Eq. 3 alone with $1/T_{\theta_2}$ fixed.² So, why add the seemingly unnecessary complexity of a simultaneous matching procedure in the spec? It was done because it was not possible to convince all of the specification reviewers that a match with $1/T_{\theta_2}$ fixed was the correct alternative. It was impossible however, to argue against the necessity to preserve the integrity of the attitude and flight path responses in the fitting process.

From the above discussion, the evolution of the LOES is seen to be firmly based on the concept that the augmented airplane attitude and flight path responses will have the fundamental characteristics of a conventional unaugmented airplane. Such characteristics are formalized in terms of a "Response-Type," and are more precisely defined, later in this lecture (see Fig. 20).

2. Some Limitations on the Use of Lower Order Equivalent Systems

In the process of developing the background and information users guide for the new Mil-Std-1797 (USAF) (see Ref. 2), it was noted that many of the cases from the Ref. 12 experiment (commonly referred to as the "Neal-Smith data") did not fit the CAP boundaries developed for conventional airplanes. These cases are shown in Fig. 5 as filled data points, and are seen to exhibit consistent Level 2 pilot ratings in the Level 1 region³ (defined by the existing Mil-F-8785C boundaries). Some researchers interpreted this result as a need for increased damping for augmented aircraft. Physically, this did not make sense since the augmentation should be transparent to the pilot. An investigation of these cases revealed that they all had an unusual "hump" in the frequency response as shown in Fig. 6. This hump constitutes higher order dynamics in the region

¹This definition removes the pilot location as a factor in the normal acceleration response. It may be argued that the effect of pilot location should be included. However, the data supporting the CAP boundaries do not include pilot location effects, and it would not be appropriate to assume that such effects would be properly accounted for by simply calculating the pilot station acceleration in the matching process. The data currently available on pilot location effects are sketchy. It is known that locating the pilot far aft of the instantaneous center of rotation (ICR) is undesirable, because of the non-minimum phase flight path response that results (i.e., an initial reversal). Conversely, locating the pilot forward of the ICR is quite desirable as shown later in Fig. 23b.

² $1/T_{\theta_2}$ will vary slightly (not "gallop") from its fixed value during a simultaneous match if there are higher order dynamics in the region between $1/T_{\theta_2}$ and ω_{sp} . However, it will be illustrated later in this lecture, that the LOES method is not valid in such cases, because it is based on the classical airplane data used to develop the CAP boundaries.

³The CAP boundaries have been presented in a different format than Fig. 3 to allow inclusion of the damping ratio limits on the same plot.

GENERAL FORM: $\frac{\theta}{F_s} = \frac{A_\theta (1/T_{\theta 2})}{(0) [\zeta_{sp} \omega_{sp}] \text{ Airframe}} \cdot \frac{K (1/T_1)}{(1/T_2) [\zeta_3 \omega_3] \text{ Added Dynamics}}$

SOLID — "HUMP" CASES

OPEN — HIGH-FREQUENCY LEAD/LAGS (NO "HUMP")

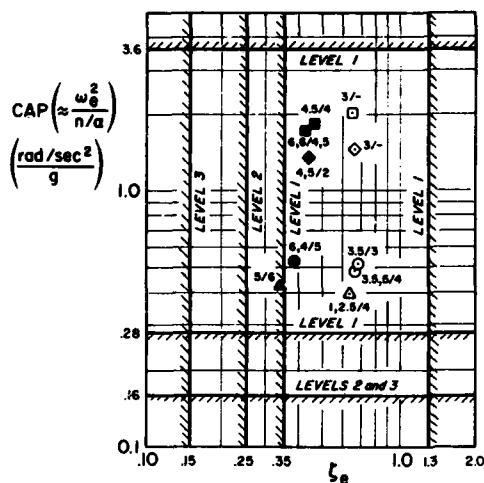

Figure 5. Lead/Lag Configurations from Neal/Smith Tests (Ref. 12)

HOS: $\frac{\theta}{F_s} = \frac{A_\theta (1.25)}{(0) [0.69, 2.2]} \cdot \frac{(1.5)}{(2) [0.75, 63]}$

LOES: $\frac{\theta}{F_s} = \frac{A_\theta (1.25)e^{+.004s}}{(0) [0.38, 3.1]}$

PR: 6, 4, 5

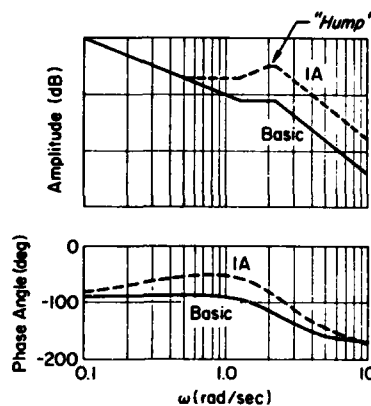

Figure 6. Example Lead/Lag Violator (Neal/Smith Configuration 1A)

in the region of piloted crossover (generally between $1/T_{\theta 2}$ and ω_{sp}), which is theoretically not allowable when using LOES to plot data on the conventional airplane CAP boundaries. A review of the data indicated that the pilot commentary all centered about excessive abruptness. The Lower order equivalent system matching routine has no way to characterize such a hump, except to lower the damping ratio, and to assign positive values of time delay (which is of-course absurd). None of the commentary indicated that low damping was a factor in the Level 2 ratings. These results support the theoretical notion that it is simply not correct to use LOES when there are higher order dynamics in the region of piloted crossover.

In summary, the LOES criterion should not be used when:

- there are higher order dynamics in the region of piloted crossover (approximately between .7 and 4 rad/sec).
- the pitch attitude and flight path response characteristics are not that of a conventional airplane (defined later, see Fig. 20).

Bandwidth as a Criterion

Bandwidth is a term that has classically been used to describe the ability of an electrical network, or a servomechanism to follow a range of input frequencies. In that context, it is defined as the frequency where the output magnitude is 3 dB less than the input (ratio of 0.707). A good system will have a high Bandwidth, and a poor one will have a low Bandwidth relative to the maximum input frequency that it is designed to follow. In most cases, the upper bandwidth limit is set by system stability considerations.

1. Definition of the Bandwidth Frequency as a Flying Qualities Criterion.

The development of the Crossover Model by McRuer and Ashkenas in the early 60s was based on the concept that the human pilot can be treated as an element of a closed loop system for compensatory tracking tasks. Experimental measurements have verified that concept, and this was discussed earlier in this lecture series. The Bandwidth criterion is an application of the crossover model concept (as is the Neal-Smith criterion discussed in the previous lecture by Dr. Noolj). It is based on the premise that the maximum crossover frequency that a pure gain pilot can achieve, without threatening stability, is a valid figure-of-merit of the controlled element (i.e., similar to a servomechanism). On this basis, Bandwidth is defined as the frequency where the phase

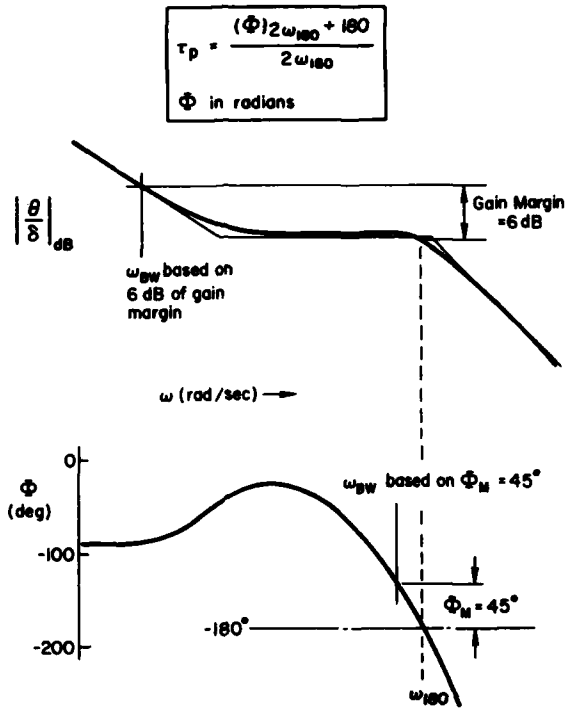

To Obtain Bandwidth:

1. Calculate ω_{BW} based on phase margin
2. Calculate ω_{BW} based on gain margin
3. Use lowest value

Figure 7. Definition of Bandwidth and Phase Delay

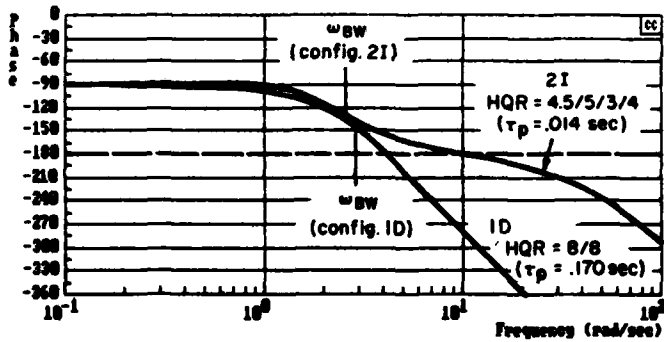

Figure 8. Comparison of Phase Characteristics Between Configurations with High and Low Phase Delay

margin is 45 degrees, or the gain margin is less than 6 dB as shown in Fig. 7.⁴ The phase margin criterion is based on pilot describing function data which shows that tracking with 45 degrees of phase margin is representative of full attention, but less than maximum effort. A gain margin limit of 6 dB was selected based on long experience which has shown that a lesser value tends to result in a PIO prone aircraft.

The "bandwidth hypothesis" was verified initially for the wings-level-turn mode as previously discussed by Mr. Ashkenas, and in more detail in Ref. 13.

2. Definition of Phase Delay

Efforts to develop Bandwidth as a generalized criterion for highly augmented aircraft showed that pilots were also sensitive to the shape of the phase curve at frequencies beyond the Bandwidth frequency. This is defined by the phase delay parameter in Fig. 7. Figure 8 illustrates that for "large" values of phase delay, the phase curve drops off more rapidly than for "small" values. Physically, phase delay is a measure of the behavior of the aircraft as the pilot increases his crossover frequency, i.e., "tightens up" beyond the Bandwidth frequency. Large values of phase delay means that there is a small margin (range of frequencies) between normal tracking at 45 degrees of phase margin, and instability. The inevitable pilot commentary for an aircraft with large phase delay is that it is PIO prone.

Phase delay (τ_p) is typically (but not always) close to the equivalent time delay (τ_e) calculated for a LOES. However, a physically satisfying explanation of why such small values of equivalent time delay resulted in large pilot rating degradations (.05 sec was shown to be roughly equivalent to 1 Cooper Harper pilot rating for values greater than 0.10) was not available until development of the Bandwidth criterion. For example, consider the two cases taken from the proposed Mil-Std-1797 (USAF) (Refs. 2 or 3), and shown in Fig. 8. These configurations both have essentially the same Bandwidth (approximately 2.6 rad/sec), but one has significantly higher phase delay (.014 sec vs .17 sec), and significantly degraded pilot ratings (average rating of 4.1 vs. 8). It seems intuitively unlikely that this drastic degradation in pilot rating can be attributed to a 0.15 sec shift in the time response or, due to the phase shift around the crossover frequency which is seen to be negligible (Fig. 8). However, the shape of the phase curve is drastically steeper above the Bandwidth frequency, a factor which intuitively would be expected to lead to a significant difference in pilot rating. This is the only factor which yields a plausible explanation of the strong sensitivity of pilot rating to phase delay (and similarly equivalent system time delay). This is important because it reveals the fact that equivalent system time delay is significant only because it is a measure of the shape of the phase curve around the instability frequency, not, because of the transport delay properties in the time domain. Paradoxically, criteria which measure "time delay" in the time domain, such as that shown in Fig. 9, taken from the Mil-Std-1797 (USAF) (Ref. 3), are of questionable validity. That is, the measurement of a transport delay resulting from a step input is sensitive to all the wrong things, e.g., minor variations in the shape of the input, initial conditions etc. Because of this, such measurements may not be an accurate representation of the shape of the phase curve, which is the root cause of the problem.

3. Effect of Task and Visual Environment on the Required Bandwidth

The Bandwidth criterion involves two parameters; the Bandwidth frequency, and phase delay. Here it is applied to a single loop (pitch, roll or yaw) tracking task, or as the inner loop to a multiple loop task. Not surprisingly the limits depend on the task (MTE), the visual conditions (UCE), and the required divided attention. This is reflected in the update 8501 specification as shown in Fig. 10. Note that a higher Bandwidth is required for "target acquisition and tracking" than other MTEs. Increased Bandwidth is also required in a degraded usable cue environment (UCE>1), and for divided attention operations.

As discussed above, the Bandwidth criterion is applicable to tasks which require closed loop compensatory tracking. Such tracking involves small amplitude attitude changes. If the task requires larger attitude changes, the pilot gradually transitions to a pursuit mode. In-flight and ground-based simulation data has shown that the requirement for Bandwidth decreases as the amplitude of the maneuver increases (see Ref. 8). The mission oriented flying qualities specification should account for this. An example of how this is done in the update 8501 is shown in Fig. 11. The parameter $q_{pk}/\Delta\theta$ is a measure of Bandwidth, and is obtained by rapidly changing aircraft attitude, starting and ending with zero angular rate. The connection between $q_{pk}/\Delta\theta$ and ω_{BW} is derived in Ref. 8. For very large amplitude attitude changes, the pilot operates open loop with full control inputs. Therefore, the applicable criterion is maximum achievable angular rates, for attitude changes larger than specified in Fig. 11.

GUIDANCE FOR APPLICATION OF CRITERIA

Before making correlations or evaluations based on any of the criteria for precision attitude or flight path control, the reader is cautioned to ask the following questions.

⁴Bandwidth is capitalized when referring to this specialized definition for handling qualities, rather than the more general definition noted above.

RISE TIME LIMITS

Level	Nonterminal Flight Phases		Terminal Flight Phases	
	Min Δt	Max Δt	Min Δt	Max Δt
1	$9/V_T$	$500/V_T$	$9/V_T$	$200/V_T$
2	$3.2/V_T$	$1600/V_T$	$3.2/V_T$	$645/V_T$

where V_T is true airspeed, ft/sec

Level	t_l	$\Delta q_2 / \Delta q_1$
1	.12	.30
2	.17	.60
3	.21	.85

Maximum allowable values of time delay and transient peak ratio

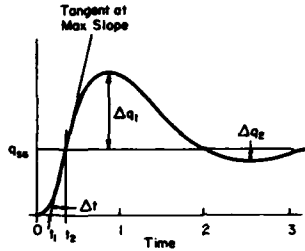

$\frac{\Delta q_2}{\Delta q_1} \sim$ Transient Peak Ratio
 $t_l \sim$ Effective Time Delay
 $\Delta t \sim$ Effective Rise Time

Figure 9. Criterion Based on Pitch Rate Response to Step Input of Pitch Controller Force or Deflection from Ref. 3

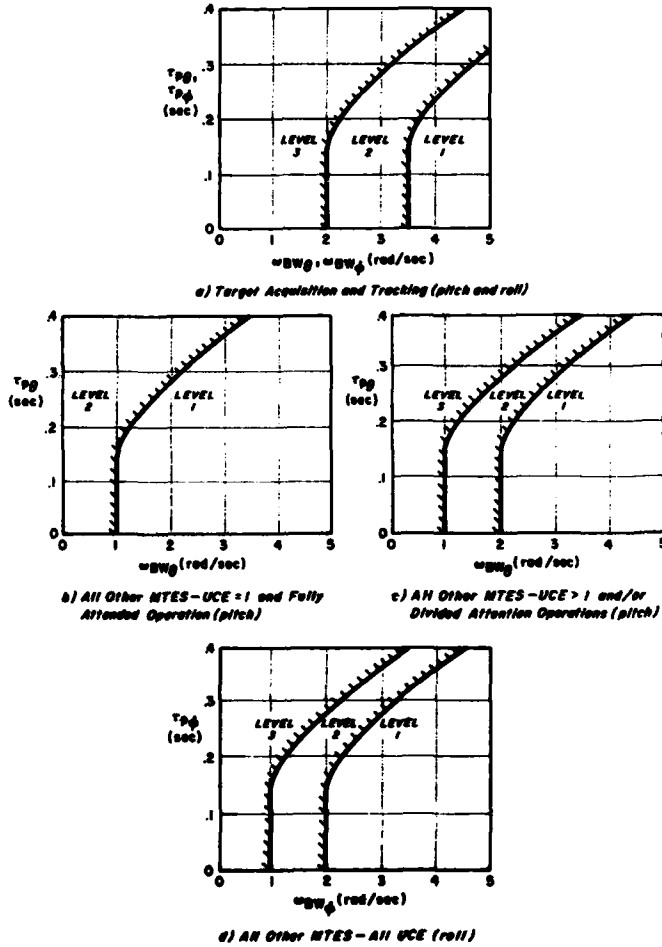

Figure 10. Requirements for Small-Amplitude Pitch (Roll) Attitude Changes -- Hover and Low Speed (from Ref. 6)

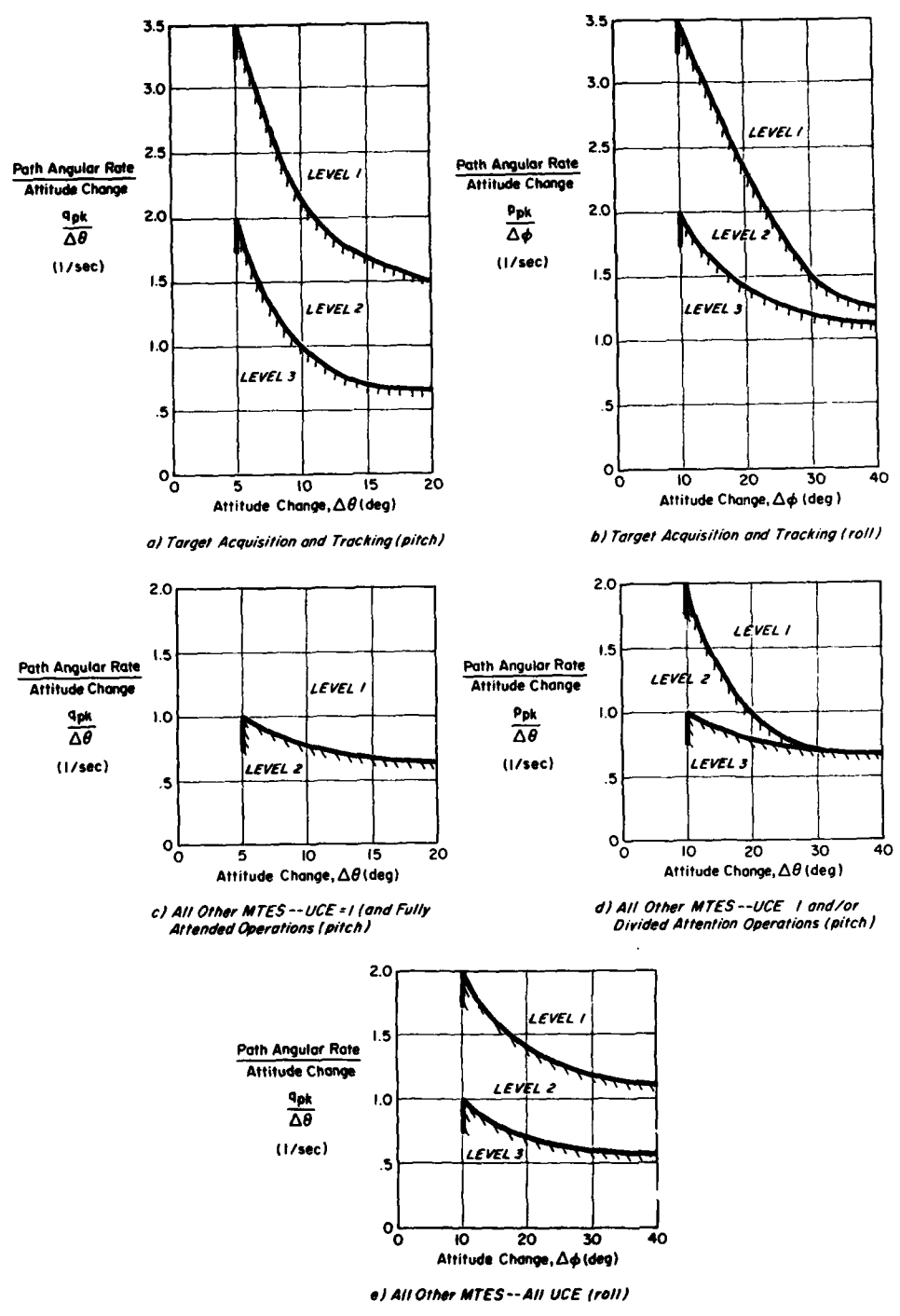

Figure 11. Requirements for Moderate-Amplitude Pitch (Roll) Attitude Changes -- Hover and Low Speed (from Ref. 6)

- Has the control sensitivity been optimized? This one factor has been, and continues to be a major source of confusion, and misinterpretation of data. Never conduct a handling qualities experiment, or use data from an experiment, without proper attention to control sensitivity!
- Is the Response-Type correct for the task? No amount of Bandwidth (or any other metric) will allow good flying qualities if the character of the response is wrong. Knowledge in this area is sketchy, but certain guidelines are available (see for example Table 1 for helicopters, and later discussion under "Proposed Specification for Precision Flare and Landings.")
- Was/is the task well defined?

CONTROL SENSITIVITY

Specification of control sensitivity represents a primary weakness of the current requirements. All of the criteria for attitude control (Equivalent Systems, CAP, Bandwidth etc.) do not include the effect of control sensitivity, assuming that it is separately optimized. Its importance is minimized for two reasons, 1) it is assumed that the control gearing can be easily changed, especially with fly-by-wire aircraft, and 2) it is a function of the task, and the characteristic dynamics (equivalent short period, Bandwidth etc.). A very large data-base (read expensive) would be required to formulate a quantitative control sensitivity specification, especially considering that sidestick, centerstick, fixed, and moving controllers should be considered.

Even the most experienced and perceptive test pilots can and have been fooled by varying control sensitivity. Excessively high control sensitivity looks like low damping, is therefore PIO prone, and will receive comments to that effect (few, if any, pilots will isolate the problem as excessively high control sensitivity). Similarly, excessively low control sensitivity will receive comments related to an overly sluggish response.

The control sensitivity should logically be specified over the band of frequencies where the pilot is most sensitive to the aircraft response. For closed loop compensatory tracking tasks, this would, by definition, be the region of piloted crossover. Considerable insight into this region can be gained from the envelopes formulated in Ref. 14, and shown in Fig. 12 (also see Ref. 2, pg. 117). These envelopes of "maximum unnoticeable added dynamics" were derived from the Ref. 12 data by noting the modifications to the baseline configuration (variable stability NT-33) that resulted in a 1 pilot rating change. Pilots are seen to be highly sensitive to changes in the dynamics between 0.8 and 5 radians/sec for the precision pitch attitude tracking task of Ref. 12. This is consistent with pilot describing function data (Ref. 15) which indicates a similar band of frequencies to define the region of piloted crossover. Since, by definition, the pilot is operating in the crossover region, it is the gain in that region that should be specified. Unfortunately, none of the existing handling qualities specifications include such a requirement, primarily because the necessary data is not available.

The Mil-Std-1797 (USAF) includes the product of the stick sensitivities at low and high frequencies as a criterion,

$$\frac{F_e}{n_{z_{ss}}} \cdot \left| \frac{\delta_{\theta}}{F_e} \right|$$

$F_e/n_{z_{ss}}$ is measured as the quasi-steady stick force required to achieve a steady load factor (low end of Fig. 13 envelope), and δ_{θ}/F_e is defined at very high frequency (high end of envelope). Since the product of these parameters does not uniquely specify the

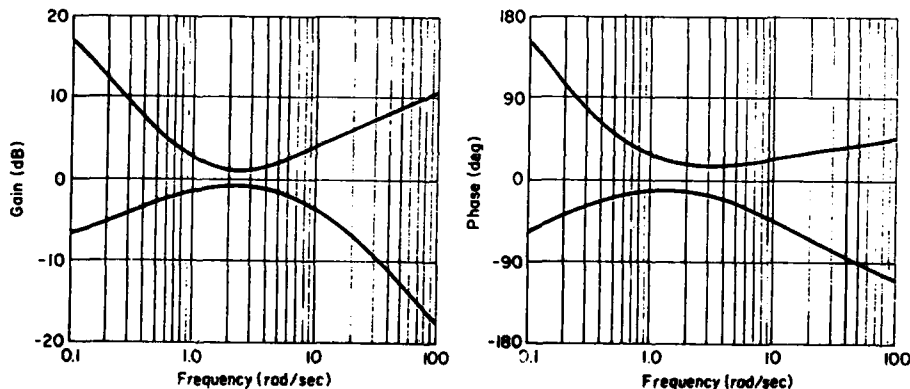
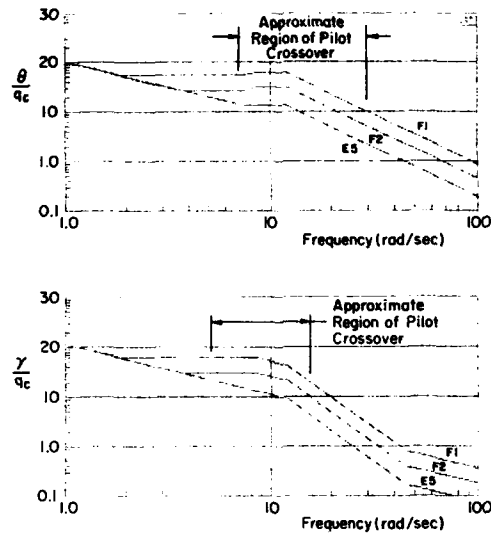

Figure 12. Envelopes of Maximum Unnoticeable Added Dynamics



Config.	Ground-Based Simulation HQR	Control Sensitivity		Bandwidth	
		$\left \frac{g}{q_c} \right _{\omega=2}$	$\left \frac{\gamma}{q_c} \right _{\omega=1}$	ω_{wg} (rad/sec)	ω_{wy} (rad/sec)
E5 Baseline	3/2/3*	0.45	1.1	1.31	0.63
F2	6/4/3	1.10	2.8	1.67	0.86
F1	8/6/5	2.20	5.5	1.83	0.97

*HQR = 3/4/4 in-flight simulation

Figure 13. Variation in Control Sensitivity for Ref. 16 Configurations

transfer function gain in the region of piloted crossover (center of Fig. 13 envelope), it is not judged to be a generally valid measure of sensitivity. Proposed limit values range from 3.6 rad.s⁻²/g in Ref. 3, to 0.45 rad.s⁻²/g in Ref. 16. The Ref. 3 value is simply the upper limit of the CAP boundary.

Stick force per g is an important cue to assist pilots from inadvertently approaching the limit load factor. If a handling qualities experiment is conducted so that the stick force per g is held constant, and the dynamics are varied, it is possible to achieve a wide variation in gain in the crossover region. In such cases, it is difficult to determine if the pilot's rating variations are due to the gain (control sensitivity) or the dynamics. For example, in the Ref. 16 experiment, stick force per g was held constant, while the dynamics were varied as shown in Fig. 13. Note that the magnitude of the Bode plot in the region of crossover for attitude and flight path control varies dramatically between the good configuration E5, and the bad configuration F1 (almost a factor of 5). Yet, the Bandwidth values of these configurations are quite similar, and fall into the level 2 range (consistent with the flight ratings of 3/4/4, see Fig. 14). It would appear that Bandwidth has inadequate sensitivity to these variations, considering the wide difference in pilot ratings and small change in Bandwidth (Fig. 14). In fact, the trend is even in the wrong direction (increasing Bandwidth yields degraded ratings). However, it is possible, even likely, that given the opportunity to reduce the control sensitivity of configurations F1 and F2, the pilots would find the flying qualities similar to E5, which would fall in line with the other experimental data for approach and landing (Ref. 17) plotted on Fig. 14. These three configurations have been included in the test plan of an upcoming piloted simulation experiment to be conducted on the USAF Lamars moving-base simulator to check this hypothesis.

As might be expected, the proper control sensitivity depends on the crispness of the response as measured by Bandwidth, or equivalent short period frequency. Aircraft with a crisp response (high Bandwidth) tend to require a lower control sensitivity than those with a more sluggish response (low Bandwidth). This intuitive observation was confirmed in Ref. 11, as shown by the data in Fig. 15. Note that the magnitude of the attitude-to-stick transfer function at the Bandwidth frequency is used as a measure of control sensitivity, a logical choice since the region of piloted crossover is, by definition, located in the vicinity of ω_{wg} . This plot serves as a possible explanation as to why certain configurations from the Ref. 17 experiment tended to violate all of the usual handling qualities criteria. That is, those configurations appear to have control sensitivity problems.

Until more data becomes available, Fig. 15, serves as a guide for control sensitivity for the landing approach task.

TIME DOMAIN VS FREQUENCY DOMAIN CRITERIA

The specification of handling qualities for precision tracking with aircraft attitude, is best accomplished with frequency based criteria. These criteria emphasize features directly related to the piloted loop closure. Time domain criteria have been found to be more appropriate for use with lower frequency phenomenon such as pursuit tracking, flight path control etc. Most time domain criteria for attitude control are based a step or boxcar input. Such inputs emphasize the mid and low frequency characteristics, at the expense of the response in the region of piloted crossover, which tends to be suppressed to the origin.

A moving-base piloted simulation experiment was conducted on the NASA Ames Vertical Motion Simulator (Ref. 5) specifically to compare rise-time type criteria (e.g., Fig. 9) vs the Bandwidth criterion. The tasks were 1) to hover over point on the deck of ship in sea state 3, and, 2) to land on that point. Four configurations were formulated which had identical Bandwidth, but exhibited wide variations in rise-time due to changes in the damping ratio. The relationship between rise-time, damping ratio and Bandwidth for the ACAH Response-Type is given in Fig. 16. ACAH was used because of known problems with simulator validity for Rate Response-Types (Ref. 2). The step input time responses, and corresponding pilot ratings for the tested configurations are given in Fig. 17. Note that the pilot ratings are essentially invariant in spite of a wide variation in rise time. The pilots noted definite differences in the open-loop responses during initial familiarization, but these were apparently unimportant in terms of the task. These results indicate that Bandwidth is a better metric than rise time for the prediction of handling qualities for small amplitude precision tracking tasks. In addition to these results, the time domain criteria had other shortcomings.

- The Level 1 values of rise time involved very small values (order of .05 sec). See Fig. 16, and Fig. 9.
- Slight variations in the shape of the "step" input caused significant changes in the rise time.
- Rise time data obtained from flight tests was not repeatable, due to the input shaping problem noted above, atmospheric disturbances, and problems with establishing ideal initial conditions.

Frequency domain criteria tend to be unreliable at the low end of the spectrum because there is typically insufficient power in the input and measured response at lower frequencies. The large amplitudes associated with low frequency inputs present practical problems in terms of maintaining trim, maneuvering room, and large deviations from the reference flight condition. Therefore, it is better to utilize time domain criteria for lower frequency tasks. The update 8501 specification utilizes a mix of time and frequency domain criteria based on the above considerations, e.g., see Figs. 10 and 11.

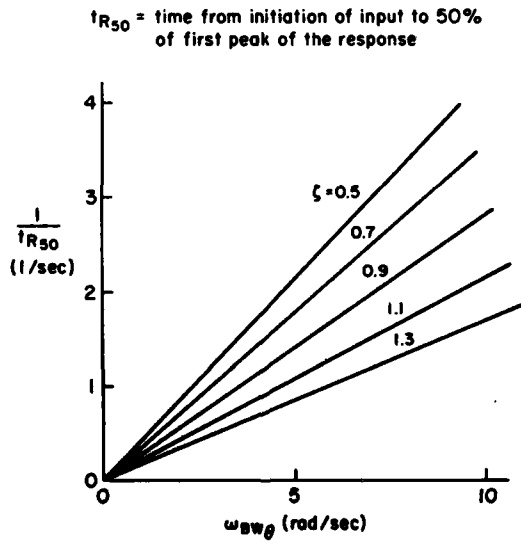

Figure 16. Relationship Between t_{R50} and ω_{bw0} for Attitude Systems

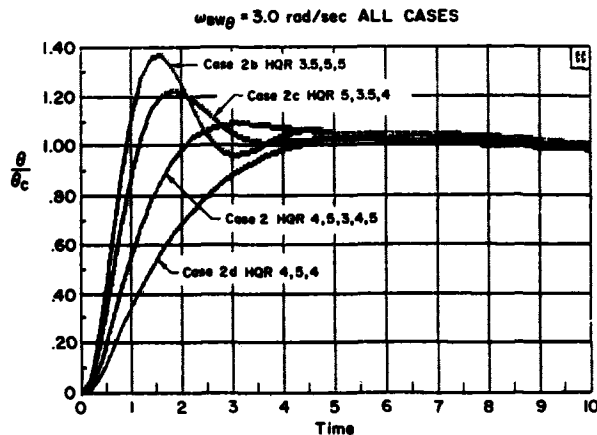

Figure 17. Illustration of Insensitivity of Pilot Rating to Rise-Time if $\omega_{w0} = \text{Const.}$ (Ref. 5)

COMBINED AXIS PILOT RATINGS

The combined effect of degraded handling qualities in each axis of control is not addressed in any of the specifications. There is however, an empirical formula which seems reasonably effective as a method to predict the combined effect of flying qualities degradations in individual axes.

$$R_m = 10 + \frac{-1(m+1)}{8.3(m-1)} \prod_{i=1}^m (R_i - 10) \tag{6}$$

Where

- R_m = the predicted overall pilot rating
- R_i = the pilot rating in a given axis
- m = the number of axes rated

This equation was recently investigated in a fixed base simulation with good results as shown in Fig. 18. Unfortunately, it has never been checked in a moving base or in-flight environment. Until such data is available, this "product rule" will remain advisory in nature. It is interesting to note that the predicted effect of two 5s is a 7, i.e., Level 3.

PROPOSED SPECIFICATION FOR PRECISION FLARE AND LANDING

The objectives of this final section of the lecture are to illustrate, 1) the role of Response-Type categories in a flying qualities specification, 2) an application of the Bandwidth criterion, 3) application, as well as certain limitations, of the use of Lower Order Equivalent Systems (LOES) and 4) the importance of considering attitude and flight path responses together. While this may seem obvious, many erroneous conclusions have been published based on using only the attitude Bandwidth, with no consideration for path response.

Consider the generic characteristics of a typical high gain SCAS as the loop gain is increased (Fig. 19). Note that the "dominant mode," omega-prime, circles the zero designated by $1/T_q$. It follows that we would want to set $1/T_q$ at as high a value as possible, without destabilizing the locus for a crisp attitude response (large omega-prime). However, we shall see that $1/T_q$ has a dramatic effect on the flight path response characteristics, which if ignored, can result in the wrong Response-Type for the flare and landing task.

For this example we shall consider three competing Response-Types for the flare and landing Mission-Task-Element; 1) Conventional Airplane, 2) Rate-Command-Attitude-Hold (RCAN), and 3) Attitude-Command-Attitude-Hold (ACAN). The generic Bode asymptotes, and time responses to a step control input are shown for pitch attitude, flight path angle, and angle-of-attack in Figs. 20, 21, and 22. Each Response-Type is discussed in some detail below.

1. Conventional Airplane Response-Type (Fig. 20)

These characteristics are associated with conventional unaugmented airplanes, and the reader is referred to any classic stability and control text for a discussion of the

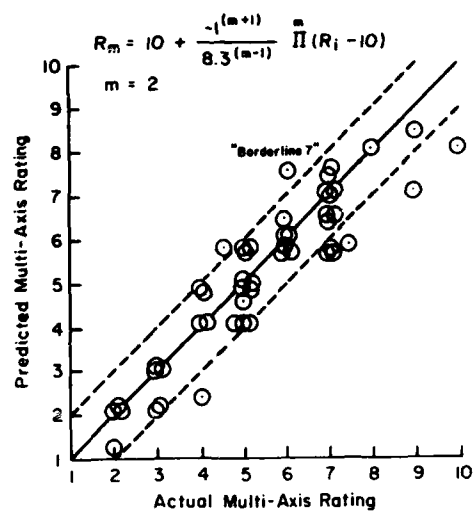
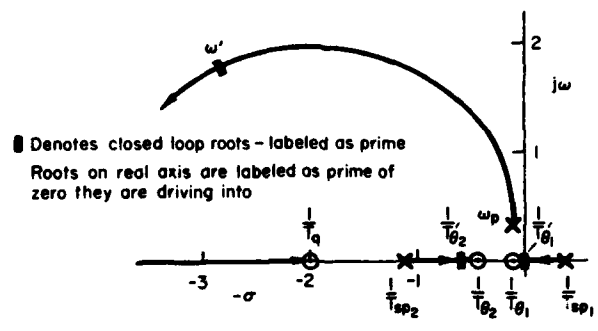
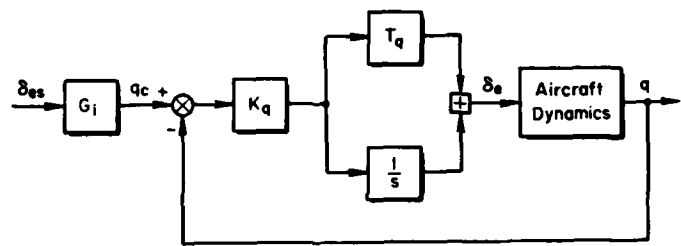

Figure 18. Comparison of STI Product Rule to Actual Single and Multi-Axis Pilot Rating Data (Fixed Base Simulation)



For $G_i = K$:

$$\frac{q}{q_c} = \frac{K_q T_q M_{\delta_e} (1/T_{\theta_1})(1/T_{\theta_2})(1/T_q)}{(1/T_{\theta_1}')(1/T_{\theta_2}') [\zeta' \omega']]} \approx \frac{K_q T_q M_{\delta_e} (1/T_q)}{[\zeta' \omega']]} \approx \frac{K_q T_q M_{\delta_e}}{(1/T_q)}$$

Shorthand Notation: $(1/T) \Rightarrow (s + 1/T)$

$$[\zeta \omega] \Rightarrow s^2 + 2\zeta\omega s + \omega^2$$

Figure 19. Generic Loop Closure Characteristics

5-18

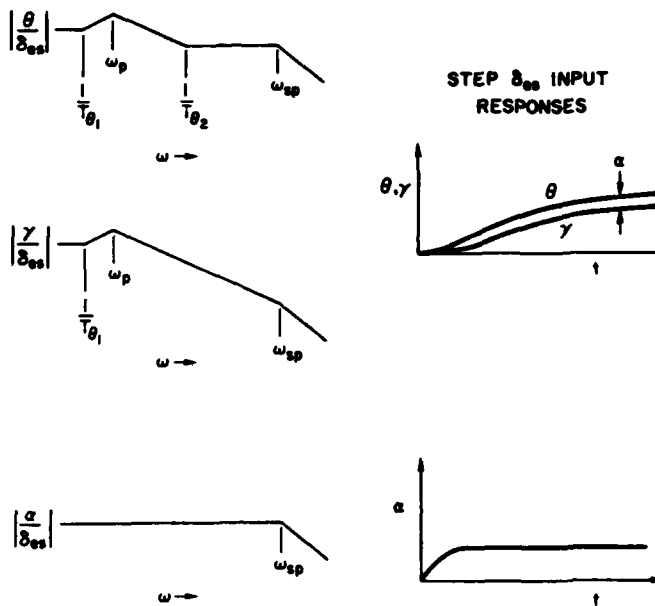

Figure 20. Generic Characteristics of Conventional Airplane Response-Type (Equivalent Systems Valid for this Response-Type) ($q + \alpha \rightarrow \delta_e$)

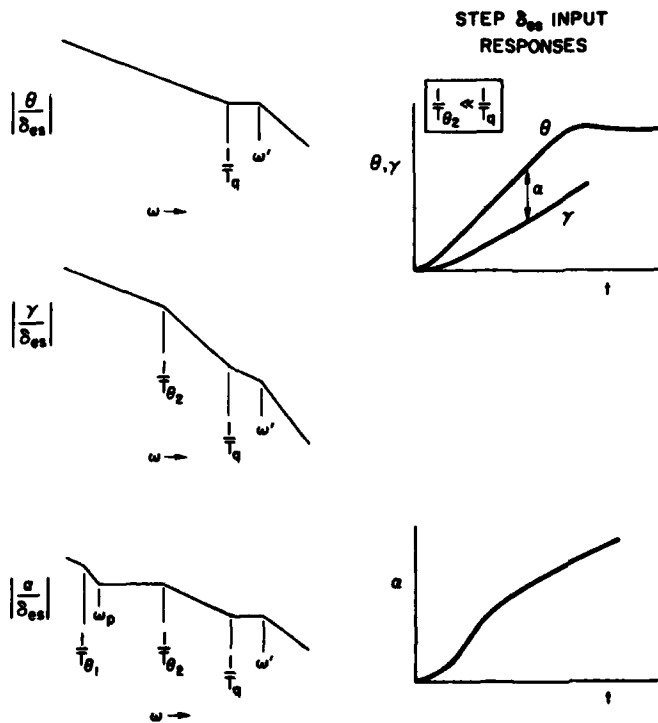

Figure 21. Generic Characteristics of Rate Command/Attitude Hold Response-Type (RCAH) ($q + f_{qd} \rightarrow \delta_e$)

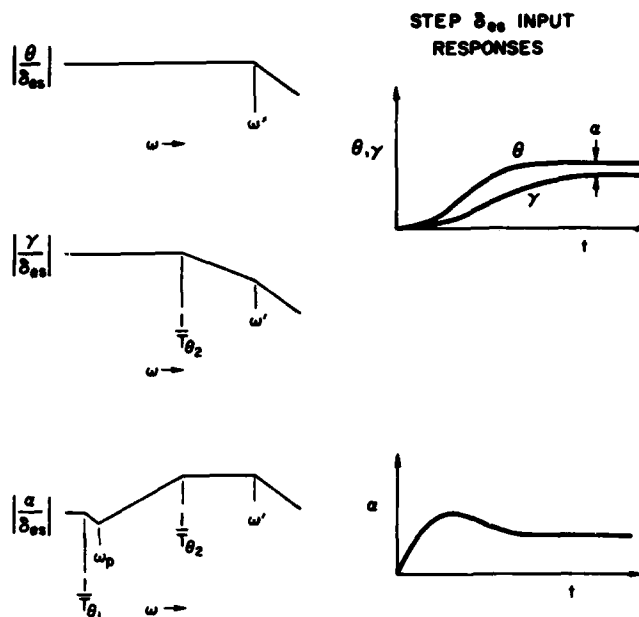

Figure 22. Generic Characteristics of Attitude Command/Attitude Hold Response-Type (ACAH) ($\theta + \delta_e$)

short period, and phugoid modes etc (e.g., Refs. 18 and 19). It is possible to achieve a Conventional-Airplane Response-Type from any configuration by feeding back pitch-rate and angle-of-attack, assuming adequate elevator control power. There are several important observations to be made from Fig. 20 regarding the generic characteristics of this Response-Type in terms of the flare and landing task.

- The flight path-to-elevator Bode plot is K/s over a long stretch between the phugoid mode and the short period mode.
- The angle-of-attack-to-elevator Bode plot is a constant amplitude at all frequencies below the short period frequency.
- The flat region of the pitch-attitude-to-elevator Bode between $1/T_{\theta_2}$ and ω_{sp} leads to pitch-rate overshoot in the time domain (to a step elevator input). The longer this flat region, the more the pitch rate overshoot.
- The flight path response lags the attitude response by 90 degrees at frequencies much above $1/T_{\theta_2}$, and is in phase with the attitude response at frequencies much below $1/T_{\theta_2}$. The following approximation applies.

$$\frac{\gamma}{\theta} = \frac{1}{T_{\theta_2}s + 1}$$

The parameter $1/T_{\theta_2}$ is directly dependent on the aircraft lift-curve slope, C_{L_α} , and is related to the CAP specification parameter n/a as follows.

$$\frac{n}{a} = \frac{U_0}{g} \frac{1}{T_{\theta_2}}$$

A low value of $1/T_{\theta_2}$ will lead to a large lag between θ and γ . The flight path-to-stick Bode plot is not affected by $1/T_{\theta_2}$ because pitch rate overshoot increases exactly proportional to a decrease in $1/T_{\theta_2}$. This fortuitous occurrence is a result of the above mentioned flat stretch between $1/T_{\theta_2}$ and ω_{sp} in the attitude transfer function (Fig. 20). Notice that this region is increased as $1/T_{\theta_2}$ is decreased, resulting in a compensating effect (i.e., the lack of flight path response to an attitude change, is exactly compensated by a more rapid initial attitude response. As will be shown later, this characteristic is unique to the Conventional-Airplane Response-Type.

There has been strong ongoing debate regarding pitch-rate overshoot for good flying qualities, some insisting that it is necessary, others are equally adamant that it is not. The characteristics discussed above indicate that the need for pitch-rate overshoot depends on the magnitude of $1/T_{\theta_2}$. A more fundamental and direct approach would be to concentrate on the need for a K/s gamma-to-stick frequency response in the region of piloted crossover.

It is important to understand that a "K/s response" implies that two conditions must be satisfied, 1) the amplitude plot should have a slope of -20 dB/decade, and 2) the phase should be -90 degrees. An excellent way to determine the extent of the region of "K/s" is to note where the phase curve departs from approximately -90 degrees. It is also important to note that the crossover model predicts equally good pilot ratings for a pure gain controlled element in a continuous tracking task (Ref. 15).

Problems can arise when we attempt to utilize criterion boundaries based on conventional airplane data (i.e., CAP), to predict the flying qualities of highly augmented airplanes (via LOES), when the Response-Type is not Conventional-Airplane. Examples of two such Response-Types are discussed below.

2. Rate-Command-Attitude-Hold (RCAH) Response-Type (Fig. 21)

The important differences between the Classical-Airplane and the RCAH Response-Types for the precision flare are summarized below (Refer to Figs. 20 and 21).

- The flat region of the attitude-to-stick Bode plot is no longer defined by the lift curve slope (i.e., $1/T_{\theta_2}$), but by the augmentation zero $1/T_q$, see Fig. 21).
- The gamma-to-stick Bode plot changes from K/s to K/s^2 (between $1/T_{\theta_2}$ and $1/T_q$). Since the flare maneuver involves control of gamma, we would expect poor flying qualities if $1/T_q \gg 1/T_{\theta_2}$.
- The angle-of-attack time response to a step stick input looks like a step if gamma-to-stick is K/s (Conventional-Airplane), and like a ramp if it is K/s^2 (RCAH). Hence the shape of the alpha time response is a clue to the shape of the gamma-to-stick bode plot in the region of crossover.

Given that the fundamental pitch attitude and flight path responses are significantly different for the Conventional-Airplane and RCAH Response-Types, it is not appropriate to apply the CAP criterion, and therefore LOES, to RCAH. Unfortunately, this is commonly done (the author is among the guilty!). Note that if $1/T_{\theta_2}$ is approximately equal to $1/T_q$ the Response-Type becomes Conventional-Airplane, so in some cases we have been lucky. In other cases, the correlations have been successful in spite of using CAP for an RCAH Response-Type, because the problem was primarily due to excessive equivalent time delay, and/or because the equivalent ω_{sp} tends to be low in spite of the poor match.

If $1/T_{\theta_2}$ is low, it may not be possible to obtain a sufficiently high Bandwidth with pitch-rate feedback alone, while keeping $1/T_{\theta_2} = 1/T_q$ (recall that omega-prime circles $1/T_q$, see Fig. 19). In such a case, angle-of-attack feedback may be employed to further increase omega-prime while retaining the Conventional-Airplane Response-Type. An alternative is to use ACAH as discussed below.

Since, in general for RCAH augmentation, $1/T_q$ is not approximately equal to $1/T_{\theta_2}$, we have chosen to label the Response-Type RCAH for all cases where the response has the generic characteristics of Fig. 21 and $1/T_q \gg 1/T_{\theta_2}$.

3. Attitude-Command-Attitude-Hold (ACAH) Response-Type (Fig. 22)

The generic characteristics of the ACAH Response-Type are seen to be dramatically different from Conventional-Airplane, or RCAH. As the name would imply, the attitude-to-stick Bode plot is constant out to the "dominant mode", ω' , see Fig. 22. The gamma-to-stick Bode plot has the desired K/s above $1/T_{\theta_2}$ and K below $1/T_{\theta_2}$. The response is clearly non-conventional, and a LOES approach to define parameters to plot on the CAP boundaries would not be appropriate.

The shape of the angle-of-attack time response is a step, with some overshoot. This is convenient in that it is possible to determine if the gamma-to-stick Bode plot has the "right shape" from an examination of the alpha time history to a step stick input. Note that the ACAH Response-Type has more phase margin in gamma-to-stick at frequencies below $1/T_{\theta_2}$ than RCAH or Conventional-Airplane, and hence might be expected to be the best Response-Type for this task. The data presented in the following section do indeed support such a conclusion.

⁵Of course the phugoid mode may be completely suppressed due to the pitch-rate feedback which is not characteristic of a "conventional airplane." Since the phugoid has no impact on fully attended tracking tasks, the Response-Type label refers to the higher frequency dynamics.

4. Data Correlations for Precision Flare and Touchdown

Flight tests to investigate flying qualities for flare and landing have been conducted using the USAF Total Inflight Simulator (TIFS), see Ref. 20. Each of the three Response-Types discussed above were tested. The results are summarized in Fig. 23, in terms of Cooper Harper Pilot Rating vs pitch attitude Bandwidth as defined in Fig. 7. Figure 23a indicates that satisfactory pilot ratings cannot be obtained for any tested value of attitude Bandwidth for the RCAH Response-Type and no trends are apparent. A definite correlation of attitude Bandwidth and pilot rating is seen to exist for the Conventional-Airplane Response-Type, and a minimum value of 2.5 rad/sec is indicated for Level 1 (Fig. 23b). This value is consistent with previous data correlations, e.g., see Fig. 14. Finally, the ACAH Response-Type is seen to yield consistently good pilot ratings down to an attitude Bandwidth of 1.5 rad/sec (Fig. 24c). This is not surprising considering the excellent flight path characteristics of this Response-Type (see Fig. 22). This point is further illustrated in Fig. 24. Here four configurations are shown which had essentially identical Bandwidth and phase delay, but the Response-Type was changed from RCAH or Conventional-Airplane (with low Bandwidth) to ACAH by inserting a washout prefilter in the command path. The improvement in flying qualities is indeed dramatic. In some cases, the angle-of-attack time history may not be easily characterized as a step or ramp. In these cases it is necessary to revert directly to measurement of the flight path Bandwidth. The data from Ref. 20 is plotted on a grid of flight path vs attitude Bandwidth in Fig. 25, which illustrates the correlation between these parameters for Conventional-Airplane Response-Type (they are both functions of w' as shown in Fig. 20). The RCAH Response-Types are indicated by filled data points, and are seen to exhibit significantly lower flight path Bandwidth and degraded pilot ratings due to the K/s^2 nature of the gamma-to-stick Bode plot. The ACAH Response-Type cases tend to exhibit the highest flight path Bandwidth.

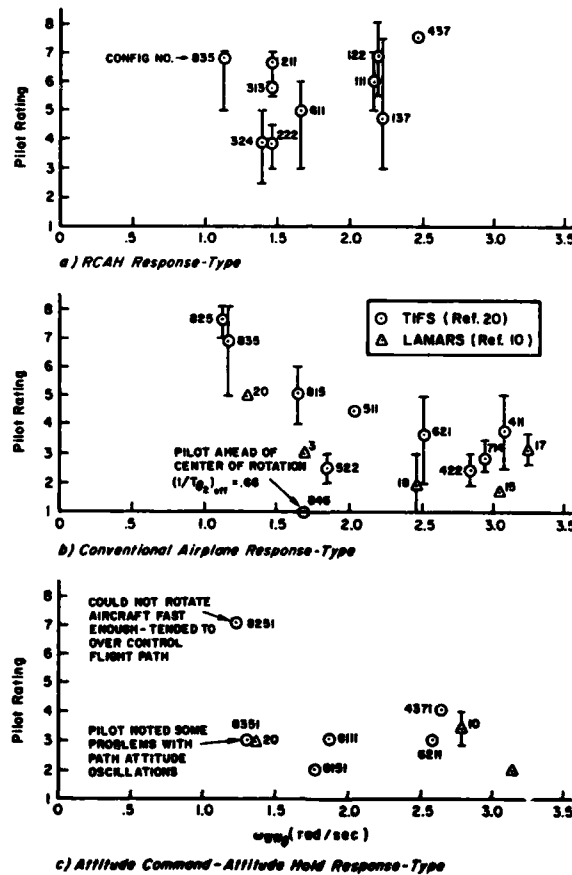

Figure 23. Correlation of w_{θ} with Pilot Rating for Each Response-Type (Ref. 10 and 20 Data)

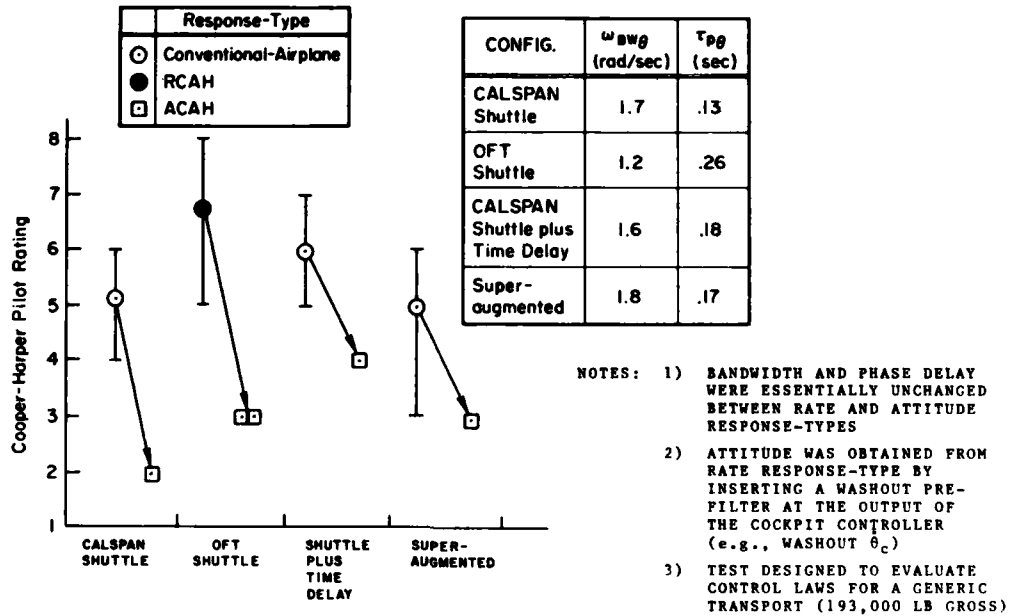

Figure 24. Flight Test Results Showing Effect of Changing From Rate to Attitude Response-Type (TIFS Flared Landing Flight Tests)

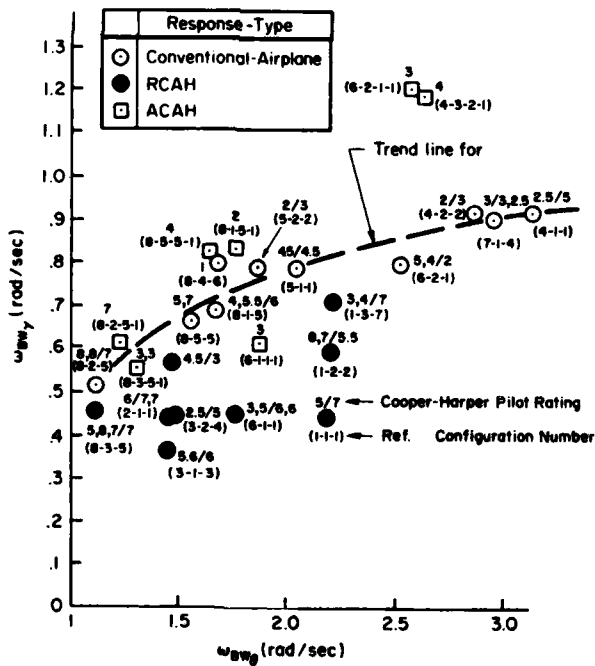

Figure 25. Pilot Rating Correlations with $(1/T_{\theta_2})$ and ω_{wg} Ref. 20 Flared Landing Experiment

The above noted trends were also seen to exist in the STOL precision landing experiment reported in Ref 10. These data are plotted in Fig. 26, and are representative of generic versions of a fighter STOL designed to achieve short field performance via highly precise frontside landings followed by reverse thrust. The Ref. 10 and 20 data are seen to be consistent (compare Figures 25 and 26), indicating that the criterion parameters are applicable in general, as opposed to being unique to any one experiment.

5. Proposed Criterion for Precision Flare

In accordance with the above discussions, it is necessary that the Response-Type be Conventional-Airplane, or ACAH. Note that a RCAF SCAS with $1/T_q$ approximately equal to $1/T_0$, is defined here as a Conventional-Airplane Response-Type. The phugoid mode may or may not be representative of a conventional unaugmented airplane, but that is of little consequence for the flare maneuver, and therefore is not a consideration in the Response-Type definition for this task. In the design stages, the Response-Type and Bandwidth values are simply determined directly from the attitude and flight path-to-stick Bode plots. However, for flight test verification, it is necessary to accomplish frequency sweeps to obtain the required information (via Fast Fourier Transforms). In most cases, it is possible to use the above noted relationship between the angle-of-attack response to a step stick input and γ/δ_0 to insure that it is not a ramp. In the event that it is not clear if the alpha response is a step or ramp, a frequency sweep must be performed to insure that the gamma-to-stick Bode plot is K/s in the region of piloted crossover. Data correlations indicate that a flight path Bandwidth of greater than 0.80 rad/sec provides reasonable assurance of an adequate region of K/s.

If it is determined that the Response-Type is Conventional-Airplane, the LOES criterion (based on CAP) can be utilized. If the Response-Type is RCAF, the aircraft fails the criterion. The BANDwidth criterion can be used for either the Conventional Airplane or ACAH Response-Types.

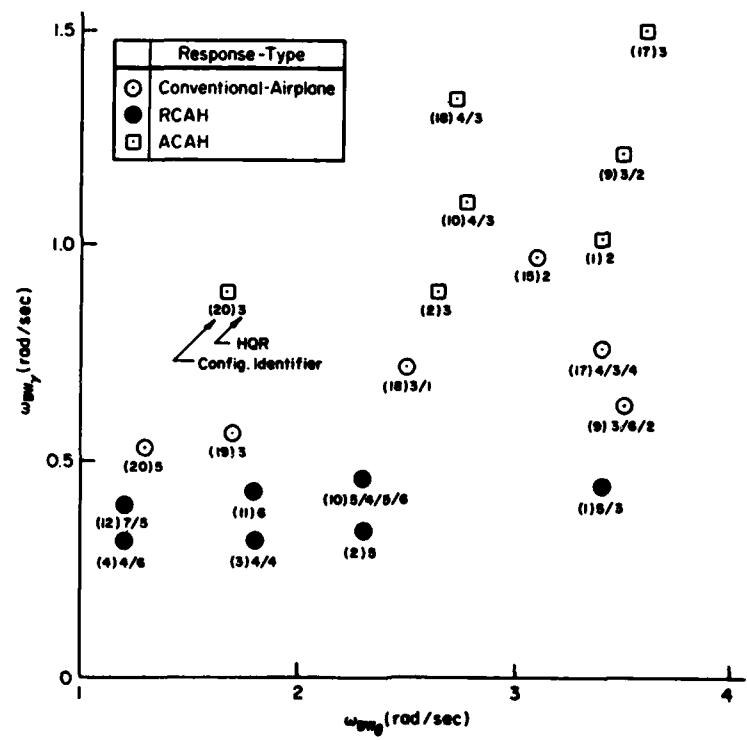

Figure 26. Fighter STOL Simulation Data (LANARS) for Precision Landings -- Ref. 10

Good direct control of the flight path vector assumes that attitude control is not a problem, and can be essentially ignored by the pilot. This is assured by requiring an attitude Bandwidth of at least 2.5 rad/sec. The final criterion is given in Fig. 27. Note that it includes a minimum value of the achievable ratio of flight path-to-attitude change to insure that sufficient energy exists to modify the flight path vector. The minimum values for $\Delta\gamma_{max}/\Delta\theta_{ss}$ are obtained from flight data generated by NASA Ames (see Ref. 10). An application of this criterion to a modern highly augmented fighter aircraft is given in the following example.

6. Example Application to Highly Augmented Fighter Aircraft

Some years ago there was considerable controversy over the flying qualities of a highly augmented fighter aircraft with regards to its flare and landing characteristics. Most pilots who flew the aircraft had problems learning to land it, and most admit that consistent good landings continue to remain an elusive goal. The strategy generally evolved has been not to "tease it" and accept whatever touchdown dispersions that might occur from an off nominal approach. Not exactly a shining example of our modern flight control system expertise! Let us briefly explore how the proper application of the Mil-Prime specification criteria not only exposes the problem, but indicates possible root causes when cast in the format proposed above.

- PITCH ATTITUDE DYNAMICS

- $\omega_{BW\theta} \geq 2.5 \text{ RAD/SEC}$

- $\tau_p \leq 100 \text{ MS}$

- FLIGHT PATH RESPONSE

- SHORT TERM α RESPONSE TO STEP δ_{es} IS A STEP --
 - HAS ZERO SLOPE BEFORE $t = 5 \text{ SEC}$

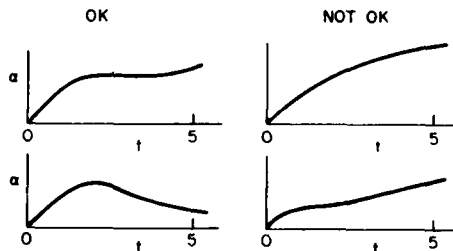

- IF SHORT TERM α IS NOT A STEP, OR IS QUESTIONABLE

- $\omega_{BW\gamma} \geq 0.80 \text{ rad/sec}$

- ENERGY TO FLARE

- $\left. \begin{array}{l} \Delta\gamma_{max} \\ \Delta\theta_{ss} \end{array} \right\} \geq 0.70 \text{ Level 1}$
 - $\geq 0.50 \text{ Level 2}$

Figure 27. Proposed Criteria for Precision Landing

A simplified block diagram of the flight control system is given in Fig. 28. A locus of the characteristic roots as the loop gain is increased is shown, and the filled boxes represent the final closed loop roots selected by the manufacturer. One approach to specification compliance (albeit incorrect) would be to interpret ω_1 as the short period frequency, and to plot it on the CAP boundaries as shown in Fig. 29. This would predict satisfactory flying qualities. However if we invoke the methodology presented above, the following factors become apparent.

- The SCAS results in a RCAR Response-Type by virtue of the fact that $1/T_q \gg 1/T_{\theta}$, (4.6 vs. .59 respectively) resulting in a K/s^2 gamma to delta transfer function. As noted above this is not an appropriate Response-Type for flare and landing.
- The attitude Bandwidth and phase delay is in the Level 3 region (Fig. 30).

The angle-of-attack time history following a step stick input is a ramp, as expected when $1/T_q \gg 1/T_{\theta}$, (Fig. 31). Finally, the flight path Bandwidth is 0.44 rad/sec, which is considerably less than the required 0.80 in the Fig. 27 requirement.

It is not surprising that the aircraft is difficult to land. An appropriate fix would be to lower the gain on the parallel integrator so that $1/T_q = 1/T_{\theta}$. This would provide a Conventional-Airplane Response-Type. However, the necessary Bandwidth may not be achievable with this reduced integrator gain, necessitating additional feedbacks (such as normal acceleration or angle-of-attack). In fact, the operational version of the aircraft does have angle-of-attack feedback, but the integrator gain remains unchanged!

Suppose, for the moment, we do not recognize the fact that this SCAS results in a non-Conventional-Airplane Response-Type, and apply the LOES criterion from the Mil-Prime Standard (albeit incorrectly according to the underlying first principles). The resulting match is shown in Fig. 32, and is seen to be less than impressive. However, the criterion still is able to correctly predict an excessively sluggish response (see Fig. 29), and exhibits excessive equivalent time delay. This result is not uncommon, and while it is fortuitous in many ways, the undesirable effect is to instill the concept that LOES works in general. Habitual application of the LOES criterion without regard to Response-Type will probably work in most RCAR cases, but is asking for trouble, because it is fundamentally incorrect. In terms of control system design, the LOES provides little guidance to indicate that the integrator gain is adversely affecting the flight path response.

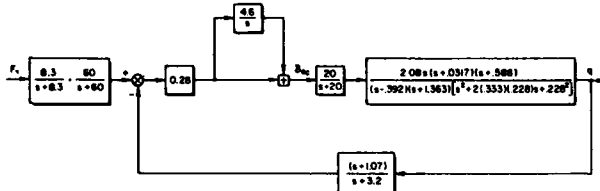

a) Pitch Rate Feedback Block Diagram

$$\Delta' = \Delta + G_q N_{\delta}^q = (-.392)(1.36)[.333, .228] + \frac{2.08 K_q (0)(.032)(.588)(1.07)(4.6)}{(0)(3.2)}$$

$$\Delta' = \frac{(.014)[.85, .90][.89, 2.55]}{(0)(3.2)}$$

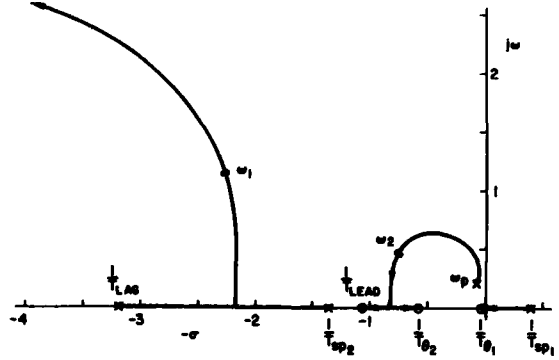

b) $q - \delta_p$ Feedback

Figure 28. Examples of Augmentation for a Current Fighter Aircraft

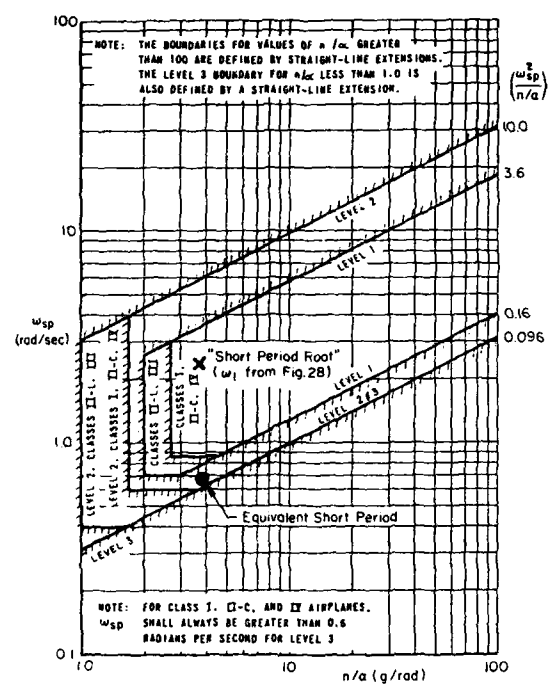

Figure 29. Short-Period Frequency Requirements -- Category C Flight Phases

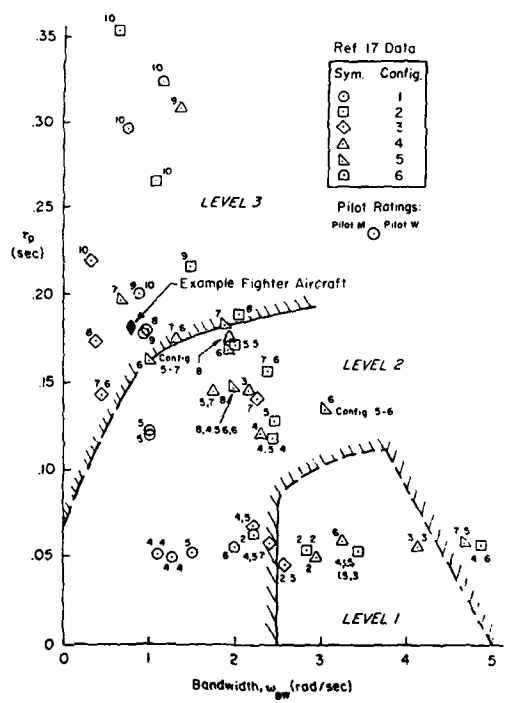

Figure 30. Example Aircraft Predicted to be Level 3 for Flare and Landing

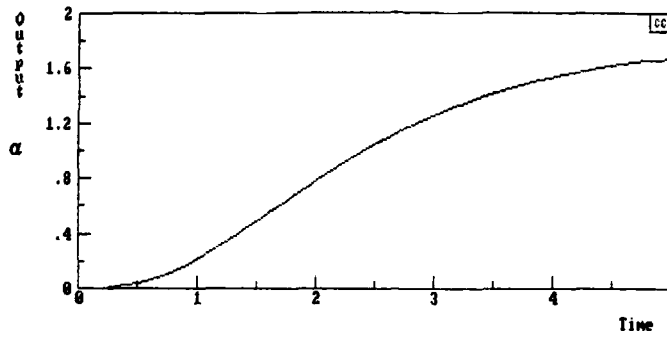

Figure 31. Angle of Attack Response to Step Steel Input for Example Aircraft

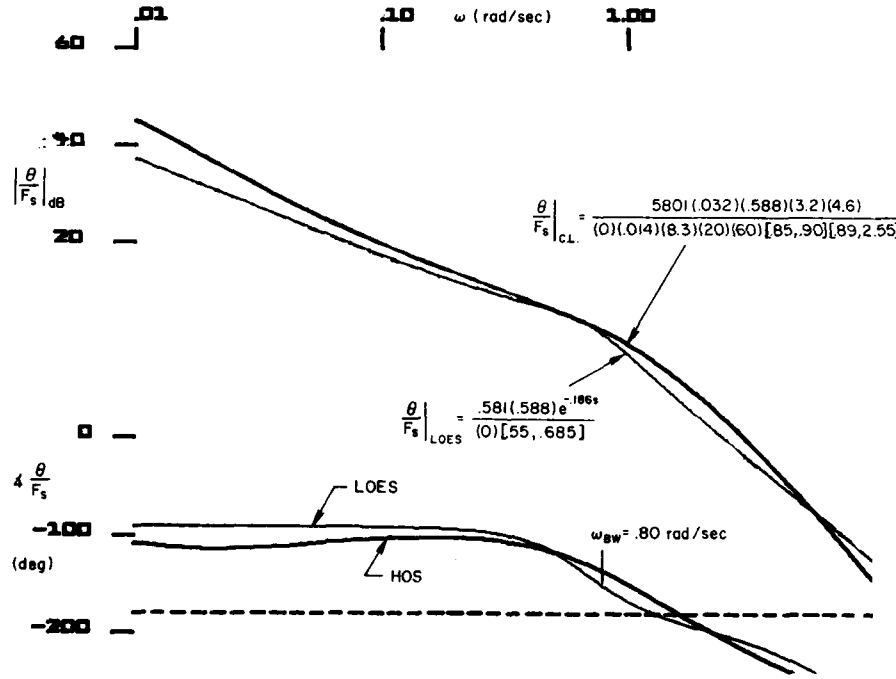

Figure 32. Lower Order Equivalent System Match for Example Aircraft

REFERENCES

1. Military Specification, Flying Qualities of Piloted Airplanes, MIL-F-8785C, Nov. 1980.
2. Hoh, R. H., D. G. Mitchell, I. L. Ashkenas, et al, Proposed MIL Standard and Handbook -- Flying Qualities of Air Vehicles, AFWAL-TR-82-3081, Vol. II, July 1982.
3. Military Standard, Flying Qualities of Piloted Vehicles, MIL-Std-1797 (USAF) Mar. 1987.
4. Military Specification, Flying Qualities of Piloted V/STOL Aircraft, MIL-F-83300, Dec. 1970.
5. Hoh, R. H., and D. G. Mitchell, Proposed Revisions to MIL-F-83300 V/STOL Flying Qualities Specification, Report No. NADC-82146-60, Warminster, PA, Jan. 1986.
6. Hoh, R. H., and D. G. Mitchell, Proposed Handling Qualities Specification for Military Rotorcraft, Vol. I, Requirements U.S. Army AVSCOM, TR-87-A-4,
7. Key, D. L., and R. H. Hoh, "New Handling-Qualities Requirements and How They Can Be Met," American Helicopter Society's 43rd Annual National Forum, St. Louis, MO, May 1987.
8. Hoh, R. H., D. G. Mitchell, I. L. Ashkenas, et al, Background Information and User's Guide for Proposed Handling Qualities Requirements for Military Rotorcraft, STI Technical Report No. 1194-3, Dec. 1985.
9. Hoh, R. H., "Handling Qualities Criterion for Very Low Visibility Rotorcraft NOE Operations," AGARD No. CP-423,
10. Hoh, R. H., and D. G. Mitchell, STOL Handling Qualities Criteria for Precision Landings, AFWAL-TR-83-3050, Nov. 1986.
11. Hoh, R. H., D. G. Mitchell, and S. R. Sturmer, "Handling Qualities Criteria for STOL Landings," 1987 National Aerospace and Electronics Conference, Dayton, Ohio, STI Paper No. 407, May 1987.
12. Neal, T. P., and R. E. Smith, An In-Flight Investigation to Develop Control System Design Criteria for Fighter Airplanes, AFFDL-TR-70-74, Vol. 1, Dec. 1970.
13. Hoh, R. H., T. T. Myers, I. L. Ashkenas, et al, Development of Handling Quality Criteria for Aircraft with Independent Control of Six Degrees of Freedom, AFWAL-TR-81-3027, Apr. 1981.
14. Wood, J. R., and J. Hodgkinson, Definition of Acceptable Levels of Mismatch for Equivalent Systems of Augmented Aircraft, MDC Rept. A6792, Dec. 1980.
15. McRuer, D. T., and E. S. Krendel, Mathematical Models of Human Pilot Behavior, AGARDograph No. 188,
16. Moolj, H. A., "Criteria for Low-Speed Longitudinal Handling Qualities of Transport Aircraft with Closed-Loop Flight Control Systems," National Aerospace Laboratory NLR, Amsterdam, Sept. 1984.
17. Smith, R. E., Effects of Control System Dynamics on Fighter Approach and Landing Longitudinal Flying Qualities (Vol. I), AFFDL-TR-78-122, Mar. 1978.
18. McRuer, D. T., I. L. Ashkenas, and D. Graham, Aircraft Dynamics and Automatic Control, Princeton University Press, 1973.
19. Etkin, B., Dynamics of Flight, New York, Wiley, 1959.
20. Berthe, C. J., C. R. Chalk, and S. Sarrafian, Pitch Rate Flight Control Systems in the Flared Landing Task and Design Criteria Development, NASA CR-172496, Oct. 1984.

A SECOND LOOK AT MIL PRIME FLYING QUALITIES REQUIREMENTS

Robert J. Woodcock
 Principal Scientist, Control Dynamics Branch
 Air Force Wright Aeronautical Laboratories
 Wright-Patterson AFB OH 45433-6553, USA

SUMMARY

This presentation addresses current and projected applications of flying qualities criteria, rather than their research and development. We will discuss the current state of the art, its deficiencies, and needs for further work.

The rationale for the new US Military Standard and Handbook on flying qualities is briefly discussed. With advanced vehicles, the scope of flying qualities is expanding, opening new areas to investigate and creating new problems.

With relaxed static stability now commonly used, control margin is a prime safety consideration: control must be available for stabilization, maneuvering and recovery from any possible attitude, as well as for trim.

Flying qualities aspects of agility include the need for nonlinear flying qualities metrics, and control systems that provide both rapid maneuvering and good damping for tight tracking. For all-aspect engagement, the pilot needs to be thoroughly integrated with displays, automatic flight control modes and other systems.

For dynamic longitudinal flying qualities, MIL-STD-1797 presents the Control Anticipation Parameter (CAP) of an equivalent classical system as a primary criterion, but gives several alternatives in recognition of problems, and research continues.

INTRODUCTION

The US military flying qualities requirements are in a new document, Military Standard 1797 (USAF)¹, which at this writing is in the process of coordination among the US Air Force, Army and Navy. For Air Force use, the original issue is dated 31 March 1987, replacing MIL-F-8785C². Its most striking feature is its size: the standard and a voluminous handbook are published as one 700-page volume. A two-volume draft³ prepared by Systems Technology, Inc (STI) under contract was extensively modified prior to publication, with input from many sources in the US and Europe. At present, distribution is limited to the Department of Defense and its contractors only, because the handbook's "lessons learned" include some characteristics of our newest combat aircraft. By the time of these lectures, we plan to have a "sanitized" version available for general distribution.

By itself, the standard is not of much use until its many blanks are filled in. The handbook gives guidance on blank-filling and on application of the requirements. This concept has allowed us to suggest alternatives for cases in which there may be doubt about the right criteria for a particular application. We have kept the same framework (aircraft classes, flight-phase categories, flight envelopes, aircraft states, and flying qualities levels) -- and many of the same requirements, but rearranged by axis, six of them, plus general and combined-axes flying qualities. We have incorporated many of the advances made through research and operational experience in the years since publication of the predecessor specification MIL-F-8785C in 1980.

While we have changed the requirements from those of MIL-F-8785C in many details, generally we have kept the concept of specifying characteristics of aircraft response to open-loop pilot inputs. By law, we cannot specify such parameters as tail size or stability derivatives: these are the province of the designer. What we are really interested in, of course, is not exactly any of those characteristics but, rather, task performance of the pilot and vehicle in concert, plus pilot workload. These are the two recognized components of flying qualities⁴. Pilots, being adaptable, can maintain good task performance for a wide range of vehicle characteristics at the expense of increased effort and concentration on flying.

Unfortunately, performance and workload are not yet measurable precisely enough for direct specification of handling qualities. With limited time and funds, flight testing emphasizes operationally-oriented maneuvers. Capitalizing on this, the Air Force Flight Test Center's Handling Qualities During Tracking (HQDT)⁵ has proved exceptionally useful in uncovering handling difficulties. System identification techniques allow determination of many specification parameters, and stability derivatives too, from the HQDT data. Run-to-run variation and the lack of adequate workload measures, however, render performance in these maneuvers unsuitable for design specification. Still, we need more standardized maneuvers and performance criteria, related to operational tasks, to guide simulator and flight-test evaluations.

6-2

As other speakers have alluded, pilot modeling can furnish valuable insights. We can foresee the day when the specification may be an analytical pilot model with adaptation rules and a workload or excess-capacity measure. Acceptance of that form of specification, however, has been slow in coming. We therefore continue to rely on correlations of pilot ratings and comments with aircraft characteristics, guided by pilot-vehicle analysis, supplemented by experience in aircraft development and operation.

For the most part, the Mil Standard also continues to state criteria in terms of classical responses: static speed and sideslip stability, short-period and dutch-roll frequency and damping, etc. It does not answer the question of how to obtain these characteristics, that being the job of the designer. The data base is almost entirely for piloted control in conventional maneuvers. We have only begun to consider the altered responses of highly augmented aircraft (although equivalent classical response parameters can often be found), and we have yet to address criteria for combined piloted and automated flight. These considerations, which are upon us, are some of the most urgent challenges for further research.

Analysis and simulation are even more important to the formulation of criteria for advanced aircraft, which not only will incorporate a high degree of stability and control augmentation to compensate for relaxed static stability in pitch and possibly yaw, but also will need:

- * Increased agility, including air-combat maneuvering near and beyond stall
- * Aircraft response tailored to particular tasks
- * Greater reliance on displays for rapid, precise maneuvering
- * Automated and semi-automated modes integrating propulsion, fire control, short-term guidance, etc modes with flight control
- * Artificial intelligence to aid and advise the pilot
- * Automatic restructuring and self-repair to make the best possible use of remaining system components after failure or damage

for much more demanding missions in a very complex environment, taxing pilot workload to maintain situation awareness.

One problem we have noted in application of the flying qualities requirements to aircraft design arises from the increased sophistication of flight control system design. While we have stated the criteria in terms felt to be meaningful to pilots and airframe designers, many flight control system designers have not found them so. One factor is experience that stability and control augmentation has at times resulted in nonclassical aircraft response. Thus a feeling arose that the requirements just weren't applicable to the case at hand. Also, despite our early efforts, flight control designers found it difficult to incorporate the flying qualities criteria into optimization techniques, and so used other criteria instead. Several resulting poor designs had to be modified, at considerable cost, after initial flight testing.

Our next response, in order to make the most of the existing data base, was to apply the requirements to an equivalent classical aircraft, matching the two responses as well as possible over the frequency or time range of principal interest^{6, 2}. We found the equivalent system approach to work remarkably well, but still not universally. We will discuss some later research results and new criteria. A current project is to develop viable multivariable, computer-aided flight control design techniques which adequately account for flying qualities. Increasingly, we feel the urgency of good interdisciplinary teamwork.

CONTROL MARGIN

Instability has been a perennial problem for manned flight. Since the need to balance stability against controllability is still very much with us, some background seems in order. The Wright brothers purposely made their early airplanes unstable so that they could be maneuvered, rather than concentrating on a high degree of stability, as was the practice of their predecessors (except Lilienthal) and contemporaries⁷. This made manned, fully controlled flight possible -- but just barely: not until the instability was drastically reduced or eliminated could the Wrights make their Flyers refrain from bobbing around continually as the pilot concentrated on maintaining control. Root⁸ recounts that in 1904, "when fifty pounds of iron was fastened to its nose, it came down to a tolerably straight line and carried its burden with ease"; and Lieutenant (later General) Foulis, the first military airplane pilot, found⁹ that:

Old Number One... with its two elevators out in front, was about as stable as a bucking bronco... When one of the elevators up front was moved around to the back, stability improved somewhat, but not enough. I later found that by using just one elevator, the rear one, I had a platform that worked very well. I could let go of the levers and make notes and sketches. It got to be an airplane that could be used for real military reconnaissance.

Nevertheless, as recounted in many sources, for example Reference 10, instabilities remained common in fighter aircraft of World War I.

With such instability, just hanging on, keeping the airplane under control, could be a challenge. But a British investigation in 1919¹¹ of a series of accidents found another potential for disaster. A mark of static stability is that the control to stabilize at a new equilibrium point is in the same direction as the control to initiate the change; but for the unstable case, a control reversal is required. Control to recover an unstable vehicle, then, is in the same direction as control to trim. Figure 1 shows this concept applied in an investigation into the loss of 13 "A" aeroplanes. In a half-looping recovery from inverted flight, insufficient nose-up elevator control deflection was left to pull out. While the maneuver cited was a poorly executed loop, there are many ways to get into such a fix.

Now, as then, the quest for performance and maneuverability drives designers to minimize stability, even to build in a degree of instability. These days, such handling defects can be corrected by response feedback, so that the pilot sees nothing amiss -- unless his controls saturate or fail. Back in 1913, Orville Wright won the Collier Trophy for his demonstration of an angle-of-attack feedback in pitch and a pendulum for roll, pneumatically driving the control surfaces for stabilization. Modern use of stability augmentation dates from the Northrop B-49 yaw damper¹², and has grown into "superaugmentation"¹³. We shall discuss several hazards of over-reliance on the flight control system to compensate for deficiencies of the basic airframe.

Ever since the appearance of swept and low-aspect-ratio wings, pitch-up has been a design problem. This pitch instability near stall is related to entrance of an aft tailplane into the core of the wing's downwash field as angle of attack increases; wing sweep, low aspect ratio, vortices trailing from side-mounted engine inlets, wing leading-edge extensions, etc can have major effects^{14, 15}. A later compendium¹⁶ recounts more recent experience with pitch and yaw departures. In order to prevent loss of control, one early fix (on the F-104 and F-101, for example) was a stick pusher which (paradoxically, and to pilots' displeasure) at a predetermined combination of angle of attack and pitch rate, momentarily took control away from the pilot so as to push the nose down.

While most airplanes have a stable stall break, two examples (among others) show that this static stability, post-stall, can itself be a problem when combined with a region of instability at lower angle of attack. Another stable equilibrium point is created, as shown in Figure 2, possibly with no nose-down control moment available to recover. The common decrease in stabilizer effectiveness at these extreme angles compounds the difficulty. Both the BAC 1-11 transport and the F-16 fighter have exhibited a capability to pitch up into a locked-in deep stall, with equilibrium at full nose-down stabilizer; no nose-down moment is available to recover. The F-16's stability augmentation applies the full nose-down command, so the pilot has been given a special switch to negate it so that he can try to rock out of this trap.

Ordinarily, the F-16's stall/g-limiter prevents reaching this state, and maneuvering is "carefree." Generally, however, a limiter can be defeated -- by tricking it in some way, say by losing airspeed in a vertical climb. Also, by its nature, a limiter restricts maneuvering capability. For all maneuvers, control deflection and rate margins must be sufficient for:

- * Stabilization to the specified flying qualities level
- * Limiting aircraft response to sensor and system noise and a specified intensity of atmospheric disturbances
- * Recovery from stall, and from any possible attitude or gyration.

Table I, based on material in Reference 17, lists simple approximations for some of the control margins necessary to avoid saturation. Figure 3 illustrates the control action for stability augmentation.

Our military engineering organizations insist that these safety-related control margins be provided through aerodynamic control power. Experience to date with current-technology inlets and engines operating at the distortion levels typical of high angle of attack at low speed dictates caution. Considerable uncertainty exists about reliability and dependability of thrust for use to stabilize and control the vehicle. Throttle usage is also a factor: idle thrust may be used to decelerate rapidly.

For a fighter especially, an effective limiter may severely restrict maneuver capability at angles of attack approaching the limit. Even if control limiting is avoided, a typical restriction is a slowing of the pitch response to avoid overshooting the limit. An additional increment of nose-down control margin must be available to counter the pitching moment from nonlinear inertial coupling in roll: as a first cut,

$$\Delta M = \frac{I_x - I_z}{2I_y} p^2 \sin 2\alpha$$

for a roll rate p about the velocity vector, with α measured to the principal x axis. In yaw, stabilization while rolling must counter not only the inertial yawing moment, but also the dutch roll and any "aileron yaw." The several nonlinear inertial terms in the equations of motion make a detailed analysis necessary to determine the motion with any great accuracy; generally, nose-down pitching accentuates this divergent tendency while rolling. For the F-16, which subsonically, unaugmented, is unstable in pitch, the roll and yaw capability at high angle of attack is severely restricted in order to preclude a pitching divergence.

Although we have seen how saturation of control effectors can lead to loss of control, dynamic deflection or rate saturation does not necessarily mean departure from controlled flight. Small amounts of command or stabilization saturation are comparable, in a describing-function sense^{17, 18} (Figure 4), to a reduction in gain. Such behavior will cause flying qualities to deteriorate for large inputs¹⁹, but up to a point will not reduce the response all the way to an instability. Deflection saturation will reduce the low-frequency stability level and the initial response to abrupt commands, while rate saturation will slow the initial response and decrease the high-frequency stability level (Figure 5). For a basically unstable airframe or a system deficient in phase or gain margin, a sufficiently large or rapid control-surface command causes a divergence. For a smaller amount of saturation than that which reduces stability to neutral, pilot opinion will degrade; moreover, the variation in response characteristics with amplitude may itself be objectionable.

The instability boundary can be expressed in terms of (a) the steady-state response to limit deflection or rate and (b) the bare airframe's response ratios for the stable mode^{17, 20}. Figure 6 illustrates such boundaries for the two-degree-of-freedom short-period motion of an aircraft having one unstable root. From the equilibrium point, with controls saturated the motion in the stable mode proceeds along the stable separatrix. For combinations of variables beyond this boundary (which depends only on the unaugmented characteristics, regardless of augmentation) the aircraft cannot be controlled and will diverge. For this simple case, full control deflection gives the equilibrium, or saddle, point:

$$\begin{aligned} \Delta \alpha_{ss} &= U_0 M_\delta (1 - Z_\delta M_q / U_0 M_\delta) \Delta \delta / (Z_\alpha M_q - U_0 M_\alpha) \\ q_{ss} &= -M_\delta (1 - Z_\delta M_\alpha / M_\delta Z_\alpha) \Delta \delta / (M_\alpha - U_0 M_\alpha / Z_\alpha) \end{aligned}$$

and the slope of the stable separatrix is given by:

$$(\Delta q / \Delta \alpha)_s = M_\alpha / (Z_\alpha / U_0 + 1/T_d)$$

where q is pitch rate, $\Delta \alpha$ is angle of attack change from straight flight, $\Delta \delta$ is the incremental control surface deflection, M_α and Z_α are dimensional angular and linear acceleration derivatives, "sub α " represents the subsidence mode and T_d is the (negative) time constant of the divergent mode.

While detailed analysis of such nonlinear behavior is best done in the time domain, this simple concept seems helpful in understanding the problem. Considering the relationship between step and ramp commands, for the corresponding boundaries for rate-saturation stability alone, merely substitute $\dot{\alpha}$ for α , \dot{q} for q , and $\dot{\delta}$ for δ . The slope $\dot{q}/\dot{\alpha}$ is the same as $\Delta q/\Delta \alpha$.

Experience to date has been mostly with the pitch axis; but if the need should arise in the yaw axis, similar considerations apply to an instability there.

Direct feedback of angle of attack, of course, will stabilize an aircraft with relaxed static stability. More commonly, however, pitch rate and normal acceleration are fed back. Since these signals cannot completely stabilize attitude, an integrator path is added to null the error signal in the long term. This mechanization gives rate-command, attitude-hold control. Even for statically stable basic airframes, we find that proportional plus integral control of these variables is often incorporated in order to maintain trim automatically. In normal operation, control is almost conventional (except for the need to push the nose down for landing). But once the control surface saturates, the continued buildup of the error signal can prevent recovery. Figure 7, from Reference 17, illustrates the effect such a runaway integrator can have in a checked pullup, and a solution: to cut out the integrator whenever the control surface saturates.

Near stall, too, the neutral stability obtained with an integrator can be of concern. For added stall protection, the F-16 introduces angle-of-attack feedback at angles of attack above that for approach.

To summarize, flight safety of an unstable airframe requires enough aerodynamic control power to trim aerodynamic and thrust forces at all possible flight conditions and thrust settings, with margins of control authority and rate sufficient for:

- * maneuvering (Command limiters can guard against loss of control, at the expense of decreased maneuverability and agility, if the instability is not too severe)
- * stabilization of the response to commands and disturbances; high damping reduces the control budget for stabilization, but overdamped responses are slower
- * recovery, for example from a stable equilibrium point in a deep stall, or sudden failures including loss of an engine, or upsets or unusual attitudes.

Multiple control surfaces and various disturbances must be taken into account when determining these margins. Maneuvering flaps, load alleviation, store drop or gun firing, and direct side-force control modes are some possibilities.

The size of the design gust determines the degree of risk reduction; a sufficiently large disturbance can still cause an unstable airframe to diverge. A wake vortex encounter, not uncommon in air combat (training or actual) and possible elsewhere, can be very violent; the only recourse may be to assure aircraft integrity and the ability to recover. It is not clear just what combinations of aggressive maneuvering and disturbances are reasonable to consider.

Some margin is also needed for design uncertainties and growth (in weight, center-of-gravity range, additional stores, etc). Several of our current fighter aircraft experienced less than predicted aerodynamic stability because of discrepancies between wind tunnel and flight (F-111, F-16), or overestimated fuselage stiffness (F-15). Reference 17 is of use for early design tradeoffs; but for more detailed design, the adequacy of limited control authority and rate need to be assessed through piloted simulation.

AGILITY

With beyond-visual-range missiles, air combat tactics are changing. All-aspect and off-boresight shots, and defensive and re-attack capabilities demand more than high speed for a head-on, "slashing" attack. Quick pointing, rapid acceleration and deceleration, and good turn capability -- for both sustained turns at high speed and steady turns* with altitude or speed loss -- are needed. Simulations have shown that high roll performance while loaded, and also beyond stall, can significantly improve combat effectiveness. Some uses of agility and design considerations are listed on Table II, from current Northrop work for us.

We are trying to develop new metrics to quantify the requirements, and the Air Force Flight Test Center has an Agility Flight Test Committee investigating methods to test for agility. Some of the metrics bear on "performance," but handling qualities implications are also apparent. Also obvious are some conflicting design requirements and some costs in weight, complexity, engine size, etc. The natural (though unreasonable) desire is to have, without penalty, the most of "all of the above" capabilities. While sustained turn capability continues to be important, we see a growing realization of the significance of steady and instantaneous capability in air combat.

"GLOC" (loss of consciousness with rapid onset of normal acceleration) and pilot disorientation in violent maneuvers have become new flying qualities concerns. Pilots appreciate the AFTI-F-16's automatic dive recovery²¹, but further improvements seem possible.

The present quantitative requirements generally assume a linear system of equations of motion. Through several approaches we are examining large-scale maneuvers which inherently involve nonlinear inertial, kinematic and aerodynamic terms. From expressions occurring in these analyses, we hope to develop meaningful nonlinear flying qualities parameters. Herdman at Virginia Polytechnic Institute has applied Volterra series to a pull-up²² and wing rock. At Honeywell, a dynamic inversion technique²³ has analyzed the controlled and uncontrolled variables in a roll reversal, a barrel roll and a diving turn to suggest flying qualities metrics. STI has classified pertinent flying qualities issues as: aircraft-centered; tactical, task and maneuver-centered; and pilot-centered perceptual or control²⁴. They applied differential geometry to describe a helix and a high-speed yo-yo maneuver, and have suggested Riccati equation theory as a way to analyze "escape" phenomena with even-function nonlinearities. At Eidetics, Skow is attempting to correlate a "roll agility parameter" with increases in mission effectiveness. All of these techniques show promise of providing some suitable metrics, but the work has been of a preliminary nature.

*Some confusion in terminology has been encountered. Here, "sustained" turn capability is thrust-limited in level flight, "steady" refers to maximum steady lift or limit load factor, and "instantaneous" includes dynamic overshoot.

For ground attack, survivability improves as the time of straight flight before bomb release is shortened. The APTI-F-16 has demonstrated good effectiveness with an Automated Maneuvering Attack System (ANAS)²⁵, releasing the store while maneuvering. With the predictive display provided, both manual and automatic deliveries, and pilot corrections during automatic deliveries, were possible. The automatic mode left the pilot more time for other tasks such as making small corrections, looking for threats and controlling airspeed. Similarly, high-angle-off air-to-air gunnery can be made an effective tactic through pilot aids and a degree of automation.

An early draft of MIL-F-8785B specified acceleration/deceleration capability, using speed brakes and engine response. We dropped all but a qualitative requirement because (a) data were insufficient to validate any numbers and (b) we felt we had no control over the engine manufacturers. Experience with different engines in the F-4²⁶ showed a marked deterioration in handling with a slower-responding engine. Since then, we seem to have gotten through to engine manufacturers, and designs are becoming more integrated; but still we have neither a quantitative requirement nor a sufficient data base. The in-flight thrust reversing being considered for advanced fighters' rapid deceleration adds significant weight, which demands more thrust and a larger wing for the same sustained turn capability.

Provision of adequate roll control has always been a design problem. It has been difficult enough just to get people to think in terms of dynamic roll performance, time to bank rather than steady roll rate or pb/2V. Although the need is to bank and stop, that demonstration maneuver is very hard to do precisely; so our criterion calls for rolling through the angle. Since we have had examples of roll dampers mechanized to change the roll time constant when the stick is deflected, perhaps we should reexamine that form. We have also observed that overly sensitive control or a very short time constant can cause "roll ratcheting" with the pilot in the loop²⁷. In the development of MIL-F-8785B, analytical studies showed no particular benefit of rolling through as much as 90 or 100 degrees in one second. Experienced fighter pilots, however, insisted on keeping such a requirement. In MIL-F-8785C, and continuing in MIL-STD-1797, we have reemphasized loaded rolls (at higher normal load factors) as well as 1-g rolls.

Simulator studies have shown a decided air-combat benefit of good roll capability at high angles of attack. Such roll performance is hard to achieve, however. Even at low angles of attack, good fighter roll capability calls for large control surfaces and extra wing structural weight. Roll performance naturally tends to fall off at low speed (the roll-mode time constant varies inversely with speed, while pb/2V is invariant). At high angle of attack, moreover, roll controls tend to produce significant yawing moments; either adverse or favorable yaw can be troublesome. A greater challenge is to find a way to avoid pitch and yaw departures due to inertial roll coupling without seriously restricting roll performance. At even higher angles of attack, beyond stall, rolling about the velocity vector requires more yawing than rolling from body-axis-oriented control effectors; and less effective aerodynamic controls must be supplemented with thrust vectoring or other reaction controls.

Presently, no particular roll axis is specified. The best axis will depend on the task, and possibly on the configuration as well. Most generally, a desire to minimize sideslip would place the roll axis along the flight path. For gunnery, however, a roll axis above the reticle causes an initial reverse movement of the reticle when rolling onto a target; in that case, rolling about the sight axis or the gun line seems best. Roll-control and roll-rate inputs to the rudder can adjust the roll-axis orientation*. At high angles of attack, a pilot located above a flight-path roll axis will get large lateral acceleration in abrupt rolling maneuvers; and during a roll, he will see the nose slew with respect to an outside reference. Of course, if direct side-force control is available, the roll axis can be moved up to the cockpit, still parallel to the flight path. An overriding consideration may be to orient the roll axis to minimize inertial coupling, making more rapid rolls feasible without losing control. This too could induce design penalties for larger, more effective directional control surfaces.

The Dutch roll requirements are fairly adequate for general flying, but have been found deficient for aggressive, precise maneuvering as in target acquisition. Higher damping (around 0.7 critical) than required helps fine tracking, but it also slows the response during rapid maneuvering. For the A-10, a derived sideslip-rate feedback now allows both good damping and rapid response for rapid, highly predictable alignment in weapon delivery. The experimental DIGITAC A-7D incorporates this and a nonlinear yaw damper. Pilots also have appreciated nonlinear pitch damping on RAE's experimental Hunter and our APTI-F-16 for agility plus good damping for fine tracking. These aircraft, however, being point designs, have not furnished sufficient data to write a general requirement. With quick, accurate response to large-amplitude commands plus inherently excellent fine tracking capability, integration of flight and fire-control systems is eased, or the need for automation reduced.

*A caution: with pu fed to the rudder to induce roll about the stability axis, one fighter experienced auto-rolls when inverted.

MIL-STD-1797 makes provision for direct force control, but criteria are minimal. In AF71-F-16 experience, practical amounts of heave control gave only a small improvement in capability (although automation of fire control modes, such as point-and-shoot, might prove more fruitful). The major benefits were in ride qualities and in quickening the normal-acceleration response to pitch control. Laterally, direct force control was found useful in a wings-level turn mode for making corrections during tracking. Moh's bandwidth criterion was first derived for such applications, in which a more-or-less universally applicable criterion is needed for a broad range of yet-poorly-defined uses. In practice, the utility of direct force controls must be balanced against their added drag, weight and complexity.

LONGITUDINAL DYNAMICS

No doubt, in the last few years more research effort has been spent on longitudinal dynamics than on any other aspect of flying qualities. A number of researchers have proposed criteria which appear to have merit, but to date we have not been able to settle on one set in which we have enough confidence to apply universally.

For the short-term response MIL-STD-1797 keeps Bihrie's Control Anticipation Parameter [CAP²⁸, the ratio of initial pitching acceleration to steady normal acceleration, or alternatively $w_{sp}^2/(n/a)$] along with damping and sensitivity, and a limit on the equivalent time delay (the lower-frequency effects of added dynamics, delays from digital computation, etc.). Phugoid damping and dy/dV , a measure of "back-sidedness," continue to specify the long-term response.

Excessive time delay is a common cause of pilot-induced oscillations. Because a pilot senses stick or column deflection as well as force, he seems able to discount any part of the response delay caused by the feel system²⁹; the requirement takes that into account. Also, preliminary tracking studies show pilots more tolerant of delays in the display than in aircraft response. Conservatively, the time delay is restricted to values which do not appreciably affect pilots' ratings for fighter aircraft. Phase lag over a task-related bandwidth might be a better criterion; allowable delay also varies with control sensitivity.

These parameters correlate fairly well the data base for aircraft that respond in the classical manner. Specifying an equivalent classical system with time delay, many heavily-augmented aircraft correlate fairly well too. The actual response is matched over the range of effective pilot inputs, roughly 0.1 to 10 rad/sec, or for the first few seconds in the time domain. The standard's handbook gives several alternative requirements that do not fit well.

An alternative interpretation of CAP applies purely to the pitching response: n/a is approximately $(V/g) \cdot (1/T_{07})$ ($1/T_{02}$ is the higher-frequency zero of the pitch-response-to-pitch-command transfer function). If the $1/T_{02}$ from matching the pitch response varies significantly from the value obtained by simultaneously matching pitching and normal acceleration, data indicate that flying qualities are suspect.

Gibson^{30, 1} has developed another frequency-response criterion, with bounds which stress ample attenuation and slow drop-off of pitch-attitude phase response at -180 deg phase, and avoidance of both sluggishness and bobble tendency in pitch. He emphasizes time-response criteria, however. He requires positive dropback (Figure 8), but limits its magnitude and duration for fine tracking; and he bounds normal-acceleration lag and overshoot in response to step commands.

In ground-based simulator evaluations, McDonnell's first flight control system design for the STOL/Maneuvering Technology Demonstrator F-15, to MIL-F-8785C criteria, was good in general maneuvering, but downrated for fine tracking: a pitch bobble tendency was noted³¹. They found that Gibson's dropback criterion seemed to explain the pilots' comments. A redesign, substituting a larger pitch-numerator inverse time-constant (by adding a lag-lead filter), met the dropback criterion. Subsequent simulator evaluations showed "vastly improved" tracking, with a quite tolerable amount of "g-creep" in the normal-acceleration response.

Some useful short-term criteria involve only the pitch response. One of these is $w_{sp} T_{02}$: $\log w_{sp} - \log 1/T_{02}$ is the (logarithmic) length of the separation between $1/T_{02}$ and w_{sp} (Figure 9); also, $w_{sp} T_{02}$ is a measure of the pitch-rate overshoot to a step input, or the lag of normal acceleration behind pitch rate. Data that correlate with CAP generally correlate with $w_{sp} T_{02}$ as well.

Moh has proposed^{3, 1} a task-dependent aircraft bandwidth with good phase and gain margins as a fairly generally applicable criterion for dynamic flying qualities. A pilot should not have to work hard to achieve the needed pilot-vehicle bandwidth; and he may object to a very abrupt response. For pitch attitude response (Figure 9), he bounds a region of bandwidth and an approximate time delay measured from the frequency

response. While the concept is inviting, in some areas this criterion and CAP are mutually exclusive. Nevertheless, for high-order systems the bandwidth criterion is easily applied and worth checking.

Chalk's recommendations for supersonic-cruise aircraft pitch-rate response³² are in the time domain. For the response to a step command, he bounds the transient peak ratio, rise time and effective delay. These are essentially a translation of Reference 7's frequency-domain criteria into the time domain. While the requirements can be applied directly to many higher-order systems, large departure from a second-order response can still cause difficulty in interpretation.

The Neal-Smith criteria have found considerable use. As modified by Calspan³⁷, using a pilot model of given form and a 0.25-sec time delay, but with its other parameters free, the closed-loop pilot-vehicle system must achieve a task-dependent bandwidth (here the frequency for 90 deg phase lag, closed-loop) with no more than 3dB resonance for Level 1 and 3dB of droop at lower frequencies. These criteria appear in Figure 10. Chalk indicates that additional considerations, not specified, are the avoidance of a need for large pilot lead and the retention of stability with reasonable variations from optimum pilot parameters.

While extensive augmentation often does not prevent a good match in the short term, adding proportional-plus-integral compensation in the forward loop, for example, will alter the lower-frequency response. Such compensation is commonly used to stabilize an inherently unstable basic airframe. The phugoid motion can be effectively suppressed, but the steady-state response may not be like that of a simple airplane. With pitch-rate feedback, unless the integrator lead zero is close to $1/T_{\theta 2}$, the flight path will not follow pitch attitude in the normal manner, which is a simple first-order lag. (For a step command, α , which is $\theta - \gamma$, will not settle at a new constant value but instead will ramp off). See Figure 11. Also, the aircraft will hold attitude rather than angle of attack, so that the pilot may have to push to lower the nose after flaring to land. With the resulting neutral speed stability, angle of attack is sometimes fed back in order to furnish stall protection -- at least near stall angles.

Otherwise, neutral speed stability is desirable in many applications: it prevents large trim changes with speed. Likewise, pilots appreciate such added features as pitch compensation in turns at up to moderate bank angles. As yet, these helps are not covered by our flying qualities requirements.

The options cited for short-term response are included in the handbook. Additional longitudinal response criteria for approach and landing have been proposed recently.

Calspan³³ has formulated an empirical pilot rating function on the basis of evaluations in the TIPS variable-stability airplane. Based on a step pilot input, the predicted rating is a function of (1) angle-of-attack response ramping, (2) α -response time, (3) the pilot's normal-acceleration cue from pitching acceleration (for a cockpit not at the instantaneous center of rotation), (4) control sensitivity and (5) effective time delay.

For carrier landings, Heffley³⁴ compares the time lags in airspeed and glideslope ("essentially $T_{\theta 1}$ and $T_{\theta 2}$ " resp) to the time available following rollout onto final approach (normally about 15 or 20 sec or 3/4 nautical mile). His analysis assumes pilot closure of an inner pitch loop, then use of pitch attitude and thrust to control airspeed and glideslope. In ground-based simulations, pilot ratings correlated with glideslope lag and airspeed lag, or with a single "excess time ratio."

After investigating various pilot loop closures in landing³⁵, researchers at NASA Ames-Dryden found an open-loop metric giving excellent correlation with several data sets³⁶. For a step command removed after five seconds (analogous to a flare), pilot rating deteriorates with increasing peak overshoot of flightpath angle.

Pitch control of the space shuttle orbiter has received much attention. After initially noting a pilot-induced oscillation tendency, extensive, continual training has resulted in very good landing performance (smooth landings with small dispersion, mostly on long runways, in smooth air). Contributing to the difficulty are a rather large time delay, the pilot location behind the instantaneous center of rotation, and added normal-acceleration lag from reducing the pitch-rate overshoot. In in-flight (TIPS) and moving ground-based (NASA Ames VMS) evaluation³⁷, the trained shuttle orbiter pilots, however, actually preferred their nominal system to modified systems with more overshoot. The other participating pilots found only the modified dynamics instinctive and natural to fly.

"One interpretation of the astronauts' technique is they have learned to compensate for the lack of initial cockpit cues by performing the landing task primarily using the visual cues of pitch attitude and attitude rate... The attitude can then be used to provide considerable lead in determining the steady-state flight-path," whereas for the other pilots, "direct observation of flightpath (or sink

rate) derived from visual as well as kinematic cues appeared to be the primary control variable."

CONCLUDING REMARKS

Ideally, flying qualities research develops criteria through a succession of pilot-vehicle analysis and increasingly detailed evaluations by pilots in ground-based and in-flight simulators, ultimately checked by flight test. To date, almost all successful criteria have been stated in terms of parameters of the augmented aircraft. While the analytical approach has on occasion been quite helpful as a design tool, its acceptance for specification use does not yet appear imminent. We do encourage its further development and use for early design analysis of suitability, and as a development and trouble-shooting tool.

Neither is flying qualities specification in terms of task performance (probability of kill, touchdown dispersion, etc) suitable, for two reasons. Quantification of pilot workload in mission-related terms is elusive, and such measures increasingly involve many factors unrelated to flying qualities as more different subsystems become involved.

Generally, we therefore continue the traditional approach of specifying characteristics of the (augmented) aircraft itself. Overall suitability for design missions is evaluated in detailed simulations and emphasized in the flight test program.

A number of flight control system designers have been reluctant to use the MIL-F-8785 flying qualities requirements to determine system behavior, feeling that they do not apply. MIL-STD-1797 attempts to show where and how its requirements do apply, and we are pursuing development of design helps. We thus hope to avoid some of the pitfalls that have been encountered.

With increasingly complex aircraft, failures that affect flying qualities at all are liable to cause degradations in several qualities. Our data base, on the other hand, generally considers one degradation at a time. Current research at STI seeks to determine general procedures for handling multiple degradations. Considering multi-axis tasks, both an optimal control model and a product rule for predicting pilot rating of two or more failures show promise. Some results using the optimal control model are given in Reference 38. For substitution of available alternate control effectors in the event of a failure, more needs to be known about tolerance to unusual cross-axis coupling.

Hypervelocity flight introduces new demands for accurate control of attitude and flight path in order to bound aerodynamic heating, navigation errors and, possibly, engine parameters. The pilot's role is as yet poorly defined for "aerospaceplane" missions, but from experience the pilot likely will have at least a monitoring and backup function in all flight phases.

To overcome the remaining shortcomings and gaps in the MIL-STD-1797 requirements, simulation will continue to be an indispensable design aid. For many tasks, ground-based simulation is adequate. Its principal shortcomings remain the missing, minimal or spurious motion cues, which can give misleading results for some tasks, and inadequate resolution and often restricted field of view for flight close to the ground. Visual and motion time delays in the simulator can be measured; they may or may not be tolerable. Direct comparison of in-flight (TIFS) and limited-motion ground-based (NASA Langley VMS) simulation³⁹ confirms that (1) generally, good correlation exists, (2) ground-based simulation may not show pilot-induced oscillation tendencies observed in flight, and (3) touchdown sink rate is about 3.5 ft/sec greater on the ground-based simulator.

Until now, we have tried to write requirements which, while assuring good flying qualities, do not overly burden the design to achieve an optimum. With a data base that until recently consisted entirely of the classical response of un-augmented aircraft, we have wanted to minimize the cost (funds, weight, drag, complexity, design effort) of specification compliance. These costs are becoming even more significant, but a combination of more demanding operational needs and enhanced flight control capability drives us to seek greater mission effectiveness through more comprehensive solutions. Unaided, no airframe can accomplish some necessary missions or, indeed, survive.

We need, of course, to define flying qualities that will demand the least from the pilot while enabling him to do the best possible job. In addition to traditional flying qualities, this will involve coupling with other subsystems, the character and dynamics of displays, and at least a degree of automation of piloting functions. Requirements need tailoring to specific tasks involved in terrain following/terrain avoidance, STOL operation including ground handling, precision weapon delivery, threat avoidance, air combat in an expanded flight envelope, etc. for normal operation and for handling failures. Battle damage and possible flight-control reconfiguration pose similar concerns.

An emerging aircraft become more complex, pilots and other crew members rely more heavily on the visual cues provided by cockpit display systems. Past research has concentrated on determining appropriate display content and format. However, displays may still fail to reduce crew workload and may even increase it. Until recently, designers failed to take into account the dynamics introduced by cockpit displays, modeling the closed-loop system using only the pilot and aircraft with its flight control system. Our work has demonstrated that display lags, bandwidth and damping do impact system performance, pilot workload and perceived flying qualities, in a task-dependent manner. Both experimental and analytical approaches are still at a fairly rudimentary stage.

The scope of flying qualities is expanding to account for improvements in flight control mechanization, automation to reduce pilot workload, and integration of flight control and other subsystems. Such niceties, of course, must be applied selectively and shown to be worth their cost. Most important, this design integration requires close teamwork among a number of technical disciplines and the pilot community.

REFERENCES

1. Military Standard, Flying Qualities of Piloted Vehicles, MIL-STD-1797 (USAF), 31 March 1987
2. Military Specification, Flying Qualities of Piloted Airplanes, MIL-F-8785C, 5 November 1980 (Superseding MIL-F-8785B, 7 August 1969)
3. Hoh, Roger H. et al. Proposed MIL Standard and Handbook -- Flying Qualities of Air Vehicles, AFWAL-TR-82-3081, Vols I & II, November 1982
4. Cooper, G. E. and Harper, R. P., Jr., The Use of Pilot Rating in the Evaluation of Handling Qualities, NASA TN D-5153, April 1969
5. Twisdale, T. R. and Franklin, D. L., Tracking Test Techniques for Handling Qualities Evaluation, AFFTC-TD-75-1, May 1975
6. Stapleford, R. L. et al, Outsmarting MIL-F-8785B(ASG), the Military Flying Qualities Specification, STI TR-190-1, August 1971 (for US Navy)
7. Gibbs-Smith, C. H., Aviation, an Historical Survey From Its Origins To The End of World War II, H. M. Stationery Office, London, 1970
8. Root, A. I., "Our Hones," Gleanings in Bee Culture, 1 January 1905 (reprinted in Reference 7)
9. Foulois, Lt Gen Benjamin F., "The Day I Taught Myself to Fly," Airman, March 1980
10. Harper, R. P., Jr and Cooper, G. E., "Handling Qualities and Pilot Evaluation," AIAA J. Guidance, Vol 9, No 5, September-October 1986 (the 1984 Wright Brothers Lectureship in Aeronautics)
11. Accidents Committee, Mervyn O'Gorman, Chmn, Preliminary Report on Behaviour of Aeroplanes When Flying Inverted, With Special Attention to Some Accidents on "A", A.R.C. R & M No 817, January 1919
12. McRuer, Duane and Graham, Dunstan, "A Historical Perspective for Advances in Flight Control Systems," Integrity in Electronic Flight Control Systems, AGARD-AG-224, April 1977
13. McRuer, Duane and Myers, Thomas T., Flying Qualities of Relaxed Static Stability Aircraft -- Volume II, Ramifications of Flight-Essential/Critical Heavily-Augmented Airplane Characteristics on Flying Qualities, DOT/FAA/CT-82/130-II, September 1982
14. Spreeman, K. P., Design Guide for Pitch-Up Evaluation and Investigation at High Subsonic Speed of Possible Limitations Due to Wing-Aspect-Ratio Variations, NASA TM X-26, August 1959
15. Harper, G. W. and Maki, R. L., A Review of the Stall Characteristics of Swept Wings, NASA TN D-2373, July 1964
16. Stall/Spin Problems of Military Aircraft, AGARD-CP-199, June 1976
17. Beufere, Henry L. et al, Control Power Requirements for Statically Unstable Aircraft, AFWAL-TR-87-3018, Vols I & II, June 1987
18. Graham, Dunstan and McRuer, Duane, Analysis of Nonlinear Control Systems, John Wiley & Sons, Inc, 1961
19. A'Narrah, R. C. and Woodcock, R. J., "The Military Flying Qualities Specification, a Help or a Hindrance to Good Fighter Design?", Combat Aircraft Manoeuvrability, AGARD-CP-319, December 1981

20. Hanson, G. D. and Stengel, R. F., "Effects of Displacement and Rate Saturation on the Control of Statically Unstable Aircraft," J. Guidance, Control, and Dynamics, Vol 7, No 2, March-April 1984
21. Howard, J. D., Capt and Johnston, A. M., "Gravity-Induced Loss-of-Consciousness and Spatial Disorientation Auto-Recovery System," Proc National Aerospace Electronics Conference (NAECON), Dayton OH, 19-23 May 1986
22. Suchomel, C. F., Nonlinear Flying Qualities -- One Approach, AIAA-87-0347, 12-15 January 1987
23. Morton, B. G. et al, Nonlinear Flying Qualities Parameters Based on Dynamic Inversion, AFWAL-TR-87-3079, October 1987
24. Myers, T. T. et al, Flying Qualities in Non-Linear Large Amplitude Maneuvers, AIAA/ABS/ASAE Aircraft Design, Systems, and Operations Meeting, St Louis MO, 14-16 September 1987
25. Ross, D. H., Lt Col, USAF, "AFTI/F-16 Program Phase II Overview, Automated Maneuvering Attack System," Proc National Aerospace Electronics Conference (NAECON), Dayton OH, 19-23 May 1986
26. Brady, C. C. and Hodgkinson, J., Validation of the Flying Qualities Requirements of MIL-P-008785A (USAF), AFFDL-TR-70-135, January 1971
27. Monegan, S. J. et al, Lateral Flying Qualities of Highly Augmented Fighter Aircraft, AFWAL-TR-81-3171, Vol I, June 1982
28. Bihrie, W. Jr, A Handling Qualities Theory for Precise Flight Path Control, AFFDL-TR-65-198, June 1986
29. Smith, R. E. and Sarrafian, S. K., Effect of Time Delay on Flying Qualities: An Update, AIAA 86-2202, August, 1986
30. Gibson, John C., "Pilot Handling Qualities Criteria for High Order Flight Control Systems," AGARD-CP-333, Criteria for Handling Qualities of Military Aircraft, June 1982
31. Bland, M. P. et al, Alternative Design Guidelines for Pitch Tracking, AIAA 87-2289, August 1987
32. Chalk, C. K., Calspan Recommendations for SCR Flying Qualities Design Criteria, Calspan Report No 6241-P-5, January 1980 (for NASA)
33. Weingarten, N. C. et al, Flared Landing Approach Flying Qualities, Vol I - Experimental Design and Analysis, NASA CR 178188, December 1986
34. Heffley, R. K., Terminal Control Tasks for the Carrier Landing Task, AIAA 86-2251, August 1986
35. Sarrafian, S. K. and Powers, B. G., Application of Frequency Domain Handling Qualities Criteria to the Longitudinal Landing Task, AIAA 85-184P (NASA TM 86728), August 1985
36. Berry, D. T. and Sarrafian S. K., Validation of a New Flying Quality Criterion for the Landing Task, AIAA-86-2126, August 1986
37. Powers, B. G. and Sarrafian, S. K., Simulation Studies of Alternate Longitudinal Control Systems for the Space Shuttle Orbiter in the Landing Regime, AIAA-86-2127, August 1986
38. McPuer, Duane and Schmidt, D. K., Pilot-Vehicle Analysis of Multi-Axis Tasks, AIAA 87-2538, August 1987
39. Grantham, W. D. and Williams, R. M., Comparison of Ground-Based and In-Flight Simulator Derived Flying Qualities and Pilot Performance for Approach and Landing Tasks, AIAA 87-2290, August 1987

TABLE I. REQUIRED CONTROL-MARGIN INCREMENTS

Flying Quality	$\delta \dot{q}_0 / \Delta n_c = 57.3 \text{ CAP}' / M_0 \text{ deg/g (for } T_{\text{eff}} \leq 0.05)$
Stabilization	$\Delta \delta_{\text{stab}} / \Delta n_c = 57.3 \frac{g}{U_0} \cdot \frac{1/T_{\text{sp}_1} \cdot 1/T_{\text{sp}_2}}{M_0 \cdot 1/T_0} \text{ deg/g (1linear, 2 DOF)}$
Turbulence	$\sigma_\delta / \sigma_w \text{ fn of } M_0, M_\delta, \omega_{\text{sp}_{c1}}, \zeta_{\text{sp}_{c1}}, \text{ structural modes}$ - most severe at low \bar{q} - $3\sigma_\delta$ and σ_w for severe turbulence recommended
Sensor Noise	$\sigma_\delta / \sigma_s \text{ fn of } K_s, K_f, \omega_s, 1/T_a, \omega_{\text{sp}_{c1}}, \zeta_{\text{sp}_{c1}}, \omega_{\text{sp}_{o1}}$
Flying Quality	$\delta \dot{q}_0 / n_c = 57.3 \text{ CAP} / (M_0 \cdot T_{\text{eff}})$ for desired CAP
Stabilization	$\delta \dot{q}_{\text{stab}} / n_c < \delta \dot{q}_0 / n_c$ if FCS stability margins OK & $\frac{1}{T_{\text{eff}}} \rightarrow \omega_c$ $\delta \dot{q}_{\text{stab}} / n_c \text{ fn of } 1/T_{\text{eff}}, 1/T_{\text{sp}_1}, \omega_{\text{sp}_{c1}}, \zeta_{\text{sp}_{c1}}$
Turbulence	$\sigma_\delta / \sigma_w \text{ fn of } 1/T_a, \omega_{\text{sp}_{c1}}, \zeta_{\text{sp}_{c1}}, M_0$ - Most severe at low \bar{q} - $3\sigma_\delta$ recommended for control margin
Sensor Noise	$\sigma_\delta / \sigma_s = K_s K_f \cdot \text{fn} (\omega_s, 1/T_a \text{ and, for low } \omega_{\text{sp}_{c1}}: \omega_{\text{sp}_{o1}}, \omega_{\text{sp}_{c1}}, \zeta_{\text{sp}_{c1}})$ - These parameters are not all independent - $3\sigma_\delta$ recommended for control margin

Δn_c is the commanded increment of normal acceleration
 $1/T_u$ is the unstable pole of the transfer function (negative; 1/sec)
 $\omega_{\text{sp}_{o1}}$ is the 2-deg-of-freedom product of the poles, 1/sec
 $\omega_{\text{sp}_{c1}}$ and $\zeta_{\text{sp}_{c1}}$ are the closed-loop frequency and damping ratio of the short-period mode
 CAP is $\dot{q}_0 / \Delta n_w$, CAP' is $\dot{q}_{\text{max}} / \Delta n_w$
 ω_s is the sensor bandwidth
 K_s, K_f are the sensor and forward-loop gains
 σ_s, σ_w are the rms intensities of sensor noise and vertical gusts
 ω_c is the crossover frequency of the δ / n_c transfer function
 T_{eff} is the effective time constant of command-path plus forward-path control-loop elements (such as prefilters and actuators)
 T_a is the time constant of the actuator ram

TABLE II. AGILITY CONSIDERATIONS

Capability	Operational Utility	Vehicle Impact
• High Angle-of-Attack/ Post Stall Maneuvering	• Good for all aspect missile pointing • Poor many-on-many tactic	• Requires Propulsive force and moment effectors
• Rapid Acceleration/ Deceleration	• Excellent for both defensive and offensive maneuvering	• Requires thrust reversing
• Quick Energy Recovery	• Essential for survivability in many-on-many • Improves utility of low speed maneuvering	• Rapid thrust onset • High Thrust / weight
• High g (9+) Maneuvering	• Outperform adversary	• High-g cockpit • Pilot loss of consciousness protection
• High Sustained Turn Rate	• Turning Advantage	• High Thrust
• High Mach (2.2+) flight	• Short, slashing engagement for survivability	• High thrust • Variable Inlet

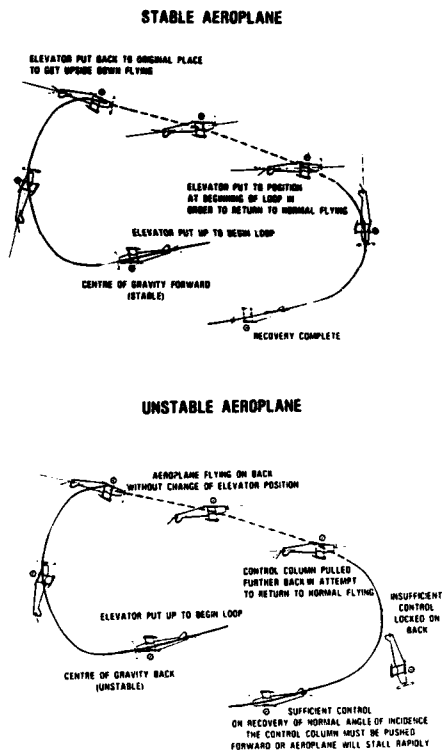

Figure 1. A Need for Control Margin

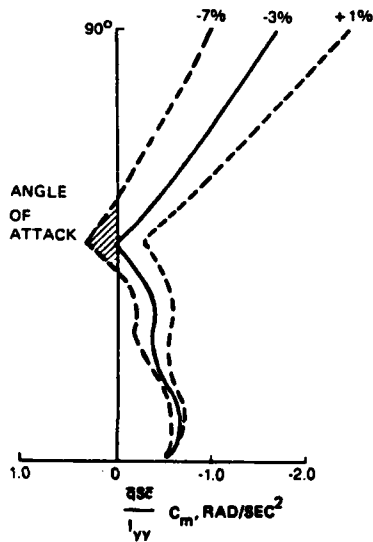

Figure 2. Maximum Nose-Down Moment for 3 Centers of Gravity

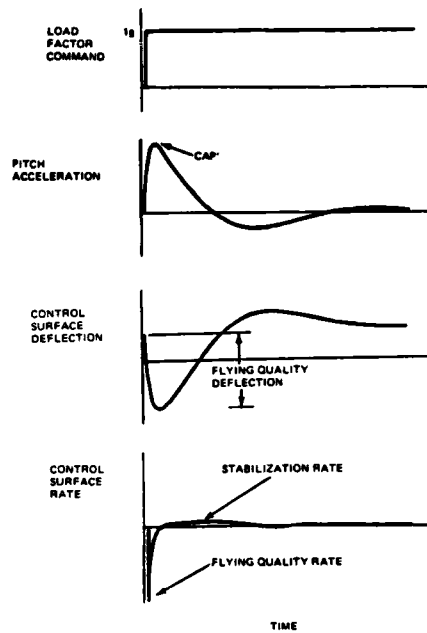

Figure 3. Control Surface Requirements for an Unstable Aircraft

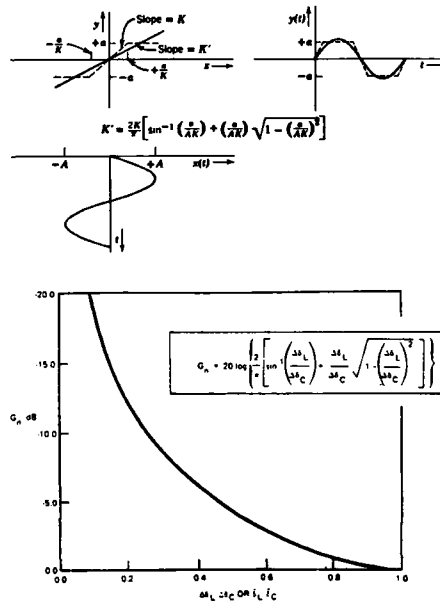

Figure 4. Sinusoidal Describing Function for Control Surface Deflection Limiting or Rate Saturation

6-14

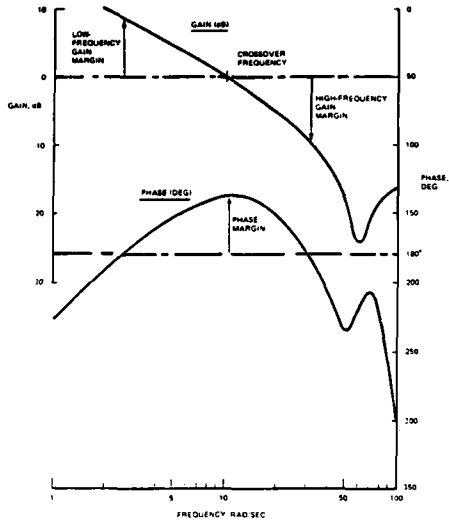

Figure 5. Generic Open-Loop Bode Plot of an Unstable Aircraft

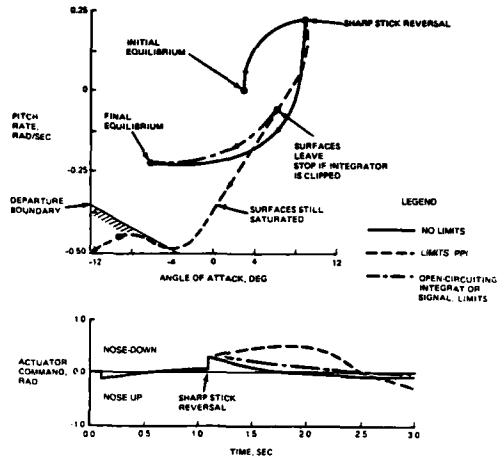
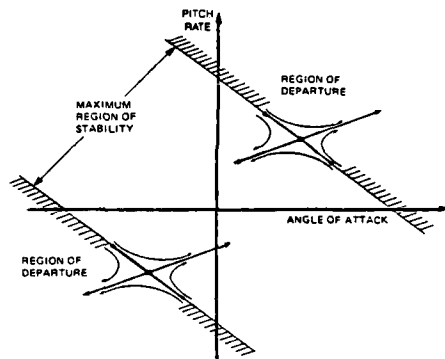
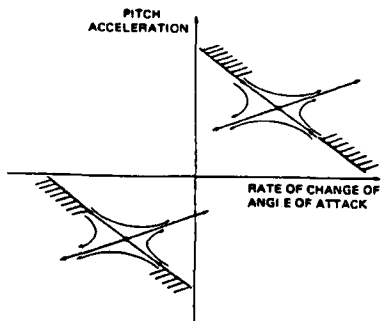

Figure 7. Phase-Plane Plot of Integrator Open-Circuiting Effects



a. Deflection Saturation



b. Rate Saturation

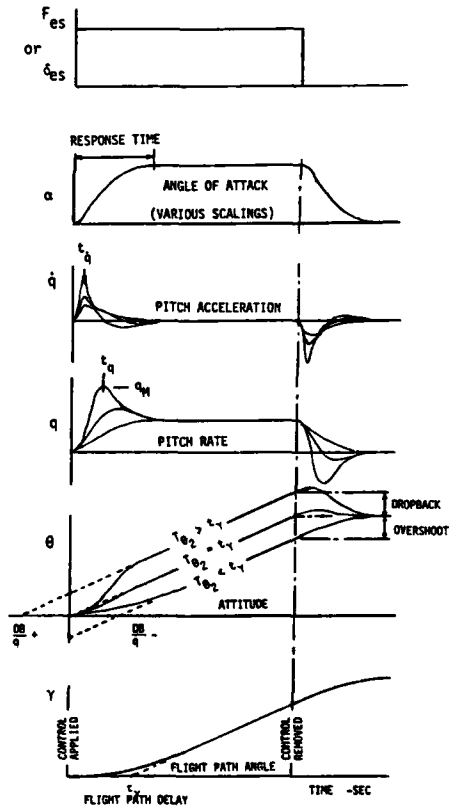

Figure 6. Deflection and Rate Limiting Figure 8. Pitch Short-Period Time Responses

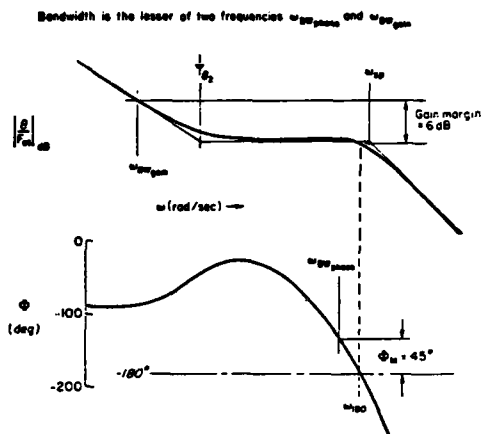

Figure 9. Definition of Bandwidth Frequency ω_{BW} from Open-Loop Frequency Response

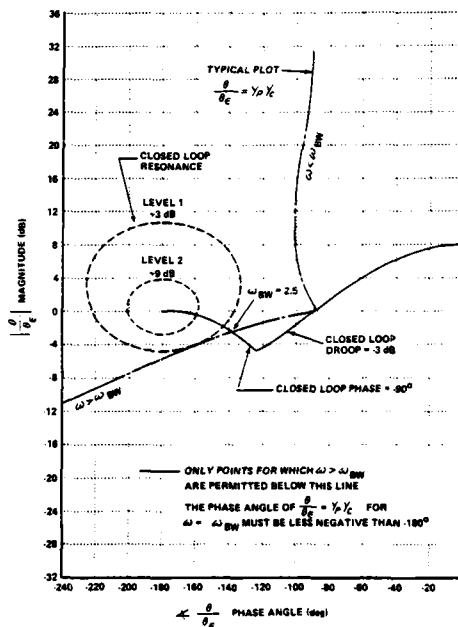

Figure 10. Design Criteria for Pitch Dynamics with the Pilot in the Loop

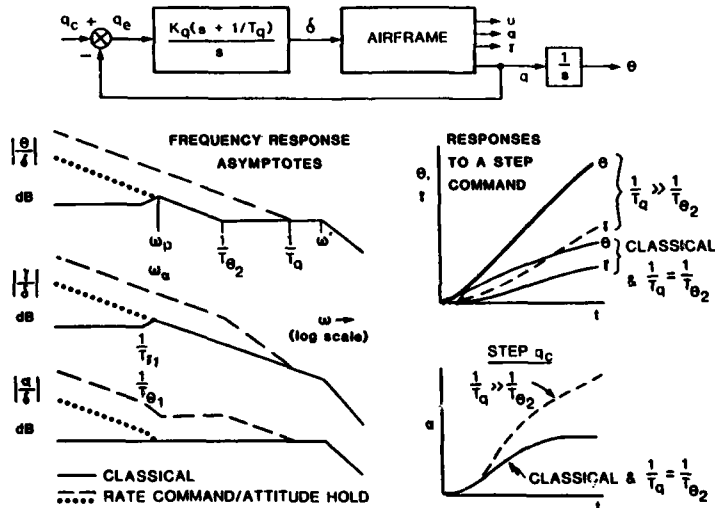

Figure 11. Frequency and Time Response Comparison

THE OPTIMAL CONTROL PILOT MODEL AND APPLICATIONS

by

Mario Innocenti^{†,*}
Dipartimento di Ingegneria Aerospaziale
Universita' degli Studi di Pisa
Via Diotisalvi 2, 56100 Pisa, Italia

ABSTRACT

The modeling of the human pilot behavior plays an important role in the preliminary analysis of aircraft handling qualities. This is especially true when the designer is confronted with non-conventional aircraft dynamics, tasks and/or lack of sufficient handling qualities data-base. The present paper reviews one modeling technique which was developed in the early 1970's and has been widely used since then: the optimal control model of the human pilot (OCM). The model has been validated in a number of tasks and used in the analysis as well as the synthesis of manual control loops. The capabilities of the model are evaluated in the pilot rating (PR) prediction, in the analysis and in the synthesis of pilot/vehicle control loops from the handling qualities standpoint.

1. INTRODUCTION

The first integrated attempt to describe the behavior of the human pilot in an optimal control theoretic framework was by Kleinman, Baron and Levison [1] in their two-part work published by Automatica in 1970. Since then, the optimal control model of the human pilot (OCM) has been used, without substantial modifications, in a variety of applications ranging from pilot modeling to rating evaluation, from visual control loop analysis, including additional dynamic elements, to loop synthesis in cases when there was not enough handling qualities data-base available.

The study and modeling of the human pilot behavior has its modern origins in the late 1940's with the work by Tustin [2]. Since then, the model development has followed over the years the introduction and usage of control theory techniques, with appropriate modifications to accommodate the peculiarities and limitations of the human operator. The most immediate result has been the development of classical, frequency domain based models, which have evolved from rather simple lead-lag compensators using describing function techniques, to the more complex crossover and structural-isomorphic models [3]. A detailed discussion on this topic has been addressed in previous lectures of this series.

The development of the OCM follows a similar path. Optimal control theory and estimation has had a major impact on the control design community, after the early work by Kalman and others, especially in the aerospace arena where the algorithmic MIMO nature of linear quadratic gaussian control (LQG) furnished a powerful systematic tool for synthesizing complex highly coupled controllers envisioned for the development of modern, high-performance aircraft. The optimal control model of the human pilot represented, therefore, a natural extension to manual control of time domain techniques which appeared to be useful in treating a variety of situations arising in piloting a highly coupled dynamic system, from multi-axis control to multi-tasking and complex mission management.

Although the use of OCM as an algorithmic tool has not posed particularly difficult problems, the optimal control nature of the method carried out both the advantages and disadvantages already known in the application of the same theory to the synthesis of automatic controllers. In particular, one of the difficulties of the OCM has been the translation of the pilot's objectives into a robust quantitative functional whose minimization produces the operator's control strategy. On the other hand, the general structure of the model was particularly attractive because of the number of applications it would allow. Originally, the OCM was used in a very straightforward way as a model of the pilot's continuous control action during tracking tasks typical of many phases of the mission of an aircraft. Comforting agreement with experimental data was found [1] especially when dealing with compensatory tracking. Research is still ongoing for multi-axis manual control [4] due to the lack of data-base, as will be pointed out later in the paper.

Due to the structure of the model (see next section), OCM can be modified to treat decision-making problems by considering the estimation/prediction section of the model [5] as the output instead of the control strategy (now a pre-assigned decision rule).

The optimal control model of the human pilot has been applied mainly with regard to aircraft flight control and dynamics, both as a predictive as well as analytic tool and some of the applications will be described and commented on later. The paper is organized as follows: the next section contains a review of the mathematical background of the model, including some extensions used for particular applications and the status of the computer codes used for the implementation. Section 3 includes some validation examples and analyzes the capabilities of the model to give pilot rating (PR) information in a quantitative manner and the matching with experimental data. Sections 4 and 5 describe the use of OCM in a closed-loop pilot/vehicle framework. In this context, applications to display analysis and synthesis, workload evaluation, time delay effects, attention allocation analysis and cooperative stability augmentation synthesis techniques will be outlined. Finally, some conclusions and comments will be given in Section 6.

[†]AGARD-LS-157, Paper #7, 1988.

*Present Address: Department of Aerospace Engineering, Auburn University, AL 36849-5338, USA.

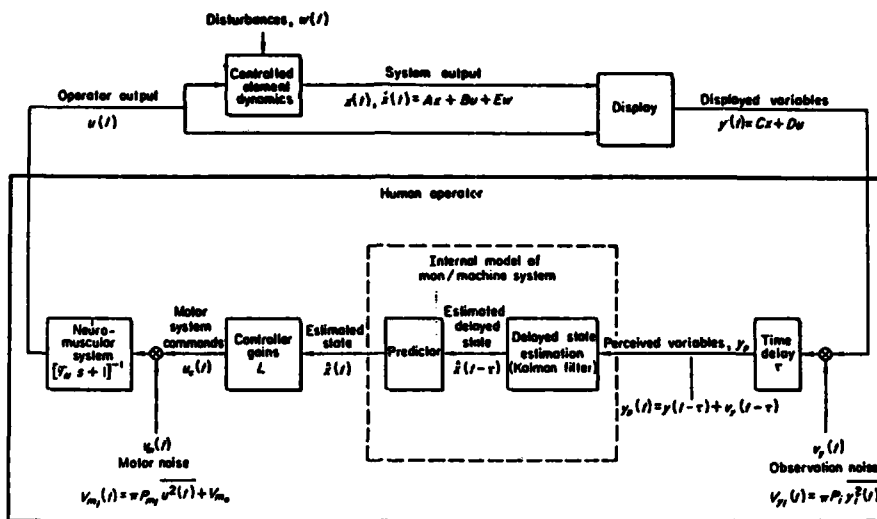

Figure 1. OCM Block Diagram [3]

2. MODEL REVIEW

In this section, the mathematical formulation of the optimal control model will be reviewed, together with the implementation of the major human operator's characteristics. The following derivation will be based on Figure 1, which shows the block diagram of the model's components.

The optimal control nature of the model arises from a basic assumption of the pilot's behavior; that is: a "well motivated, well-trained human operator behaves in a near optimal manner subject to his/her inherent limitations and constraints, and knowledge of the control task"[1]. In this context, the application of standard optimal control techniques requires the additional hypotheses of: 1) linearized representation of the plant dynamics to be controlled and/or monitored, 2) a stochastic model of the disturbances feeding the system, 3) a linear representation of the sensory information utilized by the pilot during his/her action.

The structure of the model, as shown in Fig. 1, is completed by introducing those items characterizing the human limitations constraining the pilot's behavior. Basically, these limitations comprise the properties of the sensory information, herein named as "display vector," the ability of reconstructing the state of the system, the inability to generate noise-free commands and a constraint on the bandwidth of his commands. The display vector is the perceptual component of the OCM and it is characterized by a linear combination of the system's states, including all the potentially relevant cues such as traditional symbolic display information, visual scene and outside world cues. It is well known, from experiments, that the pilot is able to associate velocity information with moving displays and this should also be taken into account in the construction of the display vector. Part of the so-called remnant is modeled in the OCM by adding an observation white noise process to the display vector, which accounts for limitations such as perceptual resolution, image processing and attention sharing. The displayed vector is additionally modified by adding an observation delay due to human processing limitations.

The other component of the pilot's remnant is modeled in the OCM by a white noise process called motor noise, which takes into account the imperfection of the command and it is additive to the control action. It has been shown that the importance of the motor noise depends upon the application [1] although its presence is "heuristically" necessary since the operator is not able to generate a perfect estimate of the control input.

The physical limitation of the pilot's bandwidth is introduced via a first order lag that, in the model, is formally the direct consequence on the penalty in control rate activity. This term is also known as the neuromotor lag and it can also be associated to subjective constraints self-imposed by the pilot in order not to make rapid control movements.

The pilot's capability of reconstructing the state of the dynamics he is controlling is the central element of the model. Based on the delayed, noisy information from the display vector, it is assumed that the operator possess an internal model of the system and forcing disturbances. This translates mathematically in two components: an estimate of the system's delayed states and a prediction of their

behavior in real time. Once the state reconstruction is performed, the optimal control model chooses its control strategy based upon a combination of two major objectives, that is the task performance and the amount of workload needed in order to accomplish the task in a satisfactory manner. The quantification of the above objectives is critical to the successful modeling of the operator's behavior since, as shown in the next paragraph, the model's control strategy is computationally dependent upon the aforementioned objectives.

The mathematical development of the OCM is briefly reviewed at this point. The plant dynamics to be controlled are given in the standard state-space linear form by:

$$\dot{\underline{x}} = \underline{Ax} + \underline{Bu} + \underline{Ew} \tag{1}$$

$$\underline{y} = \underline{Cx} + \underline{Du}$$

where $\underline{x}(t)$ is the n -dimensional state vector, $\underline{u}(t)$ the m -dimensional pilot's input, $\underline{w}(t)$ is the p -dimensional disturbance vector modeled as a zero-mean gaussian white noise with covariance W . The r -dimensional display vector and the state vector are chosen so as to include all the dynamic information and cues used by the pilot as well as rate content of the displayed variables.

As mentioned earlier in the section, the perceptual model of the displayed vector \underline{y} is corrupted by an observation noise $\underline{v}_y(t)$ and delayed by a quantity τ . The human pilot's perception is therefore modeled as

$$\underline{y}_p(t) = \underline{Cx}(t-\tau) + \underline{v}_y(t-\tau) \tag{2}$$

with $\underline{v}_y(t)$ as a zero-mean gaussian white noise process with intensity matrix $V_y = \text{diag} [v_{y_i}] \quad i=1, \dots, r$.

The intensity matrix V_y depends on the nature of the display, the physical environment and pilot's characteristics. It has been shown [1], [6] that it is proportional to the variance of the outputs $\sigma_{y_i}^2$ through a roughly constant noise-signal ratio ρ_{y_i} and inversely proportional to the attentional allocation fraction and indifference threshold T_i of each channel, according to the expression

$$v_{y_i} = \frac{\rho_{y_i} \sigma_{y_i}^2}{T_i} \cdot \frac{1}{\text{erfc}[\frac{T_i}{\sigma_{y_i} \sqrt{2}}]} \tag{3}$$

In practice, the observation noise characteristics are implemented via the ratio $v_{y_i} / \sigma_{y_i}^2$, which usually shows a power density level of about -20dB.

The model's control strategy is obtained from the minimization of a quadratic performance index J given by

$$J = E \left[\lim_{T \rightarrow \infty} \frac{1}{T} \int_0^T [\underline{x}^T Q \underline{x} + \underline{u}^T R \underline{u} + \underline{\dot{u}}^T G \underline{\dot{u}}] dt \right] \tag{4}$$

In Equation (4) the weighting matrices $Q \geq 0$, $R \geq 0$, $G > 0$ may be chosen as an extension of classical compensatory tracking tasks requirements and/or subjective constraints. The weighting on the pilot's control rate represents, as described earlier, a limitation on the pilot's bandwidth as well as the natural tendency of trained pilots not to perform abrupt control actions. This term translates formally into a first order neuromotor lag on each control channel, as shown in Figure 1 and the weighting matrix G is selected in an iterative manner so as to satisfy the experimental based neuromotor motor delays (usually of the order of .1 - .15 seconds).

The control action results from the direct application of standard LQG techniques to the delayed system, leading to the full-state feedback relation

$$\underline{u}_c(t) = -L \hat{\underline{x}}(t) \tag{5}$$

where the control gain matrix L is the solution of the standard algebraic Riccati equation referred to the augmented performance index

7-4

$$J = E \left\{ \lim_{T \rightarrow \infty} \frac{1}{T} \int_0^T \begin{bmatrix} Q & 0 \\ 0 & R \end{bmatrix} \dot{x} + \dot{u}^T C_0^T dt \right\} \quad (6)$$

with dynamic constraints given by

$$\dot{x} = \begin{bmatrix} A & B \\ 0 & 0 \end{bmatrix} x + \begin{bmatrix} D \\ I \end{bmatrix} \dot{u} + \begin{bmatrix} E \\ 0 \end{bmatrix} w = A_0 x + B_0 \dot{u} + E_0 w \quad (7)$$

Note that the augmented ($n+m$)-dimensional state vector is now $x^T = [x^T, u^T]$. The solution is therefore

$$L = G^{-1} [0; I] K_0 = [L_1; L_2] \quad (8)$$

with K_0 solution of

$$A_0^T K_0 + K_0 A_0 + \begin{bmatrix} Q & 0 \\ 0 & R \end{bmatrix} - K_0 B_0 G^{-1} B_0^T K_0 = 0 \quad (9)$$

The internal model of the pilot, that reconstructs the augmented state vector $x(t)$ from the displayed vector $y_p(t-\tau)$ and the command $u_c(t)$, is given by a cascade combination of Kalman filter and linear predictor [7] represented by equations (10) and (11), respectively.

$$\hat{x}(t-\tau) = A \hat{x}(t-\tau) + K_p [\Sigma_p(t) - C \hat{x}(t-\tau)] , \quad K_p = \Sigma C^T V_y^{-1} , \quad A \Sigma + \Sigma A^T + E W E^T + \Sigma C^T V_y^{-1} C \Sigma = 0 \quad (10)$$

and

$$\hat{x}(t) = \xi(t) + e^{At} [\hat{x}(t-\tau) - \xi(t-\tau)] , \quad \dot{\xi}(t) = A \xi(t) + B u(t) \quad (11)$$

The control gain matrix L of Eq. (8) is obtained through the minimization procedure, choosing G so that $L_2 = T_N^{-1}$ yielding the pilot's control action:

$$T_N \dot{u} + u = -L_1^T \hat{x} = u_c , \quad \text{where } L_1^T = T_N L_1 , \quad L_2 = T_N^{-1} \quad (12)$$

including the motor noise v_m we finally get;

$$T_N \dot{u} + u = u_c + v_m \quad (13)$$

with v_m modeled as a zero-mean, gaussian white noise process with intensity matrix V_m .

As for the observation covariance, $V_m = \text{diag.}[V_{m_i}]$ was found by model matching data to be proportional to the mean square value of the control input u_c according to the relation

$$V_{m_i} = \nu \rho_u \sigma_{u_{c1}}^2 = .003 \nu \sigma_{u_{c1}}^2 \quad (14)$$

which corresponds to a normalized value of about -25 dB.

A comment must be made at this point: the way the Eq. (13) has been derived leads theoretically to a control law which is "suboptimal" in the sense that no longer minimizes the performance index. This procedure, however, retains its validity since the indirect inclusion of the motor noise (after the minimization process has been completed) does not alter appreciably the closed loop response within the bandwidth of the normal control loop. Introducing the motor noise contribution in the internal model of OCM causes no particular problems, however, as shown in the derivation of [1], [8]. The motor noise is in fact treated as an additional external disturbance and the augmented system becomes

$$\dot{x}(t) = \begin{bmatrix} A & B \\ 0 & -T_N^{-1} \end{bmatrix} x + \begin{bmatrix} 0 \\ T_N^{-1} \end{bmatrix} \dot{u} + \begin{bmatrix} E & 0 \\ 0 & T_N^{-1} \end{bmatrix} \begin{bmatrix} w \\ v_m \end{bmatrix} \quad (15)$$

with the Kalman filter and predictor operating now on Eq. (15) instead of Eq. (7) and leading to the control law

$$u_c(t) = -L^* \hat{x}(t) = -[T_M^* I_1; 0] \hat{x}(t) \quad (16)$$

The mathematical structure of the OCM, as outlined in the preceding paragraphs can then be applied to the modeling of human performance once the complete set of inputs is given for the manual control loop at hand. The inputs necessary for the use of the model are collected for the sake of clarity in Table 1.

Table 1. OCM Input Data

Variable	Description	Typical Value
A,B,C,E	system's matrices	---
W	external disturbance covariance	---
Q,R,G	weighting matrices	---
V _y	observation noise covariance	---
V _m	motor noise covariance	---
f _i	attentional allocation fractions	∑f _i = 1
T _i	indifference thresholds	.05°, .1°/sec
τ	observation delay	.1-.2 sec
T _M	neuro motor delay	.1 sec all inputs
Pi:Puc	noise ratios in dB	-20,-25

The output of the OCM is usually expressed by a set of time domain performance measures such as the minimum value of the performance index and the RMS values of error and mean square values of estimation error, estimate states and input (state and input covariance matrices). Frequency domain performances are not easily obtained from OCM unless the single-input, single-output case is treated. In this case, a Fade approximation can be used to eliminate the observation delay [8],[9],[10] and to obtain the pilot's transfer function in addition to the crossover frequency, effective delay, pilot phase compensation, which are performance measures used by classical pilot models.

The basic structure of the optimal control model has not changed substantially over the years. Levison, Baron and Junker [11] defined a revised optimal control model (ROCM) in order to improve the low frequency discrepancy of OCM when trying to match the standard laboratory data for K, K/s and K/s² plant dynamics. In their work, it is shown that the introduction of a pseudo motor noise in the internal model produces a low-frequency zero in the pilot's equivalent describing function u(s)/y(s) leading to the desired droop and matching the experimental data (see next section).

Some modifications were suggested by Phatak in the mid-70's in order to overcome the identification of difficulties of the OCM parameters [12],[13]. The problem of the identification of a model of human behavior has always been very important. A lack of identification requires, in fact, an increase in qualitative judgment on the model parameters and this could lead to an increase in the trial and error procedure needed to match model output with experimental data. The main problem with OCM is that the model is overparametrized; that is, it has more parameters than necessary to uniquely describe the input-output behavior of the human operator. Over-parametrization has led to difficulties in applying standard identification procedures based on either spectral analysis model matching or heuristic iteration of model parameters, which do not offer guarantee on the uniqueness of the identification nor a high level of confidence in the selected parameters due to the non-minimum variance of FFT's.

Four major areas of simplification of the model have been considered, some of them validated later on by independent research. The first point is the structure of the internal model of the OCM. The original hypothesis is the assumption of a perfect internal model of the plant/noise dynamics (in the least squares sense), which increases in complexity by a factor of 2n with respect to the dimensions of the plant. It is reasonable to assume, due to the finite bandwidth of the pilot, that the internal model should be of a level of complexity adequate to the specific control task, thus a lower order internal model consistent with the task requirements. A validation of the above assumptions can be found in [14]. Using ground-based simulation of a highly flexible aircraft, it was found that the pilot's action in a pitch tracking task followed that of zeroing the rigid body pitch error rather than the total displayed error. This implied the pilot's ability to filter out the high frequency content due to flexible oscillation pursuit in the pitch response of the aircraft. From these observations the hypothesis was made and then verified that the OCM internal model consisted only of the low frequency component of the total plant dynamics.

A second source of simplification comes from the attempt of OCM to be isomorphic to the psychophysical characteristics of the human operator. This allows the presence of a delay in the observation vector, thus requiring a linear predictor to obtain the real time estimate of the state vector $\hat{x}(t)$. In terms of

equivalent input-output describing function, the combination predictor-estimator produces a near pole-zero cancellation over a wide frequency range and an over-parametrization of the model. In many instances, the observation time delay can be eliminated, therefore eliminating the need for the predictor's dynamics. This assumption has been validated with experimental data [14],[15]; in both cases, the observation noise was retained in the normal control loop using a first order Padé approximation.

Another aspect analyzed by Phatak has been the elimination of the display rates in the observation vector requiring the estimation of rates only if necessary and some results in [12] show an appreciable degradation in the model's capability of fitting and predicting control data. Two further simplifications can be made from the identification point of view. One is the introduction of the motor-noise at the input to the model and combined it with the observation noise to get an "equivalent" human operator randomness contribution. The second is the elimination of control rate weighting in the model's performance index, which has been found to cause serious identification problems for low value of observation delay and motor noise covariance.

The implementation of the optimal control model of the human pilot has not changed substantially over the years from that in [10]. Modifications have been made only to accommodate particular applications and to derive the pilot's and open loop describing functions for handling qualities analysis. Recently, OCM code has been made available for personal computers [8] with interesting results at least in single-input, single-output tasks and independent multi-axis tasks.

3. PILOT MODELING AND PILOT RATING EVALUATION

In this section, the optimal control model of the pilot will be first verified by a comparison with standard compensatory laboratory data and then its capabilities in evaluating pilot ratings will be assessed.

The first validation example considered is the classical SISO compensatory tracking task described in [1]. The pilot has a single control and the display explicitly shows the error so that error and error rate information are the two components of the display vector. Three different plant dynamics are used with increasing difficulty in the control task, they are K, K/s, K/s². The input consists of a combination of sine waves modeling a random noise (first order, break frequency = 2 rad/sec for K/s, K/s² and second order, break frequency = 2 rad/sec for K plant).

The measure of performance was obtained evaluating the closed loop RMS values for error, error rate and control activity, and the pilot's equivalent transfer functions $y_e(s) = h_1(s) + sh_2(s)$ where $h_1(s)$, $h_2(s)$ are the transfer functions from the input to each output (error, error rate).

Table 2 in [1] shows the comparison between measured and theoretical closed loop performance. No substantial discrepancy is found except for the proportional plant output rate variance. This error can be reduced, however if the frequency range of the measurement is limited to values of the order of 30 rad/sec [1].

The behavior of the predicted and measured equivalent transfer functions and the value of the equivalent remnant power spectrum at the plant output rate are shown in Figure 2, for the K/s plant case (similar results for the other dynamics can be found in [1],[13]). The agreement between the results is evident except for the inability to recover the low frequency phase droop. The error in low frequency matching can be eliminated using the concept of pseudo-motor noise of ROOM [11] as shown by the dashed line in Figure 2.

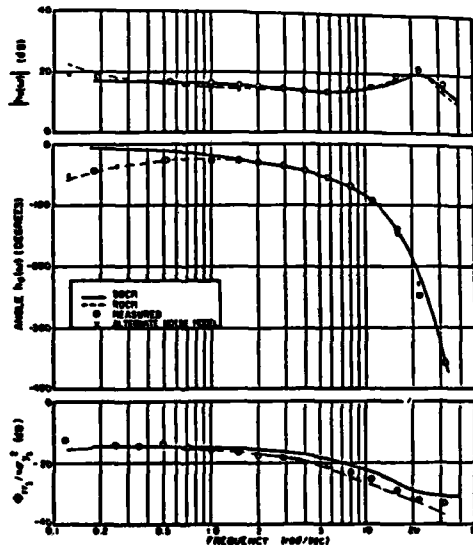

Figure 2. Frequency Domain Measures, K/s plant [13].

Another validation of the OCM in a single-axis pitch tracking task was performed by Mass [16] using three configurations from Arnold's data-base (5A, 8A, 10 corresponding to level 3, level 2 and level 1 dynamics, respectively). Figures 3 and 4 show RMS performance and pilot's describing functions as the result of Mass' analysis. The validity of the pitch-tracking task was assessed by verifying the integral behavior of the open loop describing functions near crossover.

From Figure 4, we can relate the validity of the OCM results as handling qualities assessment tool by looking at the distance between disturbance break frequency ω_b and pilot-vehicle crossover frequency ω_c . The smaller the separation between the two frequencies and the lower the acceptability by the pilot as verified from the pilot's comments and ratings during the simulation.

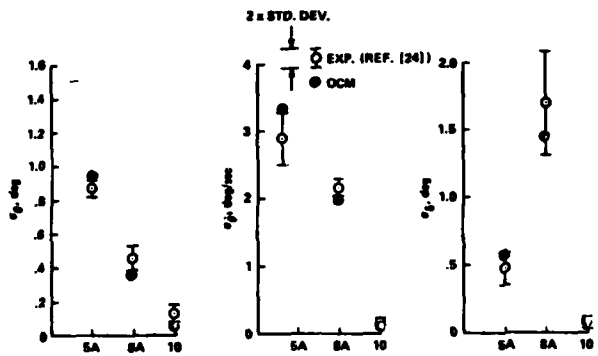

Figure 3. RMS Predictions vs. Arnold's Data. [16]

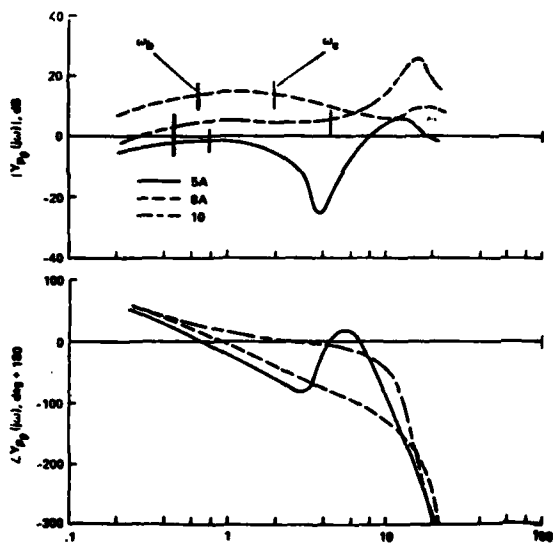

Figure 4. Frequency Separation from Arnold's Data. [16]

A maybe more important validation of the OCM model is its capability to assess and predict the handling qualities characteristics of a given aircraft. A lot of work has been done in the past in this area following two main directions, the first being a single-input, single-output compensatory tracking task validation using the large data-base available from the work done in testing classical pilot modeling techniques. The second is the identification of a relation between numerical pilot ratings (usually on a standard Cooper-Harper scale) and the main feature of the OCM, its performance index value. At the present time, research is focusing on the assessment of handling qualities characteristics of multi-axis tasks.

In the validation of the OCM as a viable tool for handling qualities prediction, a significant result was obtained in Ref. [18]. In the work by Bacon and Schmidt, the OCM capability of obtaining standard Neal-Smith type information was recognized and, furthermore, the optimal control model was able to better model actual in-flight situations without relying on the fixed bandwidth idea, thus uncovering some PIO prone cases which were not determined by the original Neal-Smith work. Figure 5 summarizes the results in [18] and the agreement of the two approaches is evident.

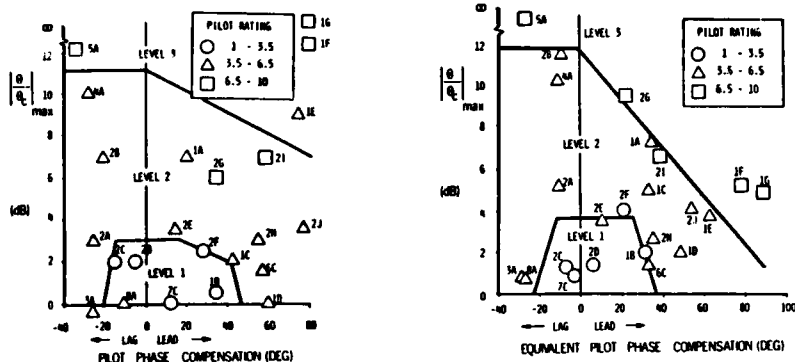

Figure 5. Reproduction of Neal-Smith Results using OCM. [18]

The advantage of using the OCM in the closed loop analysis in [18] is evident in the sense that the optimal control model minimizing the tracking error tends to minimize the low frequency droop as well as to reduce the closed loop resonance peak. In doing this, OCM will automatically adjust for the best bandwidth required to achieve the pilot's objectives.

Another application of closed-loop analysis technique using the OCM as model is given in [19]. In this work, Anderson and Schmidt extended the classical Neal-Smith analysis to the approach and landing task. The handling qualities assessment of this inherently MIMO task was performed by introducing an equivalent SISO frequency response and by plotting the pilot's phase compensation against a sensitivity parameter related to the closed loop resonance peak.

Although the closed-loop analysis in a Neal-Smith type of framework has given a considerable validation to the optimal control model, one of the major efforts, in the verification of the model capabilities, has been the relation between the model's index of performance and the pilot's subjective ratings. Some of the work in this area is reported in [20], [21], [22] and, more recently, in [4], [23].

The definition of a rating metric from pilot modeling techniques was introduced by Anderson (1970) and his "paper pilot." Anderson defined a minimum rating algorithm, implementation of a function of explicit model parameters (lead, lag) and performance (RMS errors). Following this approach, the use of the OCM's index of performance as a rating metric was hypothesized by Hess based on prior work by Dillow and Picha [21]. Hess suggested that, under three main assumptions, the numerical value of the index of performance resulting from the modeling procedure could be related to the numerical pilot rating assigned to the vehicle and task by the pilot via a monotonic function $R(J)$ which depends on the rating scale used. The use of the performance index J as a rating metric has been the obvious choice, since the OCM attempts to obtain a control strategy which indeed minimizes J . In addition, the task objectives and the mental as well as the physical aspects of the pilot's workload can be thought to be represented by the quadratic terms in J . Hess' results, which reflect the analysis of 19 different vehicle/task configurations are summarized in Figure 6. The figure contains two graphs. The first shows a logarithmic relation between pilot ratings and J . The second is the dependence between pilot ratings and the attentional allocation to the control of the task. This second graph gives an indication of how the workload, associated to allocating the control attention to the various channels in a multi-input task, affects the rating of the closed-loop system.

The idea of monotonic relation between pilot ratings and index of performance was also validated in [22] using a set of configurations from Arnold's work and flight tested by Neal and Smith. The correlation, however, appears to be variable in that the rating sensitivity (slope) changes depending on the task, aircraft and pilot model parameters. All of these factors must be carefully evaluated in order to determine a meaningful rating metric from the performance index.

Finally, an application to a multi-axis task is given in [4]. The OCM has been used to predict pilot opinion ratings from a collection of experimental single-axis and simultaneous three-axis tracking tasks [24]. The pilot ratings were obtained from the relation $PR = 7.7 + \log J$ with J being the sum of the performance indices relative to each axis. The results are shown in Figure 7, indicating that the performance index of the OCM indeed shows potential for the development of subjective ratings for multi-axis tasks.

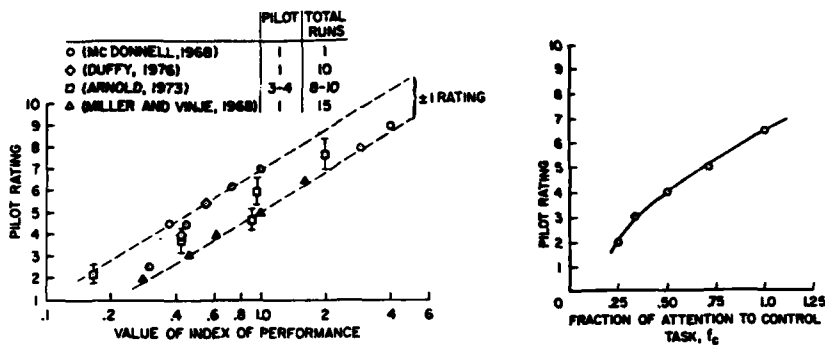

Figure 6. Pilot Rating vs. Performance Index Relation. [20]

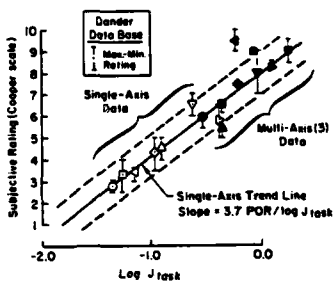

Figure 7. PR vs. J for Multi-Axis Tasks (Dander data [4]).

4. CLOSED LOOP PILOT-VEHICLE ANALYSIS

The optimal control model has been widely used in the past in the analysis of a variety of components of the manual control loop. In this section, some of the applications will be examined which deal with the analysis of particular aspects of the control system configuration, such as loop time delay evaluation and display analysis, as well as with the computation of critical pilot parameters like the workload assessment and the attention allocation in multi-axis tasks.

It is generally recognized that the presence of time delays in manually controlled systems can lead to degraded performance and potential closed loop instability. The problem becomes particularly critical in modern high performance aircraft where delays are inherent to the system, due to complex digital

control law implementation and phase lags associated with high-order controller dynamics. One of the potential effects of time delay is the degradation in handling qualities due to pilot-induced oscillations arising from the over-compensation necessary to eliminating of the equivalent loop lags. The OCM has been successfully applied by Hess [25] in identifying PIO prone configurations derived from different in-flight test data. In his work, he related an effective time delay due to higher order dynamics or a real time delay to the pilot-vehicle crossover frequency as predicted by the optimal control model of the pilot. The relation found by Hess was applied to several configurations resulting from independent in-flight test data run at NASA-Dryden at Calspan and Princeton. The results, taken from [25] are shown in Figure 8.

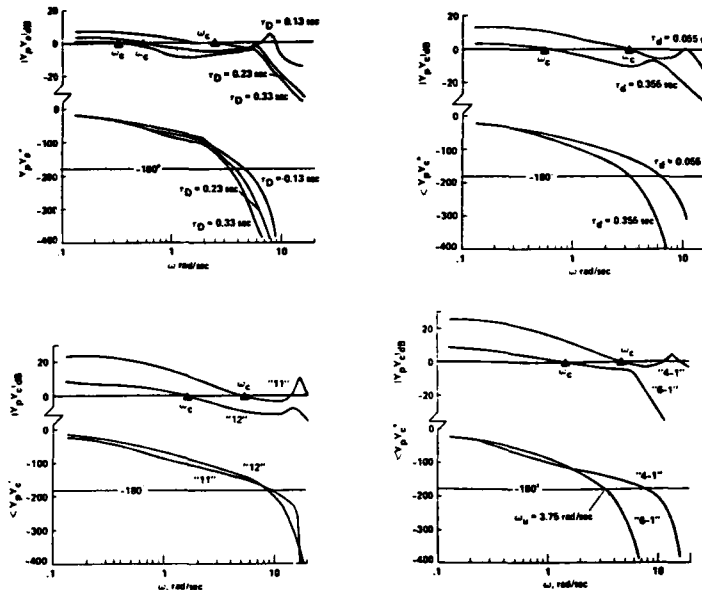

Figure 8. Influence of Loop Delays on the Open Loop Crossover Bandwidth. [25]

Two comments can be made by looking at the results in Figure 8. The first is that the open-loop crossover frequency ω_c can be reduced by varying the aircraft dynamics in a way as to increase the effective time delay. The second point is that the increase in time delay produces a slope less than -20dB/dec indicating the need of pilot equalization to restore K/s like characteristics of the open-loop system Y_p/Y_c . Poor transient performance can be identified by noting that $K_v = \omega_c$. The need for improved transient response would then imply an increase in static gain leading to potential low damped oscillations which are a necessary component of a PIO excitation. This fact was verified through the flight test results which showed configurations 12 and 6-1 of Figure 8 to be PIO prone configurations in the presence of small static gain increases.

Another example of the analysis of time delay using the OCM can be found in [26] where predicted performance were compared with manual simulation (both ground based and in-flight) performed by Calspan.

One of the most prolific applications of the OCM has been the analysis of the effect of display parameters and dynamics on the overall manual control loop. The dynamics of advanced displays play an important role in the pilot's evaluation of the handling qualities of flight vehicles. It has been shown that display dynamics may alter the pilot's opinion in rating the manual control loop. Future aircraft will present advanced display systems for controlling as well as monitoring the various phases of a mission and the amount of information displayed as well as its dynamic content are as important as the characteristics of the pilot's control manipulation in defining the pilot's role and capabilities in relation to the automated functions.

In [23] a simple second order transfer function model was used for the display dynamics in order to rate the displays according to different damping, bandwidth and time delay values. Two different plant dynamics were used and experimental data was obtained which included RMS tracking performance and pilot ratings (the Donnell's four scale system was used for the ratings). An optimal control model of the pilot behavior was then used and experimental and predicted pilot ratings were related. The OCM pilot rating prediction was in fact able to separate badly rated configurations from the good ones.

While the analysis in [23] focused on the relation between display dynamics and predicted pilot ratings, other studies evaluated the display characteristics based on increasing workload due to attentional demand [27] and task interference [28]. The basic hypothesis behind the display/workload relation is the use of equations (2) and (3) to represent respectively display variables (including quickening and flight director capabilities) and the lumped human randomness whose invariance with a variety of control tasks makes it a processing limit of the human operator under "idealized" displays

(no thresholds). Baron and Levinson [28] modified the display variable covariance to account for thresholds from equation (3) to

$$v_{y_i} = v_{y_{i_f}} + v_{i_o} \quad (17)$$

where $v_{y_{i_f}}$ contains the threshold's contribution and it is given by equation (3). Both terms on the RHS of equation (17) contain the observation noise/signal ratio P_i which is associated with the operator's central processing capabilities. This relation led to a model for task interference and operator workload using attention sharing factors at different levels. By letting

$$P_i = P_o \cdot \frac{1}{f_c} \cdot \frac{1}{f_g} \cdot \frac{1}{f_l} \quad (18)$$

with $P_o = -20\text{dB}$ as baseline signal/noise ratio, the attention allocation can be divided into fractions f_l (control related - monitoring tasks), f_g (longitudinal - lateral subtasks), f_l (attention devoted to the i th display in subtask s). With some assumption regarding the attention sharing and interference, we have $f_{l_1} = 1$, $f_{g_1} = 1$. The third attentional allocation term is taken to be a free parameter when performing performance/workload tradeoffs.

The procedure for determining the pilot's workload outlined before was used in [28] for the evaluation of a baseline status display and an advanced integrated display is a task simulating a commercial transport in a straight standard approach. A schematic of the electronic attitude/director indicator used in [28] is shown in Figure 9. The advanced display adds a perspective runway, an extended centerline and

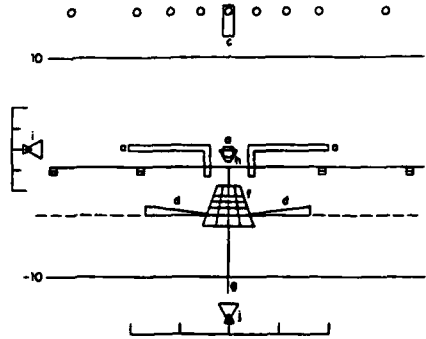

Figure 9. Display Indicator for Workload/Attention Sharing Analysis. [28]

a track angle indicator (f,g,h) to the baseline display. The displays were analyzed for two different autopilot modes (control wheel steering of attitude and velocity) and the results were based on RMS error performance as functions of the workload and attention sharing ratio.

An index of pilot's workload using the OCM was also determined by Wewerinke [29] which extends the work by Baron and Levinson.

In his work, Wewerinke was interested not only in the attainable performance predicted by the OCM, but also in obtaining an absolute index of the difficulty of the control task. Six standard SISO compensatory tracking tasks were simulated and frequency responses as well as normalized subjective ratings and RMS scores were collected for further analysis. Defining the workload index W as the ratio S/P , where P is the signal/noise ratio and S is the sensitivity of the RMS performance with respect to P , a good correlation was obtained between predicted workload W , RMS performance σ_m^2 and subjectives ratings as shown in Figure 10.

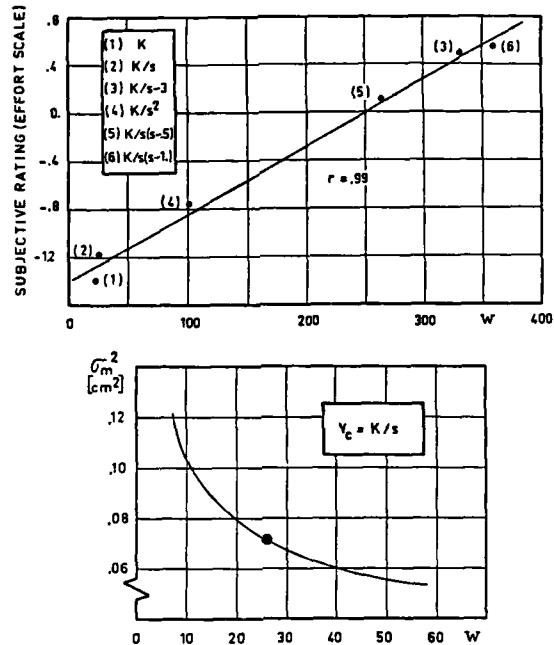

Figure 10. Prediction of Subjective Ratings via Workload Index. [29]

5. CLOSED LOOP PILOT-VEHICLE SYNTHESIS

Maybe the most desirable feature of any algorithmic methodology is its capability of contributing in a synthesis and/or a design process. One of the ultimate goals of the optimal control model is, in the author's opinion, its use in designing a satisfactory manual control loop which complies with the designer objectives. A sound, reliable pilot model should help the engineer, in the preliminary phase of the design process, in the evaluation of alternative displays/information systems, in comparing candidate inner loop and outer loop automatic closures, in choosing onboard computer speed and sampling rates so that the manual control loop presents the best flying qualities characteristics in terms of standard requirements, pilot opinion ratings and performance/workload tradeoffs.

Keeping in mind the always present necessity of experimental validation, several attempts have been made in the past to utilize the optimal control model for the synthesis of various components of the manual control loop, using the model for off-line computation, as well as for on-line simultaneous synthesis. The two examples considered in this section are stability augmentation synthesis (SAS) and display design.

In the mid and late 70's the increased availability of high power, high authority flight control systems has led to the development of the first prototypes aircraft possessing non-conventional dynamic characteristics and advanced task-tailored control modes. Quantitative handling qualities specifications were not applicable and at the present time it is still not clear how to determine and judge active control technology implementation and the actual improvement of the man-machine loop.

In this context, a cooperative augmentation synthesis was developed [30], [31] in order to indicate the most appropriate SAS in terms of predicted pilot ratings via OCM. The cooperative control approach uses the optimal control model algorithm as an active element of the control loop in the sense that the OCM's index of performance indicates how well the inner-loop dynamic element will satisfy the handling qualities requirements. The "optimum" SAS is then obtained by simultaneous minimization of its own performance index (based on mission performance) and the pilot's model cost (known to be an indicator of handling qualities characteristics).

In [30] the stability augmentation system synthesis for air-to-air tracking task was considered, with the plant dynamics inclusive of the display sight dynamics as well. The resulting augmentation system gave better RMS performance and better predicted handling qualities characteristics as shown in Figure 1 of [30], where K/s like crossover was obtained for the loop transfer function, as well as a reduced pilot lead required at crossover. In [31] the cooperative approach was used for the SAS synthesis of an unstable aircraft. The index of performance to be minimized by the SAS synthesis procedure contains the pilot's model cost F_p so as to obtain a global inner loop with satisfactory handling qualities characteristics.

The results of the cooperative synthesis procedure, for a pitch tracking task are shown in Figure 11. They are expressed in the Neal-Smith form and shown in the figure are two candidate SAS laws and two other autotuners derived from the literature (C1, C2, C3, C4, respectively).

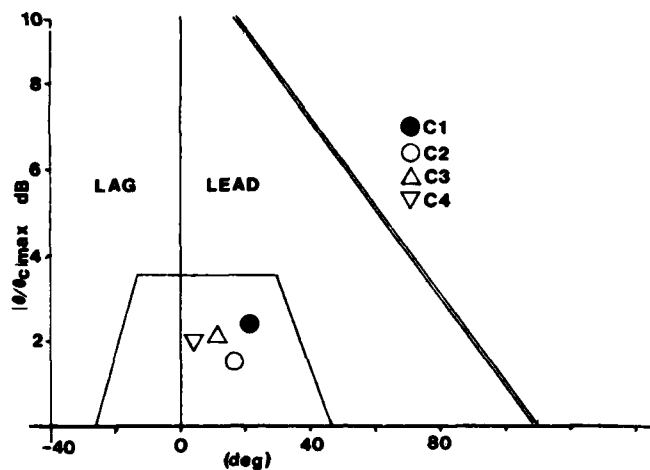
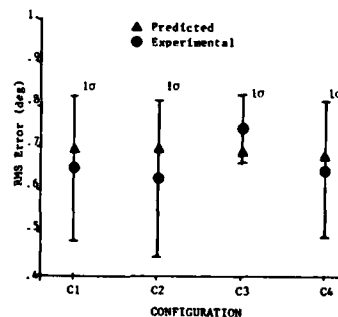

Figure 11. Handling Qualities Prediction Using Cooperative Control Techniques.[31]

All four candidate designs show Level 1 characteristics; however, lower workload was predicted for the cooperative controllers (based on lower stick rate activity).

An experimental validation of the predicted results from [31] was carried out in [15] using a fixed-base simulator. The results showed consistent agreement in terms of RMS tracking error and stick rate and in terms of predicted and experimental pilot ratings, as shown in Figure 12, below.

PR	C1			C2			C3			C4		
	Run 1	Run 2	Run 3	Run 1	Run 2	Run 3	Run 1	Run 2	Run 3	Run 1	Run 2	Run 3
10												
9												
8												
7												
6												
5					B							
4	C	BC	C	B	B					B		
3	B	B					CA	C	CA			
2	A	A	AC	C	CA	B	B	B	C	BC	BC	
1	A				A		A		A			A



Pilot Rating from Simulation

Figure 12. Experimental Validation of Cooperative Control Synthesis. [15]

Another application of the cooperative approach idea has been suggested in [23] and developed in [32]. In this case, the objective was the synthesis tradeoff between display and controller augmentation with explicit inclusion of pilot-centered requirements from an optimal control model. Although the effect of display dynamics and control system dynamics are known to contribute to the overall pilot ratings in flying high performance aircraft, the two problems have usually been analyzed separately in the past. The

analytical work in [32] and some experimental results in [33] show the potential for a global approach to the synthesis problem using the OCM as one active component of the control loop. The idea in [32] was applied to a simple double integrator plant indicating that a simultaneous display and control augmentation would lead to lower OCM performance index values compared to separately augmenting the display dynamics and the plant dynamics. In addition, the chosen candidate design would produce an integral behavior for the open loop transfer function over a wider frequency range.

The control/display cooperative synthesis has been applied in [33] as a predictive tool in the evaluation of a multi-axis X-22A at hover. Different control augmentation schemes were implemented (attitude, rate, attitude-rate combination) and two display formats (ED-2, ED-3) were considered. Figure 13 shows the relation between experimental pilot rating and the optimal control model performance index given by the sum of the longitudinal and lateral components. A model-based frequency domain analysis revealed, furthermore, that while display augmentation would reduce the workload without affecting the performance (RMS scores), control augmentation would lead to both workload reduction and performance improvement.

The display synthesis procedure, based on pilot-centered information, has received a lot of attention in recent years. Hess used the OCM to obtain a semi-algorithmic procedure for the design of a flight director display in a UH-1H helicopter in a landing approach task involving longitudinal and lateral degrees of freedom [34]. His design procedure used the pilot rating/index of performance relation as well as workload and attention allocation measures to come up with the design flowchart and candidate display shown in Figures 14 and 15, respectively.

Automated control/display design was also suggested in [35] using a four-step procedure which would start from the information requirements stage, followed by control/monitor performance, pilot/automatic control task allocation and leading to the display format design. The method was applied to a CH-47 helicopter in hover and approach, using displays with and without flight director information and with different levels of control system automation. Several results were proposed in [35]. First of all a validation of OCM as three-levels model (information, display-element, display-format). Secondly, the necessity of workload metrics for both monitoring and control tasks was suggested in order to represent the human performance at different levels of control automation.

Another application of OCM to the display design problem is given in [36], where four candidate display systems were proposed and rank-ordered according to workload and performance. The particular application consisted in the determination of information and display requirements for a terrain following task. The four-step procedure of [35] was used and validated through simulation, indicating the superiority of flight director over the other candidate displays (predictor, tunnel display, integrated tunnel-predictor).

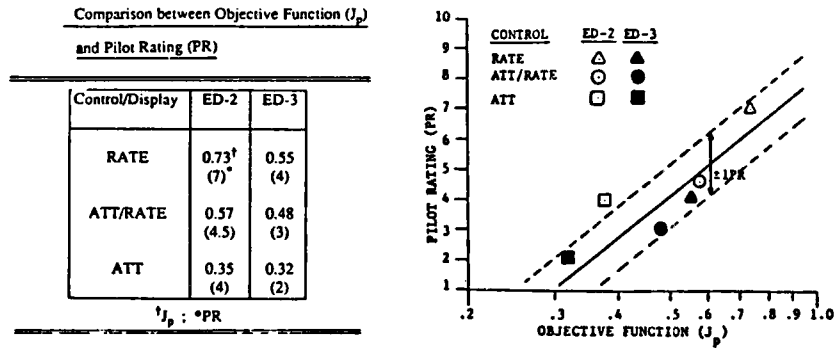

Figure 13. Correlation between Pilot Rating and Performance Index for Various Control/Display Combinations. [33]

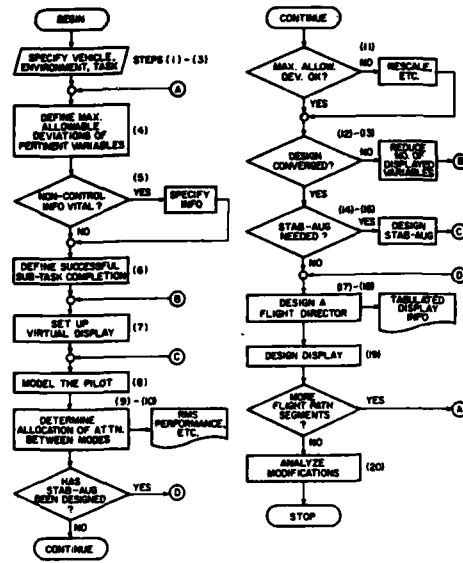

Figure 14. Potential Display Design Procedure using OCM. [34]

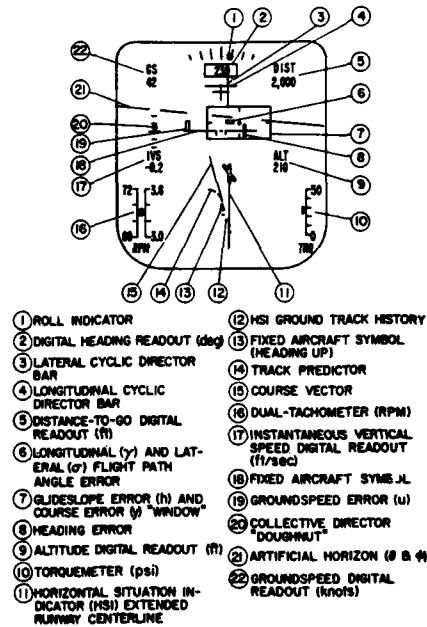

Figure 15. Resulting Display Design using OCM.[34].

7-16

6. CONCLUSIONS

Research in flying qualities has always merged several different disciplines: from flight dynamics to control theory, from statistics to human factors, from applied mathematics to extensive ground and in-flight simulation. The central point of the effort is the evaluation of the processing capabilities of the human operator as an active component of the manual control loop, in order to design the best pilot/aircraft integration in terms of mission performance.

One of the aspects of flying qualities research has been the modeling of the human controller to solve unexplained experimental results as well as to predict new, untested flight situations. The development of pilot models has often used control theory tools in an attempt to quantify those human characteristics which dominate during flight vehicle control operations. In this context, the optimal control model has been developed in the early 1970's and widely used with a high degree of success. Applications of the model cover practically all the aspects of a control task, from the analysis of the aircraft dynamics to the design of advanced display concepts, from the validation of the pilot's behavior to pilot rating prediction and integrated pilot/vehicle synthesis.

The advantages of optimal control theory make the model an appealing tool for quantifying the human's behavior in multi-axis control and some preliminary results appear to be promising in the complex area of system monitoring and attention sharing.

The optimal control model, however, has some difficulties. First of all, the complete internal model must be known, at least in the original OCM formulation, and such a knowledge is difficult to obtain. The optimal control model suffers from overparametrization making the identification of the model parameters from experimental data not always possible. Finally, the optimal control nature of the model requires the fitting of the manual control objectives into a quadratic functional cost. The problems outlined above have been analyzed in the past and even though they do not pose a limitation to the use of OCM, they must be kept in mind.

The optimal control model of the human pilot, as any other mathematical model of human behavior, shows its greater capabilities when used in tasks for which the model is appropriate. In addition, its capabilities are fully exploited when used in conjunction with other models so as to have the largest and most accurate representation of human behavior.

ACKNOWLEDGEMENT

The author wishes to thank Dr. Ing. Franco Sella of Aeritalia (GVC) SpA and member of the AGARD Flight Mechanics Panel for his interest in pilot modeling techniques, which made this contribution possible.

REFERENCES

1. Kleinman, D. L., Baron, S., Levinson, W. H., "An Optimal Control Model of the Human Response, Part I: Theory and Validation, Part II, Prediction of Human Response in a Complex Task," *Automatica*, Vol. 6, 1970.
2. Tustin, A., "An Investigation of the Operator's Response in Normal Control and its Implications for Controllers Design," *IEE Journal*, 94, 1947.
3. McRuer, D., "Human Dynamics in Man-Machine Systems," *Automatica*, Vol. 16, pp. 237-253, 1980.
4. McRuer, D., Schmidt, D. K., "Pilot-Vehicle Analysis of Multi-Axis Tasks," AIAA-87-2538, Atmospheric Flight Mechanics Conference, Monterey, California, August 1987.
5. Baron, S., Levison, W. H., "The Optimal Control Model: Status and Future Directions," IEEE paper, 1980 (unavailable Ref.).
6. Weverinke, P. H., "Mathematical Models of Manned Aerospace Systems," AGARD-CP-260, paper 25.
7. Kleinman, D. L., "Optimal Linear Control for Systems with Time-Delay and Observation Noise," *IEEE, Trans-AC-14*, October 1969.
8. Thompson, P. M., "Program CC's Implementation of Human Optimal Control Model," AIAA Guidance, Navigation and Control Conference, Monterey, California, August 1987.
9. Curry, R. E., Hoffman, W. C., Young, L. R., "Pilot Modeling for Manned Simulation," Vol. I, AFFDL-TR-76-124, ASI, 1976.
10. Doyle, K. M., Hoffman, W. C., "Pilot Modeling for Manned Simulation," Volume II (PIREP MANUAL), AFFDL-TR-76-124, ASE 1976.
11. Levison, W. H., Baron, S., Junker, D. M., "Modeling the Effects of Environmental Factors on Human Control and Information Processing," AMRL-TR-76-74, 1976.
12. Phatak, A. V., et al., "Identification of a Modified Optimal Control Model for the human Operator," *Automatica*, Vol. 12, 1976.
13. Phatak, A. V., "Formulation and Validation of Optimal Control Theoretic Models for the Human Operator," *Systems, Man and Cybernetics Review*, 1977, b(10).

14. Peopaka, S., "Handling Qualities of Large Flexible Aircraft," Ph.D. Thesis, Oklahoma State University, 1980.
15. Innocenti, M., Schmidt, D. K., "Integrated Pilot-Optimal Augmentation Synthesis for Complex Flight Vehicles: Experimental Validation," MARCON 83, Dayton, Ohio, May 1983.
16. Hess, R. A., "A Pilot Modeling Technique for Handling Qualities Research," AIAA-80-1624/
17. Arnold, J. D., "An Improved Method of Predicting Aircraft Longitudinal Handling Qualities Based on the Minimum Pilot Rating Concept," AFIT-GGC/MA/73-1, 1973.
18. Bacon, B. J., Schmidt, D. K., "An Optimal Control Approach to Pilot/Vehicle Analysis and the Neal-Smith Criteria," AIAA Journal of Guidance, Control and Dynamics, Vol. 6, No. 5, September-October 1983.
19. Anderson, M. R., Schmidt, D. K., "Closed-Loop Vehicle Analysis of the Approach and Landing Task," AIAA Journal of Guidance, Control and Dynamics, Vol. 10, No. 2, March-April 1987.
20. Hess, R. A., "A Method for Generating Numerical Pilot Opinion Ratings Using the Optimal Pilot Model," NASA-TM-V-73, 101, 1976.
21. Hess, R. A., "Prediction of Pilot Opinion Ratings Using an Optimal Pilot Model," Human Factors, 1977, 19(5).
22. Schmidt, D. K., "On the Use of the OCM's Quadratic Objective Function as a Pilot Rating Metric," 17th Annual Conference on Manual Control, Los Angeles, California, June 1981.
23. Innocenti, M., "Analytical Pilot Modelling Techniques for Display Dynamics Synthesis," Human Decision Making and Control, North Holland Press, 1987.
24. Dander, V., "An Evaluation of Four Methods for Converting Single Axis Pilot Ratings to Multi-Axis Pilot Ratings using Fixed Base Simulation Data," AFIT, GE/EE/62-4, December 1962.
25. Hess, R. A., "Analysis of Aircraft Attitude Control Systems Prone to Pilot-Induced Oscillations," AIAA Journal of Guidance and Control, Vol. 1, No. 1, January-February 1984.
26. Levison, W. H., Papazian, B., "The Effects of Time Delay and Simulator Mode on Closed-Loop Pilot/Vehicle Performance: Model Analysis and Manned Simulation Results," AIAA-87-2371, 1987.
27. Baron, S., Levison, W. H., "an Optimal Control Methodology for Analyzing the Effects of display Parameters on Performance and Workload in Manual Flight Control," IEEE-TR-Systems, Man, and Cybernetic, Vol. SMC-5, no. 4, July 1975.
28. Baron, S., Levison, W. H., "Display Analysis with the Optimal Control Model of the Human Operator," Human Factors, 1977, 19(5).
29. Weverinke, P. H., "Human Operator Workload for Various Control Situations," 10th Annual Manual Conference, WPAFB, June 1974.
30. Schmidt, D. K., "Pilot-Optimal Augmentation for the Air-to-Air Tracking Task," AIAA Journal of Guidance and Control, Vol. 3, No. 5, September-October 1980.
31. Innocenti, M., Schmidt, D. K., "Quadratic Optimal Cooperative Control Synthesis with Flight Control Application," AIAA Journal of Guidance, Control and Dynamics, Vol. 7, No. 2, March-April 1984.
32. Garg, S., Schmidt, D. K., "Cooperative synthesis of Control and Display Augmentation," AIAA-86-2204, Guidance and Control Conference, Williamsburg, Virginia, August 1986.
33. Garg, S., Schmidt, D. K., "Model-Based Analysis of Control/Display Interaction in the Hover Task," AIAA-87-2287, Atmospheric Flight Mechanics Conference, Monterey, California, August 1987.
34. Hess, R. A., "Analytical Display Design for Flight Tasks Conducted under Instrument Meteorological Conditions," NASA-TM X-73146, August 1976.
35. Curry, R. E., Kleinman, D. L., Hoffman, W. C., "A Design procedure for control/Display Systems," Human Factors, 1977, 19(5).
36. Korn, J., Gully, S. W., Kleinman, D. L., "Validation of an Advanced Cockpit Display Design Methodology via Workload/Monitoring Tradeoff Analysis," 18th Annual Manual Conference, Dayton, Ohio, June 1982.

THE ROLE OF SIMULATION IN FLYING QUALITIES AND FLIGHT CONTROL SYSTEM RELATED DEVELOPMENT

by

A.G.Barnes
 British Aerospace plc
 Warton Aerodrome, Preston, PR4 1AX
 United Kingdom

Summary

Flight Simulation makes a vital contribution to the understanding of flying quality requirements and to the clearance of modern aircraft flight controls. The background to the use of simulators, both airborne and ground-based is presented, and the experimental techniques, including validation and hardware requirements are discussed. The limitations which equipments can impose are presented, and examples are given of the use of flight simulation in flying qualities research. Finally, the techniques required for the clearance of current designs are highlighted, and a direction for future research is indicated.

1. Introduction

As the last contributor, I can add very little to the expert advice which has been given, on the current status of flying qualities requirements. It is a subject that has grown in importance over the past forty years. The growth is due to the increased demands on the pilot's control capabilities, as aircraft performance increased, and the flight envelope of new designs expanded. All the previous speakers have played major roles over the years in the progress that has been made.

My topic is the use of flight simulation for Flying Qualities Research - the equipments which are in every day use, and the techniques which we apply. although my experience lies in the use of ground based simulators, I do not wish to exclude airborne flight simulators from the discussion.

I will cover the important topic of simulator fidelity and validation to indicate the strengths and weaknesses of the equipments we do. I will give examples of the use of simulators in Flying Qualities Research. I will conclude with comments on what the future holds - equipment improvements, and how aircraft design and specification needs may dictate these improvements.

To begin, however, I would like to spend a little time with some general remarks on flying qualities, and how they have related to simulator studies in the past. It is important to know where we are today, but it is equally important to know a little about the route that we took, and how we came to be here.

2. Handling Qualities and Flight Simulation

One of the earliest applications of the Research Simulator, in Industry and in University/Government Establishments was that of predicting the flying qualities of aircraft at the design stage. In the late fifties, analog computers were at a stage where it was possible to solve the six simultaneous differential equations which determine the small perturbation response of an aircraft in flight. It was a logical step to connect the computer to stick and pedals, to stimulate the response. Equally well, the response could be observed by connecting to the computer a set of flight instruments or a CRT.

Prior to this advance, prediction of flying qualities relied on comparing the values of parameters which could be easily calculated, with criteria based on these parameters (Reference 1). Examples of these parameters are seen on figure 1.

<u>Latera!</u>	<u>Longitudinal</u>
Rolling power, $\frac{pb}{2V}$,	Tail volume coefficient $\bar{V} = \frac{S' l_t}{S \bar{c}}$,
Spiral stability, $C_{l_A} C_{n_r} - C_{n_A} C_{l_r}$,	Manoeuvre margin, $H_M = \frac{-\delta C_{L_{max}}}{\delta C_L}$,
Dutch roll frequency and damping: $T_d, C_{\frac{1}{2}}$,	Period and damping of s.p. oscillation: $\frac{2\pi}{\omega}, C_{\frac{1}{2}}$,
Directional stability, C_{n_β} ,	Phugoid period and damping $\frac{2\pi}{\omega_p} = \frac{\sqrt{2g} V}{g}; \frac{1}{2\omega_p} \cdot \frac{\partial K}{\partial u}$;

Figure 1 1950's Handling Qualities Parameters

In the sixties, as aircraft performance increased, we were to see the limitations of such rule of thumb methods.

The analog computer improvements in the 1950's was paralleled by application of servo control theories to aircraft design. The use of irreversible power controls to move control surfaces on aircraft called for techniques previously confined to specialist applications such as gunnery. Once applied, the technique of considering the aircraft, the controls and the pilots as a closed loop system quickly followed (References 2,3,4,5). By this time, the computing to support this approach was available, and a new and powerful method of studying Flying Qualities was born.

The introduction of servo-analysis took flying qualities criteria from the time domain into the frequency domain. It also introduced closed loop criteria into flying qualities requirements - phase, gain, bandwidth - a whole new methodology for deciding whether or not satisfactory control would be achieved in a particular design.

In many respects, the 1960's were our heyday. Aircraft projects of various types were available, and the flying quality requirements were framed around linear, small perturbation, continuous systems. Analytical methods could deal with such assumptions, and the state of real time computing did not allow too many non linearities to be introduced. I remember a comment about an American paper describing a computer model of spinning, made by an English professor of Aeronautics, at an Agard meeting at Cambridge in 1966 (Reference 6). He expressed disbelief that spinning behaviour could be modelled. "Spinning is a capricious manoeuvre", he said, "and has elements of unpredictability. In particular, the interference effects of the lower wing on the top wing of bi-planes are considerable."

Such views on modelling changed, as the value of analytical and simulation techniques were appreciated. The prediction methods were seen to contribute to aircraft design, and the analytical methods helped explain how adverse characteristics could be eliminated. The result was that methods and criteria were incorporated into Flying Quality Specifications, both in the U.S. and in Europe. This was the start of a process that has continued to this day. Now, the sad fact is that there is a shortage of projects to which the latest Specifications can be applied.

3. Pilot Rating Scales

The qualitative nature of flying quality assessment calls for a consistent way to record pilot opinion. Verbal descriptions of handling qualities are unsatisfactory from an engineering standpoint, for many reasons. What is needed is a more formalised method to indicate the degree of difficulty associated with a flying task, in a form which can be easily handled.

In the fifties, several different approaches were tried. At Warton, we used the initials GMB (good, moderate, bad), and to distinguish levels within these categories, suffixes of + and a - were needed. We had in effect a nine point rating scale. Other workers used numbers, in particular, the groups at NASA Ames and Cornell Aeronautical Laboratories. A paper by George Cooper (ref 7) had the effect of introducing the concept for a ten point scale. (Figure 2)

	ADJECTIVE RATING	NUMERICAL RATING	DESCRIPTION	PRIMARY MISSION ACCOMPLISHED?	CAN BE LAUNCHED
NORMAL OPERATION	SATISFACTORY	1	EXCELLENT, INCLUDES OPTIMUM	YES	YES
		2	GOOD, PLEASANT TO FLY	YES	YES
		3	SATISFACTORY, BUT WITH SOME MILDLY UNPLEASANT CHARACTERISTICS	YES	YES
EMERGENCY OPERATION	UNSATISFACTORY	4	ACCEPTABLE, BUT WITH UNPLEASANT CHARACTERISTICS	YES	YES
		5	UNACCEPTABLE FOR NORMAL OPERATION	DOUBTFUL	YES
		6	ACCEPTABLE FOR EMERGENCY CONDITION ONLY*	DOUBTFUL	YES
NO OPERATION	UNACCEPTABLE	7	UNACCEPTABLE EVER FOR EMERGENCY CONDITION*	NO	DOUBTFUL
		8	UNACCEPTABLE - DANGEROUS	NO	NO
		9	UNACCEPTABLE - UNCONTROLLABLE	NO	NO
	UNPRINTABLE	10	"MOTIONS POSSIBLY VIOLENT ENOUGH TO PREVENT PILOT ESCAPE"		

* (failure of a stability augmenter)

Original Cooper scale

Figure 2

Subsequent work resulted in the definitive standard, reference 8, where the experiences of Ames and Calspan were combined. This standard of the resulting rating scale is seen on figure 3. We are warned in reference 9 that the background guidance contained in reference 8 is not given the same attention by users of the scale, as the scale itself. Its use requires a definition of the task to be performed, and the circumstances under which it is performed. These circumstances include the presence of secondary tasks, the environment and disturbances which might be encountered, and the piloting population likely to be the end users.

From the pilots' point of view, he arrives at a rating by means of a series of dichotomous decisions - controllable or uncontrollable, adequate performance or not, and then satisfactory or not. It is usual for the pilot to make a blind evaluation - in other words, without knowledge of the configuration under assessment (although he will be briefed on the nature of the experiment and the range over which parameters will be changed). This form of evaluation conducted either in

the air or on a ground based simulator, is very demanding on the pilot. It is surprising how often pilots elect to split a rating between two integers.

From the engineers' point of view, the output of the experiments has to be handled with care. The bare numbers are often variable or inconsistent, and reference to recorded comments is needed. Small sample size, and large deviations make general conclusions difficult to draw, and in any case, taking the average of the numbers obtained is open to criticism. But in the end, they provide a measure of acceptability, which is the information needed by the designer, to improve the performance of his machine.

Figure 3 HANDLING QUALITIES RATING SCALE

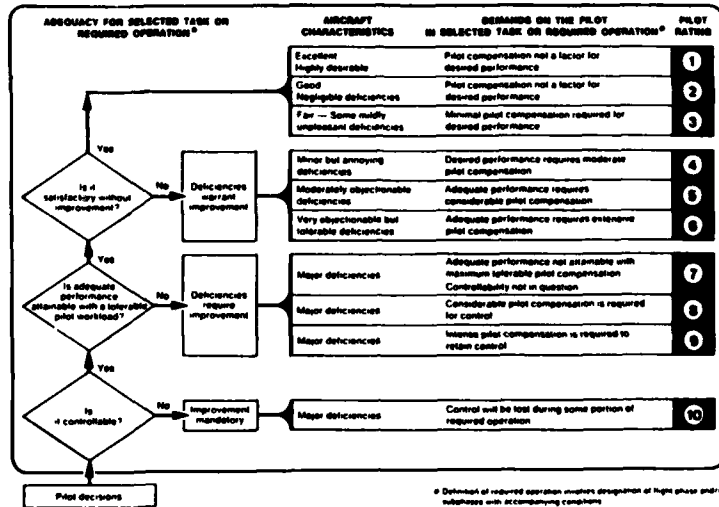

It is impossible to divorce from any discussion of pilot rating scales the concept of pilot work load. Methods of measurement of work load are inadequate for use in the interpretation of pilot ratings. Consequently, pilot rating methods are largely empirical. Criteria for acceptable handling are established from piloted experiments, either from ground based or airborne simulators, perhaps in the form of iso-opinion boundaries, such as those seen on figure 4. Alternatively, values of a handling qualities parameter, such as short period damping, can be assigned as bounds within which a standard of control will be achieved.

It is worth noting that handling qualities boundaries such as those on figure 4 relate only to the circumstances under which they were obtained - the equipment used, the flight condition simulated, and the task which was given to the pilot. Two of the longitudinal short period boundaries were from fixed based simulators, and one came from a variable stability aircraft. Similarly, one of the rolling criteria came from a variable stability aircraft, and the other from a fixed base simulator. Not apparent on these graphs are the influence of all the other factors which affected pilot ratings, and which invalidate comparisons between results of this type.

Criteria of this type were converted into mandatory requirements in the '60s (Reference 10) following long and detailed study (Reference 11). It formulated the concept of flying quality levels of desirability, based on the Cooper-Harper rating scale, depending on aircraft type category, aircraft state (including failure state), and phase of flight. It is a complex concept, which has been made even more complex as advanced flight control systems have been introduced. The specification of flying qualities requirements and their interpretation for aircraft design purposes now requires very specialised knowledge.

Simulator Equipment

A remarkable range of simulators is applied to Flying Qualities research. Reference 12 contains lists of Airborne and Ground Based Research Simulators, and the purpose for which they are used. Much the largest use of airborne simulators is associated with Flying Qualities research; ground based simulators are divided between flying qualities, systems, human factors, and simulator development. Useful work is possible on low cost simulators, restricted to simple display elements and linearised computer models of the aircraft.

8-4

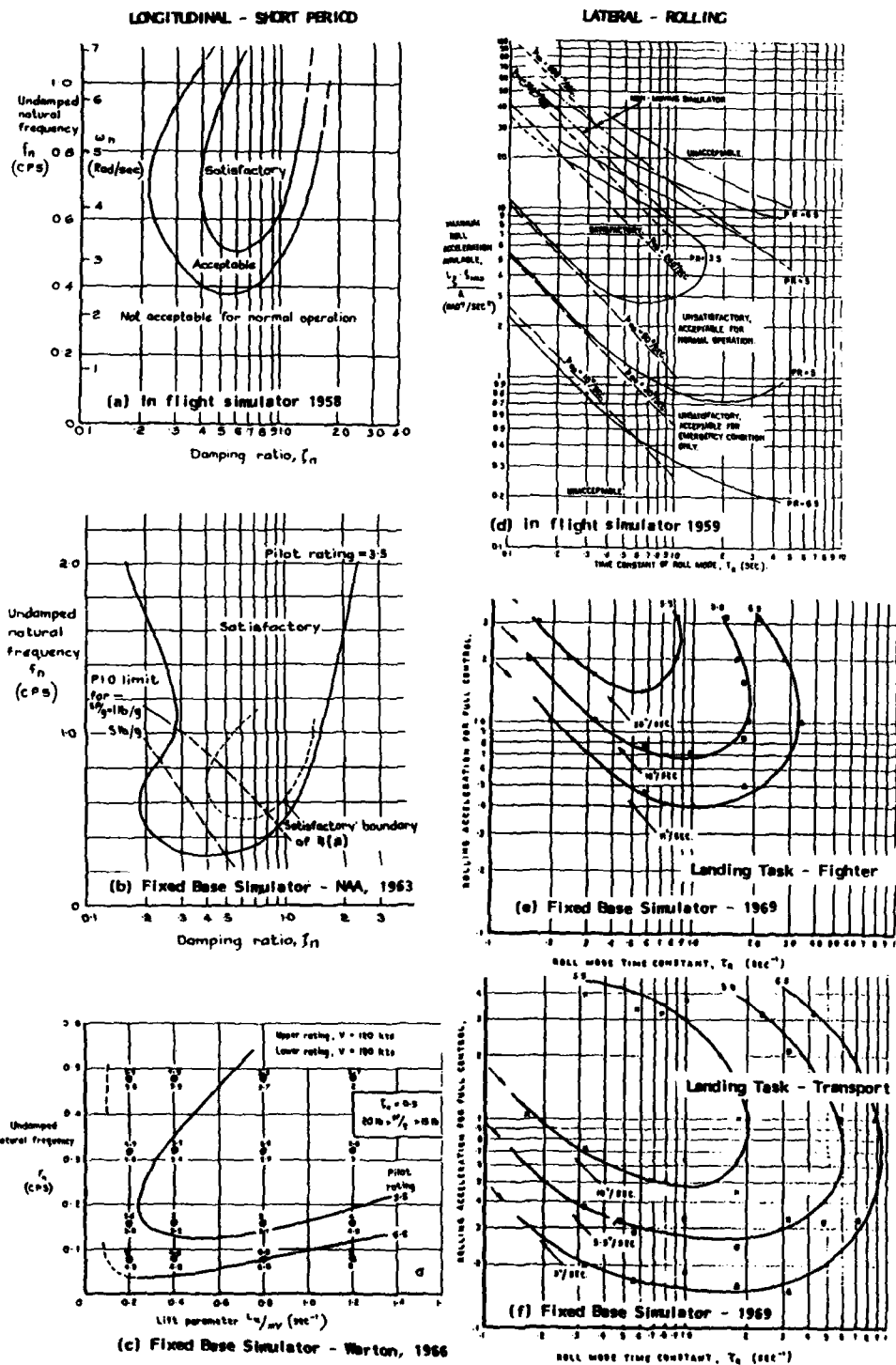
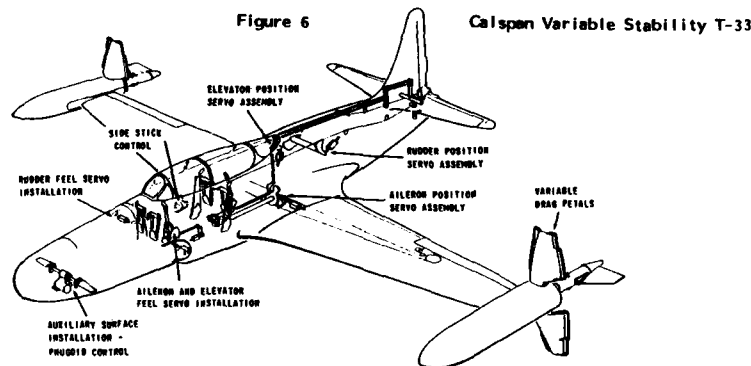

Figure 4 : Typical Handling Qualities Iso-opinion Plots



Figure 5 Boeing 1960 Fiat 1960
 Stick and Scope Simulators

In the fifties, airborne simulators, such as the B.26, F94A and T-33 at Cornell Aeronautical Laboratories had the most impact, in setting handling qualities design criteria. Doubts were expressed by proponents of variable stability aircraft about the validity of results from ground-based simulators. They considered that the assessments so obtained called for too great an extrapolation by the pilot, to predict how the experience would transfer to actual flight.



Since then, massive strides have been made in the technology of representing flight in a ground based simulator, and these doubts are now largely unfounded. The proponents of ground based simulators expressed concern about the cost/effectiveness of variable stability aircraft, and European countries were slow to follow the lead from the U.S. The increasing costs of the ground-based simulation facilities at the largest research establishments has blunted the argument. The situation today is that all the simulators have a part to play, and are proving their worth. The substantial investments being made in research and development simulators, ground based and airborne, in the U.S. and in Europe, is testimony to their prospective value. The high operating cost of airborne simulators and the more advanced ground based simulators limits the number of generalised handling qualities studies which can be funded. Consequently, a coordinated activity is required which combines analysis, low cost simulation, and advanced facilities, to construct handling qualities criteria applicable to new configurations.

A research simulator breaks down into several components. The requirements for each of these components are discussed below.

4.1 The Cockpit

For most handling quality studies, there is no need to use a tailor-made cockpit, representing a particular aircraft. Clearly, it is better to represent transport aircraft in a cockpit similar to those in transport aircraft, and the seating position used to represent fighter aircraft should correspond in terms of geometric location relative to stick, controls, and displays. Cockpit displays used by the pilot in the handling assesment, for example a head up display and flight instruments must be functional.

4.2 Stick Feel

An accurate representation is essential of the stick force gradient, friction, travel, non-linear gearing and other relationships between the pilot's input and control surface deflection. In the past, programmable hydraulic force-feedback feel systems have been necessary in many investigations. Current aircraft, using fly-by-wire manoeuvre demand systems do not require the simulation of mechanical control runs - the signals are taken from the stick unit in the cockpit. Simulating the stick feel is therefore an easier proposition.

8-6

4.3 Modelling

Computing power is no longer a restriction to the complexity of the model of the aircraft and flight control system. As a result, some work is possible with simple models, in other cases, the model is comprehensive. The need for a comprehensive model appears when the area of investigation can no longer be described in terms of linearised small perturbation equations. This situation arises more and more, partly because the airframe designer is clearing his aircraft closer to departure boundaries than in the past, and partly because the flight control designer can use complex control algorithms to achieve his purpose. Digital computers are in universal use for modelling. Models used for flying qualities work must have a high iteration rate - better than 300 solutions per second is desirable. Otherwise, modelling time delays will intrude into the assessment. For work related to advanced control system designs, the computing task is large. For example, for EAP development, the computers can handle 8 Megaflops, and overall memory is 100 Megabytes.

In these circumstances, ground based simulators have the advantage over airborne simulators, because more comprehensive computing facilities can be provided in a ground installation.

4.4 Visual Display

Once again, the type of work determines the display requirement. Symbols on a scope may be sufficient to study a pilot transfer function in a tracking task. At the other end of the scale a study of lateral departure at high incidence may need the full field of view systems only seen in Air Combat Simulators. Handling quality assessments relating to flight close to the ground, for example, approach and landing, need a three channel CGI system of good quality (reference 13). Again, display deficiencies, such as time delay or resolution can sometimes affect the assessments. The variable stability aircraft has a big advantage in this respect.

4.5 Motion System

One of the areas of research for ground-based simulators has been to determine the contribution which motion cues can give, and to determine the validity of simulations which have limited travel or do not provide motion cues. It is a difficult area of investigation, and there is no end in sight. Views on the need for motion differ, although the following guidelines may help:

- o to give accurate motion sensations requires high performance and large travel, outside the capability of most research establishments,
- o it is better to have no motion, than a system which gives false cueing,
- o motion systems are of most importance in handling investigations where stability margins are low (e.g. the pilot is stabilising the vehicle), or in studying failure cases involving a transient response, or in studying the effects of turbulence on flying qualities,
- o a small travel motion system can be used with advantage for subjective cueing, simply to add realism to the simulation.

Provided that it can achieve the required flight condition and provided that the model suppresses the response of the basic aircraft to outside disturbances, the variable stability aircraft clearly can represent accurate motion feedbacks.

4.6 General

These equipments are linked together to provide a research tool. The manner of integration has a strong bearing on the effectiveness of the tool. The link between the motion system and the visual system is self-apparent. Equally, there is a need to select the operating system, which links the computer to the other elements, for easy operation. Successful investigations require the ability to repeat cases quickly, to change parameters quickly, and to record qualitative and quantitative results. Perhaps the most important asset is a knowledgeable and dedicated team.

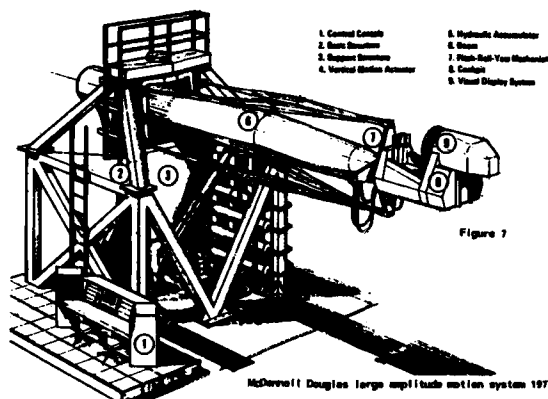

5. Validation

It has often been said "no simulation without validation". The question then arises - how do we validate a simulator for use in the study of flying qualities? In some circumstances, full validation only comes when the simulated vehicle is flown - for example, when an unstable airframe which relies on the flight control system for stabilisation is being developed. Prior to that however, confidence has been built up, based on knowledge and experience. It is equally important to know the areas where shortcomings in the simulation will lead to erroneous results, as it is to offer predictions of likely behaviour. The subject is discussed in reference 14, from which the following paragraphs are taken.

"The key to obtaining valid results are:

1. Know your simulator
2. Structure the test
3. Value the pilot

"Fidelity has many dimensions: crew station realism, vehicle model, visual scene, motion and sound, and in each dimension there are many parameters which influence fidelity. Since one-to-one engineering replication cannot be obtained, especially in the dimensions of visual and motion effects, the question becomes one of perceived fidelity.

"Simulation validation before the start of any evaluation tasks should be a four step process.

1. Document simulation equipment performance
2. Conduct non-real time model checks (compare to control law analysis results)
3. Conduct real time model checks
4. Conduct task checks

"With regard to item 1, a good check of the validity of the simulator is to model and "fly" an existing known aircraft. A rating scale like the one shown in Figure 8 can be used to assess validity. If flight data is available on the subject aircraft, the identical control inputs can be run in the simulator and the resulting time histories can be compared to flight data.

CATEGORY	RATING	ADJECTIVE	DESCRIPTION
SATISFACTORY REPRESENTATION OF ACTUAL VEHICLE	1	EXCELLENT	VIRTUALLY NO DISCREPANCIES; SIMULATOR REPRODUCES ACTUAL VEHICLE CHARACTERISTICS TO THE BEST OF MY MEMORY. SIMULATOR RESULTS DIRECTLY APPLICABLE TO ACTUAL VEHICLE WITH HIGH DEGREE OF CONFIDENCE.
	2	GOOD	VERY MINOR DISCREPANCIES. THE SIMULATOR COMES CLOSE TO DUPLICATING ACTUAL VEHICLE CHARACTERISTICS. SIMULATOR RESULTS IN MOST AREAS WOULD BE APPLICABLE TO ACTUAL VEHICLE WITH CONFIDENCE.
	3	FAIR	SIMULATOR IS REPRESENTATIVE OF ACTUAL VEHICLE. SOME MINOR DISCREPANCIES ARE NOTICEABLE, BUT NOT DISTRACTING ENOUGH TO MASK PRIMARY CHARACTERISTICS. SIMULATOR TRENDS COULD BE APPLIED TO ACTUAL VEHICLE.
UNSATISFACTORY REPRESENTATION OF ACTUAL VEHICLE	4	FAIR	SIMULATOR NEEDS WORK. IT HAS MANY MINOR DISCREPANCIES WHICH ARE ANNOYING. SIMULATOR WOULD NEED SOME IMPROVEMENT BEFORE APPLYING RESULTS DIRECTLY TO ACTUAL VEHICLE, BUT IS USEFUL FOR GENERAL HANDLING QUALITIES INVESTIGATIONS FOR THIS CLASS OF AIRCRAFT.
	5	BAD	SIMULATOR NOT REPRESENTATIVE. DISCREPANCIES EXIST WHICH PREVENT ACTUAL VEHICLE CHARACTERISTICS FROM BEING RECOGNIZED. RESULTS OBTAINED HERE SHOULD BE CONSIDERED AS UNRELIABLE.
	6	VERY BAD	POSSIBLE SIMULATOR MALFUNCTION. WRONG SIGN, INOPERATIVE CONTROLS, OTHER GROSS DISCREPANCIES PREVENT COMPARISON FROM EVER BEING ATTEMPTED. NO DATA.

Figure 8 RATING SCALE FOR SIMULATOR VALIDITY

"It is important to select pilots familiar with the art and science of simulation. The pilots must believe in simulation, take the job seriously and work hard at task demands. He must treat the simulator with the same frame of mind as he would the real aircraft.

"Pilots differ significantly one-to-the-other in their control techniques. Some are low gain operators, making a minimum of control inputs, while others are very high gained (dither) controllers. These different control techniques may cause one pilot to have little difficulty with a configuration while another pilot may uncover a control problem. It is therefore wise to have a variety of pilots in your evaluations. A minimum should be three, with five or more being preferred. Multiple pilots is more important than repeat runs."

"The objectives of the handling qualities engineer are

1. Inner loop stabilisation and control law development
2. Outer loop control integration
3. Development of stick, rudder pedals and throttle controllers
4. Development of flight displays
5. Ground handling including nose wheel steering and anti-skid braking
6. Testing of failure modes

"In these simulations, fidelity becomes critical. The fidelity of the math model of the vehicle/control system must be accurate and the visual and motion system, which provide cues used by the pilot in control, also become important. One of the big failings of the simulator community, however, is to rigorously define what fidelity is required to obtain the right answer. Although a large body of basic data exist on human perception, there is no source of compiled guidance on what degree of simulator fidelity must be used. The tendency has been to use the "best" simulator available. In fact, in the U.S., almost every new military aircraft developed has conducted an in-flight simulation as a last check before first flight. The experience of the in-flight simulations has quite often revealed concerns which had not been uncovered in the ground based simulations and which in some cases resulted in modifications to the control logic prior to the first flight".

Further valuable discussions on the topic of simulator fidelity are contained in reference 15. The contribution to simulator fidelity of the sub-systems are considered under the headings

motion effects
visual system fidelity
time delay effects

It is concluded that fidelity is a relative, rather than an absolute quantity, and that even the best of the large scale research simulators impose restrictions on the types of situations and tasks that can be faithfully simulated. Experiments are cited which compare pilot assessments of flying qualities, made in simulators and in flight. Use was made of the rating scale (figure 8) to give a measure of the degree to which the simulator represented the aircraft behaviour. One of the investigations discussed in detail is that of the UH-60 helicopter (reference 16). All the areas where pilot comments indicated the simulator to be unrepresentative of flight could, not surprisingly, be attributed to all or any of the three factors given above.

Of course, the helicopter, in terms of vehicle dynamics and tasks, presents greater problems to the simulator engineer than conventional fixed wing aircraft; the loop closures are higher order, and the dynamics of the vehicle are more complex. But the basic principles still apply, and the indications of deficiencies in motion cues, visual cues and dynamic response show where improvements will count.

Reference 15 contains a most instructive discussion on these topics. The data relating to motion cueing came from the LAMARS simulator at Flight Dynamics Laboratory at Wright-Patterson AFB (Figure 9). The results indicate the difficulties of this kind of work: of pilots adapting to produce similar performance, independent of the lateral-sway washout; of the need for non-linear washout filters to reduce the peak lateral motion. A closer look at reference 17 is recommended, and it is worth quoting the ambiguous reason for uncertainty in the conclusions - "the pilot comments were not always repeatable".

On the subject of visual system fidelity, the work reported in reference 18 is cited. The intention of this work was to vary the quality of the visual cues seen by a helicopter pilot, and assess in flight the intrusion into the flying task of the limitations of current CGI visual system. The limitations were acuity, detail, texture, contrast, and field of view. Again, reference to the original report is recommended. The significant findings seem to be that i) even though the pilots could see the horizon with reasonable clarity, their ratings of attitude cueing degraded dramatically with fogged lenses (poor micro-texture of the visual external field), and ii) their ratings of longitudinal and lateral translational control degraded, both with reduced field of view, and with the loss of micro-texture. The discussion in reference 19 may shed light on these results. Spatial orientation is largely derived from the ambient mode of vision, which requires a visual scene with good "spatial texture".



Figure 9 LAMRS Research Simulator, Wright Patterson AFB

The influence of time delays on simulator assessments of flying qualities also receives rigorous treatment in reference 15. In particular, the value of analytical models to determine the effect on loop closure of time delays from various components of the simulator is presented. In summary, "accumulated time delays from a variety of simulator component sources will cause reductions in the effective system bandwidth, relative to those in flight. If the bandwidth change occurs in a rating sensitive region, the simulator will be more poorly rated than flight for this reason alone. For region of flat rating trend with bandwidth, excessive time delay and associated phase lag will still lead to anomalous simulation results.

"Measurement of pilot behaviour in flight and simulator, directly as by frequency domain or model matching methods, or indirectly as by phase-plane trajectories is an invaluable tool for judging overall simulator fidelity. Further, it can produce direct or inferred insights into the specific causes of simulator difficulty and pin-point possible fixes or cures".

The fidelity of a simulation also depends on the task which is given to the pilot. A small perturbation tracking task may reproduce all the elements necessary for comparison with flight, whereas a complex loop closure, such as visual high speed low level flight may not. In this respect, a wealth of experience has been gathered over the years to cast doubt on the validity of ground based simulation in two areas.

1. Certain types of pilot induced oscillations, where the pilot is expected to stabilise a loop with marginal stability, and in consequence has to generate lead or lag, and change the cross-over frequency. Previous contributions to this Lecture Series illustrate the wide understanding that exists of p.i.o. related mechanisms. Now it is possible early in the design of a new aircraft to take account of p.i.o. situations, and reduce their likelihood. The flight control system ensures well-damped inner loops, and the control inceptors are tailored to provide well behaved responses. Even so, p.i.o.'s can never be forgotten, and can occur from unexpected sources.

A 'trigger' mechanism, such as an RCS failure, is usually involved, and difficulties sometimes arise in reproducing the occurrence of a p.i.o. An aircraft, flown without trouble by many pilots for hundreds of hours can suddenly exhibit a p.i.o., after which it is easy to find. One such example occurred during spin-recover testing. Following the recovery, a pitch p.i.o. occurred, increasing in magnitude, then subsiding. The explanation (found by ground-based simulation) was that there was a lag term built into the pitch feel dynamic pressure scheduling, and that the rapidly changing flight condition allowed high gain in the pitch RCS for a significant period during the recovery.

2. Unaided visual landing approach and flare. The elements of modelling, visual cues, motion cues and time delays all influence the quality of simulating this task. In the case of well-behaved transport aircraft doing stately approaches, the only area of concern is that of touchdown performance - in particular, comparisons of sink rate at touchdown comparing flight measurements with simulation invariably show factors of two in performance - with much heavier landings occurring in the simulator (Figure 10). There is also a considerable difference between pilots - its is almost possible to classify the pilots into two group "good simulator pilots", and "bad simulator pilots". It is suggested in reference 20 that the problem is not a physiological one, of differences between pilots in perception or response time, but a psychological one, in which the good pilots believe what they see and feel (inadequate as it is), the others do not, and thereby incur a lag due to incredulity. The only solution is to improve the quality of the information, and to remove known deficiencies. Several researchers have noted the need for good representation of aerodynamic ground effects. VSTOL and helicopter simulation also suffers near the ground. A useful concept in defining fidelity is to consider a speed/height base, within which fidelity of ground based simulation is suspect. The size of the box depends on the simulator, but few simulators could be truthfully said to have fidelity within a 50 knot/50 feet box. The task of the simulator engineer is to shrink that box.

Aircraft	Flight/ Simulator	Visual Display	Type of Landing	No. of Pilots	Mean Sink Rate m/s	Standard Deviation
Comet	Flight Simulator	TV model	flare	4	0.26	0.21
VC 10	"	"	flare	7	1.28	0.84
Jet Transport	"	"	flare	5	2.07	1.10
"	Flight Simulator	early TV	flare	20	2.0	-
"	"	"	flare	3	0.46	-
'good' aircraft	Simulator	CGI	flare	20	4.81	-
"	"	TV model	flare	8	1.35	-
"	Flight	"	flare	8	1.7	-
					0.3 - 0.6	
Sea Vixen	Flight		no flare	2	2.16	0.49
"	"		guided flare	2	0.79	0.26
"	"		flare	2	0.55	0.275
SAAB 105	Simulator	CGI	no flare	5	2.22	0.42
"	"	CGI	director	5	1.09	0.39
"	"	CGI	indicator	5	1.03	0.40
"	"	CGI	flare	5	1.29	0.33
"	"	CGI	with legs	5	1.64	0.95

Figure 10 . Mean sink rate at touchdown

6. Experimental Results - Quasi-Linear

6.1 Longitudinal Short-Period Criteria

Work in the fifties and sixties related both to fighter aircraft and to transport aircraft designs, and many experiments, in-flight and ground based, were conducted to establish criteria relating to the short period oscillation. Two typical results are seen on figures 4a and 4b. Considerable differences in such boundaries from different experiments were apparent. Better correlation was achieved by introducing an additional parameter which defines the lag between the generation of pitch rate and lift. Any of the three parameters, L_a , n_{z_a} and T_{a_0} , all closely related, achieve this purpose. Reference 21 describes fixed base simulator trials showing the importance of this factor.

Further work by Boeing is reported in reference 22. Trials on both a fixed base simulator, and on a variable stability aircraft (their Boeing 367-80), established the boundaries seen on figures 11 and 12. At low speed ($n_{z_a} < 15$), L_a is the preferred lift parameter, and at higher speeds, n_{z_a} is used. The assessments were based on large aircraft requirements for climb, cruise, and landing approach. The agreement between simulations (and known aircraft) is good. The figures do not show that bounds are needed on the values of ω_n , L_a and n_{z_a} for these criteria to be applicable; for example, very low values of L_a and ω_n can produce poor handling, even if the ratio seems acceptable. The existence of a lower limit can be inferred from figure 4(c).

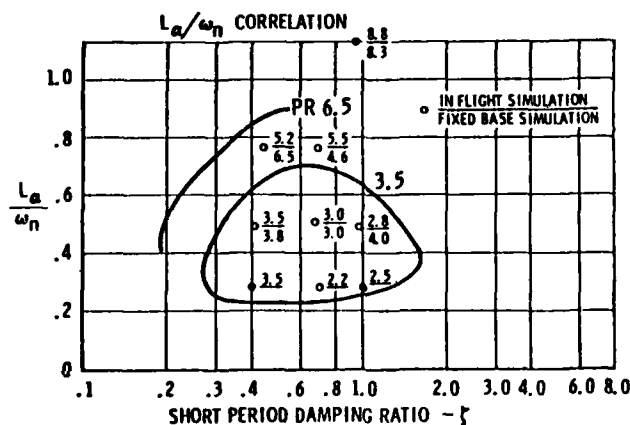

Figure 11

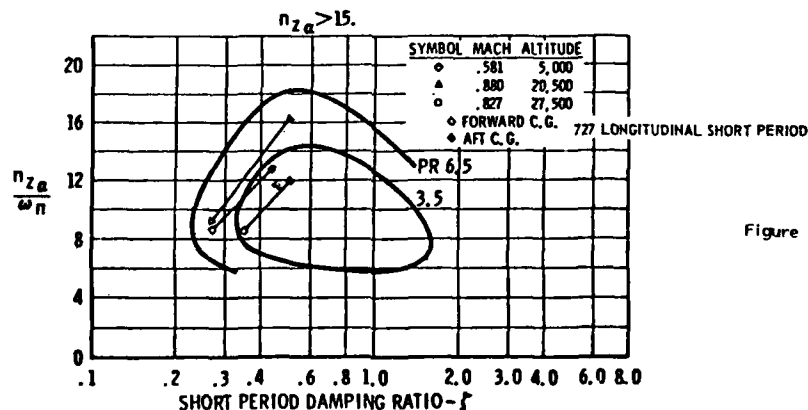

Figure 12

More work on short period requirements using the Calspan T-33, is described in reference 23. The tasks used for assessment were more akin to fighter manoeuvres, and the possibility of pilot induced oscillations was addressed. One conclusion states "feel system and control system dynamics can have significant attenuating effects on the abrupt pitch response at high frequencies, and therefore such characteristics are of considerable importance in the analysis of handling qualities results". Attention was also drawn to the importance of the parameter k_{max}/F_{ES} , the maximum pitching acceleration per elevator stick force. This parameter relates to Bihre's criterion (reference 24) and influenced the short period requirement for Category C (low speed, landing), seen on figure 14.

6.2 Low Speed Longitudinal Requirements for Advanced Transport Aircraft

An NLR study using both a ground based simulator, and the TIFS variable stability aircraft at Calspan is reported in reference 25. The ground based simulator incorporated a four degree of freedom motion system, and a TV/model board visual system, to allow the simulation of a visual approach and landing, as well as an instrument approach. Great care was taken to duplicate the tasks in the ground based simulator and in the TIFS.

The basic stability of a simulated transport aircraft was modified by a rate command/attitude hold flight control system, and by direct-lift control inputs. Based primarily on pilot ratings and commentary, boundaries between "satisfactory" and "acceptable" handling qualities (3.5) were established, and compared to existing criteria. Many valuable results emerged from this work. Although some differences between ground based and in-flight simulation were observed (sink rates at touchdown, for example Figure 13), in general the correlation of results was good, including the ratings relating to variations in short period frequency, and in pitch rate or overshoot. Figure 14 shows the mean ratings from the ground based simulation, compared to MIL-F-8785-C. Modifications to this requirement were recommended.

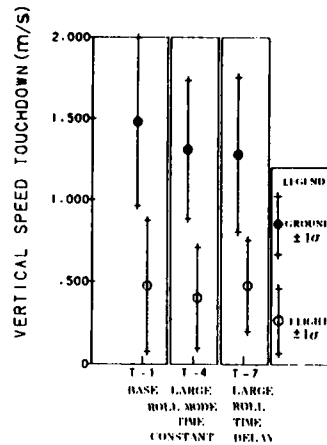

Comparison of vertical speed at touchdown

Figure 13

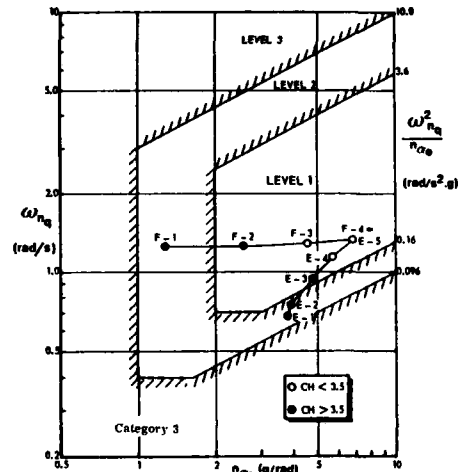

Flight simulation results versus US MIL Spec. short-period response criterion.

Figure 14

6.3 Space Shuttle Longitudinal Landing Flying Qualities

A good account of the use of flight simulation to improve the flying qualities of the shuttle is given in reference 26. Early approach and landing tests had indicated a tendency to p.i.o.s near touchdown. Analysis of the records showed that due to the hardware and mechanisation of the pitch flight control system, there was an effective time delay between the pilot input and the airplane response. Sampling in the digital FCS contributed to the delay, and matters were made worse if the pilot used large inputs, because the elevator actuators would exhibit rate limiting. The problem was tackled from several directions. An F-8 Digital FBW aircraft was used to study the inter-action of time delay and high bandwidth requirements. A fixed base simulator, with a CRT display to tailor the task, was used to study adaptive filters in the FCS, and to support mathematical modelling of the p.i.o. Extensive ground moving-base and in-flight simulations were conducted, on the FSAA and WS simulators at NASA Ames, and the TIFS at Calspan. It was found that the in-flight simulator was more likely to predict the occurrence of a p.i.o. The WS has larger vertical travel than the FSAA, and was preferred to the FSAA, but was not as p.i.o. prone as the TIFS. Although the p.i.o. tendencies were not the same, the WS and the TIFS produced similar evaluations of the basic handling qualities for less demanding tasks.

The lessons learned from the shuttle experience have been shown to apply to the approach task for fighter aircraft (reference 27).

6.4 Roll Response Requirements for Advanced Aircraft

Reference 28 describes work at NLR, equivalent to that summarised in section 6.5, relating to the roll response requirements for a transport aircraft with a rate command/attitude hold system, in the landing approach and touchdown task. Pilot ratings were obtained from assessments in the NLR moving base flight simulator of different combinations of roll damping and maximum rolling acceleration. The results are compared with various requirements and criteria from other sources. A comparison is made (figure 15) with the boundary seen on figure 4f. The perfect correlation may owe something to good fortune, but could equally be attributed to good experimental practice. Since one trial was fixed base, and the other with cockpit motion, the motion cues do not seem to have influenced the pilot ratings. Later

results from the TIFS allowed the low roll damping case R-4, to be compared to an in-flight evaluation. The more favourable rating (average OR = 5.7) from flight might be attributed to minor shortcomings of the visual system in the ground based simulator. The difference, less than one point on the OR scale, is not large, but the inference, of being within the 'acceptable' boundary, is significant.

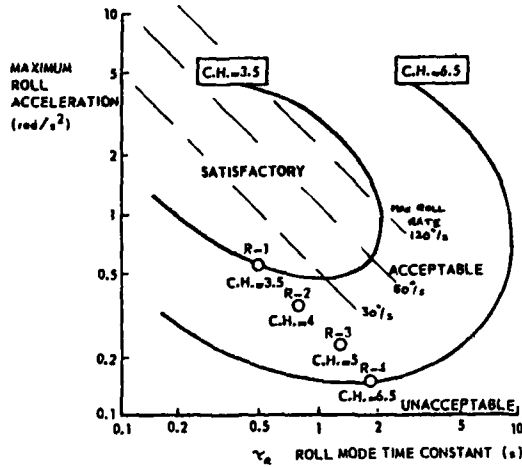

Figure 15 Handling Qualities in Roll

Rolling requirements have been complicated by the introduction of high gain manoeuvre demand systems. The roll rate feedback gain, to minimise response to external disturbance, has to be balanced by high gain in the forward path. Forward path filtering is then needed to reduce the roll sensitivity. For fighter aircraft, high maximum roll rates are wanted throughout the flight envelope, and non-linear relationships between stick force and roll demand are necessary. The use of a force side-stick adds to the design problem. The classic example is the F-16, and the roll p.i.o. which caused an inadvertent first flight. The problem is described in reference 29, which makes the point that in-flight simulation played an important role in producing the solution. A related handling deficiency in roll, "roll ratchetting", yielded to analysis and fixed base simulation, which resulted in good correlation with in-flight simulation (Figure 16). It is instructive to compare the roll rates for full stick implied by Figure 16 and the corresponding τ_r , with the Figure 15 boundaries (assume 10 lbs for full stick). The p.i.o. area lies in the top left corner of Figure 15. Conventional aircraft have problems in the bottom right corner!

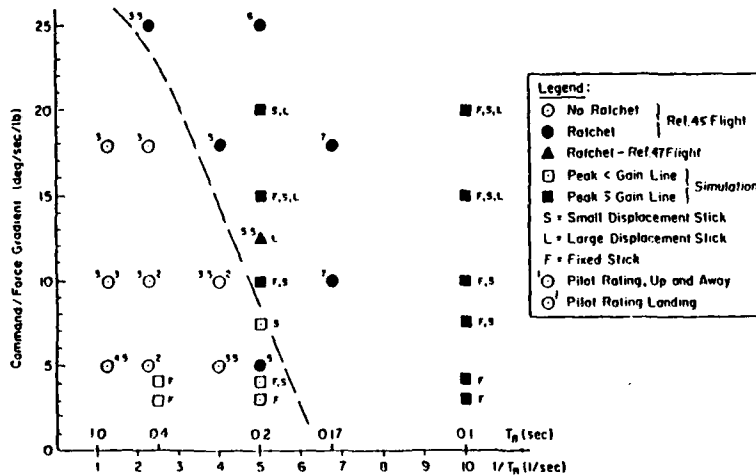

Figure 16 Roll Ratchet Comparison, Flight and Simulator

6.5 Lateral Stability and Control

Many simulations, fixed-base, moving-base and in-flight have been made to establish criteria for the rolling, spiral, and dutch roll modes, and for excitation of these modes by control movements. Frequency domain parameters provided the most convenient form to express the criteria, and were used to frame the subsequent Flying Qualities Requirements. Reference 11 deals with these results in detail.

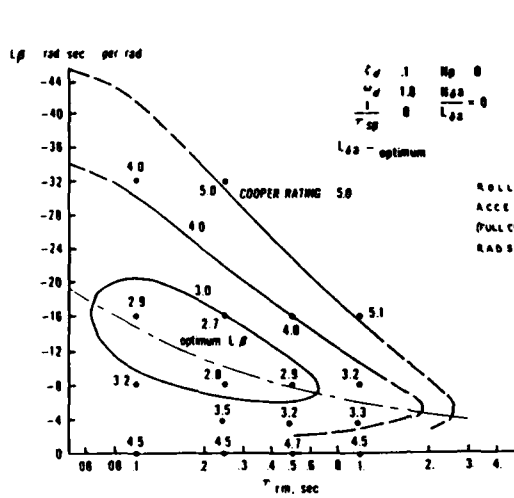
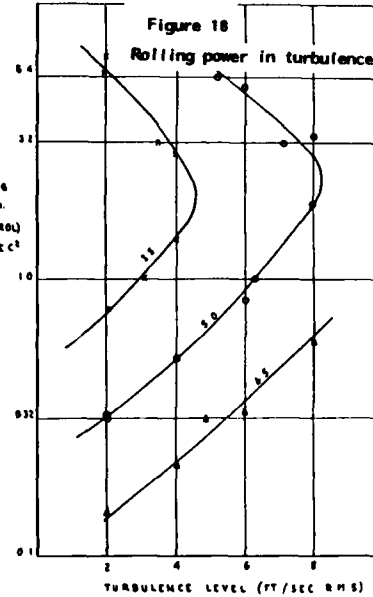

Figure 17 Lateral/Directional H.Q.



Further insights into lateral flying qualities is gained by considering dimensional derivatives, such as N_{δ} , L_{δ} , $L_{\dot{\delta}}$, $N_{\dot{\delta}}$. These derivatives indicate the magnitude of excitation - for example, L_{δ} gives a direct measure of the initial response in roll to a side gust. Figure 17, from reference 30, shows the results of an in-flight simulation study, using the variable stability Navion at Princeton University. The pilot rating boundaries are plotted in terms of L_{β} and τ_r , the rolling mode time constant. A similar study using a ground based simulator (reference 31) produced very similar ratings for the level of turbulence represented in flight. As might be expected, the pilot rating varies with turbulence level (figure 18). Systematic study of the effect of turbulence on flying qualities (as opposed to ride comfort) is a neglected area. Depending on the control loop and the excitation, the pilot may reduce or magnify the effects of turbulence. In the latter case, his best control strategy is to minimize his inputs consistent with retaining control of the inertial flight path. The question still remains whether open loop criteria, for example, bounds on the bank and yaw excitations due to gusts (figure 19), or closed loop

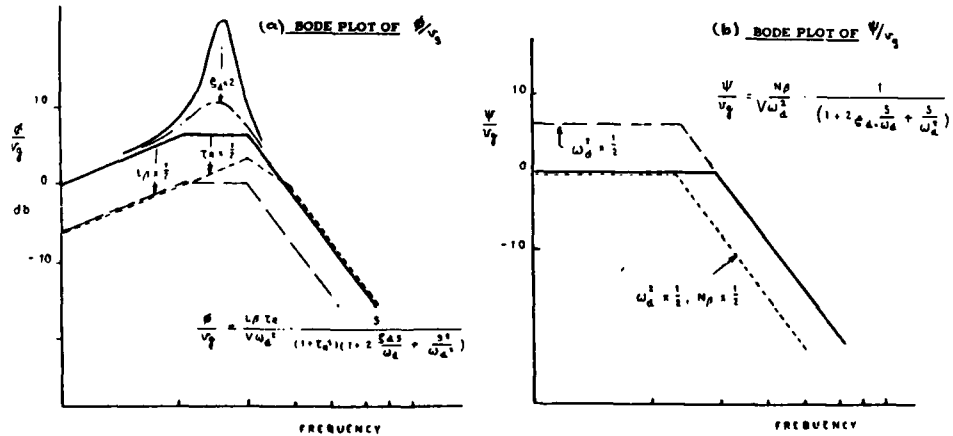

Figure 19

criteria should be the basis for specifications. There is a shortfall in the specification of requirements which cater for flying qualities in all atmospheric conditions. Modern flight control technology can address automatic gust alleviation, but even then, there is a need to ensure that the system that modulates the response to external disturbances does not detract from the manoeuvring capability of the aircraft.

Before leaving the topic of lateral handling in turbulence, it is worth noting that ground based simulators with motion systems (even of modest performance) have produced handling qualities assessments that correlate well with results from flight trials. At the same time, fixed and moving base simulators produce different results, and the character of the pilots control inputs changes, as seen in the example on Figure 20 from reference 31.

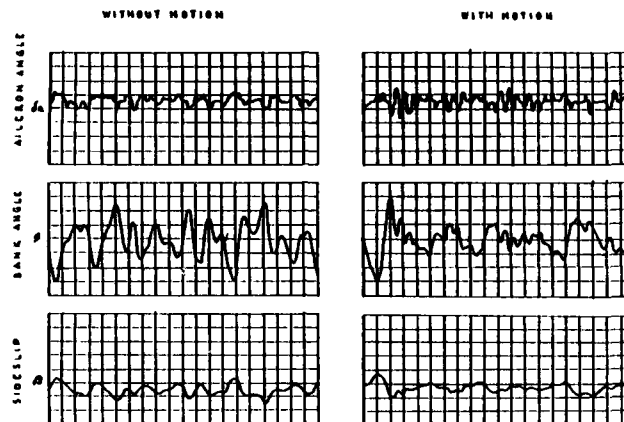

Figure 20. Comparison of fixed and moving base simulation in turbulence

7. Experimental results - large excursions

The examples of Section 6 help to satisfy the need for experimental results to support improvements to Handling Qualities Specifications. Compared to the sixties, there has been a sharp reduction in such experiments, and the lack of data has to some extent hindered the development of Specifications to deal with the types of aircraft now being designed. A further hindrance has been the application to aircraft design of new technology, including relaxed stability, fly-by-wire, and multiple redundancy. Their influence on flying qualities specifications was discussed by A'Herrah and Woodcock in 1981 (reference 32). They observed that there had been an "erosion in confidence, and a lack of commitment to understand the specification, and to actively utilise the specification guidance during the evolution of the design." One of the reasons for this situation was given as follows: "The Specification used to be the primary tool for evaluating Flying Qualities before first flight. Flight Simulators, of increasing sophistication as the design progresses, are now utilised as an integral part of the design process. The computational capabilities available to support simulation hardware can model the complex aircraft and flight control systems for pilot evaluation. Indeed, the design of advanced aircraft today is virtually unthinkable without substantial flight simulation support. Because of its sophistication and direct involvement with pilots, the simulator may be more readily believed than the specification, whether warranted or not."

The views are even more relevant today, excepting perhaps their last qualification. Modern aircraft are completely dependent on avionics - for cockpit displays, flight control, and systems. Extensive ground testing of hardware and software is essential prior to flight, part of this testing includes pilot evaluation of flying qualities. It is no longer sufficient to choose an isolated task and flight condition for assessment; the full envelope has to be explored. The engineers and pilots have to assure themselves that both the fine control of the aircraft, and its behaviour in extreme conditions will not cause problems in flight. Examples of flight simulation evaluations of the latter type will now be given.

7.1 The most recent examples are the clearance to flight of the British EAP and the French Rafale prototype aircraft. Both aircraft use relaxed stability to enhance manoeuvring capability, and could not be flown without their fly by wire control systems with multiple-redundancy. Within weeks of first flight both aircraft were being demonstrated at low-level in impressive aerobatic routines. The confidence for such demonstrations was based on ground-based rig and simulator testing.

The standard of simulation needed to clear the RCS for the EAP is described in reference 33. It is far removed from that used twenty years ago, to study flying quality requirements. Figure 21 shows the various elements included in the simulation. From the flying qualities standpoint, the aerodynamic model, and the flight control system model are of interest. It is difficult to relate the aerodynamic model to the linearised force and moment coefficient models which were once sufficient. Data is transferred to the simulator host computer in the form of hypercubes - arrays of numbers which include all non-linearities and

Figure 21 EAP Simulation Block Diagram

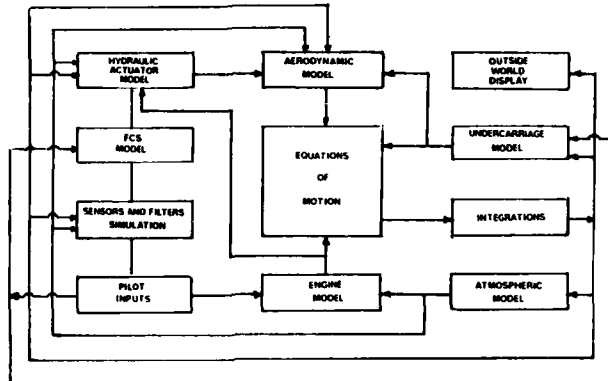

cross-coefficients, which are interrogated at high speed to provide the correct forces and moments on the airframe at all times. Typically, the computer handles 0.5 million coefficients. The critical coefficients are updated 300 times per second. The flight control system model is also complex. Features include multiple feedbacks, non-linear gain and filter shaping, forward path scheduling, limiting and monitoring. The FCS iron out aerodynamic non-linearities and cross-coupling, and takes account of the incidence/sideslip/g/speed/height envelope to allow carefree handling.

There are several consequences to this level of simulator activity. First, the capability of the simulator is stretched, particularly in the area of modelling, and qualification of the model. Good standards of documentation are essential. Secondly, classical flight mechanics methods of investigating flying quality deficiencies do not apply; neither the aerodynamic model, nor the flight control system model can be inspected with ease. Third, the flight simulator becomes a general design tool. In defining the FCS, the engineers have used analytical methods and computer models, together with a knowledge of flying qualities criteria. Even so, real-time simulation is the point where all the components come together for the first time, including representative forcing functions (pilot and external disturbances, including ground constraint). Iteration, based on inspection of responses, is the key to success, and the FCS engineer who says "yes, we know about that, and it is taken care of in the next issue of the FCS software" is usually being economical with the truth. Although the technique is different, the challenge to provide good flying qualities still remains. Repeated evaluations are needed - often it is after many hours of assessment that a loose end is spotted - an unwanted coupling, a pitch attitude drop-back, a restrictive limit, or a combination of controls that induces trouble. Once found, these things are so obvious.

7.2 Lateral Departures

Carefree manoeuvring is still a luxury, and the manoeuvring envelope of many fighter aircraft is determined by lateral stability and control at high incidence. The need to use high incidence, particularly at low speed, is dictated by requirements relating to air combat. The understanding of aerodynamic phenomena in this region has greatly improved, so that the opportunities for simulation have been enhanced. This region of flight is more appropriately studied on ground based simulators rather than airborne simulators - in fact, the study of these effects on the actual aircraft is not without difficulties. Because of their non-linear nature, repeatability of a manoeuvre is not assured, and it is often very demanding on piloting skill to achieve a test-point in the air. Flight data is needed to confirm the aerodynamic model; then the simulator can be used for exploration - the effects of trim, aircraft configuration, and flight condition. The result is a plot of departure boundaries, together with the nature of the departure and how to recover. In practical terms, the Clearance Authority can then incorporate manoeuvre restrictions into the Pilots' notes, as necessary. Alternatively, the control system could be developed to allow high incidences to be achieved without departure - the Spin Prevention and Incidence Limiting System (SPILS) on Tornado is such a development.

All of the work of this nature at Warton (relating to Jaguar and Tornado) was conducted on fixed base simulators; a proportion of the assessments used a wide field of view visual system inside a dome.

The use of ground-based simulation to support F-14A low altitude high angle of attack flight testing is described in reference 34. Over 2000 total manoeuvres were flown on the simulator, involving all aspects of the flight test programme, from initial test planning to post flight manoeuvre analysis. From the simulator results, the critical departure parameters were

identified, and departure trends were defined. As a result, the manoeuvres in the aircraft test plan were dedicated to accomplishing the critical program demonstration endpoints. The simulation programme contributed greatly to flight safety. Pilots were well rehearsed for each demonstration. Details of the software and hardware standards used by Grumman are given in the reference. Simulator fidelity is discussed, confirming the view that it is a relative quantity. The acceptability of the simulator fidelity was based on experience, familiarity with the aircraft, and best engineering judgement. The simulation was deemed acceptable as long as it provided a "close but conservative" representation of the aircraft's departure and recovery characteristics. Using simulation support in this way, the F-14's departure characteristics were safely demonstrated at angles of attack greater than 60 degrees with full engine thrust asymmetry at altitudes below 10,000 feet.

7.3 Spinning

If recovery from lateral departure is not effected, spinning will follow. Like many high performance aircraft, the F-14 exhibits several spin modes. The aircraft may transition into an aerodynamically stable flat spin mode (90 degrees AOA with increasing yaw rate to 180 degrees per second). The pilot can be subject to "eyeballs out" g forces as high as 6 1/2 g, resulting in almost total incapacitation if his shoulder harness is not securely locked. Reference 35 describes simulator trials to study the aircrew safety problems, using the Dynamic Flight Simulator (DFS) at NADC, Warrminster. The key element is a human centrifuge motion platform with three degrees of freedom - a 10 foot diameter gondol suspended in a dust gimbal system, on the end of a 50 foot arm. The system can provide 10g per second onset rate, between 1.5 and 15g. The elements of the simulator are seen on Figure 22. Many aspects were studied, including the effect on spin recovery of recovery initiation, height lost during recovery, the effect of altitude on entry, the need for recovery displays, and the design of the restraint system. Valuable data were obtained from the tests although (not surprisingly) flight validation was sparse. Fidelity aspects of the centrifuge, and the control algorithms which were used, are dealt with in papers given at the same AIAA conference.

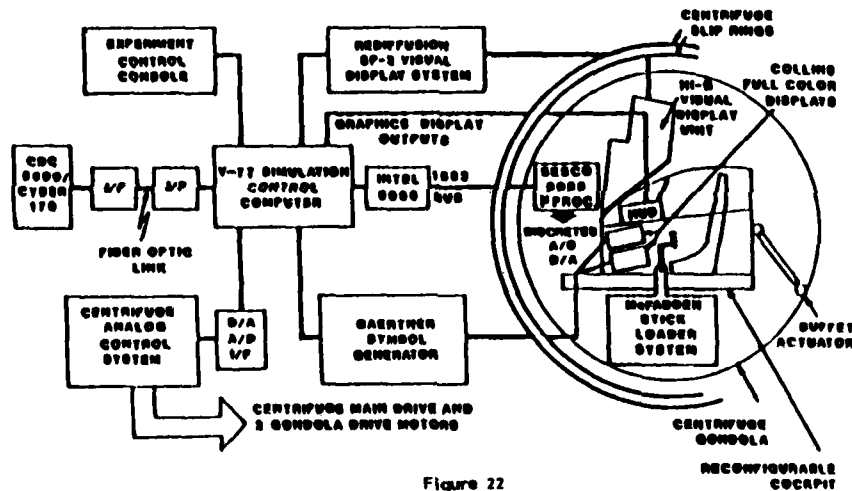

Figure 22

DYNAMIC FLIGHT SIMULATOR (DFS) BLOCK DIAGRAM

7.4 Ski-Jump

Also presented at this conference was a paper from McDonnell Aircraft Company (reference 36) describing ground based simulator trials to determine the likely success of enhancing the F-18 take-off performance by landing gear modifications to allow take off from a ski-jump ramp. Real-time, man in the loop simulation was considered necessary to study the handling and flight control aspects. The simulator programme was followed by flight testing; a comparison between flight and simulator is seen on figure 23. It is concluded that the program benefited significantly from the extensive simulator effort. The simulator provided model validation, as well as pilot familiarisation and training. It established safe operating envelopes, and a Naval Air Test Center report said that "simulation is the perfect tool to evaluate different ski jump profiles".

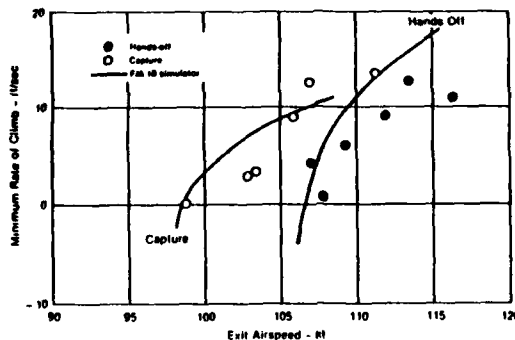

Figure 23
 Minimum Rate of Climb on 6° Ramp

7.5 General

The above examples are a small cross-section of specific trials. Of a more general nature is the value of simulation in the study of atmospheric phenomena, and their effect on flying qualities. In the sixties, simulators contributed to the understanding of the deep-stall problem and the jet-upset problem. Recommendations emerged, not only to show flight control system modifications to minimise the problem, but also to advise the pilots on flying techniques to improve safety. More recently incorporating complex atmospheric models of the micro-burst have helped engineers to understand the mechanisms involved, and have helped pilots to deal with the operational aspects.

8. Future Prospects

Without question, flight simulation will play a vital role in the design and clearance of all types of future aircraft - civil and military; conventional, VSTOL and helicopters. Hardware improvements are allowing increased fidelity in simulation. Additionally, the complexity of aircraft design increasingly calls for simulation as an essential step in the clearance process.

8.1 Simulator Improvements

The complementary nature of airborne and ground based simulator testing is unlikely to change. Standards of in-flight simulation will improve for several reasons. Hardware improvements now available include sensors, actuators, data transmission, and airborne computing. Programmable electronic displays can more easily replicate those intended for a new aircraft, so that the range of tasks which can be simulated will expand. Telemetry ground links, and monitoring devices offer more benefits.

Ground-based simulation is also improving. Most companies and agencies are updating simulator laboratories with improved hardware. A better understanding exists in the simulator community of the source of current limitations - in visual cues, motion cues, and time delays - and means of removing these limitations are appearing. The inter-actions between these three factors are recognised, and fundamentals are being addressed. Recent improvements in visual display hardware offer higher resolution and wider field of view displays. Equally impressive is the recent progress in image generation. Processing power, allied to compensation techniques, is taking the sting out of time delays.

8.2 Aircraft Design

We saw in section 7 that aircraft designers are inclined to test their ideas on simulators, and reduce the role of the Flying Qualities Specification into that of a check list. That is only half of the story. Clearly, the Procuring Authority needs a document such as MIL-F-8587C to lay down a requirement for a new aircraft. But aircraft procurement today is not a simple buyer/supplier situation - on both sides, teams are likely to be involved. In the case of a team of suppliers, involving large companies, with different philosophies, there is a need for a unifying force, an operating framework. In the case of flying qualities, the MIL Spec provides that framework. We may not obey the ten commandments, but we are all benefactors from their existence.

The aircraft design problem has changed, particularly in the area of flying qualities and flight control. Responsibility for good flying qualities resides more in the domain of avionics than it did in the past. The flight control system can be made to do a better job than the pilot in many areas - in manoeuvre limiting, and monitoring. The idea of levels of flying qualities, to deal with control degradation, has much less meaning for modern aircraft than it had ten years ago. But the pilot is still the key element, and the design must incorporate his preferences. Section 7 shows the wide scope of investigations now required. The task is a critical element, and a specification based on only 3 categories A, B and C is inadequate for design purposes.

8.3 Flying Qualities Specification

A general specification which embraces all possibilities, and sets mandatory requirements, is difficult to formulate. Applying it to a design using new principles of control is also difficult, and proving compliance is not easy. The question arises whether a general specification is worthwhile, when major projects are few, and when there may be time to prepare a specification tailored to each project.

As we have seen, the specification serves other purposes, and should be revised rather than rejected. Two possibilities could be explored. One possibility is to lean towards the format adopted in the British revision of AMP 970 Chapter 6, Flying Qualities Requirements (reference 37). The mandatory requirements are phrased in non-numerical terms, using phrases like "shall not give rise to piloting difficulties". Each requirement refers to an acceptable means of compliance (A.M.C). In this way novel, non-compliant solutions can be offered. The revision will be complete when an equivalent section, acceptable means of demonstration is complete. Such demonstration will include analysis and simulation.

The other possibility is to have a framework specification, to which can be added the numerical requirements and background information which is appropriate to a defined new project. The opportunity would then arise to define also the extent to which flight simulation is relevant to the design and development process.

The requirements themselves need to be examined. Although the 'equivalent system' approach deals with some of the features of modern digital flight control systems, definition of what is an equivalent system is imprecise. An alternative or complementary format for specification is to use parameters which emerge from the examination of time responses. Such criteria are in wide use, implying a swing from the frequency domain into the time domain. Also, the nature of simulator trials described earlier suggests a classification of criteria for either fine control or coarse control - the same control system must satisfy both types of control input. The important issue for the future, however, is to ensure that the interchange between analysis, modelling, simulation, testing and project definition is a coordinated activity, from which emerges an aircraft with good flying qualities.

REFERENCES

1. Perkins C.D. and Hage R.E. "Airframe Performance, Stability and Control".
 John Wiley and Sons, N.Y. 1949
2. James H.M. and Nichols N.B., and Phillips R.S. "Theory of Servomechanisms,"
 McGraw-Hill, N.Y. 1947
3. Tustin A. "The Nature of the Operator's Response in Manual Control and its Implications for Controller Design"
 Journal of the Institute of Electrical Engineers, No.2 1947
4. McGruer D.T. and Kendal E.S. "The Man-Machine System Concept"
 Proceedings of the IRE, Vol 50 No5 May 1962
5. McGruer D.T., Ashkenas I.L. and Graham D. "Aircraft Dynamics and Control"
 Princeton University Press, Princeton, N.J. 1973
6. Proceedings of Flight Mechanics Panel Specialists' Meeting on Stability and Control.
 AGARD CP 17 September 1966
7. Cooper G.E. "Understanding and Interpreting Pilot Opinion"
 IAS Paper, Aeronautical Engineering Review March 1961
8. Cooper G.E. and Harper R.P. "The Use of Pilot Rating Scales in the Evaluation of Aircraft Handling Qualities"
 NASA TN D-5153 April 1969
9. Harper R.P. and Cooper G.E. "Handling Qualities and Pilot Evaluation"
 Wright Brother Lecture in Aeronautics, given to AAIA Meeting 1965
10. Anon. U.S. Military Specification. "Flying Qualities of Piloted Airplanes".
 MIL-F-8785B(ASG) August 1969
11. Chalk C.R., Neal T.P., Harris T.H., Pritchard F.E. and Woodcock R.J. "Background Information and User Guide for MIL-F-8785B(ASG)"
 AFFDL-TR-69-72 August 1969

12. Rolfe J.M. and Staples K.J., ed. "Flight Simulation"
Cambridge University Press, Cambridge, U.K. 1986
13. Barnes A.G. and Yager T.J. "Simulation of Aircraft Behaviour On and Close to the Ground"
ACARDograph 285 January 1985
14. Lockenour J.L. "Simulation as a Fighter Design Tool"
ACARD LS 153 June 1986
15. Ashkenas I.L. "Collected Flight and Simulation Comparisons and Considerations"
ACARD CP 408 October 1985
16. Jewell Wayne F. "Summary of Daily Activities of the SH-60B Study on the Vertical Motion Simulator"
Systems Technology Inc.
WP-1198-6 July 1984
17. Jex Henry R., Jewell Wayne F. and Magdaleno Raymond E. "Effects of Various Lateral Beam Motion Washouts on Pilot Tracking and Opinion in the LAMAR Simulator"
Proc. 15th Annual Conference on Manual Control
AFFDL-TR-79-3134 pp 244-366 1979
18. Hoh Roger H. "Investigation of Outside Visual Cues Required for Low Speed and Hover"
Systems Technology Inc.
TR-1213-1 1984
19. Barnes A.G. "Operating Experience of a Small Six Axis Motion System Inside a Dome with a Wide Angle Visual System"
AIAA Atmospheric Flight Mechanics Conference, Monterey, Ca. August 1987
20. Barnes A.G. and Koivisto C.J. "The Landing Approach and Flare Manoeuvre - Simulation"
LUTAB-R-3046.2 Stockholm, Sweden April 1981
21. Chalk C.R. "Fixed Base Simulator Investigation of the Effects of L and True Speed on Pilot Opinion of Longitudinal Flying Qualities"
ASD-TDR-63-339 November 1963
22. Shomber H.A. and Gertsen W.M. "Longitudinal Handling Qualities Criteria: An Evaluation"
AIAA Conference on Aircraft Design and Technology, Los Angeles
AIAA paper 65-780 November 1965
23. DiFranco D.A. "Flight Investigation of Longitudinal Short Period Frequency Requirements and p.i.o. Tendencies"
AFFDL-TR-66-163 June 1967
24. Bihrie William Jr. "A Handling Qualities Theory for Precise Flight Path Control"
AFFDL-TR-65-198 June 1966
25. Moolij H.A. and Van Cool M.F.C. "Handling Qualities of Transports with Advanced Flight Control Systems"
ACARD CP 333 April 1982
26. Powers Bruce G. "Space Shuttle Longitudinal Landing Flying Qualities"
Journal of Guidance, Vol 9, No.5 Sept-Oct 1986
27. Smith Rogers E. "Effect of Control System Dynamics on Fighter Approach and Landing Longitudinal Flying Qualities"
AFFDL-TR-78-122 March 1978
28. Van Cool M.F.C. and Moolij H.A. "A Simulator Investigation of Roll Response Requirements for Aircraft with Rate Command/Attitude Hold Flight Control Systems in the Landing Approach and Touchdown"
AIAA paper 79-1679 1979
29. Reynolds P.A. "Simulation for Predicting Flying Qualities"
ACARD CP 333 April 1982

30. Seckel E. et al. "Lateral Flying Qualities for Power Approach"
Princeton University Report No. 727 May 1966
31. Barnes A.G. and Parsons N.A. "A Flight Simulator Investigation of the Effects of Turbulence on Rolling Requirements at Low Speed"
British ARC R and M 3697 May 1970
32. Al-Harrah R.C.A. and Woodcock R.J. "The Military Flying Qualities Specification. A Help or a Hindrance to Good Fighter Design?"
ACARD CP 319 October 1981
33. Perrin James E. "Flight Simulation of the British Aerospace EAP"
UKSC Conference, Bangor, UK. 9-11 September September 1987
34. Conigliaro P. and Goodman R. "Utilisation of Simulation to Support F-14A Low Altitude High Angle of Attack Flight Testing"
ACARD CP 408 October 1985
35. Eyth Jacob Jr. and Gleisner Lt. D.P. "Application of the Dynamic Flight Simulator to Evaluate Pilot Performance in a Simulated F-14 Flat Spin Environment"
AIAA Flight Simulation Technologies Conference July 1985
- 36
.Dougherty B.L. and Rolston D.R. "Simulator Evaluation of the F/A-18 Ski-Jump"
AIAA Flight Simulation Technologies Conference July 1985
37. Bennett G. "Revised Requirements for the Flying Qualities of Service Aeroplanes"
Royal Aircraft Establishment Tech Memo Structures 863 April 1975



SELECTIVE BIBLIOGRAPHY

This bibliography with abstracts has been prepared to support AGARD Lecture Series No. 157 by the Scientific and Technical Information Division of the U.S. National Aeronautics and Space Administration, Washington, D.C., in consultation with the Lecture Series Director, Irving L. Ashkenas, Systems Technology, Inc., Hawthorne, California.

UTTL: An analysis of a candidate control algorithm for a ride quality augmentation system
AUTH: A/SUKAT, REINER; B/DONALDSON, KENT; C/DOWLING, DAVID R.
PAA: C/(Kansas, University, Lawrence) CORP: Kansas Univ., Lawrence, AIAA, AHS, and ASEE, Aircraft Design, Systems and Operations Meeting, Saint Louis, MO, Sept. 14-16, 1987. 9 p.

ABS: This paper presents a detailed analysis of a candidate algorithm for a ride quality augmentation system. The algorithm consists of a full-state feedback control law based on optimal control output weighting, estimators for angle of attack and sideslip, and a maneuvering algorithm. The control law is shown to perform well by both frequency and time domain analysis. The rms vertical acceleration is reduced by about 40 percent over the whole mission flight envelope. The estimators for the angle of attack and sideslip avoid the often inaccurate or costly direct measurement of those angles. The maneuvering algorithm will allow the augmented airplane to respond to pilot inputs. The design characteristics and performance are documented by the closed-loop eigenvalues; rms levels of vertical, lateral, and longitudinal acceleration; and representative time histories and frequency response.
RPT#: AIAA PAPER 87-2936 87/09/00 88A14277

UTTL: Flight control synthesis to meet flying qualities specifications - An evaluation of multivariable synthesis techniques
AUTH: A/WENDEL, THOMAS R.
PAA: A/(McDonnell Aircraft Co., Saint Louis, MO) AIAA, AHS, and ASEE, Aircraft Design, Systems and Operations Meeting, Saint Louis, MO, Sept. 14-16, 1987. 11 p.

ABS: Four different multivariable model-following design techniques were evaluated to assess their applicability to the flight control law design of advanced aerospace vehicles. The ability of these synthesis techniques to meet the flying qualities, robustness, and turbulence rejection requirements of future fighter aircraft within the deflection and rate constraints of the actuation system was examined. The gain scheduling required to implement the control laws developed by these synthesis techniques was also investigated and the manpower required to formulate a control system capable of meeting the chosen design objectives was evaluated. This evaluation identified strengths and weaknesses of the techniques and established effective ways of applying these algorithms to the design of 'real world' high order control systems. It was determined that these algorithms can meet flying qualities requirements of advanced fighter aircraft while satisfying stability margin and turbulence rejection requirements. However, the ability of these algorithms to effectively manage high order dynamics such as actuator dynamics, sensor dynamics and structural filters should be improved.
RPT#: AIAA PAPER 87-2880 87/09/00 88A14260

UTTL: 7U7 manual flight control functions
AUTH: A/SAMKRITHI, MITHRA M. K. V.; B/BRYANT, W. F.
PAA: B/(Boeing Commercial Airplane Co., Seattle, WA) IN: AIAA Guidance, Navigation and Control Conference, Monterey, CA, Aug. 17-19, 1987, Technical Papers, Volume 2 (A87-50401 23-08). New York, American Institute of Aeronautics and Astronautics, 1987. p. 905-913.

ABS: The advanced manual control functions to be implemented in the primary flight control system of the 7U7, projected for the 1990's, are discussed. The pilot will command flight path angle, track/roll angle, and sideslip angle rather than control surface positions, resulting in reduced pilot workload in adverse weather conditions and consistently good flying qualities regardless of aircraft weight, center of gravity, configuration, or location in the flight envelope. Envelope protection functions will enhance aircraft safety and further reduce pilot workload. The 7U7 manual control functions have been validated in simulation tests.
RPT#: AIAA PAPER 87-2454 87/09/00 87A80500

UTTL: Application of multivariable control to the STOL and Maneuver Technology Demonstrator
AUTH: A/MCDONNELL, RICHARD F.; B/LOWERY, DAVID J.
PAA: A/(McDonnell Aircraft Co., Saint Louis, MO); B/(Honeywell Systems and Research Center, Minneapolis, MN) IN: AIAA Guidance, Navigation and Control Conference, Monterey, CA, Aug. 17-19, 1987, Technical Papers, Volume 1 (A87-50401 23-08). New York, American Institute of Aeronautics and Astronautics, 1987. p. 773-783.

ABS: The STOL and Maneuver Technology Demonstrator (S/MTD) program is developing and validating technologies to provide future fighter aircraft with Short Takeoff and Landing (STOL) capability and increased maneuverability. Key technologies include two-dimensional (2D) thrust vectoring/reversing exhaust nozzles and an integrated Flight/Propulsion Control (IFPC) system. The novel control capabilities provided by thrust vectoring and reversing, integration of the nozzles with the traditional aerodynamic control surfaces, and rigorous program requirements resulted in a challenging IFPC control law design problem. Both classical and multivariable control systems design and analysis techniques were applied where appropriate. Multivariable control applications included Linear Quadratic Gaussian with Loop Transfer Recovery (LQG/LTR) synthesis and Structured Singular Value (SSV) analysis. This paper emphasizes development of coupled longitudinal and airspeed control laws for the Short Landing task. By blending multivariable and classical design features, and making practical tradeoffs in performance versus complexity, control laws were designed which provided excellent flying qualities during manned flight simulator evaluations.
RPT#: AIAA PAPER 86-2403 87/09/00 87A50487

UTTL: Dynamic stability and handling qualities tests on a

highly augmented, statically unstable airplane

AUTH: A/GERA, JOSEPH; B/BOSWORTH, JOHN T. CORP:
 PAA: B/(NASA, Flight Research Center, Edwards, CA) National Aeronautics and Space Administration, Flight Research Center, Edwards, Calif. IN: AIAA Guidance, Navigation and Control Conference, Monterey, CA, Aug. 17-19, 1987. Technical Papers, Volume 1 (A87-50401 22-08). New York, American Institute of Aeronautics and Astronautics, 1987, p. 170-182.

ABS: Novel flight test and analysis techniques in the flight dynamics and handling qualities area are described. These techniques were utilized at NASA Ames-Dryden during the initial flight envelope clearance of the X-29A aircraft. It is shown that the open-loop frequency response of an aircraft with highly relaxed static stability can be successfully computed on the ground from telemetry data. Postflight closed-loop frequency response data were obtained from pilot-generated frequency sweeps and it is found that the current handling quality requirements for high-maneuverability aircraft are generally applicable to the X-29A.

RPT#: AIAA PAPER 87-2258 87/00/00 87A50421

UTTL: Compatibility aspects of active control technologies with aircraft structure design

AUTH: A/BECKER, J.; B/WEISS, F.; C/SENSBURG, O.
 PAA: C/(Messerschmitt-Boelkow-Blohm GmbH, Ottobrunn, West Germany) International Symposium on Structural Control, 2nd, University of Waterloo, Canada, July 15-17, 1985, Paper, 25 p.

ABS: Typical examples of interference between structural design and active control technologies are presented to illustrate static elastic and structural dynamic effects on the vibration level of a structure. One example deals with active gust alleviation and ride improvement investigations on a transport aircraft. It is shown that an improvement in passenger comfort could be reached only with some adverse effects on handling and local dynamic design and with a resulting increase in fatigue loads. Another example illustrates the adverse effects of static elastic deformations on the handling and ride qualities of an originally unstable military aircraft with a flight-control system.

RPT#: NBB-LKE-292/S/PUB/200 85/07/00 87A49965

UTTL: Comparison of in-flight and ground-based simulator derived flying qualities and pilot performance for approach and landing tasks

AUTH: A/GRANTHAM, WILLIAM D.; B/WILLIAMS, ROBERT H.
 PAA: A/(NASA, Langley Research Center, Hampton, VA); B/(PRC Kentron, Inc., Hampton, VA) CORP: National Aeronautics and Space Administration, Langley Research Center, Hampton, Va.; PRC Kentron, Inc., Hampton, Va. IN: AIAA Atmospheric Flight Mechanics Conference, Monterey, CA, Aug. 17-19, 1987. Technical Papers (A87-49577 22-08). New York, American Institute of Aeronautics and Astronautics, 1987, p. 12-22.

1987, p. 49-60.

ABS: For the case of an approach-and-landing piloting task emphasizing response to the landing flare, pilot opinion and performance parameters derived from jet transport aircraft six-degree-of-freedom ground-based and in-flight simulators were compared in order to derive data for the flight-controls/flying-qualities engineers. The data thus obtained indicate that ground simulation results tend to be conservative, and that the effect of control sensitivity is more pronounced for ground simulation. The pilot also has a greater tendency to generate pilot-induced oscillation in ground-based simulation than in flight.

RPT#: AIAA PAPER 87-2290 87/00/00 87A49583

UTTL: Alternative design guidelines for pitch tracking

AUTH: A/BLAND, MICHAEL P.; B/SHIRK, FRANK J.; C/CITURS, KEVIN D.; D/MODRHOUSE, DAVID J.
 PAA: C/(McDonnell Aircraft Co., Saint Louis, MO); D/(USAF, Wright Aeronautical Laboratories, Wright-Patterson AFB, OH) IN: AIAA Atmospheric Flight Mechanics Conference, Monterey, CA, Aug. 17-19, 1987. Technical Papers (A87-49577 22-08). New York, American Institute of Aeronautics and Astronautics, 1987, p. 40-48.

ABS: The unsatisfactory results obtained with a classical second-order longitudinal control system for the case of fine tracking during piloted simulation has prompted the use of alternative design criteria to develop a technique which increases the numerator lead time constant in the aircraft pitch rate response. When this value is augmented to a value higher than that of the basic airframe, a load factor is produced which, while improving flying qualities for air-to-air tracking, could degrade precise flightpath-control flying qualities. It is concluded that a classic second-order load factor response may not produce adequate fine tracking flying qualities for some aircraft.

RPT#: AIAA PAPER 87-2289 87/00/00 87A49582

UTTL: Simulation studies of translation rate command systems for hover and low speed flight

AUTH: A/KREKELER, G. C.; B/EHLERS, J. C.; C/WILSON, D. J.
 PAA: C/(McDonnell Aircraft Co., Saint Louis, MO) IN: AIAA Atmospheric Flight Mechanics Conference, Monterey, CA, Aug. 17-19, 1987. Technical Papers (A87-49577 22-08). New York, American Institute of Aeronautics and Astronautics, 1987, p. 12-22.

ABS: The flying qualities requirements for V/STOL shipboard landing operations in high sea states are investigated by a fixed-base piloted simulation, whose first phase replicated X-22 flight tests in order to validate predictions of in-flight translation rate command (TRC) and to evaluate the expanded range of TRC dynamics. The second phase gave attention to an expanded TRC test matrix, for the case of a shipboard landing aboard a small destroyer. The first phase confirmed that fixed-base

simulation can be used to accurately predict in-flight pilot ratings. Since currently proposed time-domain criteria only inconsistently predicted flying qualities levels for the fixed-base and X-22 flight data, TRC frequency response envelope and secondary TRC criteria were developed to improve flying qualities predictions; these conservatively predict flying qualities levels.

RPT#: AIAA PAPER 87-2286 87/00/00 87A49579

UTTL: Effect of time delay on manual flight control and flying qualities during in-flight and ground-based simulation

AUTH: A/BAILEY, RANDALL E.; B/KNOTTS, LOUIS H.; C/HOROWITZ, SCOTT J.; D/WALONE, HUGH L., III
PAA: B/(Calspan Advanced Technology Center, Buffalo, NY); D/(USAF, Human Resources Laboratory, Williams AFB, AZ)
IN: AIAA Flight Simulation Technologies Conference, Monterey, CA, Aug. 17-19, 1987, Technical Papers (A87-49156 21-01); New York, American Institute of Aeronautics and Astronautics, 1987, p. 30-38.

ABS: The results of an experiment whose goal was the generation of guidelines and the development of a data foundation for the specification of allowable time delay (TD) in ground-based simulators are examined. The effect of TD on flying qualities and manual flight control were studied during in-flight simulation where 'perfect' motion cuing was available. A ground-based no-motion replication of the in-flight experiment was also performed. Total delays of up to 150 msec were found to be tolerable in the simulation environment. This delay requirement reflects the most stringent condition of a highly maneuverable, highly responsive fighter aircraft simulation flown in a demanding task environment.

RPT#: AIAA PAPER 87-2370 87/00/00 87A49161

UTTL: Development of an airframe modification to improve the mission effectiveness of the EA-6B airplane

AUTH: A/HANLEY, ROBERT J.
PAA: A/(U.S. Naval Air Systems Command, Washington, DC) IN: AIAA Applied Aerodynamics Conference, 5th, Monterey, CA, Aug. 17-19, 1987, Technical Papers (A87-49051 21-02), New York, American Institute of Aeronautics and Astronautics, 1987, p. 241-247.
ABS: A higher-than-expected aircraft accident rate with the EA-6B aircraft has prompted an engineering study aimed at the quantitative characterization of its flying qualities at high angles-of-attack. Attention was given to the out-of-control flight regime, in order to arrive at an aerodynamic data base applicable to flight training simulators and, in addition, verify training manual procedures. Airframe modifications have been instituted to improve handling at high angles-of-attack; these encompass a wing glove strake, a vertical fin extension, inboard leading edge flap droop, and a trailing edge split flap.

RPT#: AIAA PAPER 87-2358 87/00/00 87A49075

UTTL: Closed-loop pilot vehicle analysis of the approach and landing task

AUTH: A/SCHMIDT, DAVID K.; B/ANDERSON, MARK R.
PAA: A/(Purdue University, West Lafayette, IN) CORP: Purdue Univ., West Lafayette, Ind. (Guidance, Navigation and Control Conference, Snowmass, CO, Aug. 19-21, 1985, Technical Papers, p. 30-38) Journal of Guidance, Control, and Dynamics (ISSN 0731-5090), vol. 10, Mar.-Apr. 1987, p. 187-194. Previously cited in issue 22, p. 3229, Accession no. A85-45880. 87/04/00 87A32233

UTTL: Control and display requirements for decelerating approach and landing of fixed- and rotary-wing VSTOL aircraft

AUTH: A/LEBACQZ, J. V.; B/HERTICK, V. K.; C/FRANKLIN, J. A.
PAA: C/(NASA, Ames Research Center, Moffett Field, CA) CDRP: National Aeronautics and Space Administration, Ames Research Center, Moffett Field, Calif. IN: American Helicopter Society, Annual Forum, 42nd, Washington, DC, June 2-4, 1986, Proceedings, Volume 2 (A87-19201 06-01), Alexandria, VA, American Helicopter Society, 1986, p. 1025-1045.

ABS: This paper reviews the results of several simulation investigations of rotary-wing and fixed-wing VSTOL aircraft performing terminal-area operations that include decelerating approaches under instrument conditions and recovery to either fixed landing pads or a ship. By concentrating on instrument decelerating approaches and the hover and landing, it is possible to compare directly the control and display requirements for similar tasks for aircraft with and without vectored thrust capability. Collectively, the results from these experiments, together with other simulator and flight experiments and operational experience, provide a consistent view of control and display complexity required for similar operational capability in adverse weather for the two types of VSTOL configurations. Some initial data showing influence of the transition corridor on flying qualities during transition are presented and lead to a general discussion of the problem of operating margin definition.

86/00/00 87A19279

UTTL: V-22 control law development

AUTH: A/GOLDSTEIN, K. W.; B/DOOLEY, L. W.
PAA: A/(Boeing Vertol Co., Ridley Park, PA); B/(Bell Helicopter Textron, Fort Worth, TX) IN: American Helicopter Society, Annual Forum, 42nd, Washington, DC, June 2-4, 1986, Proceedings, Volume 2 (A87-19201 06-01), Alexandria, VA, American Helicopter Society, 1986, p. 673-684.

ABS: The V-22 Daprey tilt rotor control law development that has been conducted during the 30 month preliminary design is described. The control law development has emphasized the flexibility of the tilt rotor configuration while minimizing flying qualities deficiencies with innovative use of the fly-by-wire control system. Separated Primary

and Automatic Flight Control Systems (AFCS and AFCS), control input lead shaping, and command response tailoring are three of the prime features of the V-22 control laws. The V-22 type specification requires that mission completion be demonstrated (a minimum of Level 2 handling qualities) for both AFCS ON and AFCS OFF flight configurations. Piloted simulation results for a variety of flight tasks have shown Level 1 to borderline Level 1/Level 2 ratings with the AFCS ON, and Level 2 ratings with the AFCS OFF. 86/00/00 87A19254

UTTL: Formulating an integrated flight control law synthesis strategy

AUTH: A/SCHMIDT, D. K.; B/ANDERSON, M. R.
 PAA: A/(Purdue University, West Lafayette, IN) AIAA, AHS, and ASEE, Aircraft Systems, Design and Technology Meeting, Dayton, OH, Oct. 20-22, 1986. 12 p. Research supported by the McDonnell Aircraft Co.

ABS: Three different model-following techniques, all based on linear, quadratic optimization theory, are reviewed in light of their ability to address several of the most important flight control design objectives. The relevant design objectives include flying qualities specifications and stability robustness; with particular attention paid to the demands made on the actuation hardware by the resulting control system. Evaluation of the algorithms is based on theoretical considerations as well as numerical results pertaining to a preliminary control system study for a highly unstable fighter configuration.

RPT#: AIAA PAPER 86-2711 86/10/00 87A17941

UTTL: A perspective on superaugmented flight control advantages and problems

AUTH: A/MCRUER, D.; B/JOHNSTON, D.; C/MYERS, T.
 PAA: C/(Systems Technology, Inc., Hawthorne, CA) CORP. Systems Technology, Inc., Hawthorne, Calif. Journal of Guidance, Control, and Dynamics (ISSN 0731-5090), vol. 9, Sept.-Oct. 1986, p. 530-540.

ABS: Superaugmented aircraft are an important subclass of actively controlled, highly augmented aircraft. The aircraft without augmentation is unstable; the control system not only redresses the stability and control imbalance, but also provides effective vehicle dynamics that differ in kind from those associated with conventional aircraft. In this paper, the longitudinal properties of highly unstable aircraft and typical superaugmented control systems used to remedy their dynamic deficiencies are explored generically. The topics considered include: (1) Basic flight control system architectures suitable to reduce or completely alleviate the unstable aircraft characteristics. (2) The primary dynamic characteristics and regulatory properties of typical superaugmented aircraft control systems, including governing factors in the linear system, dominant mode characteristics, and fundamental stability margin properties. The total available gain range factor is

presented as a basic measure that relates degree of instability, control system limitations, and key control system adjustments. (3) Some flying qualities features for superaugmented aircraft with rate command/altitude hold, extended bandwidth, and attitude command configurations. 86/10/00 87A17752

UTTL: Flight testing of aircraft and processing of test results
 AUTH: A/PASHKOVSKII, I. M.; B/LEONOV, V. A.; C/POPLAVSKII, B. K. Moscow, Izdatel'stvo Mashinostroeniye, 1985, 416 p. in Russian.

ABS: The book deals with the theoretical and practical aspects of the flight testing of aircraft and test data processing. Topics discussed include the theoretical principles of the flight testing of aircraft, preparation of the aircraft and of the crews for flight tests, special measurements and calibrations during flight testing, and methods for determining the principal performance and handling characteristics of aircraft. The discussion also covers in-flight studies of the critical regimes of state-of-the-art high-speed aircraft, deterministic and statistical processing of experimental data, and evaluation of parameters from flight test data. 85/00/00 87A17718

UTTL: Longitudinal control requirements for statically unstable aircraft

AUTH: A/BEAUFRERE, H.; B/SOEDER, S.
 PAA: B/(Grumman Aerospace Corp., Bethpage, NY) IN: MAECDN 1986; Proceedings of the National Aerospace and Electronics Conference, Dayton, OH, May 19-23, 1986. Volume 2 (A87-16726 OS-01). New York, Institute of Electrical and Electronics Engineers, 1986, p. 421-433.

ABS: Longitudinal control requirements are defined for statically unstable aircraft in terms of open- and closed-loop design parameters using classical frequency domain techniques. Design guides are presented for determining the effect that control loop hardware elements have on stability margins and closed-loop flying qualities. Loop elements containing transport delays are shown to be the most limiting factor on the amount of instability a configuration can have. 86/00/00 87A16770

UTTL: The pilot workload factor in aircraft handling qualities assessment

AUTH: A/WARNER, J. S.; B/DWYSTOTT, E. D.
 PAA: B/(Northrop Corp., Aircraft Div., Hawthorne, CA) IN: MAECDN 1986; Proceedings of the National Aerospace and Electronics Conference, Dayton, OH, May 19-23, 1986. Volume 2 (A87-16726 OS-01). New York, Institute of Electrical and Electronics Engineers, 1986, p. 349-354. Research supported by the Northrop Independent Research and Development Program.

ABS: Pilot task loading is a recognized factor in flight

sequences resulting in loss of control. An examination of the Cooper-Harper Rating Scale indicates that pilot workload is a dominant influence in the assignment of Pilot Opinion Ratings. An analytical model is constructed to investigate the interference effects of multiple piloted control tasks, including multi-axis control and side task intrusions. This methodology is applied to an example scenario involving a landing approach task with a Class IV vehicle operating in the presence of severe turbulence. 86/00/00 87A16760

UTTL: The MIL-prime standard for aircraft flying qualities
AUTH: A/WOODCOCK, R. J.; B/BROWNE, J. T.
PAA: B/(USAF, Wright-Patterson AFB, OH) IN: Atmospheric Flight Mechanics Conference, Williamsburg, VA, August 18-20, 1986, Technical Papers (A86-47651 23-08). New York, American Institute of Aeronautics and Astronautics, 1986, p. 232-238.

ABS: The new U.S. MIL-Standard and Handbook 'Flying Qualities of Piloted Aircraft' will update requirements for the procurement of aircraft and present them in a novel format, which proceeds through the categories of scope, reference documents, definitions, requirements, verification, and notes. Attention is given to frequency and time response control system specifications, and to pilot rating vs pilot position. Reasons are given for the avoidance of direct use of the Cooper-Harper (1969) standards.

RPT#: AIAA PAPER 86-2131 86/00/00 86A47677
UTTL: Effect of time delay on flying qualities - An update
AUTH: A/SMITH, R. E.; B/SARRAFIAN, S. K.
PAA: A/(NASA, Flight Research Center, Edwards, CA) CORP: National Aeronautics and Space Administration, Flight Research Center, Edwards, Calif. IN: Guidance, Navigation and Control Conference, Williamsburg, VA, August 18-20, 1986, Technical Papers (A86-47401 23-63). New York, American Institute of Aeronautics and Astronautics, 1986, p. 711-720.

ABS: Flying qualities problems of modern, full-authority electronic flight control systems are most often related to the introduction of additional time delay in aircraft response to a pilot input. These delays can have a significant effect on the flying qualities of the aircraft. This paper reexamines time delay effects in light of recent flight test experience with aircraft incorporating new technology. Data from the X-29A forward-swept-wing demonstrator, a related preliminary in-flight experiment, and other flight observations are presented. These data suggest that the present MIL-F-8785C allowable-control system time delay specifications are inadequate or, at least, incomplete. Allowable time delay appears to be a function of the shape of the aircraft response following the initial delay. The cockpit feel system is discussed as a dynamic element in the flight control system. Data presented indicate that the time

delay associated with a significant low-frequency feel system does not result in the predicted degradation in aircraft flying qualities. The impact of the feel system is discussed from two viewpoints: as a filter in the control system which can alter the initial response shape and, therefore, the allowable time delay, and as a unique dynamic element whose delay contribution can potentially be discounted by special pilot loop closures.

RPT#: AIAA PAPER 86-2202 86/00/00 86A47482
UTTL: Navy departure/spin and air combat maneuvering evaluation of a National Aeronautics and Space Administration developed flight control system for the F-14

AUTH: A/BAUCOM, C. M.; B/CLARK, C.
PAA: B/(U.S. Navy, Naval Air Test Center, Patuxent River, MD) IN: Society of Experimental Test Pilots, Symposium, 29th, Beverly Hills, CA, September 25-28, 1985, Proceedings (A86-44936 21-05). Lancaster, CA, Society of Experimental Test Pilots, 1985, p. 162-177.

ABS: An account is given of work done under a program involving NASA, Grumman Aerospace Corp., and the Navy, intended to design a system that would prevent spins without compromising the tactical maneuvering capability of the F-14. (As currently flown by the operational Navy) the F-14 exhibits two extremely undesirable flying qualities characteristics in the high angle-of-attack flight regime. First, lateral control surface deflections at high AOA can induce departure which may progress into an unrecoverable flat spin if recovery control inputs are delayed. Second, basic flying qualities are significantly degraded (typically by wing rock and lateral control reversal) at high AOA, thus increasing pilot workload in the tactical environment. An automatic-rudder interconnect (ARI) system was developed and enhanced with a low speed/high AOA cross control capability. Topics covered include: test airplane description; external store configurations; test site; simulation support of the flight test effort; and flight tests. The ARI concepts provided significantly improved high AOA flying qualities characteristics for the F-14. No serious degradation to the departure/spin resistance characteristics resulted. The low speed/high AOA cross control modification was successfully integrated into the flight control system; this option permitted the pilot to override the differential stabilator limiting and the lateral-stick-to-rudder-interconnect features, thus retaining the gross lateral control capability that currently exists in the production F-14. Future plans for further development of the ARI are noted. 85/00/00 86A44944

UTTL: Eigenstructure synthesis of an oblique wing flight control system
AUTH: A/LARSON, G. L.; B/WILLISTON, K. W.
PAA: B/(Rockwell International Corp., Los Angeles, CA) IN: Conference on Decision and Control, 24th, Fort Lauderdale,

FL, December 11-13, 1985, Proceedings, Volume 1 (AB6-42851 20-63). New York, Institute of Electrical and Electronics Engineers, Inc., 1985, p. 660-662. Research supported by Rockwell International Corp.

ABS: A flight control system design employing the recently developed linear control techniques of eigenstructure synthesis and command generator tracking is presented for an oblique wing fighter. The eigenvalues governing modal frequency and damping are developed such that the vehicle dynamics are compliant with MIL-F-8785C. 'Flying Qualities of Piloted Aircraft'. Eigenvalues are deterministically developed through output feedback in an attempt to achieve orthogonality, decoupling the symmetric and asymmetric modes of motion. The design is unique in that longitudinal and lateral/directional SAS are developed simultaneously using the same linear model. A simplified constrained controller is examined weighing complexity against performance, after which feed-forward gains are developed to translate desired pilot control to multisurface commands. For example, the NASA Oblique Wing Research Aircraft (OWRA) in transonic flight with the wing highly swept is presented as a demanding situation. 85/00/00 86A42913

AUTH: A/MORRHUSE, D. J.; B/MORAN, W. A.
PAA: A/USAF, Wright Aeronautical Laboratories, Wright-Patterson AFB, OH; B/(McDonnell Aircraft Co., St. Louis, MO) IN: NAECON 1985: Proceedings of the National Aerospace and Electronics Conference, Dayton, OH, May 20-24, 1985, Volume 2 (AB6-28326 12-04), New York, Institute of Electrical and Electronics Engineers, 1985, p. 1536-1545.

ABS: Interpretation and application of the military flying qualities specification, MIL-F-8785C, as the best guide to excellent flying qualities, is suggested. A summary is given of the government's flight control requirements of the Statement of Work of the STOL and Maneuver Technology Demonstration Program (SWTDP). The program contractor, McDonnell Aircraft Company, has had recent experience developing the digital flight control system of the F/A-18A. Lessons learned from that development are used to define the appropriate interpretations of specific requirements in MIL-F-8785C. These are expressed as preliminary detailed flying qualities criteria for the SWTDP, plus 'second tier' criteria to be used for additional design guidance. 85/00/00 86A28509

UTTL: Quantitative feedback design approach to pilot-in-the-loop analysis

AUTH: A/WEI, P.
PAA: A/(Lockheed-Georgia Co., Marietta, GA) IN: NAECON 1985: Proceedings of the National Aerospace and Electronics Conference, Dayton, OH, May 20-24, 1985, Volume 1 (AB6-28326 12-04), New York, Institute of Electrical and

Electronics Engineers, 1985, p. 416-423.

The quantitative feedback technique of Horowitz et al. (1980) is applied, in conjunction with the Neal-Smith criterion, to the pilot-in-the-loop flight control system design. The uncertain control plants are developed by varying the pilot model parameters and pilot compensation work, and the boundaries of the system performance requirements are specified on the basis of the Neal-Smith criterion. As an example, a shaping filter is designed to improve the flying qualities from a possible Level 3 to a definite Level 1. 85/00/00 86A28377

UTTL: Longitudinal flying qualities criteria for single-pilot instrument flight operations

A/BAR-GILL, A.; B/STENGEL, R. F.
PAA: A/(Rafael Armament Development Authority, Haifa, Israel); B/(Princeton University, NJ) CORP: Princeton Univ., N. J.; Rafael Armament Development Authority, Haifa (Israel) Journal of Aircraft (ISSN 0021-8689), vol. 23, Feb. 1986, p. 111-117. Previously announced in STAR as N83-30407.

ABS: Modern estimation and control theory, flight testing, and statistical analysis were used to deduce flying qualities criteria for General Aviation Single Pilot Instrument Flight Rule (SPIFR) operations. The principal concern is that unsatisfactory aircraft dynamic response combined with high navigation/communication workload can produce problems of safety and efficiency. To alleviate these problems, the relative importance of these factors must be determined. This objective was achieved by flying SPIFR tasks with different aircraft dynamic configurations and assessing the effects of such variations under these conditions. The experimental results yielded quantitative indicators of pilot's performance and workload, and for each of them, multivariate regression was applied to evaluate several candidate flying qualities criteria. 86/02/00 86A23186

UTTL: Closed-loop, pilot/vehicle analysis of the approach and landing task

A/SCHMIDT, D. K.; B/ANDERSON, M. R.
PAA: A/(Purdue University, West Lafayette, IN) CORP: Purdue Univ., West Lafayette, Ind. IN: Guidance, Navigation and Control Conference, Snowmass, CO, August 19-21, 1985, Technical Papers (AB5-45876 22-08), New York, AIAA, 1985, p. 30-38.

ABS: Optimal-control-theoretic modeling and frequency-domain analysis is the methodology proposed to evaluate analytically the handling qualities of higher-order manually controlled dynamic systems. Fundamental to the methodology is evaluating the interplay between pilot workload and closed-loop pilot/vehicle performance and stability robustness. The model-based metric for pilot workload is the required pilot phase compensation. Pilot/vehicle performance and loop stability is then evaluated using frequency-domain techniques. When these

qualities of piloted aircraft. Present handling qualities specifications do not include the effect of the display. A preliminary analysis of the influence of the display on a single axis tracking task is performed. The display is modeled by a set of parameters and a relation with tracking performance and pilot ratings is established via fixed-base simulation.

RPT#: AIAA PAPER 85-1805 85/00/00 85A43855

UTTL: Wright Brothers Lectureship in Aeronautics - Handling qualities and pilot evaluation
AUTH: A/HARPER, R. P., JR.; B/COOPER, G. E.
PAA: A/Calspan Corp., Buffalo, NY; B/(G.E. Cooper Associates, Saratoga, CA) AIAA, AHS, ASEE, Aircraft Design Systems and Operations Meeting, San Diego, CA, Oct. 31-Nov. 2, 1984, 18 p.

ABS: The dynamic system and constituent elements of the process of evaluating aircraft handling qualities are explored with an emphasis on simulation, evaluation through experiment, and historical progress. The dynamics of any aircraft are limited by the pilot's abilities as a controller. The pilot is limited by the flight envelope of the aircraft and the ergonomics of the control effectors. The system is therefore a closed loop. In simulators, a pilot's reactions to real-world events are modified by two situations: moving base simulations introduce attenuation and washout dynamics into motion feedbacks; fixed base simulators eliminate motion feedback altogether. The history of flight and test pilot reporting is traced from the Wright Brothers experiments, showing the negative flight stabilities and poor flight data in the early years of the aircraft industry. Handling qualities improved with the quality of flight test recording equipment, documentation standards, and servo-mechanisms for in-flight simulators. Finally, the interactive roles of aircraft engineers and pilot-evaluators in judging flying qualities in simulators are discussed.

RPT#: AIAA PAPER 84-2442 84/10/00 85A13534

UTTL: Investigation of pilot behavior in a training program for assessing handling qualities using a ground simulator
AUTH: A/ALTEMKIRCH, DIETRICH CORP: European Space Agency, Paris (France).
ABS: A pilot training session for rating handling qualities of transport aircraft was conducted with four test pilots by using a moving cockpit ground simulator. Each pilot flew three tasks take-off/climb, cruise/landing, approach/touchdown. In addition to the basic qualities of the aircraft, the pilots rated the handling qualities of two configurations differing in dynamics and control modes. Cooper-Harper pilot ratings and special effort ratings, as well as statistical values computed from measured performance data of the pilot/aircraft system are presented as a function of the configuration and turbulence levels.

techniques were applied to the flight-test data for thirty-two highly-augmented fighter configurations, strong correlation was obtained between the analytical and experimental results.

RPT#: AIAA PAPER 85-1851 85/00/00 85A45880

UTTL: Application of frequency domain handling qualities criteria to the longitudinal landing task
AUTH: A/SARRAFIAN, S. K.; B/POWERS, B. G.
PAA: B/INASA Flight Research Center, Edwards, CA) CORP: National Aeronautics and Space Administration, Flight Research Center, Edwards, Calif. IN: Guidance, Navigation and Control Conference, Snowmass, CO, August 19-21, 1985, Technical Papers (A85-45876 22-08), New York, AIAA, 1985, p. 1-12.

ABS: Three frequency-domain handling qualities criteria have been applied to the observed data to correlate the actual pilot ratings assigned to generic transport configurations with stability augmentation during the longitudinal landing task. The criteria are based on closed-loop techniques using pitch attitude, altitude rate at the pilot station, and altitude at the pilot station as dominating control parameters during this task. It is found that most promising results are obtained with altitude control performed by closing an inner loop on pitch attitude and closing an outer loop on altitude.

RPT#: AIAA PAPER 85-1848 85/00/00 85A45877

UTTL: A user friendly introduction to handling qualities
AUTH: A/TWISDALE, T. R.
PAA: A/USAF, Flight Test Center, Edwards AFB, CA) IN: NAECON 1984; Proceedings of the National Aerospace and Electronics Conference, Dayton, OH, May 21-25, 1984, Volume 1 (A85-44976 23-01), New York, IEEE, 1984, p. 457-463.

ABS: An account is given of the most important factors in aircraft handling quality research, specifications, design practices, and flight testing. Handling qualities are defined as the closed-loop interaction between pilot, aircraft, and data displays. The characterization of 'good' handling qualities in a consistent fashion is noted to be difficult due to variability in pilot ratings, which is in turn caused by differences in training, experience, task performance criteria, task evaluation, etc. It is concluded that a more complete understanding of handling qualities must await a more complete understanding of human dynamics.

RPT#: AIAA PAPER 84/00/00 85A45040

UTTL: Interaction between display dynamics and handling qualities in manual control tasks
AUTH: A/INNOCENTI, M.
PAA: A/Auburn University, AL) IN: Atmospheric Flight Mechanics Conference, 12th, Snowmass, CO, August 19-21, 1985, Technical Papers (A85-43826 21-08), New York, AIAA, 1985, p. 319-325.
ABS: New advanced displays have been shown to alter the flying

RPT#: NASA-TM-89147 L-16282 NAS 1.15:89147 87/09/00 87N26819

UTTL: Experimental investigation of the short-period requirements of MIL-F-8785C, volume 2
 A/BAILEY, RANDALL E. CORP: Calspan Advanced Technology Center, Buffalo, N.Y.

ABS: An investigation of the short period frequency requirements of MIL-F-8785C was performed using an in-flight simulator. Thirty-five evaluations of eighteen configurations were conducted. The experiment examined the minimum frequency boundary at three values of alpha for one true airspeed. The experiment included the effects of pilot location and evaluation task. The data indicate that the current requirement is essentially valid. The minimum acceptable frequency boundary may be relaxed, however, when the pilot station is forward of the center of rotation. Also, the phasing between the normal acceleration and pitch rate responses has been shown to be a critical determinant of longitudinal short period flying qualities. The results are analyzed also using the equivalent systems methodology.
 RPT#: AD-A181475 CALSPAN-7205-9-VOL-2 AFMAL-TR-86-3109-VOL-2 86/11/00 87N26917

UTTL: Handling qualities and pilot behavior during investigations on a ground simulator with a sidestick controller
 A/ALTEMKIRCH, DIETRICH CORP: Deutsche Forschungs- und Versuchsanstalt fuer Luft- und Raumfahrt, Brunswick (West Germany)

ABS: A pilot training procedure for rating the handling qualities of a transport aircraft was performed with three test pilots using a moving cockpit ground simulator. The emphasis was on the assessment of the flying qualities of future flight control systems in landing approach and landing tasks. The controller was a displacement sidestick with fixed force gradients. Cooper-Harper pilot ratings and special effort ratings, as well as statistical values computed from measured performance data of the pilot/aircraft system are presented for all pilots as a function of the aircraft configuration.
 DFVLR-MITT-86-20 ISSN-0176-7739 ETN-87-99680 86/09/00 87N26503

UTTL: Unusual airborne simulator applications
 A/REYNOLDS, PHILIP A. CORP: Calspan Advanced Technology Center, Buffalo, N.Y.
 ABS: Airborne simulation was conceived as a general purpose flying qualities research technique. Many diverse uses, forecast for the Total In-Flight Simulator (TIFS) while it was being developed, have come to pass, but diversity of application has exceeded even the most imaginative predictions. Some of the most unusual TIFS projects since it became active in 1971 are described. The objective is to help define and illustrate the role of airborne simulation in aerospace research and development as it

RPT#: ESA-TT-999 DFVLR-MITT-86-01 ETN-87-9111 87/09/00 88N12247

UTTL: Automation at the man-machine interface
 A/HOLLISTER, WALTER M. CORP: Massachusetts Inst. of Tech., Cambridge

ABS: There is a recognized need for automation. However, detailed analysis shows that the term automation is too broad for making specific research recommendations. The specific characteristics vary in kind and degree as a function of the piloting tasks. In some cases, the task should be left entirely to the pilot. In many cases, computer aiding is the best choice. A method for allocating functions between automated systems and the pilot is presented using the theory of divided attention. It describes a structured approach for reducing the control loop fraction with improved flying qualities. There is a need for fundamental research into the understanding of how the human pilot operates as part of the aircraft and weapons control system. 87/02/00 87N29504

UTTL: Piloted simulator study of allowable time delay in pitch flight control system of a transport airplane with negative static stability
 A/GRANTHAM, WILLIAM D.; B/SMITH, PAUL M.; C/PERSON, LEE H., JR.; D/MEYER, ROBERT T.; E/TINGAS, STEPHEN A.

PAA: E/(Lockheed-Georgia Co., Marietta.) CORP: National Aeronautics and Space Administration, Langley Research Center, Hampton, Va.
 ABS: A piloted simulation study was conducted to determine the permissible time delay in the flight control system of a 10-percent statically unstable transport airplane during cruise flight conditions. The math model used for the simulation was a derivative Lockheed L-1011 wide-body jet transport. Data were collected and analyzed from a total of 137 cruising flights in both calm- and turbulent-air conditions. Results of this piloted simulation study verify previous findings that show present military specifications for allowable control-system time delay may be too stringent when applied to transport-size airplanes. Also, the degree of handling-qualities degradation due to time delay is shown to be strongly dependent on the source of the time delay in an advanced flight control system. Maximum allowable time delay for each source of time delay in the control system, in addition to a less stringent overall maximum level of time delay, should be considered for large aircraft. Preliminary results also suggest that adverse effects of control-system time delay may be at least partially offset by variations in control gearing. It is recommended that the data base include different airplane baselines, control systems, and piloting tasks with many pilots participating, so that a reasonable set of limits for control-system time delay can be established to replace the military specification limits currently being used.

interfaces with analysis, ground simulation, and flight test. 86/09/00 87N23656

UTTL: A method for aircraft simulation verification and validation developed at the United States Air Force Flight Simulation Facility

AUTH: A/ANDERSON, G. R. CORP: Air Force Flight Test Center, Edwards AFB, Calif.
ABS: The flight simulators at the United States Air Force Flight Test Center (AFFTC), Aircraft Flight Simulation Facility (AFSF) are primarily used for performance and flying qualities studies. These high-fidelity, real-time simulators are used as an engineering tool during the flight development of new or modified aircraft. Emphasis is placed on fully developing, verifying and validating a simulation before the actual aircraft begins flight testing. The flexibility, accuracy and ease with which the facility's method of verification and validation can be learned and implemented are a few of its advantages. This is demonstrated by the number of simulations which have been developed using it. The F-16 A/B, B-1B, Shuttle, F-15 C/D, AFTI (Advanced Fighter Technology Integration) F-16, F-16 C/D, and the T-46 are examples of simulations presently operational at the facility which were developed using the AFSF's method. The philosophy of developing a simulation before flight test allows the most to be learned about the aircraft before testing begins. The test smarter approach taken at the AFFTC requires that aircraft simulations be built quickly and be used to make flight testing more efficient and safer. The method for verifying and validating simulations used at the AFSF assures that these requirements are fulfilled. 86/09/00 87N23654

UTTL: Computer simulation studies on human control reliability in manual aircraft control: The origin of PIO

AUTH: A/BRAUSER, K.; S/SEIFERT, R. CORP: Messerschmitt-Boelkow-Blom G.m.b.H., Munich (West Germany).
ABS: Pilot induced oscillations usually are defined as a sensitive indication of bad handling qualities. In the view of human performance reliability, PIO's are related to input errors with respect to the control characteristics of the controlled system. It is a general rule that man will make errors while performing arbitrary tasks under the influence of possible performance shaping factors (PSF's). A recently developed Task Taxonomy Method is used as a tool for the assessment of Human Error probabilities (REP) depending quantitatively on the effects of performance shaping factors (PSF) like task dimensions and characteristics, operator characteristics, system characteristics and environment factors. Using this Task Taxonomy procedure, HEP values for the manual aircraft control task have been calculated. HEP values are drastically increased (0.5 to 0.9) by the influence of bad handling qualities, while good handling qualities may only reduce the HEP value to 0.1, because other PSF's may

remain still active. Therefore PIO incidents remain possible, even in aircraft with good handling qualities. This has been demonstrated by means of SAINT computer simulations using appropriate HEP values. 86/09/00 87N23644

UTTL: Accurate prediction of longitudinal flying qualities for landing aircraft

AUTH: A/MARTZ, JAMES J. CORP: Air Force Inst. of Tech., Wright-Patterson AFB, Ohio.
ABS: A new longitudinal flying qualities metric, called Loop Separation Parameter (LSP), is intended to correlate with pilot opinion ratings for the landing task. This parameter is based on the observed shift of pilot control emphasis from pitch attitude control during power approach to flight path control during flare to touchdown. The calculation of LSP combines simple, intuitive pilot models with classical root locus and frequency response techniques. In this research, a new criterion based on LSP to predict expected pilot ratings is presented. Although developed from data for fighter-type aircraft, the LSP criterion successfully predicts pilot ratings for large transport and space shuttle configurations as well. This criterion is developed only for aircraft using front-side of the power curve landing techniques. The prediction of the power curve landing techniques, the prediction success of this criterion compares well with the success of MIL-F-8785C Flying Qualities Criteria. Recommendations include the consideration of LSP for the Flying Qualities Handbook.

RPT#: AD-A179069 AFIT/GAE/ENG/87M-1 86/12/00 87N22676

UTTL: A look at handling qualities of Canard configurations

AUTH: A/ANDERSON, SETH B. CORP: National Aeronautics and Space Administration, Ames Research Center, Moffett Field, Calif.
ABS: The first human-powered flight was achieved by a canard-configured aircraft (Wright Brothers). Although other canard concepts were flown with varying degrees of success over the years, the tail-aft configuration has dominated the aircraft market for both military and civil use. Reviewed are the development of several canard aircraft with emphasis on stability and control, handling qualities, and operating problems. The results show that early canard concepts suffered adversely in flight behavior because of a lack of understanding of the sensitivities of these concepts to basic stability and control principles. Modern canard designs have been made competitive with tail-aft configurations by using appropriate handling qualities design criteria.

RPT#: NASA-TM-88354 A-88332 NAS 1.15:88354 86/09/00 87N22629

UTTL: STOL handling qualities criteria for precision landings

AUTH: A/HOH, ROGER H.; B/MITCHELL, DAVID G. CORP: Systems Technology, Inc., Hawthorne, Calif.

ABS: This report documents an effort to expand on flying qualities design criteria for precision (STOL) landings. The primary emphasis is on non-powered lift, fighter-type aircraft using frontside control technique for longitudinal flight path control. The major thrust of this effort is, therefore, to be able to increase sortie generation due to bomb-damaged runways. Handling qualities criteria for STOL approaches and landings are developed. The proposed criteria have two elements: (1) the proper response-type for the task and (2) the minimum attitude and flight path bandwidths. Supporting data is reasonably complete for powered lift STOL aircraft, but less so for fighter STOL's. Fighter STOL's use precision touchdown accuracy and thrust reversing to achieve short field performance. A brief piloted moving base simulation was run on the USAF LAMARS to provide some data. Additional data was correlated from a variable stability inflight simulation of precision landings. A computer program was written to calculate all potential longitudinal and lateral handling qualities parameters for STOL approaches and landings. Finally, an extensive test plan is intended to provide guidance for future STOL testing.

RPT#: AD-A178369 STI-TR-1208-1 AFMALT-TR-88-3050 86/11/00 87N19400

UTTL: Development of an advanced pitch active control system for a wide body jet aircraft

AUTH: A/GUJMN, WILEY A.; B/RAISING, JERRY J.; C/DAVIS, MALT J. CORP; Lockheed-California Co., Burbank.

ABS: An advanced PACS control law was developed for a commercial wide-body transport (Lockheed L-1011) by using modern control theory. Validity of the control law was demonstrated by piloted flight simulation tests on the NASA Langley visual motion simulator. The PACS design objective was to develop a PACS that would provide good flying qualities to negative 10 percent static stability margins that were equivalent to those of the baseline aircraft at a 15 percent static stability margin which is normal for the L-1011. Also, the PACS was to compensate for high-mach/high-g instabilities that degrade flying qualities during upset recoveries and maneuvers. The piloted flight simulation tests showed that the PACS met the design objectives. The simulation demonstrated good flying qualities to negative 20 percent static stability margins for hold, cruise and high-speed flight conditions. Analysis and wind tunnel tests performed on other Lockheed programs indicate that the PACS could be used on an advanced transport configuration to provide a 4 percent fuel savings which results from reduced trim drag by flying at negative static stability margins.

RPT#: NASA-CR-172277 NAS 1.26:172277 LR-30844 84/02/01 87N17713

UTTL: Flared landing approach flying qualities. Volume 1: Experiment design and analysis

AUTH: A/WEINGARTEN, NORMAN C.; B/BERTHE, CHARLES J.; JR.;

C/RVNASKI, EDMUND G.: D/SARRAFIAN, SHAHAN K. CORP: Calspan Advanced Technology Center, Buffalo, N.Y.

Sponsored by NASA

ABS: An inflight research study was conducted utilizing the USAF Total Inflight Simulator (TIFS) to investigate longitudinal flying qualities for the flared landing approach phase of flight. The purpose of the experiment was to generate a consistent set of data for: (1) determining what kind of commanded response the pilot prefers in order to flare and land an airplane with precision, and (2) refining a time history criterion that took into account all the necessary variables and their characteristics that would accurately predict flying qualities. The result of the first part provides guidelines to the flight control system designer, using MIL-F-8785-(C) as a guide, that yield the dynamic behavior pilots prefer in flared landings. The results of the second part provides the flying qualities engineer with a newly derived flying qualities predictive tool which appears to be highly accurate. This time obtain predictive flying qualities criterion was applied to the flight data as well as six previous flying qualities studies, and the results indicate that the criterion predicted the flying qualities level 81% of the time and the Cooper-Harper pilot rating within + or - 1-60% of the time.

MASA-CR-178188-VOL-1 NAS 1.26:178188-VOL-1 REPT-7205-13-VOL-1 86/12/00 87N15234

UTTL: USAF test pilot school. Flying qualities textbook, Volume 2, part 1 CORP: Air Force Test Pilot School, Edwards AFB, Calif.

ABS: Flying qualities is that discipline in the aeronautical sciences that is concerned with basic aircraft stability and pilot-in-the-loop controllability. With advent of sophisticated flight control systems, vectored thrust, forward-swept wings, and negative static margins, the concept of flying qualities takes on added dimensions. In aeronautical literature there are three terms bandied about which are generally considered synonymous. These terms are flying qualities, stability and control, and handling qualities. Strictly speaking, they are synonymous. An early publication by Phillips in 1949 defines flying qualities of an aircraft as those stability and control characteristics that have an important bearing on the safety of flight and on the pilots' impressions of the ease of flying an aircraft in steady flight and in maneuvers. The specification's stated purpose of application is to assure flying qualities that provide adequate mission performance and flight safety regardless of design implementation or flight control system mechanization. Successful execution of the military mission then is the key to flying quality adequacy. A definition of flying qualities which can be agreed upon by both the USAF and the US Navy is: Flying qualities are those stability and control characteristics which influence the ease of safely flying an aircraft during

steady and maneuvering flight in the execution of the total mission.
RPT#: AD-A170959 USAF-TPS-CUR-86-02 86/04/00 87N13431

UTTL: Maximum normalized acceleration as a flying qualities parameter
AUTH: A/WARNER, J. S.; B/ONSTOTT, E. D. CORP: Northrop Corp., Hawthorne, Calif.

ABS: In 1984, Maximum Normalized Rate (MNR) was presented as a flying qualities parameter. Subsequent analysis of data from ground based simulation and flight test revealed the utility of a companion parameter, Maximum Normalized Acceleration (MNA). MNR and MNA profiles reveal the presence of both continuous and pulsed compensation strategies during discrete attitude tracking. In addition, MNR appears to be a suitable metric for pilot opinion in the LATHOS data base, while the MNR/MNA relationship is sensitive to pilot-induced-oscillation (PIO) and roll ratcheting problems. As part of an investigation of this problem, Northrop has developed an analysis technique known as the Step Target Method. The Step Target Method is essentially a one degree-of-freedom simulation, where an attitude command in the form of a step function is presented to a closed-loop pilot/aircraft model. The two parameters MNR and MNA were shown to be useful in Flying Qualities analysis. MNR was shown to correlate with Pilot Opinion Rating in the LATHOS data base, while MNA reflects PIO and roll ratcheting. Profiles of MNR versus MNA reveal the presence of pulsed compensation strategies in both ground based and in-flight simulation. Furthermore, comparison of continuous and discrete attitude tracking simulation data reveals that these two tracking tasks exhibit independent sensitivities to aircraft characteristics. 86/05/00 86N33012

UTTL: A flight test method for pilot/aircraft analysis
AUTH: A/KOEHLER, J.; B/BUCHACKER, E. CORP: Institut fuer Flugmechanik, Brunswick (West Germany).
ABS: In high precision flight maneuvers a pilot is a part of a closed loop pilot/aircraft system. The assessment of the flying qualities is highly dependent on the closed loop characteristics related to precision maneuvers like approach, landing, air-to-air tracking, air-to-ground tracking, close formation flying and air-to air refueling of the receiver. The object of a research program at DFVLR is the final flight phase of an air to ground mission. In this flight phase the pilot has to align the aircraft with the target, correct small deviations from the target direction and keep the target in his sights for a specific time period. To investigate the dynamic behavior of the pilot-aircraft system a special ground attack flight test technique with a prolonged tracking maneuvers was developed. By changing the targets during the attack the pilot is forced to react continuously on aiming errors in his sights. Thus the closed loop pilot/aircraft system is excited over a wide frequency range of interest, the pilot

gets more information about mission oriented aircraft dynamics and suitable flight test data for a pilot/aircraft analysis can be generated. 86/05/00 86N33011

UTTL: Failures in advanced flight control systems of future transport aircraft
AUTH: A/VANGDOL, M. F. C.; B/RICKARD, W. W.
PAA: B/(McDonnell-Douglas Corp., Long Beach, Calif.) CORP: National Aerospace Lab., Amsterdam (Netherlands).

ABS: Failure probability and the effects of flight control system failures on handling qualities of a medium-weight transport with reduced stability equipped with a side-stick controlled fly-by-wire flight control system were studied in a flight simulator. A very simple electrical back-up system was used to reduce the pitch divergence when the primary flight control system failed. Results indicate that a large variability in pilot ratings can occur in this kind of investigation. However, analysis of the ratings and the associated commentary provides a ranking of the configurations used from good to bad. The results are compared to the existing criteria for handling qualities. It is shown that the rankings correlate well with closed-loop performance criterion, and Mil-F-8785 C criteria, whereas other criteria are either not applicable (time history criteria), or inappropriate (static stability criterion, bandwidth criterion).
RPT#: NLR-TR-84108-U ETM-86-96983 84/11/12 86N26343

UTTL: Analysis of flexible aircraft longitudinal dynamics and handling qualities. Volume 1: Analysis methods
AUTH: A/WASZAK, M. R.; B/SCHMIDT, D. S. CORP: Purdue Univ., West Lafayette, Ind.
ABS: As aircraft become larger and lighter due to design requirements for increased payload and improved fuel efficiency, they will also become more flexible. For highly flexible vehicles, the handling qualities may not be accurately predicted by conventional methods. This study applies two analysis methods to a family of flexible aircraft in order to investigate how and when structural (especially dynamic aeroelastic) effects affect the dynamic characteristics of aircraft. The first type of analysis is an open loop model analysis technique. This method considers the effects of modal residue magnitudes on determining vehicle handling qualities. The second method is a pilot in the loop analysis procedure that considers several closed loop system characteristics. Volume 1 consists of the development and application of the two analysis methods described above.
RPT#: NASA-CR-177943-VOL-1 NAS 1.26:177943-VOL-1 85/06/00 85N35202

UTTL: Aspects of application of ACT systems for pilot workload alleviation
AUTH: A/WILHELM, K.; B/GHELIN, B. CORP: Deutsche Forschungs- und Versuchsanstalt fuer Luft- und Raumfahrt, Brunswick

B-12

(West Germany).
An essential element in the construction of future civil and military aircraft will be the inclusion of Active Control Technology (ACT) in the design process. This will be true for fixed-wing aircraft as well as for rotary-wing aircraft. The implementation of ACT makes possible improvements in flight performance and handling qualities. In particular, ACT can lead to alleviation of pilot workload in performing a specific task. This can be achieved by reducing undesirable motions and effects and adjusting the aircraft dynamics to a certain flight task and to the pilot. The above-mentioned problem areas concerning the implementation of ACT are discussed. Piloting problems with conventional systems and the influence of ACT systems on flying qualities and pilot workload are covered. Results from wind tunnel testing and flight testing using a BO 105 type helicopter and the HFB 320 in-flight simulator are given. 85/03/00 85N27887

ABS:

B-13

REPORT DOCUMENTATION PAGE			
1. Recipient's Reference	2. Originator's Reference	3. Further Reference	4. Security Classification of Document
	AGARD-LS-157	ISBN 92-835-0461-5	UNCLASSIFIED
5. Originator	Advisory Group for Aerospace Research and Development North Atlantic Treaty Organization 7 rue Ancelle, 92200 Neuilly sur Seine, France		
6. Title	ADVANCES IN FLYING QUALITIES		
7. Presented	on 26-27 May 1988 in Delft, The Netherlands, on 30-31 May 1988 in Rome, Italy and on 15-16 June 1988 in Torrance, USA.		
8. Author(s)/Editor(s)	Various		9. Date May 1988
10. Author's/Editor's Address	Various		11. Pages 194
12. Distribution Statement	This document is distributed in accordance with AGARD policies and regulations, which are outlined on the Outside Back Covers of all AGARD publications.		
13. Keywords/Descriptors	<p> > Flight characteristics , Mathematical models Flight control Flight simulators Pilots (personnel) Aircraft Human factors engineering, <i>France, (SDU) ←</i> </p>		
14. Abstract	<p> > Judging the suitability of an aircraft to safely and effectively perform its mission without undue pilot skill and discomfort is what "flying qualities" is all about. Central to such judgement, and to the design of suitable aircraft plus flight control systems, is an understanding of what the pilot can do with ease and comfort or conversely what bothers him. The Lectures are designed to impart such understanding to both novice and seasoned practioners in flying qualities and flight control and thereby to provide the bridge required to extend flying qualities requirements from simple "classic" response aircraft, to the responses attending the use of full-time active control. It also provides a unifying connection among the empirically derived flying qualities requirements of different aircraft types, e.g. fixed- and rotary-wing. </p> <p> Mathematical models of pilot control behaviour are explained. The application of various models to flying qualities problems is discussed; and the influences, regarding the generic likes and dislikes of pilots drawn from such studies are listed. The effects of distractions are examined. </p> <p> → For purposes of ready and universal "characterization", the aircraft plus flight control system (plus displays if applicable), is approximately matched by a lower order equivalent system of sufficient bandwidth to be indicative of the pilot's concerns. The fixed form representations for such equivalent systems and the "matching" considerations are described; and the experimental data base is also discussed. Finally, some of the pitfalls and benefits of using simulators for flight control system development and flying qualities research are exposed and clarified. <i>Keywords:</i> </p> <p> This Lecture Series, sponsored by the Flight Mechanics Panel of AGARD, has been implemented by the Consultant and Exchange Programme. <i>flight</i> </p>		

<p>AGARD Lecture Series No.157 Advisory Group for Aerospace Research and Development, NATO ADVANCES IN FLYING QUALITIES Published May 1988 194 pages</p> <p>Judging the suitability of an aircraft to safely and effectively perform its mission without undue pilot skill and discomfort is what "flying qualities" is all about. Central to such judgement, and to the design of suitable aircraft plus flight control systems, is an understanding of what the pilot can do with ease and comfort or conversely what bothers him. The Lectures are designed to impart such understanding to both novice and seasoned practitioners in flying qualities and flight control and thereby to provide the</p> <p>P.T.O.</p>	<p>AGARD-LS-157</p> <p>Flight characteristics Flight control Pilots (personnel) Human factors engineering Mathematical models Flight simulators Aircraft</p>	<p>AGARD-LS-157</p> <p>Flight characteristics Flight control Pilots (personnel) Human factors engineering Mathematical models Flight simulators Aircraft</p>	<p>AGARD-LS-157</p> <p>Flight characteristics Flight control Pilots (personnel) Human factors engineering Mathematical models Flight simulators Aircraft</p>
<p>AGARD Lecture Series No.157 Advisory Group for Aerospace Research and Development, NATO ADVANCES IN FLYING QUALITIES Published May 1988 194 pages</p> <p>Judging the suitability of an aircraft to safely and effectively perform its mission without undue pilot skill and discomfort is what "flying qualities" is all about. Central to such judgement, and to the design of suitable aircraft plus flight control systems, is an understanding of what the pilot can do with ease and comfort or conversely what bothers him. The Lectures are designed to impart such understanding to both novice and seasoned practitioners in flying qualities and flight control and thereby to provide the</p> <p>P.T.O.</p>	<p>AGARD-LS-157</p> <p>Flight characteristics Flight control Pilots (personnel) Human factors engineering Mathematical models Flight simulators Aircraft</p>	<p>AGARD-LS-157</p> <p>Flight characteristics Flight control Pilots (personnel) Human factors engineering Mathematical models Flight simulators Aircraft</p>	<p>AGARD-LS-157</p> <p>Flight characteristics Flight control Pilots (personnel) Human factors engineering Mathematical models Flight simulators Aircraft</p>

<p>bridge required to extend flying qualities requirements from simple "classic" response aircraft, to the responses attending the use of full-time active control. It also provides a unifying connection among the empirically derived flying qualities requirements of different aircraft types, e.g. fixed- and rotary-wing.</p> <p>Mathematical models of pilot control behaviour are explained. The application of various models to flying qualities problems is discussed; and the influences, regarding the generic likes and dislikes of pilots drawn from such studies are listed. The effects of distractions are examined.</p> <p>For purposes of ready and universal "characterization", the aircraft plus flight control system (plus displays if applicable), is approximately matched by a lower order equivalent system of sufficient bandwidth to be indicative of the pilot's concerns. The fixed form representations for such equivalent systems and the "matching" considerations are described; and the experimental data base is also discussed. Finally, some of the pitfalls and benefits of using simulators for flight control system development and flying qualities research are exposed and clarified.</p> <p>This Lecture Series, sponsored by the Flight Mechanics Panel of AGARD, has been implemented by the Consultant and Exchange Programme.</p> <p>ISBN 92-835-0461-5</p>	<p>bridge required to extend flying qualities requirements from simple "classic" response aircraft, to the responses attending the use of full-time active control. It also provides a unifying connection among the empirically derived flying qualities requirements of different aircraft types, e.g. fixed- and rotary-wing.</p> <p>Mathematical models of pilot control behaviour are explained. The application of various models to flying qualities problems is discussed; and the influences, regarding the generic likes and dislikes of pilots drawn from such studies are listed. The effects of distractions are examined.</p> <p>For purposes of ready and universal "characterization", the aircraft plus flight control system (plus displays if applicable), is approximately matched by a lower order equivalent system of sufficient bandwidth to be indicative of the pilot's concerns. The fixed form representations for such equivalent systems and the "matching" considerations are described; and the experimental data base is also discussed. Finally, some of the pitfalls and benefits of using simulators for flight control system development and flying qualities research are exposed and clarified.</p> <p>This Lecture Series, sponsored by the Flight Mechanics Panel of AGARD, has been implemented by the Consultant and Exchange Programme.</p> <p>ISBN 92-835-0461-5</p>
<p>bridge required to extend flying qualities requirements from simple "classic" response aircraft, to the responses attending the use of full-time active control. It also provides a unifying connection among the empirically derived flying qualities requirements of different aircraft types, e.g. fixed- and rotary-wing.</p> <p>Mathematical models of pilot control behaviour are explained. The application of various models to flying qualities problems is discussed; and the influences, regarding the generic likes and dislikes of pilots drawn from such studies are listed. The effects of distractions are examined.</p> <p>For purposes of ready and universal "characterization", the aircraft plus flight control system (plus displays if applicable), is approximately matched by a lower order equivalent system of sufficient bandwidth to be indicative of the pilot's concerns. The fixed form representations for such equivalent systems and the "matching" considerations are described; and the experimental data base is also discussed. Finally, some of the pitfalls and benefits of using simulators for flight control system development and flying qualities research are exposed and clarified.</p> <p>This Lecture Series, sponsored by the Flight Mechanics Panel of AGARD, has been implemented by the Consultant and Exchange Programme.</p> <p>ISBN 92-835-0461-5</p>	<p>bridge required to extend flying qualities requirements from simple "classic" response aircraft, to the responses attending the use of full-time active control. It also provides a unifying connection among the empirically derived flying qualities requirements of different aircraft types, e.g. fixed- and rotary-wing.</p> <p>Mathematical models of pilot control behaviour are explained. The application of various models to flying qualities problems is discussed; and the influences, regarding the generic likes and dislikes of pilots drawn from such studies are listed. The effects of distractions are examined.</p> <p>For purposes of ready and universal "characterization", the aircraft plus flight control system (plus displays if applicable), is approximately matched by a lower order equivalent system of sufficient bandwidth to be indicative of the pilot's concerns. The fixed form representations for such equivalent systems and the "matching" considerations are described; and the experimental data base is also discussed. Finally, some of the pitfalls and benefits of using simulators for flight control system development and flying qualities research are exposed and clarified.</p> <p>This Lecture Series, sponsored by the Flight Mechanics Panel of AGARD, has been implemented by the Consultant and Exchange Programme.</p> <p>ISBN 92-835-0461-5</p>