

(S) 27/2/77 NDR

P-341940

AGARD-AR-342

AGARD-AR-342

AGARD

136A

ADVISORY GROUP FOR AEROSPACE RESEARCH & DEVELOPMENT
7 RUE ANCELLE, 92200 NEUILLY-SUR-SEINE, FRANCE

AGARD ADVISORY REPORT 342

Precision Terminal Guidance for Munitions

(le Guidage terminal précis pour les munitions)

This report has been prepared as a summary of the deliberations of Working Group 02 of the Mission Systems Panel of AGARD.

Processed / Not Processed by DIMS
.....signed 23/4/77 date
NOT FOR DESTRUCTION

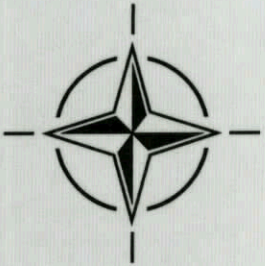

NORTH ATLANTIC TREATY ORGANIZATION

Published February 1997

Distribution and Availability on Back Cover

UNLIMITED

AGARD

ADVISORY GROUP FOR AEROSPACE RESEARCH & DEVELOPMENT

7 RUE ANCELLE, 92200 NEUILLY-SUR-SEINE, FRANCE

AGARD ADVISORY REPORT 342

Precision Terminal Guidance for Munitions

(le Guidage terminal précis pour les munitions)

This report has been prepared as a summary of the deliberations of Working Group 02 of the Mission Systems Panel of AGARD.

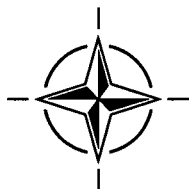

North Atlantic Treaty Organization
Organisation du Traité de l'Atlantique Nord

The Mission of AGARD

According to its Charter, the mission of AGARD is to bring together the leading personalities of the NATO nations in the fields of science and technology relating to aerospace for the following purposes:

- Recommending effective ways for the member nations to use their research and development capabilities for the common benefit of the NATO community;
- Providing scientific and technical advice and assistance to the Military Committee in the field of aerospace research and development (with particular regard to its military application);
- Continuously stimulating advances in the aerospace sciences relevant to strengthening the common defence posture;
- Improving the co-operation among member nations in aerospace research and development;
- Exchange of scientific and technical information;
- Providing assistance to member nations for the purpose of increasing their scientific and technical potential;
- Rendering scientific and technical assistance, as requested, to other NATO bodies and to member nations in connection with research and development problems in the aerospace field.

The highest authority within AGARD is the National Delegates Board consisting of officially appointed senior representatives from each member nation. The mission of AGARD is carried out through the Panels which are composed of experts appointed by the National Delegates, the Consultant and Exchange Programme and the Aerospace Applications Studies Programme. The results of AGARD work are reported to the member nations and the NATO Authorities through the AGARD series of publications of which this is one.

Participation in AGARD activities is by invitation only and is normally limited to citizens of the NATO nations.

The content of this publication has been reproduced
directly from material supplied by AGARD or the authors.

Published February 1997

Copyright © AGARD 1997
All Rights Reserved

ISBN 92-836-1048-2



Printed by Canada Communication Group
45 Sacré-Cœur Blvd., Hull (Québec), Canada K1A 0S7

Precision Terminal Guidance for Munitions

(AGARD AR-342)

Executive Summary

Working Group 02 (originally Guidance and Control Panel working Group 13) was approved by the AGARD National Delegates Board in the Spring of 1991, shortly after the Gulf War with Iraq. The effectiveness of the guided munitions used in that conflict emphasised their importance in “conventional” warfare. Following this experience, the lessons learned from military interventions by NATO nations has often yielded less clear-cut results. In spite of these recent events, it seems clear that the future of precision guidance is assured, for reasons similar to those prevailing during the Gulf War, that is, their usefulness as a “force multiplier”. This enables them to:

- maximise the effective fire power of launch platforms;
- minimise the number of missions required to carry out a given task;
- reduce collateral damage to non-combatants to a minimum.

The Working Group oriented its aims towards NATO military needs and the review of terminal guidance technology in relation to those needs, using the two following items as a starting point:

- the AGARD planning guidelines, which give a top-down view, derived from the NATO strategic concept;
- an analysis by GCP of the implications of the Gulf War for guidance and control.

The review of terminal guidance technologies was also aimed at identifying new capabilities not currently part of NATO’s armoury. Projections into the future often produce speculative concepts that, in the light of deeper study, turn out to be unworkable, unaffordable or even misguided. But new ideas, however impractical at first sight, are the stimulus NATO needs to stay at the forefront of technology advances.

Le guidage terminal précis pour les munitions (AGARD AR-342)

Synthèse

La création du groupe de travail MSP 02 (à l'origine, le groupe de travail N° 13 de la Commission Guidage et Pilotage) a été approuvée par le Conseil des délégués nationaux de l'AGARD au printemps 1991, peu de temps après l'issue de la guerre du Golfe. Le succès rencontré par les munitions guidées, déployées lors du conflit, a mis en exergue leur importance dans une guerre "classique". Après cette expérience, les enseignements tirés des interventions militaires décidées par les pays membres de l'OTAN, se sont souvent avérés moins explicites. En dépit de ces récents constats, il apparaît évident que l'avenir du guidage de précision reste efficace, pour des raisons analogues à celles qui prévalaient lors de la guerre du Golfe à savoir leur utilité en tant que "multiplicateurs de forces". En effet, cette dernière capacité permet:

- de maximaliser la puissance de feu réelle des plates-formes de lancement;
- de réduire au minimum le nombre de missions requises pour exécuter une tâche donnée;
- de réduire au minimum les dommages collatéraux au niveau des non-combattants.

Le groupe de travail s'est orienté dans la définition des besoins militaires de l'OTAN, et dans l'examen des technologies du guidage terminal en fonction de ces besoins. Pour ce faire, il a été considéré comme points de départ:

- les directives de planifications de l'AGARD dérivées du Concept Stratégique de l'OTAN;
- une analyse réalisée par GCP des implications de guidage et de pilotage dans la guerre du Golfe.

L'examen des technologies du guidage final avait également pour objectif d'identifier de nouveaux concepts qui ne sont pas, à ce jour, en service dans l'armement de l'OTAN. Cette projection conduit le plus souvent à proposer des concepts "exotiques", lesquels, à la lumière d'examen plus approfondis, peuvent s'avérer trop dispendieux, irréalisables, voire même inopportuns. Les idées nouvelles, si utopiques qu'elles puissent paraître au premier abord, représentent, pour l'OTAN, une stimulation nécessaire qui lui permettra de rester à la pointe du progrès technologique.

Contents

	Page
Executive Summary	iii
Synthèse	iv
Working Group Membership	vii
Acronyms and Abbreviations	viii
CHAPTER 1 INTRODUCTION	1
1.1 Background	1
1.2 Content of the Report	2
CHAPTER 2 TERMINAL GUIDANCE SYSTEMS	3
2.1 Guidance Concepts	3
2.2 Seeker Functions	7
2.3 Target Characteristics	12
2.4 Seeker Programmes	13
CHAPTER 3 MILITARY NEEDS	17
3.1 NATO Strategic Needs	17
3.2 Operational Experience	19
3.3 Future PGM Needs	21
3.4 Summary of Needs	24
CHAPTER 4 TECHNOLOGY TRENDS	25
4.1 Sensors	25
4.2 Signal/Data Processing	29
4.3 Guidance Laws (Tracking & Homing Processes)	38
4.4 Seeker Stabilization	39
4.5 Inertial Sensors	43
4.6 Global Positioning System (GPS)	47
4.7 GPS/INS Integration	49
4.8 Communications/Command Links	53
4.9 Countermeasures & Counter-Countermeasures	54
4.10 Chapter Four Overview	57
CHAPTER 5 USER CONCERNS	61
5.1 Mission Planning	61
5.2 Identification of Friend or Foe (IFF)	65
5.3 Battle Damage Assessment (BDA)	66
5.4 Cost - Schedule	67
5.5 Environmental Issues	73
5.6 Chapter Five Overview	74
CHAPTER 6 FUTURE CAPABILITIES	75
6.1 Global Targeting and Force Projection	75
6.2 All-Weather Operation	75

6.3	Miniaturized Munitions	76
6.4	Rationalised Inventories and “On-Demand” Munitions	76
6.5	Integral IFF	78
6.6	Unmanned Aircraft	78
6.7	Novel Weapon Concepts	78
6.8	Chapter Six Overview	79
CHAPTER 7 CONCLUSIONS AND RECOMMENDATIONS		81
7.1	Potential to Meet NATO Needs	81
7.2	NATO Cooperation	82
Appendix A — Basic Definitions		85
Appendix B — Terrain Referenced Navigation		89
Appendix C — Countermeasures		97
Appendix D — Relative GPS Techniques		103

Members of the Working Group

*Dr Pedro SANZ-ARANGUEZ
Profesor Universidad
ETS de Ingenieros Aeronauticos
Madrid Polytechnical University
Pza Cardenal Cisneros, 3
28040 MADRID
SPAIN

Dr George SCHMIDT
M/S 2A
The Charles Stark Draper Laboratory
555 Technology Square
CAMBRIDGE, MA 02139
UNITED STATES

Dr Steven BUTLER
Technical Director
HQ AFMC/EN
4375 Chidlaw Rd, Ste 6
WRIGHT-PATTERSON AFB, OH 45433-5006
UNITED STATES

Mr Thierry URING
THOMSON-CSF/CNI
160 Bd de Valmy, BP 82
92704 COLOMBES CEDEX
FRANCE

Mr S LEEK
8 Sunnyfield
HATFIELD, HERTFORDSHIRE AL9 5DX
UNITED KINGDOM

Other contributors to the Working Group or to this report are listed below:

Dr Drayton BOOZER
Sandia National Laboratories
Organization 4400
PO Box 5800
ALBUQUERQUE, NM 87185-5800
UNITED STATES

Mr Gonzalo FERNANDEZ DE LA MORA
SENER Ingenieria y Sistemas SA
C/Severo Ochoa s/n
Parque Tecnologico
28760 TRES CANTOS (MADRID)
SPAIN

Acronyms and Abbreviations

The following is a list of acronyms and abbreviations employed in this document. It does not include acronyms used as names of projects or systems, with a few exceptions where the term appears frequently or is used in a generic sense.

AAM	Air-to-Air Missile
AASC	(AGARD) Aerospace Applications Studies Committee
AGARD	(NATO) Advisory Group for Aerospace Research and Development
AHRS	Attitude Heading Reference System
ALCM	Air Launched Cruise Missile
APN	Augmented Proportional Navigation
ARPA	Advanced Research Projects Agency (formerly Defense ARPA, DARPA)
ASM	Air-to-Surface Missile
ATR	Automatic Target Recognition
BAM	Bidirectional Associative Memory
BDA	Battle Damage Assessment
C/A	(GPS) Coarse Acquisition
CAD	Computer Aided Design
CADCAM	Computer Aided Design / Computer Aided Manufacture
CCD	Camouflage, Concealment and Deception or Charge-Coupled Device
CCM	Counter-Countermeasure
CEP	Circular Error, Probable
CFAR	(Appendix C) Constant False Alarm Rate
CINCHAN	Commander in Chief Channel (NATO Command)
CLOS	Command to Line Of Sight
CLT	Centre Level Tracking
CM	Countermeasure
CMW	Centimetre Wave
DGPS	Differential GPS
DLMS	Digital Landmass System
DMA	Defense Mapping Agency
DTED	Digital Terrain Elevation Data
DWT	Discrete Wavelet Transform
ECCM	Electronic Counter-Countermeasures
ECM	Electronic Countermeasures
EMCON	Emission Control
EO	Electro-Optical
ERP	Effective Radiated Power
ESM	Electronic Support Measures
FEI	Fuzzy Expected Interval
FEV	Fuzzy Expected Value
FLIR	Forward Looking Infrared
FM	Frequency Modulation
FMCW	Frequency Modulated Continuous Wave
FOG	Fibre Optic Gyro
FOR	Field of Regard
FOV	Field of View
FPA	Focal Plane Array
G&C	Guidance and Control
GCP	(AGARD) Guidance and Control Panel
GLONASS	Global Orbiting Navigation Satellite System
GN&C	Guidance, Navigation and Control
GPS	Global Positioning System
HgCdTe	Mercury-Cadmium-Teluride
IF	Intermediate Frequency
IFF	Identification, Friend or Foe
IIR or I ² R	Imaging Infrared

IMU	Inertial Measurement Unit
INS	Inertial Navigation System
IPT	Integrated Product Team
IR	Infrared
ISO	International Standards Organisation
ladar	Laser Radar
LOS	Line of Sight
LWIR	Long Wave Infrared
MMW	Millimetre Wave
MSP	(AGARD) Mission Systems Panel
MWIR	Medium Wave Infrared
NdYAG	Neodymium-Yttrium-Garnet
NEΔT	Noise Equivalent Differential Temperature
NIAG	NATO Industrial Advisory Group
nm	Nautical Mile or nanometres
O&M	Operation and Maintenance
PbS	Lead Sulphide
PGM	Precision Guided Munition
ppm	parts per million
PPS	(GPS) Precise Positioning Service
PRF	Pulse Repetition Frequency
R&D	Research and Development
RAM	Random Access Memory
RCS	Radar Cross Section
RF	Radio Frequency
RGPS	Relative GPS
RHWR	Radar Homing and Warning Receiver
RLG	Ring Laser Gyro
ROM	Read-Only Memory
rss	Root Sum of Squares
S/A	(GPS) Selective Availability
SACEUR	Supreme Allied Commander Europe (NATO Command)
SACLANT	Supreme Allied Commander Atlantic (NATO Command)
SAR	Synthetic Aperture Radar
SBW	Space Bandwidth
SHAPE	Supreme Headquarters, Allied Powers in Europe
SLT	Sensor Level Tracking
SSM	Surface-to-Surface Missile
STC	SHAPE Technical Centre
TF/TA	Terrain Following / Terrain Avoidance
TRN	Terrain Referenced Navigation
UAV	Unmanned Air (or Aerial) Vehicle
VBA	Vibrating Beam Accelerometer
VGS	Velocity Gate Stealer
WFEV	Weighted Fuzzy Expected Value
WGS	World Geodetic System
WSO	Weapon System Operator

CHAPTER 1. INTRODUCTION

1.1. Background

The first meeting of the GCP's Working Group 13 (subsequently MSP Working Group 02) was held in the autumn of 1992, eighteen months after the end of the Gulf War (Operation Desert Storm). In its Spring 1991 Business Meeting the GCP, prompted by the apparent success of guided munitions in Operation Desert Storm, had also initiated a study (reference 1.1) of its implications for guidance and control. Two important aspects of guided munitions employment in modern warfare were tested in that conflict: firstly, precision attack and secondly, stand-off attack. Both aspects were featured in the symposium on "Advances in Guidance and Control of Precision Guided Weapons." at the 54th meeting of the Guidance and Control Panel in May 1992.

Precision guided air-to-surface munitions played a major role in Operation Desert Storm, making it possible to attack important targets, such as Iraqi command, control and communications assets, supply routes, and resources, with a minimum of damage to civilian areas. More than in any previous conflict, the avoidance of collateral damage was a major issue in mission planning and execution, because of the intense and – in the West – largely uncensored news media coverage. By avoiding the need for repeat sorties, PGM also made an important contribution to reducing losses. It is reported for example that of the 90,000 tonnes or so of munitions delivered by US aircraft on Iraq and occupied Kuwait, 7% were precision guided munitions, 90% of which hit their target, compared to only 25% of the conventional bombs that were dropped. The implications are obvious.

The attack of heavily defended high-value fixed targets by stand-off munitions, though not one of the most important factors in Operation Desert Storm's success, was also a significant pointer for the future. The circumstances of a limited – though intense – war emphasise the importance of air-launched and surface-launched stand-off munitions as partial alternatives to manned aircraft missions and forward deployment of ground and sea-borne forces.

A final issue of major importance to the Alliance was cost. The preceding Operation Desert Shield lasted six months and involved transportation of immense quantities of materiel as well as personnel. The total cost of the Gulf War, and the build-up to it, was some \$53 billion. Clearly, improved munitions effectiveness could have a dramatic impact on the indirect cost of similar operations in the future by alleviating the logistics burden, as well as on direct costs by reducing the required scale of operations. Improvements in terminal guidance to increase accuracy of delivery, autonomy of operation, resistance to countermeasures, and adaptability in use, would all help to save cost.

AGARD, in planning its technical programmes, has focused increasingly on technologies to improve Nato Forces' effectiveness. This is a response to changing circumstances since the end of the Cold War, reflected in Nato's new Strategic Concept of 1991 and in reduced national defence budgets. The analysis that led up to AGARD's planning guidelines for specialist panels, plus the GCP's own analysis, have been important drivers for the Working Group.

The declared objectives of the Working Group were: "to review the state of the art in seeker technology in Nato countries and document current capabilities;" – "conduct analyses to determine capabilities of future seeker technology to provide precision terminal guidance in representative threat scenarios and in realisable munition sizes" (a specific focus was to be on the application of multi-sensor and multi-mode seekers to munitions in the year 2000 and beyond); – "make recommendations for future work;" and "document all the results in a report" : in short, to review present and future terminal guidance technology, in relation to military needs.

The Working Group decided early on to limit information in the report at the Unclassified level so as to ensure the widest circulation. Similarly, documentation of current capabilities has been confined to mainly qualitative description. The main thrust developed towards a more direct response to Nato's military needs and the prospects for meeting them.

1.2. Content of the Report

To set the scene for the analysis and discussion of terminal guidance technology advances that was the main thrust of the Working Group, Chapter 2 presents a background review of techniques and systems currently in use or under development. As in the rest of this report, and as expressed in the Working Group's declared objectives, the main focus is on seeker systems; however, the progress made in high accuracy GPS/INS made inclusion of non-seeker alternatives desirable.

Chapter 3 presents an analysis of military needs, mostly based on AGARD planning guidelines derived from the AASC analysis. The subject matter is related to recognised Nato Military Functions for which guided munitions are most relevant. Chapter 3 also discusses the significance of the Gulf War (particularly the analysis in ref. 1.1.) and other conflicts that Nato has been – or might be – involved in. It concludes with a statement of future needs expressed in terms of specific munition capabilities associated with precision terminal guidance.

The subsequent two chapters, constituting the core of this report, contain analysis and discussion of terminal guidance technology in relation to those needs. Chapter 4 is concerned with advances in contributory technologies, whilst Chapter 5 concentrates on operational factors. In addition to providing a survey which it is hoped will be of general value, the two chapters also provide a basis for Chapter 6, which contains speculative ideas for new capabilities that extend beyond the enhancement of existing capabilities.

The Working Group's conclusions and recommendations are presented in Chapter 7, under the following headings:

Potential to meet Nato Needs:

- **Technology Improvements** – summarising the analyses of Chapters 4 and 5 in relation to the specific military needs identified in Chapter 3, with an emphasis on the improvement of present Nato capabilities.
- **Future Capabilities** – stating the potential of munitions guidance technology for new or novel solutions such as: new types of warhead system; one-shot/one-kill small arms rounds; new types of munition; precision counterfire.

Nato Cooperation:

- **Standardization** – recommending a relatively modest but effective programme for a range of interchangeable munition components, plus international standards, protocols and tools.
- **Cooperative Approaches** – recommending the adoption of performance-related specifications and commercial practices in international munitions programmes.

Reference

- 1.1 AGARD Report R-806. Persian Gulf Technology Implications Assessment. AGARD Guidance and Control Panel, 1993.

CHAPTER 2. TERMINAL GUIDANCE SYSTEMS

This chapter surveys the field of terminal guidance and provides a setting for the analyses of military needs and guidance technology of later chapters. It concentrates mainly on the familiar forms of terminal guidance already in use or in advanced stages of development: more advanced systems and their implications for military operations are discussed in Chapters 4, 5 and 6.

2.1. Guidance Concepts

2.1.1. General

As stated in Chapter 1, the report's principal aim is to review the present and future potential of terminal guidance technology in relation to military needs. Munitions of all types are included, whether air or surface launched. Some familiarity with guidance and control terminology is assumed; though for completeness Appendix A provides a brief summary of the basic concepts.

Attention is focused primarily on seeker-based systems though command guidance and beam riding guidance need to be mentioned, since they find important weapon applications, particularly for short range infantry weapons and surface-launched air defence systems. Mid-course guidance also needs some discussion, since it interacts with terminal guidance and in many cases utilises common or similar components. For both midcourse and the final phases of flight, GPS/INS systems are also discussed.

2.1.2. Trajectory Phases

Figure 2.1 illustrates a typical guided munition trajectory (so far as any trajectory can be regarded as typical). The sequence of different trajectory phases is shown, including mission planning and pre-launch initialisation, as well as mid-course flight, target acquisition, terminal interception and warhead initiation.

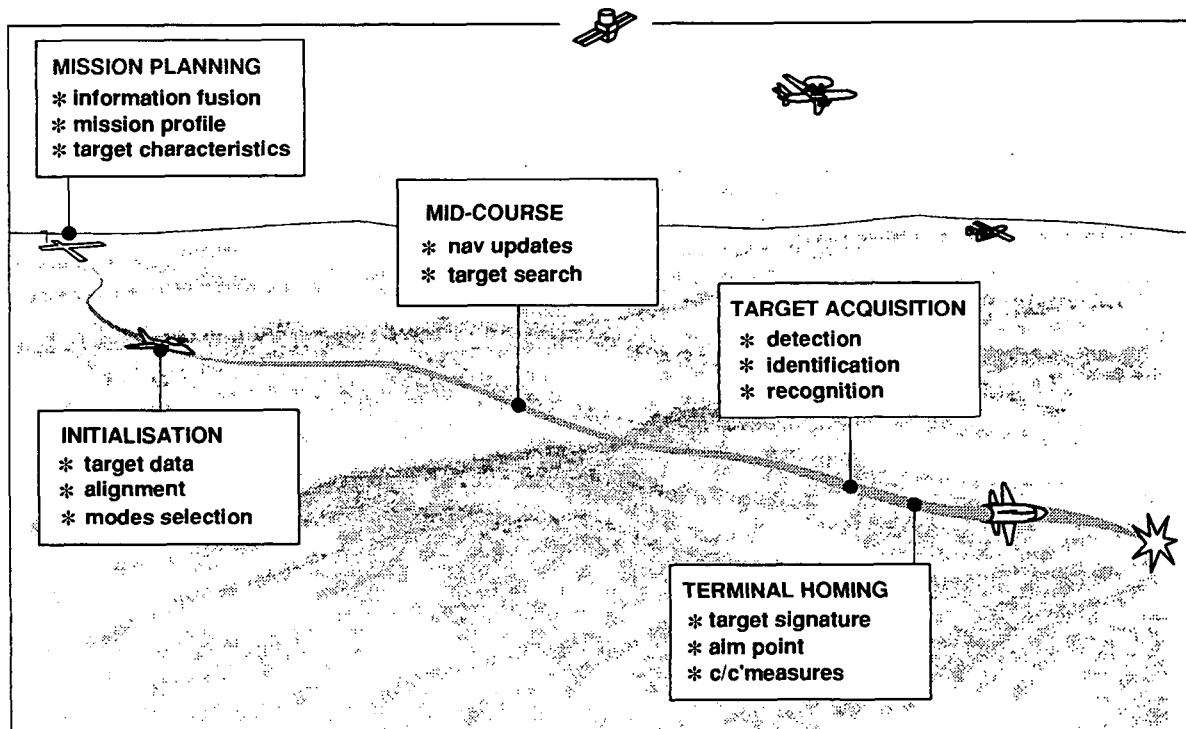

Figure 2.1. Guided Trajectory Phases

The example shown is an air-launched stand-off munition, chosen to emphasise the dependence of guided munitions on C³I and the large number of inputs that can go into the successful functioning of the terminal homing system. Guidance methods may vary greatly from that shown, though some basic concepts are common to most weapon system applications. In the case of direct fire systems, or some short-medium range indirect fire systems, initialisation may be no more than pointing and firing (or releasing) the munition. The mid-course – if the target has not already been acquired by the seeker before launch of the munition – may be merely an unguided ballistic path up to the point of target acquisition. Long range indirect fire munitions however can be critically dependent on the accuracy of the initialisation and mid-course guidance phases, which must be taken into consideration in examining the way a seeker functions. The following sections therefore review both seekers and mid-course guidance systems including, for the latter, consideration of non-seeker homing options.

2.1.3. Homing Guidance.

For the purposes of this report homing guidance is taken as synonymous with target tracking by an on-board seeker to generate control commands for target interception. Since the earliest homing munitions, considerable ingenuity has been shown in exploiting the electromagnetic spectrum in active, passive and semi-active modes, within the limits of sensor technology available. It is remarkable that some of those early systems were based on principles that have not changed significantly until recent years. Examples include: operator-in-the loop television guidance, first employed in World War Two and subsequently re-developed several times, though with the modern addition of auto-tracking; and the principle of proportional navigation which has been a feature of homing guidance since the earliest systems.

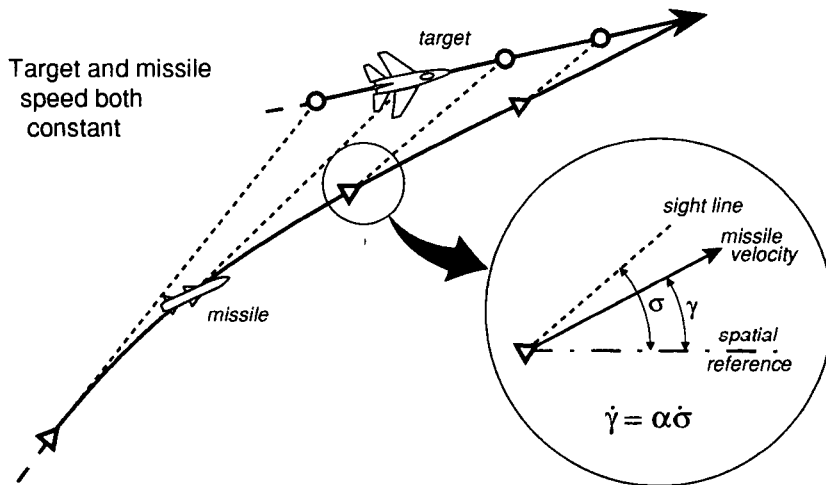

Figure 2.2 . Proportional Navigation

Figure 2.2 shows the basic principle of proportional navigation (PN). It is usually mechanised in missiles by expressing the required missile flight path turn rate, $\dot{\gamma}$ as lateral acceleration commands proportional to sight line angular rate, $\dot{\sigma}$ divided by closing speed. Variants include so-called augmented proportional navigation (APN) which aims to extend classical PN's assumption of constant speed by resolving all components of acceleration (including the target's if known) relative to the sight line. Proportional navigation remained the basis for most homing guidance in the forty years up to the 1980s; a reflection of the fact that until recently, for all but some strategic weapons, only analogue-based systems were affordable or small enough to be practical. This situation has changed dramatically in the last decade or so with the advent of powerful low-cost microprocessors. While some degree of trajectory shaping was

possible with the earlier analogue systems, for example the deliberate aim point biasing employed in later variants of the AIM-9 Sidewinder air-to-air missile, it is only with the advent of microprocessor-based guidance and control that radical departures in homing navigation principles have become possible. Later chapters will examine the implications for improving the capabilities of guided munitions by the use of optimum guidance laws aimed at maximising range, selecting aim point and/or direction of target interception, etc. At the other extreme, pursuit homing, in which the munition heads directly at the target throughout its trajectory, provides a simple alternative to proportional navigation which, though subject to wind drift error, is effective against stationary targets.

In the past, homing guidance systems were mainly associated with direct-fire munitions, due to the lack of lock-after-launch ability in earlier generations of target seeker. This situation has changed as a result of improved seekers, inertial sensors and digital data processing although, with the exception of very low-cost self-targeting submunitions of limited performance, autonomous seeker acquisition has been confined mainly to high value stand-off missiles. A much wider range of applications is now emerging as cost/performance of electronic components continues to fall – though software and system development costs need to be brought under control before the full benefits are realised. The implications and likelihood of a revolution in the use of guided munitions resulting from affordable processor-based guidance (including autonomous target detection and identification, aimpoint selection, programmable multi-mode operation, etc.) will be evident from later chapters.

2.1.4. Mid-Course Guidance

In lock-after-launch systems, target acquisition can be either non-autonomous (examples are: remote television guidance via data/command link, and semi-active laser guidance with third party target illumination) or autonomous (examples are: imaging infrared terminal guidance seeker, and medium/long range air-to-air active radar guidance). Mid-course and terminal guidance systems are necessarily interdependent and may or may not share common equipment in integrated guidance systems. The following examples illustrate some of the more common combinations of mid-course and terminal guidance and their application in weapon systems:

- Inertial mid-course combined with active radar terminal, as used in AMRAAM also includes command updating which permits extended range operation and freedom of trajectory optimisation while allowing for target evasive manoeuvre. For long range applications the combination of semi-active mid course with active terminal is also important.
- Passive imaging infrared terminal with autonomous target acquisition is used in ASRAAM. Common inertial sensors are employed for mid-course and terminal sensors in lock-after-launch modes to overcome lock-before-launch limitations of earlier generation SRAAM.
- Ballistic mid-course with autonomous target acquisition is common in anti-armour munitions, such as artillery rocket systems with homing sub-munitions, and guided mortar rounds (e.g. Merlin). They tend to rely on high terminal approach angles and easily discriminated target characteristics.
- Ballistic mid-course with semi-active terminal is used in Paveway guided bombs and AS-30. Typically launched from aircraft with target tracking and laser illumination equipment, they are also effective in conjunction with third-party illumination, including for example forward ground observers.

Until recent years mid-course guidance over long range posed severe problems of cost and accuracy. Precision inertial navigation systems are inherently expensive, although laser gyros, solid state sensors and strapdown configurations have reduced costs to a large extent. In addition, less expensive hybrid systems involving INS plus various combinations of terrain referenced navigation (whether by sensor comparison of stored terrain elevation data or terrain map features), have been introduced; though the use of pre-stored terrain elevation data imposes an additional burden of collecting the high-resolution digital data in areas of

potential conflict and on mission planning for the weapon and/or weapon carrier. A review of terrain referenced navigation based on elevation data is given in Appendix B.

Perhaps the most significant development however is likely to be the impact of the microprocessor-based terminal guidance systems referred to in the previous section, coupled with low cost precision miniature inertial sensors, in strapdown or semi-strapdown configurations. These developments make it possible to completely integrate the guidance and control system, with programmable or self-adaptive mode selection of mid-course and terminal phase functions. The beneficial impacts go well beyond avoidance of hardware duplication to the development of greater user flexibility and adaptability, with important operational implications.

The use of the Global Positioning System (GPS) for mid-course navigation offers world-wide, autonomous navigation when used in conjunction with an INS. In fact, the first weapons fired at the start of the Gulf War's air campaign were B-52-launched ALCMs in which the terrain matching navigation capability was removed and a GPS receiver installed in its place. However, because questions continue to be raised concerning the vulnerability of GPS receivers to selective jamming (whether in the midcourse or terminal phases) it is important to ensure that mission objectives can be met by the INS alone. GPS/INS alternatives are discussed in Chapter 4 and Appendix D.

2.1.5. Non-Seeker Alternatives

The most widely used form of non-seeker system is command guidance, typically command-to-line-of-sight (CLOS), together with variations designed to achieve greater lead angle. Among the most successful applications have been optically guided infantry anti-armour weapons and short-to-medium range air-defence systems, for example Rapier and Roland, which employ either electro-optical or radar tracking. The attractions of command guidance are obvious. The low cost and small size of command receivers, together with avoidance of seeker aerodynamic drag penalties, leads to small low-cost missiles of high kinematic performance, although infrared seekers for very short range SAM are also in wide use (e.g. Stinger, Mistral). Other categories of weapon, such as helicopter anti-armour missile systems, also make effective use of command guidance where target sensors and precision tracking are an integral part of the weapon platform, particularly at short range. For many classes of infantry weapon, such as LAW, the difficulty of achieving seekers of adequate performance at an affordable cost has tended to make them prohibitive. A hybrid form of command guidance, as used for example in the Patriot SAM system, utilizes a down link for on-the-ground processing of the output from the active radar terminal guidance seeker.

Beam riding guidance also finds continuing applications, particularly where – as for CLOS – small munition size makes a seeker impractical, for example Star Streak short range SAM. It is also used for mid-course guidance in some longer range air-defence systems.

The extent to which the development of high-performance low-cost seekers will alter the situation is uncertain because of the proven capability of present CLOS systems and the heavy investment in tracking and command equipments already made. However, the European TRIGAT long-range infantry/helicopter anti-armour missile currently under development utilises seeker-based homing guidance. For other applications, particularly air-defence, it seems unlikely that command guided munitions will disappear from the scene in the near future. In the longer term, the advantages of improved seeker-based systems, in terms of post-launch autonomy (or fire-and-forget) and longer range potential, will increase their appeal if cost, size and aerodynamic constraints can be overcome.

For stand-off munitions, although the problems of autonomous target acquisition can be severe, there are to date no autonomous weapons that have the capability to achieve precision terminal guidance accuracy without a terminal sensor. This is for two main reasons. The first is that target location error typically far exceeds that allowable for precision accuracy using self-contained navigation. The second is that autonomous weapon guidance and navigation system inaccuracy (or error growth) during the weapon flight time exceeds the on-target accuracy requirements. So these two limitations have effectively limited

autonomous weapon accuracy. In Chapter 4 on technology trends, it is suggested that improvements in the accuracy of the GPS system broadcasts, or the use of relative (or differential) GPS on board the weapon itself, may lead to major improvements in weapon navigation accuracy. In conjunction with new approaches to solving the relative targeting problem prior to weapon launch, this could yield terminal accuracies in the order of 3 metres against fixed targets without the use of a seeker on board the weapon.

2.2 Seeker Functions

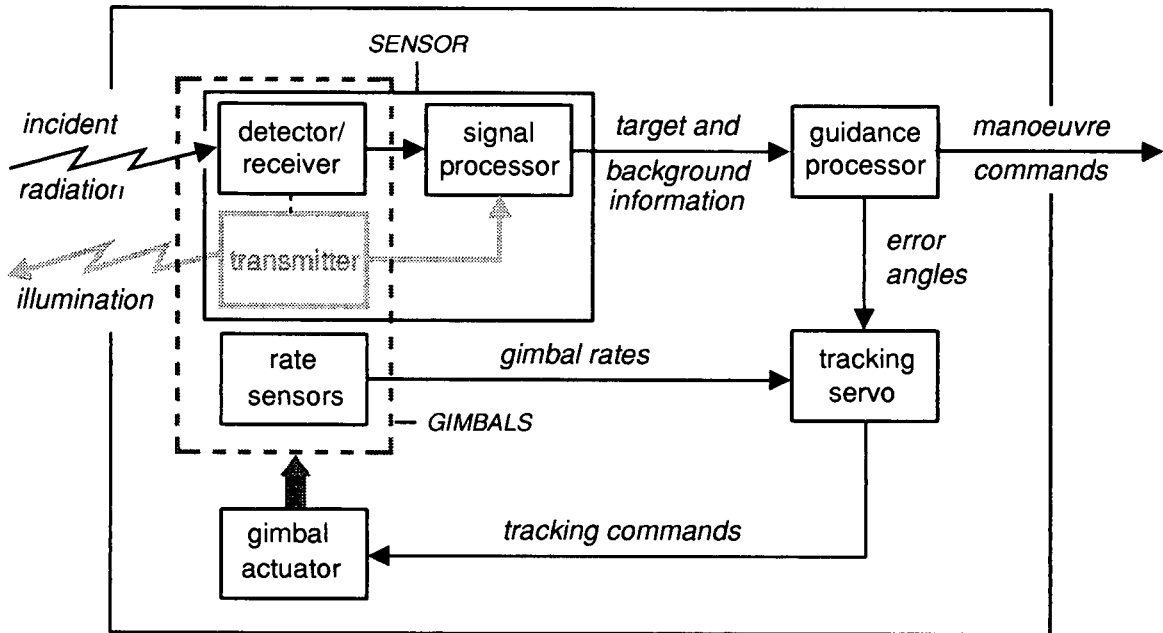

Figure 2.3. Seeker Functions

2.2.1 Modes of Operation

A typical functional scheme is shown in Figure 2.3, though hardware implementation can show considerable variation in detail. Note that, for the purposes of this report, the term "seeker" is taken to include all the signal and data processing associated with target search, acquisition and tracking. Seekers fall into one of three general categories, defined by their basic modes of operation. They are:

Passive: in which the seeker detects and tracks the target using only the energy reflected or radiated by the target itself without associated illumination (other than from natural sources such as the sun). High performance passive seekers in the visible and infrared bands tend to be sensitive to radiation from the target and background and need to process the received signals to discriminate the target. Other types of passive seeker operate simply as radiometers, sensitive only to the emissions of the target itself, whether infrared or millimetre wave thermal emissions, or radar emissions.

Operational advantages are: post-launch independence of the launch platform (except in the special case of operator-in-the-loop TV guidance), low detectability, and resistance to active countermeasures. The main disadvantage is the often low intensity level of the target emitted radiation which limits detection and acquisition range. Short range air-to-air and surface-to-air missiles, advanced anti-tank guided munitions, anti-radar missiles and anti-ship missiles, are typical applications.

Active: in which the seeker emits energy to "illuminate" the target, and receives the reflected energy to perform the homing process. Most seekers of this type use a radar transmitter/receiver operating in the millimetre or centimetre wavebands. Other examples of active seeker include laser radar types.

As in the case of passive seekers, independence of the launching platform is a major advantage, but in this case the possibility of detection is inherently greater, and in consequence counter-countermeasure (CCM) requirements are of special importance. Range is limited by emitter power, a function of size and weight allowable in the missile. Nevertheless, advances in microelectronics are leading to significant improvements in range and size and it is becoming one of the main terminal guidance systems for medium-to-long range air-to-air and surface-to-air systems. It is also commonly used in the terminal phase of antiship missiles.

Semiactive: In which the target is illuminated from a source external to the munition, such as the launch platform or by a third party source. This configuration is commonly used when emitter size is too great, due to range requirements or technological constraints, to permit its inclusion as part of the seeker, or to minimise cost.

Although many air-to-air and ground-to-air missiles utilise semiactive radar terminal guidance, it is being superseded by active systems because of the constraints semi-active operation imposes on the launch platform, though it can be expected to remain in use for midcourse guidance for extended range operation. It is also used in the helicopter-launched anti-ship missile, Sea Skua where size and weight are at a premium. Laser semiactive seekers find typical use in smart bombs or air-ground missiles, with either aircraft or ground-based target illuminators.

2.2.2. Spectral bands

Figure 2.4 overleaf shows atmospheric absorption of radiation in the electromagnetic spectrum, illustrating the available transmission bands commonly used for seekers. As well as operational range limitations from atmospheric absorption of signals, the choice of seeker frequency bands (or, for convenience, wavebands in the case of electro-optical seekers) are determined by practical considerations such as detector size, cost and availability. Angular resolution is also a major factor. The minimum size of object that can be instantaneously resolved by a detector at any given distance is roughly proportional to wavelength divided by the diameter of the receiver aperture, as determined by the theoretical diffraction limit for electromagnetic radiation and the detail design of the receiver. In practice, seeker design always involves some compromise between conflicting factors, as the following categories of seeker indicate, in order of increasing wavelength:

Television Seekers

Operating in the visible band of around $0.6\mu\text{m}$ wavelength, the main advantage of TV seekers is their very high optical resolution plus the mature and readily available technology of silicon array detectors which have replaced earlier vidicon detectors. In conjunction with auto-tracking algorithms and operator designation, TV guidance is employed in direct-fire and indirect-fire applications. In stand-off munitions it is capable of extremely high accuracy together with positive target identification by the operator, at the cost of a data/command link plus associated tracking transmitter/receiver, and constraints on the launch platform. It is also subject to degradation by mist, fog, smoke, and in very low light conditions.

Laser Seekers

Laser seekers are in widespread use in semi-active laser-guided munitions. The seekers in current general use typically employ very low cost quadrant silicon detectors which track targets illuminated by pulsed NdYaG lasers operating at $1.06\mu\text{m}$ wavelength. Laser-guidance add-ons to conventional 500–2000 lb bombs, as in the Paveway series, can be very cost-effective. Like TV guidance its effectiveness is degraded

by mist, fog and smoke. A recent development is laser radar (or lidar) operating at 10.6 μ m wavelength for high resolution active laser seekers: this is discussed further in Chapter 4.

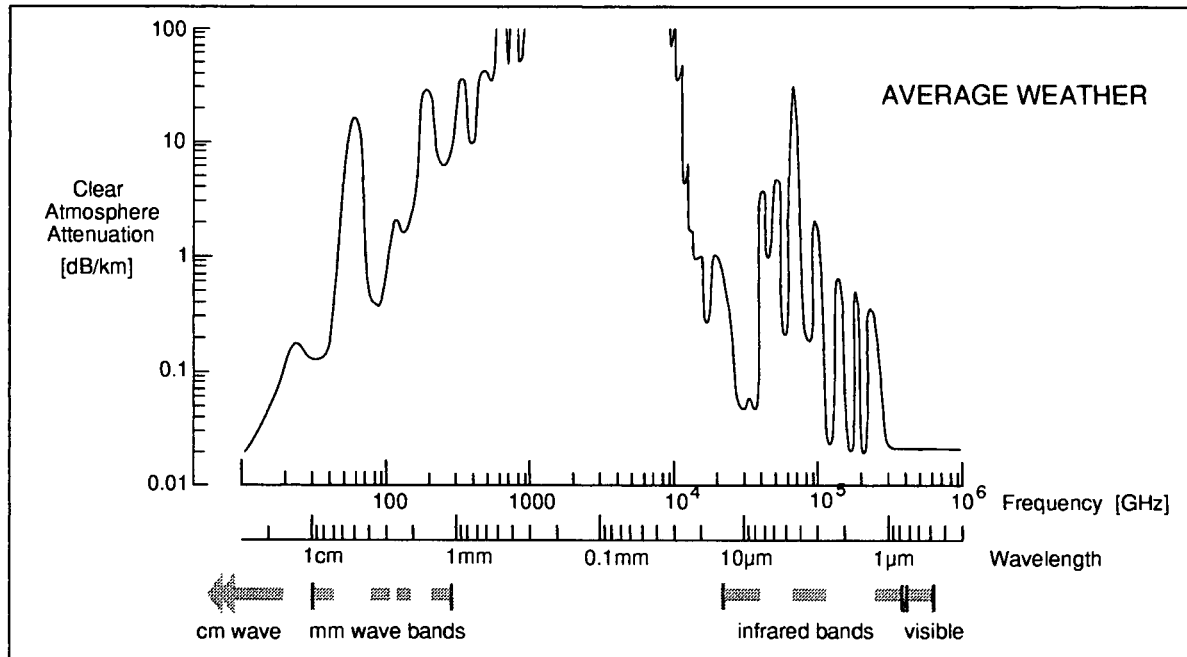

Figure 2.4. Atmospheric Attenuation

Infrared Seekers

One of the earliest and most commonly used categories, IR seekers are now represented by a wide variety of different types. Generally they fall into two distinct classes: hot spot trackers (or heat seekers) and imaging infrared (I²R) systems. The earliest air-to-air heat seeking missiles, using uncooled PbS detectors in the short (1-3 μ m) waveband, were limited to tail attack. The development of cryogenic detectors operating in the medium (3-5 μ m) waveband greatly improved the sensitivity of heat-seekers but against head-on targets their maximum range is still restricted, though in the short range role, they are an effective complement to medium range radar AAM. I²R seekers operating in the long (8-12 μ m) waveband are used in subsonic anti-tank munitions where long waveband IR dome temperature limitations do not apply, but new types of highly sensitive medium-band staring array detector are also facilitating the use of I²R for high performance AAM and SAM. The high accuracy and compactness of infrared seekers has to be set against their sensitivity to mist and fog.

Millimetre Wave Radar Seekers

Seekers in the MMW radar bands (around 35 and 95 GHz frequency) have found applications principally in short range anti-tank munitions. They include passive and active types. Passive MMW seekers, using simple radiometers to detect target thermal radiation relative to background, are extremely limited in range but can be effective in smart submunitions. Most MMW seekers however operate in the active mode. The relatively short wavelengths (less than one centimetre, hence their designation) enable small antennas to achieve narrow beamwidth and relatively high resolution, making them particularly suitable for small munitions. Though not capable of the high resolution of IR seekers, they have advantages where visibility is poor due to smoke and fog. Monolithic array MMW passive detectors with imaging capability and improved angular resolution, have been developed but have so far not found an application. The use of

MMW radar at longer range tends to be limited by its greater atmospheric attenuation compared with centimetre wave radar (CMW).

Centimetre Wave Radar Seekers

CMW radar originated in the late 1930s for ground and ship air defence, and in the early 1940s for airborne applications, but it was not until the 1950s that miniature receivers were developed to fit into munitions. Semi-active seekers, with continuous wave (CW) target illumination at J band frequencies (10-20 GHz) were used in first generation medium range AAM and SAM, where the relatively large antennae necessary for acceptable beamwidth and sensitivity were compatible with the size of vehicle required to achieve the desired range. Active radar seekers, with their bigger and heavier transmitters, were restricted to large long-range AAM and anti-ship missiles until the development of miniature high-power devices which has led to more compact medium-range pulse Doppler active radar AAM replacing semi-active systems. The greatest disadvantage of active and semi-active radar seekers, apart from their size, is their sensitivity to countermeasures resulting from target ESM awareness of illumination, although this may be countered by more complex spread spectrum transmitters/receivers.

Broad-band passive CMW radar seekers are used in anti-radar munitions (ARM) as a counter to air-defence systems. They have the lower detectivity advantage of other passive systems, but face severe technical problems in the design of sensitive wideband receivers and fast target discrimination capability in an often congested electromagnetic environment.

Acoustic Seekers

In an altogether different class from the foregoing electromagnetic seekers, acoustic seekers have the considerable advantage of relatively simple microphonic detectors and audio-frequency signal processing. The disadvantages, which have inhibited their widespread use, are the difficulty of separating target signature (e.g. the characteristic sound of a tracked vehicle) from aerodynamic noise, and low precision with anything other than large detector arrays. Nevertheless, for low speed munitions, particularly in conjunction with other forms of terminal seeker, acoustic seekers can be effective and would be particularly appropriate to anti-armour UAV.

Multi-Spectral Seekers

The limitations and compromises involved in operating in a single spectral band has led to the development of seekers with a detector (or multiple detectors) responding to signals in more than one band. Although multiple bandpass filters have been used in the medium IR band to enhance discrimination of signal from background radiation and countermeasures, other types of seeker operate in two or more completely separate bands. For example, anti-tank munitions can usefully employ IR detectors for terminal accuracy and discrimination, combined with MMW detectors for longer range target acquisition in poor weather. Short range IR SAM have also employed additional discrimination of the negative ultraviolet (UV) signature of the target against the sky's background radiation.

2.2.3. Tracking and Homing Processes

The mechanisation of homing navigation processes requires the seeker to track the target and, by measuring sightline angular motion, to generate manoeuvre commands to eliminate homing errors, as in the idealised illustration of Figure 2.3. Advanced guidance systems may depart from simple proportional navigation but the target tracking function is fundamental, as also are measurement or estimation of range rate, and aim point considerations.

Sightline Stabilisation

The classical form of target tracking is achieved by mounting the detector (e.g. infrared telescope or radar

antenna) plus inertial rate sensors on a set of gimbals which are driven by a servomechanism with angular error input from the detector and stabilisation feedback from the rate sensors, which together provide the basis for determination of sight line angular motion. The configuration is inherently expensive, although designs such as the elegant gyro-stabilised AIM-9 Sidewinder seeker with optical transfer to a non-gimballed detector, have succeeded in reducing cost by integrating the different components, at the expense of inherent restrictions on maximum sightline tracking rate. Alternative semi-strapdown schemes dispense with gimbal-mounted rate sensors by estimating sightline angular rate from the difference between rotational velocity of the gimbals and body-mounted rate sensor measurements which can also be utilised for vehicle stabilisation feedback: however this approach makes great demands on the rate sensors to achieve the required measurement accuracy over a wide dynamic range.

Fully strapdown seekers go a stage further by eliminating the gimbals altogether. They are either restricted to direct-fire munitions and near-stationary targets which have a limited off-axis look angle requirement, or need detectors with a very wide field of view. The latter is readily achieved with CMW radar seekers, at the expense of either sensitivity (with conventional monopulse receivers) or high cost (with phased array detectors), but fully strapdown seekers have found application in anti-radar missiles where a wide search beamwidth is necessary anyway because of the difficulties of simultaneously combining wide-band frequency search with spatial search by a scanning antenna.

The extremely simple aerostable seeker configuration relies on "weathervane" aerodynamic stabilisation with pursuit homing guidance. This configuration, in conjunction with a semi-active laser receiver, is a low-cost solution typically used in laser-guided bombs against stationary targets.

Range-Rate Determination

In practice, the mechanisation of proportional navigation or its derivatives in terms of generating lateral acceleration manoeuvre commands requires a knowledge of closing speed (or range rate). In active or semi-active radar seekers Doppler measurement usually provides a straightforward solution but for passive radar and electro-optical seekers (other than the special case of ladar seekers, which are reviewed in Chapter 4) closing speed must be estimated. Against stationary targets, this can be determined from missile speed, estimated by pre-launch initialisation plus integration of three-axis accelerometer measurements, by pre-launch prediction and scheduling or, if the variation of terminal velocity is not too great, by assuming a constant value. Fortunately, proportional navigation can tolerate wide gain variations without incurring either unacceptable degradation of miss distance due to too low a gain, or instability (hunting) due to too high a gain.

Evasive manoeuvre by the target during end-game interception can also generate significant variation in range rate. Anti-aircraft missiles do not generally need to compensate for this effect provided the ratio of missile speed to target speed is high enough to minimise the spread of closing speed. However, engagement envelopes can be usefully extended by target manoeuvre estimation, which allows minimum missile speed at the limit of range to fall to levels where homing accuracy would otherwise be degraded. Advanced microprocessor-based guidance systems with imaging detectors, employing optimising state estimation techniques, provide a basis for determining the effects of target manoeuvre and the appropriate response.

Anti-missile applications, where very large variations of closing speed can occur, pose more severe problems for passive seekers. In this case the system usually depends on prior estimation of target velocity from surveillance and tracking systems. Continuous on-board estimation by the seeker of time to intercept is another possibility, in conjunction with other forms of guidance law than pure proportional navigation. There are also other reasons than homing guidance for measuring or estimating distance to intercept, for example as an enabling input to the warhead and fusing system. Time to intercept (though not relative velocity) can in principle be based on comparison of signal strength variation at successive time intervals or, for imaging systems, comparison of apparent target image size in successive frames.

Aim Point Determination

For large targets, or targets which are large relative to the effective radius of the warhead, the actual point of impact or nearest miss is important in achieving the required lethality. Short range heat seeking AAM for example, approaching an aircraft target from a beam-on aspect, will tend to aim for the jet engine's exhaust plume, especially if its afterburner is engaged. With hot-spot-tracking IR seekers the problem can be alleviated by lead biasing, in which the intercept lead angle, as indicated by gimbal angle measurement, is used to generate a bias input to the proportional navigation loop in order to induce a forward displacement of intercept point. The technique, although approximate, is effective, but with more advanced forms of imaging seeker it is possible to accurately determine the target image centroid and indeed to select a preferred vulnerable aim point.

In the case of radar guidance, the aim point is determined by the centroid of reflected energy, which is influenced by glint (apparent random displacement of aim point due to fluctuations in relative strength of the distributed sources of reflection which make up the complete target signature), the amplitude of which can exceed the target's dimensions. Frequency agile seekers can reduce the effects of glint by frequency hopping because the apparent displacement of the target echo is a function of frequency. Nevertheless, the terminal accuracy of CMW radar seekers is inherently less than that of electro-optical seekers and generally implies a larger warhead, so they continue to find applications mainly in larger medium-long range munitions. MMW radar seekers, with their low glint amplitudes, can achieve a direct hit capability, which enables them to be effective in direct-hit anti-tank munitions with shaped charge warheads.

2.3. Target Characteristics

2.3.1. Target Signatures

For a seeker to discriminate between its intended target and the background environment it must be sensitive to the features which make the target unique. For example, an aircraft with the same radar reflecting area as a car is differentiated by speed, or an armoured tank is much heavier than a truck of equal size and has a characteristic shape and sound.

Radar cross section (RCS) is the major determining factor of target signature for the performance of radar seekers. The strength of target reflections is strongly dependent on aspect, an aircraft's RCS being very much larger when viewed beam-on compared to head-on and varying in an apparently random fashion with small change of aspect angle. Multiple radar targets, for example aircraft flying in formation, present a problem when the group of targets fall within the seeker's antenna beamwidth, a situation which may persist until the munition has closed to very short range. Doppler discrimination with very narrow velocity gates is needed in this situation. Radar reflections are also subject to glint and other noise which can affect seeker acquisition of the target. Radar signature reduction of manned aircraft has been a major thrust in recent years. RCS has been reduced by the use of radar absorbing materials and, more drastically, by major change in the shape of aircraft (or missiles - see section 2.3.4) to reflect energy away from the receiver. The operational advantages of "stealthy" aircraft are regarded as well worth the aerodynamic compromise and additional cost.

Infrared signature reduction has also been a major feature of stealth aircraft, in the form of carefully located and shaped intakes with the use of radar absorbing linings, plus jet engines of high bypass ratio and high non-afterburning power-to-weight ratio such as the F-22. Minimum-reflecting surface finishes also avoid high infrared emissivity and can be matched to the expected background radiation at the aircraft's design operating condition.

The age old art of camouflage is the most obvious form of visible signature reduction, aimed at making the target look as much like its natural background as possible. Other means for reducing the contrast between target and background, and therefore seeker acquisition range, include minimum-reflecting paint finishes or even active illumination of aircraft to match the measured background illumination levels.

Acoustic detection of tanks and other tracked vehicles depends on the characteristic clanking sound of their tracks. Other vehicles have similarly distinctive acoustic signatures, such as aircraft jet engine noise, including recognizable compressor rotational speed and blade count. Acoustic signatures can be reduced by improved mechanical efficiencies or acoustic barriers. They can also be masked by natural or artificial noise in the same frequency range.

Many other kinds of target signature may be exploited by new types of seeker, leading to corresponding protective efforts to reduce the signature. By reducing target signature, other measures to confuse or distract the seeker will generally become more effective. Signature reduction and countermeasures should therefore be regarded as complementary, and treated accordingly in the design of seekers.

2.3.2. Effect of Countermeasures

The countermeasures (CM) and counter-countermeasures (CCM) of interest in relation to guidance seekers are surveyed in Appendix C, including active and semi-active CMW radar, MMW radar, passive infrared, and semi-active laser guidance. The following is a brief review of some of the most commonly employed CM. More sophisticated techniques, including those specifically designed to overcome seeker counter-countermeasures, are beyond the scope of this chapter though Chapter 4's treatment of advances in seeker technology covers CCM development.

A variety of countermeasures that a guidance seeker might need to counter are listed in Appendix C. Radar CM employ a wide spectrum of noise and deception jamming techniques, plus decoys which can range from simple chaff to elaborate powered and unpowered off-board projectiles complete with sophisticated jammers of their own. Electro-optical CM are generally less sophisticated than radar CM: at the simplest they may just be smoke generators, camouflage or other rudimentary forms of concealment, or decoy flares; though modulated jammers for use against scanning single-element IR seekers, have been developed. Directed energy weapons such as high power microwaves and lasers are potentially effective CM, though they require elaborate surveillance and detection systems and, particularly for lasers, very accurate tracking and location close to the aim point of the seeker, all of which will tend to limit their use.

Electronic warfare is a never-ending process of action and reaction and it is a truism that any CM can be countered by an equivalent CCM. The problem, for both sides, is the escalation of complexity and expense. For seekers, this has led to the adoption of such CCM as frequency-agile radar and two-colour IR systems, with associated cost increases. Future seekers will increasingly be forced to adopt more elaborate designs, including spread spectrum radar, the much greater use of imaging sensors than at present, and multi-spectral seekers involving two or more widely spaced bands (e.g. CMW+MMW or CMW+HIR). The main issue will therefore be to develop such systems at affordable cost. Multi-spectral seekers can however be justified on the grounds of improved accuracy (which reduces – or even eliminates – warhead requirements, and so yields a balancing reduction in munition size) and/or simplification of each waveband element.

2.4. Seeker Programmes

Examples of seekers in use, plus some of those under development and in advanced research programmes, are listed in Table 2.1. The fact that so many different seekers have been – or are being – developed may be regarded as evidence of the special needs of each category of munition (ASM, AAM, etc.), though it may be questioned whether every munition in that category needs a seeker specially designed for it. With few exceptions, munition development programmes have generally involved a completely new associated seeker R&D programme. This has sometimes led to wasteful duplication and higher costs than necessary. The costs have generally been accepted as an essential condition for technological advance, particularly in the past where analogue systems have necessarily been finely tuned to the seeker's operating conditions. Newly available technologies, such as those discussed in the following chapters, demand a reconsideration.

Duplication of effort is most apparent between the different Nato nations' munitions programmes; several initiatives having been directed towards overcoming the problem by collaborative R&D programmes. The European TRIGAT programme for an advanced anti-armour munition is a case in point. Too often however, such programmes have foundered because of differing military needs, whether of performance, cost or timescale. One way to overcome this difficulty might be the use of international and interchangeable subsystems in national munitions programmes. To some extent this already happens, particularly where international competitive tendering is followed, as for example in the current ASRAAM R&D programme which ignores national work sharing restrictions and whose seeker development involves a US contractor for the sensor and a UK contractor for the processor.

National activities have included numerous advanced research and demonstrator programmes, as well as full scale development. The USAF ACGW (Autonomous Guidance for Conventional Munitions) to demonstrate autonomous acquisition of fixed high-value targets is a good example of the application of high speed data processing in combination with advanced IIR focal plane arrays. Other USAF demonstrator programmes include the various ladar seekers, e.g. ATLAS and LOCAAS (Low Cost Anti-Armor Seeker), ASARG (Advanced Synthetic Aperture Radar Guidance), and MSAAS (Multi-Spectral Air-to-Air Seeker). US Army programmes include TACAWS, a precision seeker for anti-tank and helicopter targets, and ADKEM (ADvanced Kinetic Energy Missile) MMW seeker. The US Navy's advanced seeker demonstrators include a strapdown seeker for medium range AAM application, MMW Passive Imaging Radiometer Seeker, Semi-Strapdown Seeker and the ERSE (Electromagnetic Radiating Source Elimination) passive anti-radiation seeker with active terminal.

European research/demonstrator and development programmes include several activities aimed at low-cost seekers for guided anti-armour munitions, for example the BUSSARD, SMAT, SMart 155, and AEPM programmes, plus the cooperative TRIGAT (TRI-national Guided Anti-Tank) programme. Multi-spectral seeker research/demonstrator programmes include LW-IIR/MMW and MW-IIR/MMW activities. Current development programmes for low-cost anti-armour munitions include the Merlin MMW radar guided 80mm mortar round. ASRAAM development is centred on a seeker with autonomous acquisition, and the Apache stand-off weapon programme also includes future development of autonomous target acquisition capability. A number of medium range AAM programmes include advanced active radar seekers (Mica, Aspide, and Active Sky Flash).

The challenge with all advanced research/demonstrator programmes is to translate successful technology demonstration into fully-qualified Service-standard hardware. Since present full-scale development processes involve setting up quantity production facilities and proving them by test and evaluation, it might be advantageous to rethink the relation between concept research and development processes, either by greater utilisation of proven components in the research phases, by extending them to include a greater attention to production processes, by utilising existing qualified equipments in new systems, or by streamlining the design/development process. Some of these ideas are elaborated in Chapter 5.

Table 2.1. Nato Seeker Programmes

MUNITION/SEEKER	TYPE	STATUS	APPLICATION
Paveway	1.06µm semi-active	US In-Service	ASM (fixed land/sea targets)
TV Maverick	Visible	US In-Service	ASM (fixed/mobile land targets)
IR Maverick	Long wave IIR	US In-Service	ASM (fixed/mobile land targets)
HAVE NAP	Visible	US R&D	ASM (fixed land/sea targets)
HAVE NAP	Long wave IIR	US R&D	ASM (fixed land/sea targets)
AGCW	Long wave IIR	US research	ASM (fixed land/sea targets)
ATLAS LADAR	CO2 FMCW	US R&D	ASM (fixed land targets)
ATLAS LADAR	Solid state pulse	US R&D	ASM (fixed land targets)
LOCAAS LADAR	Solid state pulse	US research	ASM (mobile land targets)
LOCAAS MMW	94 GHz real beam	US research	ASM (mobile land targets)
ASARG	35 GHz SAR	US research	ASM (fixed land targets)
ASARG	Ku band SAR	US research	ASM (fixed land targets)
MMW Maverick	35 GHz real beam	US R&D	ASM (mobile land targets)
MMW Maverick	95 GHz real beam	US R&D	ASM (mobile land targets)
Dual Mode	IR/MMW	US research	ASM (mobile land targets)
AMRAAM	X band	US In-Service	AAM
HARM	Passive EM	US In-Service	ASM (anti-radiation)
Sidewinder	Medium band IR	US In-Service	AAM
MSAAS	Active/Passive RF	US research	AAM
Ultraseek	UV	US research	Space
AIMS	two-colour HgCdTe	US research	Space
TACAWS	IR	US R&D	SSM/SAM
ADKEM	Active MMW	US R&D	helicopter ASM/AAM
Longbow	Active MMW	US In-Service	helicopter ASM/AAM
Javelin	Long wave IIR	US R&D	helicopter ASM
Hawk	Semi-active CMW	US In-Service	SAM
Patriot	Semi-active CMW	US In-Service	SAM
Stinger	Short wave IR	US In-Service	SAM
Advanced Seeker	Active CMW	US research	AAM/SAM
MMW Imaging	35 Ghz radiometer	US research	ASM (fixed land targets)
Semi-Strapdown Seeker	Medium wave IR	US research	SAM
ERSE	K band anti-radiation	US research	ASM (mobile SAM targets)
Magic	Medium wave IR	Fr In-Service	AAM
Mistral	Medium wave IR	Fr In-Service	SAM (incl helicopter)
AS 30 Laser	1.06µm semi-active	Fr In-Service	ASM (fixed land/sea targets)
S 530 D	Semi-active CMW	Fr In-Service	AAM
Exocet	Active CMW	Fr In-Service	SSM (anti-ship)
ARMAT	Passive EM	Fr In-Service	ASM (anti-radiation)
Mica IR	Medium wave IR	Fr R&D	AAM
Mica EM	Active CMW	Fr R&D	AAM
Aster	Active CMW	Fr R&D	SAM
Apache	Active MMW	Fr R&D	ASM (fixed/mobile land targets)
Bimode Anti-Radar	IR/passive EM	Fr research	ASM (anti-radiation)
Bimode Anti-Cible Terrestre	Medium IR/MMW	Fr research	ASM (fixed/mobile land targets)
Bimode Actif/Passif IR	Active 1.06µm/med IR	Fr research	AAM
STAR	Passive EM	Fr research	ASM (anti-radiation)
AD Multifaisseau	Active array CMW	Fr research	SAM/SSM
AIM-9i	Medium wave IR	Ge In-Service	AAM
AIM-9 Juli	Medium wave IR	Ge In-Service	AAM
IRIS	Medium wave IIR	Ge R&D	AAM/SAM

Table 2.1. (continued)

Bussard	1.06µm semi-active	Ge research	SSM (anti-armour)
EPHAG/WBSK	Long wave IR	Ge research	AAM/SAM (helicopter targets)
SMAT/IRSS	long wave IIR	Ge research	ASM/SSM (anti-armour)
MSS	IIR/MMW	Ge research	ASM/SSM (anti-armour)
Sprint	IIR/passive EM	Ge research	ASM (anti-radiation)
ASTRID	IIR/MMW	Ge research	ASM (fixed/mobile land targets)
SMart 155	IR/MMW	Ge research	SSM (anti-armour)
AEPM	Active MMW	Ge research	SSM (anti-armour)
Aspide	Semi-active CMW	It In-Service	AAM/SAM
Penguin	Long wave IIR	No In-Service	SSM (anti-ship)
ALARM	Passive EM	UK In-Service	ASM (anti-radiation)
Sky Flash	Semi-active CMW	UK In-Service	AAM
Sea Eagle	Active CMW	UK In-Service	ASM (anti-ship)
Sea Skua	Semi-active CMW	UK In-Service	ASM (anti-ship)
ASRAAM	Medium wave IIR	UK R&D	AAM
Active Sky Flash	Active CMW	UK R&D	AAM
Merlin	Active MMW	UK R&D	SSM (anti-tank mortar)
Multi-Spectral Seeker	Long wave IIR/MMW	UK research	ASM (land/sea targets)
Uncooled Imaging Seeker	Long wave IIR	UK research	ASM (land/sea targets)
MMW Research	Active MMW	UK research	SSM (anti-armour)
Snark Strapdown	1.06µm semi-active	UK research	ASM (fixed land/sea targets)
IEPG TA-11	Long wave IIR	UK research	ASM (land/sea targets)
DASH	IIR/passive EM	UK research	ASM (anti-radiation)
TRIGAT	Long wave IIR	Coop R&D	SSM/ASM (anti-armour)

CHAPTER 3. MILITARY NEEDS

This chapter reviews Nato's needs for guided munitions in the light of the changing geopolitical situation of the last few years. It is based on the views and perspectives of the authors and does not claim to represent the policy of Nato or its agencies.

3.1. Nato Strategic Needs

3.1.1 General View

This examination of Nato's strategic needs takes as its starting point the major reviews in strategic thinking that took place after the dissolution of the Warsaw Pact. Nato's response to the altered situation in Europe at the end of the 1980's was a new Strategic Concept, formulated in 1991, which has led to major changes in its approach to defence planning. Corresponding changes in military equipment needs, including those for precision guided munitions, can be expected to follow, in line with the changing military demands now being made.

In general, the future technology needs of Nato are likely to be determined by its new emphasis on rapid reaction forces, augmentation forces and "out of area" operations. In addition, increased pressure on national defence budgets is generating even greater demands for efficiency and value for money in weapons procurement and use. The main thrusts therefore, so far as the impact on future guided munitions is concerned, will be towards improvements in mobility, affordability, effectiveness and adaptability.

Among other influences that must also be considered is an understandable pressure in Western nations to minimise the numbers of combatants involved in military operations and the risks they run. At the same time it is essential to maintain or improve upon the capabilities of Nato forces to deal quickly and effectively with any new threats that may arise, possibly in uncertain circumstances. These conflicting factors could reinforce the trend towards "arm's length" operations with autonomous and/or stand-off weapons. However, there need to be major improvements in methods for identifying potential targets (either by reconnaissance or by the weapons themselves) to ensure discrimination of friendly forces from enemy forces and non-combatants, and the weapons need to be made much more affordable than at present. Nato's formal statements of technological needs are discussed in the following paragraphs.

3.1.2. Major Nato Commanders Guidance for Defence Planning

The analysis of the implications for PGM technology that follows is based on the Nato Defence Planning guidance provided by SACLANT, CINCHAN and SACEUR which in turn reflects changes in the Alliance Strategic Concept. The guidance on planning priorities is expressed in terms of technology trends and key shortfalls in Nato capabilities, related to specific military functions. From the point of view of Precision Guided Munitions technology, the most relevant military functions (that is, those on which PGM technology might be expected to have a significant bearing) are: Interdiction; Land Combat Operations; Air Defence Operations; Offensive Air Operations; Maritime Surface operations; Amphibious Warfare; and Peace Support Operations.

3.1.3. AGARD Analysis - Strategy to Technology Linkage

As an adjunct to the new Nato Guidance for Defence Planning, the Aerospace Applications Studies Committee (AASC) of AGARD has analysed the linkage of technology to military needs as an aid to planning AGARD's future programmes. The primary aim was to assist the AGARD specialist panels in responding through their technical programmes to the military needs of Nato but it has also been a significant factor in the ongoing review of AGARD's organization and responsiveness.

The AASC analysis identifies specific aerospace technology developments in terms which can be related to the scientific and technological communities from which the AGARD membership is primarily drawn, whilst following a consistent top-down view based on Nato's policy documents as shown in figure 3.1. The principal findings of the AASC's study are expressed as aerospace system improvements and technology needs related to: Mobility; Flexibility; Rapid Augmentation Capability; Improved Situational Awareness; Improved Training Techniques; Reduced Environmental Impact; and Improved Affordability.

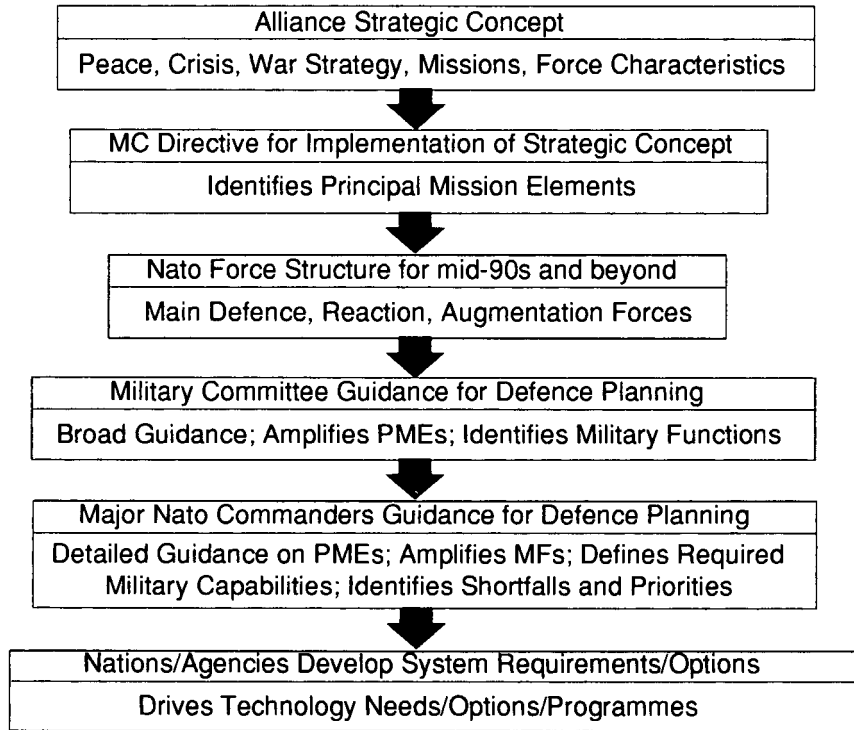

Figure 3.1. Nato Strategy to Technology Linkage

Figure 3.2 overleaf presents a PGM perspective of the technological needs identified by the AASC that are directly relevant to PGM. In addition, a number of indirect benefits that might be obtained from improvements in PGM technology, particularly guidance technology, have been included. The significant weapon requirements highlighted by the AASC analysis are:

Improved weapon effectiveness, bearing in mind that the single shot effectiveness of guided munitions in the field is often less than 50%. Some of this may be due to test and evaluation limitations, but difficulty of use is also a major factor. Improvements in the operator interface will not only reduce training needs but also improve effectiveness.

Improved stand-off weapons to overcome the limitations of present systems, particularly in terms of their cost and their capabilities in poor weather and against mobile targets. A further major factor restricting the use of SOW is the need for positive target identification: a limitation that calls for major advances in machine intelligence for automatic target detection and recognition, and the possible extension of IFF to guided munitions.

Multiple target capability and the ability to attack different types of target would enhance the flexibility of air operations considerably. It demands adaptable munitions as well as crew aids for target recognition, designation and handoff, plus improved aircraft:weapon interfaces.

Improved affordability throughout the life cycle from R&D through to operational use and upgrades. The pattern of Nato weapons acquisition, involving lengthy Research and Development, Test, and Evaluation phases, is designed to ensure a well proven product at the end but is inimical to the rapid introduction of advanced and lower cost technologies. It also militates against the development of truly adaptable systems, since the system is geared to the development of specific systems against individual military requirements. Alternative approaches, such as rolling R&D programmes with quick spin-off as needed, ought to be considered if the key R&D elements could be identified.

The implications for R&D, as outlined in the AASC analysis, are addressed in paragraph 3.3.

NEEDS	
Direct PGM Relevance	Potential PGM Capabilities
MOBILITY Lighter, more effective weapons	Global stand-off (alternative to platform mobility)
FLEXIBILITY More precise, night/all weather stand off weapons for mobile and fixed targets Multiple Target/target type engagement capability	
RAPID AUGMENTATION CAPABILITY User-friendly systems and concepts for augmentees Extended shelf life	
IMPROVED SITUATIONAL AWARENESS Improved IFF, both ground and air (incl weapons)	High-resolution sensors/weapons with communications net
IMPROVED TRAINING TECHNIQUES Improved man/machine interface on weapons	
REDUCED ENVIRONMENTAL IMPACT	Miniature precision weapons
IMPROVED AFFORDABILITY Improved producibility, reliability, maintainability, dual-use	

Figure 3.2. AASC - Implied System Improvements and Technology Needs

3.2. Operational Experience

3.2.1. Significance of Recent Nato Operations

To appreciate the significance of the changes confronting the Alliance it is only necessary to consider the experiences of the last few years. Recent military history has been characterised by a succession of localised conflicts which have pointed up the difficulties that Nato member nations face, whether in dealing with threats (direct or indirect) to their interests or in peace-keeping missions in support of the United Nations. The first point to note is that, with the notable exception of ex-Yugoslavia, these have tended to occur outside the traditional Western/Central European area of concern. Mobility of forces has therefore been a major factor; not least in the Persian Gulf War of 1990-91. Even more than in previous conventional wars, the task of moving materiel and personnel substantially exceeded in size and duration the actual combat. Secondly, the limitations of military support to UN peace-keeping initiatives have also been amply demonstrated in civil wars as diverse in character as Somalia and ex-Yugoslavia. If peace does not already exist, there often seems to be little that "peace-keeping" forces can do except ameliorate the worst effects on uninvolved civilians.

The third striking feature of recent experience has been the extent and scale of public media attention. Nothing in past war reporting compares with the nightly Western television broadcasts made direct from Baghdad while UN forces attacked military targets. The targets were often located (deliberately or by chance) close to civilian populations and other sensitive installations, with understandable public reaction to the inevitable collateral damage to non-combatants; not to mention the equally inevitable and distressing casualties from accidental "friendly fire" on Nato's own forces, however few these might have been.

Finally, there has been a trend towards the proliferation of advanced weapons in the Third World; in part resulting from past deliveries to former Cold-War client states but, increasingly, from the development of indigenous arms industries. The probable result will be an increase in the number, quality and unpredictability of newly-appearing threats to world peace. All these factors contribute to the need for improved mobility, capability and adaptability of Nato forces and their equipment.

3.2.2. Gulf War of 1991

The Persian Gulf War deserves special mention because it perfectly encapsulated the demands for mobility and care in the application of force required to achieve the United Nations Coalition's objectives. The resounding military success of Desert Storm was partly due to thorough planning and the build-up of superior force on the ground, following classical military principles. The other outstanding feature was the deployment of air power to weaken the enemy's defences and resolve. Air supremacy was achieved quickly and exploited effectively, with only two reservations. Firstly, the Coalition forces experienced great difficulties in locating and destroying Scud ballistic missile launchers which, although of negligible military significance, represented a politically important terror threat: considerable resources were diverted in an attempt to counter them. Secondly, there were some losses of ground attack aircraft (other than stealth fighters) from relatively primitive, albeit heavy, ground defences.

Important pointers to future operational capabilities were the use of conventional cruise missiles, helicopter-launched anti-ship stand-off missiles, and unmanned air vehicles for reconnaissance, surveillance and targeting. Perhaps even more remarkable than these relatively new weapons however was the fact that the majority of airborne weapons deployed (such as laser guided bombs and missiles) had been in the inventory for a decade or more.

In the autumn of 1991, AGARD's Guidance and Control Panel, impressed by the apparent success of precision guided weapons in contributing to the effectiveness of the Coalition forces, instituted its own study of the Gulf War implications for guidance and control. The results of this study, which predated the AASC analysis (paragraph 3.1.3) have been published in AGARD Report R-806 (Persian Gulf Technology Implications Assessment) and proved a valuable guide to planning the Panel's technical programme.

The two studies covered many of the same topics in terms of Nato Strategic Needs but, with the GCP's concentration on Guidance and Control, it identified a number of additional operational needs and technology thrust areas where developments in G&C technology could be expected to have a significant impact, as indicated in figure 3.3 overleaf.

3.2.3. Peace Support Operations

In marked contrast to the Gulf War, ex-Yugoslavia stands as an example of one of the more intractable problems threatening world peace – civil war. As with most civil war situations, it defies conventional solutions, except perhaps old-fashioned, draconian "pacification" which would require very large forces and is in any case incompatible with the UN Forces' peace-keeping mission.

If PGM guidance technology can make a contribution it can only be to limit the scale of the combatants' operations by denial (or neutralisation) of their offensive weaponry. Thus a high-precision near-instantaneous counterfire capability might conceivably be employed to inhibit the use of artillery, mortar fire and even small arms fire against civilian populations with reduced risk of collateral civil casualties.

Similarly, surgically precise offensive air operations are necessary when the targets are located in the midst of civilian populations.

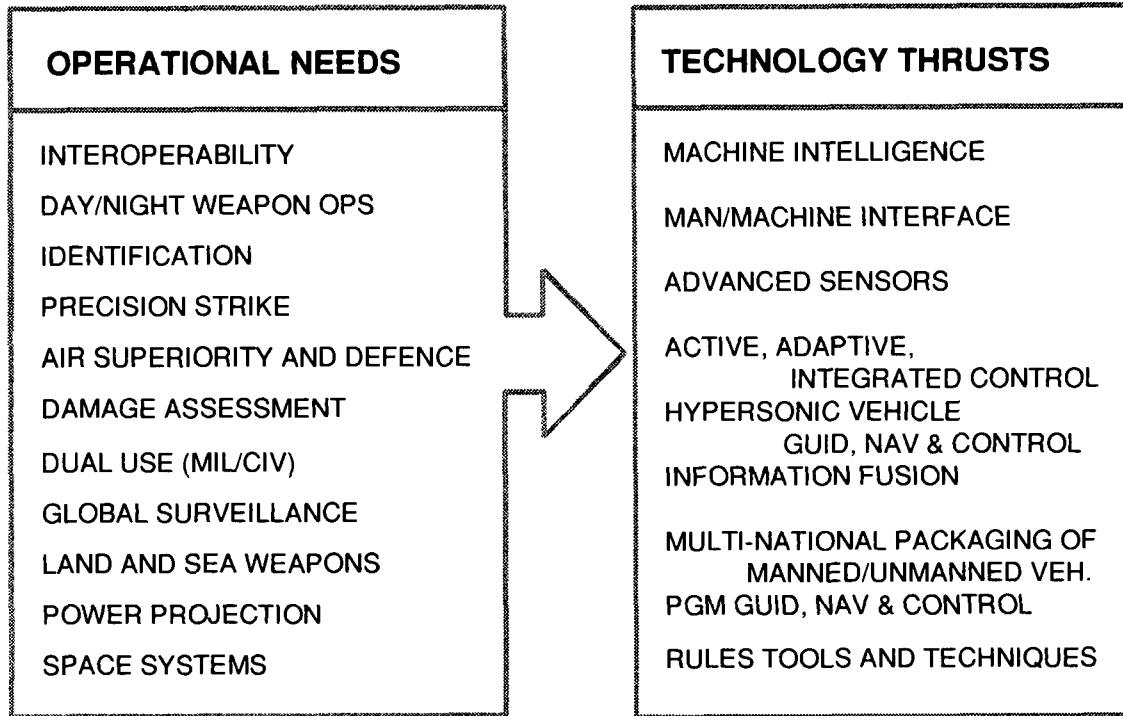

Figure 3.3. Operational Needs and Technology Thrusts

3.2.4. Future Conflicts

The only sure prediction that can be made in considering future conflicts is that they are unpredictable. However, there are several lessons relevant to PGM technology that can usefully be applied from the experiences of the last few years. Firstly, the need will remain for a conventional limited war capability, and for improvements in the effectiveness and general utility of PGM. Secondly, Nato forces must be prepared to adapt rapidly to changing circumstances, which will require an ability to modify, adapt, and develop their weapons quickly, as needed. Thirdly, there is a clear need for new types of munition that could be safely deployed in the confused situations of civil war. Also, the heightened awareness and sensitivities of Western nations will impose an even greater urgency on minimising or eliminating accidental injury to non-combatants and friendly forces.

3.3. Future PGM Needs

3.3.1 Summary of Strategic Needs

For the military functions identified in paragraph 3.1.2, major improvements in the cost-effectiveness of operations could be achieved by better use of PGM and by increases in their effectiveness and general utility. In summary, the significant trends may be represented in order of importance as in figure 3.4 overleaf. The identification of priorities is necessarily subjective and the emphases can be expected to change as circumstances change: nevertheless the aim is to provide an indication of the areas in which PGM developments would be of most help in meeting Nato needs.

MILITARY FUNCTION	WEAPON SYSTEM FEATURES						
	All-Weather Day-Night Op.	Multi-Use	Interoperability	IFF	Precision Effect	Stand-Off / Autonomy	Air Trans-Portability
Interdiction	1	3	1	1	1	1	2
Land Combat Operations	1	2	1	1	1	1	1
Air Defence Operations	1	2	2	1	1	2	3
Offensive Air Operations	1	2	2	3	1	1	3
Maritime Surface Operations	1	3	3	2	2	1	3
Amphibious Warfare	1	1	2	1	2	2	1
Peace Support Operations	2	1	1	1	1	3	1

KEY

POTENTIAL INFLUENCE ON PGM

1 Major
 2 Significant
 3 Minor

Figure 3.4. Military Functions and Weapon System Implications

3.3.2. Specific PGM R&D Needs

Following on from the analyses of the AASC and the GCP, the PGM capabilities needed to meet the future needs of Nato may be summarised under the following headings:

Lighter, more effective weapons: requiring improved sensors and guidance, as well as advanced warheads and propulsion systems. As an example of how technology advances might meet this goal, Figure 3.5 overleaf shows diagrammatically the interaction between guidance and control systems and warhead systems. Developments in on-board data processing capacity, coupled with intelligent imaging seekers offer the possibility of major increase in lethality with smaller warheads through aim point selection and precision homing. This in turn, by reducing missile size, can reinforce homing dynamics and kinematics in a beneficial interactive loop.

Consideration must however be given to the possible widespread proliferation of stealth technology with compensating emphasis on guidance complexity, size and weight: for example, multi-spectral imaging seekers with data fusion and adaptive guidance; high power active radar seekers; bi-static/netted surveillance and command guidance mid-course and/or data links; semi-active/third-party-illuminated guidance. Conversely, stealthy targets, by reducing target acquisition ranges could make even greater demands for low mass and agility in PGMs.

More precise, night/all weather stand off weapons for mobile and fixed targets: requiring improved sensors with autonomous capability, including target detection, classification and recognition. In the case of fixed targets a combination of GPS navigation (with some reservations on availability and integrity in wartime) and scene-correlation target acquisition may be adequate but mobile targets make greater demands which are only likely to be met by the introduction of machine intelligence into PGM guidance. The rapid development of powerful on-board data processing capacity and/or neural networks can be expected to have a profound influence – if the problem of timely procurement can be solved. In no

other area is technology developing so rapidly, and the problem of built in obsolescence so acute, as in data processing applications to guidance and control.

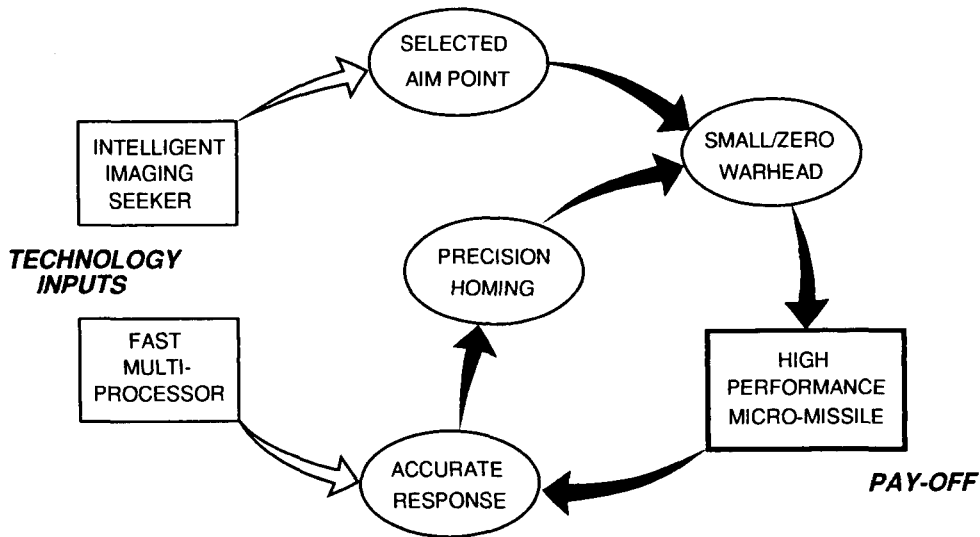

Figure 3.5. Guidance - Lethality Interactions

Extreme stand off weapon capability: is a possible alternative to the platform mobility that smaller, more effective weapons are intended to address. Development of stand-off capability to an extent that would reduce the need for ground force forward deployment depends on overcoming the restraints of cost and positive target identification. At the present time conventional cruise missiles are prohibitively expensive for many applications and are limited to well-defined high value targets in conventional war situations.

Multiple target/target-type engagement capability: This problem is essentially one associated with direct fire weapon employment and applies particularly to the platform's target acquisition, aiming and weapons management systems in Air Defence systems. Nevertheless, improvements in PGM technology will have a significant influence. Multi-mode missile capability, whilst enhancing weapon system effectiveness, imposes its own demands for improved interfaces. In addition to multiple target engagement, attention should also be given to improved salvo effectiveness, including shared intelligence through internetted data/command links and data fusion.

User friendly (minimum training) systems and concepts for augmentees: To improve rapid augmentation capability, this requirement is also relevant to the issue of reducing life cycle cost. Improvements to the man/machine interface and development of machine intelligence are areas of direct relevance to PGM, as are Extended Shelf Life. Improved man/machine interface: though primarily aimed at reducing costs and improving effectiveness in the field, is also a significant factor in reducing training requirements.

Improved identification of friend/foe: including the introduction of IFF capability into PGM. Advanced micro-miniaturisation may provide solutions to this requirement in Air Defence operations. Back up capability could be provided in other operations by autonomous seekers with target recognition capability. The possibility of combining stand off capability with surveillance through data-linked, internetted SOW for example, could also provide major improvements in situational awareness.

Smaller, more precise weapons: the main driver being the need for improved mobility of Nato forces and improved weapon platform firepower. Other benefits could also be significant, such as: reduction of environmental impact and collateral damage; and response to the future development of faster

and more agile targets with the consequent need to cope with reduced reaction times and second shot margins. On-line dynamic kill assessment (that is, predicting engagement outcome continuously, in advance of warhead detonation) could provide improved second-shot assessment.

Improved producibility, reliability, maintainability: are aimed at reducing whole life cycle cost. Early expenditure on research and technology demonstrators can be a major factor in making the right design decisions at an early stage in the PGM life cycle, including R&M factors.

Dual-use (including PGM adaptability): to meet demands for increased flexibility of Nato Forces. Improving the adaptability of PGMs could also help to overcome problems of obsolescence and enable rapid responses to be made to changing threats. Guidance techniques may include built-in programmability/reprogrammability, pre-planned product improvements (P³I) via software changes, re-configurable on-board software, built-in surplus computer capacity and modular guidance architectures.

3.4. Summary of Needs

The future PGM needs listed in paragraph 3.3 above are intended as a focus for the discussion of technology trends and user concerns in Chapters 4 and 5. The division of subject matter in those chapters reflects the difference between predominantly technology-driven – albeit directed – research which often precedes formal military requirements (technology push) and more specific military needs that are generally the subject of more formal research or development programmes (requirement pull). This distinction is not black and white, but is nevertheless a useful and comprehensive way of looking at the subject.

Chapter 4 provides a general review of the principal areas of technology appropriate to the terminal guidance of munitions. The relevant military needs can be summarised in terms of greater operational flexibility, precision, adaptability and ease of use. These basic needs are the background against which the value of technological improvements addressed in Chapter 4 may be judged.

Chapter 5 addresses a number of specific concerns, related to Nato operations, which terminal guidance technology has the potential to ameliorate. They include the obvious and long-standing problems of munitions' costs and development timescales, IFF and BDA which have a direct bearing on munitions' use and effectiveness, plus two issues (mission planning, and the environment) in which advances in munitions technology could provide useful benefits.

CHAPTER 4. TECHNOLOGY TRENDS

The aim of this chapter is to review technology, directly or indirectly related to guided munitions, and its future potential in relation to military needs, either from the point of view of enhancing current capabilities or of generating new capabilities.

4.1. Sensors

The target sensor is defined here as that portion of the seeker which senses the target (and/or target area). It comprises a sensor device to convert target or background input energy (electromagnetic or acoustic) into a measurement, plus a signal conditioner or signal processor which outputs target and background information in a useable form to the guidance processor and tracking servo (see figure 2.3). The components making up the sensing element depend on the sensor type and operating frequency (or wave) band as illustrated in figure 2.4. The best known target sensors for munitions include passive electro-optical (EO) devices (Infrared, visible, or ultraviolet); semi-active EO (1.06 μ m laser); active EO (10.6 μ m laser radars); active or semi-active radio frequency (RF), from centimetre wave (CMW) to millimeter wave (MMW); plus passive MMW.

4.1.1. Multi-Spectral / Multi-Mode

A multi-spectral or multi-mode system uses a combination of sensors to perform its mission (e.g. I²R/MMW, I²R/ladar). The main reason for using more than one sensor is to achieve improved performance by blending the advantages of each: typically, the more independent the measurements of a sensed scene, the better performance can be obtained, usually through better resistance to countermeasures and poor weather. Multi-spectral seekers also offer a natural solution to the problem of target discrimination and target tracking by their ability to measure many more properties of the desired target and its background. Multi-spectral operation can also make use of multiple narrow band-pass filters in a single atmospheric transmission band in order to discriminate target spectra from background or countermeasure sources. In addition to the foregoing advantages, performance enhancements potentially include the measurement of more target features, greater variety of targets for multi-purpose munitions, improved identification of friend or foe, and improved countermeasures resistance.

The distinction between multi-spectral and multi-mode is essentially the use made in the seeker of the different information obtained in each spectral band. Whereas a multi-spectral seeker will generally aim to use the information simultaneously through data fusion, multi-mode seekers operate in only one band at any one time, switching from one sensor to another as circumstances demand. The term "multi-mode" also embraces the concept of a seeker operating in a single frequency band but with the ability to switch operating modes between combinations of active, semi-active, or passive. Switching operating modes can be advantageous for tactical reasons, for example to avoid the necessity of a launch platform maintaining semi-active illumination of the target throughout interception, or to extend maximum range, or as a counter-countermeasure.

The advantages of multi-mode seekers may be seen by the dual-mode case using IR/MMW combination. By combining an IR and MMW sensor, not only are the individual strengths of each exploited, but the unique advantages of dual mode operation are realized as well. For instance, in an interceptor application a dual mode seeker is much harder to spoof or hide from than a seeker that relies on electromagnetic phenomena in a single band. Countermeasures become difficult or impossible when it is necessary to disguise or imitate both the radar cross section (RCS) and the temperature/emissivity properties of the target. Chaff or corner reflectors that may confuse a MMW seeker will have little or no effect on an IR seeker. Specialized camouflage, on the other hand, can be effective in making tanks or buildings difficult to distinguish from their surrounding in the IR. These paints and cloths may have little or no effect on MMW sensors. The detection advantage of a dual mode seeker is also evident under varying weather conditions. In clear weather, a ship, aircraft, tank, or foot soldier, carrying a missile that employs an IR seeker, has the

advantage of good maximum effective range. If the user of such a weapon engages an enemy who is using a limited range MMW weapon, he is able to detect and destroy the enemy before the latter is capable of firing a shot. On the other hand, if fog, clouds, rain, or smoke should unexpectedly engulf the area, an IR weapon system may be entirely blinded, but a MMW missile may be launched from close range.

The cost of multispectral or multi-mode devices is typically higher than an equivalent single spectral device. Radomes (or equivalent) must pass energy in each band and processors must handle the burden of additional target information, especially if the information is being processed simultaneously. The additional costs can be contained to some extent however, since it is often easier to achieve a required weapon performance from a combination of sensors, and the use of multi-spectral features may allow the use of simpler designs of each individual sensor. For example, the measurement of range by a millimeter wave sensor may reduce the demands on an infrared sensor for target discrimination, and the availability of optical imagery at short range may allow the radar to be optimized for longer range weather penetration. In essence, the aim should be to apply each sensor in the roles that best satisfy its capabilities without forcing its operation into regions that challenge its capabilities and drive up costs. The problem of finding compatible transparent materials for different parts of the electromagnetic spectrum can also be sidestepped by using separate transparencies for each band. In special cases, synergy between complementary sensors may actually be exploited to reduce the cost for a given performance requirement.

4.1.2. Multiple Targets

In the presence of multiple targets, weapon sensors are presented with special problems. Sensor limitations such as spatial and frequency resolution may render the system unable to isolate individual target characteristics, and targets with vastly different features may cause incorrect measurements to be assigned. For example, a large cross section target will mask lower cross section targets in radar range and velocity gates. Reflections or countermeasures may also confuse measurements of the number of aircraft operating in a region. Multi-mode or multi-spectral sensors enable the various views of the targets to be correlated to ensure that features are associated with the correct target track.

4.1.3. Improved Acquisition

Despite the tremendous capability demonstrated in the precision guided munitions of the 1990s, many improvements are needed. Most Nato countries have active programmes to correct such deficiencies. Desert Storm demonstrated a serious inability to strike in all weather conditions. Many aircraft returned from their missions with their stores unlaunched due to weather limitations in the target area. Most precision guided munitions use electro-optical sensors to achieve their "near-zero" CEP. Their short wavelength permit high angular resolution with a reasonable sized aperture. However, these short wavelengths do not penetrate the atmosphere for any great distance in conditions of high water vapour content, whether rain, fog or even high humidity. Although weapons can fly horizontally under a low cloud ceiling, the ability to hit or penetrate targets that have a low profile, or are hardened in their horizontal aspect, is compromised. The ability to predict accurately the the weather in the target area requires some form of weather reconnaissance at the time of, or shortly before, weapon deployment. For a long range munition, the weather can also change during its flight. Clearly there is a need for improved acquisition in poor weather. The basic laws of physics preclude EO sensors for all weather operation. Longer wavelength MMW or CMW radar sensors provide better atmospheric penetration but are unable to resolve very small targets or target features. As mentioned elsewhere, real beam radars may be replaced by synthetic aperture radars (SAR) to achieve high resolution. Moving targets are effectively invisible to SAR processing which may be an advantage or a disadvantage, depending on the application – although, at the cost of additional complexity, single beam aperture processing can always be added "to put the vehicles back". Against fixed targets SAR seekers are potentially very effective and are under development in several countries for tactical missile application.

Increased acquisition range in good weather is also needed for almost all seeker applications. Missile

trajectory shaping is facilitated by early target acquisition, and it minimises restraints on the launch platform in cases where it is required to support missile operation (e.g. semi-active seekers). In exchanges with advanced enemy systems, the ability to shoot first is vital to survival, and extended range can compensate for numerical inferiority. In radar systems, acquisition range is a function of transmitter power, receiver sensitivity and aperture. Greater range can be achieved by increases in power, by larger apertures, or by more sophisticated clutter rejection. Passive sensors, such as EO or IR, must use larger apertures, more sensitive detectors, or more sophisticated target discrimination processing. Improvements might include better matching of target and background spectral, temporal, polarimetric, or trajectory characteristics.

Weapons are generally tailored to specific targets, causing them to be of limited use against other targets. For example, an anti-ship missile depending on the radar characteristics of ships may be totally ineffective against most land targets. It would be highly desirable for a frigate, say, to avoid having to carry different weapons for sea and land targets. It would reduce loadouts, simplify logistics, and make it more likely to have the correct weapon when needed. However, the benefits of broader use weapons must be balanced against possible loss of effectiveness compared with a weapon tailored to a specific task. Similarly, anti-radiation missiles would benefit from a capability against both air and surface targets of all types: the design implications are significant but the operational pay-off would be major.

Finally, it must be mentioned that, as weapons improve, potential targets are improving their survivability through stealth and countermeasures. Weapons of the future must be capable of dealing with stealth technology through greater sensitivity, better discrimination, and improved clutter rejection. This could lead to entirely new concepts in sensors, able to recognise new target features not previously considered or regarded as useful. For example, if an aircraft could be made nearly invisible to present sensors, a sensor capable of detecting the aircraft's wake might be an attractive alternative, previously disregarded because of the relative ease of detecting past aircraft designs. Thus, as targets become more difficult to detect, acquire and track, previously improbable approaches become more attractive in an evolutionary process to match advances in aircraft, ships and land vehicles. Counter-stealth technology may represent the use of old technology in new ways.

4.1.4. New Seeker Types

Solid state ladar: A laser radar (ladar) sensor is represented functionally by the block diagram shown in figure 4.1. As shown in the figure, a laser pump and amplifier module are used to generate a pulse of the proper length (τ), pulse repetition frequency (PRF) and wavelength (λ). This pulse of energy is routed through the optics module which provides a transmit/receive diplexing function. The energy propagation path is then through the scanner module which accomplishes necessary beam scanning so that the required spatial scan pattern is formed. These modules, in conjunction with the telescope module and the "window," are also responsible for formation of the beam shape (instantaneous field of view) as it exits the sensor.

The received reflected energy is passed through this same light path. The detector system detects the reflected energy (signal) and through the preamp provides the signal to the image processor.

Ladars are configured as serial scan devices in which the pulsed output of the laser is steered in a raster scan format to cover the desired search pattern. This search pattern in turn can be steered to obtain coverage over the desired field of regard (FOR).

Ladar has the potential of providing high 3-D resolution images of observed objects. When properly processed highly accurate aim-point tracking as required for precision guidance is achievable. Solid State Ladar in the 1.06 μ m band, with features of multiple beam splitting, multiple element receiver arrays, and mirrors which provide framing rates much higher than that obtainable by a PRF-constrained single beam serial scan concept, represent the state-of-the-art.

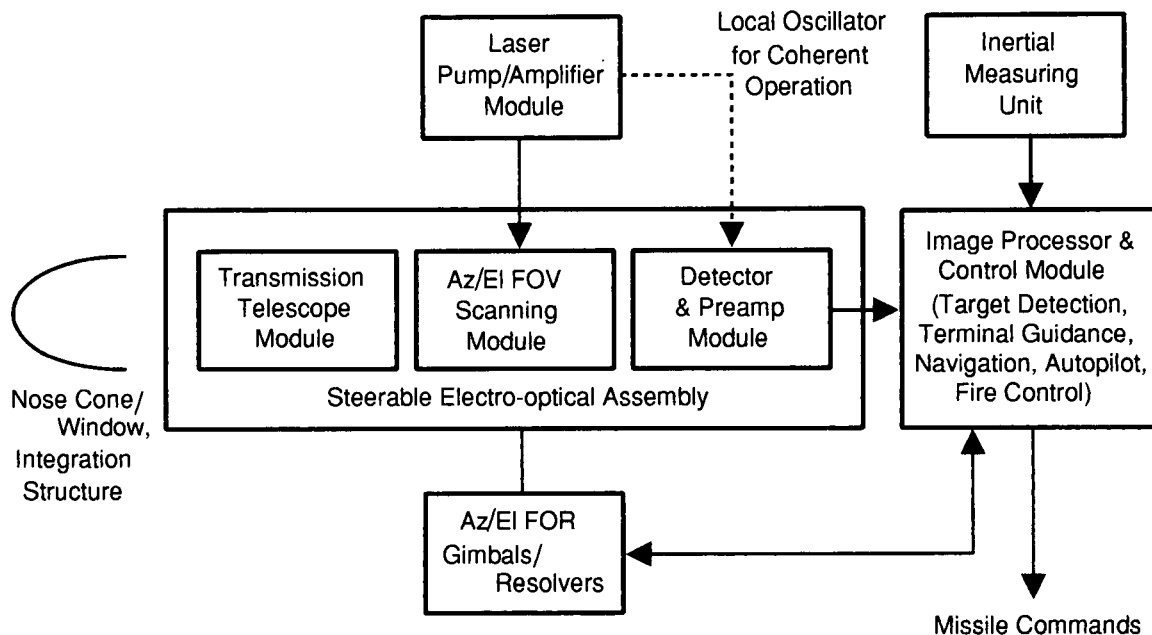

Figure 4.1. Typical Ladar Seeker Configuration

Synthetic aperture radar (SAR): SAR sensors, represented functionally by the block diagram shown in figure 4.2, provide strong possibilities for precision guidance.

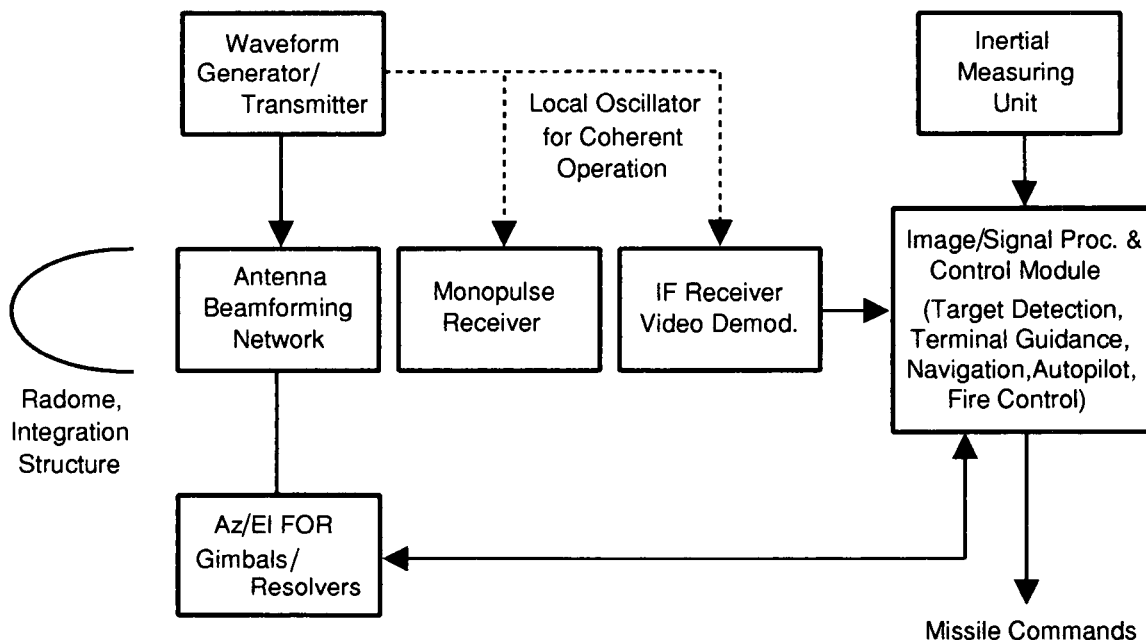

Figure 4.2. Typical SAR Seeker Configuration

The SAR approach makes use of differential changes in slant range (and associated RF propagation phase) along the line-of-sight (LOS) that exists between different cross range parts of the range resolution cell as the sensor is carried along its flight path. By appropriately processing the signals received over a portion of

the flight path, the sensor achieves a cross range resolution that is many times better than that of the aperture associated with the sensor. Achievement of the enhanced cross range resolution allows the collection of sufficient information from the data to accomplish, within complex scenes, target acquisition and precision tracking. High resolution is important for target acquisition. The cross-range resolution, ΔR_{Xr} that can be achieved is related to the radar characteristics and to the effective length of the synthetic array, by

$$\Delta R_{Xr} \approx R_S \lambda / V \sin\theta T_i$$

Where:

- R_S is Slant range
- λ is RF wavelength
- V is vehicle ground speed
- θ is squint angle
- T_i is integration time

To obtain high resolution it is necessary to extend integration time and fly a path not directed towards the target. The implied trajectory constraints must be considered in assessing the value of SAR to the precision guidance application and in the design of the weapon's autopilot.

Imaging infrared sensor (I²R): Although I²R sensors have been around for a number of years, the most common being those in the Maverick and GBU-15 weapon systems, the newness of the focal plane array technologies must class this under the heading of "new sensors." These sensor types have been demonstrated in "autonomous" modes, and both the MWIR (Medium Wave IR) and the LWIR (Long Wave IR) spectrum have been demonstrated to various degrees. Scanning arrays and staring arrays, gimballed systems and strapdown systems are all candidates for precision terminal guidance application. The imaging infrared sensor is more mature, and has lower technological risk, than any of the other technologies described here, but of course is limited in some scenarios by weather influences similar to that of ladar

A modern I²R seeker might typically have:

- 256 by 256 element focal plane array (FPA)
- milliradian resolution (electronically combined to fit imaging needs)
- 15° by 15° FPA/Optics system field of view (FOV) of which parts are electronically selected to satisfy line-of-sight and processed FOV requirements
- Two-axis pseudo-gimbals ($\pm 30^\circ$ conical gimbal freedom)
- <0.1° noise equivalent differential temperature (NEAT)

Figure 4.3 shows a generic block diagram of an I²R sensor, in this instance a semi-strapdown type (that is, a sensor which has some, but not all, of its major elements fixed relative to the missile airframe). As represented in the figure, the sensor's look angle is controlled with respect to the body by a simplified two-axis gimbal mechanism which manipulates the angular orientation of a scan mirror in such a way that a desired wide FOV is obtained. It enables the centre-line of the FOV to be scanned relative to the strapped-down detector (FPA/Dewar/Optics assembly) over a $\pm 30^\circ$ conical range. The body-referenced pointing angles of the steering mirror are calculated to point the center line of the FOV along the weapon-to-target LOS defined by an inertial measurement unit (IMU). LOS stabilization is executed electronically by the signal processing functions.

4.2. Signal/Data Processing

4.2.1. Devices

The effective real-time implementation of many new techniques for target detection, recognition, classification and the terminal guidance of missile seekers requires a high level of computing power. Many companies are now producing high resolution imaging systems which further necessitate the use of high computing power for image analysis. These considerations form the central focus of this section.

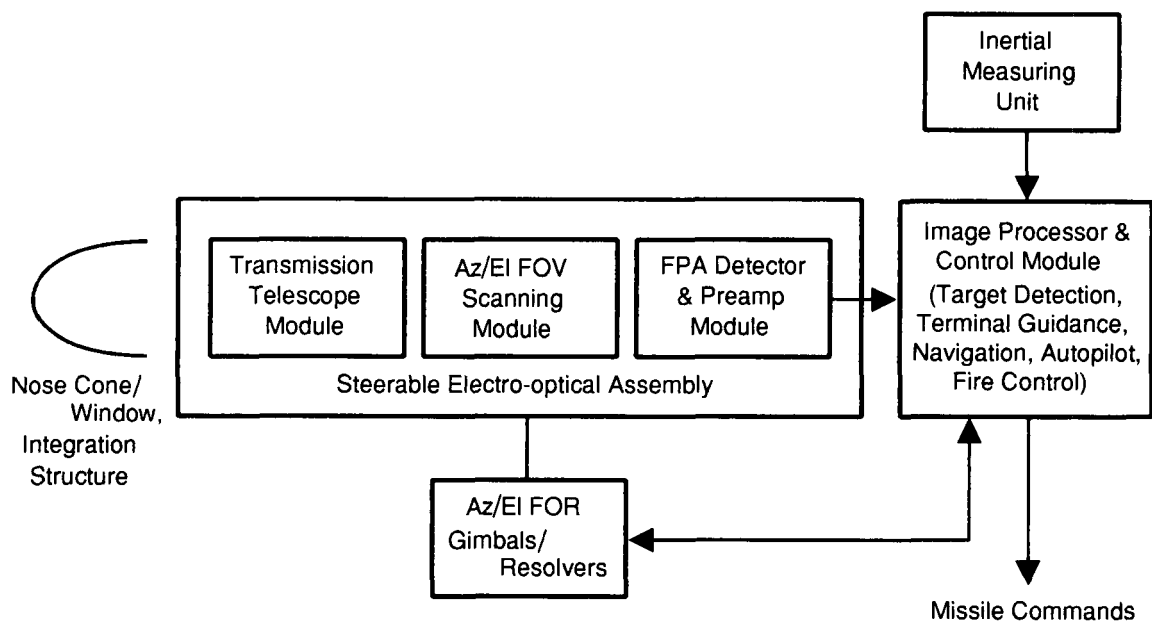

Figure 4.3. Generic Semi-Strapdown IIR Seeker Configuration

In an attempt to increase the resolution of thermal imaging systems, several companies have produced high space bandwidth (SBW) product devices. Some of these devices employ long multi-element linear array detectors which enhance output resolution but which display in standard video format. Other thermal imaging systems generate imagery using a standard 625 line output, but use cylindrical optical elements to increase horizontal resolution. In the main, though, high SBW product devices require non-standard displays, due to the increased resolution. Although the question of display standards is not relevant to most guided munition applications (the exception being operator-in-the-loop systems), the requirements apply equally to the fast image processing needs of guided missile seekers.

The high resolution of high SBW product devices is particularly useful for automatic target recognition (ATR) (since a more accurate target representation is available) and guidance (since a more accurate target position is available). However, the increased resolution of this class of devices leads to a consequent increase in the computing power necessary for image analysis.

Parallel processing architectures, that can work on several operations concurrently to increase the speed of calculation, have been implemented for some time. Existing parallel processing machines, such as the Space Centre 2000 shared memory computer, which uses 16 separate processors in parallel to achieve high processing power, and the Cray T3D massively parallel computer, which uses 256 DEC processors in conjunction with a Cray YMP vector processor front end, are interesting examples of the speed of computation that can be achieved by serial processors arranged in arrays with suitable partitioning and scheduling of the total task to permit individual operations to be performed in parallel. Inmos Transputers represent a different approach. They are distributed computing devices with multiple input/output links, designed to use the OCCAM parallel computing language. A typical application consists of an array of transputers whose paths are executed in parallel and are connected by high speed asynchronous data links which increase data transfer rates as shown in Figure 4.4. They are being utilised for example in ASRAAM for guidance processing and autopilot functions.

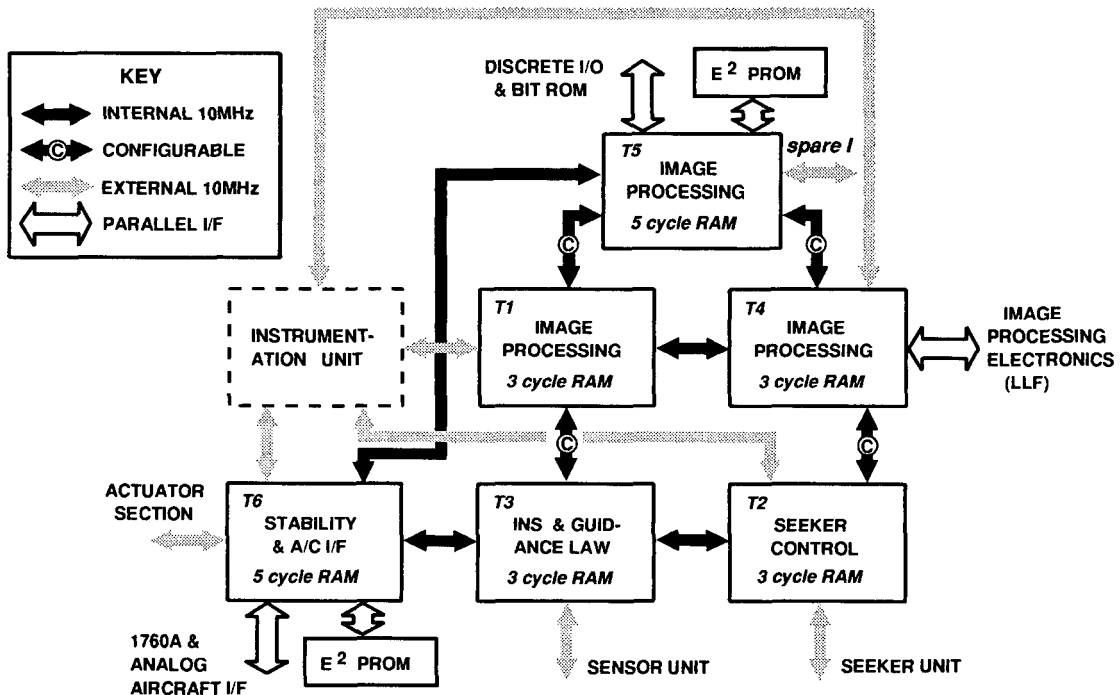

Figure 4.4. Transputer Application to Guidance Processing

The commercial and scientific pressures towards more advanced parallel processing architectures and devices will inevitably lead to orders of magnitude improvement in processing speed and power becoming available in the relatively near future. The implications for terminal guidance are extremely important, not only in higher performance of existing functions but also the possibility of entirely new modes of operation, representing a qualitative change equivalent to the adaptable multi-mode features made possible by the shift from analog to digital guidance processing.

4.2.2. Processing

Sensor Fusion

The main purposes of sensor fusion are to obtain better target positional information, to eliminate false alarms and to reduce susceptibility to countermeasures. All the types of sensor described in Chapter 2 can be considered as possible inputs for sensor fusion (ref. 1, chapter 1), noting the basic performance strengths of weather penetration and angular discrimination for radar and EO sensors respectively. Possible scenarios involving sensor fusion are:

- Use of a low resolution sensor to sweep large volumes of space in a relatively short time, to provide possible targets for a high resolution system which operates in a different waveband. Because one sensor confirms/denies the existence of the target, the false alarm rate is reduced. Because the two sensors operate in different wavebands, countermeasures against one will not affect the other.
- Dual waveband thermal Imager and visible/thermal imager: used to discriminate against flare countermeasures. The ratio of the target signal from each waveband is used as a measure of the certainty of target designation.
- Passive I²R(or FLIR)+ladar: The passive I²R can be used for large area search, while the laser radar can be used to find target range. This is useful for moving target designation. The system would be passive until the laser radar was employed, leaving less time for the target to perform avoidance tactics, helping the system itself to avoid detection.

- Millimetre wave radar+thermal imager: The millimetre wave radar is used for target search and the thermal imager is used for target recognition.

With sensor fusion, one of the key problems is that of data association. Consider a target surveillance system which employs several sensors. The information from each sensor can be used to form separate detection tracks, which can then be combined to form a master track file. This is known as Sensor Level Tracking (SLT). The alternative is to send the information from each sensor to the central processor and form a master track file. This process is termed Central Level Tracking (CLT). A fuller discussion of CLT and SLT can be found in ref. 1.

SLT reduces data-bus and computational loading and enhances system survivability due to the distributed track capabilities (degradation of one sensor does not affect the other sensors). The main problem with SLT is how to combine the sensor tracks. The track combination logic must also take account of target manoeuvres. This problem has been solved by use of Kalman filtering (ref. 2). CLT suffers mainly from the amount of information which must be transferred from the sensors. However, the track combination problems of SLT are not present with CLT.

Since CLT and SLT suffer from potential problems, a combined approach (where both central and sensor tracks are maintained) can be utilised (ref. 3).

Kalman filtering methods have essentially replaced fixed gain filtering methods for sensor information combination. Bayesian and Dempster-Shafer methods for target identification (ref. 1, Sections 7.5.2 & 7.5.3) are beginning to replace previous methods, such as Possibility Theory (ref. 1, Section 7.5.1). There has also been much recent interest in artificial intelligence techniques to determine interrelationships between targets. These techniques are useful for predicting target intent and behaviour (ref. 1).

Neural Nets

Neural networks offer a solution to the problems of pattern recognition and noise reduction by aiming to imitate autonomous brain functions. Unlike conventional computer programs, a neural network is presented with a series of examples that specify desired outputs for given examples, thus learning by example.

In general, a neural network consists of simple processing elements called neurons. Each neuron is connected to some of the other neurons and a real valued weight is associated with each connection to represent the connection strength. Each neuron has an activation function whose output determines the state of the neuron (dependent on the inputs to it from neighbouring neurons and the input nodes connected to it). Neurons go through a succession of activations which modify the connection strengths between them (the Learning Procedure). The connection strengths, once the network has been through its learning procedure, collectively contain a blueprint for the behaviour of the network.

Neural network architecture can be categorised as one of three types: Single-Layer Networks, Multilayer Feedforward Networks and Feedback Networks (ref. 5).

Figure 4.5(a) shows a single-layer network with one output. This type of network can classify objects into types. The Perceptron (ref. 6) is an example of such a single-layer network. The Perceptron can only classify objects if the object acts are linearly separable, a problem which is solved by the single-Layer Functional-Link Network (ref. 7) which incorporates additional nodes along with the input nodes. In general, single-layer networks tend to be less stable than other networks.

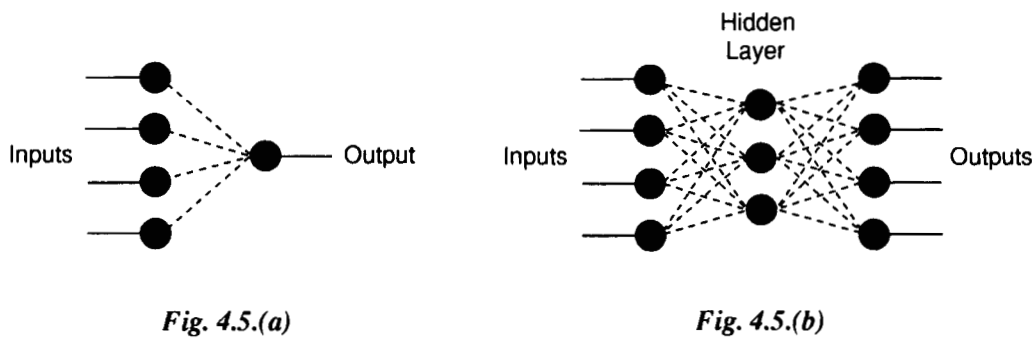

Fig. 4.5.(a)

Fig. 4.5.(b)

Figure 4.5. Basic Neural Networks

Figure 4.5(b) shows a multilayer feedforward network architecture, consisting of an input layer, an output layer and a "hidden" layer (so called because it is not connected to the outside world). At present, the most widely applied neural network paradigm is the multilayer feedforward network which employs backpropagation (BP). The BP architecture consists of fully interconnected processing nodes (as figure 4.5(b)). The BP network functions in two stages, the Forward Sweep (an estimate of the desired output) and the Backward Sweep (to calculate node errors and update node weights). Once the network has completed one Forward Sweep and Backward Sweep for each training pair (input and desired output) a Learning Epoch is said to be completed. Several Learning Epochs may be required for the network to become operational.

Multilayer feedforward networks can be constructed which determine their own topology adaptively. The Cascade-Correlation Architecture (ref. 5, section 2.2) begins with no hidden nodes and gradually adds hidden nodes, one by one, until the Learning Procedure is complete.

Feedback networks, such as Hopfield Networks (ref. 8), Bidirectional Associative Memory (BAM) Networks (ref. 9), the Neocognitron (ref. 6) and Boltzmann Machine Networks (ref. 11) gradually settle to a solution by gradually solving a complex set of constraints. These networks are useful for filtering noise as a pattern goes through successive updates of the state of the network. The answer is given by the network after it stabilises.

Specific learning algorithms such as the Gradient Descent Method (ref. 12), the Delta Rule (ref. 5, Sec. 3.2), the Backpropagation Algorithm (ref. 5, Sec. 3.3) and the Cascade-Correlation Algorithm (ref. 5, Sec. 3.4) have been derived from the underlying mathematics of the relevant network.

These algorithms have been designed to provide an efficient structure for teaching networks. For certain applications, once the network has been trained, it may be operated in learning-mode for a long time without further training. For such cases, learning speed (normally measured in terms of the number of Learning Epochs taken for the network to settle) may not be a critical factor and may be traded off against other factors, such as robustness of solution. Certain applications may require the network to change frequently from operational mode to learning mode (if, for example patterns do not remain static for long). For these applications, the choice of learning algorithm is critical.

The Metric Associative Memory Capacity is used to measure the number of distinct patterns that can be stored in Associative Memory. Analytical techniques for estimating memory capacity are discussed in (ref. 11). It is important that the associative memory model can not only store the required number of patterns, but also provides a recalling mechanism with a good noise filtering capability.

It is important that the design of a network minimises the number of Spurious States (stable states which do not correspond to any desired pattern). This is done by ensuring that the network has the best noise filtering capacity possible.

In the design of a Neural Network, several issues are of prime importance.

- Neural Network Architecture Selection.
- Learning Speed.
- Data Representation and Preprocessing.
- Accountability, Capability and Reliability.

A discussion of the foregoing properties is given in ref. 14.

Artificial Intelligence

The processes of image recognition and interpretation necessary for ATR and terminal guidance require some measure of "intelligent cognition". The knowledge and understanding of the fundamental principles involved in recognition and interpretation are imprecise and, in many cases, speculative. This lack of understanding requires the formulation of constraint and idealizations intended to reduce the level of complexity to a manageable level. This tends to force intelligent systems to be less general with specialised operational capabilities.

At present, intelligent systems for image analysis tend to fall into three categories:

- Decision Theoretic Models for recognition.
- Structural Methods for recognition.
- Methods for image interpretation.

Decision Theoretics models (ref. 15, Sec. 9.3) are based on representing patterns in vector form and then seeking approaches for grouping and assigning pattern vectors into pattern classes. The principle approaches are minimum distance classification, correlators, Bayesian classifiers and neural networks.

In structural recognition (ref. 15, Sec. 9.4), patterns are represented in symbolic form and recognition methods are based on symbol matching i.e. models which treat symbol patterns like sentences in an artificial language.

The current techniques for image interpretation (ref. 15, Sec. 9.5) are based on predicate logic, semantic networks and expert systems.

4.2.3. Algorithms

Wavelets

Wavelet Theory has applications in the fields of data compression (ref. 16) and signal analysis (Ref. 17). In terminal guidance, there are advantages to be gained from processes which allow efficient passage of image information and target identification. The mathematical theory of wavelets (Ref. 18) has applications to both, and is particularly useful for the analysis of wideband and short duration signals.

A wavelet is a truncated wave which is oscillatory in nature and of finite duration. Applying a wavelet transform to a signal serves to decompose that signal into a set of related wavelets, each of which is a scaled version of a "mother" wavelet. The contribution to the signal from each wavelet is calculated by comparing the signal with the wavelet as it is varied in scale (stretched or compressed) and translated in time (or space). The measure of similarity is called the wavelet coefficient.

The Wavelet Transform is similar to the Fourier transform, which measures the spatial frequency content of a signal in terms of swept sinusoids. However, the wavelet approach allows signal characteristics to be isolated in time (or space) by translating the wavelet relative to the signal, while various signal resolutions can be obtained by scaling (stretching or compressing) the wavelet (Ref. 19).

The wavelet approach also allows different signal representations by changing the "mother" wavelet. Thus, target identification could be enabled by matching the "mother" wavelet to the target signal, or a signal type which mimics a certain class of targets.

The practical implementation of wavelet theory requires that a finite number of wavelets is used. This means that the signal is mapped onto a 2-D grid of coefficients in the wavelet domain (translation and scale parameters). If the signal under analysis is a sampled function also, the Discrete Wavelet Transform (DWT) (Ref. 20) results. For good frequency resolution (helpful for target identification), stretched wavelets are useful. This results in degraded time (or space) localization (e.g. target positional information would be less accurate). For good time (or space) localization (good target position information), compressed wavelets are useful. This results in degraded frequency resolution (reduced target identification efficiency). When choosing the DWT lattice step size, if the scale increment is too great then signal detail may be lost. On the other hand, if the scale increment is too small, the signal may change considerably between adjacent wavelet comparisons.

When performing wavelet transforms, there is always a trade-off between temporal (or spatial) accuracy and frequency resolution.

Devices used to perform wavelet transforms are High Pass/Low Pass filter banks and the Wavelet Transform Processor from Aware STC (Ref. 19).

Image Algebra

Image Algebra is a standardised, mathematically rigorous algebraic structure designed for image manipulation (Ref. 21). The purpose of Image Algebra is to avoid the large number of image processing techniques, notations and operations that have resulted from the ad hoc development of Image Processing, and all too often duplicated previous methods, with consequent increase in research and development costs.

The fundamental basis for the Image Algebra is the mathematical theory of sets. Images are defined in terms of Z (the set of integers), R (the set of real numbers), C (the set of complex numbers) or Z^{2k} (the set of binary numbers of fixed length k). Next, the functions used in image processing are defined (images and templates). These consist of the basic set theory operands and operators as well as the morphological operations of Erosion and Dilation. Erosion and Dilation are particularly useful for image segmentation and shape recognition (ref. 22) through their application to the processes of "Opening" and "Closing" (Ref. 23). "Opening" generally smoothes the contour of an image, breaks narrow isthmuses and eliminates thin protrusions. "Closing" generally fuses narrow breaks, eliminates small holes and fills gaps in the image contour.

As well as object recognition, these morphological operations are useful for the elimination of noise, boundary extraction, extraction of connected image components and region filling.

Fuzzy Set Theory

Fuzzy set theory allows the rigid framework of computer logic to be adapted to deal with the analogic and flexible thinking of humans. The term "fuzzy" (in the sense used here) was termed by Zadeh in 1962 (Ref. 24). Fuzzy set theory was developed in order to investigate certain problems which are too complex or ill-

defined to allow analysis by classical set theory. Zadeh's aim was to investigate problems that are non-statistical in nature. An example like "x is a number smaller than 9" conveys no information as to the probability distribution of the values of x, and as such, is non-statistical in nature. However, fuzzy set theory can also deal with problems that are statistical in nature.

In classical set theory, a set is defined as any number of definite, well distinguished objects grouped together. Within this framework, an object is either a member of a set or it is completely excluded from it. The Membership Function is defined as the degree to which an element belongs to a set.

Whereas In classical set theory the Membership Function for an object takes the value 0 or 1, fuzzy set theory (Ref. 25), allows each element to belong to a set to a certain degree i.e. the Membership Function is represented by a value between 0 and 1 (inclusive).

Having defined the Membership Function, the fuzzy theory of sets goes on to define all set theoretic operations in terms of the Membership Functions of various elements.

Important terms used in fuzzy set theory are:

- The Fuzzy Expected Value (FEV) – The typical value of the membership function.
- The Fuzzy Expected Interval (FEI) – The typical interval of a group of elements.
- The Weighted Fuzzy Expected Value (WFEV) – The typical value of the membership function. In some cases, this is a better reflection of the typical value than the FEV.

Fuzzy set theory is usually utilised in Expert Systems (knowledge-based consultant systems which are structured representations of data, experience, inferences and rules that are implicit in the human expert. Expert systems draw conclusions from a "knowledge base" which is accessed by the user using a software system called the "inference engine". The advantage of using fuzzy set theory in expert systems is that "common-sense" statements (statements that are usually but not always true) can be incorporated into the knowledge base. This allows the "certainty factor" (the measure of the confidence the system has in its conclusion) to be calculated while taking account of the underlying imprecision or incompleteness of information in the knowledge base. Previous expert systems relied upon probability-based methods for calculating the certainty factor. These methods are not flexible enough to prove reliable in many cases.

In terminal guidance, fuzzy set theory could be useful for deciding which object in a scene is most likely to be the target. An example of a pattern recognition system which employs fuzzy set theory is COFESS, which uses three separate fuzzy expert systems to analyse scene elements to see which ones match expected scene elements best (object components), to examine the relationship between scene elements to see which groups best match the desired target, then repeat these processes until a match has been found (the "concluding rule" is satisfied). In order to define the feature certainty, use is made of the FEV concept, an inference machine and a knowledge base.

Another useful application of fuzzy systems is that they can be predictive. This means that a system would be able to "tell" the user under what conditions the system conclusions will be unreliable.

Reusable Software

The concept of reusable software focuses on the development of software systems that are similar in structure to that used by the electrical and mechanical engineering industries, where a system is constructed by combining off-the-shelf component parts.

The idea is that software could also be constructed by combining standard software components, providing reduced software costs and increased reliability.

In order to provide a standardised framework for the investigation of reusable software concepts, the SC model was developed (Ref. 26). The SC model introduces three distinguishable ideas:

- **CONCEPT:** the abstract specification of software functional behaviour.
- **CONTENT:** the code to implement a functional specification.
- **CONTEXT:** the additional information needed to write a behavioural specification.

The model emphasizes the importance of separating what a component does (concept – abstract component) from how a component works (content – concrete component), as well as distinguishing both content and concept from the environment in which a component works (context). This is done to allow for different concrete elements which may provide realization of the same abstract element, thus permitting the software components to be sold as object code. This is done since algorithms cannot be patented so must be "hidden". As a result, the abstract component of reusable software must contain formal specification of the functional behaviour of reusable components. Two main approaches have been developed to perform this task, the "algebraic" approach and the "model-based" approach. In the "algebraic" approach a mathematical object whose behaviour is identical to the program objects is defined. Full explanation of the mathematical object is given, then the program objects are said to act just like the mathematical object. Using this method, a new mathematical object is needed for each new reusable software component. In the "model-based" approach, a number of existing mathematical objects are used to model the desired program objects. This approach seems to be the preferred one because once a customer has learned the various mathematical objects used, it is easier to understand any new reusable component.

In general, the 3C model stipulates that a reusable software component should:

- be clear and understandable,
- state everything about the behaviour that is expected of a correct implementation,
- support a variety of implementations,
- export operations that are so basic that they cannot be obtained by combinations of other exported operations,
- export operations that when combined provide enough functionality to allow a wide variety of computations,
- not depend on the behaviour of another abstract component for an exploration of its functionality, unless it is an extension of that component,
- encapsulate a single concept that cannot be further decomposed.

The implementation of reusable software components also calls for the Initialisation and Finalisation of software objects, so that no problems occur at the "second use" of a software component.

In order to allow reusable software component adaptation by customers, there must be some method for allowing the context of a component to be known. The two main methods used are Genericity and Inheritance. The mechanism of Genericity is to define a schema which defines a family of reusable abstract components, while Inheritance defines a new component in terms of an existing one. Certain programming languages, such as RESOLVE (REusable Software Language with Verifiability and Efficiency) combine Genericity and Inheritance to permit a vast range of reuse possibilities, whilst preserving "information hiding". A major consideration for reusable software components must be verification and testing. It must be ensured that not only does a component always export an operation but that the operation must be correct.

In application to terminal guidance, high level image processing languages (such as SEMPER), which have reusable components that define operations upon images, are certainly useful for algorithm development and demonstration. The reusable elements allow operations, such as Fourier transforms, spatial and convolution filtering, etc., to be performed with relative ease, allowing the user to investigate methods of detection, tracking and target designation without getting too involved in highly detailed code.

4.2.4. General Comments

The foregoing review of signal and data processing technology can only provide a partial view of this rapidly developing subject and will inevitably be overtaken by events. However, some broad conclusions can be drawn that are of major significance for terminal guidance:

- In addition to the exponential increases in raw processing speed, apparent in commercial computers, which result from advances in microelectronics design and manufacturing, the use of new types of device such as neural nets and parallel processors on board guided munitions can be expected to produce orders of magnitude increases in signal and data processing power in the near future.
- Novel processing functions and algorithms, in conjunction with increased processing power, will generate a transformation in existing guidance functions and lead to completely new guidance functions. These could include: genuinely autonomous target detection, recognition and identification; flexible, re-programmable guidance to take account of target information updates and change of weapon application; and "intelligent" determination of the most vulnerable target impact point together with pin-point homing accuracy (using high resolution sensors) and resistance to countermeasures.
- The move towards re-useable software will be facilitated by increases in processing power which will ameliorate the effects of added overheads and functional redundancies. The concept of re-useability can be extended to embrace re-useable hardware, ranging from discrete devices (such as neural network processors) to complete guidance units with re-programmability and/or the capacity for a flexible response to changing inputs.

4.3. Guidance Laws (tracking & homing processes)

4.3.1. Optimal Guidance Laws

Guidance laws based on proportional navigation guidance are generally used for missile applications against high-speed manoeuvring targets. Although simplicity and ease of implementation are the main reasons for the popularity of proportional navigation based guidance laws, this method of guidance is robust and highly effective against responsive threats. Pursuit based guidance laws are not used against these difficult targets. The acceleration requirements for pursuit guidance in these applications are so great that this guidance law can never be used in the terminal phase of these engagements although it may be used in the midcourse phase of flight for trajectory shaping purposes.

Against surface-based stationary targets pursuit guidance is a practical alternative to proportional navigation and permits the use, for example, of velocity-vane or weathercock-stabilized seekers of low cost (relative to those needed for proportional navigation). In addition, pursuit guidance also yields a trajectory which is less likely to hit the ground before the target under the influence of gravity (although proportional navigation can be modified to include gravity compensation if an approximate vertical reference is available).

Since guidance system lags may cause miss distance – even when pursuing a stationary target – it may be necessary to dynamically compensate for those lags. This requires a knowledge of time-to-go before intercept. Usually this requirement means that the range from the missile to target must also be measured for time-to-go information to be derived. Although passive ranging techniques (i.e., techniques for estimating range based only on measurements of the target's subtended angle or of its signal strength or brightness) have not worked in operational systems against manoeuvring targets, they may be worthy of further investigation for passive seekers, when the target is stationary and the vehicle's velocity is known.

At short range however, with an imaging system, the direct estimation of time-to-go is simpler – which in part explains the survival of most pedestrians when crossing the street. A basis for time-to-go estimation algorithms is to compare the target's subtended angle, θ over measured time intervals, Δt . At its simplest, time-to-go to intercept, τ , for constant relative velocity is given theoretically by:

$$\tau \approx \Delta t \div ((\theta_2/\theta_1)-1)$$

Optimal guidance law may go beyond that of the traditional pursuit and proportional navigation laws mentioned. In principle, a guidance law can be conceived which optimises any number of different parameters. For example, one could optimise for impact accuracy, impact angle, impact speed, longest/shortest range, least observable trajectory, least/most propellant remaining at impact, smoothest flight, or least expected trajectory. A trajectory to strike airborne targets from underneath might give the seeker a better opportunity to acquire the target against a low clutter sky at the cost of range. An anti-missile missile might shape its trajectory to optimally coincide with the expected trajectory of the incoming missile. There is an infinite number of different possibilities for optimisation, albeit with the risk of losing performance in other areas. Depending on the degrees of freedom allowed, multiple sub-optimisations could be computed. An aircraft or missile could sense failures of its various flight controls and compensate with new guidance laws to maximise mission survival while sacrificing other goals. Modern high speed computing systems are necessary to perform the massive calculations necessary for such optimisations. In more complex systems, such as a long range missile, the optimisations might be selectable or programmable through the mission planning system.

4.3.2. Trajectory shaping

Trajectory shaping usually occurs during the midcourse phase of flight to maximize interceptor velocity, reduce handover errors by flying towards the expected intercept point, and to place the interceptor in such an orientation that seeker acquisition will occur rapidly. By maximizing missile velocity, an interceptor is provided with its maximum acceleration potential relative to that of the target. Reducing handover errors ensures that only a minimum of interceptor acceleration will be required to take out these errors. Finally, a proper seeker orientation will maximize the terminal flight time which will also reduce the interceptor's acceleration requirements. Trajectory shaping also may be used in conjunction with terminal guidance in those applications where it is important to hit the target at a specific point and a certain strike angle in order to increase interceptor lethality. Such guidance laws have previously been employed in large and complex systems such as the Apollo lunar landing module but are now feasible in digital-data-processor based guidance systems at very little extra hardware cost. In some munition applications a penalty may have to be paid for trajectory shaping, in the form of increased interceptor acceleration than that required for an unshaped trajectory.

4.4. Seeker Stabilization

4.4.1. Stabilization Objectives

The basic reasons for providing seeker stabilization are: 1) to provide the necessary wide field of regard (that is, the angular field over which the seeker can look) for a seeker whose sensor has a restricted instantaneous field of view, and/or conversely reduce the munitions corresponding flight dynamic requirements; 2) to provide for a reliable measure of target inertial angular rate for homing guidance; 3) to enhance acquisition range by increasing the target energy at the seeker; and 4) to reduce the linearity requirements on the seeker's focal plane. The traditional means of obtaining these goals is through an inertially stabilized gimbal. However, a gimbal structure imposes significant cost, weight, and size constraints on terminally guided munitions. Although not always possible, the ultimate goal for all stabilization systems should be the elimination of the gimbals.

The generic situation is illustrated in Figure 4.6. A staring optical focal plane is illustrated overleaf; however this discussion is equally applicable to a scanning optical seeker or to radar seekers. A munitions control system nominally consists of two feedback control loops, one being a position loop closed through

the optical seeker and the other being a rate loop closed through the gyroscope. Because of the position loop, the drift requirements for the gyro, both for stabilization and homing guidance purposes, are very easily met. Typical accuracy values are on the order of 0.01 deg/sec.

The primary stabilization/tracking system objective is to maintain the target on the focal plane while concurrently providing an accurate measure of the error between the target position and the focal plane's reference coordinate axes. Because the target image is not inertially stable, motion of the munition, if not corrected for, will cause the target to move about the focal plane corrupting the tracking accuracy. This effect can be corrected for by using either mechanical gimbal stabilization or by strapdown stabilization techniques. Apparent target motion will be a complicated function of the munitions disturbances, the control system response, and structural resonances. However, for our purpose, apparent target motion is best analyzed when segregated into its low frequency and high frequency components.

High frequency motion in a strapdown stabilization system, which is beyond the basic capabilities of the stabilization system, essentially increases the apparent size of the diffraction limited spot on the focal plane. The result is to spread the target energy over a larger area of the focal plane. This decreases the target detection range and reduces position measurement accuracy since the new target spot size will be roughly equal to the rss addition of the diffraction limited spot size and the uncompensated residual focal plane motion. Gimballed stabilization systems, if their performance is better than the seeker diffraction limit, maintain the target energy on a single pixel and do not have this problem.

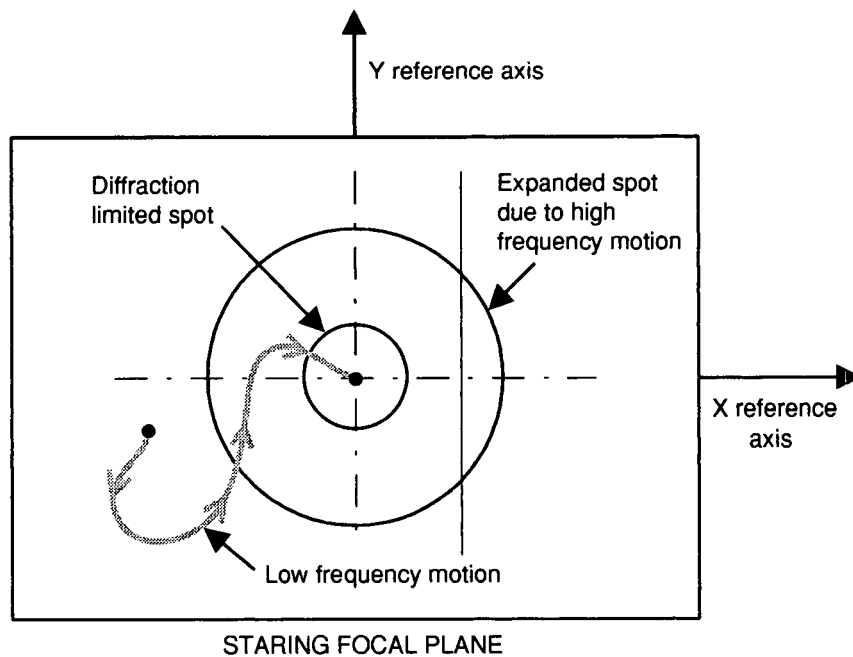

Figure 4.6. Sensor Stabilisation Objective

Low frequency motion is capable of being compensated by either stabilization system approach. In a gimballed system, the target is maintained at the focal plane centre by the position and rate loops, and the angular rate of the target will be the angular rate of the gyroscope or rate sensors controlling the gimbal. For strapdown stabilization approaches, the target is allowed to wander over the focal plane while the gyro simultaneously measures the motion of the focal plane with respect to inertial space. The target motion on the focal plane is then added to the inertial motion to obtain the complete angular rate signal required for guidance.

Selecting between gimballed or strapdown stabilization concepts requires consideration of all the above factors and many more; however, as seekers improve, the long term trend is towards complete strapdown system approaches and away from the use of gimbals, provided detectors have the necessarily wide instantaneous field of view.

4.4.2. Low Cost Gimbals

Gimbals are intrinsically a major cost factor in terminally guided munitions. There is both a direct effect, the cost of the gimbal structure itself, and an indirect effect, that is, the cost associated with the overhead functions needed to support a gimbal in such munitions. The increased mass of the munitions will be greater than that of the gimbal system itself since it also includes the additional propulsion and control required by the added mass.

Additional weight at the front end can also create stability and control difficulties for the autopilot. A wider field of regard, while a significant positive attribute, results in the need for windows or radomes that are more difficult to manufacture, expensive, and heavier. The issue of radome aberration slope (the angular rate of off-axis refraction of received target radiation) is aggravated by the need for a larger window associated with a gimballed system, resulting in potentially detrimental stability and/or accuracy effects on the munition.

Gimbals of all types are expensive because of the numerous precision machining and labor intensive processes which are generally involved. The primary method to create low cost gimbals is to automate the manufacturing process, eliminating such labor intensive processes. Significant research is now under way to develop these processes. These new techniques often rely on composite materials or moulded components in order to realize such processes. Rate sensors, which often impose major restrictions on gimbal layout, have also become smaller and less costly. An example of new rate sensor technology is the development of silicon micromechanical machining of gyros which can be packaged on the focal plane becoming an integral part of the sensor itself. This also has the advantage of eliminating the effects of relative motion and vibration, improving stabilization quality, and facilitating precision manufacture.

If a system cannot be made to operate without a gimbal then reducing the number of gimbals, where possible, becomes an important factor in reducing total cost. While a full three-axis gimbal is generally required for complete stabilization, two gimbals, or even one gimbal can sometimes meet the system requirements. Hybrid concepts, which use gimbals and some strapdown techniques, can also provide a satisfactory compromise between cost and performance. In such cases the gimbal provides coarse stabilization while residual motion near the focal plane centre is compensated by strapdown techniques.

A significant factor in the decision making process is whether the munition is spinning or not and, if so, how rapidly. For example, if the munition is not rolling about its nominal velocity axis, then two-axis stabilization will often be sufficient. Conventional artillery shells spin rapidly (typically 200 Hz.). More modern artillery designs employ non-spinning penetrators with sabots to fit within conventional gun designs. Many bombs roll, though slowly. Spinning of munitions can provide advantages and/or disadvantages beyond the traditional reasons associated with projectile stability. Spin can provide for target modulation and error signal generation, and often supports fixed actuator control schemes. However, if the munition spins too rapidly, these potential advantages can disappear. The primary point here is that a de-spun munition, requiring the development of a single axis gimbal, is usually the best solution and is certainly the cheapest, short of a strapdown system.

4.4.3. Strapdown Stabilization

The ultimate objective in a fully strapdown seeker is to determine line-of-sight angular rate due to target-missile relative motion without the use of gimbals, to avoid the expense and unreliability normally associated with precision mechanisms. In such a case, the target no longer remains at – or near – the seeker

null but is allowed to move about the field of view. Wider fields of view are required to maintain target track, and linearity across the field of view becomes more important since the tracker no longer operates only at its null. As a result, the seeker requirements become more difficult than for a conventional rate-stabilized gimballed seeker. Furthermore, the dynamic range of missile body rate and relative target sight line rate measurements (from which line-of-sight angular rate must be determined) is generally wider than the more direct measurement made in a rate-stabilized gimballed seeker, and therefore the demands for rate sensor measurement (or estimation) precision become much more severe. However, advances in seeker technology and data processing are making such strapdown techniques both feasible and affordable.

Semi-strapdown seekers utilize a gimballed sensor which is stabilized by reference to body-mounted rate sensors (which may also be the autopilot control feedback sensors) or INS platform (if needed for other guidance functions); sight-line angular rate being determined by measuring gimbal rates relative to the missile body and comparing them with body rate measurements as in a fully strapdown configuration. Sensor complexity is avoided, and the gimbal design is simplified relative to a conventional seeker by the absence of gimbal-mounted rate sensors, while the total number of rate sensors is reduced (though with concomitant demands for increased performance).

For applications – for example sub-munitions, anti-radiation missiles, etc. – against stationary targets, and where no great manoeuvre is necessary, a fully strapdown system is mechanically simple and attractive. However, it still relies on a substantial amount of data processing for estimation of sight-line angular rate and, because the target seeker is rigidly attached to the body frame (in effect making the entire munition body the seeker platform) the attitude control system must retain the target image of optical seekers stable on the focal plane as well as holding the vehicle steady. If the attitude disturbances due to manoeuvre and control are too large, or if the optical signal strength is lower than expected, the focal plane image will suffer. It is the objective of this section to discuss gyroscope requirements for electronic stabilization of an image on the focal plane of a strap-down seeker operating within a specific environment or system.

There are two principle reasons for stabilizing the image on the focal plane. First, if the signal strength is small, it should be concentrated in as few pixels as possible (for a staring array detector) in order to be seen above the background noise. The second reason is somewhat implementation-dependent and can be discussed in terms of the target state estimator. This estimator (usually a Kalman filter) expects input (angle measurements) from the seeker at the end of the measurement interval. It is assumed that the measurements are taken at some specific time, e.g. the middle or the end of the interval. Of course, if the image is stationary on the focal plane this is no problem. However, if the image is moving during the signal integration time, the question arises of whether the angle measurement at any particular instant of time is at the midpoint or the end of the interval. If the image motion is due to the inertial rotation of the line-of-sight to the target, then there is no choice but to make the integration interval smaller. If the image motion is due to seeker rotation then that rotation can be "subtracted out" or compensated for.

The requirements for strapdown gyroscopes or rate sensors, which measure body attitude motion during the signal integration interval, are obviously a high data rate with only moderate-to-low long term stability. There are many variations depending on the mission and on the other system components: for example, gyroscopes used in the rate stabilization loop of a gimballed radar can also be used for body motion stabilization; or functionally equivalent algorithms using inertial measurements can be used to stabilize body fixed seekers. Here, so-called "inertial aiding" is used to "point" the seeker when rates exceed those of the target tracking loop.

For the purposes of image stabilization, the small sight-line rotations due to target relative motion must be measured over several subintervals of the total signal integration time. Each of these measurements must be of comparable accuracy to the desired seeker measurement accuracy. Because the small rotations during the signal integration time are of interest, the long-term stability or drift of the gyroscope is not important. The requirements for the gyroscope can be specified without actually defining an operational stabilization algorithm. (An algorithm can be used to construct an image and to evaluate the angular error in that

constructed image). The requirements are strongly dependent on the vehicle rotational motion. This motion determines the frequency with which the gyroscope must be read to provide an adequate history of the attitude during the signal integration interval.

The requirement for angular rate stabilization is easily established. It should be smaller than, but in the same order of magnitude as, the desired optical instrument accuracy. Measurement noise is more difficult to specify. One simple approach to the problem is to let each of the n sub-interval measurements be a single non-redundant percentage measurement of the attitude at that time. However, noise in these measurements will cause the de-smear spot to be noisy. If enough independent sub-interval measurements are taken, the desmeared image will be more fuzzy (larger), but its mean location will be accurate. The uncertainty in the mean is a function of sample size and can be computed. However, the noise itself, due to the physics of the instrument, is a function of bandwidth. (The bandwidth must be high to get frequent, independent measurements.) The specification of gyro quality will thus be in terms of noise and frequency of output.

To summarize, strapdown stabilization is a preferred technique whenever possible because of its inherent cost and weight advantages over conventional gimbaled approaches. Strapdown stabilization is an important element in achieving the longer term objective of smart munitions and interceptors, that of reducing the mechanical complexity of all components and subsystems (engines, seeker, propulsion, etc.). Strapdown stabilization techniques require advances in seeker FOV, linearity, and window technologies, while simultaneously imposing dynamic or agility constraints on munitions. Nevertheless, the advantages of these techniques at the system level are often worth the investment in near-term technological advances. The recent development of silicon micromechanical inertial instruments has opened up the prospect of integrating stabilization and detector technology, and could be the single most important step in the development of this capability.

4.5. Inertial Sensors

Major changes are currently underway in technologies associated with inertial sensors used for stabilization, control, and navigation. These changes are leading to the proliferation of inertial sensors in a wide variety of new military and commercial applications. Inertial sensor manufacturers have begun to adopt many of the fabrication techniques that have been developed by the solid-state electronics industry over the last decade. Inertial sensors are being fabricated in silicon, quartz, and with electro-optic materials, such as lithium niobate, by employing low-labor-intensive batch processing techniques. The utilization of these techniques will result in low cost, high reliability, small size, and light weight for inertial sensors and for the systems into which they are integrated. Some inertial sensors have already been fabricated with dimensions so small that they are barely visible to the naked eye. Some of the more trend-setting emerging sensor technologies applicable to precision guided weapons are described next. They are: fiber-optic gyros, micromechanical gyros, resonating beam accelerometers, and micromechanical accelerometers (refs. 27, 28).

4.5.1. Fiber-Optic Gyros (FOG)

Sagnac effect rotation rate sensors result from the counter propagation of light beams in a waveguide which exhibits optical reciprocity between its clockwise and counterclockwise paths. Rotation normal to the waveguide plane upsets this symmetry, which is then photoelectronically detected and processed to provide an indication of rotation rate. The FOG is implemented using an integrated optics chip constructed in lithium niobate, and fiber-optic sensing coil (a few meters to a kilometer long), diode light source, and photodetectors. This configuration is expected to be supplanted eventually by quantum well technology, such as gallium arsenide, which will then allow integration of most of the above components into a single substrate attached to the fiber-optic coil, thus increasing reliability and reducing costs. FOG sensors have no gas or mirrors and do not exhibit lock-in at low rate, which are disadvantages associated with some ring laser gyros. They therefore should be an economical replacement for the ring laser gyro (RLG), providing the same level of gyro bias performance.

4.5.2. Micromechanical Gyros

Micromechanical gyros are usually designed as an electronically-driven resonator, often fabricated out of a single piece of quartz or silicon. Such gyros operate in accordance with the dynamic theory that when an angle rate is applied to a translating body, a Coriolis force is generated. When this angle rate is applied to the axis of a resonating tuning fork, its prongs receive a Coriolis force, which then produces torsional forces about the sensor's axis. These forces are proportional to the applied angle rate, which then can be measured capacitively (silicon) or piezoelectrically (quartz). The output is then demodulated, amplified, and digitized to form the device output. As an example, Systron Donner's QRS (Quartz Rate Sensor) uses this technology and has been incorporated into a tactical missile guidance set. Silicon micromechanical instruments can be made by bulk micromachining (chemical etching) single crystal silicon or by surface micro-machining layers of polysilicon. Many manufacturers are developing gyros and accelerometers using this technology. Their extremely small size combined with the strength of silicon makes them ideal for very high acceleration applications.

Draper Laboratory has demonstrated a 30 degree/hour ($^{\circ}/h$) open-loop silicon tuning fork gyroscope with folded beam suspension in which the flexured masses are electrostatically driven into resonance with a comb-like structure. Rotation is sensed capacitively along the axis normal to the plane of vibration. The Draper gyroscope is aimed at the automobile market and is being marketed through an alliance with Rockwell International. Between 3,000 and 10,000 devices can be produced on a single five-inch silicon wafer. Devices with lower drift rates are being developed for more demanding applications, such as autopilot control and smart munitions.

4.5.3. Resonating Beam Accelerometers

Resonant accelerometers (sometimes referred to as vibrating beam accelerometers, VBAs) have a principle of operation similar to that of a violin string. When a violin string is tightened, its frequency of operation increases. Similarly, when the accelerometer proof mass is loaded, one tine is put into tension and the other into compression. These tines are continually electrostatically excited at frequencies in the hundreds of kilohertz range when unloaded. As a result, when "g" loaded, one tine frequency increases while the other tine frequency decreases. This difference in frequency is a measure of the device's acceleration. This form of accelerometer is essentially an open loop device, in that the proof mass is not rebalanced to its center position during the application of a force. For accuracy, it relies on the scale-factor stability inherent in the material properties of the proof mass supports. These accelerometers can be constructed using several different fabrication techniques. One method is to etch the entire device (proof mass, resonating tine, and support structure) from a single piece of quartz. The use of such techniques can result in low-cost, highly reliable accelerometers with a measurement accuracy better than 100 micro g's (μg). Constructing this accelerometer from a single piece of quartz results in high thermal stability, along with dynamic ranges approaching those obtainable in the timekeeping industry.

Kearfott and Sundstrand have developed laboratory prototypes aimed at strategic missile guidance in the belief that these solid-state devices hold potential for good lifetimes and reliability. Sundstrand, Systron Donner, Draper Lab, and others have produced navigation grade – and tactical grade – quartz resonant accelerometers.

4.5.4. Micromechanical Accelerometers

Micromechanical accelerometers are either the force rebalance type that use closed-loop capacitive sensing and electrostatic forcing, or the resonator type as described above. Draper's force rebalance micromechanical accelerometer is a typical example, in which the accelerometer is a monolithic silicon structure (i.e., no assembly of component parts) consisting of a torsional pendulum with capacitive readout and electrostatic torquer. This device is about 300 x 600 micro meters (μm) in size. The pendulum is supported by a pair of flexure pivots, and the readout and torquing electrodes are built into the device

beneath the tilt plate. The output of the angle sensor is integrated and then used to drive the torquer to maintain the tilt plate in a fixed nulled position. The torque required to maintain this balance is proportional to the input acceleration. Performance around 250 μg bias and 250 parts per million (ppm) of scale factor error have been achieved.

Micromechanical accelerometers can also be fabricated using wafer bonding sandwich construction techniques, as in Litton's silicon accelerometer. Kearfott and Sundstrand are also developing silicon micromechanical resonator accelerometers. Analog Devices has a polysilicon capacitive accelerometer fabricated with an on-chip BiMOS process to include a precision voltage reference, local oscillators, amplifiers, demodulators, force rebalance loop and self-test functions. Complete integration of sensor and electronics will likely become common in all future micromechanical instruments.

4.5.5. Future Technology Applications

Solid-state inertial sensors like those described previously have potentially significant cost, size, and weight advantages over conventional instruments, which will result in a rethinking of the options for which such devices can be used in systems. While there are many conventional military applications, there are also many newer applications that will emerge with the low cost and very small size inherent in such sensors, particularly at the lower performance end of the spectrum. In nearly every case, when these newer solid-state inertial technologies have been evaluated against today's technology, given comparable technical requirements, this new class of solid state inertial sensors becomes the winner because the basis of selection is almost always cost. A vision of the inertial instrument field for relevant military applications for the next twenty years is shown in Tables 4.1 and 4.2 for the gyro and accelerometer, respectively.

Future Navigation Application	Gyro Stability Requirement (deg/hr) 1 sigma	Typical Gyro Types Used
Cruise Missiles and Aircraft Navigation Systems	0.01 – 0.1	Fibre Optic Ring Laser
Tactical Missiles	0.1 – 10	Fibre Optic or Silicon Micromechanical
Flight Controls, Smart Missiles	Greater than 10	Silicon Micromechanical

Table 4.1 Future Gyro Requirements vs Applications

Future Navigation Application	Accelerometer Stability Requirement (micro-g) 1 sigma	Typical Types Used
Cruise Missiles and Aircraft Navigation Systems	10 – 100	Quartz resonant or Silicon Micromechanical
Tactical Missiles	100 – 1000	Quartz resonant or Silicon Micromechanical
Flight Controls, Smart Missiles	Greater than 1000	Silicon Micromechanical

Table 4.2. Future Accelerometer Requirements vs. Applications

The performance application region of about 0.01°/h for gyros is expected to shift from current ring laser gyro (RLG) applications to fiber optic gyros, which will detect their rate-induced Sagnac frequency shifts using lithium niobate or gallium arsenide technologies. The ring laser gyro is an excellent instrument, but its manufacturing is heavily dominated by precision machining processes and alignment requirements,

which force its costs to remain relatively high. However, one particular area where the ring laser gyro is expected to retain its superiority is in the area of scale factor. The laser gyro has its optical path maintained in a rigid structure, whereas the fiber-optic gyro has its path in glass, making the FOG fundamentally much more susceptible to environmental effects such as temperature changes. For comparable performance applications, the selection between the FOG and the RLG will very likely depend on the scale factor requirements (i.e., the accuracy in measuring an applied rotation rate).

The tactical low-performance end of the application spectrum will be dominated by micromechanical inertial sensors. These could be, for example, gyros and accelerometers photolithographically constructed in silicon or quartz and subsequently etched in very large numbers as a single batch. The military market will likely push the development of these sensors for applications such as "competent" and "smart" munitions, aircraft and missile autopilots, short time-of-flight tactical missile guidance, fire control systems, radar antenna motion compensation, "smart skins" utilizing embedded inertial sensors, multiple intelligent small projectiles such as flechettes or even "bullets," and wafer-scale GPS/inertial integrated systems.

The potential commercial market for micromechanical inertial sensors is orders of magnitude larger than any contemplated military market. The application of micromechanical gyro technology to the automobile industry is one case where, for example, a true skid detector requires a measure of inertial rate in order to operate successfully. Products designed for this industry must be inexpensive and reliable – both characteristics of solid-state technology. Many other micromechanical inertial sensor applications exist for automobiles such as airbags, braking, leveling, and GPS augmented navigation systems. Additional commercial applications can be found in products such as camcorders, factory automation, general aviation, and medical electronics. The performance of the micromechanical instruments will probably continue to improve as more commercial applications are found for this technology.

Since the end of the "Cold War", the actual number of military inertial systems that will be procured in the future has been uncertain. However, the general trend is clearly away from large strategic systems towards smaller tactical systems and towards military applications of commercial products. Table 4.3 gives some projections of cost for quantity production of future inertial systems.

	Flight Controls, Smart Munitions	Tactical Missiles	Tactical Missiles	Cruise Missiles Aircraft INS
Accelerometer Technology	Silicon Micromechanical	Quartz Resonant or Silicon Micromechanical	Quartz Resonant or Silicon Micromechanical	Quartz Resonant or Silicon Micromechanical
Accelerometer Bias Stability (micro-g)	1000	200	100	50
Type of Gyro Technology	Silicon Micromechanical	Silicon Micro- mechanical or Fibre Optic Gyro	Fibre Optic Gyro	Fibre Optic Gyro
Gyro Bias Stability (°/hr)	10	1	0.1	0.01
INS Production Cost	\$500	\$2,000	\$10,000	\$15,000

Table 4.3. Future INS Error Budgets (1σ) and costs

The systems are made up of gyros and accelerometers whose performance match the mission requirements. Current research and development activity for inertial sensors spans the spectrum of the four performance ranges shown. The United States Advanced Research Projects Agency is pursuing the FOG based 0.01°/h

INS in its GPS Guidance Package (GGP), while many commercial firms are pursuing the mid to very low performance ranges in Table 4.3. Size has also become important. The FOG based GGP has a volume goal of 100 cubic inches (1.6 litres), a weight goal of 7 lb (3kg), and a power consumption goal of 25 watts. A Draper Laboratory system using micromechanical instruments and a GPS receiver is being developed with a volume requirement of 30 cubic inches (0.5 litre), and a goal of 9 cubic inches (150 ml). These latter two development programs use the Global Position System to update the navigation information so as to bound navigation errors.

4.6. Global Positioning System (GPS)

"Precision strike weapon" is a phrase used in the United States defense industry to connote a weapon system CEP < 3 metres relative to the target. The specification that is applicable to the Global Positioning System results in a precise positioning of a GPS receiver operating with the P(Y) code of approximately 10 metres (CEP) in the WGS-84 coordinate system. Recent advances and planned programs to improve GPS accuracy, new approaches on how to use GPS in relative or differential modes, and new techniques to reduce target location error, have all contributed to the real possibility of developing a "precision strike weapon" using GPS/INS navigation without a target seeker. This section will discuss these three items. It should be noted that even if GPS/INS is only used for accurate mid-course navigation, the target acquisition by the target seeker should be simplified because of the accurate position information provided by the GPS/INS.

4.6.1. GPS Specified Accuracies

The current 16 metre (CEP) specified accuracy, or 8 to 10 metre (CEP) derived accuracy of the GPS PPS (Precise Positioning Service) provides impressive navigation performance especially when multiple GPS measurements are combined in a Kalman filter to update an INS on a weapon. The Kalman filter provides an opportunity to calibrate the GPS errors, as well as the inertial errors, and when properly implemented, CEPs better than 8 metres have been obtained. For example, in 1993 the USAF dropped GPS/INS equipped GBU-15 bombs from F-16s and demonstrated better than 8 metre accuracy (ref. 29). Some current weapons in the US inventory exploiting (or planning to exploit) GPS/INS are listed below.

- Stand-off Land Attack Missile (SLAM)
- Tomahawk Block III Cruise Missile
- Tomahawk Block IV Cruise Missile
- Joint Direct Attack Munition (JDAM)
- Joint Stand-off Weapon (JSOW)
- GBU-15 Precision Glide Bomb
- AGM-30 (Powered version of GBU-15)
- ATACMS Ballistic Missile
- Conventional Air Launched Cruise Missile (ALCM-C)

In assessing the accuracy of GPS, the largest error sources are in the space and control segment. Ionospheric errors, tropospheric errors, satellite clock errors, and satellite ephemeris errors are the dominant error contributors. For most military receivers, the ionospheric errors can be reduced by using a two-frequency receiver, and tropospheric errors can be reduced by using a deterministic compensation model. The remaining errors of satellite clock and ephemeris can be decreased by any of 3 methods: Wide Area GPS Enhancements (WAGE), differential GPS (DGPS), or relative GPS (RGPS). The next three subsections describe these approaches that offer potential for "precision strike accuracy."

4.6.2. Wide Area GPS Enhancements (WAGE)

The GPS ground control segment is responsible for determining the ephemeris and satellite clock parameters and uploading them to each satellite once a day. During that following day, the errors in the satellite's position and clock, as a function of time, slowly grow from the corrected information. In the

current GPS constellation, the satellite clock and ephemeris errors have been observed to be more accurate than specified and can be expected to be on the order of 3.4 and 1.4 metres (1σ), respectively (ref. 30, p.99). Combining these errors by taking a root sum square gives a user range error (URE) of about 3.6 metres.

If it is assumed that receiver and other independent random errors are approximately 2m (1σ), denoted as UEE, then the total user equivalent range error (UERE) is:

$$UERE = \sqrt{(URE^2 + UEE^2)}$$

For the values of URE and UEE specified above, UERE is 4.1m (1σ).

Horizontal dilution of precision (HDOP) is a geometrical factor that is a function of the geometry between the GPS receiver and the tracked satellites. For tracking 4 satellites, HDOP is typically 1.5. Then applying the approximate formula:

$$CEP = 0.83(HDOP)(UERE)$$

results in a CEP of 5.1 metres for the present upload approach. (Note that further calculations are required for a weapon diving towards a target such that the projection of vertical errors is also included.)

An innovative and extremely simple strategy was developed in 1994 for accuracy improvements in the once a day correction updates (ref. 31) and experiments have been conducted during 1995 to verify the concept. The experiment involves uploading pseudo-range corrections for all satellites with each scheduled, individual satellite upload. The correction tables are available to all authorized users in the encrypted navigation message. A receiver can decode the messages from all the satellites it is tracking, to find and apply the most recent table to correct these satellites. The GPS message table of corrections is repeated every 12.5 minutes; the time that the table was updated is broadcast every 30 seconds. So a user can rapidly find out which satellite in his field-of-view contains the most recent table of corrections. Once that is found, the user selects the corrections for the satellites that are being tracked. In this scheme, the expected error contributions from satellite clock and ephemeris are expected to be about 2m (1σ) or better. This is the case of tracking 4 satellites, where the average age of the correction data is now 4.8 hours, as opposed to an average age of 12 hours in a once-a-day upload. Repeating the previous calculation with URE of 2 metres and UEE of 2 metres results in a CEP of 3.5 metres.

The average age of the data improves if more than 4 satellites are tracked. If tracking 7 satellites, the average age is 3 hours; if tracking 8, the average age is 2.67 hours. Tracking more than 4 satellites also improves HDOP. For 8 satellites, HDOP is typically 1. The calculation now gives a CEP of 2.3m. With multiple GPS measurements used in a Kalman filter and an INS, even higher accuracy should be achievable. Experiments reported to date (ref. 32) indicate an improvement of 7.5 metres to 2.5 metres in CEP and 9 metres to 3.25 metres in CEP for a stationary GPS receiver.

As these experiments are being conducted, the GPS Joint Program Office has not finalized the final implementation details on WAGE, but expectations are that it will be implemented. Even further improvements are contemplated to clock and ephemeris accuracy. (ref. 30, p.99). In this later phase, the data from five Defense Mapping Agency (DMA) GPS monitoring sites will be integrated with data from the existing Air Force operational control segment. By including additional data from the DMA sites, which are located at higher latitudes than the Air Force sites, an additional 15 percent improvement in combined clock and ephemeris accuracy could be anticipated.

A final decision on the implementation was expected in 1996. There are currently "precision strike" demonstrations planned using both the AGM-130 and the ALCM-C using WAGE in late 1995 and in 1996.

4.6.3. Differential GPS (DGPS)

DGPS typically uses a single reference receiver located at a surveyed point to compare its range measurements to the GPS satellites with those calculated from the surveyed location. The differences between the measured and calculated ranges are the pseudorange corrections that are transmitted to other user-receivers. The corrections remove most of the satellite clock and ephemeris errors as well as ionospheric and tropospheric delay errors. The corrections are usually very accurate over a few hundred miles, particularly if the weapon (or aircraft) has its own tropospheric and ionospheric corrections. In 1995, six GBU-15s incorporating a differentially corrected INS/GPS navigation scheme, were dropped from US Air Force F-16s at Eglin AFB. These tests demonstrated that better than 5 metre CEP was achieved (refs. 33, 34).

In actual implementation in a theater of operations, corrections would be sent over encrypted data links to the aircraft (or weapon) in a timely fashion. Accuracy of these corrections would be a function of distance to the ground reference stations and time since the last update to the weapon. The cost of the improved accuracy is the increased vulnerability of the data links, as well as, the ground stations and aircraft equipment needed to support the implementation.

4.6.4. Relative GPS (RGPS)

Relative GPS is similar to both DGPS and WAGE in that the concept owes its increased accuracy to the elimination of "bias-like" errors due to ephemeris and satellite clock errors. However, these errors are not explicitly calculated and corrected for, as in WAGE and DGPS. In RGPS, two GPS receivers are forced to track the same satellites and (conceptually), the difference between the two receivers (the relative navigation solution) only contains small random noise errors since the "bias-like" large contributors to the navigation error cancel out.

RGPS is probably the least known of the three concepts proposed to achieve precision strike accuracy. Experiments have also been conducted which show that 3m CEP is possible. In Appendix D, the RGPS concepts and experimental results are described. RGPS is similar to DGPS in that a data link for the one time transfer of information is typically required if using ground-based receivers. However, as explained in Appendix D, RGPS has certain attributes when targeting is considered. If aircraft on-board targeting of the weapon is performed, then the target location is identified relative to the aircraft GPS/INS set and those relative coordinates are loaded into the GPS/INS guided weapon and the weapon is made to guide to the target location using the same set of satellites that the aircraft used. In this manner, the biases due to satellite clock and ephemeris errors cancel out of the solution.

4.6.5. Summary of GPS Approaches

This section described three approaches involving GPS that could be used to update an INS for precision strike applications. WAGE, DGPS, and RGPS all have the potential to provide updates accurate enough for precision strike in a non-jamming environment. It has been assumed that the target location errors have also been reduced, either by using sensors on the launch aircraft to accurately measure the relative location from the weapon launch point to the target or through some other off-board means that transmits targeting information to the aircraft or weapon either during or before the mission. The next section of the report will describe trends in GPS/INS integration and discuss GPS jamming issues.

4.7. GPS/INS Integration

Many guided weapon inertial navigation systems could be replaced with less accurate inertial systems if GPS were continuously available to update the inertial system to limit its error growth. A less accurate inertial system usually means a less costly system. However, given the uncertainty in the continuous

availability of GPS in most military scenarios, an alternate way to reduce the avionics system cost should be to attack the cost issue directly by developing lower cost inertial sensors while maintaining their current accuracy and low-noise levels as reported in Section 4.5. For applications without a jamming threat, GPS updating is expected to eventually provide better than 3 metre navigation accuracy (CEP) when used in conjunction with an INS. In this section, the benefits and issues in using inertial navigation systems augmented with GPS updates are reviewed including a discussion of jamming issues.

4.7.1. Benefits and Issues of Inertial Systems Aided by GPS

The synergism offered by GPS/INS integration is indicated by the following:

1. Aiding the receiver's carrier and code tracking loops with inertial sensor information allows the effective bandwidth of these loops to be reduced, even in the presence of severe vehicle maneuvers, thereby improving the ability to track signals in a noisy environment such as that caused by a jammer. The more accurate the inertial information, the narrower the loops can be designed. In a jamming environment, this allows the vehicle to more closely approach a jammer-protected target before losing GPS tracking. A factor of 3 to 4 improvement in approach distance is typical. Even outside a jamming environment, INS data provides a "smooth" and accurate navigation solution in situations where GPS receiver navigation solutions alone would be subject to short-term outages caused by geometry, signal-strength variations, and antenna shading.
2. The inertial system provides the only navigation information when the GPS signal is not available. Then inertial position and velocity information can reduce the search time required to reacquire the GPS signals after an outage and to enable direct P(Y) code reacquisition in a jamming environment.
3. Low-noise inertial sensors can have their bias errors calibrated during the mission by using GPS measurements in a "tightly-coupled" navigation filter that combines inertial system and GPS measurements to further improve the benefits listed under (1) and (2). The accuracy achieved by the combined GPS/INS system should exceed the specified Precise Positioning Service accuracy of GPS alone.

The synergistic benefits of combining inertial data with GPS data as described in the previous paragraph are notionally shown in Figure 4.7.

However, the ability to adequately calibrate the biases in low-noise inertial system components depends on the avionics system architecture. There are two fundamentally different system architectures that have been commonly implemented to combine the GPS receiver outputs and the inertial navigation system information and thus obtain inertial sensor calibration and to estimate the vehicle state. They are referred to here as the "cascaded filter" and the "tightly-coupled" approaches. It is generally expected that a tightly-coupled filter implementation would result in better inertial system calibration and better CEP. The reasons for that expectation will now be explained.

In the typical cascaded filter approach, as shown in Figure 4.8, there are two separate Kalman filters in the GPS/INS system. The first is within the GPS receiver. The GPS receiver loops are aided with information from the inertial system, and the receiver outputs position and velocity data from its own Kalman filter. The receiver's Kalman filter is usually not optimized for the vehicle dynamics or for the errors in the inertial system aiding it. Furthermore, its position and velocity errors are highly correlated in time with the inertial errors. The second Kalman filter that compares the receiver position and velocity outputs with those of the inertial system is usually run at a much lower rate (typically 5 to 10 seconds update interval) than the receiver filter (10 to 1 Hz). This is to avoid filter instability because the second filter is designed as if the errors in its input measurements were uncorrelated.

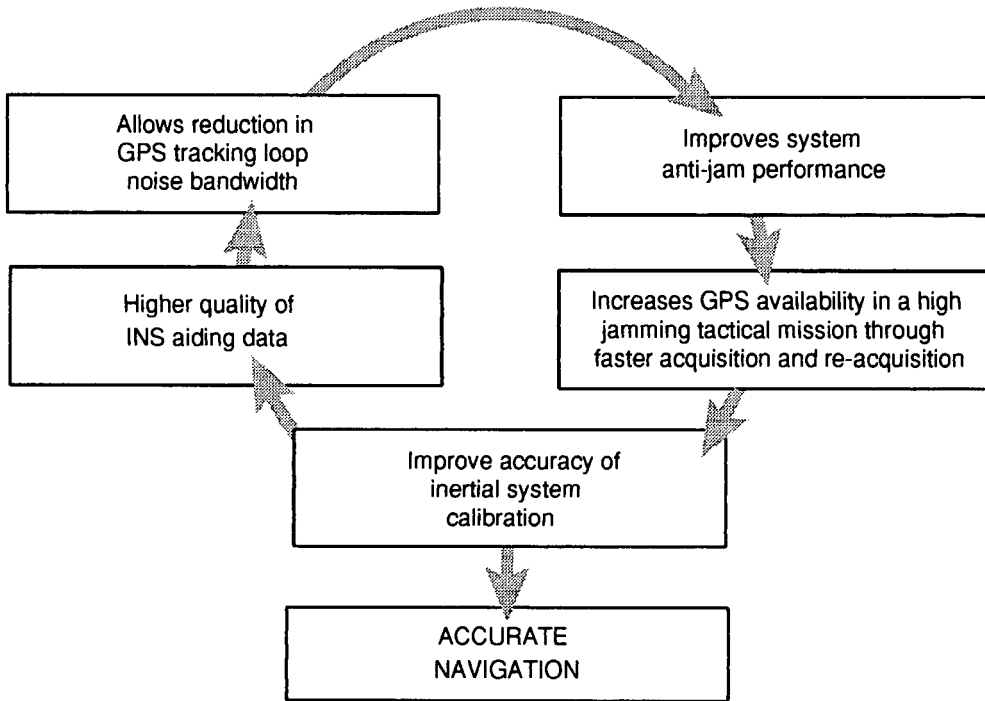

Figure 4.7. The Synergy of GPS/INS Integration

In the tightly coupled approach, shown in Figure 4.9 there is only one Kalman filter. The GPS measurements of pseudorange and deltarange, as derived from the code and carrier tracking loops, are treated as measurement inputs in a single Kalman filter that also includes the INS error states. The measurements are typically processed at a 1 Hz rate. One single, overall optimal filter in the tightly-coupled approach will provide more accurate estimates than two cascaded filters operating at a lower update rate. Incorporating measurements much more frequently will contribute to faster calibration of the inertial sensors.

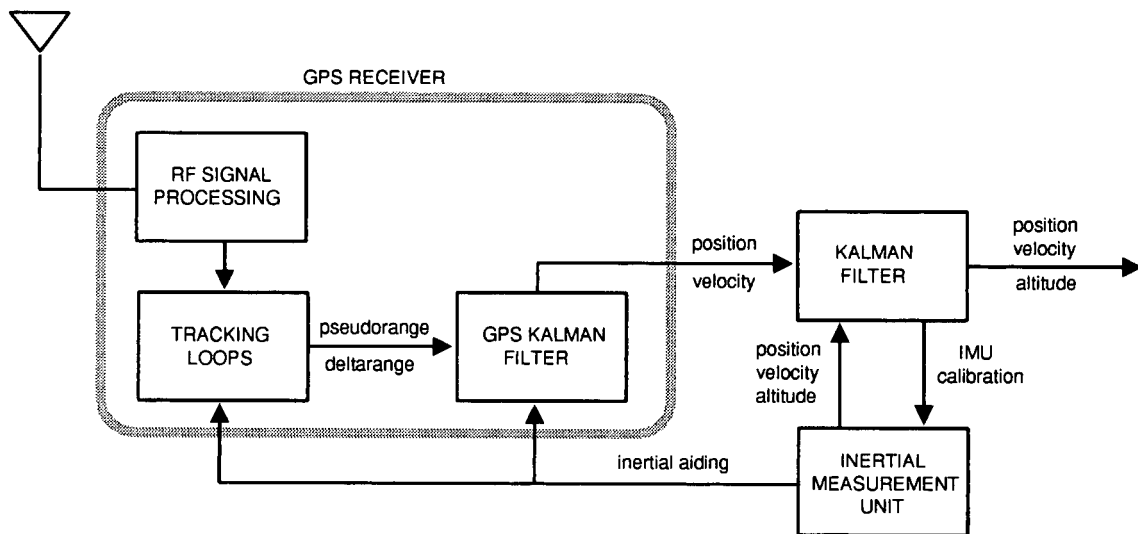

Figure 4.8. Cascaded Filter Approach

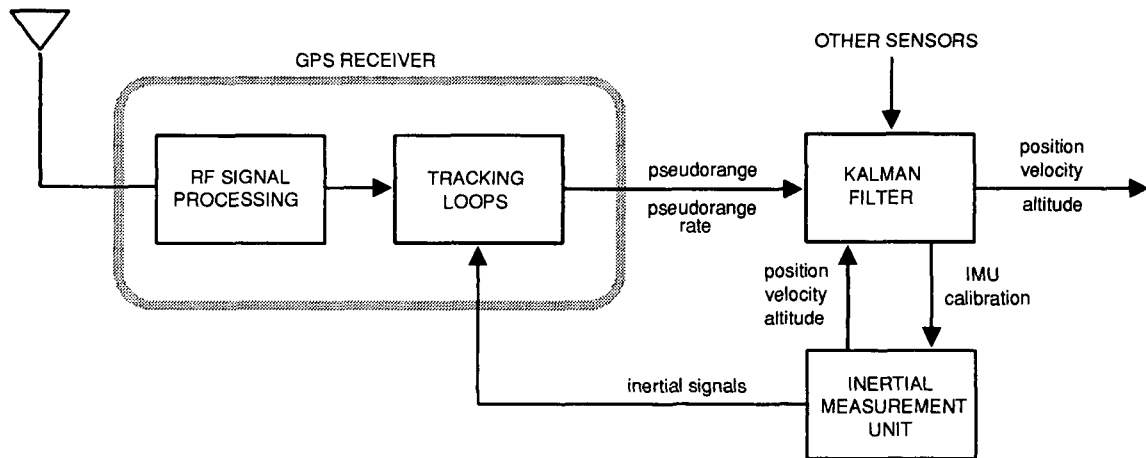

Figure 4.9. Tightly Coupled Approach

Tightly coupled implementations are also more robust against jamming in that the cascaded filter usually cannot provide a GPS update to the inertial system if fewer than four satellites are being tracked by the receiver (the receiver navigation solution degrades and begins to track the inertial system errors). The tightly-coupled system, however, can make use of measurements of pseudo-range from three, two, or just one satellite. This could be extremely beneficial in a jamming scenario especially if large areas of the sky are blanked out by a nulling antenna and only a few satellites are available for tracking.

The trend during the last several decades in the design of multisensor navigation systems has been to use one centralized Kalman filter that uses raw measurement information from all available sensors (e.g. Doppler radar, synthetic aperture radar, GPS receiver, and other sources). Implementation of the tightly-coupled architecture allows for the straightforward inclusion of additional sensors or upgrades of existing sensors. Tightly-coupled systems should be implemented in many applications even in the presence of improved receiver security features that are contemplated, such as GRAM/SAASM*, which may limit the availability of pseudorange and deltarange measurements outside the security boundary of the receiver. In this case, the security boundaries will have to be appropriately defined.

Having now reviewed some of the main issues in GPS aiding of inertial systems, the next section will discuss jamming issues.

4.7.2. GPS/INS Jamming Issues

In designing an integrated GPS/INS, trade-offs must be made between the use of an high accuracy inertial system and the use of a GPS receiver/antenna with high anti-jam (A/J) capability. Most precision guided weapons cannot afford to have both. The trade-offs to be made are a function of the phases of the scenario: GPS satellite acquisition, mid-course, and terminal. The presence of jamming in any of these phases presents a unique problem for that phase.

* GPS Receiver Applications Module/Selective Availability Anti-Spoofing Module (GRAM/SAASM).

Proponents of high-accuracy inertial systems will generally argue that a high A/J GPS is not required while GPS proponents will argue that use of a higher GPS A/J set will substantially reduce inertial system accuracy requirements. The arguments given by both are entirely dependent on the usually ill-defined mission and jamming scenario. However, what has generally become accepted is that the GPS is remarkably vulnerable to jamming during the C/A code acquisition phase where conventional receiver technology has only limited jammer tolerance ($J/S - 25$ dB) (refs. 35, 36). A one watt (ERP) continuous wave (CW) jammer located at 60 nm from the GPS antenna terminals could prevent acquisition of any satellites. A one watt jammer is inexpensive and the size of a hockey puck. Furthermore, the C/A code can be spoofed by an even smaller power jammer. So generally, a GPS receiver cannot be expected to acquire the C/A code in a hostile environment. For long range cruise missile type applications, the C/A code could be acquired outside hostile territory and then the receiver would transition to P(Y) code lock which has about 55 dB of A/J. A 1000 watt (ERP) CW jammer at about 60 nm would now be required to break receiver lock. This is also not a difficult power level for a jammer to achieve. Furthermore, as the weapon approaches the jammer, jammer power levels of about 1 watt would be effective in breaking P(Y) code lock at 10 nm.

The P(Y) code has more anti-jam protection than the C/A code due to its ten-times larger spread spectrum bandwidth. Thus, the current receiver technology during a direct P(Y) code acquisition would have a jammer tolerance of J/S of 29 to 32 dB†. However because the P(Y) code is very long, much time or many correlators would be needed for a two-dimensional search over code timing and Doppler frequency. It would be faster if satellite ephemerides and accurate code timing were available to perform a "hot start." For a GPS aided weapon, accurate timing and satellite position could be transferred from the aircraft to the weapon. However, this transfer normally requires a wide-band data bus and, as yet, few aircraft are so equipped.

As new receiver technology, improved algorithms, and adaptive antenna technology are incorporated into the system, increasing its A/J capability, costs naturally escalate thus making the trade-off space fairly large. It has generally become accepted as reality that in the terminal phase of flight the weapon will probably lose GPS and have to depend on INS-only guidance or the use of a terminal sensor. Thus, it is important to make sure that adequate back-up guidance and navigation capability is provided to meet military mission requirements against adversaries who are able and willing to invest in ECM.

4.8. Communications/Command Links

4.8.1. Typical Current Operation/Limitations

A laser guided bomb uses a target designator to illuminate the target aimpoint allowing the bomb seeker to home on the laser light reflected from the target. The designator contains a camera or FLIR to enable the weapon System Operator (WSO) to see the target area and pick the correct aimpoint. To see the target, the designating aircraft must be within line-of-sight of the target. The light path to the target must be clear of intervening weather, smoke or other obscurants. The designating aircraft must remain in the immediate target area until bomb impact placing that aircraft at risk to the air defenses. This problem can be partially offset by placing the camera or FLIR on the weapon itself. The weapon flies to the target carrying the target sensor with it. It can penetrate the intervening atmosphere reducing the attenuating effects of weather or obscurants. It gets a clearer, better resolved, image of the target as it nears. In fact, when fired from a distance or over an obstacle, the weapon can see the target even when the launch aircraft is hidden from target view. This allows the launch and "designating" aircraft to remain at some distance from the target increasing survivability. In most cases, the communicating system comprising the data link onboard the

† P(Y) on frequency L1 is 3dB lower in signal power than C/A on L1. P(Y) on L2 is 6dB lower than C/A on L1. Hence, the A/J advantage (other things being equal) of P(Y) acquisition over C/A acquisition is 4 to 7 dB.

aircraft is easier to carry and integrate than the full electrooptical designator. Although the weapon costs are increased, the sortie cost may be reduced drastically through reduced attrition.

A data link provides the WSO communications capability to enable accurate, stand-off delivery of television (TV) and infrared (IR) guided weapons. Stand-off ranges and altitude are a function not only of terrain and hostile air defenses, but also of the type of weapon employed. In a lock-on-before-launch mode, the weapon is locked on the target before launch, so that the weapon seeker, while still attached to the aircraft, sends video images directly to the video display in the cockpit. The WSO can locate the target and provide lock-on corrections up to the time that the weapon is launched. After weapon release, the WSO can correct break-lock and refine the desired aimpoint until impact. In a lock-on-after-launch mode, the weapon sends video images and accepts control commands via the data link. The WSO guides the weapon to the target area using en-route checkpoints, by acquiring the target or target area, and may lock-on or manually track the target. The WSO may elect to manually update the lock-on aimpoints or manually steer the weapon to impact.

4.8.2. Improved Data links

In today's countermeasure environment, data links must take on additional characteristics. To control emissions (EMCON) which may be intercepted by the enemy, the data link must use low probability of intercept methods. That is, it must reduce its radiated power so as to make the control and video signal difficult to detect and track. If the signal is intercepted successfully, the information should be encrypted so that the information cannot be used to disrupt weapon control. The decryption equipment must be immune to jamming or spoofing. Due to the video and control commands, the data link signals may have significant bandwidth. By compressing the information to be linked, the system can be made more robust to jamming and covertness. Modern compression algorithms may be needed to trade-off jamming vulnerabilities and system performance. The man-machine interface becomes an important factor in these trades.

4.8.3. Semi-Autonomous Operation

Another option which must be considered for data link operations is the semi-autonomous mode. In a data link system, the WSO is normally assumed to perform all the video interpretation and weapon control. In an autonomous system, the weapon contains the equipment necessary to detect, acquire, and track the appropriate target without human intervention. These systems are becoming more likely with the rapid advances of modern computers. A middle ground is also gaining popularity. That is, the use of a pilot's assistant or some form of Automatic Target Recognition (ATR) to assist the WSO in finding and attacking the target. Such a system might still use a data link, but would contain an ATR device capable of highlighting potential targets to the operator. This reduces the workload but leaves the operator in the decision process with the option of improving over the computer's choices. Such a semi-autonomous system could automatically range from merely assisting the operator by emphasizing target features (such as edges, hot spots, higher cross section, target like appearance, etc.) to actually performing the entire acquisition and tracking process in a full autonomous mode. Such an adaptive capability could adjust for operator workload and situation. It gives the fully autonomous system a backup capability utilizing the data link while providing the operator with assistance when needed.

4.9. Countermeasures & Counter-Countermeasures

This section is concerned with the way in which countermeasures (CM) are deployed and the probable impact on future munitions guidance systems. CM – or in the case of CM designed for RF systems, electronic countermeasures (ECM) – are designed to exploit any sensitivities of munitions' guidance equipment. The development of new sensors and new signal processing systems for munitions involve the complementary development of new countermeasures and therefore new counter-countermeasures (CCM or ECCM) in a continuing spiral. Some of the many forms of countermeasure are listed in Appendix C.

4.9.1. Countermeasures Deployment

The main threat to an aircraft comes from EM and EO missiles, against which three different types of countermeasure tactics are employed:

- self protection of the aircraft which carries its own ECM.
- Mutual support jamming which involves more than one platform which may operate their jamming together to obtain improved overall protection.
- Jamming aircraft serving the role of a stand-off jammer, flying at a safe distance outside the missile engagement zone.

The development of self protect countermeasures ranges from single simple countermeasures all the way up to a comprehensive ECM suite including on-board jammer, chaff, decoy and a Radar Homing and Warning Receiver (RHWR). The aircraft can operate or deploy its ECM individually or in any combination at any time during its trajectory.

The CM and CCM of interest in relation to guidance seekers include systems designed to counter active and semi-active CMW radar, MMW radar, passive infrared, and semi-active laser guidance systems. The following is a brief review of some of the most commonly employed CM.

4.9.2. Radar Countermeasures

The simplest and oldest form of CM against CMW radar is chaff, originally developed in World War II, directly deployed from the target. It consists of large quantities of strips made from radar reflecting materials which present a large false target to confuse the seeker or mask the real target. Chaff, although effective, is transient in its effect due to rapid dispersion of the chaff cloud after deployment, and requires either repeated deployment or accurate response to an immediate threat. Chaff deployed from aircraft is also countered by accurate seeker doppler discrimination due to the rapid deceleration of the chaff cloud.

The more sophisticated and expensive active CM fall into two categories; noise jammers, and deceptive jammers, both of which exist in great variety. The basic objective of noise jammers is to prevent operation of the seeker by broadcasting high power radiation which masks or swamps the seeker's own signals. Seeker home-on-jam capability effectively precludes noise jamming for self protection. Typical forms of noise jamming are:

- Spot noise, which concentrates noise, and therefore power, across a narrow band of frequencies. It can be countered by frequency agility or spread spectrum techniques.
- Barrage noise, which is broadcast over a wide range of frequencies and is therefore more difficult to counter than spot noise but requires much more power and therefore can be countered by higher power guidance illumination and/or advanced signal processing techniques to improve signal : noise discrimination.
- Swept noise, across a wide range of frequencies which combine the power output of spot jamming with the frequency coverage of barrage jammers, albeit intermittently. Against frequency agile seekers the probability of coincidence of frequencies renders the technique ineffective.

In contrast to noise jamming, deceptive jammers seek to degrade performance by broadcasting low power signals which adversely modify seeker functions without necessarily preventing it from operating. They include for example:

- velocity gate and range gate stealers; coherent repeater type jammers which send signals mimicking the seeker's signal with a shift of frequency or time interval respectively to confuse the seeker. Their effectiveness is also degraded by frequency agility which imposes severe RWHR/ECM signal processing requirements.
- multiple source jammers: to degrade the accuracy of angle tracking, for example by cross-eye jamming to produce a bias in the receiver, or by glint enhancement jamming. The technique is intended as a self-protect measure but is subject to the same vulnerability to frequency-agile seekers as other forms of jamming.

Other forms of deceptive jammer are listed in Appendix D. Radar decoys are a further important type of CM. They can at the simplest consist simply of ballistic chaff dispensers, or can employ the whole range of techniques, including noise or deceptive jammers.

- Decoys may be deployed from ships, aircraft or land vehicles in response to a perceived immediate threat. They may be carried by rockets, parachute retarded devices, or simply dropped from aircraft. Multi-spectral seekers provide an effective CCM.
- Decoys towed behind the target vehicle provide continuous protection. Towed decoys, though inconvenient (particularly for aircraft (whose freedom of manoeuvre may be impaired)) can be extremely effective against CMW seekers which may not achieve sufficient angular discrimination between decoy and target until too late in the terminal homing phase – if at all. Dual-mode seekers with high resolution MMW, IR or IIR terminal mode provide an effective CCM though at the cost of still further munition complexity.

Many of the above RF countermeasures are similarly effective against radio navigation systems such as GPS.

4.9.3. Electro-optical Countermeasures

EO countermeasures are generally quite distinct from radar countermeasures, with the possible exception of high power microwaves which are potentially effective against all types of seeker. Passive EO CM range from CCD (camouflage, concealment and deception) to a variety of types of decoy.

- CCD measures include the simplest forms of concealment, such as camouflage paint, nets, foliage, obscurants and smoke such as carbon fibre, aluminized glass, nickel, or carbon, plus obscurant or smoke grenades (burning oil drums can also provide a decoy effect from the bright source of the flames). They all suffer from the disadvantages of being difficult to apply to large or mobile targets and of not being effective at all wavelengths.
- Decoys tend to be most effective against "hot spot" tracking IR seekers. They include aircraft-deployed flares, fires, and other deliberate or naturally-occurring battlefield sources of radiation. They are readily countered by IIR seekers.

Active CM are most effective against active or semi-active seekers where illumination of the target gives scope for identification of the seeker's signal processes and allows the broadcast of appropriate disruptive signals. They include:

- Laser Damage CM include high power illumination of the seeker to dazzle or destroy the seeker, operating either outside the pass band of the seeker or inside (for maximum effect). They require accurate tracking and co-location of laser CM and target. Against in-band laser CM it is possible to introduce a range of different bandpass optical filters as part of the manufacturing process. Other possible CM include

- Modulation Jamming by emission of signals at or near the scan frequency of modulated passive EO seekers (e.g. scanning reticle IR hot spot trackers) which include most IR guided AAM to date. The more modern IIR seekers are more or less immune to this type of jammer.
- In this category can also be included modulated jamming of semi-active laser seekers, which can be countered by pulse coding of illuminator and receiver. The CCM requires cooperation between seeker and illuminator source which, if remote, may compromise security of the code.

4.9.4. Anti-Missile Missiles

Though not generally included in the term countermeasures, the importance of anti-missile missile defence is an important issue which is increasingly affecting the design of high-value conventional cruise missiles. The reduction of missile signature along the lines of manned aircraft is a natural development, although the design compromises involved may be even more severe in relative terms, because of cost and logistics penalties due to departure from the generally simple structures of munitions. Seeker signature reduction, whether radar or EO, is a particularly difficult problem which tends to emphasise the importance of non-seeker options.

4.10. Chapter Four Overview

From the foregoing review of technology, it seems that major benefits in terms of munition costs and/or performance can be expected from present and future advances in areas such as micro-miniaturization, on-board signal and data processing, and navigation techniques. In most cases these benefits are likely to appear in the form of progressive improvements and upgrades of existing munitions or the replacement of existing types that have reached the end of their useful life: in some cases however, the effect of innovative developments, such as micro-mechanical sensors and small low-cost GPS/INS, make it possible to envisage more radical changes, in the form of new kinds of munition or military capability. These ideas are elaborated in Chapter 6.

Chapter 4 References

1. Introduction to Sensor System, S.A. Hovamessian, Artech House Press, 1988.
2. The effect of Common Process Noise on the Two Sensor Fused-Track Covariance, Y. Bar-Shalom & L. Campo. IEEE Trans. AES July 1987, p. 803.
3. An Approach to Multi-Sensor Integration Problem, D.L. Alpaugh, Proc. EASCON, September 1983, p. 149.
4. Data Fusion and Decision Support for Command and Control, E.L. Wertz & D.M. Buede, IEEE Trans. Systems, Man and Cybernetics, Nov. Dec. 1986, p. 865.
5. Neural Networks for Pattern Recognition SC Kothari & H. Oh, Advances in Computers, Vol. 37, p. 119.
6. Principles of Neurodynamics, F. Rosenblatt, Spartan Books 1962.
7. Adaptive Pattern Recognition and Neural Networks, Y. Pao, Addison - Wesley, 1989.
8. On the Convergence Properties of the Hopfield Model, J. Bruck, Proc IEEE 78 (10), p. 1579.

9. Optical Bidirectional Associative Memories, B. Kosko, Proc. SPIE 758, No 11.
10. Neocognitron; A. hierarchical neural network capable of visual pattern recognition, K. Fukushima, Neural Networks 1 (2), p. 119.
11. A Learning Algorithm for Boltzman Machines, D.H. Ackley a al, Cognitive Science 9, p. 147.
12. A logical calculus of the ideas immanent in nervous activity, W.S. McCulloch & W. Pitts, Bulletin of Mathematical Biophysics, 1913, No 5, p. 461.
13. Learning Patterns and Patterns sequences by self-organizing nets of threshold elements S. Amari, IEEE Trans. Comp., C-21, 1972, p. 1197.
14. The Logic of Learning: A Basis for Pattern Recognition and for Improvement of Performance, R.B. Banerji, Advances in Computers, Vol 24, 1985, Vol. 24, P. 177.
15. Digital Image Processing, R.C. Gonzales & R.E. woods, Addison Wesley, 1992.
16. Combined Wavelets – DCT Image Compression – A.C. ansari, L. Gertner, Y.Y. Zeevi, SPIE Vol. 1699 (1992) p. 308.
17. Wavelets and Signal Processing, IEEE Signal Processing Vol. 8, No. 4, October 1991, p. 14.
18. Special Issue on Wavelets and Signal Processing, IEEE Transactions on Signal Processing, Vol.41, No. 12, December 1993.
19. Wavelets give rise to a flood of images, New Electronics, July 1994 p. 12.
20. Computational Algorithms For Discrete Wavelet Transform Using Fixed Size Filter Matrices – A.Z. Baraniccki and S.O. Karism SPIE Vol. 1699 (1992) p. 408.
21. Image Algebra in a Nutshell, G.X. Ritter and J.N. Wilson, IEEE 1987 CII2465-3/87 p. 641.
22. Image Algebra and Automatic Shape Recognition, T.R. Crimmins and W.M. Brown, IEEE Transactions on Aerospace and Electronic Systems, Vol. AES-21, No. 1, January 1985.
23. Digital Image Processing, R.C. Gonzalez and R.E. Woods, Addison WESLEY, Section 8.4.
24. From Circuit Theory to system Theory, L.A. Zadeh, Proc. Inst. Radio Engineers, No 50, p. 856, 1962.
25. Fuzzy Sets and their Applications to Artificial Intelligence, A. Kandel & M. Schneider, Advances in Computers, Vol. 28, p. 69, 1989.
26. Reusable Software Components, B.W. WEIDE & al., Advances in Computers, Vol. 32, p. 1, 1991.
27. Inertial Instruments: Where to Now? Barbour, Elwell, Schmidt, Setterlund, Draper Laboratory Report, Cambridge, MA., May 1994. Presented at the 1st International Conference on Gyroscopic Technology, Elektropribor Institute, St. Petersburg, Russia, May 1994.
28. Emerging Low(er) Cost Inertial Sensors, Barbour, Kumar, Elwell, Draper Laboratory Report P-3399, Cambridge, MA, July 1994. Presented at the 22nd Joint Services Data Exchange, Scottsdale, AZ, October 1994.

29. INS/GPS Operational Concept Demonstration (OCD) High Gear Program, S. Snyder, et.al., IEEE PLANS Conference, April 1994, pp. 292–297.
30. The Global Positioning System – A Shared National Asset, National Research Council, National Academy Press, 1995.
31. Navigation Message Correction Tables: A Proposal, J. Butts, C. Shank, ION National Technical Meeting, January 1995 pp. 97–103
32. Navigation Message Correction Tables: On Orbit Results, B. Brottland, C. Harris, ION 51st Annual Meeting, June, 1995, pp. 413–420.
33. Exploitation of Differential GPS for Guidance Enhancement (EDGE) High Gear Program, J. Dargen, et.al., NATO/AGARD MSP Meeting, Technologies for Precision Air Strike Operations in Rapid Reaction and Localized Conflict Scenarios, Seville, Spain, October 1995.
34. Navigation Performance Analysis for the EDGE Program, D. Kelly, et.al., NATO/AGARD MSP Meeting, Technologies for Precision Air Strike Operations in Rapid Reaction and Localized Conflict Scenarios, Seville, Spain, October 1995.
35. NAVSTAR GPS User Equipment, NAVSTAR–GPS Joint Program Office, February 1991.
36. Analysis of Differential Global Positioning System (DGPS) Techniques and GPS Jamming on Precision Guided Munition (PGM) Performance, S. Mahmood, et.al., NATO/AGARD MSP Meeting Technologies for Precision Air Strike Operations in Rapid Reaction and Localized Conflict Scenarios, Seville, Spain, October 1995.

CHAPTER 5. USER CONCERNS

This chapter discusses a number of issues that are of concern to military users, and their interaction with terminal guidance technology. Unlike Chapter 4, which focused on specific areas of guidance technology, the present chapter takes a broader view which also recognizes that many of the problems of concern to the User are unlikely to be solved by technological solutions alone and generally not by any single area of technology.

5.1. Mission planning

5.1.1. Mission Planning for Conventional Weapon Terminal Guidance

Planning for modern warfare has resulted in the identification of needed improvements in the performance of conventional (non-nuclear) air-to-surface weapons for attacking high-value, fixed targets. Improvements identified include the need to increase mission flexibility, reduce aircrew workload and improve mission effectiveness. To date, missions for high-value, fixed targets have generally been accomplished with weapon systems that require manual control after launch. For these weapons, operator intervention is necessary to (a) achieve proper guidance to the target area, (b) acquire and track ("lock-on") the target and (c) perform precision, terminal homing manoeuvres to impact the desired aimpoint.

To overcome some of the shortfalls of manually guided weapons, emphasis has been placed on developing weapons which can attack a variety of targets by automatically performing guidance, target acquisition, and precision terminal homing. Such "launch-and-leave" weapons are being designed to provide an autonomous, all-weather, "near-zero CEP" capability without requiring any operator intervention after launch.

Development of autonomous, precision guided weapons has concentrated heavily on designs that use a precision, forward-looking, imaging sensor performing correlation of the sensor image with a preplanned and stored model of the target and target area. Contrast differences in the image are used to identify target area features which are subsequently used for correlation with the stored model. The stored model, known as a target reference "template" generally consists of data describing "wire frame" models of the various features (including the target) in the target area. Templates include data for object locations, dimensions (length, width, height), orientation, and material type. The actual data necessary to adequately describe the target area is highly dependent on the type of sensor and the particular signal processing techniques and algorithms that each sensor uses to (a) process the image, (b) perform correlation with the stored template, (c) achieve target acquisition/tracking and (d) perform precision, terminal homing. Templates may be represented in two or three dimensions depending on the chosen correlation techniques. In general, templates are not developed for every object that is expected to be imaged. Typically, objects are chosen that can be readily modeled with graphic "primitives". The specific objects chosen for template generation are selected to produce a high probability of achieving a strong and unique correlation for the expected weapon trajectory and its associated guidance error and approach axis geometry. The precision of the weapon impact is achieved by guiding to the aimpoint whose position (relative to the correlation objects) is known to a high degree of accuracy.

Although sensor algorithms are considered "company proprietary" by weapon developers, they must of necessity be designed around properties of the particular sensor technology. To date, most of the work in developing sensors for precision guided, autonomous weapons has been with a limited number of sensor types. In particular, SAR (synthetic aperture radar), ladar (laser radar) and I²R (imaging infrared) have received the bulk of development efforts primarily due to their ability to form a high resolution image suitable for achieving aimpoint position measurement accuracies on the order of 3 metres. The following brief discussions address some of the key sensor characteristics and parameters that must be considered in developing suitable target templates.

SAR systems are active, "side-looking", radar sensors which typically operate in the centimetre wave band and develop a high resolution image by synthesizing the effect of a narrow beam, large aperture sensor using extensive processing of the signal returns in range and doppler. Intensities (and contrast) in SAR imagery are not only dependent on sensor parameters (such as frequency and polarization) but they are also dependent on the viewing geometry, dielectric properties of objects, object geometry and object surface roughness. Consequently, in addition to dimensional and position data, reliable information and data is needed for material types (including man-made and natural), surface roughness and slopes. Since the wavelengths chosen for SAR sensors are long relative to the size of atmospheric particles, the effects of fog, rain, and clouds do not significantly degrade image quality. Thus, weather data is of little importance in developing templates for SAR sensors.

Ladar sensors use an active transmitter to develop a highly collimated, precision beam. Operating on the same principle as a pulse radar, ladar sensors explicitly measure the range to points in the target scene as the beam is scanned over the target area. A three dimensional image of the scene is obtained by scanning the beam in two dimensions and recording the range data for each "position" of the scanned beam. The resulting image is in angle/angle/range coordinates and can be of high resolution. An intensity (reflectance) image may also be generated by recording the values of the received reflections for each resolved beam position (pixel). Depending on the particular properties of the ladar image chosen for exploitation, the primary data required for generation of target templates include object geometry (length, width, height), orientations, slopes and positions. If the reflectance image is used, then reliable data and information on object material types may be needed to predict scene contrast. Since atmospheric attenuation can be significant at ladar wavelengths, weather data is needed to predict ranges where images of sufficient contrast can be formed and reliable target acquisition is achieved.

I²R sensors are passive sensors that receive naturally emitted or reflected infrared energy from objects in the scene. Generally, an image is formed by scanning (in two dimensions) a set of detector elements which convert the collected radiation into electrical signals that are quantized and subsequently processed with digital processors. At any given instant, each detector element images only a narrow solid angular portion of the scene due to the design of the scanning mechanism and associated optics. The resulting two dimensional image is in azimuth and elevation coordinates with an intensity value for each resolved position (pixel). Changes in intensity of the image as the detectors are scanned across the target area scene are primarily due to changes in surface reflectance, incident radiation, emissivity and temperature of the objects imaged. Data requirements for generation of reference templates include object dimensions, locations, orientation and material types. Although I²R sensors can only exploit two dimensional data, three dimensional information of the target area is needed to determine the additional dimensional projections of objects within the target area. Since I²R sensors detect infrared energy, scene contrast is highly dependent on the thermal properties of the target area and atmospheric absorption between the sensor and target area line-of-sight. Consequently, data on ambient temperature, wind conditions, sun orientation, time of day, weather conditions and object material types are critically important in predicting scene contrast and developing reference templates for a given mission.

5.1.2. General Considerations for Target Templates

In addition to sensor specific properties that influence the development of target reference templates, additional factors that are generally independent of the sensor type must be considered when planning for a specific mission. Such factors include:

Obscuration: Target areas typically contain several objects with various heights and locations. Consequently, since the weapon sensor must "see" the objects chosen for correlation, care must be taken to assure that the sensor will have a clear line of sight to the correlation objects during the weapon's flight. Also, since the weapon must be able to impact a selected aimpoint, template preparation must consider the planned weapon attack geometry.

Uniqueness: Due to the complexity of target areas, several objects similar in shape and size may appear in the sensor's field of view. Target templates must be prepared to insure that the sensor does not achieve a "false fix" on background objects or other "clutter" objects. During mission planning and template preparation, the weapon's flight path and attack geometry must be considered when selecting objects for correlation since "clutter" objects can move into and out of the sensor's field-of-view during weapon flight.

Offset Aimpoint: In many cases, the actual target may be obscured during the weapon's flight or the target may not have distinct features suitable for modeling and correlation. In those cases, template preparation must be based on objects that are located away from the target aimpoint. Offset aimpoints must also be used if multiple weapons attack, the same target since template correlation must be insensitive to the effects of weapon impact and blast.

5.1.3. Template Preparation

Preparation of target templates is typically performed on a computer workstation which has custom software programs designed by the sensor developer to guide and direct the template preparation process. In response to prompts and queries, the operator enters mission parameters (target aimpoint, attack azimuth, desired terminal impact conditions, time-of-day, weather, etc.) as well as object data (dimensions, location, orientation, material type). Once all data is entered, the software performs appropriate processing to define, format and store the resulting template data. Additional steps may be required to render the templates for operator viewing, analysis and quality checks. After the process is completed, the software can perform a validation process that computes figures-of-merit for the particular template. Such figures-of-merit may include probability of acquisition and probability of false fix. Upon final verification/validation, the template data is combined with other mission planning data and stored for subsequent transfer to the weapon.

Although the template preparation process is similar for each sensor type, the specific techniques and steps may vary widely. In some cases, workstations may be designed to extract template data directly from stored imagery. In other cases, data must be entered manually by the operator. Also, to prepare an accurate template, some processes may require the operator to be knowledgeable of the particular sensor's characteristics.

Much work is being done to reduce the template preparation time and complexity. The use of "expert systems," graphical user interfaces, and image processing techniques are being combined to speed up the process, reduce required operator skill levels, and improve the robustness and accuracy of the resulting templates.

5.1.4. Target Data for Autonomous Precision Guided Weapons

Considerable data is needed to prepare target templates. Although the exact data is dependent on each sensor and its associated signal processing algorithms, experience to date shows that high resolution stereo imagery is the only practical source for data that can be used to produce reliable and accurate templates. Even data from stereo imagery must be supplemented with other information such as weather and material types. Based on work done by the USAF, table 5.1 is representative of "generic" target data that could be used for preparation of reference templates for SAR, ladar and I²R sensors:

As can be seen from Table 5.1, the requirements for target data can be severe for complex target areas which have numerous man-made objects and natural features. Also, template preparation can be very time consuming and tedious if the operator has to mensurate object dimensions and locations using "hard copy" imagery. In order to prepare reliable templates in reasonable times, digital image processing on high performance computer workstations will have to be used to streamline and facilitate the target data extraction process.

Table 5.1. Target Data for Reference Templates

Visible Spectrum Imagery

- At least one vertical image (0-15 degrees off nadir)
- At least one oblique image (30-60 degrees off nadir)
- 300 metre radius of coverage (from target) for all images
- One high altitude image with a 5 nautical mile (9 km) radius of coverage

Control Points

- One reference point geopositioned within 30 metres horizontal and vertical accuracy at 90% confidence.
- No less than 4 control points with point-to-point horizontal accuracy of at least 3 metres, 90% confidence (relative to the reference point).
- All control points clearly identifiable.
- One control point to be located near the center of the target area and all remaining control points positioned to bound the target area.

North Arrow

- One North Arrow on each image, oriented within 3 degrees of true north.
- North Arrow placed and divided so that each end is at an opposite edge of the image and the image center is not obscured.

Object Mensuration

- All man-made objects larger than 300 square metres and located within the 300 metre radius shall be mensurated to an accuracy of 1 metre in length, 1 metre in width and 2 metres in height at a 90 percent confidence

Natural Features Location

- A best estimate of height for all natural features (i.e., tree line) within a 100 metre radius of the target.

Material Identification

- A coarse (i.e. concrete, grass, dirt, metal, wood) material identification for all targets larger than 300 square metres that are within the 300 metre target area radius.

5.1.5. Automatic Feature Extraction and Template Generation

Due to the difficulties and resulting extended times experienced in preparation of target templates, work has been done to determine if appropriate feature data can be automatically extracted from various sources and stored in a "generic" database that could support template preparation for a variety of sensors. This work was accomplished by using a variety of digital image processing techniques operating in various combinations. To date, results show that automatic feature extraction, suitable to support the preparation of reliable target templates, is beyond the state-of-the-art. However, this work indicates that with improved processing hardware (large capacity hard disks, high speed processors, large amounts of high speed memory) and software (improved image processing algorithms, graphical user interface), a semi-automated process using high resolution digital stereo imagery has the potential to significantly decrease the time to extract appropriate target data while maintaining the required quality and accuracy. To support this process, source imagery must be of high quality in terms of resolution, contrast, and accuracy of supporting data (camera models and geopositioned control points). It is envisaged that an "all digital" system would be configured so that an operator could graphically select and mensurate the various features by a "point and click" operation. Data extraction would be performed automatically by the computer, and transferred to sensor template generation software which would process and format the data. After processing, the templates could be displayed for operator viewing and editing (if necessary) prior to the validation process. Upon validation, the resulting templates would then be stored for subsequent loading into the weapon sensor.

5.2. Identification of Friend or Foe (IFF)

5.2.1. Desert Storm Experience

The Persian Gulf War brought attention to an old problem: fratricide, or "friendly fire" – that is, casualties from friendly weapons inadvertently fired at friendly personnel. Nearly a quarter of all combat fatalities in the war were caused by friendly fire. This proportion seemed much higher than in previous wars and caused a sudden focus on avoiding fratricide in future wars. World War II and Vietnam War estimates of the proportion of fratricide to total casualties were substantially lower, though total casualties were much higher. The public is becoming increasingly sensitive to the human costs of military involvement, especially for conflicts where national survival is not in question. Fratricide has a compounding effect on combat effectiveness: weapons aimed at friends are not aimed at the enemy; and friends killed by friends are not able to fight the enemy. The psychological effects of friendly fire are always greater than from enemy fire. This Desert Storm experience suggests that fratricide may be a relatively greater cause of casualties in future conflicts. Although eliminating fratricide is not possible, reducing it is highly desirable.

Fratricide has a multiplicity of causes, including: faulty navigation; poor communication, command, and planning; lack of fire discipline; and occasional malfunctioning equipment. But outstanding among the many causes is misidentification. Identification techniques can be roughly divided between cooperative and non-cooperative approaches. Cooperative techniques can provide positive identification of friends, with a lack of response indicating an unknown. Non-cooperative techniques must identify the foes among the unknowns. The technology for avoiding fratricide of land surface targets lags behind the technology important to avoiding aircraft fratricide. IFF systems, developed for aircraft during World War II, are only now being developed for land combat vehicles. Whatever systems are developed, coordination among the services and international allies is essential.

5.2.2. Non-Cooperative IFF

Target attack consists of a sequence of steps culminating in target destruction or neutralisation. It begins with object detection. The object must then be classified according to whether the object is a target-like object or merely natural surroundings which mimic target characteristics. Further classification separates the general target class into more specific classes ultimately leading to an identification of an enemy class.

Further decisions may be required to determine whether the target is hostile or if the attack would be effective, depending on the rules of engagement.

Precision guided munitions and their associated fire control systems will play an important role in avoiding fratricide through the use of their advanced sensors. These sensors which directly gather target information may, in some circumstances, provide the necessary friend or foe determination. Although it is highly contentious that one might fire a weapon at an unknown, the weapon itself has a unique ability to gather target information due to its short relative range to the target. That is, the weapon can gather data while guiding to the target. When sufficiently close, the weapon can discern friend or foe and divert if positive confirmation is not achieved. This has an increased weapon cost but allows firing prior to fully completing the IFF process.

Noncooperative identification can be as simple as visual identification or passive interception of radio and radar transmissions. It may be possible to induce enemy targets to transmit by sending false communications requiring answers or causing defensive radiation or communication. Many features may be used for noncooperative IFF including shape, colour, and reflectivity. More complex signatures, such as polarimetric properties, vibration (such as engine modulation), glint characteristics, and shape properties might be available to active probes of the target. High resolution radar may derive sufficient shape resolution to distinguish between target types. Such shape resolution might, for example, be an effective ship discriminant. However, in other applications, shape may not be a useful discriminating feature – for example, the F-15 and the Su-25 have strong physical similarities, or friend and foe may be flying the same aircraft, as may well be the case in future conflicts. Some existing electro-optical sensors use precise spectral techniques to determine plume spectra and thus fuel mixes. Antiradiation homing seekers can identify the target's emissions, including frequency and modulation waveforms.

5.2.3. Collateral Damage

The question of collateral damage has become a sensitive issue, largely because of the experience of Desert Storm when television cameras were trained on targets to beam images of destruction in real-time to audiences throughout the world. Such rapid and global visibility makes the art of war increasingly subject to political action and reaction. It is becoming increasingly unacceptable for even small percentages of weapons to miss their intended targets and kill innocent people. An extension of the friendly fire or fratricide problem, it forces the designer to consider designs to minimise collateral damage. Clearly, ongoing improvements in precision, adverse weather operation, target recognition, and warhead control will make future systems far superior to "iron bombs." However, political pressures may cause consideration of more drastic means. For example, a weapon which failed to lock on to a confirmed target could be directed to airburst at altitude in order to reduce danger to those on the ground. Alternatively, the fuze could be disabled, although the missile's kinetic energy and the possibility of explosion on impact would still present a significant hazard, or the missile could be redirected to a pre-defined "safe" area. The latter course of action would however reduce the weapon's effective range due to the reserve of energy required for the evasive manoeuvre. Other more exotic means may be possible, at the expense of other weapon features; the extent to which these might become enshrined in Operational Requirements being as much a political as a technical issue.

5.3. Battle Damage Assessment (BDA)

5.3.1. Statement of Need and Current Capability

During Desert Storm, pilots and weapon systems operators were able to confirm weapon effects visually. This "eyes-on-target" facilitated real-time battle damage assessment (BDA). Even at night, high resolution FLIRs allowed clear identification of the target under attack. When using PAVEWAY or GBU-15 type weapons, a video tape of the weapon video or associated targeting pod provided evidence of the attack for further analysis.

BDA can be broken up into several distinct phases. The first requirement is to locate the point of weapon impact. This is accomplished by confirming the identity of the target as seen by the pilot directly, or in the targeting sensor, or from the weapon sensor radio-linked back to the controlling aircraft. Once target location is confirmed, weapon fuzing and detonation must be verified. Again, in the case of direct viewing or targeting systems, weapon detonation can be visually verified. However, when the target sensor is on the weapon, and the target is beyond pilot visual range, detonation may not be verified without independent surveillance. Next, information on actual target damage caused by the weapon detonation is desired. In the case of buried bunkers, there may be no visual clue to indicate the extent of target damage. In fact, in some cases, external views of the target may not be sufficient to verify target effect. Ultimately, the success of any single mission has to be judged in the context of a more complex set of goals than the mission itself. For example, destroying a bridge might not necessarily prevent tanks from crossing the river. Thus, verification of successful mission accomplishment places a greater burden on the reconnaissance system.

5.3.2. BDA Issues of Autonomous Weapons

Of particular concern is the ability to perform BDA for autonomous weapons. Future weapon systems will make greater use of lock-after-launch seekers capable of recognizing and tracking targets by use of automatic target recognizers. Cruise missiles serve as a current example of this but many more tactical weapons will operate autonomously in the future. This compounds the BDA problems because the warhead impact occurs beyond visual range of the launch system and thus all BDA must be accomplished independently. It is possible to incorporate radio links to transmit target data derived from on-board sensors for analysis and BDA (or at least impact location) either for the missile itself or even of adjacent missiles (in this context, it is interesting to note the plans to equip Tomahawk Block IV with data link equipment). For example, terminal guidance seeker outputs (preferably processed and/or video compressed) or Global Positioning System (GPS) data could be transmitted to a recorder located well behind the launch point. A more extreme suggestion would be to carry a low cost camera on a tether behind the weapon to record and transmit the bomb impact. The expense of integral weapon BDA would have to be offset against the cost and availability of other reconnaissance means for determining BDA.

5.4. Cost - Schedule

5.4.1. Development Time and Associated Cost

Precision guided munition programs, as other military item programs, are made of several phases:

- Upstream studies,
- Advanced development,
- Development,
- Industrialization,
- Production,
- Utilization.

Typical timespans for such programs are forty to fifty years, of which twenty or thirty years can be taken up in research, advanced development and evaluation, and final development and industrialization; while fabrication and utilization in the armed forces can extend over fifteen to twenty-five years. Until now this lengthy period of time has been necessary to ensure the technology is mature and will have a reasonable probability of achieving its anticipated capabilities – based as it is on entirely new, and purely military, design elements. The useful life of a munition design has generally been long enough to warrant waiting

another generation: after all, most of the munitions employed in Desert Storm were derived from designs more than a decade old.

Consequently the magnitude of the costs associated with developing a modern seeker with its signal and data processing is in the range of \$50-100 million. The unit production cost may be up to 100 k\$ for an IR seeker and more than 200 K\$ for a radar seeker.

5.4.2. Programmatic Approaches

Some ways to reduce both development costs and unit production costs might be: to share costs with other programmes, to increase production series and rates by common/modular designs, and/or to buy components (especially standard commercial items) off-the-shelf.

Joint Programmes

The following two kinds of cooperative development have been tried in the past with varying degrees of success:

- Cooperative procurement of a nationally-developed munition initiated by national military staffs. Joint programs allow the sharing of developmental costs and the benefits of higher production quantities and rates. This approach is limited by lack of common military requirements and timescales and the desire for national off-set agreements.
- Cooperative development work-sharing between countries. The same gains can be achieved as above but because of the multiplication of decision-making, such international programs are hard to manage. Past successes include Roland and Hot munitions. The many failures include Modular Stand Off Weapon (MSOW) and Multiple Launch Rocket System (MLRS) Phase 3.

To the above might be added two commercially-orientated approaches, in line with a growing trend of national governments to achieve better value for money by competitive procurement of military equipment:

- National procurement of other nation's existing munitions. Similar to the first approach above, it avoids the necessity of prior international agreement. Sidewinder AIM-9 is an outstanding example. It too depends on national military requirements being met, though timescale is no longer such a great issue.
- National development based on international cooperation by Industry. The Advanced Short Range Air-to-Air Missile (ASRAAM) is a current example. The advantages of this approach are that the most cost-effective subsystems/components can be incorporated, unhindered by national work-share considerations.

The question of national off-sets within Nato is particularly thorny. If off-sets were purely an economic issue there would be little justification for national governments to pursue dubious protectionist policies that have been almost universally rejected by economists as counter-productive. The reason lies rather in the perceived need of national governments to retain a defence technology base, and avoid dependence on foreign suppliers – however friendly – for reasons of long-term national security.

Modular Components, Standard Components

High operational effectiveness requires the kill probability of precision guided munitions to be very high, typically 90%. To achieve these values the munitions must be tailored to take account of the numerous scenarios of target interception or strike, and the specifics of target and target environment. Moreover, each nation individually develops relatively few seekers, and components cannot generally be used in two

seekers developed in the same time frame because of the specificity of the requirements, still less used for successive generations of seeker (because of obsolescence). The foregoing factors tend to limit the usefulness of modularity or standardisation of components within any one nations' programmes. Nevertheless, if the total requirements of all Nato nations' development programmes were taken into consideration, useful standardisation of seekers or components of seekers within different national munitions might be possible. The capabilities most amenable to this approach would seem to be:

- high resolution, miniaturized thermal imagers;
- electronically-scanned millimeter wave radars;
- miniaturised laser radars.

The philosophy could be extended to embrace the complete range of munitions' subsystems and components, including propulsion units, control actuators, data/command link equipment and so on. The required high probability of target intercept or strike would be achieved by a mix of such components instead of by highly specialised and sophisticated custom design. Modular components could also ease technological updating to meet changes in military requirements, which are tending to increase in frequency as battlefield needs develop unpredictably.

Though having some superficial similarities to the MSOW international project, the above approach would avoid the extremely difficult problem of harmonizing requirements and timescales required by the wholly top-down process of MSOW. International agreement on subsystems and components requirements would not only be far easier than for a complete munition system, it could also provide opportunities for competitive development and manufacture, and for individual nations to customize their systems whilst retaining a high degree of Nato interoperability and interchangeability. The first step in this process would be to establish internationally agreed interface standards and protocols.

The successful development of the US GBU-28 during the Gulf War (see also section 6.4) provides an example of the very rapid design and development cycle possible when suitable components exist and can be backed up with available software tools in the form of mathematical models. The process is illustrated ideally in Figure 5.1.

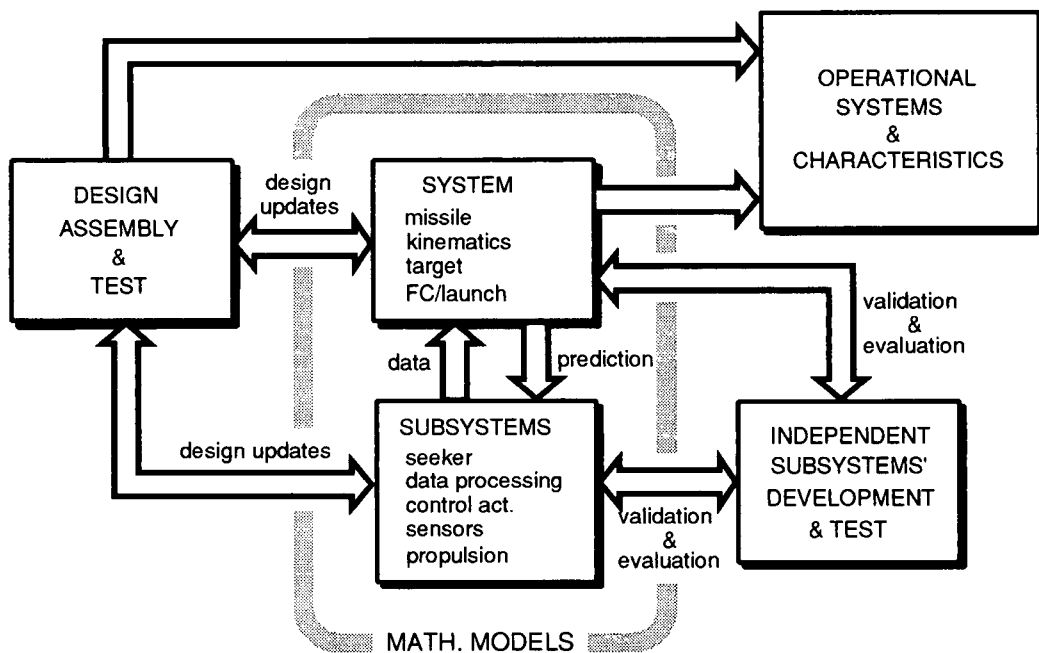

Figure 5.1. Custom Munitions Systems Process

Utilization of Commercial Components and Practices

Acquisition reform is becoming an urgent priority for most Nato governments under the pressure of reduced threats and budgets. Secretary of Defense Perry, in the United States, has three major thrusts in order to turn the force modernization shortfall around. The first and most obvious, from the force modernization stand point, is to try to reinstate that funded portion of the budget – to try to slow down the rate of decrease and turn it around. The second is through savings that accrue from base closures both in the U.S. and abroad. Third is the money to be saved from acquisition reform.

There is immense scope for cost savings, including the utilization of commercial components and practices, if acquisition procedures can be reformed. For example, commercial aircraft may be fitted in the future with sensors such as thermal, millimetre wave or laser imagers to improve safety on landing and, in the longer term such devices might even equip automobiles in anti-collision systems. Although cost and performance aims may be very dissimilar to those of munitions, the possibility of at least using common components is attractive. Environmental requirements are often cited as a restrictive factor in utilising civil commercial devices in military applications, when in fact civilian conditions of use are often as severe, or more severe, than many military situations. Automobile engine components, for example, have to be made sufficiently rugged to withstand extremes of temperature, vibration – and misuse. It is not practical in this report to go into the detail of environmental requirements for military equipments' (especially the micro-environments of systems and components on-board munitions), but it has to be recognized that extreme conditions of temperature and vibration in missile flight, and of the transportation and long-term storage conditions of air, land and sea munition systems, must be taken into account. Nevertheless, where operational environmental conditions prove to be more severe than for commercial use, the conditions can be specified as part of the specification of required performance for individual munition systems, rather than embedded in blanket military specifications.

In a publication by the US Under Secretary of Defense ("Blueprint for Change," AD-A278 102, 1994), reporting on the Process Action Team (PAT) on Military Specifications and Standards, a move towards "performance-based" specifications for military products is recommended in place of the military-unique specifications and standards that have historically been used. The aim is to facilitate opportunities for the use of commercial and nondevelopmental items, the introduction of new technology, and the reduction of Government oversight. A change in philosophy of this magnitude – although on the face of it, highly desirable – will not be easy to implement and, it is recognised by the PAT, will incur significant expenditure. The long term savings, however, are expected to far outweigh the short term costs.

The issue is, however, deeper than merely saying that by reforming processes, we will save money. In acquisition reform, we must look at both development and sustainability in weapon systems. A key to this is the above-mentioned shift towards performance-oriented specifications. Imposing detailed design and management standards on contractors carries a heavy premium. Some companies, as part of a military industrial base complex, deal only with military procurement agencies. They are accustomed to working with those design standards and practices in order to do business and if governments are paying a premium for them to do this, that same premium will be reflected in the prices at which they attempt to compete in the non-military commercial environment. If, in consequence, they find they cannot compete in the commercial sector, they run the risk of going under, which does not appear to be in the best interest of Nato. They could be unshackled from strict military-unique practices, and allowed to adopt competitive commercial practices, if governments were prepared to buy items produced using commercial practices. A similar but different point is that there are companies in the commercial sector who do not do business with the military because they have no wish to conform to the practices or design solutions that the military imposes since that would force them to run two production lines, have two sets of quality oversight, and duplicate processes. Acceptance of commercial industrial practices would broaden the military industrial base to include the entire Nato commercial industrial base.

On the sustainment side, not only would it be cost effective to use performance-based specifications to buy replenishment spares it would also make good business sense from the point of view of life-cycle-cost. In

the latter context, there is a longer term multiplying effect which can be seen in the buy-to-print of hardware items that may have been defined many years ago to military design packages. Items are often kept in the inventory for long periods when those design-to-print packages have become obsolete – the result is: premium prices for obsolete equipment; premium prices for items no longer produced; high weapon systems maintenance costs; and inability to deploy state-of-the-art technology. If that were not enough, the obsolete technology bought at premium prices is, in many cases, less reliable than state-of-the-art technology. Performance-related specifications offer a simple and almost painless way of introducing current technology into military systems.

In addition to the need to reduce cycle time and at the same time reduce costs, there is a security implication of extended cycle times. Since the end of the Soviet Union and the Warsaw Pact, Nato is unlikely again to face the threat of superior numbers, when new technologies were necessary to provide a security edge. A back bone strategy of Nato has always been one of technological superiority to offset numerical superiority; attributed, in part, to highly classified R&D programs. Once inserted into weapon systems however, it was harder to keep the Genie in the bottle because of inevitable security leaks and intelligence gathering operations, that enabled the technology to be replicated. In the meantime however, newer technology could be brought along in order to restore the technological edge. That strategy now seems less viable, because of a greater reliance on the technology commercial base, with more and more technology permeating the entire world. Therefore a crucial aspect of cycle time reduction will be the ability to get advanced technology into Nato weapon systems before anybody else. The maintenance of Nato's technological edge in weapon systems will most probably come from an ability to reduce cycle times rather than the past ability to hold on tightly to new technology until its insertion into weapon systems.

5.4.4. Production Methods

With budgets and inventory needs lower than for many years, low cost production of weapons can no longer depend on high volume or high rates of manufacturing. Low rates and volumes historically imply craft manufacturing methods and the impracticability of mass production assembly lines. New innovative manufacturing methods are needed to properly blend the low-cost high-volume methods of the Cold War era with present realities. New technical advances in computer aided design (CAD), and computer aided design and manufacture (CAD/CAM), allow significant concurrency between design and manufacturing processes. Together with significant reorganisation into integrated product teams (IPT) many companies are merging teams of designers, manufacturers, testers, and users of products. This closely integrated teamwork promotes a streamlined manufacturing flow that reduces process cycle time and rework. By working from a single set of drawings accessible electronically by all members of the team, the design evolves as a team activity. This concurrent engineering eliminates processes which were once sequential and involved many iterations. The modern CAD/CAM environment also encompasses the application of "expert systems" to the design – that is, design and re-design are accomplished with established engineering design rules embedded in computer software.

Many new manufacturing policies are being tested in weapon acquisitions in order to reduce cost while maintaining high reliability and quality. These include the use of pilot production lines to prove the validity of manufacturing processes, application of statistical process control, alignment with "preferred" suppliers, modern quality approaches (e.g. ISO 9000), reliance on the manufacturer for production standards, and the merging of military and civil production. The use of commercial production lines, together with extensive utilisation of civilian products (modified if necessary) for military use, permits significant cost savings in areas where they overlap.

5.4.5. New Components

New components made available by advances in technology may not only result in increased performance but also reduced costs. There are many examples of cost saving breakthroughs, usually by chance when research goals had actually focused on performance. These include focal plane arrays, high level electronic

integration, solid state lasers, and electro-optical rate sensors. Components such as these, while offering higher performance, also yield significant cost savings over the components they replace – or perhaps it might be more accurate to say that the cost savings permit affordable advances in performance, since the devices are often associated with more elaborate systems. It is generally true for example that any increase in computer capacity is soon eaten up by bigger software. Investment needs to be directed towards reduction in the cost of components, or their use, regardless of performance improvement; as for example in recent developments of solid state micromechanical sensors, actuators, etc. which, driven by the prospect of civil applications, promise orders of magnitude cost reductions. This attention to cost-versus-performance trades requires dedicated management application and a cultural shift in research and development organisations.

5.4.6. Schedule Savings

As mentioned previously, the cycle time for modern military equipment acquisition can span decades. A new concept can spend three-to ten years in the laboratory, two years in concepts exploration, three years in demonstration testing, five years in engineering development, and several years to be fielded, not to mention the intervals between phases for decision making and contract negotiations which can add several more years onto the cycle. Over this lengthy period the technology may have aged beyond the usefulness of the weapon. This inability to capitalise on technological advances while they are new and supportable makes cycle time an issue of pressing interest to the Military. It might also explain the continuing manufacture and employment of ageing systems, alleviated by modifications to overcome their most serious shortcomings. Commercial companies are quickly assimilating the lessons of cycle time reduction because of the financial losses they suffer when a competitor beats them to the market place with a new product. Cycle time reduction can be achieved in many ways but foremost is the concept of concurrent engineering, which is interpreted here as an organisational process in which the engineering elements from the whole life cycle work together "early and upfront" as a team, to avoid the need for time-consuming and costly re-design. Concurrent engineering practices are facilitated by modern tools, including factory simulations, CAD/CAM, digitisation and dissemination of design information, and aggressive software management.

Hardware development cycle time can be significantly reduced by utilising components from civil commercial applications, as well as reducing costs (see also the discussion on dual civil/military use in paragraph 5.4.2). One of the problem with this approach is the historical imposition of security rules and military specifications which prevent the sharing of production facilities, although in the case of microelectronic components there has generally been no choice but to use the outputs from high-quantity commercial production, albeit it with added time delays and costs of separate military qualification proving – often of doubtful worth.

5.4.7. Nato's Industrial Base

NATO military strategy for nearly five decades focused on the threat imposed by the Soviet Union and its communist ideology. The most demanding military requirement was to be prepared for a quick thrust, major Soviet attack in Europe that could rapidly escalate into a global conflict. NATO allies would be forced to fight against massive Soviet forces equipped with the most modern weapon systems. To meet this threat, Nato had to field relatively large numbers of systems while pushing modernized weapons into production as quickly as possible.

With the demise of the Soviet threat, the need to develop, produce and field a large number of modernized weapon systems and munitions has ended, as has the need to provide industrial capacity to surge the production of major weapon systems during a crisis. Certain realities remain, however. Nato's continuing mutual security needs and its widening external responsibilities in an unstable world, necessitate the ability to deal with all kinds of future threat. These challenges can be met with a smaller force, as long as that force maintains the kind of technological edge demonstrated in Operation Desert Storm.

Less equipment is required, and in many cases, the service life of that equipment can be extended because the pressures for modernization and replacement have greatly diminished. Defense spending will continue to be reduced, with a shift in priority toward science and technology, including manufacturing process technology.

These changes have obviously affected, and will continue to affect, the industrial base. After a period of rapid growth in the early 80's, defence acquisition budgets have been declining, with the Defence Industry reacting accordingly. Companies and organic defence departments continue to downsize and streamline and to divest excess capacity by sales, merger, or plant shutdown. Further changes are likely. Prime contractors may decide to bring subcontracted work in-house, and some suppliers may leave the defence business. The result should be a smaller, more efficient industrial base, better sized to meet our reduced needs.

The Defence Departments must:

- continue to invest in cost effective, producible, and necessary systems upgrades to maintain the superiority of their weapon systems. They must also ensure that new systems have the capacity for improvement built into them from scratch – an ability facilitated by microprocessor-based guidance systems.
- continue to develop new and innovative manufacturing technologies to improve the efficiency of production.
- establish an industrial base oversight process which will identify critical processes, products or capability and monitor changes in the industrial base to obtain early warning of the potential loss of these critical items;
- take actions to preserve a needed critical process, product or capability in those exceptional situations where it may be lost and cannot be recovered in time to meet an emerging threat;
- stimulate changes in the industrial base that will increase efficiency and competition.

5.5. Environmental issues

5.5.1. Protection of the Environment

Protection of the environment has hardly been a primary concern for bomb, missiles and other weapon systems in the past. However, with "green" movements growing in influence, environmental pressures will affect laws, policies, manufacturing processes, and the basic design of all future systems. Most of the decisions concerning the Operation and Maintenance (O&M) of systems are determined as a result of the design decisions made early in the acquisition process. Historically, O&M pollution concerns were hidden costs not addressed before the system was fielded and passed on to the user in higher waste disposal costs. The driving cost factors associated with hazardous materials, including legal/environmental, personal processing, and disposal, average 71% of life-cycle cost. Since the current trend is toward a shrinking defense budget, pollution prevention must become an ingrained business practice.

In addition to material substitution – that is, replacing dangerous materials with ones less hazardous – the modern designer must change or eliminate processes in order to move away from the use of hazardous materials. A hazardous material is defined as a material that, due to its chemical, physical or biological nature, causes safety, public health or environmental concerns that result in an elevated level of effort to manage it. Every design decision is an opportunity to eliminate a hazardous material. All chemicals and materials must be evaluated in terms of program trade-off decisions and life cycle cost impact. Major decision review should contain an evaluation of the hazardous materials and documentation of the program

manager's decisions. This allows hazardous materials trade-off to take a logical place in the overall weapon system design and development thereby balancing pollution prevention and support characteristics.

This heightened focus on hazardous materials will change the design process for modern weapons and seekers in particular. Specifically, processes for electronics circuits will have to find new solvents for soldering, cleaning, and coating. New technology devices will have to be considered in light of the processes needed to manufacture them in quantity. Both the actual materials which make up the seeker and the materials used in the manufacturing process will be scrutinized for their role as a hazardous material. This will cause new performance trade-offs not previously considered.

5.5.2. Munition Effects

Damage to the environment from large bombs and similar munitions – including long term damage to buildings, communications, (bridges, roads, rail networks) and public utilities (water, electricity, gas, etc.) – could be minimized by a more precise application of force. Small munitions delivered with high precision to the most vulnerable component of the target, using kinetic energy damage mechanisms for example, could in principle eliminate collateral damage. Their feasibility depends of course on the nature of the damage to be inflicted: for example, duration of effect must be balanced against speed of repair. The random dispersion of anti-personnel mines is also an unacceptable long term environmental hazard which has always been a limiting factor for air-delivered mines (as distinct from carefully surveyed and recorded minefields). Alternatives, such as more selective munitions, limited-life munitions, and non-lethal damage mechanisms, must also be given much greater consideration than hitherto.

5.6. Chapter Five Overview

It is tempting for technologists to overstate the importance of technology in ameliorating Nato's operational problems: many of these problems are primarily diplomatic, political and organizational in nature and are only marginally affected by the weapon systems available to the Military User. Nevertheless, as this chapter has attempted to show, by focusing on User needs it is possible to identify novel approaches to some military problems by the application of new technologies (or by the new application of old technologies). In particular, it is clear that existing procedures – both in operations (e.g. mission planning) and supply (e.g. munition systems acquisition) – are not always appropriate to the changing world and reduced military budgets which the Nato alliance faces. At the same time, extremely rapid advances in non-military technology – particularly in information technology – provide opportunities to make better use of existing assets and introduce more efficient and cost-effective procedures for developing new assets.

CHAPTER 6. FUTURE CAPABILITIES

Earlier chapters explored the influences on PGM guidance technology and the possibilities for improvement, mainly within the framework of existing NATO military functions. However, developments in guidance technology offer the potential for new capabilities beyond those currently available to NATO forces. This chapter aims to give some indication of that potential.

6.1. Global Targeting and Force Projection

The first notable advance in capability for PGMs may not be directly in the PGM itself, but rather, in the architectures which support PGM use. In future, Nato countries will have, in varying degrees, the ability to apply force at great distances; the ability to detect, identify, and geolocate a target properly being paramount among the qualities needed for successful attack. In this context, global information access and strike are key elements of future Nato security and warfighting. Also, as weapons become more capable in range and speed, reliance on the pilot to make all targeting decisions during the endgame will become increasingly impractical.

Internetted sensors capable of providing timely information to the tactical warfighter will allow near-real-time decisions in reaction to threats. Internetting of assets may include sharing of information between unmanned aircraft and even tactical missiles. Advances in data links (which may be covert and jam resistant), internetting architectures, autonomous target recognizers and expert system mission planning, will enable precision strikes to be conducted rapidly and with significantly higher probability of success. Targets will be identified with greater precision in location and local condition: this higher fidelity enabling stand-off weapons to be used with greater confidence of mission success and avoidance of collateral damage. Such internetting must cut across Service and International boundaries which at present create political as well as technical difficulties in specifying requirements.

This greater knowledge of target location and condition should lead to a global weapon projection capability – that is, the ability to apply force to all areas of the world with or without manned aircraft. This will require highly internetted surveillance along with associated data and command links. Aircraft (both manned and unmanned) will be highly internetted to share information and provide an overall situational awareness not available to totally autonomous operations.

6.2. All-Weather Operation

The development of new all-weather sensors and seekers will permit a significantly more robust ability to react to tactical and strategic conflicts. All future weapon designs must have acceptable resistance to countermeasures and, in addition to man-made interference, must be capable of operating in all natural conditions. New uses for millimetre wave radars and the availability of tactically-sized and low-cost synthetic aperture radars, will enable future homing seekers to see when existing seekers cannot. The rapid deployment and improvement of GPS will also provide highly accurate jamming-resistant guidance in all weather conditions.

Because conflicts can start at any time, all-weather capability is highly desirable, including weapon launch from long range, or from altitudes where the aircraft is free from the effects of adverse weather, into locations and conditions not acceptable for manned aircraft flight. This ability to engage targets despite local flying or sighting conditions is akin to soldiers' night vision capability, demonstrated in Desert Storm and other conflicts. Similarities to bad weather are found in extreme battlefield conditions, which may include smoke, dust, and explosive debris – again, as in Desert Storm, where obscuration by the dense smoke from burning oil fields degraded the operation of precision guided weapons. These limitations must be overcome if Nato's forces are to **"own the battlefield"** (whatever the conditions).

6.3. Miniaturized Munitions

One of the biggest advances in weapon guidance systems, and electronic systems in general, is in packaging; the most noticeable trend being miniaturization with its associated cost reductions. A computer which once filled a large room can now be duplicated in a digital chip at a small fraction of the cost. The power of such computers appears to grow in capability as their size and cost decrease, enabling them to accomplish tasks hitherto considered impractical for tactical systems. Similarly, microminiature sensors can be made small enough to be placed in structures normally considered too small or hostile. This technological trend is accompanied by great leaps in conformal antennas and low cost electromagnetic apertures. Advances in conformal array antennas allow sensor apertures to be packaged in the weapon's outer skin and matched to the airframe's aerodynamic requirements. This permits the same – or improved – capability as has been demonstrated in weapons with large dish type antennas, but with considerably less volume and shape interference. The end result is that sensors will be mounted in small airframes or in places normally considered too small, too curved, too hot, or too hostile for effective sensor operation.

As miniaturization in the world of electronics has advanced, so also has mechanical technology developed to the point where micro-machines can perform the functions of gimbals, flight controls and other weapon components. Such devices can be used for controlling very small vehicles or alternatively, they may be used for control of many small surfaces or devices in larger vehicles. Strapdown inertial sensors can provide flight control without bulky, expensive gimbals. Again, as in the electronic world, this mechanical revolution will permit the design of complex devices in extremely small packages together with reduced fabrication costs.

The weapon designer is in a position to consider subminiature and shock resistant guidance systems for applications where previously they would have been impossible. The most likely applications would be in the precision guidance of smaller and smaller calibre weaponry. Just as bombs or missiles can be delivered accurately to a target by precision guidance systems, so it is possible to guide a tank round, a mortar round, (or, in the future, even a bullet) at an affordable munition cost. The soldier's effectiveness will be multiplied many times over when gun-fired bullets can be directed and steered by miniature sensors and aerostructures for a "one bullet - one kill" capability. The design of the gun itself may also be simplified for lower cost or simpler use. Although guided rounds might first find use for snipers or for special operations, eventually the technology will permit their general use in all classes of small calibre weapons.

Micro-miniaturization will not only spur new capabilities in existing weapons but could lead to new concepts of operations. Aircraft may be fitted with very much smaller munitions than at present, equipped with precision homing guidance to compensate for small warheads. This would provide the aircraft designer with significant options to carry many more munitions and/or reduce aircraft size and cost while maintaining effectiveness, and to provide greater payload diversity through specialized weaponry. Such micromissiles could be stored more efficiently and ease the problems of launch from stealthy platforms.

In addition to the miniaturisation of the weapon, miniaturisation of components will find application in current sized weapons to allow greater capability in the same overall volume. Specifically, in the case of radar systems, system performance is limited by the power aperture product of the transmitter. Subminiaturisation permits packaging components of greater capability in the transmitter and antenna. Greater power aperture, processing, and spectral purity will facilitate homing on extremely difficult targets, such as stealthy vehicles (land, sea or air) or those deeply immersed in countermeasures.

6.4. Rationalised Inventories and "On-Demand" Munitions

A consistent theme throughout this document has been the drastic reduction in defence budgets available for the purchase of large caches of expensive weapon systems. This implies new paradigms are needed in the future for weapon development and inventories. One approach is to take advantage of the rapid improvements in guidance systems described in this report to better effect a one-shot, one-kill capability.

The tightening of guidance accuracies, combined with new warhead effects, will provide an inventory that is considerably more efficient and that will drastically reduce the need for the present bulk storage of huge inventories of dumb weapons.

Another possibility is the use of modular components with standard interfaces and protocols. Components designed with high inter- and intra- vehicle -operability will ease future opportunities to modularise that component with resulting better flexibility, adaptability and reprogrammability. Preferably, these parts should also enjoy significant commercial application in order to better maintain technological currency, ensuring thorough development and qualification for a wide range of uses. As an essential part of this process, the governing R&D agencies would need to develop and maintain robust and accurate mathematical models and simulations. Pre-packaged digital simulations, for analysing the performance of new configurations, would be developed along with the components, and industrial companies developing new weapon systems could take advantage of pre-existing subsystems with well-understood and well-documented properties.

An example of such rapidly responsive capability was demonstrated during Desert Storm. There was a recognized urgent military need to penetrate and destroy deeply buried bunkers, but no weapon existed that could fulfil this mission. However, many of the necessary components did exist and were well documented. Designs for penetrating warheads, demonstrated in numerous test filings of various sizes, were scaled to the size needed. To guide the weapon, an existing guidance section from a GBU-24 was chosen for integration with the warhead. The entire weapon consisted of components – each of which was documented and well understood – borrowed from other systems and integrated into a new capability. Finally, and importantly, a detailed digital simulation was available which could be modified for the new configuration so that the software tools were in place to accurately predict the weapon's capability and handling properties. This weapon (assigned the nomenclature GBU-28) was conceived, tested, and operationally deployed in just two months. Had these modular components not been available or adequately documented, such a powerful weapon would have taken years to develop.

The PAVEWAY laser guidance head used in the U.S. Air Force's GBU-24 and GBU-28 has also found use in the U.S. Navy and many Nato forces. Again, this has been possible through the highly modularized nature of the kit and the excellent documentation and system understanding. In the future, it is hoped that weapons inventories will be rationalized with modularity in mind. Each major component should be documented and have significant computer simulations defining its use and operation, with each part operating under standard interfaces and protocols to allow speedy integration. This approach reduces the cycle time required for weapon development when the technology is well defined and available off-the-shelf. For example, Nato member nations might jointly choose to design and develop modular sensors capable of homing on jamming signals, to be stockpiled in limited quantities. When needed, Nato would then be in a position to integrate an anti-jammer homing system with a portion of the inventory to discourage or eliminate specific jamming threats.

Taking the idea of rationalization of inventories a stage further, multi-purpose, multi-service PGMs, using adaptable multi-use components could avoid duplication between the inventories of national and international armed forces. Stockpiles could be rationalized to create compatible sets of munitions and components purchased and held by various nations. Inventory rationalization and minimisation could be accomplished on this scale through a systematic review of by Nato of PGM requirements at the international level. The confidence that other Nato countries would maintain stockpiles of smart components which could become available during conflicts, would reduce each individual country's need for excessive inventories. As was the case with the GBU-28 development, the availability of well documented components with standard or straightforward interfaces would provide tools for rapid generation of war fighting capability. As mentioned earlier, this cycle-time reduction produces savings in both development and cost of inventory. Cost savings through smaller inventories becomes practicable if the rapid prototyping of new capability is possible to deal with a prolonged threat. At present, the very real danger exists of stockpiles are being run down or becoming obsolete, without a compensating philosophy of rationalization such as that described above.

6.5. Integral IFF

Future conflicts may occur over a broad spectrum of intensity, ranging from humanitarian missions and peacekeeping operations, up to full-scale conventional war. Special operations will include anti-terrorist, policing and psychological actions, as well as other related operations. Engagements may occur at close quarters where rapid identification of friend or foe is crucial. Improved situational awareness, higher information-rate sensors, and robust internetting will provide information about potential threats. Smarter, more densely packed computers will be able to sift through very large quantities of information and extract information of high reliability in a way that is beyond existing or practical manual capacity. This information, plus computed uncertainty analysis, could be an integral part of the processes of decision-making and response embodied in battlefield munitions systems, either in the form of automatic-prompt or soldier-interactive operation. Though not foolproof, such an architecture would provide significantly greater access to information plus the tools needed to best decide friend from foe.

6.6. Unmanned Aircraft

Despite the somewhat disappointing progress to date, it is possible – some would say probable – that the future battlefield will be dominated by unmanned air vehicles (UAV) designed to conduct a wide range of tactical missions. Advanced UAV could provide global force projection, with access to all areas of the world, without manned aircraft. This capability would entail internetted surveillance, data and command links, and data fusion for autonomous operation at extreme stand-off. Roles could embrace the full spectrum of activities currently undertaken by manned aircraft, including existing non-lethal UAV roles of reconnaissance, surveillance, target acquisition and battle damage assessment, but additionally, the lethal roles of tactical precision strike and suppression of enemy air defenses. UAV or drones could monitor and engage cruise missiles and theater ballistic missiles launched from enemy regions and even supplant manned fighter aircraft in some air superiority roles, including air-to-air engagements and close air support.

Combat UAVs will be highly internetted, with a cooperative ability to pass situational awareness to strike elements. Each will be equipped with advanced processors capable of automatic target recognition and mission planning. Planning and operation of these robots will be simplified through powerful expert-system-based mission planning tools, which will greatly reduce the amount of training required for each mission.

6.7. Novel Weapon Concepts

Although this volume is focused on guidance of PGMs, it is necessary to recognize the equally significant effects of advances in other PGM functions. New warhead concepts allow better control of blast effects to channel their destructive energy at the heart of the target. New materials and effects will permit greater effectiveness especially when combined with the higher precision noted earlier. Smart warhead systems could react to the type of target identified by the terminal sensor – for example, with focused fragment patterns for point targets and spread patterns for more dispersed targets. Novel warheads may also include non-lethal devices using electromagnetic effects, temporarily disabling chemicals, or even psychological tools (even the humble pamphlet has its uses). A more speculative warhead concept is for localised weather control, in which the deployment of chemicals or energy in combinations capable of producing operationally-significant local weather changes. Weapons might even be used in information warfare by acting as telecommunication links in threat networks: in this case, the payload is not a warhead in the conventional sense, but an electronic intelligence probe capable of receiving enemy information and/or transmitting false information. Perhaps the most important of all new concepts, future warheads could be capable of neutralizing stockpiles of materials and weapons of mass destruction. Similarly, confidence in the abilities of munition terminal guidance, along with a diversity of warheads, will confer the opportunity to warn, rather than wound; to wound, rather than kill; and to assure a kill of the right target when appropriate.

New vehicle concepts could completely change our perception of PGMs. New weapon airframes have demonstrated hypervelocity over significant ranges. Long range boost glide vehicles capable of high speed flight over ranges of thousands of miles offer the potential for use as political tools. High speed, long range systems can give national leaders the ability to react confidently to international conflict without maintaining a costly overseas presence. Other vehicle concepts might include multipurpose structures permitting operation in more than one environment. For example, a combined air/submarine missile could fly long distances prior to entering the water for a submerged run at sea targets, including submarines (in a limited way, this capability has already been demonstrated in anti-submarine systems such as the Australian-developed ship-launched Malkara which carries an air-dropped torpedo). A hardened missile body might also incorporate a ground boring capacity for attacking deeply buried targets.

The weapon designer will be able to take full advantage of the ability for missile trajectory-shaping inherent in modern digital-processor based guidance systems. By predicting the most likely path of an incoming round, a counter-fire weapon system could launch precision-guided munitions on a reciprocal path to engage the threat and/or intercept the round. An anti-air missile can fly a trajectory based on some optimizing parameter such as highest intercept velocity, largest target cross section, or least threat to friendly forces. Extension of these ideas drives towards high-precision combined self-protect/counterfire capability. Self-protect systems exist today, such as the Phalanx system which uses a rapid-fire gun to protect against anti-ship missiles. Equivalent systems can be imagined in which an incoming shell is matched with a return fire that could be aimed at the shooter and/or the incoming round itself. As missiles become smaller and more capable, the concept could perhaps extend to self protection of individual soldiers – that is, a device worn by soldiers to sense an incoming round and respond with a self-protect or counterfire round. The idea has some affinities with the reactive armour of armoured fighting vehicles but to be effective would need to operate at a stand-off distance from the object or person(s) protected. Precision counterfire could find great use in deterring or suppressing offensive weapons in confused civil/military situations (Bosnia for example), in low intensity conflicts, and in peace keeping operations.

6.8. Chapter Six Overview

Whilst future capabilities such as those as suggested above will be made possible by the kind of advanced technologies described in Chapter 4, it is equally clear from Chapter 5 that radical changes will also be needed in operational doctrines, and in research, development and procurement of munitions. The combination of advanced technology – borrowed where necessary from non-military sources – and organizational changes, could offer Nato new approaches to meeting many of its military needs. Those discussed in the present chapter are summarised below:

- **Global targeting and force projection** by unmanned air vehicles and very long range hypervelocity missiles. This capability depends on the development of machine intelligence embodied in highly capable on-board data processing, together with internetted communication, data and command links, and robust GPS/INS-based navigation (which in some cases may provide a realistic low cost alternative to traditional homing seekers).
- **All weather operation** (and operation in severe battlefield conditions) will be facilitated by new types of terminal guidance sensor, either singly or in multi-mode and multi-spectral combinations. GPS-equipped munitions, when equipped with simple inertial navigation, can also provide a robust capability in adverse weather and countermeasures environments.
- **Miniaturized munitions**, made possible by extreme miniaturization of electronic and mechanical devices applied to precision homing, which will enable munitions to be made more compact and more effective. Miniaturization will be extended to encompass micro-missiles or even guided bullets, with profound significance for logistics and platform firepower.
- **Rationalized inventories and "on-demand" munitions** can be achieved by programmable and modular munitions design and the use of standardised components and interfaces. They would yield

major cost reductions, together with improved adaptability and flexibility in use, plus the ability to respond quickly to new or changing threats. Part of this process would be the deployment of practical multi-purpose / multi-Service PGM.

- **Integral identification of friend or foe** – integral, that is, to the munition system, which could incorporate high-power data gathering and analytical devices to provide interactive aids to decision making and response in confused battlefield situations.
- **Unmanned aircraft** could become increasingly effective in the future through the use of improved sensors and on-board data processing capability, involving target location and description by the vehicle, and enabling the development of more highly integrated data management and C³I architectures.
- **Novel weapon concepts**, that could be developed by advances in terminal guidance technology offer opportunities for a range of new capabilities beyond those currently available to Nato. They include, for example:
 - New types of warhead system (or payload) including non-lethal options and smart warhead systems, functioning in conjunction with "intelligent" terminal guidance, which could provide Nato with a wide range of flexible responses to changing tactical situations, especially as part of a modular munitions philosophy.
 - One-shot / one-kill small arms rounds will become a possibility, incorporating micro-sensors and control devices in extremely small and robust packages. Benefits in logistics and firepower would be achieved by reductions in quantities and/or increases in munitions' effectiveness.
 - New types of munition, including very long range, high speed vehicles (as described above) and also multi-purpose and multi-phase munitions, capable of operation in air, space, submarine (even underground?) environments. Simplification of inventories savings would be accompanied by improved weapon platform effectiveness.
 - Precision counterfire, ranging from counter-battery to small arms, utilizing advanced sensors and guidance techniques to achieve rapid response and the neutralize of incoming rounds and/or threat agents. This capability could be invaluable in low-intensity conflicts and peace keeping missions.

CHAPTER 7. CONCLUSIONS AND RECOMMENDATIONS

As stated in Chapter 1, the Working Group has become progressively more focused on Nato military needs. This is reflected in our conclusions and recommendations, which fall into two clearly defined areas: the potential of terminal guidance technology to help meet those needs; and the possibilities for international cooperation to help reduce costs and increase availability of advanced munitions.

7.1 Potential to Meet Nato Needs

7.1.1 Technology Improvements

The analysis of Chapters 3 highlighted a number of areas of concern, arising in large part from the changing World situation of recent years, but in some cases reflecting longer standing problems that Nato would have faced anyway. The specific needs identified in Chapter 3 (based on analyses by AGARD's Aerospace Applications Studies Committee and Guidance and Control Panel) are for: lighter, more effective weapons; more precise, night/all weather stand off weapons for mobile and fixed targets; extreme stand off weapon capability; multiple target/target-type engagement capability; user friendly (minimum training) systems and concepts for augmentees; improved identification of friend/foe; smaller, more precise weapons; improved producibility, reliability, maintainability; and dual-use (including PGM adaptability). Every one of those needs can be met, at least in part, by improvements in guided munitions – particularly by guidance technology advances such as those described in Chapters 4 and 5. Most importantly, improvements in precision guided munitions will usually offer contributions to Nato military needs in more than one area of concern simultaneously, as evident in the following conclusions drawn by the Working Group:

- **Improvements in imaging sensor technology and on-board data processing will lead to LIGHTER AND MORE EFFECTIVE WEAPONS that are also SMALLER AND MORE PRECISE, capable of engaging MULTIPLE TARGETS (or DIFFERENT TARGET TYPES), MORE USER-FRIENDLY, and CAPABLE OF DUAL (OR MULTIPLE) USE.**
- **All-weather multi-mode and multi-spectral sensors, featuring intelligent target detection, recognition and identification, will ensure PRECISE, NIGHT/ALL WEATHER STAND OFF CAPABILITY (including EXTREME STAND-OFF) FOR FIXED OR MOBILE TARGETS, together with significant contributions to IDENTIFICATION OF FRIEND OR FOE and BATTLE DAMAGE ASSESSMENT, particularly if combined with secure data/command links.**
- **PRODUCIBILITY, RELIABILITY AND MAINTAINABILITY will all be improved by the trend towards micro-miniaturization in electronics and mechanical devices, which is an essential element in the development of SMALLER, LIGHTER, MORE EFFECTIVE WEAPONS.**

7.1.2. Future Capabilities

In addition to the specific needs identified above, munitions guidance technology offers potential for new or novel solutions lying outside present capabilities. They include:

- **NEW TYPES OF WARHEAD SYSTEM (or payload) including non-lethal options and smart warhead systems, functioning in conjunction with "intelligent" terminal guidance, which could provide Nato with a wide range of flexible responses to changing tactical situations, especially as part of a modular munitions philosophy.**

- **ONE-SHOT / ONE-KILL SMALL ARMS ROUNDS**, incorporating micro-sensors and micro-mechanical devices in extremely small and robust packages, which would improve logistics and firepower by reducing quantities of munitions and/or increasing their effectiveness.
- **NEW TYPES OF MUNITION**, including very long range, high speed vehicles and also multi-purpose and multi-phase munitions, capable of operation in air, space, and submarine environments. Simplification of inventories would be accompanied by improved weapon platform effectiveness.
- **PRECISION COUNTERFIRE**, ranging from counter-battery to small arms, utilizing advanced sensors and guidance techniques to achieve rapid response and neutralization of incoming rounds and/or threat agents. This capability could be invaluable in low-intensity conflicts and peace keeping missions.

7.2. Nato Cooperation

The following comments and recommendations are by no means unique to terminal guidance but, as indicated in paragraph 2.4, there are few fields of defence in which there has been such duplication of effort among Nato members as in the development of guided munitions – and particularly their terminal guidance systems. In view of the vast expenditures required for development, production and operation of weapon platforms (whether ships, aircraft or armoured fighting vehicles), and the comparatively small sums spent on guided munitions to equip them, greater cooperative efforts on standardized munitions would pay large dividends. Whereas cooperative efforts have often been frustrated in the past by over-ambitious goals that have not matched individual nations' needs, the present recommendations are comparatively modest and widely applicable.

7.2.1. Standardization

The Working Group regards the following recommendations as affordable, easy to implement and yet far-reaching in their scope for long term improvement of Nato's armoury:

- **A RANGE OF INTERCHANGEABLE MUNITION COMPONENTS** (conforming to international interface standards and protocols) should be identified that could be utilized in new or updated munitions, for manufacture or purchase by individual nations according to their needs, and supported by standard, validated development tools.
- **INTERNATIONAL STANDARDS, PROTOCOLS AND TOOLS** should be developed by, or in conjunction with, Industry representatives (for example, the Nato Industrial Advisory Group, NIAG) for the standardized munitions systems referred to above.

7.2.2. Cooperative Approaches

Although not specific to the Working Group's primary concerns, the following recommendations are offered – with some caution. There is a long history of failure in Nato international cooperative munitions ventures (though there have also been resounding successes). The reasons for failure are many and varied but programmes have suffered, among other things, from divergent national goals of timescale and performance, from almost impossible workshare aims, and from over-management. To overcome these problems the Working Group recommends that:

- **PERFORMANCE-RELATED SPECIFICATIONS** should be universally adopted and applied internationally, in place of each nation's military design standards and procedures, in order to facilitate international procurement and the use of commercial components and subsystems.

- **COMMERCIAL PRACTICES** should be adopted for international munition programmes, including competitive tendering and flow-down, regardless of national boundaries, against performance-related specifications. A single Prime Contract – administered by an agreed coordinating agency – should be awarded, containing requirements for international subcontracting (managed by the Prime Contractor).

APPENDIX A - BASIC DEFINITIONS

A.1. General

In strict terms, the flight path of a guided munition is governed by three main processes: navigation, guidance, and control, which can be defined in the following terms:

1. **navigation** is the information gathering process on the position, velocity and acceleration of the vehicle.
2. **guidance** is the process of determining the desired manoeuvres, usually aimed at reaching a predefined target, which might be fixed or mobile.
3. **control** is, within our field, the process of controlling the vehicle, following the manoeuvre commands determined by the guidance process.

Although "guidance" is the subject of this document, it is impossible in practice to avoid consideration of the total system of navigation, guidance and control as it applies to the terminal phase of a munition's trajectory. All three topics are therefore freely discussed in the main body of the report. However, as part of the background presented by this appendix, a review of the separate processes follows.

A.2. Navigation

Navigation systems generally fall into the following basic forms, or hybrids of the two forms.

Dead Reckoning, in which position is determined incrementally by reference to an initial state. A familiar form of dead reckoning in missile applications is the inertial navigation system (INS) which determines velocity and position by integration of measured accelerations. Its main advantages are autonomy, indetectability and high resistance to countermeasures. although degradation of accuracy with flight time may require updates from external sources for high precision in long range operations. Air data navigation and doppler navigation, which determine position from measured velocity, may be used in certain long range missiles as a complementary or back-up navigation system.

Position Fixing, in which position is determined from external references. The most familiar form of position fixing navigation used to date in aircraft has been radioelectric navigation in which position and velocity are determined from friendly ground sources, which limits its application in missiles because of countermeasures sensitivity and lack of autonomy.

A more relevant type of radioelectric navigation for missiles is the Global Positioning System (GPS), which operates by on-board computation of the distance to several orbiting satellites, based on their radio emissions. Its main advantages are high accuracy, independent of range, and global coverage which effectively make the system autonomous.

For low level flight of interdiction military aircraft and missiles, true autonomy, independent of time or range, is achieved by terrain reference navigation (TRN). This may be by terrain profile correlation based on radioaltimetric terrain profiles compared in real time with a stored data base, or by the more accurate terrain feature correlation, in which sensor images of features such as rivers, buildings, roads, etc., are correlated with stored information.

Mixed Navigation/Guidance. The above navigation systems may supply the complete state vector of the missile directly, or require additional equipment such as radioaltimeters. In either case they may be considered as complete stand-alone navigation systems. Other systems, however (such as homing, beam-

rider, etc.) only require partial or minimal navigation information to perform the guidance process; the navigation and guidance functions being in effect interrelated.

A.2. Guidance

The problem to be solved by a guidance system, can be stated from a mathematical perspective, as:

Given a vehicle with a set of initial conditions (position, speed, energy, etc.), define the manoeuvring requirements to reach a set of desired final conditions, of which the most important one is position. If the vehicle is a missile, final position must be coincident with the target, which can be fixed or mobile. The final conditions can be fixed or time dependent, and they may be, or may not be known a priori.

Therefore, the problem is modeled by a system of differential equations, usually with time varying coefficients, with limits in most of the state variables, external perturbations and, in many cases, with final conditions varying continuously along the flight in an unforeseen way as a function of the vehicle and the target instantaneous state vectors. This problem can have infinite theoretical solutions, unless additional constraints (i.e. optimization of certain functions) are imposed. On the other hand, it will generally not admit an exact solution, and approximations have to be applied.

To achieve in practice an exact, or near exact solution (in other words, high accuracy), three main requirements must be satisfied as closely as possible:

1. Exact knowledge by the system of the initial conditions (given by the navigation system).
2. Exact knowledge by the system of the final conditions (i.e. target final state vector).
3. Mathematical and physical implementation of an appropriate guidance process.

The first condition requires either a navigation system with very high accuracy throughout the vehicle flight or, if this is not possible, a change to another form of "final navigation", during the last stages of flight.

If the target is a vehicle, or its position is not known a priori, or its dimensions are small enough to prevent the system knowing in advance target position with sufficient accuracy, it is necessary in order to comply with the second condition that the target data be acquired by the system in real time during flight up to impact, to continually obtain the required instantaneous final conditions.

Finally, the third condition demands a system provided with appropriate algorithms, sensors, computing power, electronics and mechanisms, to deliver a solution within the required accuracy.

The above considerations give rise to the concepts of "midcourse" and "terminal" guidance.

During the period of flight preceding target detection, navigation and guidance have to be based on references external to the target, or on commands received from external sources. This is defined as midcourse guidance, where the external references of the target can be a direction in the space, a series of way-points coordinates, the coordinates of the target itself, etc. Navigation can be either of the "dead reckoning" or "position fixing" types. Guidance algorithms, and initial and final conditions need only to be known with sufficient accuracy to allow the system to be able to detect and lock-on to the target, with a change to the terminal guidance process when actual target data is provided to the system.

Once the system acquires the target, the terminal guidance phase begins, during which the actual target is tracked in real time by the missile, obtaining the necessary target data up to impact. Also in this phase, the guidance process is in general such as to require little navigation data, and is mainly referenced to relative

missile-target motion. This avoids the explicit use of missile and target state vectors, always subject to errors, arriving at a form of "mixed navigation-guidance process" as previously mentioned. These terminal guidance functions are performed by (or through) the seeker mounted on the missile.

A.3. Control

The effectiveness of the guidance system is strongly influenced by the method of aerodynamic control employed. Aerodynamically controlled missiles generally depend on the movement of control surfaces such as a wing or tail to obtain the desired acceleration. These missiles are generally designed with response times that degrade as altitude increases in order to maintain guidance system stability. Typical aerodynamic configurations are:

Tail Control. Aerodynamic controls in the rear fuselage, behind the wings (if any).

Canard Control. Controls in the front part of the fuselage, ahead of the wings.

Moving Wing Control. Control by deflecting the wings, located ahead of rear stabilizing surfaces.

The control response of tail control configurations is generally inferior to canard configurations (that is, their control response delay is greater), while both are inferior to moving wing control. The converse is true of control torque requirements, moving wings needing much more powerful control actuators than tail controls, with canard control requirements intermediate.

Faster response times can be achieved with rocket thrusters located at the centre of gravity, which provide near-instantaneous response. However, these systems generally provide lower acceleration capability than conventional control methods because of thrust-to-weight limitations.

Thrust Vector Control is essentially a variant of tail control, but using deflection of the propulsion motor efflux to generate lateral control forces at the tailend of the missile. It has the advantage of being independent of aerodynamic conditions but has the obvious disadvantage that it is effective only while thrust is maintained.

A.4. Seekers

Following the foregoing concept of terminal guidance, the seeker may be defined as a chaser mounted equipment which collects information of the actual target in real time and generates guidance commands.

From a conceptual perspective, the seeker is a system which performs simultaneously navigation and guidance functions. Given the historical importance of the seeker, this duality of functions has permeated the whole field, leading to confusions, such as the use of the term "proportional navigation" when applied to its mechanisation as a guidance function. In general, the seeker firstly detects and acquires the target, with the appropriate scanning strategy, then secondly tracks it to obtain the necessary information, and finally generates the guidance commands. In many guidance systems, these functions are only partly executed by the seeker itself. For example, in laser guided weapons, target detection and identification is performed by a human operator, and the weapon tracks a laser spot, not the target itself.

The basic information provided by the seeker is that relative to line of sight kinematics, but in certain systems additional information may be provided (i.e. target range, target configuration, etc.). Tracking commands themselves are also elaborated sometimes externally to the seeker, as in certain TV or IR guidance systems.

It is therefore difficult to provide a universal functional definition of the seeker, as it does not always perform all the guidance functions. From the architecture point of view, it is simpler. It is a unit with a

direct line of sight to the target, whose information is used for guidance purposes (either directly or indirectly). The different types and uses of such information are the the main subjects of the report.

A.5. Other Terminal Guidance Concepts

Although the requirements of precision terminal guidance are generally assumed in the present report to involve a seeker, in some cases the target data can be collected and/or processed by means outside the munition itself. Examples are: beam riding, command guidance, INS, satellite navigation, and terrain-referenced navigation (TRN). Where appropriate, theses are referred to in Chapters 2 and 4 of the report.

APPENDIX B. TERRAIN REFERENCED NAVIGATION

B.1. INTRODUCTION

Terrain referenced navigation is a technique for improving the accuracy of a navigation system by correlating a sensed elevation profile of terrain beneath a vehicle with stored terrain elevation data. Position estimates are referenced to the terrain data. Because of this characteristic, terrain referenced navigation systems are especially useful in application that require accurate navigation relative to targets, obstacles, structures, and other features whose locations are derived from the same source as the stored elevation data. Example applications include low-emission terrain-following/terrain-avoidance, target cueing for standoff weapon terminal sensors, indirect ranging and ground proximity warning. System navigation accuracy depends primarily on the ratio of terrain roughness to terrain data vertical accuracy and secondarily on navigation system accuracy, vehicle ground clearance, ground cover, vehicle manoeuvres, and update frequency. Terrain referenced navigation systems are often considered for use with terrain masking for covert, low-altitude ingress into hostile areas. Low probability of intercept radar altimeters may be used in these applications. A key issue is the availability and quality of terrain elevation data. This Appendix provides an overview of the characteristics and the of capabilities of terrain referenced navigation, and the outlook for future applications.

Two generic types of "dead-reckoning" navigation are frequently used in military vehicles: inertial navigation systems (INS) and Doppler/attitude heading reference systems (AHRS). INS are typically used in fixed wing aircraft and Doppler/AHRS in rotary wing aircraft. Once aligned, an INS operates independently of external stimuli, but errors drift with time. INS stochastic error characteristics are well understood and can be accurately modelled. Doppler/AHRS navigation systems produce a navigation solution by integrating Doppler velocity measurements transformed via the AHRSdetermined vehicle attitudes. Errors drift with distance traveled rather than with time, thus, Doppler/AHRS systems are often preferred to INS for rotary wing aircraft. Both types of navigation systems can use position updates from external sources to remove accumulated drift. Terrain referenced navigation (TRN) is a technique for updating the position of a navigation system by correlating a sensed elevation profile of terrain beneath a air vehicle with stored digital terrain elevation data (DTED). TRN updates may occur over pre-planned mapped areas, or as they become available over large mapped areas. For familiarity, an INS-type navigation system of the kind currently used in aircraft, and updated over large geographical areas, is emphasized in this Appendix. The concept's extension to standoff weapons, and to restricted geographical areas, are not discussed specifically.

B.2. Concept

TRN consists of sensing a terrain elevation profile beneath a vehicle and correlating the profile with stored DTED to produce an estimate of the air vehicle's position. For practicability, the approximate shape of the trajectory must be known and the correlation limited to areas of reasonable size. An INS, usually with barometric altimeter aiding, provides the approximate trajectory. TRN systems provide three dimensional position updates to the navigation system by estimating INS trajectory errors. A radar or laser altimeter measures ground clearance and the DTDE gives terrain elevation above mean sea level (MSL). Implementation requires an INS, an altimeter, DTED, and a computer for executing the TRN algorithm. Figure B.1 illustrates the sensing of the terrain profile along the true ground track and the terrain profile along the INS ground track.

B.3. Theoretical overview

Estimating errors in an INS trajectory by measurements functionally related to the terrain profile beneath the vehicle requires application of nonlinear estimation theory. The sensed profile obtained along the true ground track is compared to DTED-derived profiles for possible horizontal locations of the vehicle within

a position uncertainty region and a fit-error surface generated. The sensed terrain elevation profile is obtained by subtracting the ground clearance measurements from vehicle altitude. The terrain elevation profiles from the DTED are produced by interpolating the DTED at the appropriate horizontal position along the translated INS ground track. The location with the best fit is the estimate of the vehicle's horizontal position.

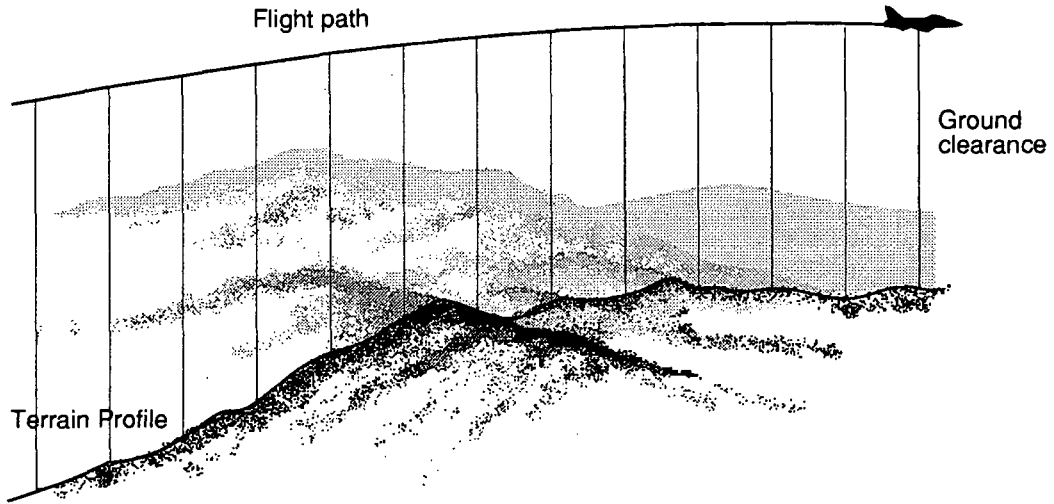

Figure B.1. TRN Process

Even in the simplest case of an INS with only position errors and an error-free altimeter, the correlation process may yield multiple solutions due to identical terrain profiles. Thus there is a fundamental issue of ambiguous solutions located in the vehicle initial position uncertainty region. Mean squared difference is the metric most often used for fit-error. In the error-free case the minimum of this surface is zero for both the correct and ambiguous solutions. Errors in the DTED and/or altimeter cause the surface to be positive at the minimum and increase the possibility of a position estimate far from the true position. The possibility of a "false fix" results from the nonlinear aspect of the estimation problem. Usually TRN performance specifications separate nonlinear (false fix) and linear (update accuracy) effects. The characteristics of system errors, the size of the uncertainty region, terrain characteristics and the vehicle ground track over the terrain are primary contributors to the probability of false fix.

The accuracy of the TRN position estimate for a simple case is derived from application of linear estimation theory. If one assumes independent profile measurement errors, the circular error probable (CEP) horizontal accuracy, where position biases between the actual and sensed trajectory in each of three dimensions are estimated, and terrain slopes are independent in the down-range and cross-range direction, is

$$CEP = 1.17\sigma_n \div (\sqrt{\sigma_s})$$

where:

- CEP is the circular error probable of the update (m)
- σ_n is the standard deviation of the profile measurement errors (m)
- σ_s is the standard deviation of local terrain slopes at the measurement locations in both down-range and cross-range direction
- N is the number of independent measurements.

σ_s parameterizes both terrain correlation length and elevation variation effects. While ref. 1 suggests that CEP can approach zero for some choice of N, INS velocity errors make arbitrarily small error unachievable in practice. Because of the measurement geometry, vehicle altitude (vertical position) errors in DTED coordinates are estimated more accurately than horizontal position errors. For this case, altitude error standard deviation is σ_n/N .

Using horizontal INS position errors modeled as independent random walks, with no altitude error, first principle covariance analysis leads to the expression,

$$CEP_{SS} = 0.57 \delta V^{1/4} (\Delta d/s)^{3/8} (\sigma_n/h)^{3/4}$$

where

- CEP_{SS} is the steady state circular error probable of horizontal position updates (m)
- σ_n is the standard deviation of the profile measurement errors (m)
- h is the deterministic local terrain slope at the measurement locations in both down-range and cross-range directions
- Δd is the distance between profile measurements (m)
- s is vehicle ground speed (m/s)
- δV is TNS maximum velocity error (m/s)

The primary value of ref. 2 is that it shows the sensitivities of accuracy to implementation parameters. Steady state CEP is most sensitive to σ_n/h , least sensitive to δV , and nominally sensitive to the time between profile measurements $\Delta d/s$. Using typical values of

- $\delta V = 1$ m/s (1 nm/hr-class INS)
- $s = 250$ m/s
- $\Delta d = 100$ m
- $h = 0.05$ (moderately rough terrain)
- $\sigma_n = 15$ m

results in a CEP_{SS} of 29m. Because of the assumptions leading to ref.2, predictions should be treated as approximations, a conservative lower bound for TRN accuracy.

DTED errors are not explicitly considered in refs.1 and 2. Lower accuracy is achieved when the DTED vertical (elevation) errors have the same correlation length as the terrain itself. This is conceptually reasonable since in this case the correlation process must accommodate errors that undulate statistically like the terrain itself. The lack of statistical error models for the only broad-area database available, US Defense Mapping Agency (DMA) Digital Landmass System (DLMS) Level 1 DTED, is the key reason TRN has not been developed to a theoretical level comparable to other navigation updating techniques like ground and satellite-based ranging systems.

B.4. Implementation considerations

TRN systems typically consist of four basic elements: an INS, an altimeter, a DTED database, and an algorithm executed by a flight computer. The function of the INS is to provide a stable three-dimensional approximate trajectory whose primary errors are horizontal position and altitude bias errors. A 1nm/hr class INS is a common choice. Either strapped-down or gimballed INS can be used. A barometric altimeter is traditionally used to stabilize the vertical dimension of the INS and can be retained in a TRN system. In either case, the navigation system vertical channel must be accurately modeled since TRN requires accurate measurement of the terrain profile.

DTED is a static database of terrain elevations over a prescribed geographical area. It may be produced from topographical maps of various scales, or stereo photographs of different resolutions. The DTED with

the widest geographic coverage is produced by the US DMA. DLMS Level 1 DTED have been productd for about 70% of the world's landmass and are distributed on compact disk read-only memory (CD-ROM) media (ref. 4). Level 1 DTED have an elevation value for each 3" in latitude and longitude within +50° latitude of the equator. Larger horizontal post-spacings (in degrees longitude) are used at latitudes greater than 50° to maintain approximately constant spatial sampling of the terrain. Postspacing is constant at 93m in latitude but varies around this value in longitude. Algorithm design and implementation are simplified and computer throughput minimized when DTED have constant horizontal post-spacing . When using Level 1 DTED, this requires a priori preparation of the flight DTED. As flight computers become more capable, the trend toward using Level 1 DTED as produced by DMA directly in TRN algorithms is likely to continue.

The function of the altimeter is to measure nadir ground clearance, the distance between the vehicle and the terrain at the same horizontal coordinates as the vehicle. Radar altimeters measure the distance to the closest point and the nadir ground clearance is a measurement error whose magnitude is a function of vehicle ground clearance and attitude, antenna beam pattern, and terrain characteristics. These effects can be eliminated with a laser altimeter gimbaled to point at nadir. Radar altimeter anennas used on aircraft typically have broad beam patterns that accomodate significant aircraft maneuvers while continuing to measure the closest point beneath the aircraft. Such altimeters have been used in most TRN applications. Radar altimeter antennas with narrow beam patterns require either gimbals of limiting terrain sensing to specific aircraft pitch and roll attitude limits. Attitude limits are a function of vehicle ground clearance. Whenever radar altimeters are used, modeling of beam pattern effects in the TRN algorithm will improve performance, especially at higher ground clearances.

Altimeters typically provide ground clearance measurements to the flight computer at a rate of the TRN algorithm and spacing along the ground track that is small with respect to the DTED horizontal post-spacing. Depending on the algorithm design and DTED source, meaurements may be either averaged or simply used as needed by the algorithm. Trees, foliage, ice, structures and other ground cover, as well as soil type, affect the altimeter meaurements. TRN system performance depends on the altimeter measuring whatever is contained in the database. For example, if the DTED contains elevation of tree top rather than the ground beneath the trees, the altimeter should range on treetops for best TRN correlation performance.

TRN algorithms must solve a nonlinear estimation problem in real time. Practical algorithms require a number of simplifying assumptions and in most cases were developed for specific aircraft avionics and for use in specific scenarions. Given this situation it is not surprising that a number of TRN algorithms have been proposed and developed over the last thirty years. The TERCOM approach developed for US cruise missiles (refs. 5,6 and 7) has a batch-processing throughput and memory, and an accurate INS. The missile flies a constant heading course over the DTED. TERCOM provides one position update for each DTED "patch" or matrix. Thus INS updates are infrequent. TERCOM was extended to accomodate arbitrary shaped trajectories over wide-area DTED (ref. 8). Algorithms of this kind must deal with vehicle manoeuvres and lower quality DTED. Sandia Inertial Terrain Aided Navigation (SITAN) (ref. 9) was initially developed for a specific weapon application that required vehicle manoeuvring, short flight distances, and relatively small initial position errors. These requirements led to an extended Kalman filter, recursive algorithm design that processes altimeter ground clearance measurements and produces an estimate of vehicle state every 100m along the vehicle ground track. A key idea is the use of stochastic terrain linearization to permit use of a single extended Kalman filter when horizontal position errors are much larger than the local terrain correlation lengh. The initial application led to "track-mode" SITAN. Later, a bank of parallel filters was used with decision logic (an "acquisition mode") to accommodate larger initial position errors (ref. 10). The SPARTAN algorithm (ref. 11), originally designed by A.R. Runnalls, uses maximum likelihood estimation in such a way that there is more measurement smoothing before incorporating measurement information into the Kalman filter than in SITAN but more frequent INS updates than in TERCOM. All current implementations use variations on one of these three basic approaches, e.g. terrain profile matching (TERPROM) (ref. 12) is based on an extended TERCOM acquisition mode coupled with a SITAN-like track mode.

Key implementation issues are the balance between on-board processing versus preflight mission planning and access to the stored DTED during flight. To minimize requirements on flight systems the DTED may be formatted into a grid with constant horizontal post-spacing data. Data compression may be used to minimize the amount of on-board storage at the expense of requiring in-flight reconstruction of the DTED. Storing only the DTED on the vehicle that may be used in a given mission lowers the required DTED storage capacity at the expense of requiring more pre-mission effort. The trend is to store the DTED of large areas on aircraft, and to use the DTED in the format in which it is supplied by DMA: during flight the DTED of the area being over flown is extracted from the large capacity storage device and placed in a buffer where it can be rapidly accessed by the TRN algorithm. How this is done is often determined by DTED access requirements of other system functions like low-emissions TF/TA. The flight computer interfaces to the altimeter, TNS, etc. are not usually affected by TRN.

The primary determinants of incremental flight computer resources needed to implement TRN, beyond accessing the DTED and placing it in a buffer, are the speed of the vehicle and the size of the largest horizontal position errors that the system must accommodate. Higher vehicle speeds require greater computer throughput. The required maximum position error depends primarily on the longest anticipated flight without updated and INS quality.

B.5. System considerations

TRN position estimates are referenced to the stored terrain data and are insensitive to bias errors in the terrain elevation data. Because of this characteristic, TRN systems are especially useful in applications that require accurate navigation relative to targets, obstacle, structures, and other features whose locations are derived from the same sources as the stored terrain data. Example applications include low-emission TF/TA, target cueing for standoff weapon terminal sensors, ground proximity warning and indirect ranging (refs. 13,14 and 15). Three dimensional position bias errors made in the DTED production process can be estimated by a combined satellite navigation (GPS and/or GLONASS) and TRN system. This is especially important in systems using the DTED for TF/TA since DTED bias errors cannot be estimated by satellite navigation alone. Satellite navigation is performed in world-wide coordinates and has no reference to errors in the DTED used for TF/TA. Thus, even through the absolute accuracy of a satellite system may be superior to a TRN system in world-wide coordinates (e.g. World Geodetic System (WGS)), a TRN system may be more accurate with respect to obstacles and features within the DTED because of errors made in registering the DTED to world-wide coordinates. Used alone, TRN systems can only estimate the total bias in each position dimension with respect to the INS position but cannot estimate the constituent parts of the total bias in each coordinate ; DTED position bias errors and INS errors.

The improve underlying INS accuracy, TRN systems must be used in areas for which terrain of sufficient roughness and DTED of appropriate accuracy and quality are available. The area over which the TRN system searches for updates is an important consideration since it determines the TRN system's ability to correct TNS drift error accumulated during periods of no updating. The larger the search area the greater the possibility of false fix. A false fix that is recognized by the TRN algorithm logic is not of particular concern, but large search areas do require greater care in design and testing of the TRN algorithm to ensure that no unrecognized false fixes are used as INS updates.

The robustness of the TRN system design to DTED error processes is perhaps the most important consideration for system developers. As used herre, robustness is the ability of the design to navigate in the presence of a variety of DTED errors. Because of its broad-area coverage, Level 1 DTED is used by most TRN systems. TRN system performance using Level 1 DTED is very repeatable over the same geographical area but tends to vary from one geographical region to another. This is caused in part by terrain and ground cover differences but primarily by the varying characteristics of DTED. In TRN systems some areas may need to be reworked or the TRN algorithm changed to accommodate the errors discovered. This learning process is inevitable until world-wide DTED derived form the same source materials become available.

With very accurate and expensive-to-produce DTED, system horizontal position accuracies rivaling those of GPS can be achieved for TRN. In TRN systems using Level 1 DTED over broad areas, accuracies in the range of 50-200 m CEP are typical for low-flying aircraft. Since TRN systems require terrain roughness and operate best at low ground clearance, they are especially attractive for use in covert attack TF/TA systems. Conversely, these are the flight regimens that cause satellite-based systems the most problems; satellite line-of-sight masking by the airframe or terrain, and signal jamming. Low probability of intercept radar altimeters are often considered for use in these applications.

Most TRN systems implemented to date are add-ons to existing avionics systems. These systems are termed "loosely coupled" because TRN INS error estimates are simply added to the output of the standard INS solution in software. Future systems are likely to be more tightly integrated with real time estimation and correction of INS inertial sensor parameters.

B.6. Outlook

The coincidence of commercial and military requirements in combination with advances in computer, communications and satellite technology will ensure availability of very accurate, high-quality, world-wide databases of both DTED and feature data early in the twenty-first century. By using satellite positioning, the absolute position of terrain and features will be known to sub-metre accuracy. These databases will be used pervasively in military aircraft to enable no-emission TF/TA, very accurate indirect ranging and ground proximity warning. TRN will be used in integrated avionics systems to provide navigation redundancy and to improve position estimation accuracy.

The availability of significantly greater computer throughput, memory and mass storage will lead to implementation of more capable TRN algorithms: performance improvements will be greatest at higher ground clearance and over very rough terrain. Altitude position estimation accuracy will be improved over that available from satellite-based sensors alone. This is because altitude error is greater than horizontal error in satellite-based sensors, TRN is especially sensitive to altitude errors, and the DTED will be accurately positioned with respect to world-wide coordinates.

Over the next ten-to-twenty years, TRN will be integrated with GPS/INS systems to improve low-emission TF/TA, indirect ranging and ground proximity warning performance when using Level 1 DTED. TRN will enable conversion of local DTED coordinates into world-wide coordinates in areas of sufficient terrain roughness.

Operational use of TRN by the US is currently limited to the TERCOM system used for cruise missile guidance. TRN integration with GPS/INS in fixed and rotary-wing attack aircraft is an area of current development in Europe, Australia and the US. Fielding of several operational systems during the decade is anticipated.

Appendix B References

1. Hinrichs, PR. "Advanced Terrain Correlation Techniques", TEEE Position Location and Navigation Symposium, 1972, p394 (also in Kayton, Myron, NAVIGATION LAND, SEA, AIR & SPACE, TEEE Press, 1990, pp288-295).
2. Hostetler, L.D. and Andreas, R.D. "Nonlinear Kalman Filtering Techniques for Terrain-Aided Navigation", TEEE, transactions on Automatic Control, Vol AC28; No3, March 1983, p320 (also in Sorenson, H.W. KALMAN FILTERING THEORY AND APPLICATION, TEEE Press, 1985, pp325-333).

- 3 Maybeck, P.S. STOCHASTIC MODELS, ESTIMATION AND CONTROL, Vol. 1, Academic Press, 1979, p300.
- 4 US Defense Mapping Agency, DIGITIZING THE FUTURE, 3rd Edition.
- 5 Sorrels, C.A. US CRUISE MISSILE PROGRAMS, McGraw-Hill, 1983, p9.
- 6 Werrell, K.P. THE EVOLUTION OF THE CRUISE MISSILE, Air University Press, 1985, p136.
- 7 Betts, R.K. ed. CRUISE MISSILE, TECHNOLOGY, STRATEGY, POLITICS, The Brookings Institution, 1981, p7.
- 8 Bialecke, E.P. and Lewis, R.C. "A Digital Terrain Correlation System for Tactical Aircraft", TEEE/AIAA 5th Digital Avionics Systems Conference Proceedings, Oct 31-Nov 3, 1983, pp14.1.1.
- 9 Hostetler, L.D., "A Kalman Approach to Continuous Aiding of Inertial Navigation Systems Using Terrain Signatures", TEEE Milwaukee Symposium on Automatic Computation and Control Proceedings, April 1976, pp305-309.
- 10 Boozer, D.D., Lau, M.K. Fellerhoff, J.R. "The AFTI/F16 Terrain-Aided Navigation System", Proceedings of the TEEE National Aerospace and Electronics Conference Proceedings, May 1985, pp 351-357.
- 11 Henley, A. J. "Terrain Aided Navigation – Current Status, Techniques for Flat Terrain and References Data Requirements", TEEE Position Location and Navigation Symposium Record, Mar 20-23, 1990, pp608-615.
- 12 Robins, A.J. "Recent Developments in the "TERPROM" integrated Navigation System", Proceedings of the Institute of Navigation 44th Annual Meeting June 21-23, 1988, pp58-65.
- 13 Beal, C. "World in a box : Air Leaps Forward, International Defense Review, Vol. 25, May 1992, pp417-422.
- 14 Priestly, N. "Terrain Referenced Navigation", TEEE Position Location and Navigation Symposium Record, Mar 20-23, 1990, pp482-489.
- 15 Benett, P.J. "Enhanced Navigation and Displays form Passive Terrain Referenced Avionics", Proceedings of the TEEE National Aerospace and Electronic Conference Proceedings, May 1988, pp209-216.

APPENDIX C - COUNTERMEASURES

As defined by the Joint Chiefs of Staff of the United States Department of Defense, a countermeasure (CM) is an action taken to prevent or reduce an enemy's effective use of the electromagnetic spectrum and a counter-countermeasure (CCM) is an action taken to insure friendly effective use of the electromagnetic spectrum despite an enemy's use of CM.

C.1. Radar Countermeasures

The large variety of CM commonly employed against radar guided munitions is discussed in the following pages. The techniques described can be used in isolation or in combination with one another. Similar techniques can be applied to other RF systems, including radio navigation, communications, data/command links, etc.

C.1.1. Noise Jammers

Noise jammers are RF countermeasures techniques that increase the noise level in RF receivers. Jammer-induced noise raises the noise floor in the RF receiver and reduces the target acquisition sensitivity, reducing the acquisition range and introducing noisy tracking signals. A noise jammer may effectively deny the victim radar the ability to measure range and range rate. Thus, the missile must be closer to the target before it acquires it, and will be faced with poorer angular resolution in its tracking circuits.

Spot Noise. Spot noise is continuous noise-like RF power usually spread across a single band of frequencies. Ideally, the bandwidth is just wide enough to include all frequencies of the victim's signal, so as to concentrate the jammer power in those frequencies. A spot jammer can be either responsive (starting when it senses a victim signal it has been programmed to jam) or non-responsive (started by some other signal).

Barrage Noise Jammer. A barrage noise jammer is similar to a spot jammer, but its noise bandwidth is greater. Both the center frequency and bandwidth can be set manually or automatically. Barrage noise can be effective against broadband receivers such as spread spectrum and frequency-hopping radars.

Swept Noise. Swept noise is generated by sweeping a narrow bandwidth noise signal across a broader range of frequencies. This CM is typically set to disrupt the victim's mode switching, automatic gain controls, constant false-alarm rate detectors, angle tracking, and so on.

C.1.2. Deception Jammers

There are three classes of deceptive jammers: high-duty factor coherent repeaters, and low-duty factor repeaters or transponders. Repeaters use broadband amplifiers to amplify incoming signals and to introduce deceptive modulations before retransmission. High duty-factor repeaters are usually used against CW and pulsed-Doppler systems, and employ deception techniques that maintain output signal coherency with the incoming RF signal. Repeaters may modulate their signals or use a straight-through repeater with no modulation. Their outputs may be a replica of the input signal plus spurious signals (such as harmonics).

Transponders do not repeat the incoming signal; they trigger a separate transmitter at the same or different frequency. The transponder output may, therefore, be non-coherent with the incoming signal. A technique called predictive gating allows the system to transmit a pulse whenever it chooses, as soon as a fraction of a microsecond before the anticipated reception of an RF pulse in the transponder receiver.

Velocity Gate Stealer. A jammer using a velocity gate stealer (VGS) coherently repeats the victim's signal, shifting its frequency by some f according to a preset program. The effect of VGS is to capture a victim's velocity-tracking gate, move it away from the target's skin return, and "dump" it. The gate may be dumped at a frequency where there is no return of any kind, where there is clutter, or where there is a "velocity hook". VGS will be ineffective against a victim that does not track velocity.

False Doppler Targets. The false Doppler target generator (also known as a multiple frequency repeater) is a coherent repeater that produces a signal at a number of frequencies spaced around the frequency of the target echo. Spacing between adjacent frequencies may be constant or variable, and some frequencies may be enhanced.

Range Gate Stealer. A range gate stealer transmits a false target return with a time delay that slowly increases from the radar pulse time of arrival to simulate an increasing target range. The time delay then snaps back to its minimum value and the cycle is repeated. A range hook, which is a false target at the maximum delay, is often left in place. The objective is to capture the range tracking gate of a low-or-medium-PRF system during the dwell time, and then retransmit the pulse to produce an apparent range change. It is ineffective against a victim that does not track range.

Cross Eye. Cross-eye jamming combines two RF signals generated by widely separated antennas on the jamming platform to produce an interference pattern with a null at the victim's antenna. The two signals phases are controlled to be 180° out of phase at the victim's antenna. Classical cross-eye CM is used against active systems. It causes errors in the victim's angle tracking, and becomes more effective as the range closes (being most effective at a few miles). Amplitude modulation applied to the jamming signals will cause the missile's angle measurement error to vary, presenting what then appears to be a maneuvering target.

Repeater Noise. Repeater noise is produced by a coherent repeater modulated in both frequency and/or amplitude to produce a very narrow noise spectrum that is reradiated over a repeated RF signal. It is used to mask the target skin return (forcing the victim radar into a jammer angletrack mode), to provide a relatively smooth return that prevents the victim CFAR (constant false alarm rate) threshold from detecting the target or jammer, to provide a sequence of random frequencies that appears as false targets, and to provide a narrow-band, apparently incoherent return that will confuse the receiver's frequency tracker.

False Range Target. A false range target generator creates one or more false targets in the main beam or sidelobes of a victim's radar. For low-PRF radars and seekers false targets are generated either by delay lines or by using a coherent memory. Signals are reradiated with appropriate delays at amplitudes greater than those of the skin returns. If the victim is using a linear FM ranger false targets can be introduced by a repeater that produces ambiguities in the victim's ranging modulation. False targets are not limited to the main beam; they can be generated for the sidelobes if the transmitter has sufficient power.

Phase Modulation. Phase modulation jamming is typically used against a system that incorporates some form of intrapulse phase modulation. An example is a radar or missile seeker that uses a phase-coded pulse for implementing pulse compression. The jammer reradiates the victim's pulse, but with altered phase modulation. Possible modulation formats include a constant phase shift over the pulse duration, alternate 0°-180° phase shifts, or a unique code optimized based on knowledge of the victim's code. The effects of phase modulation depend on how the victim uses intrapulse modulation and the nature of the jammer's modulation program. Typical effects include suppression of the target signal (prevents the victim from acquiring the target), and erroneous measurement of range and/or frequency of the target echo.

Straight-through Repeater. A straight-through repeater receives, amplifies, and retransmits the victim RF signal without inducing any phase, frequency, or amplitude modulation. It is a signal augmentor used primarily with on-board techniques such as surface bounce or non-adaptive cross

polarization, or on decoys. The objective is to create a return larger than skin reflections from the target being protected.

Inverse Gain. Inverse gain describes a class of amplitude modulation techniques designed to counter the ability of a victim radar to determine a target's angle by spatially scanning its antenna beam. This jammer must be on or near a target to protect it. When used against a conical scan radar, inverse gain can induce angle tracking errors that drive the victim's antenna off the target.

Cross Polarization. A cross polarization jammer attempts to transmit an RF signal with a polarization orthogonal to that of the victim's signal. In adaptive crosspolarization jamming the jammer measures the polarization axis of the victim's signal and orients the polarization of its own transmission relative to that axis. It may "rock" tilt and ellipticity about some nominal value. Cross polarization jamming degrades angle measurements, possibly leading to antenna drive off or, in an RF guided missile, increased guidance noise causing loss of kinetic energy.

Amplitude Modulation. Both noise and deception jamming can be amplitude modulated. Jamming is turned off and on, either gradually with a triangular or sinusoidal envelope, or abruptly, with a rectangular envelope. This technique attacks home-on-jam, skin tracking, automatic gain control, and critical system frequencies such as angle scan and multiplex. It can generate false targets, degrade signal processor performance, and produce mode confusion.

Antenna Lobe Modulation. This is a noise or repeater mode in which the amplitude history of the signal seen by a searching victim radar is distorted as its main antenna lobe traverses the jammer aircraft. In one version the jamming signal amplitude varies so the jammer produces a constant return over a relatively long interval. The jammer might also vary when the victim's main beam traverses the jammer so that the jammer produces a peak return displaced from the true line-of-sight. Or, when the victim radar scans continuously in one dimension then hops discretely, in bars, in the orthogonal direction, the jamming signal varies in discrete steps at the bar rate. The victim of antenna lobe modulation is a scanning radar. If such a radar scans continuously in azimuth and steps discretely through two or more bars in elevation, the jamming may frustrate the transition from searching to single-target tracking because there is no definite azimuth. If the radar uses apparent target extent as a means for estimating the number of targets, antenna lobe modulation may indicate multiple targets where only one is present. The target may appear to be undergoing violent maneuvers that may induce large track errors or track splits in the victim radar.

Glint Enhancement. To simulate glint the jamming signal is transmitted alternately from different antennas, switching from one antenna to another either sequentially or randomly. More than two antennas, or antennas with different polarizations, can be used. In general, glint enhancement is used in combination with other CM techniques. Its primary effect is to increase the overall effectiveness of the other jamming techniques. For instance, during the final seconds of a missile's flight, glint enhancement can increase guidance noise and thereby increase miss distance, especially if the missile employs adaptive guidance filtering based on angle noise.

Image Jamming. The image jammer places the jamming signal at the image frequency of a superheterodyne receiver. A receiver may have several stages of conversion and, hence, several images. Image jamming reverses the sense of error-correction voltages for automatic frequency control loops, or detected angle errors, or both. This could stop a missile from acquiring and tracking the frequency of the target echo and guiding properly.

Continuous Wave (CW) Jamming. In CW jamming an oscillator produces a narrowband signal without repeating the received victim signal, or a repeater is modulated. There are three types of CW jammers: skirt, comb jamming, and delta modulation. In skirt jamming a CW line is produced in the skirts of the Doppler search window or central band filter of the victim receiver. This forces the receiver to track a signal lying outside its intermediate frequency passband. Comb jamming produces spectral lines or spots of repeater noise at preselected frequencies over as many as several hundred MHz. Comb jamming results

in signals across a band of frequencies including all those used by a receiver; the receiver finds all available frequencies subject to jamming. In conventional delta jamming the jammer transmits two high-power CW signals whose frequency difference is the fundamental or a subharmonic of the victim's first IF stage. The signals would normally be positioned within the victim's RF passband, but not close to the victim's specific operating frequency. If properly implemented the delta jammer produces a spurious IF signal that dominates all other IF signals, and causes the detected angle error to be an even function of angle rather than a linear function.

Retrodirective Antenna System. A retrodirective antenna system enables a jammer to direct a narrow beam of jamming energy at each of one or more victims. The narrow beam produces high antenna gain, giving the jammer high effective radiated power. The system must measure the angular direction of each incoming victim signal to point the retrodirective antenna. Because of the high gain this jammer can jam at longer ranges.

Cover Pulse. Cover pulse jamming is a carrier that is transmitted in pulses synchronized with pulses in the victim signal. To be most effective the jammer signal should be larger than the victim signal, its pulse width should be greater than the victim's pulse width, and the jamming pulses must lead the victim pulses. Cover pulsing gives a jammer two advantages: first, it can concentrate jamming power over the victim's signal and, second, because of its timing it effectively denies the victim the information needed to implement a counter CM.

High-Power RF Jammers. High-power RF jammers direct very intense RF power at an aircraft or missile to upset or burn out critical electrical components. High power RF radiation is potentially effective against any electrical component. For example, when a missile is illuminated by high-power RF, its actuators may freeze. If the power is high enough, the target will leak radiation into some critical component that will be rendered ineffective.

Chaff. Chaff is composed of elemental passive reflectors, absorbers, or refractors of electromagnetic radiation. It is dispensed in the atmosphere to confuse, screen, or otherwise adversely affect the victim electronic systems. Common examples of chaff are metal foil strips, metal-coated dielectrics (aluminum, silver, etc. on plastic or glass), aerosols, stringballs, rope, and semiconductors. Chaff is commonly thought of as thin metallic or metal-coated dielectric strips or rods of various lengths and frequency responses that passively reflect energy. Chaff can be made to be effective over a broad frequency range, and it can be effective against many radars simultaneously.

C.2. Electro-optical Countermeasures

With the potential exception of high power microwave energy, electro-optical (EO) guidance systems do not respond to the countermeasures designed for radar guidance. The significance of the reference to high power microwaves is that, although the energy is outside the seeker's normal operating band, it is difficult to shield detectors against the effects of high power radio frequency sources at close range. In general, countermeasures against EO seekers are designed to be effective over the relatively short distances appropriate to the maximum range EO seekers. The wide variety of EO CM include passive camouflage, concealment and deception (CCD), and active sources used for blinding and spoofing.

C.2.1. Concealment

CCD is the means by which an object is concealed by disguising and changing its appearance, such as by paint or background matching nets, etc.

Concealment ranges from obstructing the view of a hot part of the target to hiding the target under nets, foliage, or earth. Signature suppression can be accomplished through such concealment and also through shape, surface preparation, self-illumination, active heating/cooling, and wake control. Terms such as "stealth" and "low observables" imply the reduction of observable contrasts. Shadows and natural

features can be used to mask the target. The primary camouflage techniques today are screening (nets) and disruptive pattern painting.

Obscurants can be used to reduce target contrast and may be dedicated to the purpose of completely hiding the target, for example smoke generators. Obscurants can also occur naturally such as fog or as a by-product of other effects such as dust and smoke from battlefield activity. They need not remove all contrast, but rather reduce it to the point that other objects appear as more probable targets: in this context the combination of obscurants with decoys is even more effective. Burning oil drums for example, while providing smoke to conceal the target or targets also provide a bright source decoy for spot source tracking systems.

C.2.2. Decoys

Expendable decoys, in the form of flares dispensed from aircraft for example, are widely used. They have the virtue of low cost and are effective against heat-seeking non-imaging IR seekers. Flares burn a highly reactive fuel creating an intense energy source which provides more energy in the sensor passband than the target emissions. A simple tracker will decoy towards the flare causing it to lose lock on the target. More sophisticated sensors might use colour or target trajectory to differentiate between the target and the decoy, but there is always a trade between cost and complexity of the CM and the munition. For example, flares may be aerodynamically designed to more nearly simulate a realistic aircraft trajectory but at greater cost and a reduction in the numbers carried. Imaging seekers are practically immune to flares unless they emit such high levels of radiation in the narrow passband of the detector as to dazzle the seeker: again size and cost are limiting factors for aircraft.

C.2.3. Active CM

Active CM use a source of energy to blind or confuse the seeker. They can be in-band or out-of-band.

Out-of-band CM operate outside the seeker's normal passband are generally taking advantage of secondary effects such as heating or electronic circuitry disruption. For example, a high power carbon dioxide laser might be used to thermally disrupt a sensor operating in the visible or the short wave infrared bands. Likewise, high power microwave energy can be directed into a detector and transmitted into sensitive circuitry causing adverse secondary effects. Either method requires a stable means of tracking and delivering energy to the seeker.

In-band CM operate within the passband of the sensor with the aim of causing confusion or to actually blind or destroy the sensor. Lasers such as those mentioned in connection with out-of-band CM can be tremendously more effective when operating in the sensor's passband when the CM energy is transmitted to the detector with the magnification inherent in the optical system. The optical gain may reach many orders of magnitude, with a corresponding reduction in the CM energy needed to blind or permanently disable the seeker.

Modulated CM sources can be used against scanning seekers if their operating characteristics are known. They require much lower power lasers and aim to confuse the detector system. They are however ineffective against imaging seekers. Typically they involve modulation at the spin frequency to interfere with the normal modulation process of rotating or nutating reticle receivers (or choppers), which are typical of those used in "hot-spot" IR guided anti-aircraft missiles. A more complex CM could create the appearance of false targets to distract or decoy the seeker. There is a trade between the power required of the CM and the complexity of the signal transmitted which requires detailed knowledge of the seeker and its vulnerabilities. Because of the drastic reduction in required power or the equivalent increase in effective range of the CM, the acquisition of weapon characteristics is a primary goal of intelligence gathering and exploitation efforts.

Finally, it is worth noting that EO CM against humans may preclude an operator launching or completing the actions necessary for full weapon operation. The pilot of an aircraft may be prevented from reaching the launch point, the weapon operator prevented from effecting the launch sequence, or the operator-in-the-loop controller prevented from guiding the weapon to target acquisition or impact. Bright active sources including – but not limited to – lasers can distract, stun, disable, or permanently impair vision.

APPENDIX D. RELATIVE GPS TECHNIQUES

D1. Introduction

Many weapons and weapon carriers will have an avionics suite that includes an integrated INS/GPS set. This means of navigation motivates examination of whether very high accuracy (10ft (3m) CEP) may be obtainable using only this set of weapon avionics operating in a *relative* GPS mode, rather than in an *absolute* GPS mode where CEPs of 30 to 40ft (9 to 12m) would be expected (ref. 1). This appendix will explain how 10ft accuracy may be achieved and it will present several different weapon system concepts that exploit such a capability to rapidly attack targets.

Fundamentally, two problems must be solved to achieve an overall accuracy of 10ft: firstly, target location must be determined to better than 10ft, and secondly, the GPS/INS equipped weapon must be guided accurately to better than 10ft. This paper will explain how the use of *relative* GPS can solve the guidance problem and how the use of *relative* targeting in a GPS based coordinate system can solve the target location problem.

The appendix begins with a discussion of relative GPS and reports the results of actual experiments to determine accuracy degradation of relative GPS guidance systems as a function of baseline length and targeting latency. Baseline lengths of up to 540 nm (1,000km) and latencies up to 15 minutes are considered, showing that relative GPS guidance may achieve high accuracy over baselines and latencies useful for tactical applications.

Next, the target location part of the problem is addressed. There must be an accurate sensor that locates the target relative to the GPS reference receiver. The sensor may be on either the launch aircraft or at a remote location. The target could also have been located prior to the mission.

Real-time target location concepts that will be explained include the use of aircraft equipped with an INS/GPS/Synthetic Aperture Radar (SAR) avionics suite to perform a real-time relative targeting function for weapon initialization. The importance of reasonable aircraft maneuvers to enhance observability and speed up the three-dimensional (3-D) targeting fire control solution will also be addressed. Simulation results for several realistic scenarios will be presented.

Finally, several concepts will be discussed that all make use of highly accurate premission relative target positioning, i.e., the ability to specify the 3-D location of two points, or localized areas, on the earth relative to each other in a suitable reference frame such as WGS-84. It is of interest to speculate how such a capability could be exploited in a precision strike context. Scenarios involving several existing or planned weapon systems will be described.

D.2. Definitions and Concepts

Relative GPS techniques can be used to remove the large, highly correlated common mode GPS errors between two receivers at a particular time and achieve accuracies of a few metres. In this application, one GPS receiver is used in navigating the weapon, whereas the other receiver is involved in the targeting. The key to achieving high accuracy is to require that both receivers use a common set of GPS satellites for navigation. In this way, correlated errors cancel out of the relative navigation solution. Not all error sources are perfectly correlated, however, and the degree of correlation tends to decrease as the distance between the two receivers – the baseline length – increases. Also, the correlated errors themselves change slowly with time, so that if corrections are to be used at some time after they are computed, an additional positioning error will be introduced. The effects of these error sources need to be quantified before relative GPS techniques can be applied to guidance problems. It is the effects of these errors – the spatial and temporal decorrelations – that the experiment reported in Section D.3. measures.

The cartoon sequence of Figures D.1. through D.4. is meant to illustrate the ideas described in the previous paragraph. In Figure D.1, two identical receivers are located at true position B and they are made to track the *same* 4 or more satellites. Although both identical receivers are in error from the true position B by an uncertain amount – say 40ft (12m) – due to major error sources such as satellite clock drift, ephemeris errors, and propagation delays, they both read the *same* position with the exception of much smaller errors expected to be random and on the order of one or two metres. These smaller remaining errors include receiver noise and quantization errors, receiver interchannel biases, and to some degree, multipath effects.

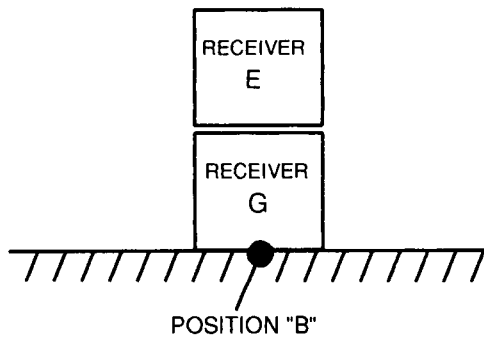

Figure D.1. The Relative GPS Concept - 1

In Figure D. 2, receiver E is now on a weapon whose guidance system receives the broadcast position of receiver G (G is located at the target). As long as receiver E tracks the same satellites as receiver G, and the weapon guidance system follows its commands with small errors, then the weapon will guide to impact at receiver G within the limits of receiver noise. Even though the absolute position coordinates of receiver G and receiver E may be incorrect, the "target" position B would be reached essentially perfectly. Clearly, receiver G position would need to be broadcast continuously if both receivers use C/A code only and selective availability (S/A) is turned on. However, the use of GLONASS receivers or P(Y) code receivers may allow targeting to be done with one data transmission of target position and the identity of satellites being tracked by the "targeting" receiver. Thus a central question is: "can one transmission of receiver G position and the satellites it is using, be sufficient for receiver E to guide the weapon to receiver G?" Alternatively stated, the question is: "how far in time prior to impact can the transmission be performed and still achieve better than 10ft (relative) accuracy at impact?" Experimental results described in Section D. 3. will answer this question.

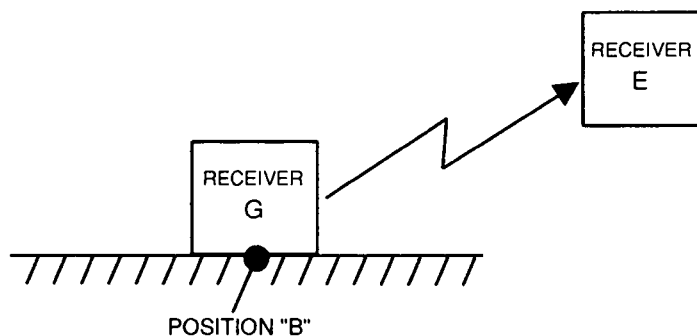

Figure D.2. The Relative GPS Concept - 2

In addition, the target location problem needs to be addressed because it is not usually practical to put a broadcasting GPS receiver on the target! The next step in the cartoon sequence is thus to move receiver G some distance away from the target while still maintaining its accurate location relative to that target.

Figure D. 3. shows the target and receiver locations and the relative location vector between receiver G and the target – \overline{RTL} .

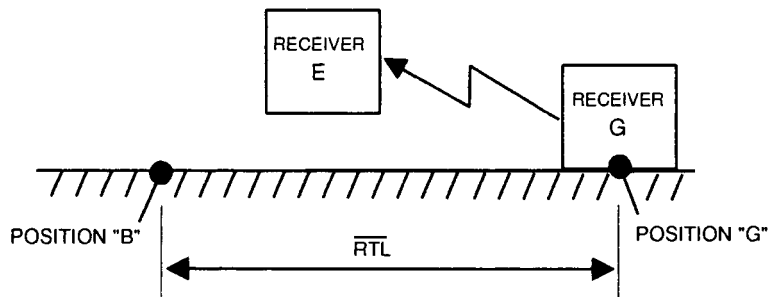

Figure D.3. The Relative GPS Concept - 3

Note that now two additional sources of error have been introduced. First, a spatial error in the GPS coordinates of the target because the reference receiver G is not located exactly at the target. The central question is: "how far can receiver "G" be from the target and still predict with better than 3m relative accuracy what receiver E should read at the target?" Experimental results described in Section D. 3. will answer this question.

The second additional source of error is in the scheme used to measure the relative location between the reference receiver G and the target. There are various means to determine the relative location vector, \overline{RTL} to the target. In one of the schemes described in Section D. 4, a high resolution SAR radar is used to locate the target relative to the aircraft in coordinates established by the aircraft INS/GPS system (receiver G). The target coordinates are used by the GPS/INS guided weapon (receiver E). These approaches are summarized in Figure D.4.

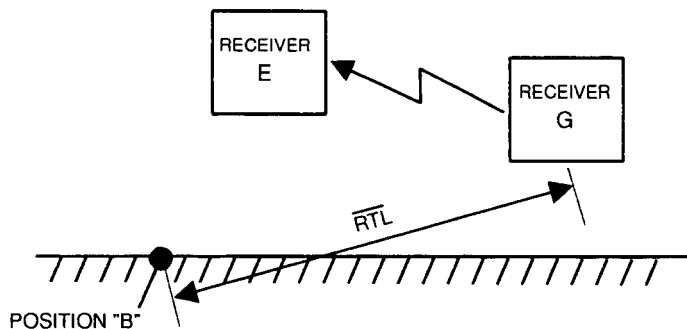

Figure D.4. The Relative GPS Concept - 4

In contrast, for the weapons systems described in Sec. D. 5, in which the reference receiver "G" is located on the ground, the relative location vector is determined prior to the mission. All of the approaches to be described require the two receivers being able to receive signals from a common set of GPS satellites while possibly separated by ground distances of several hundred miles. Section D. 6. will show this to be true for separations greater than 540 nmi. Finally, Section D. 7. gives some concluding remarks.

D.3. Experimental Relative GPS Accuracy with Separations in Time and Horizontal Distance

The experiment was implemented by placing GPS receivers at eleven sites across the continental United States (ref. 2). Data was collected in two phases: one on the East Coast conducted in December 1993, and one on the West Coast conducted in March 1994. Figure D.5 is a map showing the locations of the receiver sites and baselines used. Table D.1 lists baseline endpoints and baseline lengths. Over thirty hours of

receiver data was collected for each of the eight East Coast baselines, approximately half of that at a 1 Hz sampling rate, the other half at a 1/30 Hz rate.

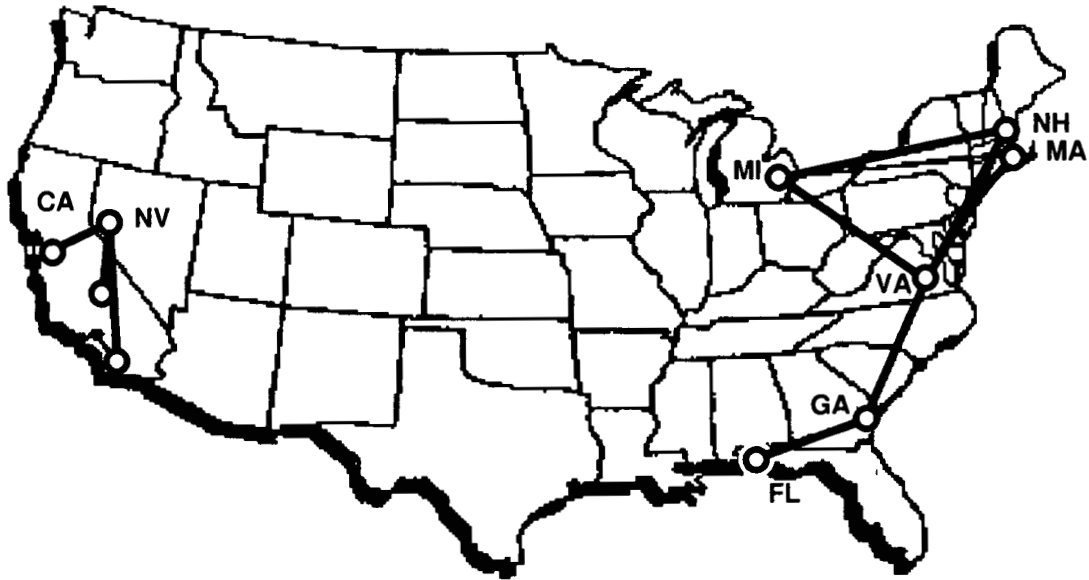

Figure D.5. East and West Coast Baselines

Between twelve and sixteen hours of receiver data was collected for each of the West Coast baselines, all of it at a 1/30 Hz rate. The absolute positions were established by independent means. The experiment consists of reading the GPS receiver at one location, adding to its position the relative location vector to a second receiver, and then predicting what the second receiver reads given that it is commanded to use the same satellites as the first receiver.

East Coast Baselines

Endpoint	Endpoint	Baseline Length (nm)
Cambridge, MA	Portsmouth, NH	45
Eglin AFB, FL	Ft. Stewart, GA	263
Langley AFB, VA	Cambridge, MA	400
Langley AFB, VA	Ft. Stewart, GA	405
Langley AFB, VA	Portsmouth, NH	442
Langley AFB, VA	Willow Run, MI	452
Willow Run, MI	Cambridge, MA	552
Willow Run, MI	Portsmouth, NH	558

West Coast Baselines

Endpoint	Endpoint	Baseline Length (nm)
San Diego, CA	Long Beach, CA	80
Stockton, CA	Fallon, NV	152
Ft. Irwin, CA	Fallon, NV	268
San Diego, CA	Fallon, NV	409

Table D.1. Baseline Endpoints and Baseline Lengths

To obtain a single value indicator of expected three-dimensional error, bias and standard deviation have been combined in the following way: bias and standard deviation are first computed for each position coordinate (north, east, vertical); the three bias components are combined in a root-sum-square (RSS) sense to give an undirected bias magnitude; similarly, the three standard deviation components are combined in an RSS sense to give an undirected standard deviation magnitude; the undirected bias magnitude and undirected standard deviation magnitude are themselves combined in an RSS sense to give a statistic simply called the "total error." The total error represents, in a geometrically intuitive way, how a large number of baseline vector measurements would be expected to differ from truth. In the results following, the total error bias and standard deviation components are shown separately at first, combined afterward.

Figures D.6a and D.6b show the bias and standard deviation components, respectively, for the East Coast data as a function of baseline length. Individual data points represent the statistical results of a single data collection session, typically two to four hours in length. Figures D.7a and D.7b are the corresponding error components for the West Coast data.

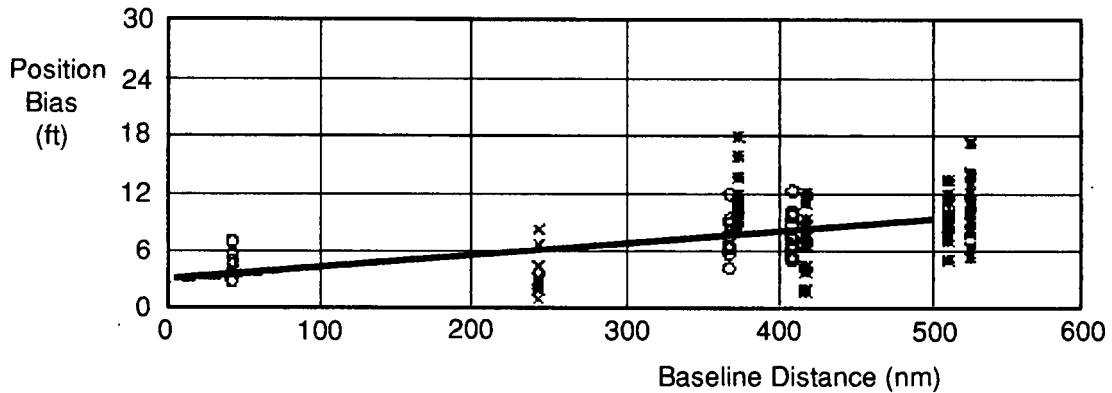

Figure D.6a. Bias Component of Error, East Coast Data

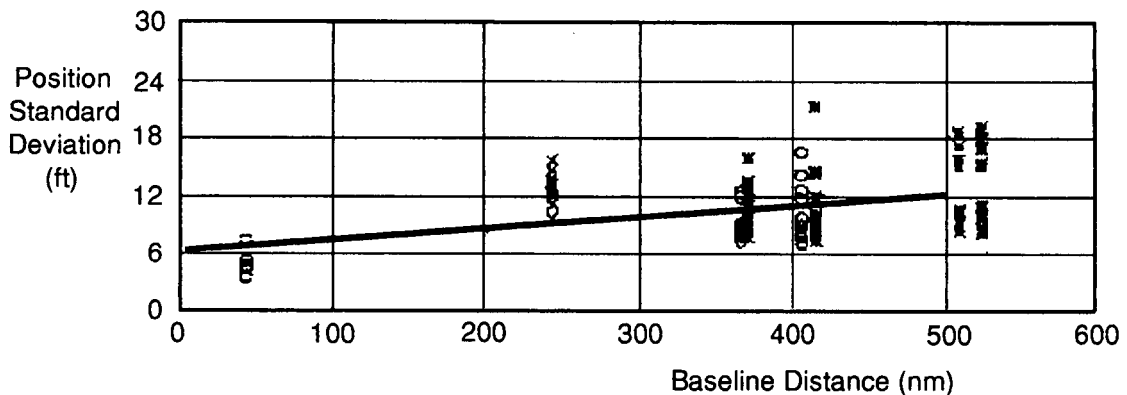

Figure D.6b. Standard Deviation Component of Error, East Coast Data

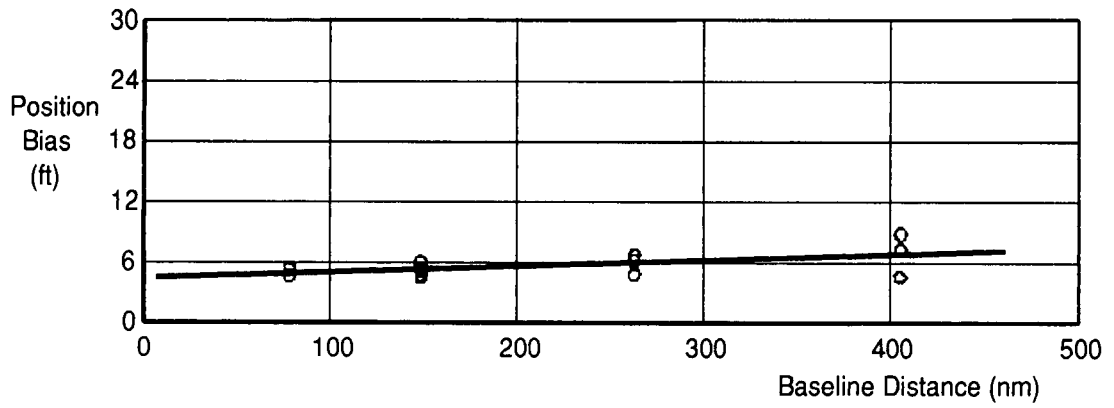

Figure D.7a. Bias Component of Error, West Coast Data

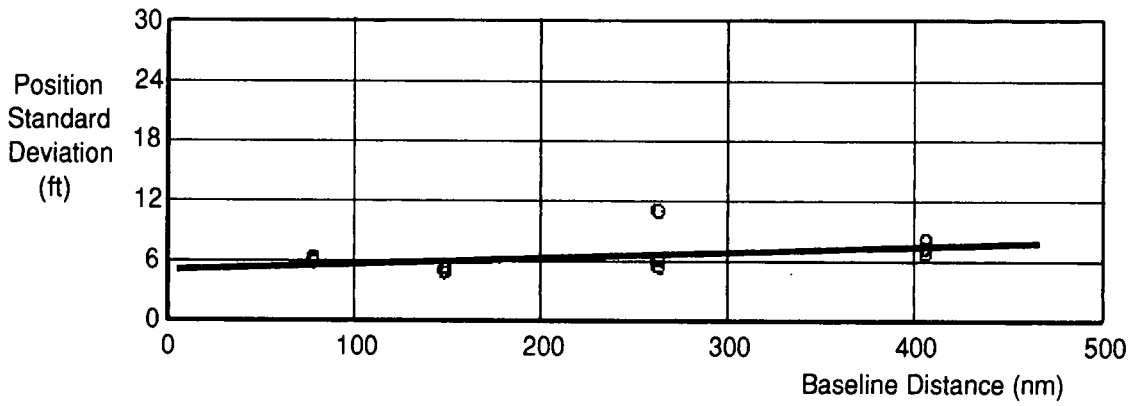

Figure D.7b. Standard Deviation Component of Error, West Coast Data

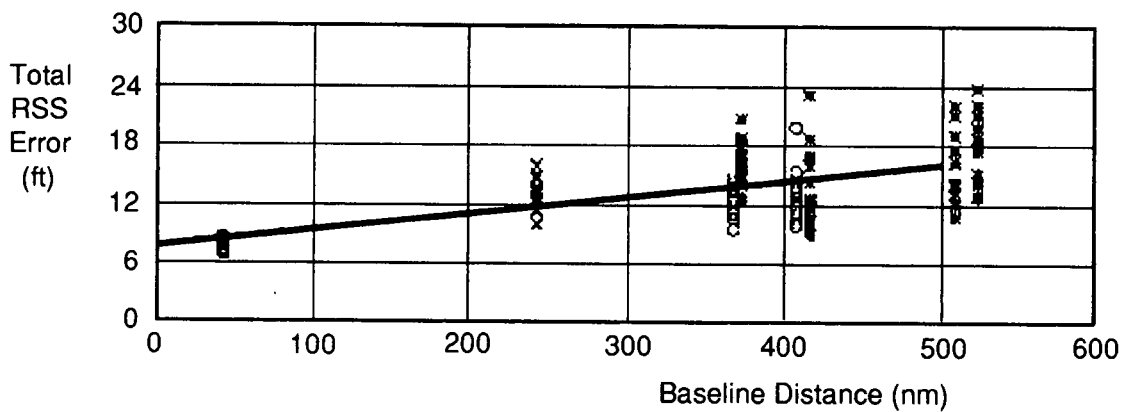

Figure D.8a. Total RSS Error, East Coast Data

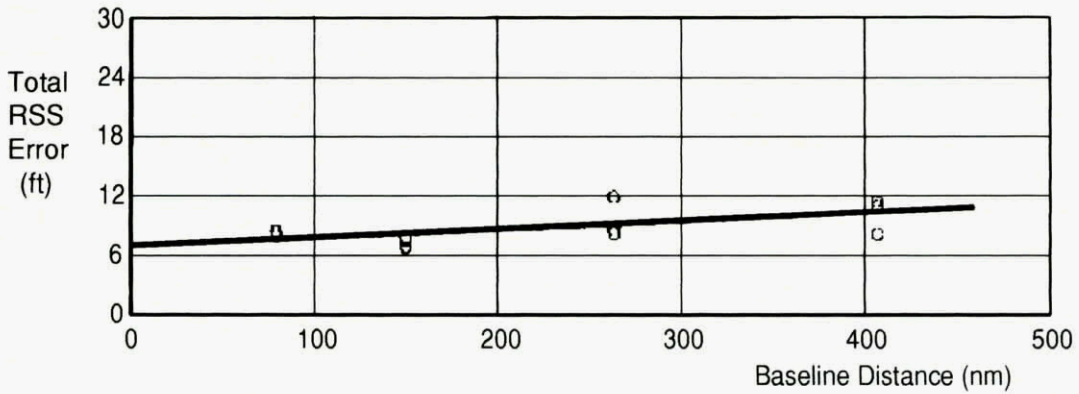

Figure D.8b. Total RSS Error, West Coast Data

Time delay, Δt , for temporal decorrelation analysis was varied from zero to fifteen minutes in thirty second intervals. Error was again computed as the RSS combination of the bias and standard deviation components measured at each value of Δt . Results for all four West Coast baselines are shown in Figure D.9. The uniform increase in error with increasing time delay and baseline distance indicated by this plot immediately suggests a plane as a representative surface. A least squares fit has been performed on these data, and the deterministic equation of the resulting plane is

$$E(\Delta l, \Delta t) = E_0 + A\Delta l + B\Delta t$$

where Δl is the baseline length in nm, Δt is the time delay in seconds, $E(\Delta l, \Delta t)$ is the error in ft, and E_0 , A , and B are constants with the following values:

$$E_0 = 7.6 \text{ ft}, A = 2.7 \times 10^{-3} \text{ ft/nm}, B = 4.4 \times 10^{-3} \text{ ft/s}$$

The results of this experiment show that targeting error grows slowly and linearly with baseline length and targeting latency. The nearly linear behavior of this growth for baseline lengths on the order of 540 nm (1,000km) and times of flight up to fifteen minutes indicates that the relative GPS navigation technique will give acceptable relative navigation accuracy for precision strike missions. The next part of the problem, relative location of the target will now be discussed.

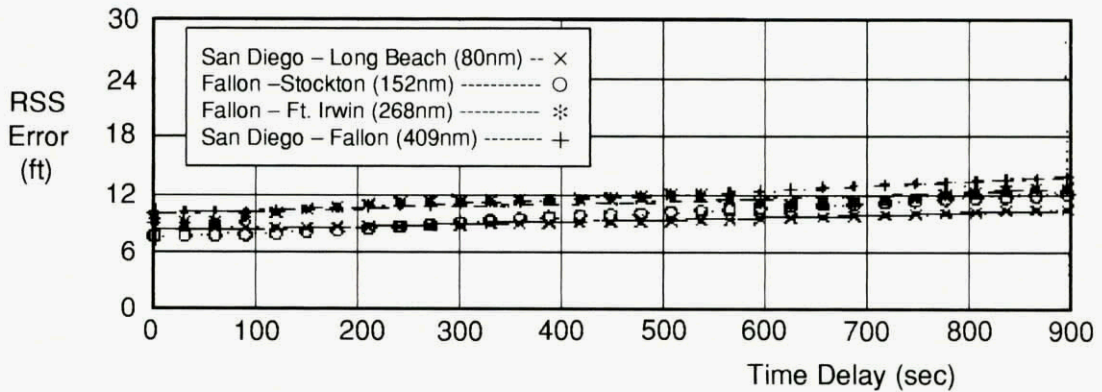

Figure D.9 Total RSS Error vs. Time Delay, West Coast Data

D.4 Real Time Relative Target Location Techniques

In Section D.3 it was shown that a GPS/INS guided weapon, using the same set of satellites as a reference receiver, will be able to maintain precision strike accuracies over long flight distances and flight times. The next part of the problem is to determine the target location relative to the reference receiver. This target location, when used by the weapons GPS/INS navigation system, will result in precision strike accuracy even though it can be substantially in error in an "absolute" sense. The target is then determined by adding this relative location to the reference GPS receiver location.

Figure D.10 shows one concept in which the relative targeting is done by a foot soldier with a reference GPS receiver and a target location device. The target location device might consist of a laser range finder combined with an attitude determination device. The target location (relative to the soldier) would be added to the GPS location to determine the target location in GPS coordinates. The target location and the satellite set used by the reference receiver would be transmitted to the weapon. The receiver on the weapon would use this set of satellites and the guidance would use the computed target location to achieve precision accuracy.

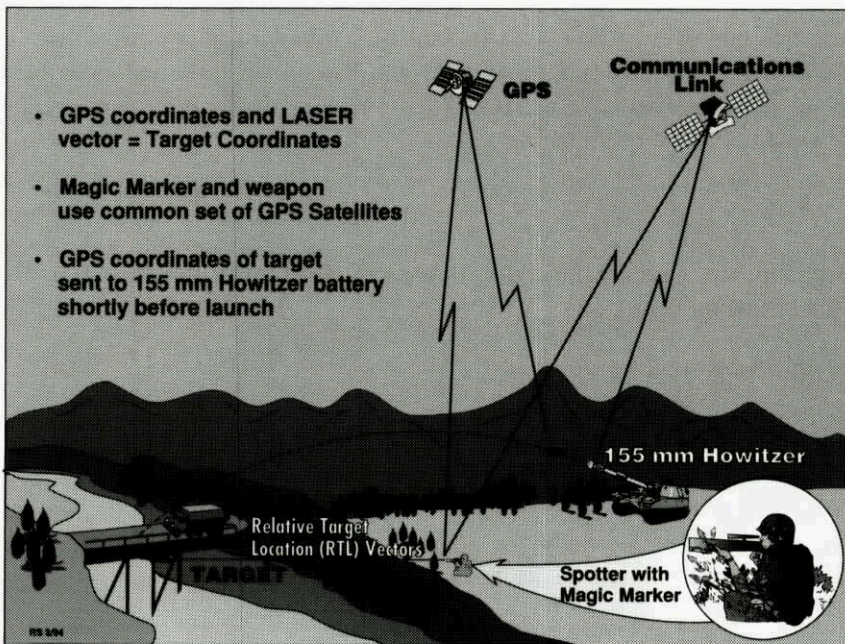

Figure D. 10. Determining Relative Location

Other implementations might involve the use of a high resolution synthetic aperture radar (SAR) onboard the weapon-carrying aircraft in order to accurately determine the relative target location vector in the aircraft GPS/INS coordinate system. The remainder of this section provides an extensive analysis of this case.

To achieve high 3-D position resolution of ground targets using SAR range and range-rate (Doppler) measurements, SAR uses the velocity vector of the aircraft to create, in effect, an antenna length (or aperture) that is proportional to the velocity of the aircraft times the integration time used in the radar processing. Errors in knowledge of the actual velocity vector directly translate into cross-range errors in the slant plane defined by the velocity vector and the line of sight (LOS) to the target location. GPS

provides accurate navigation information that helps the aircraft's Kalman filter sort out the GPS errors, the inertial system errors, the radar errors, and importantly, to relate the SAR Doppler measurement to cross-range position in the slant plane.

As an example, Fig. D.11 shows an aircraft trajectory during which a sequence of simulated SAR maps were made. The radar range resolution was set to 3 ft (0.9m). The aperture length/integration time was adjusted so that each measurement in the sequence also resulted in a radar cross-range resolution of 3 ft. It was assumed that the ARPA GPS Guidance Package (GGP) was the inertial/GPS system on the aircraft (ref. 3). An error covariance analysis of a system which used these measurements in combination with GPS/INS navigation to determine target location was performed. The INS errors were those associated with a 1nm/h (1.9km/h) system. The relative GPS errors were modeled as discussed in Section D. 3. Several results of this analysis are of interest. Figure D.12 contrasts the results in target location determination with and without the use of GPS. For this figure, the initial target location error was 500ft. (150m) (1σ) in each of three axes. In the graph on the left (without GPS) the first radar measurement (at $t=0$) immediately results in relative target accuracy in the range direction of less than 3 ft. However, many more measurements are required to resolve cross-range accuracy. Even at 1000s, the cross-range coordinate is not known to better than about 60 feet (18m) (1σ). This error is primarily due to velocity errors in the inertial system corrupting the relationship between the SAR Doppler measurement and cross-range position. The component of error out of the slant plane is not resolved at all until the slant plane is rotated shortly after 1000s. In the graph on the right, the accuracy provided by GPS velocity measurements greatly aids in translating the SAR Doppler measurement into cross-range position. By about 10 minutes, both in-plane components of target location are accurately measured. Again the third component is not resolved at all until the slant plane is rotated at about 1000s. The GPS aided resolution of this third component is better but still not to the desired level.

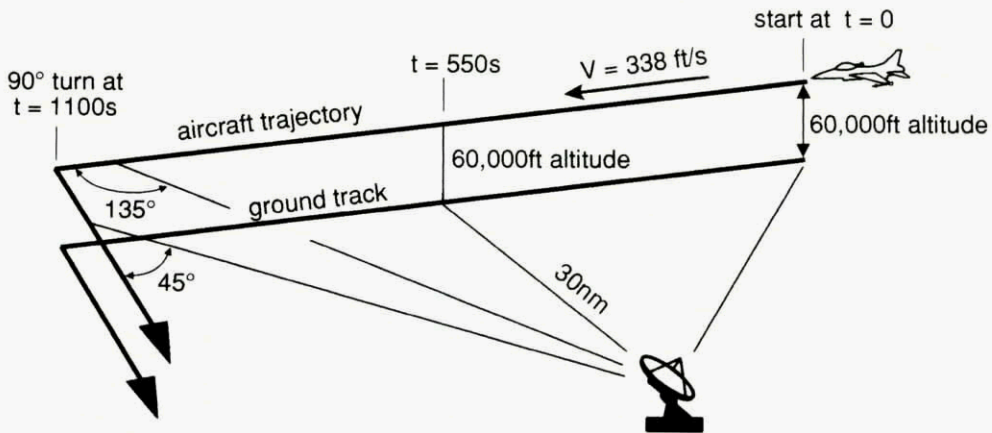

Figure D.11. Trajectory 1 Geometry

The observability of this third component must be further enhanced by slant plane rotations. The idea is to align the measurement directions, either in range or cross-range, along the unresolved direction. There are two approaches to this, one to change the aircraft position, the other is to change the aircraft velocity. It takes much less time to change the aircraft velocity, so this was the approach used here. A series of dive and climb maneuvers, (porpoising) were incorporated into the flight plan. These maneuvers rotate the slant plane by rotating the velocity vector. Figure D.13 shows the resulting target determination accuracy. Again the graph on the left shows errors when GPS measurements have been forgone. The graph on the right shows errors when GPS measurements are included. In this later case, accurate measurements are achieved relatively quickly. After about 20 minutes the RSS errors are 7.6ft (2.3m). Although perfectly feasible in terms of SAR processing (and aircraft capability), there seems to be a desire in the SAR community to fly

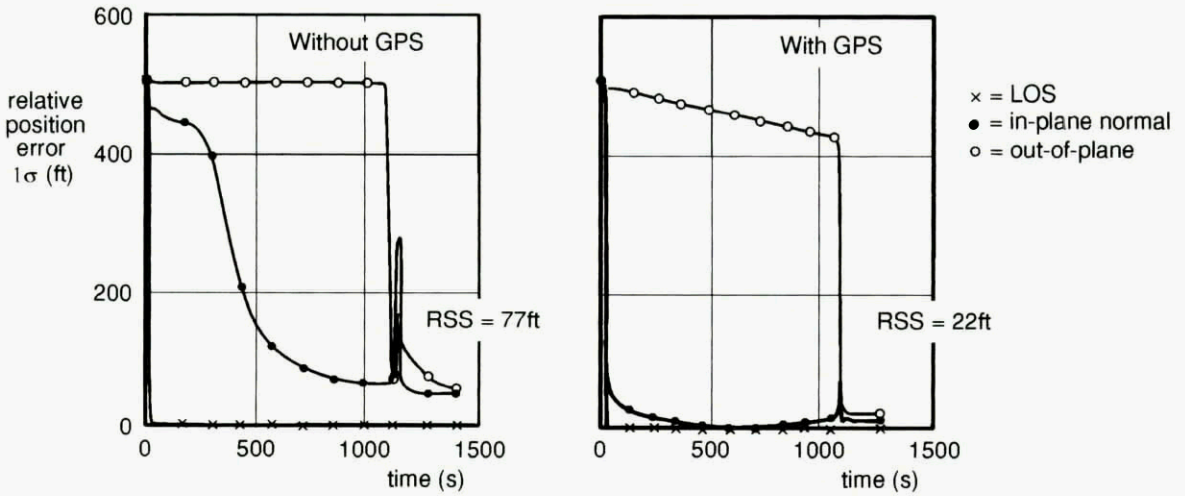

Figure D.12. GPS Measurements greatly improve SAR Performance

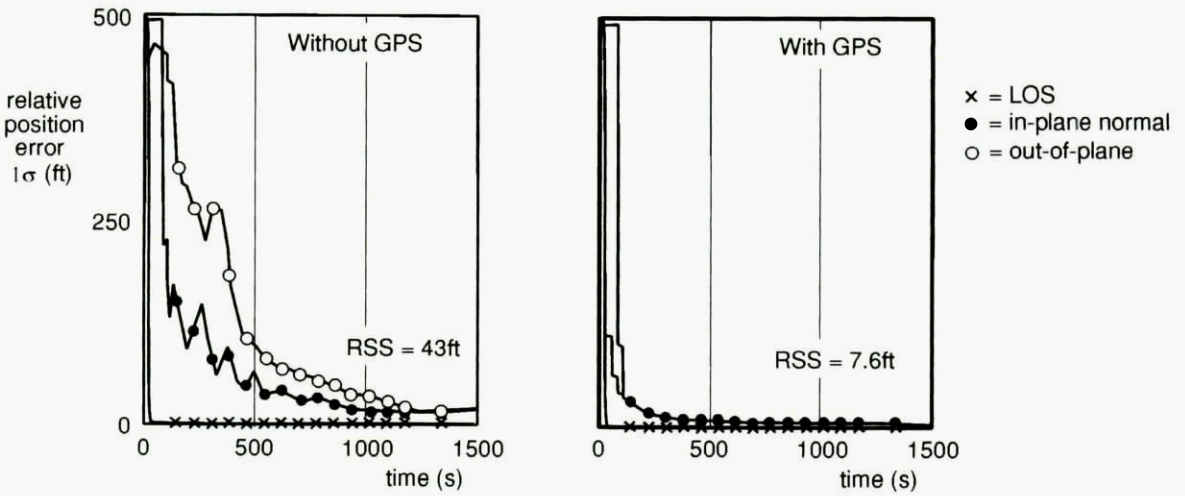

Figure D.13. GPS Measurements and Slant Plane Changes greatly improve SAR Performance

straight and level. Practically speaking this undoubtedly simplifies processing algorithms which even so require enormous computing resources. Perhaps a more practical scenario for target location and subsequent weapon delivery is shown in Figure D.14. On its way to the target, the aircraft executes a dogleg and altitude change, thus dividing the trajectory into three segments with different slant planes. SAR measurements are made along the dogleg with the SAR beam squinted quite far forward, first +20 deg, then at -20 deg. For this study both the range and cross-range resolution was 8ft (2.4m). Table D.2 shows resulting target location accuracy for two variations. In the first, Case 1, six SAR maps were made, two for each segment of the trajectory. For Case 2, a sequence of several measurements was made along each segment with the aperture time adjusted to yield an 8 ft. cross-range error for each measurement. The last measurement was made at $t = 143s$. At $t = 376s$, a guided bomb was launched. The bomb GN&C system included a GPS/INS reference receiver locked to the same satellites as the receiver on the aircraft and used the target coordinates determined by the GPS/INS/SAR system.

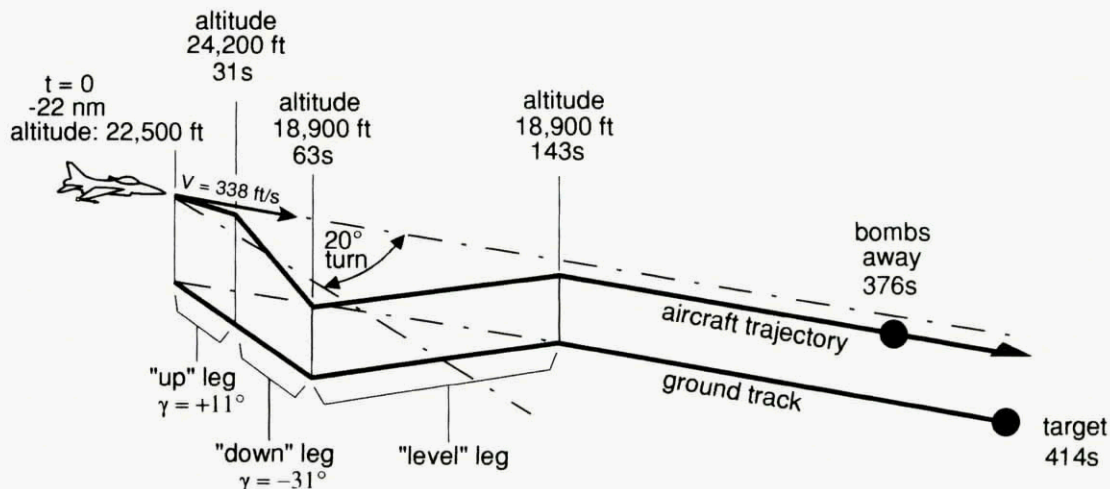

Figure D.14. Trajectory 3

The resulting bomb impact errors shown in Table D.2 demonstrate the efficiency of relative GPS/INS navigation and target determination by this system at weapon delivery time. The next section analyzes weapon delivery scenarios for which the relative target vector has been determined premission.

Case		1	2
SAR Measurement Conditions		2 at end of each leg	Continuous
"Up" Leg, $\gamma = +11^\circ$	LOS	8.0	4.0
Plane Inclination: $+45^\circ$	CR	49.1	51
Altitude: 24,200ft	Normal	500	500
"Down" Leg, $\gamma = -30^\circ$	LOS	5.7	2.7
Plane Inclination: -45°	CR	31	32
Altitude: 18,900ft	Normal	32	33
"Level" Leg, $\gamma = 0^\circ$	LOS		
Plane Inclination: -45°	CR	No measurement	
Altitude: 18,900ft	Normal		
Bomb Impact	FWD	9	5
	CRR	21	15

1σ Relative errors

LOS = Along the line-of-sight to the target

CR = Perpendicular to LOS in the slant plane

Normal = Perpendicular to the slant plane

FWD = Forward

CRR = Cross range at impact

Table D. 2. Trajectory 3 Results

D.5 Relative Techniques Employing Ground-Based Receivers

In this section, it will be shown how various existing or planned GPS-guided weapons could exploit an hypothetical capability to accurately determine 3-D relative target location vectors that are determined prior to the mission. The explicit assumption is that someday the capability to accurately determine these vectors to an accuracy of better than 10 ft (1σ per axis) over distances up to, say, 540 nm (1,000 km) will exist.

Such a capability would provide relative (or absolute if a surveyed point is used) targeting information on many targets over reasonably large potential theaters of conflict. For example, Figs. D.15 and D.16 show how only a few cooperative receivers located in "friendly territory" could provide coverage of nearly the entire Middle East and parts of northern Africa when used in a relative GPS mode. Of course, increasingly better accuracy would be expected as the distance between the cooperative ground-based receiver and target is shortened. It will be shown how several, somewhat different, existing or planned weapon systems could exploit such a capability.

Middle East

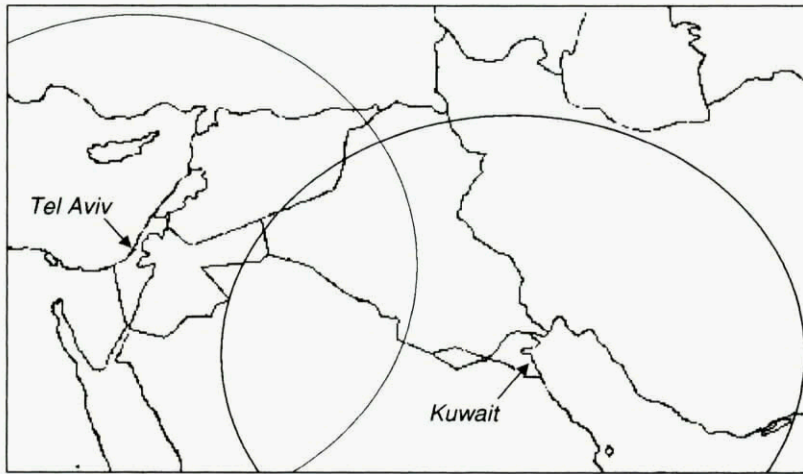

Figure D.15. 540 nm "coverage" for two cooperative GPS receiver/transmitter

Mediterranean

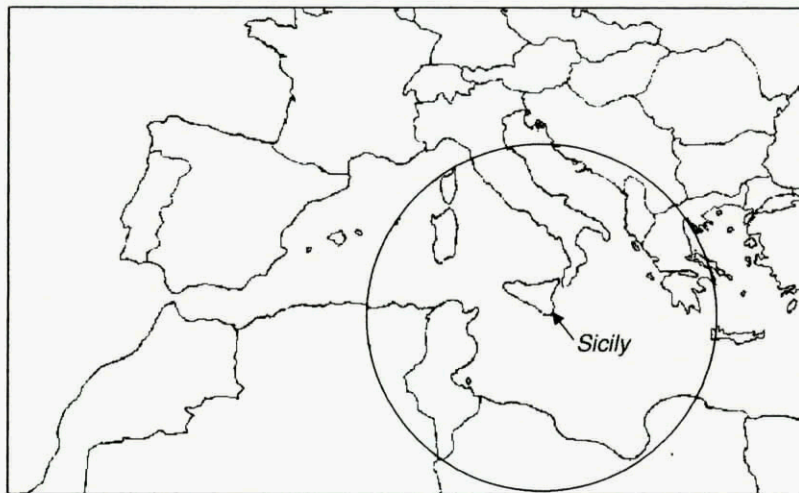

Figure D. 16. 540 nm "coverage" for one cooperative GPS receiver/transmitter

First, consider the cruise missile scenario shown in Fig. D. 17. Here, a ground-based receiver has been located with respect to a target. It will be necessary for the ground-based receiver to update the cruise missile shortly before its arrival at the target. It is not certain how "short" this time must be to be consistent with the accuracy goals. However, the results of Section D.3 indicate that several minutes are permissible. A few minutes before impact, the cooperative receiver transmits to the weapon the receiver's indicated position and the set of satellites it is using to form its navigation solution. A communications relay (satellite or aircraft) might be used if there were line-of-sight constraints. It is also assumed that prior to launch the relative vector from the cooperative receiver to the target is stored in the cruise missile's flight computer. Then, on receipt of the short data message from the cooperative receiver, the cruise missile ensures it is tracking the correct set of satellites and then adds the indicated position of the cooperative receiver to the RTL vector – thereby making an estimate of the indicated GPS position of the target and steers itself to that location. This scheme would appear to be relatively easy to implement in the Tomahawk weapon system, for example, since future planned upgrades include both "time-of-arrival" control and a communications link.

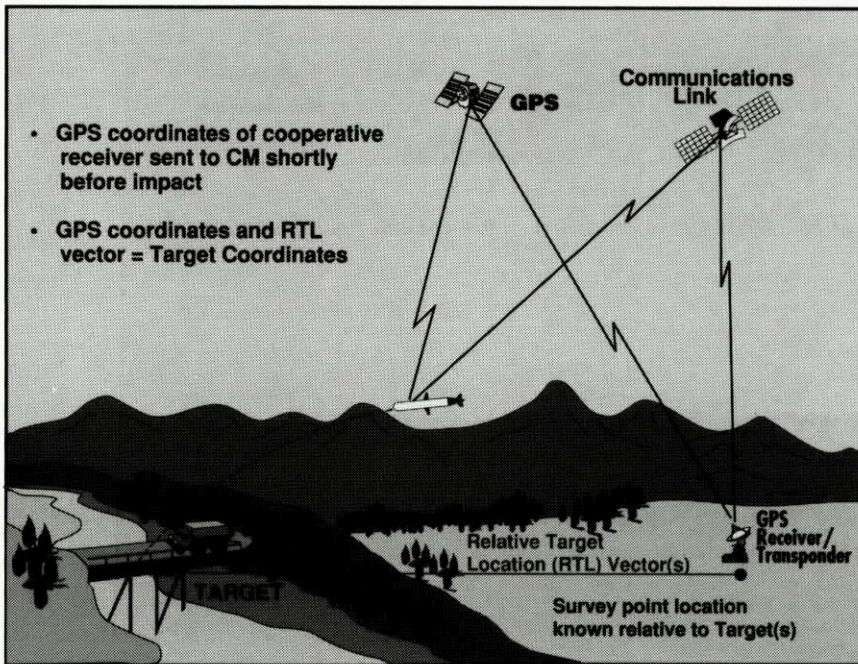

Figure D. 17. Cruise missile precision strike concept employing relative GPS

An equally simple scenario can be mechanized for a Joint Direct Attack Munition (or Standoff) weapon system (JDAM, JSOW). Fig. D.18 illustrates this concept. The slight difference in this scenario from that of the cruise missile is that the communication would probably go from the cooperative receiver to the aircraft carrying the weapons. This is feasible due to the relatively short time of flight of the JDAM weapon. Thus, just before launch of the weapons, the aircraft receives the targeting data, computes the indicated GPS coordinates of the target(s) and downloads these new coordinates and the set of satellites to be tracked into the JDAM computer. The ship-based Navy can also take advantage of this relative targeting technique just as well for precision shore bombardment. Fig. D. 19 illustrates this scenario. It could be possible to locate a receiver in Italy, for example, and have the ship in the Mediterranean Sea while holding targets in northern Africa at risk.

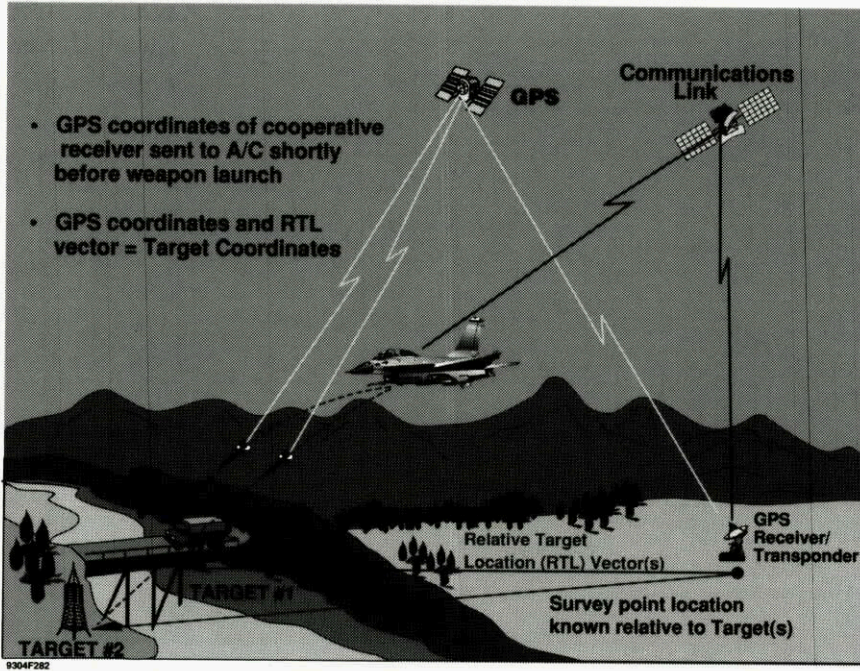

Figure D.18. JDAM precision strike concept employing relative GPS

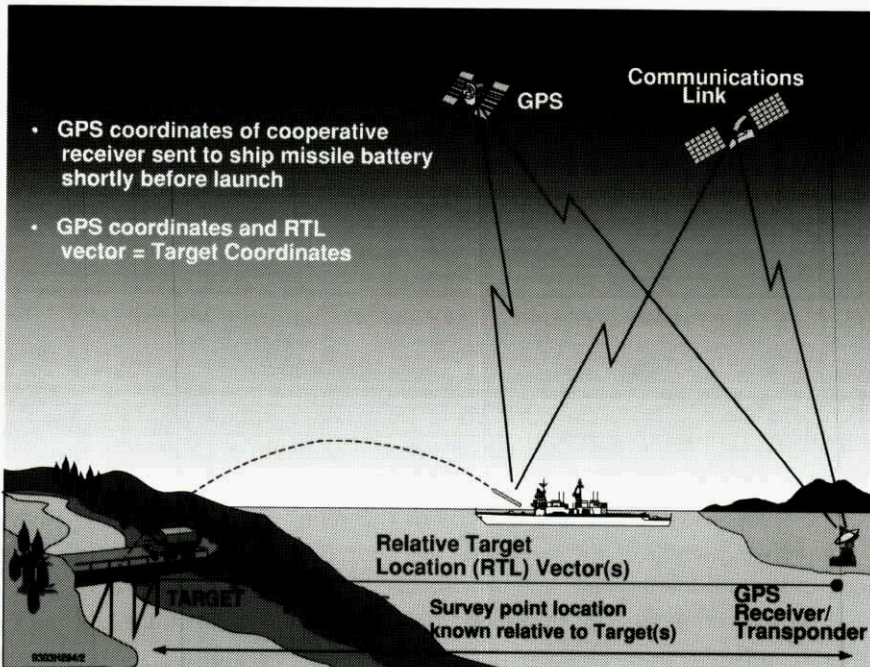

Figure D.19. Relative GPS for Ship-based precision strike

Possibly the simplest scenario might involve the US Army's extended range (ER) version of the its Tactical Missile System (ATACMS) (ref. 4). An ER-ATACMS battery could set up on one of these cooperative sites. Then the GPS receiver in the weapon itself could act as the "cooperative" receiver – thus, not requiring even a communications link, since cooperative receiver and weapon receiver are one in the same – and do the targeting by adding on to its own indicated position the relative target location vector just before launch and then using the same GPS satellites to navigate from there to the target. This scenario is shown in Fig. D. 20. Of course, a separate cooperative receiver can also be used as in the other scenarios, thereby allowing the ATACMS battery to set up at other locations (now, however, a communications link is required between the cooperative receiver and the ATACMS battery).

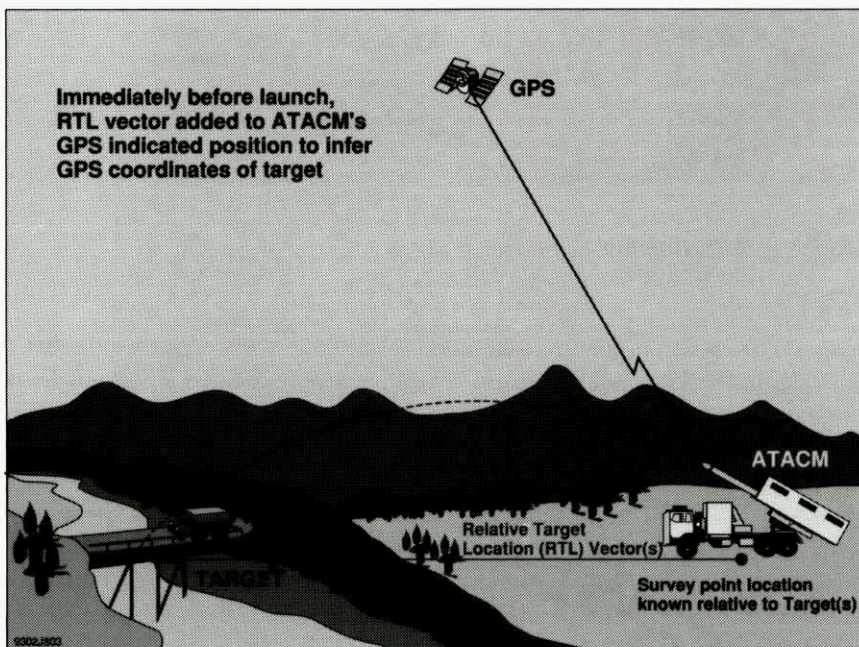

Figure D.20. Relative GPS/ATACMS Scenario

Variations on these scenarios can be applied to many other existing or contemplated GPS-guided weapon systems. For example, the SAR-equipped aircraft of Section D.4 could be used to image off-set aimpoints (rather than the target). The points could be in friendly territory and have been mapped relative to the target prior to the mission (See Figure D.21). In some tactical situations it might even be conceivable to include the reference station and the target in the same SAR image.

D.6. GPS Observability Issues

This section addresses the important issue of GPS satellite availability as a function of (1) target-to-receiver separation, and (2) the time interval between when the target location is estimated and when the weapon actually arrives at the target. In other words, is it reasonable to expect that as the weapon approaches the target that both it and the cooperative GPS receiver located "far" from the target will have a sufficient number of common satellites in view to enable a relative GPS mechanization? A study was undertaken to address this important issue.

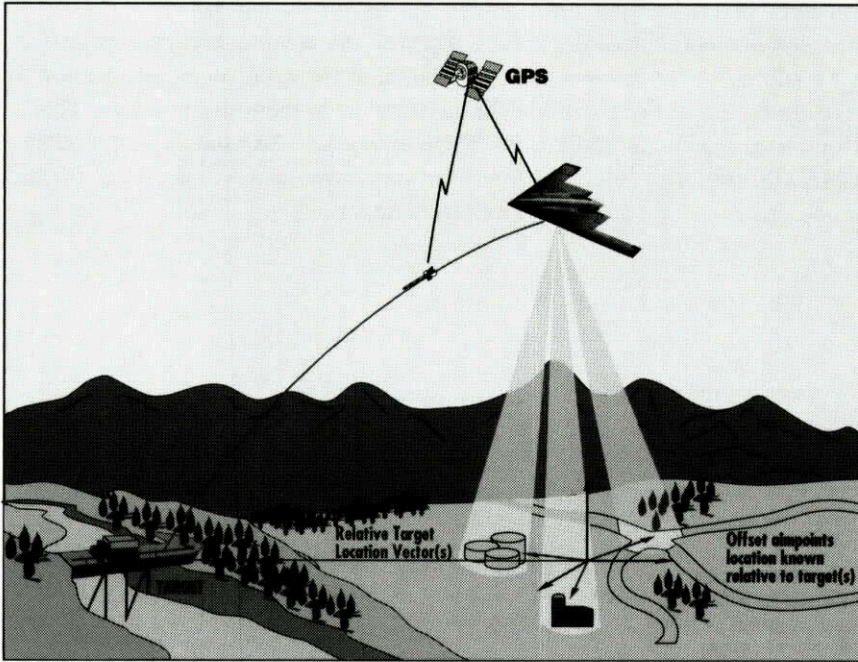

Figure D.21. Relative GPS/Bomber Scenario

The study assumes the full constellation of 24 GPS satellites. A simulation was written to model the orbital motion with respect to the earth. In the simulation, pairs of receivers were located at various latitudes (0 to 90 deg) and at various orientations (i.e., N/S or E/W, etc.) with respect to each other. Time was advanced in increments so as to let the geometry evolve for a long enough period so that all the behavior patterns could be observed. Both distance and "time delay" between receivers were varied, the process is illustrated for one location in Figure D.22.

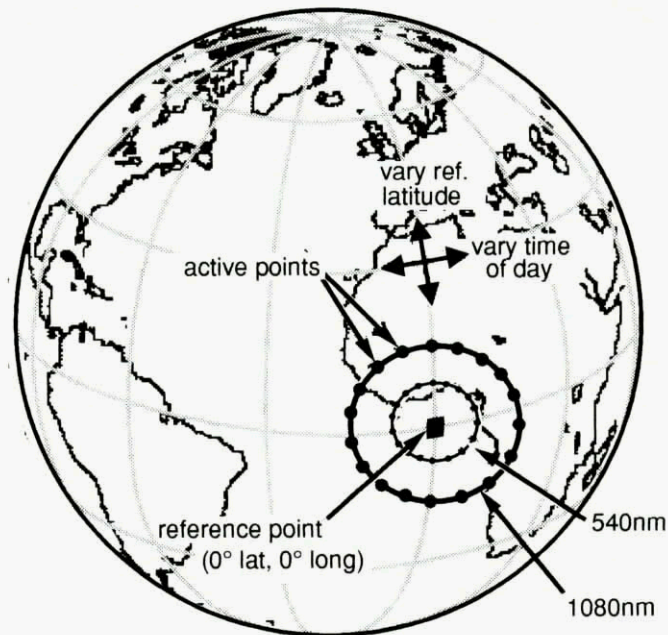

Figure D. 22. Reference and Active Receiver Locations

Table D.3 summarizes the results of the study. If, for example, the Tomahawk's aimpoint coordinates are updated 5 minutes before impact using data computed from a receiver located 945 nmi away from the target at 60 deg latitude, the table indicates that there will never be a condition with fewer than 4 satellites in view common to both receivers.

Reference Latitude Degrees - North	Time Delay (minutes)	Minutes Number in View for Zero Separation	Max. Separation with Four Satellites in View (nm)
0	0	6	1458
	5	6	1296
	15	6	1377
	30	6	1080
30	0	5	1350
	5	5	1188
	15	4	918
	30	4	324
60	0	4	918
	5	4	945
	15	4	702
	30	4	432
90	0	7	1836
	5	7	1944
	15	6	1836
	30	6	1458

Table D. 3. Summary of Results

Two Specific Examples are listed below.

Latitude (deg)	:	30	60
Time Delay (min)	:	15	15
Separation Distance (nm)	:	540	540
Min. Number of Common Satellites	:	4	4
Average Number	:	6.2	6.5
Average GDOP	:	4	3.9

High accuracy, however, is not guaranteed solely by having a set of four or more common satellites in view. Satellite constellation geometry (PDOP) is also important. On rare occasions, the geometry may be such that a change in the attack time by +/- a few minutes may result in a substantial improvement in accuracy (as when a new satellite appears over the horizon and has a dramatic effect on the available constellation geometry). This rare condition can be predicted weeks ahead of time if the approximate target location and time of attack are specified, thus allowing the mission planners to either select times with extremely favorable GPS geometry or to avoid the very rare instances of poor geometry. Again, it should be emphasized that instances of poor geometry are, indeed, the rare exception.

D.7 Concluding Remarks

This appendix has addressed several potential methods for achieving high accuracy (~10 ft (3m) CEP) using GPS/INS weapons. The approaches all revolve around a low-cost weapon navigation system (i.e., no terminal seeker on the weapon) and were variants of relative GPS guidance schemes. In a sense, removal of the terminal seeker on the weapon is allowed by determining the relative location vector using the sensor on the launch aircraft in real time, or by some other premission means of determining the relative target location vector. Simulated accuracies were shown to have promise for achieving the high-accuracy goals. Actual experimental results were presented confirming the theory of relative navigation between receivers separated by long baselines and also separated in time.

APPENDIX D REFERENCES

1. GPS Joint Program Office System Segment Specification for the User System Segment, SS-US-200, 31 January 1979.
2. Mullen, F., Fink, B., and Setterlund, R., "Verification of Relative GPS Targeting Concept," Proceedings of the 22nd Joint Services Data Exchange, Scottsdale, AZ, October 1994, Section 5A.
3. Ebner, R. and Rickords, T., "The Status of the Global Positioning System Guidance Package," Proceedings of the 22nd Joint Services Data Exchange, Scottsdale, AZ, October 1994,
4. "Extended Range ATACMS," Aerospace Daily, 5 January 1993, pg. 8.

REPORT DOCUMENTATION PAGE

1. Recipient's Reference	2. Originator's Reference AGARD-AR-342	3. Further Reference ISBN 92-836-1048-2	4. Security Classification of Document UNCLASSIFIED/ UNLIMITED																
5. Originator Advisory Group for Aerospace Research and Development North Atlantic Treaty Organization 7 rue Ancelle, 92200 Neuilly-sur-Seine, France																			
6. Title Precision Terminal Guidance for Munitions																			
7. Presented at/sponsored by																			
8. Author(s)/Editor(s) Multiple			9. Date February 1997																
10. Author's/Editor's Address Multiple			11. Pages 132																
12. Distribution Statement There are no restrictions on the distribution of this document. Information about the availability of this and other AGARD unclassified publications is given on the back cover.																			
13. Keywords/Descriptors <table border="0" style="width: 100%;"> <tr> <td style="width: 50%;">Precision guided munitions</td> <td style="width: 50%;">Terrain</td> </tr> <tr> <td>Conventional warfare</td> <td>Military planning</td> </tr> <tr> <td>NATO forces</td> <td>Strategic analyses</td> </tr> <tr> <td>Terminal guidance</td> <td>Requirements</td> </tr> <tr> <td>Persian Gulf War (1991)</td> <td>International cooperation</td> </tr> <tr> <td>Reviews</td> <td>Countermeasures</td> </tr> <tr> <td>Global positioning system</td> <td>Guidance</td> </tr> <tr> <td>Navigation</td> <td></td> </tr> </table>				Precision guided munitions	Terrain	Conventional warfare	Military planning	NATO forces	Strategic analyses	Terminal guidance	Requirements	Persian Gulf War (1991)	International cooperation	Reviews	Countermeasures	Global positioning system	Guidance	Navigation	
Precision guided munitions	Terrain																		
Conventional warfare	Military planning																		
NATO forces	Strategic analyses																		
Terminal guidance	Requirements																		
Persian Gulf War (1991)	International cooperation																		
Reviews	Countermeasures																		
Global positioning system	Guidance																		
Navigation																			
14. Abstract <p>This report summarises the deliberations of Working Group 02 of the Mission Systems Panel (originally Working Group 13 of the Guidance and Control Panel) of AGARD. The broad objectives of the Working Group were to review present and future terminal guidance technology in relation to NATO military needs.</p> <p>The report includes: a review of existing terminal guidance capabilities and shortcomings; an analysis of NATO military needs; reviews of relevant technology trends, user concerns and future capabilities; and a statement of conclusions and recommendations in respect of the potential to meet NATO needs and for NATO cooperation. Appendices provide basic definitions, plus background outline descriptions of terrain referenced navigation, countermeasures, and relative GPS (Global Positioning System).</p>																			

Aucun stock de publications n'a existé à AGARD. A partir de 1993, AGARD détiendra un stock limité des publications associées aux cycles de conférences et cours spéciaux ainsi que les AGARDographies et les rapports des groupes de travail, organisés et publiés à partir de 1993 inclus. Les demandes de renseignements doivent être adressées à AGARD par lettre ou par fax à l'adresse indiquée ci-dessus. *Veillez ne pas téléphoner.* La diffusion initiale de toutes les publications de l'AGARD est effectuée auprès des pays membres de l'OTAN par l'intermédiaire des centres de distribution nationaux indiqués ci-dessous. Des exemplaires supplémentaires peuvent parfois être obtenus auprès de ces centres (à l'exception des Etats-Unis). Si vous souhaitez recevoir toutes les publications de l'AGARD, ou simplement celles qui concernent certains Panels, vous pouvez demander à être inclu sur la liste d'envoi de l'un de ces centres. Les publications de l'AGARD sont en vente auprès des agences indiquées ci-dessous, sous forme de photocopie ou de microfiche.

CENTRES DE DIFFUSION NATIONAUX

ALLEMAGNE

Fachinformationszentrum Karlsruhe
D-76344 Eggenstein-Leopoldshafen 2

BELGIQUE

Coordonnateur AGARD-VSL
Etat-major de la Force aérienne
Quartier Reine Elisabeth
Rue d'Evere, 1140 Bruxelles

CANADA

Directeur - Gestion de l'information de
recherche et de développement - DRDGI 3
Ministère de la Défense nationale
Ottawa, Ontario K1A 0K2

DANEMARK

Danish Defence Research Establishment
Ryvangs Allé 1
P.O. Box 2715
DK-2100 Copenhagen Ø

ESPAGNE

INTA (AGARD Publications)
Carretera de Torrejón a Ajalvir, Pk.4
28850 Torrejón de Ardoz - Madrid

ETATS-UNIS

NASA Goddard Space Flight Center
Code 230
Greenbelt, Maryland 20771

FRANCE

O.N.E.R.A. (Direction)
29, Avenue de la Division Leclerc
92322 Châtillon Cedex

GRECE

Hellenic Air Force
Air War College
Scientific and Technical Library
Dekelia Air Force Base
Dekelia, Athens TGA 1010

ISLANDE

Director of Aviation
c/o Flugrad
Reykjavik

ITALIE

Aeronautica Militare
Ufficio del Delegato Nazionale all'AGARD
Aeroporto Pratica di Mare
00040 Pomezia (Roma)

LUXEMBOURG

Voir Belgique

NORVEGE

Norwegian Defence Research Establishment
Attn: Biblioteket
P.O. Box 25
N-2007 Kjeller

PAYS-BAS

Netherlands Delegation to AGARD
National Aerospace Laboratory NLR
P.O. Box 90502
1006 BM Amsterdam

PORTUGAL

Estado Maior da Força Aérea
SDFA - Centro de Documentação
Alfragide
2700 Amadora

ROYAUME-UNI

Defence Research Information Centre
Kentigern House
65 Brown Street
Glasgow G2 8EX

TURQUIE

Millî Savunma Başkanlığı (MSB)
ARGE Dairesi Başkanlığı (MSB)
06650 Bakanlıklar-Ankara

Le centre de distribution national des Etats-Unis ne détient PAS de stocks des publications de l'AGARD.

D'éventuelles demandes de photocopies doivent être formulées directement auprès du NASA Center for AeroSpace Information (CASI) à l'adresse ci-dessous. Toute notification de changement d'adresse doit être fait également auprès de CASI.

AGENCES DE VENTE

NASA Center for AeroSpace Information
(CASI)
800 Elkridge Landing Road
Linthicum Heights, MD 21090-2934
Etats-Unis

The British Library
Document Supply Division
Boston Spa, Wetherby
West Yorkshire LS23 7BQ
Royaume-Uni

Les demandes de microfiches ou de photocopies de documents AGARD (y compris les demandes faites auprès du CASI) doivent comporter la dénomination AGARD, ainsi que le numéro de série d'AGARD (par exemple AGARD-AG-315). Des informations analogues, telles que le titre et la date de publication sont souhaitables. Veuillez noter qu'il y a lieu de spécifier AGARD-R-nnn et AGARD-AR-nnn lors de la commande des rapports AGARD et des rapports consultatifs AGARD respectivement. Des références bibliographiques complètes ainsi que des résumés des publications AGARD figurent dans les journaux suivants:

Scientific and Technical Aerospace Reports (STAR)
publié par la NASA Scientific and Technical
Information Division
NASA Langley Research Center
Hampton, Virginia 23681-0001
Etats-Unis

Government Reports Announcements and Index (GRA&I)
publié par le National Technical Information Service
Springfield
Virginia 22161
Etats-Unis
(accessible également en mode interactif dans la base de
données bibliographiques en ligne du NTIS, et sur CD-ROM)



NATO  OTAN

7 RUE ANCELLE • 92200 NEUILLY-SUR-SEINE

FRANCE

Telefax 0(1)55.61.22.99 • Telex 610 176

DISTRIBUTION OF UNCLASSIFIED

AGARD PUBLICATIONS

AGARD holds limited quantities of the publications that accompanied Lecture Series and Special Courses held in 1993 or later, and of AGARDographs and Working Group reports published from 1993 onward. For details, write or send a telefax to the address given above. *Please do not telephone.*

AGARD does not hold stocks of publications that accompanied earlier Lecture Series or Courses or of any other publications. Initial distribution of all AGARD publications is made to NATO nations through the National Distribution Centres listed below. Further copies are sometimes available from these centres (except in the United States). If you have a need to receive all AGARD publications, or just those relating to one or more specific AGARD Panels, they may be willing to include you (or your organisation) on their distribution list. AGARD publications may be purchased from the Sales Agencies listed below, in photocopy or microfiche form.

NATIONAL DISTRIBUTION CENTRES

BELGIUM

Coordonnateur AGARD — VSL
 Etat-major de la Force aérienne
 Quartier Reine Elisabeth
 Rue d'Evere, 1140 Bruxelles

CANADA

Director Research & Development
 Information Management - DRDIM 3
 Dept of National Defence
 Ottawa, Ontario K1A 0K2

DENMARK

Danish Defence Research Establishment
 Ryvangs Allé 1
 P.O. Box 2715
 DK-2100 Copenhagen Ø

FRANCE

O.N.E.R.A. (Direction)
 29 Avenue de la Division Leclerc
 92322 Châtillon Cedex

GERMANY

Fachinformationszentrum Karlsruhe
 D-76344 Eggenstein-Leopoldshafen 2

GREECE

Hellenic Air Force
 Air War College
 Scientific and Technical Library
 Dekelia Air Force Base
 Dekelia, Athens TGA 1010

ICELAND

Director of Aviation
 c/o Flugrad
 Reykjavik

ITALY

Aeronautica Militare
 Ufficio del Delegato Nazionale all'AGARD
 Aeroporto Pratica di Mare
 00040 Pomezia (Roma)

LUXEMBOURG

See Belgium

NETHERLANDS

Netherlands Delegation to AGARD
 National Aerospace Laboratory, NLR
 P.O. Box 90502
 1006 BM Amsterdam

NORWAY

Norwegian Defence Research Establishment
 Attn: Biblioteket
 P.O. Box 25
 N-2007 Kjeller

PORTUGAL

Estado Maior da Força Aérea
 SDFA - Centro de Documentação
 Alfragide
 2700 Amadora

SPAIN

INTA (AGARD Publications)
 Carretera de Torrejón a Ajalvir, Pk.4
 28850 Torrejón de Ardoz - Madrid

TURKEY

Millî Savunma Başkanlığı (MSB)
 ARGE Dairesi Başkanlığı (MSB)
 06650 Bakanlıklar-Ankara

UNITED KINGDOM

Defence Research Information Centre
 Kentigern House
 65 Brown Street
 Glasgow G2 8EX

UNITED STATES

NASA Goddard Space Flight Center
 Code 230
 Greenbelt, Maryland 20771

The United States National Distribution Centre does NOT hold stocks of AGARD publications.

Applications for copies should be made direct to the NASA Center for AeroSpace Information (CASI) at the address below. Change of address requests should also go to CASI.

SALES AGENCIES

NASA Center for AeroSpace Information
 (CASI)
 800 Elkridge Landing Road
 Linthicum Heights, MD 21090-2934
 United States

The British Library
 Document Supply Centre
 Boston Spa, Wetherby
 West Yorkshire LS23 7BQ
 United Kingdom

Requests for microfiches or photocopies of AGARD documents (including requests to CASI) should include the word 'AGARD' and the AGARD serial number (for example AGARD-AG-315). Collateral information such as title and publication date is desirable. Note that AGARD Reports and Advisory Reports should be specified as AGARD-R-nnn and AGARD-AR-nnn, respectively. Full bibliographical references and abstracts of AGARD publications are given in the following journals:

Scientific and Technical Aerospace Reports (STAR)
 published by NASA Scientific and Technical

Government Reports Announcements and Index (GRA&I)
 published by the National Technical Information Service

Info
 NAS
 Ham
 Unit



341940++P+UL

UNLIMITED