

2

AFFDL-TR-79-3071

**LEVEL**

AD A 077029

THE HISTORY OF STATIC TEST AND AIR FORCE STRUCTURES TESTING

Bernard C. Boggs  
Structures Test Branch  
Structures and Dynamics Division

DDC  
RECEIVED  
NOV 14 1979  
E

June 1979  
TECHNICAL REPORT AFFDL-TR-79-3071

Approved for public release; distribution unlimited

DDC FILE COPY

AIR FORCE FLIGHT DYNAMICS LABORATORY  
AIR FORCE WRIGHT AERONAUTICAL LABORATORIES  
AIR FORCE SYSTEMS COMMAND  
WRIGHT-PATTERSON AIR FORCE BASE, OHIO 45433

79 19

**Best  
Available  
Copy**

NOTICE

When Government drawings, specifications, or other data are used for any purpose other than in connection with a definitely related Government procurement operation, the United States Government thereby incurs no responsibility nor any obligation whatsoever; and the fact that the Government may have formulated, furnished, or in any way supplied the said drawings, specifications, or other data, is not to be regarded by implication or otherwise as in any manner licensing the holder or any other person or corporation, or conveying any rights or permission to manufacture, use, or sell any patented invention that may in any way be related thereto.

This report has been reviewed by the Information Office (IO) and is releasable to the National Technical Information Service (NTIS). At NTIS, it will be available to the general public, including foreign nations.

This technical report has been reviewed and is approved for publication.

  
BERNARD C. BOGGS  
Chief, Facilities Engineering Group

  
SANFORD LUSTIG  
Chief, Structures Test Branch

FOR THE COMMANDER

  
RALPH L. KUSTER, JR., Colonel, USAF  
Chief, Structures and Dynamics Division

Copies of this report should not be returned unless return is required by security considerations, contractual obligations, or notice on a specific document.

UNCLASSIFIED

SECURITY CLASSIFICATION OF THIS PAGE (When Data Entered)

REPORT DOCUMENTATION PAGE		READ INSTRUCTIONS BEFORE COMPLETING FORM
14) 1. REPORT NUMBER AFFDL-TR-79-3071	2. GOVT ACCESSION NO.	3. RECIPIENT'S CATALOG NUMBER
6) 4. TITLE (and Subtitle) THE HISTORY OF STATIC TEST AND AIR FORCE STRUCTURES TESTING	5. AUTHOR Bernard C. Boggs	6. TYPE OF REPORT & PERIOD COVERED Final Technical Report
		7. PERFORMING ORG. REPORT NUMBER
		8. CONTRACT OR GRANT NUMBER(s)
		13) 299
10) 9. PERFORMING ORGANIZATION NAME AND ADDRESS Structures Test Branch (FBT) Air Force Flight Dynamics Laboratory Wright-Patterson Air Force Base, Ohio 45433		10. PROGRAM ELEMENT PROJECT TASK AREA & WORK UNIT NUMBERS
11. CONTROLLING OFFICE NAME AND ADDRESS Structures and Dynamics Division Air Force Flight Dynamics Laboratory Wright-Patterson Air Force Base, Ohio 45433		11. REPORT DATE 10 June 1979
		12. NUMBER OF PAGES 299
13. MONITORING AGENCY NAME & ADDRESS (if different from Controlling Office)		13. SECURITY CLASS. (of this report) UNCLASSIFIED
		13a. DECLASSIFICATION/DOWNGRADING SCHEDULE
14. DISTRIBUTION STATEMENT (of this Report) Approved for public release; distribution unlimited.		
15. DISTRIBUTION STATEMENT (of the abstract entered in Block 20, if different from Report)		
16. SUPPLEMENTARY NOTES		
17. KEY WORDS (Continue on reverse side if necessary and identify by Block number) Structures testing      Test methods Instrumentation; strain, deflection measurement      Test criteria Testing; static, fatigue, elevated temperature      Fuel simulation Test facilities      Digital computers Test equipment      Military organizations; structures testing		
20. ABSTRACT (Continue on reverse side if necessary and identify by Block number) This report traces the history of aircraft static testing from its early beginning and follows the development of structures testing in the United States Air Force from 1917 to 1979. Those technologies that are related to structures testing are included which were important to airplane structures strength. Test technology development which provided test facilities, test systems and test methods are covered for the static, dynamic, fatigue, and environmental simulation of subsonic, sonic, supersonic, hypersonic and re-entry aircraft missions.		

DD FORM 1473, 1 JAN 72 EDITION OF 1 NOV 65 IS OBSOLETE

UNCLASSIFIED

SECURITY CLASSIFICATION OF THIS PAGE (When Data Entered)

012 070

et

FOREWORD

This report was prepared by the Structures Test Branch, Structures and Dynamics Division, Air Force Flight Dynamics Laboratory, Wright-Patterson Air Force Base, Ohio.

The research and report preparation were accomplished by Bernard C. Boggs, Chief, Facilities Engineering Group, over a period of several years as an unassigned adjunct to his regular duties.

Acknowledgement is made to Robert L. Cavanagh, Sanford Lustig, Robert L. Schneider, Ronald E. McQuown, Helmut F. Ostrowski, Jarold G. Anderson, James L. Mullineaux, Martin D. Richardson, Robert L. Denison and Phyllis A. Brown of the Structures Test Branch for reviewing the manuscript at various stages of its development and making helpful corrections and suggestions. Discussions were held with several retired employees of the Laboratory for their knowledge of past events.

The material in this report was researched from Branch and Group files, the Air Force Flight Dynamics Technical Library, the Avionics Laboratory Technical Library and the archives of the Air Force Museum. First hand knowledge and experience were supplied with the author's 28 years working in the Structures Test Branch.

Accession For	
Microfilm	<input checked="" type="checkbox"/>
35mm TAB	<input type="checkbox"/>
Unprocessed	<input type="checkbox"/>
Justification	<input type="checkbox"/>
By	
Distribution/	
Availability Codes	
Dist	Avail: 1/or Special

980

## TABLE OF CONTENTS

<u>SECTION</u>		<u>PAGE</u>
I	INTRODUCTION	1
II	ARMY AND AIR FORCE MILITARY ORGANIZATIONS IN AIRPLANE STRUCTURES TESTING	6
III	DEVELOPMENT OF FLIGHT	12
IV	AIRPLANE STRUCTURES AND MATERIALS	29
V	AIRPLANE DESIGN AND TEST CRITERIA	35
VI	STRUCTURES TEST FACILITIES	55
VII	STATIC TESTING	99
VIII	FATIGUE TESTING	132
IX	ELEVATED TEMPERATURE STRUCTURES TESTING	152
X	FUEL SIMULATION STRUCTURES TESTING	188
XI	STRUCTURES TEST FACILITY AUTOMATION AND DIGITAL COMPUTER APPLICATIONS	196
XII	STRUCTURES TEST INSTRUMENTATION	202
XIII	CONCLUSIONS	226
	APPENDIX A MATERIEL DIVISION TEST PROGRAMS	228
	APPENDIX B FY-73 TEST ACTIVITIES AND MANHOURS	276
	BIBLIOGRAPHY	282

ILLUSTRATIONS

FIGURE		PAGE
1.	View of Building 65 Test Floor During Filming of TV Show	5
2.	Lower Surface View of B-58A Right Wing Failure	53
3.	Part of Building 28 Test Floor at Wright Field	59
4.	XCG-16A Wooden Troop and Cargo Glider Being Static Tested in Building 28 at Wright Field	61
5.	The Beginning of Excavation for Building 65 at Wright Field	65
6.	Construction of the West and East Crane Support Rail Piers	66
7.	Installation of Building 65 Roof Trusses	67
8.	Aerial View of Building 65 Under Construction	68
9.	Building 65 Nearing Completion at Wright Field	69
10.	Steel Erection for the Storage Building Adjoining the East End of Building 65	73
11.	Building 65 Control Room	78
12.	Building 65 Showing Substation E for the 50,000 KVA Power Installed for Elevated Temperature Testing	81
13.	Radiant Heat Test Facility	82
14.	Control Data Corporation 1604 Computer System Room	84
15.	Data System Transmitter-Multiplexer Unit	85
16.	Liquid Nitrogen Fuel Simulant Facility and Test Barrier	89
17.	Outside Storage Dewar for Liquid Nitrogen, Liquid Carbon Dioxide and Compressed Nitrogen Gas	90
18.	Structures Test Facility Showing the 50 by 100 Ft. Metal Storage Building and Permanent Additions	92
19.	Building 65 hydraulic Pump House	95
20.	Fatigue and Fracture Mechanics Test Facility	97

ILLUSTRATIONS

FIGURE		PAGE
21.	Static Test of German Fokker D-VII after World War I at McCook Field	104
22.	Albree-Fraser U.S. Army Scout Airplane Undergoing Static Test at McCook Field	105
23.	Albree-Fraser Scout Undergoing Static Test on the Horizontal Tail Section at McCook Field	106
24.	Albree-Fraser Scout Monoplane Fuselage-Wing Failure	107
25.	Static Test Setup of USAO-11 Lepere Triplane at McCook Field	108
26.	First Hydraulic Load Method Used at Wright Field	111
27.	General Airborne Transport Company XCG-16A Flying Wing 40 Troop and Cargo Glider	112
28.	Turnover of the Hughes YF-11 in Building 65	114
29.	B-36 Assembled in Normal Position for Test Conditions Before Turnover	115
30.	Turnover of B-36 in Building 65 at Wright Field	116
31.	Static Test of the F-80 Sandwich Wing at Wright Field	117
32.	Manual Hydraulic Loading Equipment	124
33.	Edison Hydraulic Pressure Control Units	125
34.	C-123B Positive Low Angle of Attack Condition Static Test	126
35.	Vacuum Blanket Method Used for Installing Sponge Rubber and RTV Silicone Rubber Tension Load Patches on Test Structure	129
36.	Building 65 Test Floor Showing the A-10 Static Test, F-4C/D Fatigue Test and the Advanced Metallic Air Vehicle Structure (AMAVS) B-1 Wing Carry Through Structure Fatigue and Fracture Test Setup	131
37.	Test Failure of B-24 Nose Down Crash Landing Study	133
38.	First Automatic Hydraulic Control System Used for Fatigue Testing at Wright Field	135

ILLUSTRATIONS

FIGURE		PAGE
39.	F-84D Wing Fatigue Test at Wright Field	136
40.	First Fatigue Loading Equipment not Made by the Air Force	142
41.	14 Channel FM Tape System and Datatron Automatic Tape Search and Control with Error Detection Used for Fatigue Tests	144
42.	Information Technology, Inc. Digital Simulators	147
43.	Resonant Fatigue Machine and Electronic Control Equipment	149
44.	Digital Equipment Corporation PDP-11/40 Minicomputer System	151
45.	Elevated Temperature Pilot Plant and Research, Inc. Regulator and Controller Installation	153
46.	Graph Showing Adiabatic Wall Temperature versus Mach Number	155
47.	Pilot Plant 40 Channel Control Computers with Console for Elevated Temperature Testing	162
48.	Power Control Equipment Used in Early Elevated Temperature Tests	164
49.	General Electric T-3 Infra-red Radiant Heating Lamps Used for Elevated Temperature Structures Testing	166
50.	First Radiant Heating Oven Built at Wright Field	168
51.	Landing at Wright Field of B-36 with B-58 Tucked into the Bomb Bay Door	170
52.	B-58 Static Test Program Conducted at Wright Field	171
53.	B-58 Nacelle Honeycomb Sandwich Structure Panel	172
54.	Test Method Development Setup for Simulating External Surface Aerodynamic Heating and Engine Heating Internally on the B-58 Engine Nacelles	173
55.	Graph Showing the Relative Cost of Radiant Heating Reflectors for Elevated Temperature Structures Testing in the 1960's	175

## ILLUSTRATIONS

FIGURE		PAGE
56.	Boeing Hot Structure Lower Surface Elevated Temperature Radiant Heating with Cooling of the Lamps and Reflector Surface Using Carbon Dioxide (Vaporized Liquid)	176
57.	Air Cooled Pyrometric Reflector Unit and High Temperature Electric Wire for Radiant Heating to Over 3000 Degrees Fahrenheit	177
58.	Elevated Temperature Test of Diboride Ceramic Nose Cap Shown Undergoing 3000 Degrees Fahrenheit	178
59.	Equilibrium Power Curves for Simulative Test Panel and Actual Test Structure	180
60.	Heat Control Equations - Functional Diagram	182
61.	Thermocouple Switching Units for the 2300 Thermocouples Used on the B-58A Elevated Temperature Tests	184
62.	Parallel Thermocouple Circuit and Switching Schematic	185
63.	Building 65 Test Floor Showing the SR-71 Wing Box Elevated Temperature Test Setup	187
64.	Static Elevated Temperature Test of the Thor Missile Section Using Liquid Nitrogen as a Simulant for Liquid Oxygen	189
65.	Advanced Structural Concepts Experimental Structure Inside Cryogenic Test Barrier	191
66.	Northeast View of Building 65 Structures Test Facility	193
67.	Gaseous Hydrogen Test Capability Constructed for Testing Hypersonic Vehicle Skin Panels	194
68.	AN/GJQ-9 Test Set	197
69.	Digital Computer Company PDP-11/40 Master and PDP-11/40 Slave Concept	200
70.	F-4C/D Extended Life Fatigue Test Program Center Splice Plate, Lower Surface, Showing Rosette and Axial Strain Gages	207
71.	F-4C/D Extended Life Fatigue Test Program Showing Strain Gage Rosette for Measuring Strains in the Lower Wing Torque Box	208

ILLUSTRATIONS

FIGURE		PAGE
72.	F-4 Horizontal Stabilator Shear Bridges Used in Calibration for Have Bounce Runway Roughness Program	209
73.	B-32 Structure Undergoing Static Test	211
74.	F-84D Positive High Angle of Attack Condition Under Static Test with Combined Lead Shot Bags and Hydraulic Tension Patch Loading	212
75.	F-84F Undergoing Tail Calibration	213
76.	Multiple Manometer Water Deflection Measuring System Used on the F-105B	215
77.	Sponge Rubber Tension Load Patches Using Sheetmetal Load Beams and Water Manometer Deflection Cans	216
78.	Data System Displacement Transducer Electronic Signal Conditioning Equipment Rack	217
79.	Data System Displacement Transducers in Two of the Several Ranges for Measuring Structural Deflections Electronically	218
80.	Diboride Ceramic Nose Cap Showing High Temperature Thermocouple Instrumentation for Re-entry Heating Profiles	219
81.	Data System "Tie-In" with Test Structure and Facility Components	221
82.	Data Acquisition Support Equipment Used on the Boeing Hot Structure Elevated Temperature Tests	222
83.	Schematic of Building 65 Data Acquisition System as Configured in 1979 with the SEL 86 Computer and Four PDP-11 Minicomputers	224

## SUMMARY

This report provides a historical background of airplane structures testing with primary emphasis on that done by the United States Air Force.

"Failures, it is said, are more instructive than successes: and thus far in flying machines there have been nothing but failures".\*

The above quote was made by an unknown author prior to 1894. Since that time, events have not changed enough to have lost its truthfulness. New airplanes still crash while in flight, but ground test and subsequent investigations pinpoint the cause. This quote referred to the entire airplane, though the usual cause was structural at that time. Experience since then has demonstrated that a structures test program which does not experience a failure, or failures, is suspect to the engineer in charge of testing.

Perhaps some day structures designers will perfect their skills and knowledge to such a level that airplane structures testing will become a redundant task, but that day is still over the horizon.

The evolution of structures testing, as described in this report, shows that it grew from the simple task of pouring sand on a structure to complicated computer operated electro-hydraulic loading systems which also program and control the structure's simulated environments. All this is done within the context of the airplane or space vehicle's design function or mission.

\*Progress in Flying Machines. Octave Chanute

## SECTION I INTRODUCTION

The history of airframe structures testing began with the Wright Brothers, although Otto Lilienthal, Samuel Langley and others first tested their structures using sand loading methods. This historical report on structures testing provides an insight by detailing selected facts, and imparts considerable knowledge for those becoming involved in structural testing and related professions. This history is of particular importance to the beginning structures engineer in government and industry.

Testing of airplane structures has been an exciting business since the McCook Field (predecessor to Wright Field Laboratories) heydays. The important highlights of structural testing's growth are presented in relation to other important flight requirements from structures testing's crude beginnings to the present. The static test work, first done with sand and log chains, has grown into an important engineering discipline of great complexity and sophistication.

The structural integrity test requirements for military airplanes, when properly met, insures that an airplane will be operationally safe for its design mission. Such testing has not always been done, yet much was learned through trial and error operations, redesign and retest. Each design concept has required comprehensive testing to demonstrate and verify design objectives.

In the beginning, proof of structural adequacy was seldom undertaken and proven by the manufacturer. The burden of proving an aircraft's

COMPARISON OF TESTING METHODS

TABLE 1

PARAMETERS	METHODS OF TESTING			
	WIND TUNNEL	TRACK TESTING	FLIGHT TESTING	STATIC TESTING
LOADING SIMULATION				
AERODYNAMIC	GOOD	GOOD	EXACT	GOOD
INERTIA	NO	NO	EXACT	GOOD
ULTIMATE LOAD	NO	GOOD	NOT FEASIBLE	GOOD
AERODYNAMIC HEATING				
TRANSIENT COND	GOOD	GOOD	EXACT	SATISFACTORY
EQUILIBRIUM COND	NOT FEASIBLE	NOT FEASIBLE	EXACT	GOOD
STRESS SIMULATION				
FROM AERO LOADS	GOOD	GOOD	EXACT	SATISFACTORY
FROM INERTIA LOADS	NO	NO	EXACT	SATISFACTORY
FROM HEATING	GOOD	GOOD	EXACT	SATISFACTORY
INSTRUMENTATION	GOOD	LIMITED	LIMITED	GOOD
CONTROLLABILITY	DIFFICULT	DIFFICULT	GOOD	SATISFACTORY
PERSONNEL SAFETY	GOOD	GOOD	POOR	GOOD
COST	EXCESSIVE	HIGH	EXCESSIVE	MODERATE

Table compares static testing to the other methods in use for proving the operational design limits on aircraft.

adequacy was left to skilled, impartial and experienced users. Perfection in airframe testing has been accomplished by using the combined experience of government and industry. Generally, the government test methods were made available and copied by industry before they began their own research and development work on improving test methods. The McCook and Wright Fields have always been held in high regard for pioneering work in new test methods and in contributing to airplane structural integrity and flight safety.

Until the military buildup for World War II, the Air Force's airplane operations depended very little on industry resources. Since that time it has become nearly totally dependent. The McCook Field and early Wright Field operations represented the approach to a national test facility to be available to the airplane oriented military services. Interest to establish a national test facility remained in the Air Force until the late 1960's. The present trend of 30 percent of its own work within the Department of Defense assures that there will not be a renewal of interest in such a test facility.

Air Force test engineers are totally objective in their efforts to obtain the best test results at lowest cost without jeopardizing the results. This had been true since the beginning of McCook Field. It is important that the Air Force perform its own structures testing while retaining its leadership in test methods and audit capability for its contracts.

Structures testing is notorious for not following a set schedule because of unpredictable failures, load changes and modifications.

These become extremely costly when done at a contractor facility as compared to the same work when done in a government facility.

The history of testing highlights the Air Force test facility at Wright Field and its test methods. The structures test facility is currently used primarily in support of test programs under the Air Force Flight Dynamics Laboratory's exploratory and advanced structural development efforts. The structures test facility provides the Air Force with a unique capability to experimentally determine the structural integrity and reliability of new military flight vehicle structures and advanced aerospace structural concepts. The Air Force test facility has test capabilities greater than most aerospace contract facilities and remains a leader in test methods development.

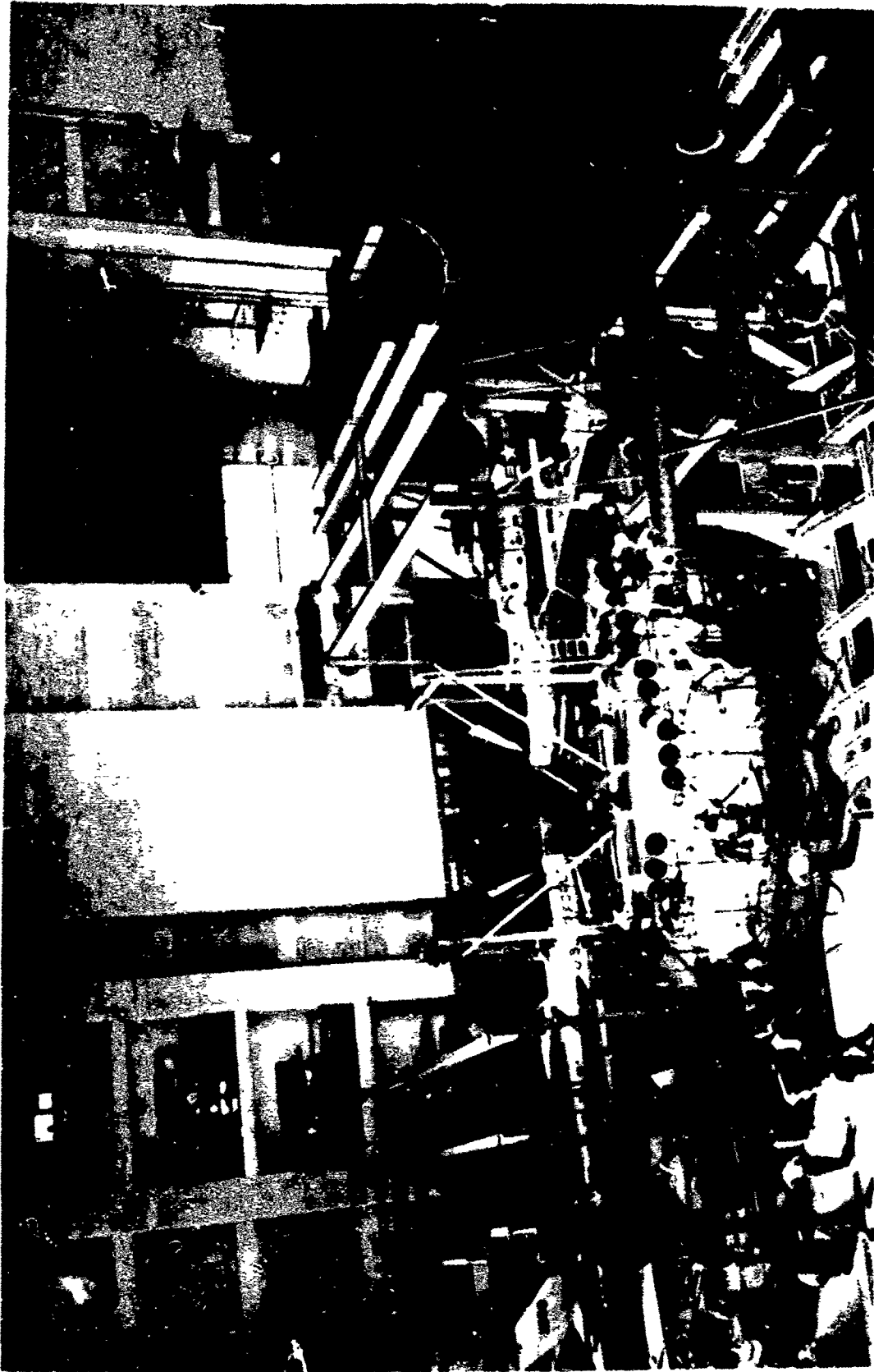

FIGURE 1

Building 65 structures test facility at Wright Field is a favorite for tours from school children to high level government officials and foreign dignitaries. A local Dayton television station is broadcasting the Howdy Doodly show in 1955. The airplanes are F-84F's undergoing flight test calibration.

## SECTION II

### ARMY AND AIR FORCE MILITARY ORGANIZATIONS IN AIRPLANE STRUCTURES TESTING

The testing of airplane structures has changed greatly since the first static test was performed by the Wright brothers in 1903. It was some time before the United States Army realized that static testing was necessary and essential for flight safety and that it was a continuing necessity.

Such static testing of flight vehicle structures is presently done at the Flight Dynamics Laboratory at Wright-Patterson AFB, Ohio under the Air Force military organizational structure using civilian employees primarily.

While early military commands did not recognize the need to test airplanes, it was done in some simple form by the manufacturer before being accepted by the military.

The Air Force is now a huge organization which had its beginnings somewhere in the lowest echelons of the United States Army in 1907 under Brigadier General James Allen. He established an Aeronautical Division in the office of the Chief Signal Officer, which up to that time had only used balloons. The Wright Flyer became the first and only military airplane through early 1911. It crashed on November 5, 1909 while being flown by Lt. Frank P. Lahm and Lt. Frederic E. Humphreys at College Park, Maryland. They were recalled to their regular duty stations which left only Lt. Benjamin Foulois as a military pilot. He moved the repaired airplane to Fort Sam Houston, Texas for the winter to be able to fly under better weather conditions. Lt. Foulois

learned to fly there by corresponding with the Wright brothers. He made 61 flights from March to September 1910. He used up the initial 150 dollar allotment and then had to use his own money to keep the contraption patched up and in the air. He finally took the Wright's recommendations against rebuilding it anymore, which left the Army without an airplane.

Robert F. Collier bought a Wright Type B airplane and loaned it to the Army in 1911. Finally, Congress appropriated some money and the Army bought a Wright Type B and a Curtiss Model D and had them delivered to Fort Sam Houston in April 1911. Three additional pilots were assigned from the flying school at North Island, California. That summer the Aeronautical Division established a flying school at College Park, Maryland and flying activities were continued there.

On July 18, 1914, Congress accorded statutory recognition to military aviation by establishing an Aviation Section as part of the Signal Corps. Most of the Army's efforts were involved in putting together an organization to fly and to teach flying. It had very little conception of how the airplane could be used as a fighting machine until the synchronized aerial machine gun was invented in 1913 and 1914 by both a German and French inventor. This invention was to take some time in perfecting, but it did make the airplane a formidable weapon. Up to this time, the airplane was held in less regard than a horse because it took too many people to operate and maintain, and it was absolutely useless in bad weather.

Just before World War I in Europe, the Aviation Section personnel authorization was raised to 60 officers, including students, with an

airplane inventory of 28. In December 1915, it had 23 airplanes and 44 officers. The airplanes were training types by European standards.

World War I changed the status of the airplane, and the United States finally became involved formally by declaring war on Germany April 6, 1917. The Signal Corps plan promised 10,000 aircraft, trained pilots to fly them and all the other needs for the "Winged Cavalry." The program called for 2,000 airplanes and 4,000 engines per month. At that time there was only one aircraft manufacturer of any significance in the United States--the Curtiss Company. It was turning out about 100 primary trainers per month for the British. Up to this time no military planes had been built and very few technically trained Americans had ever seen one.

Three days after the declaration of war, the Dayton-Wright Aeroplane Co. at South Field (Moraine Field), was organized to produce airplanes. It produced 400 Standard SJ-1 trainers and 3,106 DeHavilland DH-4 two place observation biplanes during the war. The United States built what was considered to be the best of the European models for its "Flying Cavalry."

On May 24, 1917, an Aircraft Engineering Equipment Division of the Signal Corps was organized which included an Engine Design Section and a Plane Design Section. Two months later these sections were reformed into the Airplane Engineering Department. They were located at McCook Field, a new aviation facility in Dayton, Ohio.

On May 24, 1918, the Aviation Section of the Signal Corps was discontinued and replaced by the Air Service (not the Air Service of the American Expeditionary Force activated in mid-1917). Subsequent

reorganizational efforts led to the inclusion of the Airplane Engineering Division August 31, 1918. The major responsibility of the experimental engineering managers was aeronautical research and engineering. The subdivision allowed contracting for experimental work and controlled most of McCook's facilities such as the engineering drafting, airplane fabrications shops, the laboratories and the airfield area itself.

By mid-1919, the Airplane Engineering Division became the Engineering Division. This title and basic function continued until July 2, 1926 when the Army Air Corps replaced the Air Service. The old Engineering Division was broadened to include supply, procurement and maintenance of aircraft. The name was changed to Materiel Division. During this time from 1917 to 1926 McCook Field placed in the ranks of the world's foremost aeronautical laboratories. Its engineers and mechanics worked on, or initiated and proved, the turbo-supercharger, the helicopter, reversible propeller, air to air refueling, controllable pitch propellers, bulletproof gasoline tanks, all metal airplanes, parachutes, special steels and alloys for airplane engine manufacture and many other things.

An Air Corps Materiel Division was set up at Wright Field (McCook's successor) with supply, procurement, and aircraft maintenance functions. Development responsibilities were delegated to an Experimental Engineering Section which remained in operation throughout the years which included the evolution of the Air Corps into the Army Air Force(s) June 20, 1941.

At the beginning of World War II the United States military was not in a much different position than it was just before World War I. Under the National Defense Act of 1940, 6,000 airplanes were authorized and President Roosevelt asked Congress to increase aircraft production to 50,000 airplanes per year and airplane manufacturers were ordered to tool up for mass production.

During all of the many World War II organizational realignments, and the establishment of an independent United States Air Force on September 18, 1947, the Experimental Engineering Section remained. During most of this time it was under the Air Materiel Command. In 1951, the Air Materiel Command's applied research functions were assigned to the Air Research and Development Command, a new organization. The Wright Field aeronautical laboratories and facilities (which were the old Engineering Division or Experimental Engineering Section) were organized into the Wright Air Development Center of the Air Research and Development Command. Testing of airplane structures was done in the facilities of the Aircraft Laboratory.

The obstacles and limitations which were thought to limit flight were removed when the speed of sound was broken October 1947. This was followed with development of the intercontinental missile and the orbiting Russian Sputnik. The Wright Air Development Center's responsibilities changed. The organizational structure was changed and called the Wright Air Development Division in late 1960. On April 1, 1961, another mission snake-up involved the Air Materiel and the Air Research and Development Commands. The Wright Air Development Division was

discontinued and in its place the Aeronautical Systems Division was formed, one major segment of the new Air Force Systems Command. At this time the Directorate of Engineering Test was formed and took over all of the Wright-Patterson AFB test facilities and shop support functions.

In June 1963, the laboratories and facilities were reorganized directly under the Air Force Systems Command and removed from control of the Aeronautical Systems Division. The Directorate of Engineering Test was abolished. The different test facilities were assigned to the laboratories. Structural testing operations were placed in the Air Force Flight Dynamics Laboratory.

A reorganization in August 1975 was made in order to establish a center of excellence and to give better support to Aeronautical Systems Division among several other objectives. This organization was the Air Force Wright Aeronautical Laboratories which consisted of the Avionics Laboratory, Aero Propulsion Laboratory, Flight Dynamics Laboratory, and Materials Laboratory.

### SECTION III DEVELOPMENT OF FLIGHT

The ambition to fly has been in man's blood since he first watched birds fly and soar. First attempts to fly imitated birds by attaching "wings" to his arms and legs to jump off cliffs and towers. Birds were man's inspiration and envy and his attempts to imitate them most often were met with tragedy.

Birds had no basic problem with structure, aerodynamics, flutter, stability, control, propulsion or anything except for the most severe weather conditions. They experienced no wing failure in flight which perhaps led to man's early complacency concerning his safety or that of his airplane.

Man first used feathers, bamboo rods, willow canes, wood, steel, aluminum, cloth, and many other materials in an effort to find the right combination structure that was built strong and light enough to support it and himself while in the air. He fastened the parts together with glue, string, wire, solder, welds, etc. In so doing, he eventually learned that it was necessary to know the exact mechanical and physical properties of each material along with its limitations.

According to Greek legend, Icarus attempted to escape from Crete with wings built by his father Daedalus, but in so doing lost his life when he flew too high and the sun melted the wax by which his wings were fastened. King Bladud of England was also killed while attempting to fly in 825 B.C.

Although Roger Bacon speculated about mechanical flight around 1250, the first man to do aeronautical design was Leonardo Da Vinci around

1483-1503 when he designed the first parachute, finned projectiles, ornithopters, the first powered airplane and wrote on bird flight. Much of this knowledge was never made public, and contributed nothing to flight development. Newton's theory of the power required for a flat plate to sustain lift and drag retarded flight for many years. He and other physicists were responsible for this error being perpetuated.

In the intervening years a number of men toyed with solving the problems of flight using wings (attached to the body), kites, windmills, ornithopters, lighter than air flying, gliders, helicopters, airscrews, and jet and rocket power ideas, but not a single flight materialized until the hot air balloon was invented and demonstrated. Yet nothing appears in nature lighter than air which can fly. Too much time was lost as a result of lighter than air balloons and retarded mechanical flight.

Sir George Cayley, father of British aeronautics, did some important work by flying a model helicopter. He also designed a modern configuration airplane with fixed wings, tail unit control surfaces and an auxiliary method of propulsion. Cayley tested airfoils on a whirling arm, flew glider models, invented the cycle type tension wheel, flew the first unmanned full sized gliders, designed a solid of least resistance based on studies of the trout, designed a convertible plane which was the first biplane, first man carrying flight by an airplane (glider) not under occupant's control, designed a stretched rubber motor for airplane models, and tried to form an aeronautical

society during the time period 1796 to 1853. Cayley helped make manned flight possible and was the most important designer and experimenter at that time in history.

There were many men following Cayley who designed, invented and made vehicles for attempting mechanical flight. John Browning built the first wind tunnel in 1871 and N.A. Otto (Germany) invented the four stroke engine which eventually provided the power for manned flight. The first self-propelled powered model that demonstrated inherent stability was designed and built in 1871 by Alphonse Pénard.

In 1874, Félix Du Temple made the first powered take off in a man carrying airplane, but it did not fly. The first motor propelled flight was made by Clement Ader, a French inventor, in his steam powered Eole in 1890. It left the ground under its own power for 150-165 feet and crashed. None of these efforts resulted in sustained or controlled flight and these and other such efforts were recorded as hop flying.

In 1884, a Russian, Mozhaisky, tested a steam powered monoplane using an English engine, driven by a large tractor propeller and two small pusher propellers in the wing trailing edge. It took off down a ski-jump ramp and was said to be airborne 65-100 feet without sustained flight.

In 1884, Horatio Phillips patented his invention of double surface cambered wings which is the true foundation of modern airfoil design as they were widely published and experimented with.

The problems of mechanical flight which had to be solved were lift, thrust and control. These remained to be solved when

Otto Lilienthal (Germany) became interested in flying in 1890. Instead of building an engine to propel a machine which could be used to solve the balance problems, Lilienthal built hang gliders and used gravity as the motor. His early flight experimentation was done secretly at night to avoid being labeled as a nut and having to endure more serious consequences, as the German government had taken the official position that mechanical flight was impossible. It was his opinion that successful flight depended on solving control which he accomplished by changing his position while hanging beneath his glider. He had 2000 flights but had accumulated only about five hours flight time when he was killed in an accident from a structural weakness in his glider in 1896.

The Englishman, Pilcher, was killed in his glider September 1899 because of a structural failure of a bamboo rod in the tail assembly. Pilcher and Lilienthal were believed to be the only two men who could have solved the problems of powered flight up to this time. There was a lot of experimenting and inventing by others and the concept of flight was still primarily limited to learning the art of flying like a bird.

It was Otto Lilienthal who laid the foundation for Pilcher, Octave Chanute, John J. Montgomery and the Wright brothers. Chanute was a famous American civil engineer (a bridge builder) when he became interested in gliding flight in 1889. He designed his gliders with trusses and bracing using the principles of bridge design. In approximately 1000 flights there were no structural failures.

Chanute built a Lilienthal glider with the idea that he could solve the problem of equilibrium in the air by making automatic mechanical adjustments between the wind and the apparatus independent of a man in the loop. He conducted his experiments in 1896 and 1897 at Dune Park, Indiana (about 50 miles from Chicago) with the assistance of Augustus M. Herring, William Avery, W. Paul Butsov and James Ricketts. He started the year Lilienthal was killed.

In 1894, Maxim, an American engineer in Great Britain, produced a huge steam driven aerial apparatus which while impractical in looks might have flown but lacked adequate control and crashed.

Professor Samuel Pierpont Langley, Secretary of the Smithsonian Institution, constructed a steam driven model airplane in 1890 which was unsuccessful, but he kept trying until he was successful in 1896. His model was 16 feet long, had a 13 foot wingspan, and used a 1-1/2 horsepower steam engine geared to twin propellers and was launched from a special catapult mounted on top of a houseboat. He continued this technique for his man carrying powered airplane in 1903, which failed. Langley was supported by the Army Board of Ordnance and Fortification at a cost of \$50,000, and an unknown sum of money from a Smithsonian fund for over 10 years. Langley's work became the subject of a law suit with the Wrights several years later.

The Wright brothers, Wilbur and Orville, became first aware of flying when their father, Reverend Milton Wright gave them a toy helicopter in 1878. It was made of bamboo, cork and paper, and represented the heavier than air flying machines of that time.

It could fly on its own power, but could not be controlled. The older brother, Orville, tried building one with the aim of improving on it, but was not very successful. It was this particular helicopter gift that molded the future lives of these two men. Also, they should be recognized as the two greatest aeronautical engineers of all time for their work.

Wilbur and Orville Wright did not have more than a formal high school education, but undertook solving the problems of flight in a way that no educated man at that time would have dreamed of. They left nothing to chance or ignorance. They studied everything on past efforts to fly, all the books on birds, and corresponded with Chanute. They believed that their only chance of success was to get lots of practice flying, which Lilienthal had failed to do. They believed that flying was a very difficult art, and knowing the problems experienced in learning to ride a bicycle or horse with confidence, the total time of five hours accumulated by Lilienthal was not adequate.

The Wright brothers studied Lilienthal's tables on air pressures and lift, and built their first wind tunnel in 1901 after first having done some experimentation with their glider at Kittyhawk, North Carolina. Over 200 different wing sections were tested and they learned the range and importance of the shift in the center of pressure at different air velocities and angles of attack. Every part of their gliders were static tested for the required design strength before being flown.

Before their first glider flight, they developed a means of control. They also mastered stability and balance before they ever attempted to build their motor and propellers for powered flight.

Extensive stress analyses were done, and they worked out the best materials for their gliders and also used them for powered flight. In their experimental glider flight at Kittyhawk, they measured the lift and drag. Using these values, they calculated the horsepower required to sustain flight.

They glided, alternately, and developed complete mastery over light gusty winds. They steered at will, but would not venture too high or more than a quarter circle so as not to endanger their works or lives. It was at this same time that they learned the importance of pre-flight inspection, and always made repairs at once when something was out of order. They were very careful not to take unnecessary dangerous risks. The Wright brothers planned to succeed and they would not take such risks as Lilienthal, Pilcher, and others, whose deaths ended their flying experiments. The Wrights realized that some method of piloting their machines other than hanging by their arms was needed. They patterned their first glider designs after Chanute's double decker wings. They were in constant contact with him for a number of years.

Their study of the horsepower necessary for flight led them initially to the prone position in gliders with mechanical controls for balance. The methods used by previous experimenters caused physical fatigue and a depletion of energy, which in the event of sudden wind gusts could wrench the machine from their grasps.

The Wrights planned to use a tower with a rope pulley and a counterbalance, equivalent to the weight of the operator, for catapulting the glider into the air. In settling on the sand dunes

at Kittyhawk where it appeared they could get a lot of flight time per flight, they used the sand hills and a launch rail instead. Later on they used the catapult for powered flight near Dayton.

While at Kittyhawk, they continued to study birds, primarily buzzards, to learn their secret of balance and control. This observation taught them that buzzards regained their lateral balance when partly overturned by a gust of wind by torsion at the tips of their wings. As they experimented, they continued to study the birds while learning how to make adjustments to their glider's balance and control.

The Wright brothers experimented for lateral control by flying models as kites with the twisting of the wing tips done by them from the ground. Once successful, they added loads using chains or sand bags of various weights to perfect the lifting qualities as well as balance. It was somewhat of an accidental happening based on the discussion of a dream, that one had, that they were able to work out the simultaneous moveable vertical rudder and wing warping. This occurred in October 1902, was later patented, and is the flight control principle used today.

Even before the Wright brothers tried to glide their first machine, they designed it to sustain five times their body weight and then tested every piece. But they did not make bending or compression tests as they were not equipped for them. They did perform a crude stress analysis in addition to static testing the finished product. They were aware that an awkward landing could cause failure of their machine, but since the velocity relative to the ground was almost zero most of the time, and the fact that they flew close to the ground, they did not

consider this a real problem. Actually, these machines were so light that if caught with a high wind gust it would destroy them.

The Wright brother's first airplane weighed 750 pounds and was pushed by two propellers driven in opposite directions by automobile chains from a four cylinder gasoline motor of 12 horsepower. Later, in Dayton, it was launched on rails aided by a 1400 pound weight suspended on a tower. First flights were low to the ground and speeds were kept within the design cruise speed of less than 30 mph. Maneuvers were not made until 1904, and that was started with a circle flight at the southwest end of Patterson Field, which was known as Huffman Prairie at that time, and was later named Wilbur Wright Field.

The Wright brother's early flights were not believed, and there was confusion abroad in that the reporters in the United States were not aware of their significance and were not reporting them accurately or in a manner which would not attract attention.

The Wright brother's flights began to excite the European military, but it was several years before the United States War Department showed any interest, although Langley had been financed by the War Department for several years.

Langley proved what he had set out to do when he successfully flew his steam propelled tandem wing model aerodrome, as he called it. He never intended to build a piloted airplane, but after being encouraged by the Army, he went ahead, with many reservations. Since Langley was not an engineer, he did consult with engineers, although none had any real knowledge or appreciation of his objective.

The most important achievement of Langley, with the help of Charles A. Manly, was the successful design and development of a

10 horsepower gasoline engine that weighed only 120 pounds.

Manly worked as Langley's assistant, directed all of his experimental work on his aerodrome, and was at the controls when the two unsuccessful flight attempts were made. Langley was not even present when Manly tried to fly the aerodrome from the houseboat launch facility in the Potomac River at Widewater, Virginia.

Samuel P. Langley, as secretary of the Smithsonian Institution, had too many other duties to devote his time, which prevented him from perhaps becoming the first man credited with mechanical flight. His workers, except for Manly, were less than motivated and caused many model failures by poor workmanship and made unauthorized changes in the belief that they knew the "minor" correction needed. Had Langley devoted his full time and effort to this task, the results would have been better.

While the Wrights were preparing to fly in a motor propelled machine in 1903, it is interesting to note that Konstantin Tsiolkovsky was proposing space travel by means of a step or multistage rocket using liquid oxygen and liquid hydrogen propellants, while even other scientists were talking of atomic power. Yet, most people at that time did not believe that manned flight in an airplane would occur, much less believe in space operations.

The Board of Ordnance and Fortification of the War Department from 1904 through 1907 refused to believe that the Wright brothers were successful, and continued to send them a form letter each of the several times they offered their invention to the Army. The same form letter was sent to all inventors of perpetual motion machines, and

flying machines were placed in the same class.

Foreign governments were interested, but highly skeptical and afraid to risk their names by entering into an agreement to buy a flying machine. France was the most active country involved in trying to solve mechanical flight but concentrated mainly on stable flight. They imagined that the air would be an extension of the ground in which they could drive and steer the airplane like the automobile. It is interesting to note that, even after all the secrets of flight were known to the Europeans, not a single minute of powered flight was achieved until November 1907. They never fully accepted the fact that the Wrights had flown until Wilbur demonstrated his airplane in France in August 1908. Those who watched were dumbfounded and realized how thoroughly they had been beaten by the Americans.

It was not until 1909 that the airplane was accepted as a practical vehicle. After all the effort of many unorganized individuals, it had taken 110 years for the practical powered airplane to become a reality.

Due to the Wright's later foreign ventures, more pressure was put on the Army by Senator Henry Cabot Lodge to investigate the Wright brother's airplane. It was hard for anyone in politics and certain levels of government to believe the rebuff given the Wrights by the War Department, but even letters to the Secretary of War from Senator Lodge also ended up with the same stock reply by the Ordnance Board.

Finally, in the spring of 1907, Herbert Parson, a Congressman from New York, sent President Theodore Roosevelt a clipping from

Scientific American about the Wright's success with their flying machine. The President, in response, sent the article and a note through the Secretary of War, Taft, to the Ordnance Board. The Board contacted the Wrights requesting a proposal to sell the Army one airplane. The Wright brothers quoted \$100,000 which they knew was an excessively high price. Then the Board needed four months to inform the Wrights that it had insufficient funds. The final agreement for the one Flyer was for a sum of \$25,000 which the Board had. It is ironic that their invention could have been bought for much less had the Wrights been given better treatment by the Army. This example of the Army's performance and lack of foresight was repeated in aviation many times.

The first airplane contract was finally given to the Wright brothers after "competitive" bids on February 10, 1908. It contained an incentive and penalty clause. The baseline speed was 40 mph, and speeds below or above this speed would result in a specified decrease or increase in payment relative to the base price of \$25,000.

Prior to the Army's final acceptance flight of the Wright Flyer, a new wooden propeller, which had been put on the night before for better performance, split and broke brace wires causing loss of control. The resulting crash, September 17, 1908, killed Lt. Thomas Selfridge and severely injured Orville Wright, but he recovered. The plane was rebuilt and it remained the only airplane in the Army through early 1911.

The Wrights first put wheels on their airplanes in 1910. After flying their machines on the Huffman Prairie for all those years, they finally flew over the city of Dayton. The citizens had never before seen an airplane. Most of them did not believe the stories they had

heard about the Wright brother's flying activities.

Wright airplane companies were established in Europe before they were in the United States. When they finally did set up companies here, their first office was in New York with their plant in Dayton.

Grover Loening, the first person to study aeronautical science in a university, began his employment at the Wright Company in 1913, and he later became its factory manager.

At the time of his death from typhoid fever, May 30, 1912, Wilbur Wright was entangled full time in patent infringement suits. His death was a tragic loss to Orville and their business, as well as to aviation in general, but aviation was attracting many other converts who were building their own planes. Foreign governments were by this time very interested in the airplane, especially in England, France, Germany, and Italy.

The Wright brother's accomplishments encouraged others to build airplanes all over the civilized world. The combination of engine horsepower rating, propellor design and efficiency, and structural design were paramount to success. Each year saw advances and setbacks. Flyers died and others stepped in where they had left off, each time making safer and longer flights.

The first metal airplane (monoplane) built mostly of aluminum was done in 1910 by Moisant, but it could not fly. A German, Dr. Adolph Rohrbach, started building smooth skinned metal wings of box spar construction in 1919. This was considered the beginning of the modern stressed skin concept and the basis for structural design of the aircraft that ultimately broke the sound barrier and also helped determine the designs of currently flying airplanes.

There was no organized or systematic research, planning or development of the follow-on work done by the Wright brothers through 1911. Then in 1912, the first known laboratory in the world for experimental studies and investigation to improve the airplane was founded in Berlin, Germany. It was called the Deutsch Versuchsaustalt fur Luftfahrt (DVL) headed up by Hans J. Reissner. In 1913, at Farnborough, England, methods were developed for inspection, testing and basic aeronautical research. Basic aeronautical research and development at that time was for improved airfoils of high lift and low drag with suprisingly little attention given to improving structures. The problems of aerodynamics were being studied by Prandtl, Kutta, Joukowski and Von Karman. The Germans later expanded their operation to include structures, but it was not until 1917 that the United States set up its research and development laboratories covering flight operations for warfare at McCook Field, Dayton, Ohio.

The airplane was first equiped with guns and used in a war in 1911 in Spain. War in the air was envisioned long before when Francesco de Lana prophetically described it in 1670.

The year 1912 brought forth military aviation, the spin, and the first intentional aerobatics, loops, upside down flying, vertical S, inverted loop, bunt and rollout and tail slice.

The United States Army Materiel Division's reason for not building all metal airplanes in 1927 was their lack of accessibility, added weight, high cost of construction and corrosion of thin sheet aluminum. This was still the belief of the Materiel Division when every aircraft manufacturer in the United States was working on all metal airplane designs, which

were mostly financed by the Army and Navy. Practical fabrication of metal airplanes began with the DC-1, DC-2, B-9 and others in the early 1930's. By 1936, airplanes were being constructed of stainless steel and magnesium in addition to those of aluminum, steel, wood and fabric.

World War II did much to extend the frontiers of aviation. Germany developed the rocket and jet propulsion for offensive and defensive war operations. After their defeat, these scientists and engineers were captured and moved to the United States and Russia where they continued to develop rocketry and jet propulsion. Both forms of propulsion were destined to eliminate what was then known as the sound barrier. Rocket propulsion for aircraft, first accomplished in the United States in August 1953, resulted in the design and operation of orbiting flight vehicles and the solution to re-entry problems as well as escape from the earth's gravity.

The Air Force began flying its Century series aircraft in May 1953. They flew faster than the speed of sound in level flight and counteracted a similar flight capability of the Russian MIG-15 in the Korean conflict.

There was a shockwave impact in the United States when the Russian scientists and engineers launched the first successful orbiting space vehicle in 1957. The United States was accustomed to being first in just about everything involving flight. This provided the impetus and challenge necessary for President Kennedy to set the goal of putting a man on the moon in the following decade. This effort commanded the dedication of billions of dollars in research and development, new

facilities, and many vital resources to solve all the problems to achieve this goal. It was a national challenge, similar in nature to the personal challenge undertaken by the Wright brothers in 1899.

The moon task was assigned to the National Aeronautical and Space Agency (NASA). It was seemingly managed to near perfection and the first moon landing by Apollo 11 was made on 20 July 1969 and ended with Apollo 17 landing back on earth on 19 December 1972.

In the early 1940's there was research and development done on composite materials and sandwich construction for the BT-15 and AT-6. Static tests at Wright Field in November 1943 and flight tests in March 1944 proved these concepts. Other such work was done through September 1946 on the AT-6, and it was flight tested for 1600 hours. Composites development was dropped for no understandable reason but was revived in the 1970's. The composite material demonstrated superior strength, durability and a weight reduction of 30 to 40 percent over comparable metal designs, but there were problems with lightning strikes and humidity.

High temperature skin material usage was not a major concern as the United States Air Force during the Vietnam war had reverted back to low and slow type fighting airplanes. Also, supersonic flight over most land areas was essentially forbidden, and flight research was in the transonic regions for better flight economy, thus making composite structures very attractive.

The Federal Aviation Administration (FAA) had responsibility for development of the supersonic transport, but environmental groups in the United States convinced Congress that it should be cancelled.

This decision left a wide open field to England, France and Russia for such flight development and operations. The combined effort by England and France resulted in the Concorde which is in commercial passenger service, but it was prevented from landing in the United States by pressure from environmental groups for several years.

The first all titanium high performance airplane, the SR-71, was built secretly for the Air Force by Lockheed in 1967. This was a revolutionary airplane capable of high Mach number and extremely high altitude which enabled it to be unchallenged for high altitude reconnaissance all over the world. In future years perhaps another new metal will be successfully used to expand the frontiers of flight. The possibility of using metallic hydrogen is no more remote now than titanium was to the designers of the 1920's.

The United States Space Shuttle by NASA uses liquid hydrogen as did many of the space vertical launch boosters up through the Apollo flights. It uses aluminum sub-structure insulated from re-entry temperature by a special insulation bonded with silicone to the aluminum. The space shuttle is a revolutionary step where man can put more things in orbit cheaper and retrieve those which are no longer useful and hazardous to inhabitants on earth. This provides a stepping stone to achieve the age old dream of visiting the stars and planets. It will break the final barrier for both atmospheric and space flight and create new problems for man to safely venture into the universe.

## SECTION IV

### AIRPLANE STRUCTURES AND MATERIALS

Construction techniques for airplanes and glider construction of the 1800's used whatever materials were available relative to needed strength and weight. Otto Lilienthal quickly learned that metal was not suited to his construction ideas and techniques. He considered making metal wings for his gliders, but found that aluminum was eight times heavier than willow wood construction with barely four times the strength. Lilienthal settled on willow wood which could be easily formed, and was much more suitable for his purpose than bamboo or aluminum. The difference between the permanent strain of willow wood and its breaking strength offered Lilienthal a factor of safety of nearly three.

Samuel Langley found that hollow ribs constructed of spruce were much stronger than aluminum tubing of the same weight. Regardless of the material used he found that geometry was a very important consideration. Langley's box-like design for a wing rib, for example, was heavier than an I-beam section, but the I-beam would twist when made long enough for the wing rib design. Many of his ideas were borrowed from nature and he had difficulty evaluating the cause and effect between material usage and design configuration. His research and development were thorough, through trial and error methods, but not always fruitful. The frame of his aerodrome was made from steel tubing which did not present the kind of problems that plagued him in wing design and it was over-designed by comparison.

The Wright brothers settled on spruce wood for glider and airframe construction materials, and were so successful that for many years the general belief was that the use of spruce wood for construction was critical to mechanical flight. Their research and development was more professional, and their success in material usage seemed preordained by comparison to the other experimenters.

The advances of military aircraft were dependent on research and development (R&D) to improve performance - most often at the expense of cost and operating economy. The airplanes were required to fly higher, faster, maneuver better and fly farther than those of the enemy or potential enemy. The R&D effort was imperfect and many problems were encountered early in the life of the airplane.

The use of almost every conceivable material considered for construction of the airplane was related to its strength to weight ratio. The selection and usage of these materials were critical to the design and performance.

The early airplane designs showed the influence of the structural work of the civil engineer using wires and trusses. While they may have been strong and useful, they lacked the aerodynamic shapes to reduce drag and the light weight necessary for high speed and efficient payload.

To obtain the best possible weight advantage, the Wright brothers used a one piece engine casting of aluminum alloy. Aluminum was used in 1907 for aircraft propellers. The first aluminum airframe was for a bomber in 1916 designed by L. Breguet.

It was Hugo Junkers (Germany) whose inventive genius paved the way for advanced airplane design in 1912. He conceived the idea of building airplanes with wings thick enough to carry fuel to save payload space in the fuselage. It was he who also conceived the all metal cantilever wing (which did not have the conventional wire and struts). His work resulted in the Junkers J-1 in 1915 and it was still being used in Spain in 1956. The Junkers F-13 (metal wings and fuselage in 1914) all metal transport is dated 1919.

The World War I treaty requirements generally relegated the German aviators to gliders and they were not able to contribute to powered flight for several years. They are credited with the development of duraluminum (17ST or 2014-T4) in the middle 1920's.

The United States continued to use wood for airplane construction. The experimental work in airplane structures was directed toward light weight materials. In the early 1920's, at McCook Field, a number of plywood and composite structures were tested in an effort to achieve higher strength and lower weight. New materials and methods of fabrication were also evaluated from time to time such as the CO-1 all aluminum structure in 1921, but there was a strong reluctance to design an all metal airplane.

Around 1927, the reason the United States government gave for not building all metal airplanes were such things as additional weight, high cost of construction, lack of accessibility and corrosion of thin sheet aluminum. Yet at the same time the Army and Navy financed private aircraft companies in aluminum design.

In 1931 and 1932, two twin engined, cantilever wing, all metal, monoplane bombers were delivered to Wright Field for competitive evaluation. The non-selected airplane then became the first all metal airplane to enter commercial service in the United States. The winning airplane made use of semi-monocoque construction, developed at Wright Field, using aluminum alloy thin sheet metal. This was the beginning of stressed skin airplane design and unstressed fabric coverings were relegated to control surfaces. Weight became an even more pressing problem. To achieve desired performance, a weight group was established with the responsibility to standardize weight statements and calculation methods.

The use of new materials or construction methods on flying airplanes resulted in a development program to substitute a modified existing wing, fuselage, tail or secondary structure for complete evaluation. These structures were tested to some realistic loads in order that a direct comparison could be made. When proven structurally sound the component was installed on that particular airplane it was designed for and flight tested.

In the early 1940's the glass fabric polyester radome material was used in several development concepts. These concepts used glass fiber laminates and sandwich construction. The BT-15 airplane monocoque aft fuselage section was redesigned using a plastic laminate sandwich utilizing glass cloth fibers faced with end grain balsa core. The construction was completed in November 1943 and it was flight tested in March 1944.

Another effort was the redesign of the entire outer wing panel of the AT-6C advanced trainer. This design utilized glass cloth laminates, both as a solid and sandwich core construction. The sandwich core material used was cellular cellulose acetate with glass fabric polyester face sheets. Fabrication of the first wing panel was completed in May 1946 and several others were fabricated, tested and installed on AT-6C aircraft which accumulated 1600 flight hours.

These early composite materials applications were reasonably successful, but work was discontinued for no particular reason. Since that time new aluminums and steels, titanium, columbium, super alloys for elevated temperature operation, fiberglass and filamentary composites (carbon, boron, and Kevlar<sup>(R)</sup>, etc) have found uses in new aircraft after extensive development programs. All were tested and evaluated in an effort to find a better, stronger and lighter material to cut the structural weight fraction of which the structure may account for 1/4 of the total airplane weight. Composites are claimed to be capable of reducing this by 30 to 40 percent. A current problem being studied is the effect of moisture to boron-epoxy composite structures. Practically no work is being carried out for its use in supersonic or hypersonic structures and not much work with metals or ceramics. Our past history clearly shows that military aircraft performance will not stop at Mach 3 or 4.

The present work in structures in the Air Force Flight Dynamics Laboratory centers on advanced composite materials and assembly and bonding methods and techniques which essentially eliminates structural fasteners.

(R) Registered trademark of Du Pont.

Metallic advanced development relates to high toughness steels for improved fracture resistance. The F-16 laminated aluminum wing box structure minimizes or eliminates fasteners in a 1978 metals advanced development program. The Built Up Low Cost Advanced Titanium Structure (BLATS) emphasis is on weld bond design using spot welds in combination with structural adhesive to improve the strength to weight ratio and fatigue. There is also design and development work on high toughness steels such as the B-1 wing carry through Advanced Metallic Air Vehicle Structure (AMAVS).

## SECTION V

### AIRPLANE DESIGN AND TEST CRITERIA

Perhaps much of the design criteria for airplanes evolved very slowly from trial and error experiences, but it is now an essential element in design and operation of the airplane. Test criteria came first in the Wright brothers approach to flight safety in order to assure survival in their work to build a successful flying airplane.

The beginning of airplane maneuvers started with the Wright's first circle flight and it came of age when they made turns within 100 feet while demonstrating in Germany in 1910.

The Wright brothers were successful in every aspect of airplane design and construction, and the establishment of a factor of safety of five for their airplane assured adequate strength to their airplane for experimentation without loss of their lives from structural weakness.

Flight testing was the basic method for proving an airplane's handling and strength characteristics, and several different pilots were used to evaluate it in the 1910's. Crude wind tunnels were also built by the designers and builders to help understand the physics of flight. During World War I, unexpected flight forces on airplanes caused structural failures. To compensate, the designers increased the factors of safety and tried to improve their wind tunnels.

The first serious experimentation concerning all flight aspects was done at McCook Field, and the engineers were able to predict the performance of an airplane before it was built. These engineers

achieved prominence from the textbooks and handbooks which they wrote. Alfred Niles, Chief, Structures Branch, Engineering Division, U.S. Air Service, wrote several reports and books on aircraft design. McCook Field engineers prepared "A Handbook of Instructions for Airplane Designers", (HIAD), and it was continually updated to the present day. They also helped prepare the Army, Navy, Commerce (ANC) series of design specifications of which the old ANC-5 Materials Design Handbook is the most familiar to test engineers and designers.

A serious drawback to airplane design, around 1920, was due to the lack of materials suitable for building monoplanes which would be resistant to flutter. The biplane with wire trusses gave confidence to the aviators and was also simple to design and build. The monoplane required high torsional strength and rigidity to prevent flutter, which at that time the problem or cause was not fully understood. It was first experienced in 1922 in high speed thick wing monoplanes.

Early designs for load factor and airplane testing were directed mostly to wing strength first and fuselage strength second, as the fuselage was believed of secondary importance to safe flight. Some of the early gliders and airplanes which were designed to withstand what was believed to be adequate strength in the air would break up from the wind while on the ground. As a result, special design considerations then had to be given for ground and ground handling loads. Early designers also believed that the lighter airplane needed a higher safety factor for tail surfaces. Consideration was eventually given for the nose over condition and for building

sufficient strength to provide the pilot and passengers quick egress in a crash. Thus, McCook Field engineers developed design criteria for all facets of flight and ground handling as knowledge became available from both flight and test experience.

Lt. James H. Doolittle of the U.S. Air Service conducted acceleration flight tests in a Fokker PW-7 pursuit airplane in 1924, and was able to pull 8 g's whereas only 4-5 g's were the highest load factors ever recorded or knowingly reached before that. The design criteria was changed to reflect this capability and the wings were required to withstand a load factor of 12, with a fuselage design of seven. This was also the design load factor for the landing gear. Loads were arbitrary, primarily from ignorance or lack of experience, and it was in the time period from 1919 to 1926 that the Army and Navy had the first disagreement on test loadings of wing ribs. They were to have many more. The Army Air Service required tests of the wing leading edges, but the Navy Bureau of Aeronautics did not, and it also used a different method for testing wing ribs.

The ratio for the design load to the maximum probable load (factor of safety) in this time period was two. Tests were largely intuitive and most loads and load distributions were arbitrary, even though efforts were made to spell these out in specifications and handbooks.

The dynamic or drop test, to prove landing gear strength, was considered adequate at that time even though foreign governments had used a method of rotating a drum of sufficient inertia and forced the gear, wheel and tire onto it at varying speeds to simulate the

drop test with wheel and tire inertia. The vertical velocity for drop tests at McCook Field was determined by drop testing the JN-4 to destruction. These results were used to determine the heights of free drops for the other various types of airplanes.

Some of the first test conditions were based on impressions obtained by the designers who, on seeing how wings failed in flight, then tried to test them that way.

Pilots experimented with new and different flight maneuvers. Structural failures were somewhat common in barrel rolls and it was difficult to determine the cause as the accelerometer gave low "g" readings. It did become evident that the increased load factors at the tips were caused by the rolling acceleration. Thus, it was from such experiences as this, that even though an airplane had successfully passed the required tests of the time period, it was not necessarily safe for all flight maneuvers. Air races served an incentive to increase top speeds and spurred new developments. Each new airplane flight regime usually resulted in higher flight loads than those to which it was tested. Testing only proved that the structure was as strong as the loads applied under the conditions tested which were assumed to exist in flight and on the ground.

Air Service specifications were issued concerning all kinds of materials used in airplane manufacture. Glue tests and specifications were extremely important during this early period, as were rivet tests in relation to metal fabrication which followed.

Development testing on wood veneer fuselages was done by the Air Service through the cooperation of Forest Products Laboratory.

These had many advantages over the truss fuselage of the same size and strength and the wood veneer fuselage weighed less.

The Curtiss Company carried out many tests as early as 1919 to obtain exact materials data which was used to check against stresses figured from wind tunnel data to insure a high factor of safety. These factors of safety supposedly made the Curtiss airplane as reliable as bridges or tunnels. This was an obvious indication that the designers were primarily civil engineers. The Curtiss Company pioneered materials testing and light weight design, and worked closely with the Navy on flying boat designs involving light weight structures.

It should be noted that the French and Germans built laminated wood fuselages before and during World War I, and perhaps some were built in the United States during World War I in an effort to achieve lighter structures with greater strength.

Airred Niles, in 1925, stated in his book "Airplane Design", that if both external and internal forces are considered, then the forces on the airplane must satisfy the conditions of equilibrium. He did not have the means to test airplanes using this concept then, and it was not until nearly thirty years later that an airplane was suspended in the test jig and loaded, as if in flight, for true equilibrium balance of the external loads and such that the true internal stresses were produced. This floating balanced condition also produced the correct wing-fuselage interaction.

The Engineering Division made a record of all the special rules for computing loads in the 1925 edition of the Handbook of Instructions for

Airplane Designers (HIAD) to use as a guide. The test conditions listed were:

High Incidence

Medium Incidence

Low Incidence

Inverted Flight

As load distributions on the wings became better known, a need existed for duplicating them in static test more efficiently than by using sand in buckets and by pouring and raking it over the wing span and chord. This was solved by the construction of five and ten pound sand bags made from flat stitched canvas which were stacked up on the test surface to approximate the spanwise and chordwise loadings. Positive wing loads were applied with the airplane inverted, and negative or inverted flight loads with the airplane upright.

Around 1928, the Aeronautics Branch of the Department of Commerce created a board to review aircraft accident reports and to determine the causes which also helped establish new criteria in learning from accidents. No design criteria in published form was available until 1936. Up to that time Army Serial reports, Handbook of Instructions for Airplane Designers, the ANC series and specifications, and the book Airplane Design by Niles (published in several Army Serial Reports) were used. Engineers were not in agreement on airplane design methods and the X-1803 Structures Design Criteria by Al Epstein, Engineering Division, which later became SPEC C 1803, helped. It was issued without industry or government committee activity or approval. It established the formal requirement that any aircraft or component

would have a safety factor of 1.5 rather than 2.0 which was in use during the 1920's. Basic data for computing air loads was in the HIAD. Airfoil properties used in design were developed from NACA's wind tunnel tests and were considered accurate. This assumption held until the early 1950's.

In 1929, the Guggenheim Foundation offered \$100,000 for a safety award which made some contribution to design criteria. Twelve airplane manufacturers participated. The safety award was won by the Curtiss "Tanager" airplane in 1930 which used wing flaps and other high lift devices. Aircraft airworthiness requirements were also established by the Aeronautics Branch, Department of Commerce in that year which emphasized a need for safe designs.

Until the 1930's, load factors specified for design were ultimate. There were not enough flight records available to establish any relationship between the ultimate load factor and the actual load factors experienced in service. There were no flight restrictions other than those implied by the ultimate load factor.

The Fokker PW-7 flight test program in 1924 had a load factor of 7.8 developed in a sharp pull-up from a dive. It was designed for a load factor of 8.5 and had an estimated ultimate strength of 10 g's based on the limited knowledge of aerodynamic loadings at that time. It would seem obvious that for a design load factor of 2 that the 7.8 g loading was not considered a maximum probable load. Because of the program, the ultimate load factor for a pursuit airplane was raised to 12 g. In the F6C-4, in 1929, a load factor of 10.5 was developed in a pull-up, and in a flight loads test program on a PW-9 pursuit

airplane, in 1930, accelerations up to 9 g's were reported. Both were designed for an ultimate load factor of 12. For these airplanes a factor of safety of 1.5 existed for flight operations. A decision had to be made concerning what limit should be placed on flight operational g's and still retain a factor of safety of 1.5. The principle of designing to the maximum recorded load factor was recognized as unwarranted because of the weight increase and loss in performance.

In 1930, Air Corps regulations adopted a method for determining design tail loads based upon balancing the airplane throughout its speed range. These loads were multiplied by a factor of 1.5 to determine ultimate load for design. This was the first time the factor of safety of 1.5 appeared in Air Corps requirements and for use on the horizontal tail. The factor of safety allowed for possible imperfections in materials, approximations of analysis and for insufficient loads knowledge.

The factor of safety had limited significance until a V-c flight boundary was defined; the Navy Bureau of Aeronautics was the first service to specify this diagram. The 1.5 factor for design was also influenced by the use of 24 ST aluminum alloy where the ratio of 1.5 existed between ultimate tensile and yield strength. From this characteristic, the principle that an airplane should operate within its flight envelope without any significant permanent set was developed. Yet, it remains that the origin of the 1.5 factor was due to opinions as to severity of representative flight operations at the time.

In 1936, airplane usage was such that accidents occurred because the airplanes were not designed for all weather flying, but they were being flown regardless of weather conditions. The military were just beginning to tackle the problem with the first pressure cabin airplane, the XC-35, which was soon followed by other designs providing better flight environment for the pilot who was only part of the problem.

It was believed that all-metal airplanes were limited in usage and capability because of the thin metal skins which buckled under load. Von Karman and perhaps others, discovered that there were ways to design metal structures so that its strength would be adequate after it buckled, without consideration of the aerodynamics which resulted. Thin skin and stringer construction developed because of theories worked out involving effective skin width. This development started studies for design criteria on thin metal skin buckling on flat and curved panels.

Design criteria improved by necessity, as in the past, yet many service airplanes were still being lost from structural failures. Most were caused by a failure of some primary member, and few, if any, new structural designs (including new material usage) were in service operations very long before they experienced structural failure. Accident investigations usually revealed the cause (and source) of a failure, and the structure was again analyzed, redesigned, modified and retested until satisfactory operation was obtained.

A survey of leading airplane manufacturers, Navy, NACA, CAA, experts, and universities in 1946 showed the overwhelming reluctance

to accept stress analysis by itself as proof of an airplane structure. Only three indicated that on new airplane designs, stress analysis alone, or in conjunction with representative sections being tested, was adequate to guarantee the ultimate strength. Since the Air Force was faced with transition from war-time to a peace-time organization, the basic question concerning justification of buying an airframe and providing for the test costs had to be defended.

Studies were then made to justify static testing of airplanes. Also, during the 1940's and 1950's, after airplane manufacturers were finally permitted to test their own designs for the Air Corps and Air Force respectively, there were questions which had to be answered to higher levels of management on the issue of less costly testing in the Air Force facility. One documented example, typical of many through the years was the B-29 tested by Boeing Aircraft in 1942-43 at a cost of \$825,000. The B-29 had a gross weight of 105,000 pounds as compared to the C-74 with a gross weight of 145,000 pounds which was tested at Wright Field in 1947 at a cost of \$197,000.

At that time, Headquarters, Air Materiel Command (AMC) had data on 71 aircraft which had a complete stress analysis prepared and which had been subjected to complete structural test programs. This survey covered test failures from 1940 to 1946, and showed stress analysis accuracy of approximately 80 percent. In this study, 60 airplanes (84.5 percent) had one or more structural failures in a wing, fuselage, horizontal tail, vertical tail or landing gear. Ten percent of the failures occurred at less than 60 percent of ultimate load, 14.7 percent from 60 to 70 percent ultimate load, 28.9 percent from 80 to 90 percent

percent ultimate load, and 36.8 percent above 90 percent ultimate load. From this data, Major Leon S. Jablecki of the Aircraft Laboratory showed that structural failures are to be expected frequently in static tests of major airplane structures which could be attributed to analysis inaccuracies or errors. Jablecki's report seemed to substantiate the fact that static testing is essential for aircraft structures designed with small safety factors. Almost all failures occurred in some type of joint, fitting, cutout or other load transition area. The fact came out that testing has proven effective and necessary for determining manufacturing defects, analytical deficiencies and disclosing human design errors.

Further studies by Freudenthal and Wong, and Jablecki and Thomas showed the need for structural testing of aerospace structural systems. These studies indicated that one-third to two-thirds of the tested structures failed at a lower load than predicted by the analysts. While the difference between the 1940 data and the more recent data indicates a significant improvement in analytical accuracy, the role of the standard static test as an error discloser is still very evident.

The airplanes during the 1940's were tested to the static and dynamic loads as specified by Volume I, 8th edition of the Handbook of Instructions for Airplane Designers, Air Corps. U.S. Army and Air Corps Specification C-1803A. The classical airplane test conditions were still being used and the airplanes were dropped to prove the landing gear strength. Elastic axis determination and torsional rigidity tests were being run as required for analysis purposes.

Typical test conditions in the 1940's on wings were Elastic Axis Determination, Torsional Rigidity Test, Negative Low Angle of Attack, Positive Low Angle of Attack, Positive High Angle of Attack, and Negative Low Angle of Attack to failure. The horizontal tail surfaces were tested for a Balancing Tail Load Condition, Pull-up Condition, and Pull-up Condition to failure. The vertical tail surface was tested for Gust Condition, Pull-up Condition and Pull-up Condition to failure. The fuselage was tested to Positive High Angle of Attack Condition plus torque and then tested to failure. The landing gears were tested for Three Point Landing (drop test), Level Landing with Inclined Reactions (drop test) and Drift Landing Conditions. The miscellaneous tests included ailerons, flaps, elevator trim tab, control system, seats and supporting structure, slat and slat attachment and other required miscellaneous tests.

Dynamic landing load tests began in early 1944 at Wright Field because B-24 airplane stabilizers were failing in service usage. These stabilizers were designed for 20 g static loading. The failures were attributed to dynamic loads that occurred during hard landings. In an effort to solve this problem, flight tests were made with accelerometers and strain gages used to measure vertical, lateral and longitudinal incremental accelerations at the center of gravity. Also, vertical incremental accelerations were recorded at the fuselage nose, stabilizer root, stabilizer tip, wheel well, outboard engine, and at wing tips. Strain gages were installed to measure the drag, vertical and side loads on the main gear and nose gear. Wheel angular displacement was measured with a photocell circuit. The signals were

amplified and recorded on a multi-channel oscillograph.

Two and three wheel landings were made on sod and concrete runways with cross-winds to 20 mph. The large dynamic accelerations measured at the stabilizer were found to be due to resonance between the fore and aft vibration of the landing gear and the vertical bending vibration mode of the stabilizer.

The recommendation to solve the stabilizer failures was that landing gears be designed to withstand forward loads of the same magnitude as the rearward loads. Subsequent flight testing resulted in adding a spinup condition for design.

In the early 1950's, many of these same basic test conditions remained in effect with Positive Symmetrical Condition, Dynamic Landing Condition, Maximum Rate of Roll Condition and Unsymmetrical Flight Condition. Also, external and internal store tests were added for restricted airplane flight maneuvers. Cargo aircraft required testing with internal cargo and tiedown arrangements to the floor. Wing fuel and cockpit pressurization were required and, in at least some cases, the effect of the fuel pressure due to high rolling acceleration was simulated. Landing gear tests were more involved with springup and springback test conditions added, among others, during landing. Test conditions for taxiing, towing and jacking were also required. High roll rates increased the number and kind of tail test conditions.

The need to calculate airloads on all of the airplane surfaces became necessary in order to balance the airplane under equilibrium conditions for static testing. Static testing was complex even before the need arose to simulate aerodynamic heating, cooling or fuel temperature.

These additional requirements resulted in the updating of the specifications in the early 1950's and SPEC C-1803A was changed to MIL SPEC 5700 series. Further revision to satisfy increased design and test requirements resulted in that series being replaced in 1960 with MIL SPEC 8860 series.

Aircraft structural design continued to be a problem for the designer into the 1950's since he had to know the loads experienced in flight and had to depend on less than exact data. Prior to flight load measurement programs, the design loads were based on experience, empirical load equations given in specifications, aerodynamic data calculated for a particular airplane, or from wind tunnel tests on scale or full size models of an airplane.

Before the Aircraft Structural Integrity Program (ASIP) was fully in force in 1958, many of the design loads for fatigue were doubtful, because the exact relationship between fatigue and static load design requirements was not established. Static loads were used for design. These had been derived from the actual flight envelope measurements on high performance airplanes since June 1952.

The criteria for safety in airplanes which carried nuclear bombs involved very stringent test and operation procedures. At least one airplane of each series was fully instrumented and calibrated in the laboratory. Absolutely nothing was left to chance or ignorance and the ASIP benefited from these tests. These airplanes were continually monitored for wing bending loads and other critical areas while in flight. This represented the first time that additional flight testing had been done aside from demonstrating that it could perform inside its flight

maneuver envelopes (V-g diagrams) which included gust effects to limit load factors.

There was some tendency before the F-89C static and fatigue flight failures in 1952 to return to the idea that static test might not be essential. The F-89A static test program had revealed no major structural discrepancies, and based on those tests, and the recommendation of the stress analysts, the F-89C model was not static tested before going into service. After the F-89C series of flight structural failures, a flight measurement program revealed a more outboard center of pressure and a higher wing loading on this airplane. For one major flight condition, the measured load was almost twice as high as used for design. Once the static strength problem was resolved, attention was focused on the fatigue life.

These problems precipitated the Structures Division of the Aircraft Laboratory to formulate an aircraft structural integrity program which included instrumented flight test airplanes to measure actual flight loads for all new air aircraft. This program also included a static test article. Problems with the B-47 fleet in 1958, followed by the B-52, resulted in adding a requirement for a fatigue test article to MIL SPEC 5700 (changed to MIL SPEC 8860 in 1960).

Steps taken to improve the structural integrity of high performance aircraft at that time consisted of design criteria, static test, flight loads survey, fatigue test, low altitude gust environment, mission profile data, interim service load program "VGH" life history followed by the 8 channel service loads history, sonic fatigue and high temperature testing in conjunction with static and fatigue tests.

Specific emergency steps were taken in April 1958 in an effort to save the existing strategic type combat and support aircraft. The first step was an interim oscillograph recording program to expedite the collection of service loads data on B-47, B-52F, B-58, KC-135 and C-133A aircraft. A Century 12 channel oscillograph was used (as it was readily available in quantity) to collect VGH (velocity, gravity and height) data. This program was followed later with an extensive recording program that included 19 different aircraft in a joint service load program. That program was delayed because an advanced recorder was not available. Flight recording was not new to the Air Force as it was first done in the late 1930's. At that time the Aircraft Laboratory used a two channel "V-G" recorder developed by the National Advisory Committee for Aeronautics (NACA). In 1945 the laboratory's Structures Branch developed the "Hathaway Flight Analyzer" and used 40 during the Korean War, primarily, on fighter aircraft for VGH data.

The need for an improved tape recorder for the eight channels of required data was noted in 1954. In November of that year, the National Advisory Committee for Aeronautics proposed that the data collecting be expanded to eight channels. In November 1955, an inter-service agreement was made to develop an eight channel recorder and data reduction system. In January 1956, Wright Air Development Center began work to satisfy the Air Force portion of this joint program. Sixty instrument manufacturers had representatives at Wright Field for a bidder's conference and a month later 20 proposals had been received. Three study contracts were let to the Benson-Lehner Corp., Emerson Radio and Phonograph Corp., and Radiation, Inc. These study reports

were submitted in April 1957. Two months later, design and development contracts went to Radiation, Inc. and Emerson Radio. The contract with Radiation, Inc. was cancelled in September 1957.

A critical turn in the structures program in 1958 resulted in WADC drawing up specifications for repackaging the eight channel device and obtaining a three-channel recorder immediately to serve the pressing needs of the VGH program. Two prototypes were delivered in June 1958 by Emerson. In November, it was designated "Signal Data Recording Set A/A-24U-3." Work continued on eight channel recorders and in March 1959 the first five were installed in B-52 airplanes.

A contract for 644 recorders and three ground playback units was terminated with Emerson on June 7, 1961. Efforts to modify and develop flight recorders to meet the requirement prior to this cancellation resulted in development contracts to Dalmo-Victor, Olympic, Lockheed and Telecomputing in 1960 and 1961. Telecomputing was bought out by Whittaker Corp. which started work September 1962 on the recorder, and was finally able to develop and produce a satisfactory 8 channel recorder in February 1965. It was put into operation as a 9 channel system. Eight channels were for recording and ground station reproduction of flight information with the ninth channel recording elapsed time.

The Whittaker recorder (A/A 24 U-6) was small in size (7-1/4" x 7-1/4" x 8"), accurate and crash resistant, capable of recording 8 channels of 0-6 Hertz structural data for 25 hours or 0-12 Hertz for 12.5 hours. Thus ended the difficult and time consuming effort to obtain a satisfactory flight recorder for the structural integrity program fulfilling all Air Force and Navy requirements.

After large scale scientific computers became available, it was believed by some that stress analysis would be improved to the point where static testing would not be needed. As it happened, there were no dramatic improvements which could justify elimination of static and fatigue testing. Much of that which was developed remained as theory, and no dramatic breakthroughs in respect to stress analysis as compared to test results came about. There were several good structural design programs developed and they have been used to great advantage. Every time the structural stress analysts seemed on the verge of proving their theories, problems would develop in new service airplanes which resulted in new criteria and required additional analysis and testing.

Prior to 1970, because the airplanes were designed to a specific gross weight, there were a number of programs designed to reduce the weight after the airplane was in service. Static testing to failure was also an important part of this effort. These programs sometimes built in future operational problems since the testing was not always sufficient to determine such limiting factors as fatigue, stress corrosion or intergranular corrosion experienced in operational conditions. The high strength materials were susceptible to surface blemishes, corrosion or scratches, and these resulted in progressive fractures through the material at a relatively low average stress level until fracture.

The established fatigue factor used to cover variations in material tolerances, manufacturing, assembly and operation was changed when new data from fracture mechanics studies became available. The results of this work provided that no crack could reach a critical length in one



FIGURE 2

A lower surface view of the B-58A right wing failure at span station 34 resulting from a destruction test using MMC-1a at 135 percent design ultimate load. This extra strength alleviated the speed and load factor restrictions at 180,000 pounds gross weight. February 1962.

lifetime where it could not carry the airplane design load.

Charles Tiffany, Aeronautical Systems Division, was instrumental in changing this criteria and the test requirements. A new military specification was issued July 1974, MIL-A-83444 (USAF), outlining the airplane damage tolerance requirements, and service inspection requirements. This specification paved the way for a later revision to MIL SPEC A-008867B in August 1975.

The new MIL SPEC A-008867B required design development tests; proof, ultimate, and failing load static tests using a full scale airframe; durability tests using a full scale airframe; damage tolerance tests; and, fuel tank tests. It changed the test life fatigue factor from four to two with consideration of the economic life when the structure fails at less than two lifetimes. There is a further hedge concerning the full scale tests. It is now possible for a contractor to satisfy the requirements of this specification by testing only critical separate major assemblies of the airplane as was done with the B-1 test program in 1975-77.

## SECTION VI STRUCTURES TEST FACILITIES

The lack of central engineering and experimental facilities delayed aircraft production for World War I, according to the Aircraft Production Board. Prior to our entry into World War I, very little attention had been given to aeronautical research within the Signal Corps' Aviation Section. Some experimentation had been done at flight installations at North Island, California and at Mineola, New York, but it was hit and miss with no improvement in the aeronautical sciences.

In 1916, the War Department purchased 700 acres on lower Chesapeake Bay for use as an engineering development station and proving ground for aircraft. World War I forced a change in plans for Langley Field, as it was named, and it was used as an aviator training school instead. At that time the one engineering department in the Army had only a handful of engineers and draftsmen who worked in the Aviation Section in Washington, D.C.

After the war, the Aircraft Production Board selected Dayton, Ohio as the site for its experimental work. South (Moraine) Field, used by the Dayton-Wright Airplane Company, was being used for experimental work and the Aircraft Production Board was first interested in it, but Charles F. Kettering and H.E. Talbott, Sr. objected. While the search for a suitable location continued, aeronautical engineers and technicians worked in temporary offices in various buildings throughout downtown Dayton.

A lease was later signed between the government and the Dayton Metal Products Company at an initial fee of \$12,000 a year for North Field. The metal firm and Orville Wright had originally acquired and graded the property for a private flying school. This site lay in a bend of the Miami River about one mile north of the downtown Dayton business district and was named McCook Field. The name honored the McCook family which had achieved fame during the Civil War as the "Fighting McCooks", and because part of the land had been owned by the McCook family.

The work of constructing buildings was started late in 1917 and everything was done in a hurry. By the early part of 1919, the flying field had a 100 foot wide by 1340 foot long macadam runway and 69 buildings, which included hangars, shops, laboratories, offices, a hospital, wind tunnel, etc. The lease now cost \$36,000 a year. No rail line serviced the field, the maintenance and fire prevention of the poorly planned wooden structures were costly and rental after 1924 had increased to \$60,000 a year. Of greatest significance was the inadequacy of the flight facilities where the prevailing wind for takeoff was across the least dimension of the field. Expansion was impossible as it was bordered by the river and practically surrounded by residential areas, and was located within the Dayton city limits with takeoffs and landings over the populated areas. A new location was considered essential but Congress refused to appropriate money to purchase new land.

The prestige of aeronautical experimentation and the payroll was important to Dayton business leaders, and they formed the Dayton Air

Service Committee with the goal of keeping the Engineering Division in the Dayton area. A fund raising drive brought in approximately \$450,000 and this money was used to purchase 4,525 acres of land located south of Mad River, five and one-half miles east of Dayton. This land encompassed Wilbur Wright Field which contained 2,075 acres. It was leased by the government from the Miami Conservancy District in early 1917 to train British, Canadian and American airplane pilots during the war in the area which now includes Huffman Dam and the city of Fairborn. The lighter than air work was also conducted at the Wilbur Wright Field. Earlier, Maj Benjamin D. Foulois of the Aviation Section had viewed the site and endorsed it.

This land was presented to President Coolidge as a gift from the city of Dayton in 1924 under the condition that the land be used for an experimental facility, and that it would revert back to the city if it was later abandoned by the government.

The work of clearing and grading began in 1925 with the construction of the buildings starting in 1926. Dedication of Wright Field took place on October 12, 1927, ending the ten year history of McCook Field, the birthplace of Army aeronautical engineering in this country.

The Materiel Division moved from McCook Field in the spring of 1927. Wright Field was five and one-half miles east of Dayton and occupied 747 acres at the extreme western point of the 4,525 acres.

Static test operations were performed in the Final Assembly Building (Bldg. 31) until the static test building (Bldg 23) was completed with the authorization of \$900,000 on March 10, 1928, and

finally occupied in December 1934. As at McCook Field, all contractor built airplanes were static tested by the Materiel Division at these new locations.

The Wright Field static test laboratory building which was completed and occupied in December 1934 was 182 feet long, 102 feet wide, with a maximum height of 61 feet with the lower chord of the roof trusses 45 feet from the floor.

It was a steel frame, brick faced building with some consideration given to sound deadening from the nearby power plant and propeller test laboratories. The front face north and had a center opening of 100 feet which closed with eight sliding doors on two tracks. Door height was 35 feet. A 15 ton crane extended out 80 feet across the railroad track to facilitate loading and unloading test structures directly from railroad cars. The south side of the building was entirely of brick with a tile back wall to help headen noise and to provide a background for pictures of test setups.

Column and truss spacing was on 20 foot centers with a center row of columns designed to support the roof and crane tracks. The south half was equipped with a five ton crane traveling the full length of the building. In the center, a 60 foot opening was provided to move airplanes from one side of the building to the other without removing the wings. It was spanned by a flat bridge truss designed for roof loads and the crane tracks. The trusses over the main door and 60 foot openings were designed to support a 50,000 pound concentrated load.

The test floor was divided into two halves, front and rear, approximately 50 by 180 feet each half. Inserts embedded into the



six inch thick concrete, flush with the surface, were designed to carry an up load of 15,000 pounds each. Their purpose was to eliminate the handling of lead shot and sand bags in static testing for unsymmetrical load conditions and for applying a load (down load to inverted structures) to the structure under test.

Two heavy test jigs, one located in the center of the building under the 60 foot opening and the other located at the west end of the front half of the building, were for testing large wing panels. Each steel jig was designed to withstand a 2,500,000 foot pound moment and a shear of 100,000 pounds.

A three floor structure was provided in the west end, rear half of the building for a small shop and men's washroom on the ground floor; office space, instrument storage, dark room and ladies rest room on second floor; and storage on the third floor.

Edgar R. Weaver was chief of the Static Test Laboratory and responsible for its design and construction. Rigidity of the steel structure for future vibration tests was a concern, since it was assumed that the test structures would be suspended from the roof trusses and cranes. The structures were to be vibrated until failure.

Within ten weeks after this building was occupied, all of the occupants were effected by the magnesium-fluoro-silicate hardener used on the concrete floors which caused respiratory and skin problems. The problem was solved by painting everything.

Between 1927 and 1944, the work of building and testing aircraft with reciprocating engines and propellers advanced and improved.

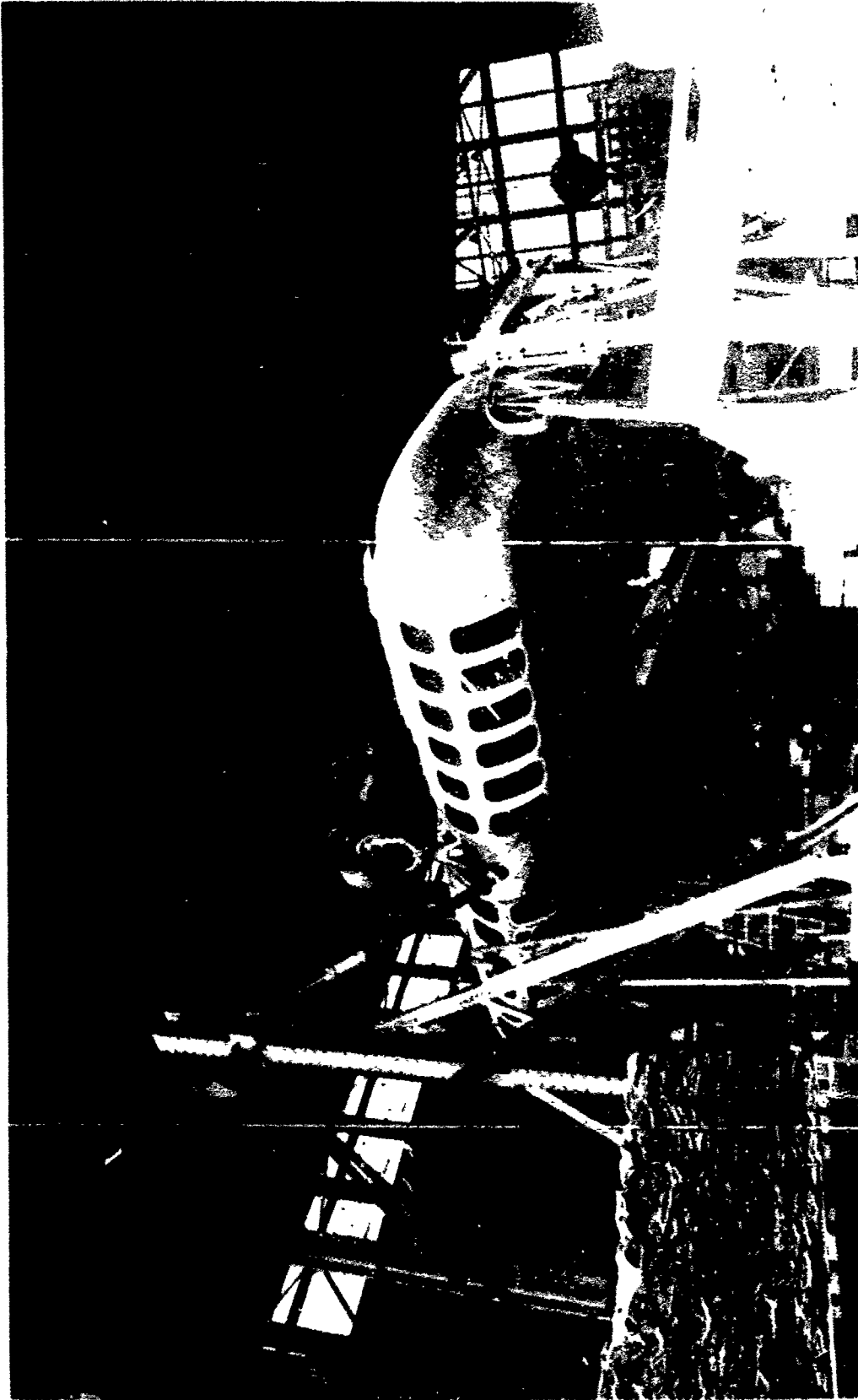

FIGURE 4

XCG-16A wooden troop and cargo glider being static tested in Building 28 at Wright Field in 1944. Note large stack of shot bags to react load because test floor does not have adequate load inserts. Hydraulic loading is shown for loading the tow hook.

Hostilities prior to World War II precipitated aircraft development and construction beginning in 1939 on a scale unheard of in history. A large number of different types of aircraft were being built and the static test building was once again considered too small to effectively handle the work.

The increasing buildup in aircraft overtaxed the test facility and manpower at Wright Field. Approval was obtained from Congress to build a new static test building with the war emergency Wright Field construction program. The site selected was south of the existing facility, adjacent to the south embankment of the gun range and near the flight line.

Rationale for the new static test building was based on the lack of storage space in the existing building and that approximately one-half of the test floor space had piles of lead shot, sand bags, structural steel and apparatus. Also, it was too small to efficiently static test the B-17B airplane, and the 15 ton crane was not adequate to lift the 45,000 pound airplane. It was noted that airplanes under construction at that time had gross weights two and one-half times the B-17B and they had wing spans greater by 40 percent with even larger ones in design.

The original planners for the new static test building (Building 65) rejected the inclusion of a cast steel test floor because it was too expensive and would take too long to deliver. They even rejected the use of second hands on the clocks in the interest of economy. The large door was originally planned for the

north end of the building that faced the gun range embankment. Mr. Weaver suggested putting doors at the other end (west). The south wall was to be solid masonry to protect the main test floor from the direct rays of the sun to protect the test area from its heat. This requirement for the south wall was to be given first consideration in importance.

The new building height had to be sufficient to handle large airplanes, principally in physically turning over such aircraft as the B-19 with the fuselage and center section still attached (to the wings). A 100 ton electric bridge crane on a span of approximately 125-1/2 feet was planned for hoisting and dropping airplanes of the B-19 class. At least 60 feet was needed between the lower roof truss and the floor. Another electric bridge crane of 75 ton capacity was required with provisions for adding another one later on. A permanent test jig of 5,000,000 ft. lbs. capacity on 10 frames was planned and the existing ones in Building 23 were to be moved to the new building. The test floor was required to have 400 hold down fittings of 10,000 pound capacity each.

A three story structure attached to the main test floor east was required for storage of sand bags, shot bags and structural steel for use on the first floor, a machine shop, and instrument and drafting rooms along with the office space being sound proofed and air conditioned. The newly acquired hydraulic machine was to be moved to the new building.

Somewhere between the preliminary design specifications and the final design by Hazelet and Erdal, Chicago, Illinois, the new building

was changed. The north wall was closed in with steel frames, windows and heavy transite. Transite was used for the outside walls and covering on all parts of the building except for the concrete piers and block fill-in. The large hangar doors were placed in the south end with two large door openings at the west and east sides of the building. Five floors (10,000 square feet of office space and a machine shop) were attached to the west crane piers and three floor levels on the east side also attached to the crane piers to the same overall height. The west side was allocated for offices with each floor consisting of just a large open area without sound proofing or air conditioning. The east side was allocated for storage and work areas and also was comprised of open areas

The new building was 265 feet long, 248 feet wide, 132 feet high at the center and 100 feet high at each end. The center raised section was 107 feet north to south with the north and south section approximately 79 feet. The main test floor area of 42,670 square feet was 251 feet long in the north and south directions and 170 feet wide in the east and west directions with clear heights of 86 feet at each end and 121 feet at the center.

Two cranes were installed with the initial building construction. One was of 150 ton capacity on a span of 84-1/2 feet and traversed the 170 feet east and west directions. It also had a 25 ton auxiliary hook and a 10 ton monorail hook. The second electric bridge crane was on a span of 170 feet with a 75 ton hook and a ten ton monorail hook. The third crane, which was installed at a later date, had a 50 ton

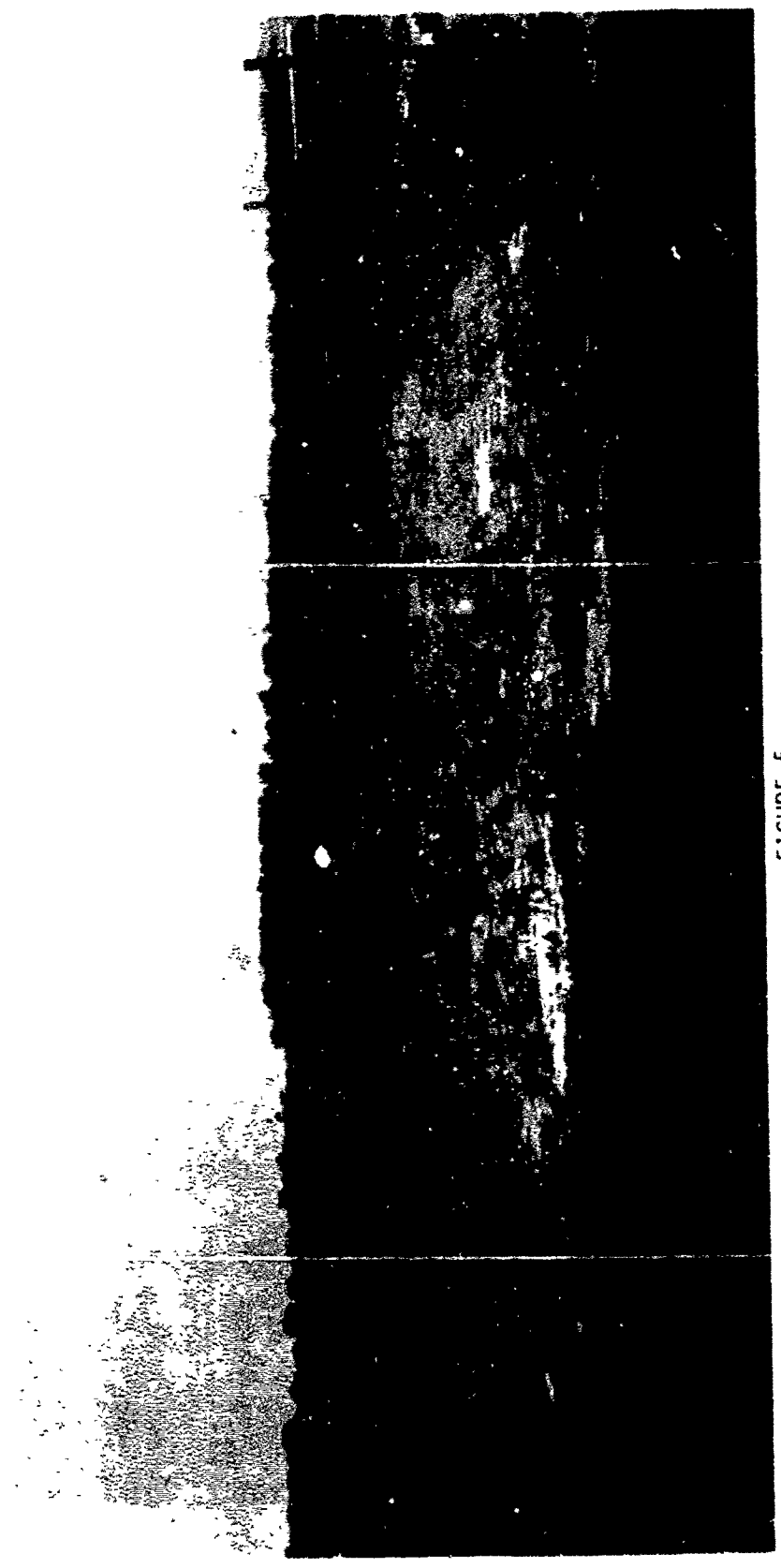

FIGURE 5

The beginning of excavation for Building 65 at Wright Field in August 1943. View is looking southeast toward accelerated runway from the gun range embankment.



FIGURE 6

The unique construction of the west and east crane support rail piers is shown for Building 65 in December 1943. View is looking northwest from near the accelerated runway.

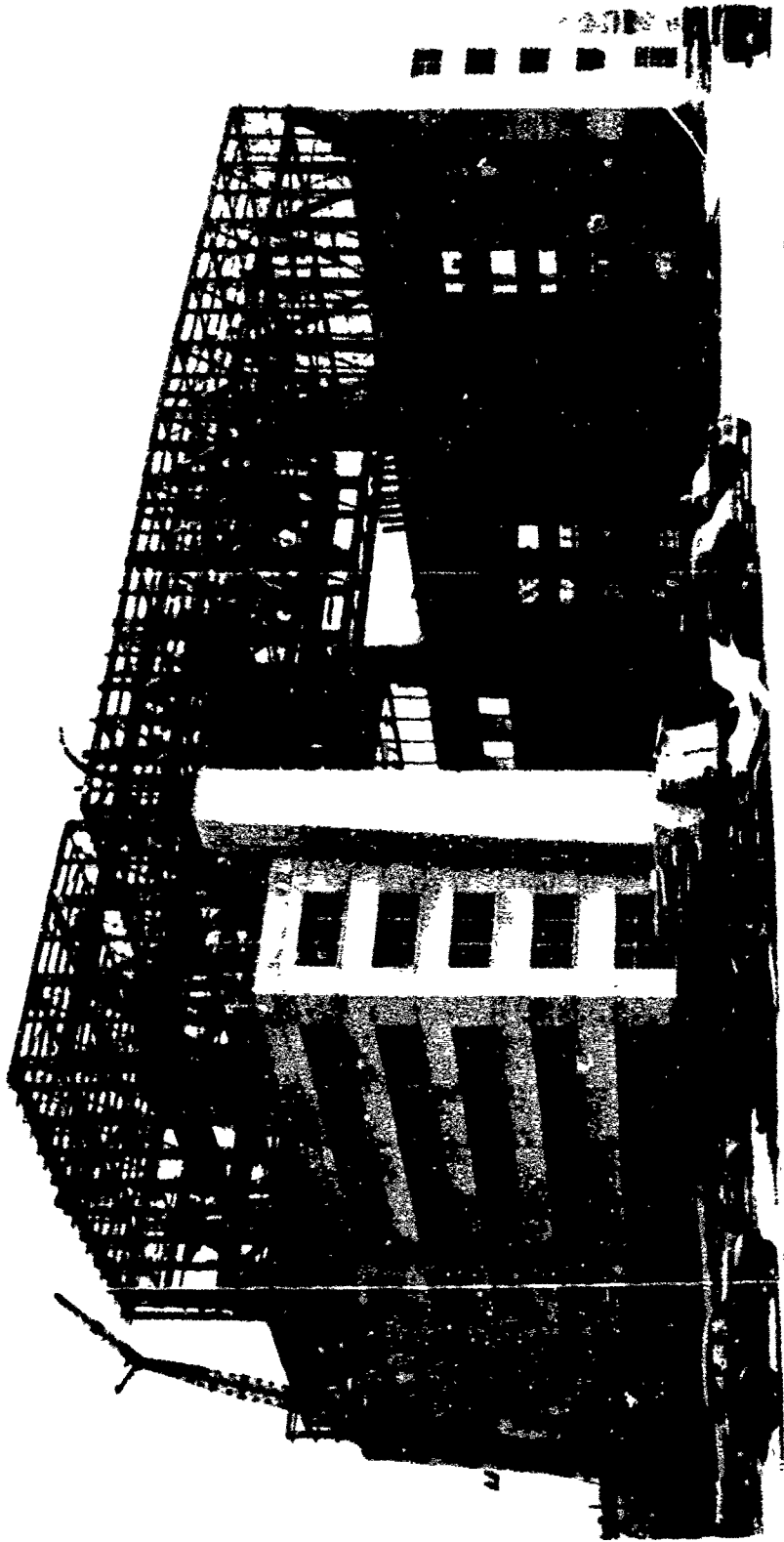

FIGURE 7

Building 65 showing installation of the roof trusses nearing completion in July 1944. The large H frame structure can be seen at the far end of the open test floor area.

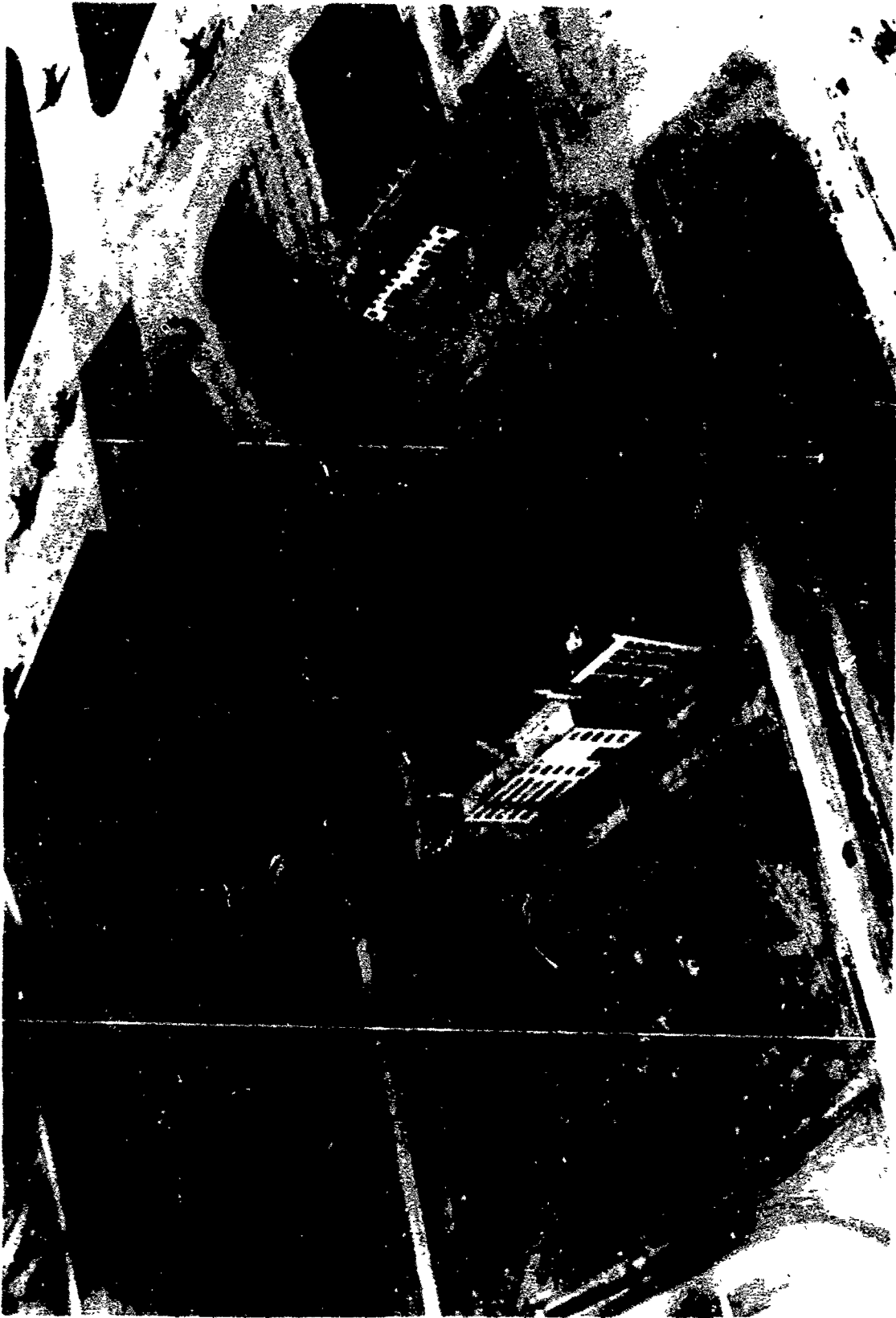

FIGURE 8

An aerial view of Building 65 under construction in June 1944. The center area steel truss structure is being installed. This is a view looking southwest.

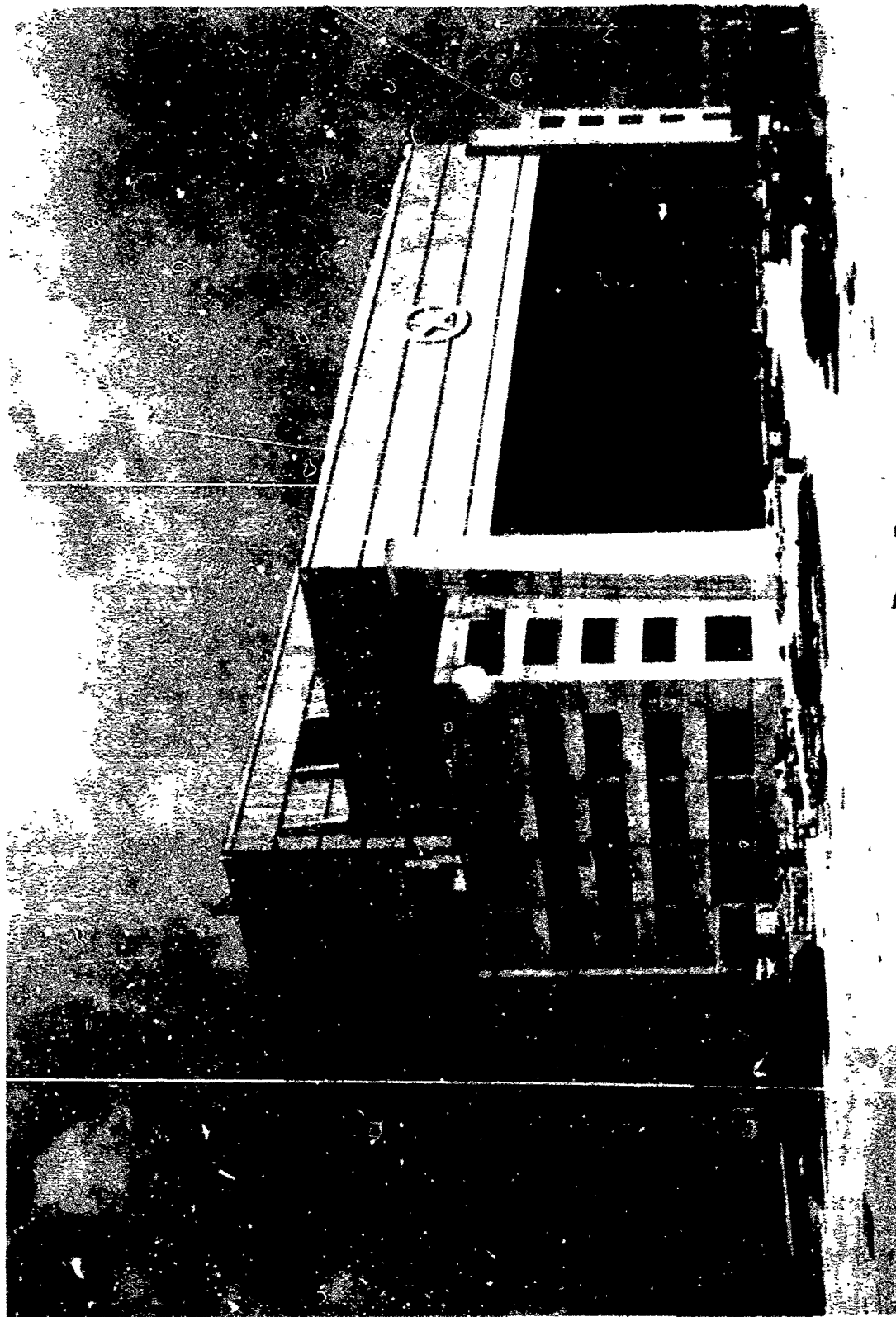

FIGURE 9

Building 65 nearing completion at Wright Field in 1944. View is of the southwest corner.

capacity hook, a 25 ton capacity hook and a 10 ton monorail hook. Vertical clearances under the cranes were 60 feet for the 170 foot spans and 100 feet for the 84-1/2 feet span.

The test floor was a special design of 30 inch thick reinforced concrete. Incorporated in the slab were both individual and track type tie down fittings. The individual fittings were spaced five feet apart the entire length of the floor and ten feet apart across the width. The continuous track type fittings were located between the rows of individual fittings the entire length of the floor. The combination of the two types of fittings provided a complete "five foot on center" modular load network over the entire area. The individual fittings and the track were rated for 10,000 pounds every five feet.

Incorporated within the building on the east side, and accessible to the test area, was a large steel support jig (strongback) 44 feet wide and 50 feet high. It was embedded in rock 37 feet below the floor level and sealed with reinforced concrete. A 12 feet deep pit was provided in front of this jig face to provide additional usable area. The capacity of this jig was 10,500,000 foot pounds (13 frames installed).

Cost of this bare building in 1944 was \$1,412,000 with the two cranes costing \$500,000. It is estimated that when the third crane was added the total cost was \$2,100,000. This building is used today for structures testing, but has undergone several alterations to incorporate individual offices, air conditioning, hydraulic pumphouse, technician work areas, computer rooms, etc.

Access to this test facility was provided from the main landing runways through a taxi strip to a concrete apron, 212 feet wide by 475 feet long, located immediately outside the south end of the building. The large telescoping south doors provided a clear opening into the test area of 170 feet wide and 60 feet high.

It was impossible to static test all of the aircraft being built during World War II in the Wright Field static test facility. Within a decade after 1945 every important Air Force aircraft contractor had its own test facility, financed by the government, to test a specific airplane. Contractors then maintained possession and control of these test facilities for future work.

The early structures specifications, MIL SPEC A 5700 series, required an Air Force test engineer to supervise the static and fatigue test operations at contractor facilities. That test engineer had the authority for structural certification for the Air Force and could impose flight limitations and restrictions to insure safe flight. Engineer shortages did not always permit Air Force test engineering supervision on a full time basis.

With the first jet operational aircraft, the P-80 in 1945, the faster speeds and higher performance resulted in higher leading edge and wing loads and the thicker wing skins required a new approach to testing. There was talk of aircraft breaking the sound barrier, which would further impact the need to develop new test methods.

The Bell X-1 did break the speed of sound in October 1947, and the need to develop new criteria, test facilities and test methods

8888-52-21-01 Original Document

became even more evident. The forecast of very high aerodynamic heating on the airplane skin made it necessary to begin studying methods to simulate it in the test laboratory.

The changes in test requirements resulted in the need for more and different test support services, such as a larger machine shop, sheet metal shop, wood working shop, welding shop, tension patch shop, planning, supply and instrumentation operations which also needed adequate space. Many of these service operations were begun in areas originally designed for storage.

In 1950, 6500 square feet of floor space was allotted for a special enclosure to house test projects which were submitted through the Special Weapons Office and required special security, and another 1000 square feet allotted for Aero Medical Laboratory seat ejection tests. As a consequence of these requirements, the main test floor was being used for too much storage and requests were made for a Military Construction Program to add storage space. The plans were initiated in the late 1940's, but it was not until 1951 that Public Law 564 by the eighty first Congress authorized construction of a static test storage building at an estimated cost of \$181,200. It was finally designed in 1954 by the Corps of Engineers and constructed by the Maxon Construction Company in 1955 at a cost of \$276,407.84, which did not include the electric bridge crane. It joined the main test building on the east end and was 202 feet long, 69 feet wide, with a clear height of 31.5 feet to the bottom of the roof trusses. A ten ton bridge crane with a 21 foot clearance serviced the entire area.

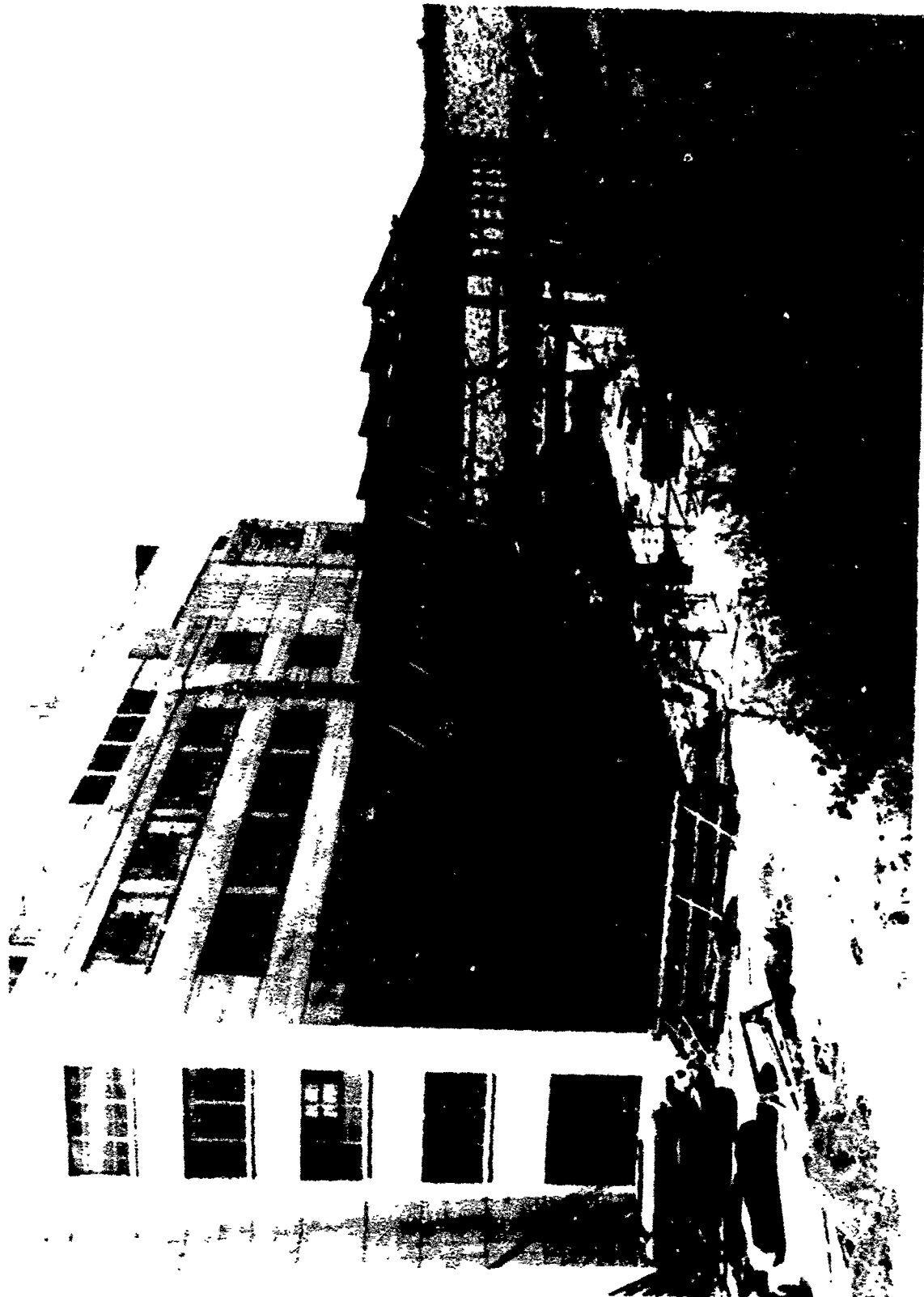

FIGURE 10

Steel erection for the storage building adjoining the east end of Building 65 at Wright Field  
in 1955.

The south end was partitioned off to provide 350 square feet for a sheet metal shop and an adhesives or tension patch shop. A 20 by 20 foot door for a trucking entrance was provided at each end of the building. An automatic sprinkler system was installed.

In October 1952, the Air Research and Development Command directed the Wright Air Development Center to design, construct and place into operation an electrical pilot plant for simulating the aerodynamic heating of flight structures in the test laboratory. The research and development work planned for this facility was to develop design criteria, design, construction and operation of a full scale test facility to test aircraft using radiant, conduction, induction and convection heating methods.

Between 1953 and 1955, the pilot plant electrical equipment was purchased and installed. It consisted of two 6900/480 volt 1500 KVA transformers and associated high and low voltage switchgear, and a spare high voltage circuit breaker for future induction heating equipment which was being researched by the University of Florida. The University of Colorado was doing research on conduction heating by using tension patches with integral heating elements, but no particular research effort was being done on convection heating.

The 3000 KVA pilot plant for research in elevated temperature test methods was located in the north-west corner of Building 65 with a second level metal balcony for equipment. The pilot plant had 40 saturable reactor power control units of 75 KVA each for controlling the electrical heating to the test structures using radiant or

conduction techniques. The aerodynamic heating was simulated (controlled) with a set point position on a Brown recorder or the temperature programmed as a function of time using an analog computer having 40 program channels. The computer, furnished by Research, Inc. on a development contract, operated on only a portion of the aerodynamic heating equation  $Q = hA (T_{aw} - T_s)$  where  $Q$  was the total rate of heat transfer in British Thermal Units per hour,  $h$  the convective heat transfer coefficient,  $T_{aw}$  the adiabatic wall temperature and  $T_s$  the actual skin temperature. An efficiency factor determination for laboratory simulation was part of the research effort. Structural test specimens for heating research were also furnished on contract by Research, Inc.

Every heating element on the market at this time was experimented with in some kind of array (and studied). Various configurations were made by Air Force engineers from nichrome wire until the quartz tubular lamp with tungsten filament was found to be the better method for radiant heating. It was anticipated that the research work on conduction heating pads and induction heating methods would prove fruitful, but some test work had to be done immediately and it was radiant heating that proved itself early for practical use before the research results for the different methods were available.

In 1955, a preliminary planning and design study was awarded to Vitro Engineering Division of Vitro Corporation of America to determine design criteria for the full scale elevated temperature facility. The facility was to be located at the Arnold Engineering Development Center in Tennessee (dedicated in June 1951). The Tennessee Valley

Authority power was supposedly available in large quantities to satisfy the large power requirements for simulating the aerodynamic heating on supersonic and hypersonic aircraft. Arnold Engineering Development Center was a contractor operated facility and some of its engineers were located at Wright Field, Building 65, to learn static testing and to assist in the research into elevated temperature test methods.

Sometime later it was learned that the Dayton Power and Light Company shipped electricity there, and the decision was then made to construct this facility at Wright Field by expanding Building 65 under a Military Construction Program.

The full scale elevated temperature facility was designed for 50,000 KVA (with expansion capability to 100,000 kVA) with additional KVA capability for radio frequency induction heating methods. The radiant heat facility was initially designed for normal environments up to a maximum of 200 BTU/ft<sup>2</sup>/sec. The existing test building, Building 65, was designated for use for both room and elevated temperature testing purposes with all of the power and control equipment, except the primary power substation, housed in a 23,000 square foot, four floor, building addition attached to the north-east corner joining the storage building's north wall. It was constructed of reinforced steel framework, reinforced concrete floors and concrete walls. The heat control computers for controlling the large ignitron regulated power blocks were installed in a control room on the old third floor on the east side of Building 65 which connected to the fourth floor of the new building. This entire construction

effort was handled by the Air Materiel Command, Office of the Installation Engineer, by direction of Hq. USAF. The Vitro Corporation was selected as architectural engineer for design and inspection.

The heat control computer equipment and data system were excluded from the architectural engineer design, and the Aircraft Laboratory at Wright Field was given responsibility to procure this equipment with public works (Military Construction Program) funds.

The Air Materiel Command procured first the electric power substation on open bid, then awarded a construction contract (Phase I) to install 20,000 KVA of radiant heat equipment on the test floor of Building 65. The fabrication of the electrical control equipment was sub-let as designed by the architectural engineer.

Phase II procurement was for an addition to Building 65 for housing the radiant and induction heating equipment.

Phase III procurement was for 10,000 KVA of induction heating equipment. Altogether there were six contracts and each installation contractor subcontracted for equipment as required by the basic contracts.

In spite of the effort undertaken in the pilot plant facility, adequate criteria were not developed in time for the final design of the full scale facility. Rejection of the heat buildup in the test floor volume from the radiant and conduction heating methods was not adequately evaluated. Special ducting and barriers to cool radiant heated test structures during test and afterwards in the design were abandoned after the construction phase had begun. Some were retained and never used for that purpose, including the radiant heat barrier panels, but these were used later for a liquid nitrogen test barrier

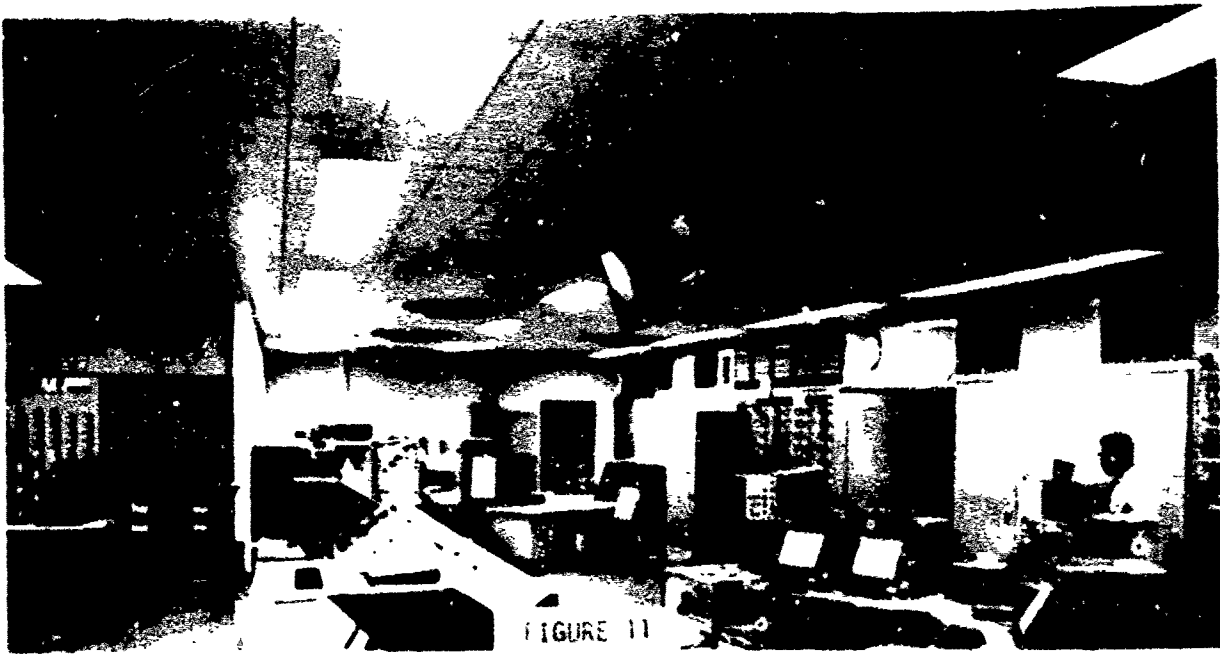
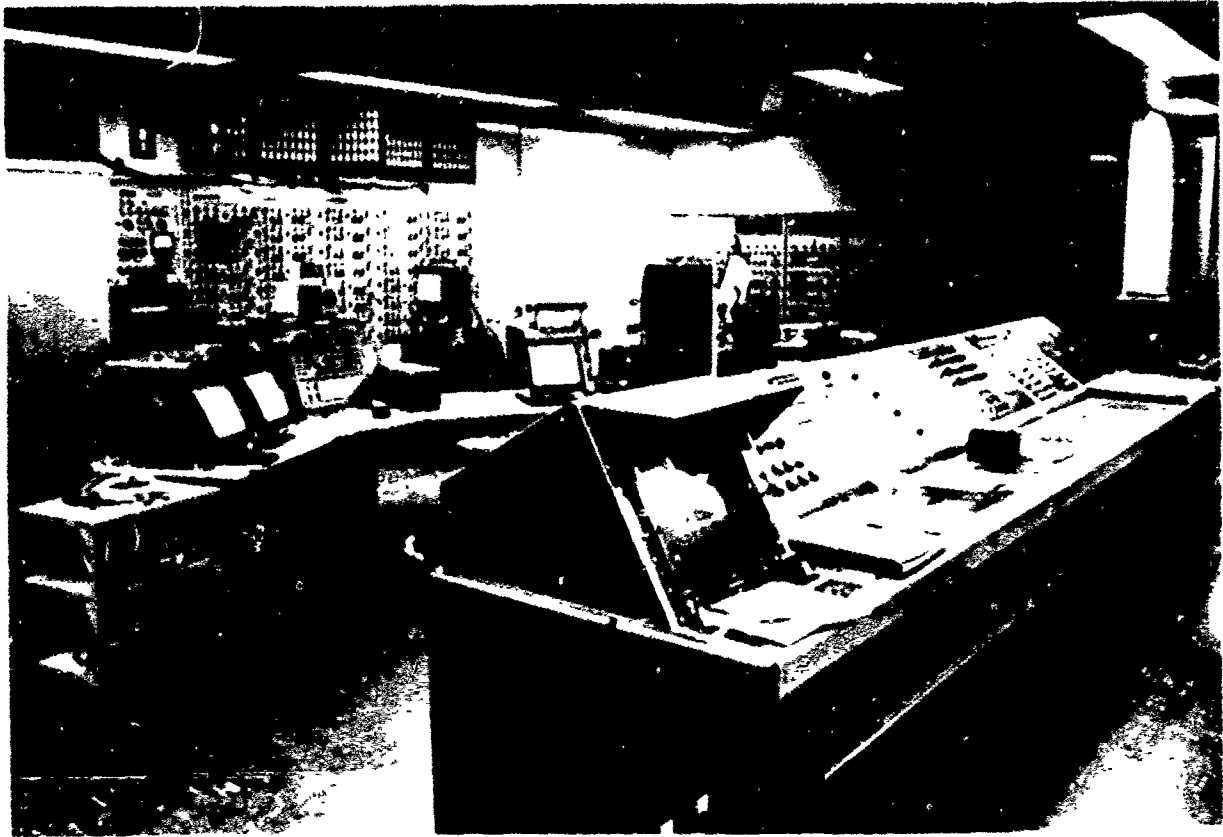

The top picture shows Building 65's control room with Heat Control Computer No. 2 in the left background and Heat Control Computer No. 3 in the right background. The Visicorder instruments are for monitoring control and feedback signals. The bottom picture shows the control room, looking north, which had Heat Control Computer No. 1 in the right center, AN-100-9 Test Set in the middle rear and the ignitron position control switches on the left side. Circa 1965.

of 30 by 60 feet plan area.

The roof and wall cooling fans were installed to remove excess heat from radiant heating of test structures, but the heat buildup in the large open test area never materialized. The ceiling fan openings were a source of heat loss in the winter and had to be blocked. The wind and differential pressure kept the fan covers open most of the time.

The estimated completion date for the full scale elevated temperature radiant heat facility was projected for 1 January 1959. Construction was started 30 July 1958 and completed 29 August 1961 at a cost of \$1,775,567, with an additional \$250,000 in 1959 for Heat Control Computer No. 2. Prior to this, a requirement existed for a pilot plant expansion program for completion 1 January 1957 to meet test commitments. Construction was started 10 June 1957 and completed 25 November 1959 at a cost of \$1,050,000 with an additional cost of \$250,000 for the Heat Control Computer No. 1, and \$175,000 for the controlled load programmer that was added to the Heat Control Computer's digital section in 1962.

The pilot plant expansion was for an interim facility capability. It had 20,000 KVA of electrical power broken down for control into 39-720 KVA ignitron power regulators and a 40 channel hybrid digital and analog heat control computer. No provisions were made to cool the test structure or building air space in this contract. This pilot plant expansion was not completed until 1959, and it was hardly checked out for operation before the final construction contract required that it be relocated. This contract included the balance of

the electrical power, consisting of 40 more ignitron regulators and substations. For some unexplained reason, this equipment was bought from another major electrical manufacturer that was supposed to be equivalent to the first procurement, but was not. There were problems, but these were eventually overcome. It also included an additional 40 channel heat control computer made by the same manufacturer as the first. The only difference was that the Heat Control Computer No. 1 had a load programmer of 40 channels for fatigue testing. A demineralized water system was built as part of this contract to cool the ignitrons of the Radiant Heat System, the work coils and load matching networks of the Radio Frequency (RF) Heating System. The portable heat exchangers provided on the pilot expansion facility were no longer needed and were removed.

The new outdoor substation was for 69,000 volts, three phase, 60 cycles. This substation stepped the power down by a 15/20/25,000 KVA transformer. Power at 6900 volts was brought into the ground floor of the four story addition to 10 unit substations. Nine of the unit substations furnished power to 27 ignitron cubicles on the second floor. Each ignitron cubicle supplied three circuits of single phase controlled power for a total of 81 circuits of single phase power for radiant heating or conduction heating purposes. The maximum power duty cycle was 50,400 KVA for 5 minutes then 30,744 KVA for 30 minutes followed by no load 60 minutes. The continuous duty design cycle was 20,000 KVA, other duty cycles were 38,880 KVA for two hours or 43,740 KVA for thirty minutes. These large power blocks were suited for extreme transient heating conditions where high heat fluxes were required, but steady state or quasi-steady state conditions were better satisfied using a large number of control circuits having low power ratings.

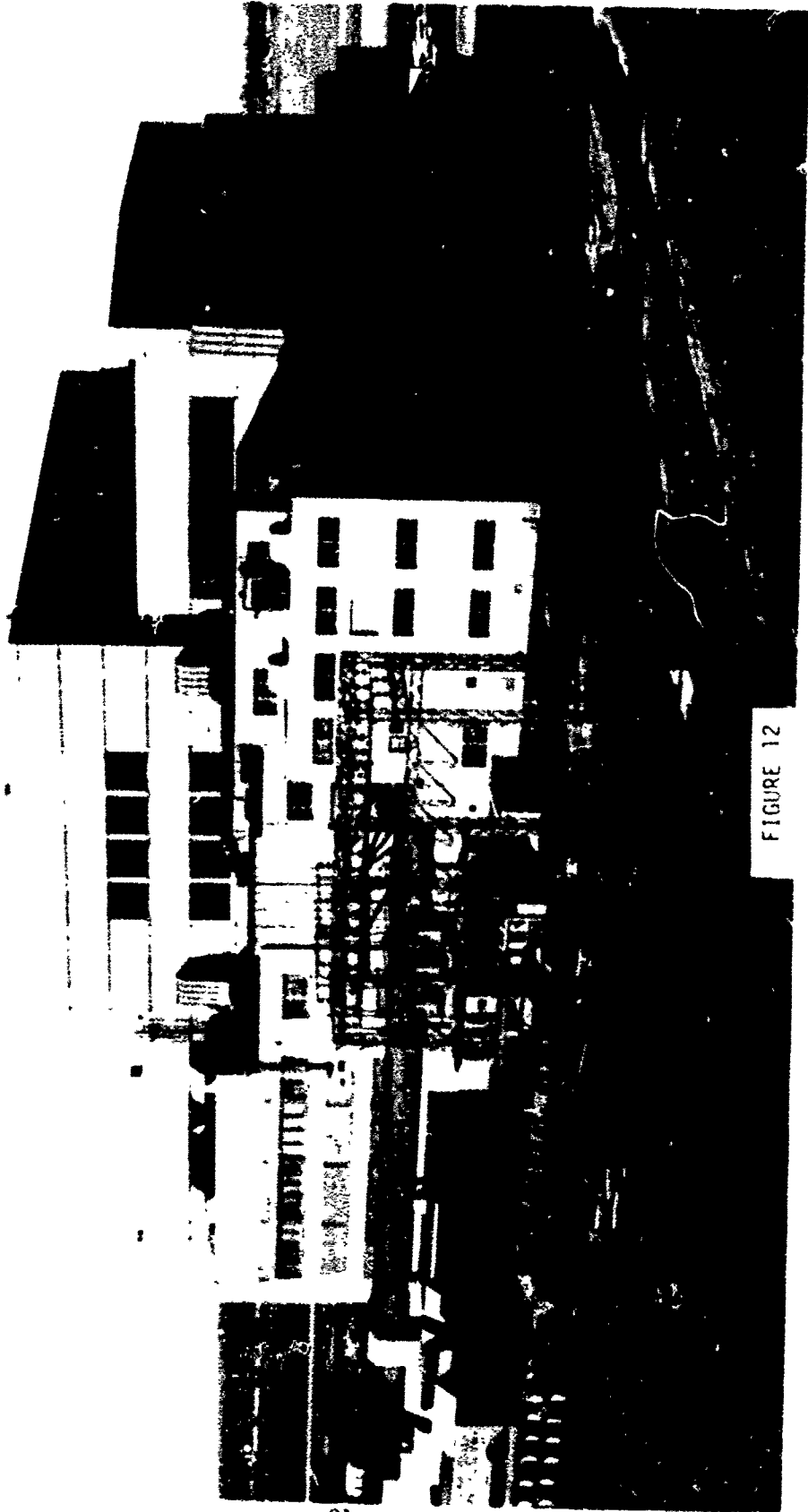

FIGURE 12

Northeast corner of Building 65 at Wright Field showing Substation E for the 50,000 KVA power installed for elevated temperature testing. The elevated temperature building addition is located on the northeast corner, and the demineralized water system and cooling tower buildings are adjacent to the substation.

# RADIANT HEAT TEST FACILITY

BLD. 65 WPAFB, OHIO

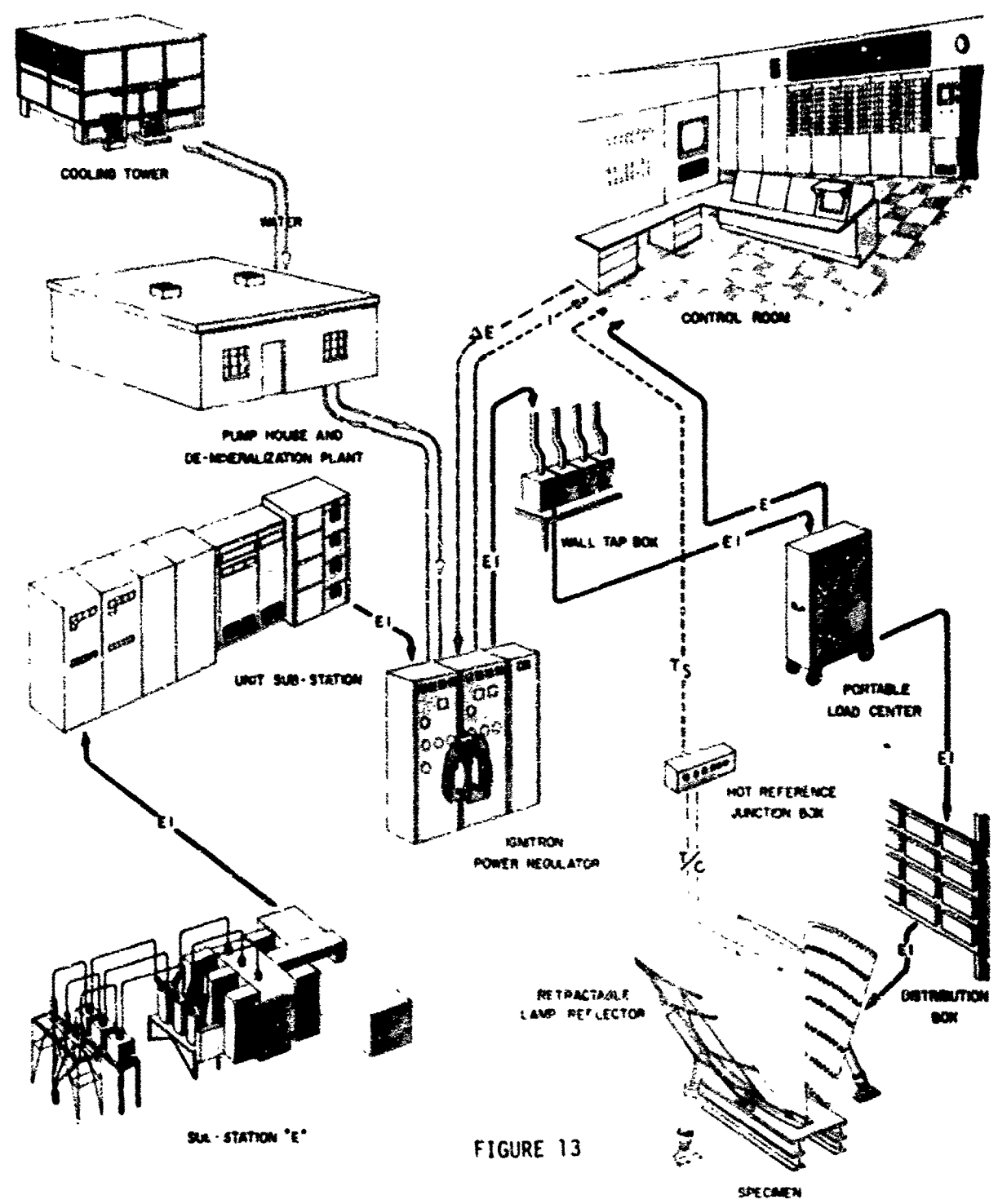

FIGURE 13

The radio frequency facility was designed with eight 2000 KVA mini-plate transformers; 30-350 KVA unit plate transformers; 20-250 KVA radio frequency generators; 30 power loops of 4-1/8 inch diameter coaxial cables; 30 load matching networks; a 30 channel heat rate computer; and a 240 foot perimeter radio frequency shielded modular heat barrier. The system was decreased from the original 40 power loops because of the delays and price increases.

The demineralized water system of 3440 gpm for radio frequency cooling and 600 gpm for radiant cooling was built east of Building 65 in the storage yard. It was built in 1960 at a cost of \$215,000. Several years later a concrete block building was built to protect the three cooling towers from freezing conditions during winter.

Radiant heating techniques advanced to match the required test capability, but the radio frequency induction heating techniques and conduction heating techniques proved to be impractical for aircraft or missile aerodynamic heat simulation in the laboratory.

This resulted in the acceptance testing of only one 250 KVA radio frequency prototype loop in 1964. It was located on the fourth floor along with a modified radio frequency barrier. It was never used and was later dismantled and given to the Materials Laboratory. Even if suitable dielectric material for radio frequency methods had been found, the load matching networks and co-axial cable were too bulky and impractical. The added Heat Control Computer No. 3 was intended for the radio frequency heating system and cost \$375,000 in 1966 and is presently part of the radiant heat system offering test improvements over the other two.

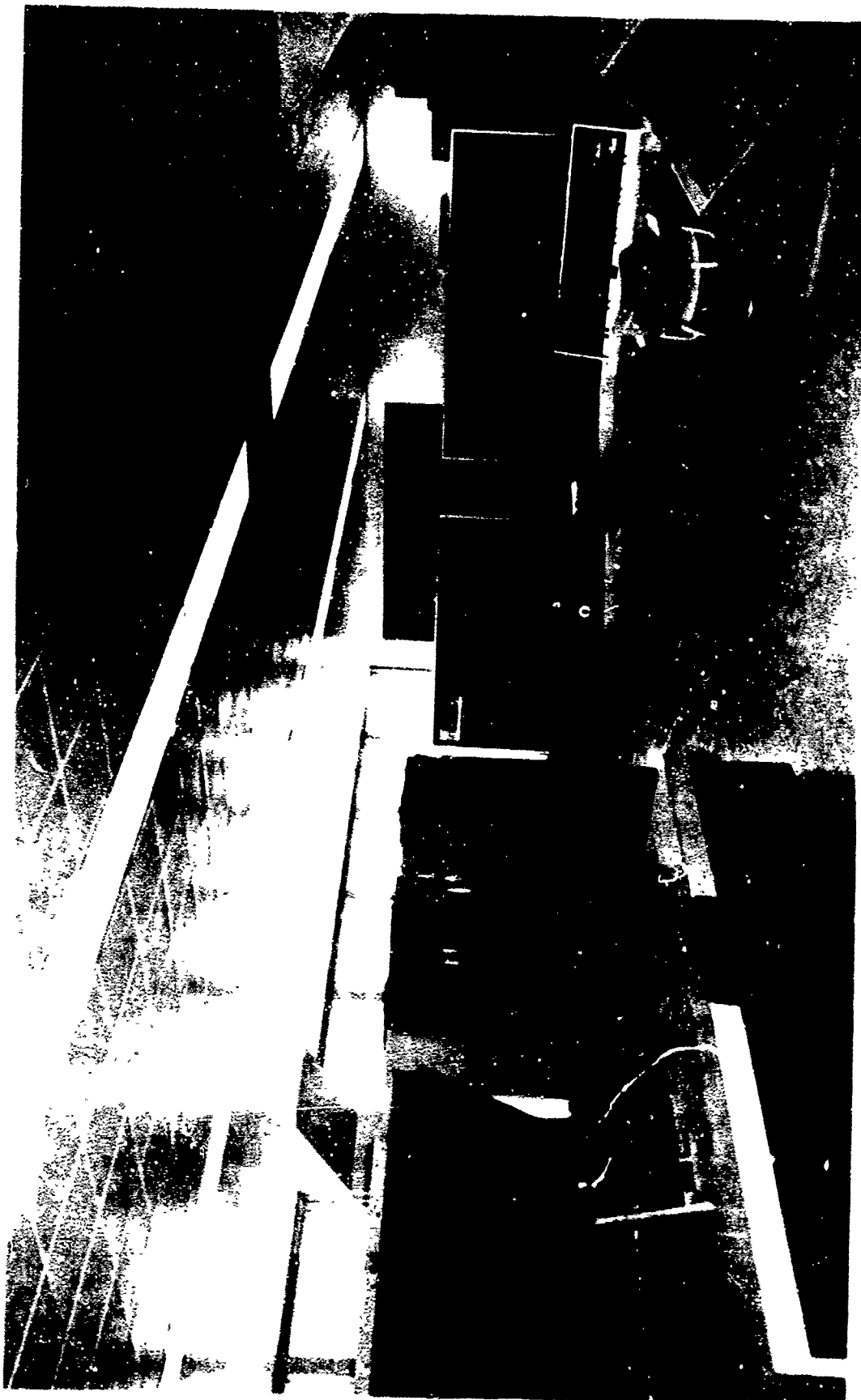

FIGURE 14

Building 65, Wright Field data acquisition Control Data Corporation 1604 computer system room for on line and off line monitoring of strain gauges, deflection transducers and thermocoup 25.

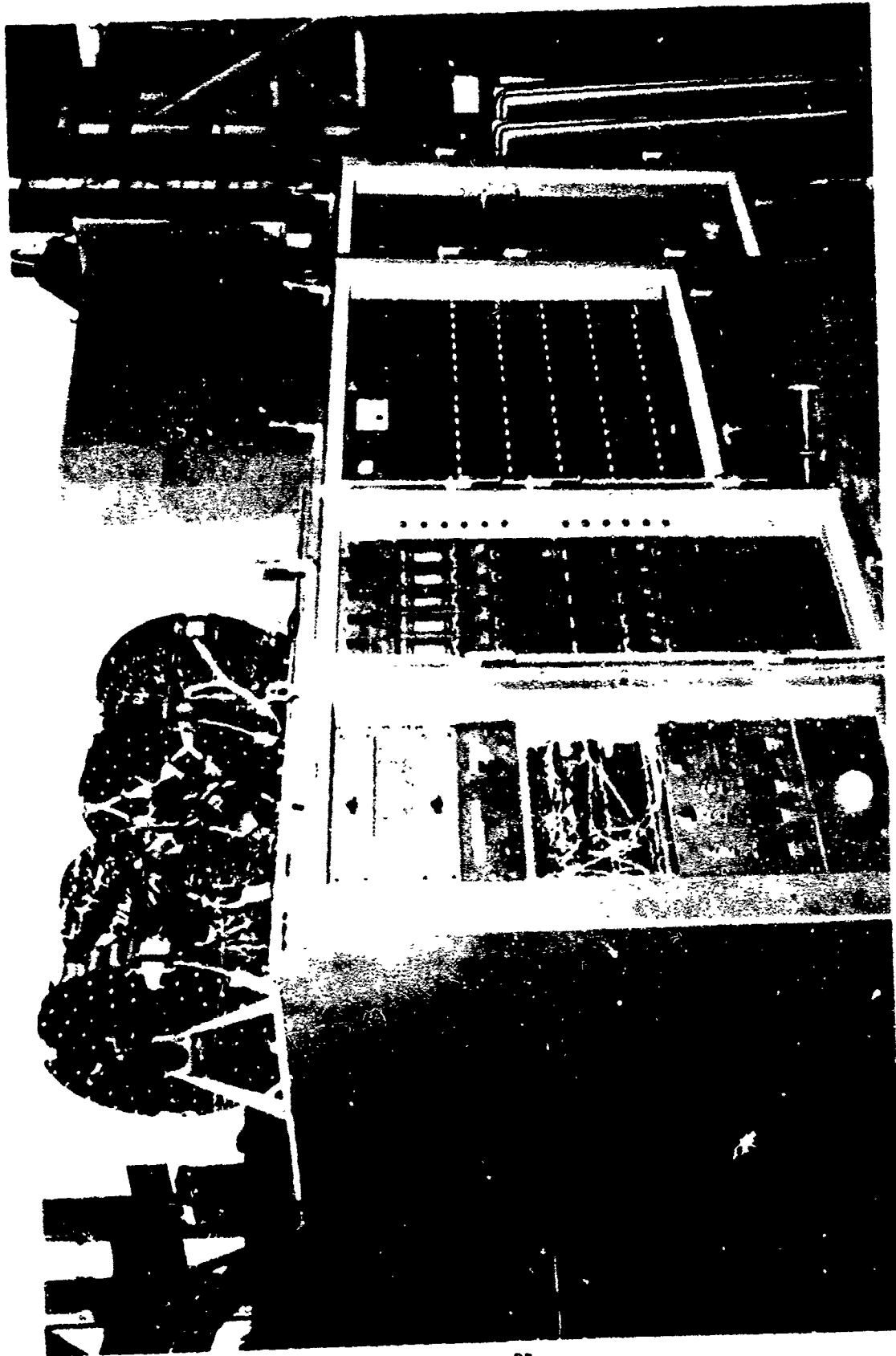

FIGURE 15

The Building 65 data system Transmitter-Multiplexer Unit for instrumentation low level signal handling is shown with computer cover and side panels removed. These units were designed with internal air conditioning and shielding from possible radio frequency waves from using induction heating methods. None of these provisions were used for radiant heating methods. Circa 1962.

As part of this Military Construction Program, money was provided to develop a data collection and handling system for all instrumentation used in static testing which included strain, temperature, load and deflection. The system consisted of a Control Data Corporation 16048 computer, eight portable transmitter/multiplexer (TM) carts for signal conditioning, commutating, digitizing and transmitting signals to the master control room, and the necessary peripheral equipment for data collecting and reproduction in engineering format. It collected data on 632 quarter or half-bridge strain channels, 160 force channels, 160 deflection channels and 976 thermocouple channels. The system was designed for both on line and off line operation. The computer handled 50,000 commands per second while providing visual monitoring and automatic alarming and an on-line prediction alarm. The computer and monitoring system were located on the third floor east of the original part of the building on the south end. The transmitter/multiplexer carts were used on the test floor and could be connected directly to the radiant heat and radio frequency barriers.

The total cost of this complete Military Construction Program effort was \$8,340,091.93 including the radio frequency phase-down and prototype loop. The data system installation cost was \$2,501,078 with additional equipment added that cost \$433,996 and became operational in 1961.

The full scale elevated temperature facility's completion date was too late for testing the B-58 airplane and modifications were made to the 3,000 KVA pilot facility to enable it to be used instead.

The early facility design concept assumed that aerodynamic heating would require high BTU inputs per square foot and the 79/720 KVA ignitrons were expected to handle most situations. These had to be derated to 580 KW for alignment and equipment compatibility, and the heat control computer scaling was changed accordingly, but the low power requirements and large number of required heat channels for the B-58A made the full scale facility impractical for use even if it had been completed and checked out in time.

The research work during the construction phases had shown that the facility design assumptions were partially wrong and it was not possible to simulate aerodynamic heating on large areas with a single power regulator and controller using a single feedback thermocouple. Consequently, it was necessary to purchase a large number of small capacity power regulators and temperature controllers which were procured from Research, Inc. These were controlled by the use of several thermocouples installed in each heat zone connected in parallel for average temperature control. This contract provided 210/60 KW water cooled ignitron regulators and 550/24 KW convective cooled thyratron regulators for power and 760 temperature controllers at a cost of one million dollars.

The reorganization of Aeronautical Systems Division and the Directorate of Engineering Test in 1963 altered the Air Force structures testing emphasis to exploratory and advanced development. This required new test capabilities for hypersonic flight and re-entry type vehicles.

Because of new requirements for elevated temperature and fatigue support, a 1964 Military Construction Program was authorized by Congress

to provide building modifications to existing work space on the three original floors on the east side. The existing floors were 18 feet high and were inefficient. The cost of this effort was \$185,000 for alteration of 10,000 square feet to provide valuable technician work space and instrument storage.

These same requirements resulted in the design study of a liquid nitrogen test system for internal fuel simulation in structures by Cryovac, Inc. in June 1963 at a cost of \$21,000 which was then followed by a facility design in April 1964. Catalytic Construction Co., Philadelphia, Pa. was awarded the design at a cost of \$22,050 and the facility was constructed by Stevens Co., Newport, Ky. for \$482,133.12 in August 1964. Inspection of the construction was done by Catalytic Construction Co. for \$21,000.

This facility was located on the north half of the main test floor and the 10,000 gallon liquid nitrogen dewar was located outside of the north wall by the service road. The inside construction consisted of a barrier 30 by 60 feet, 30 feet high and structurally capable of reacting all loads to a test structure. The liquid nitrogen fill and circulating pump had a 250 gpm capacity and the discharge pump had a 750 gpm capacity. A 10,000 lb/hr vaporizer and superheater (-320 to +450°F) were used for cooling and heating the test tank according to the mission flight requirements. The design provided for manual or automatic control of the process. The barrier had an insulated basin floor of wood with overflow through a trench to an outside dump pit of limestone rocks. Ventilating fans and ducts removed nitrogen vapors to the outside.

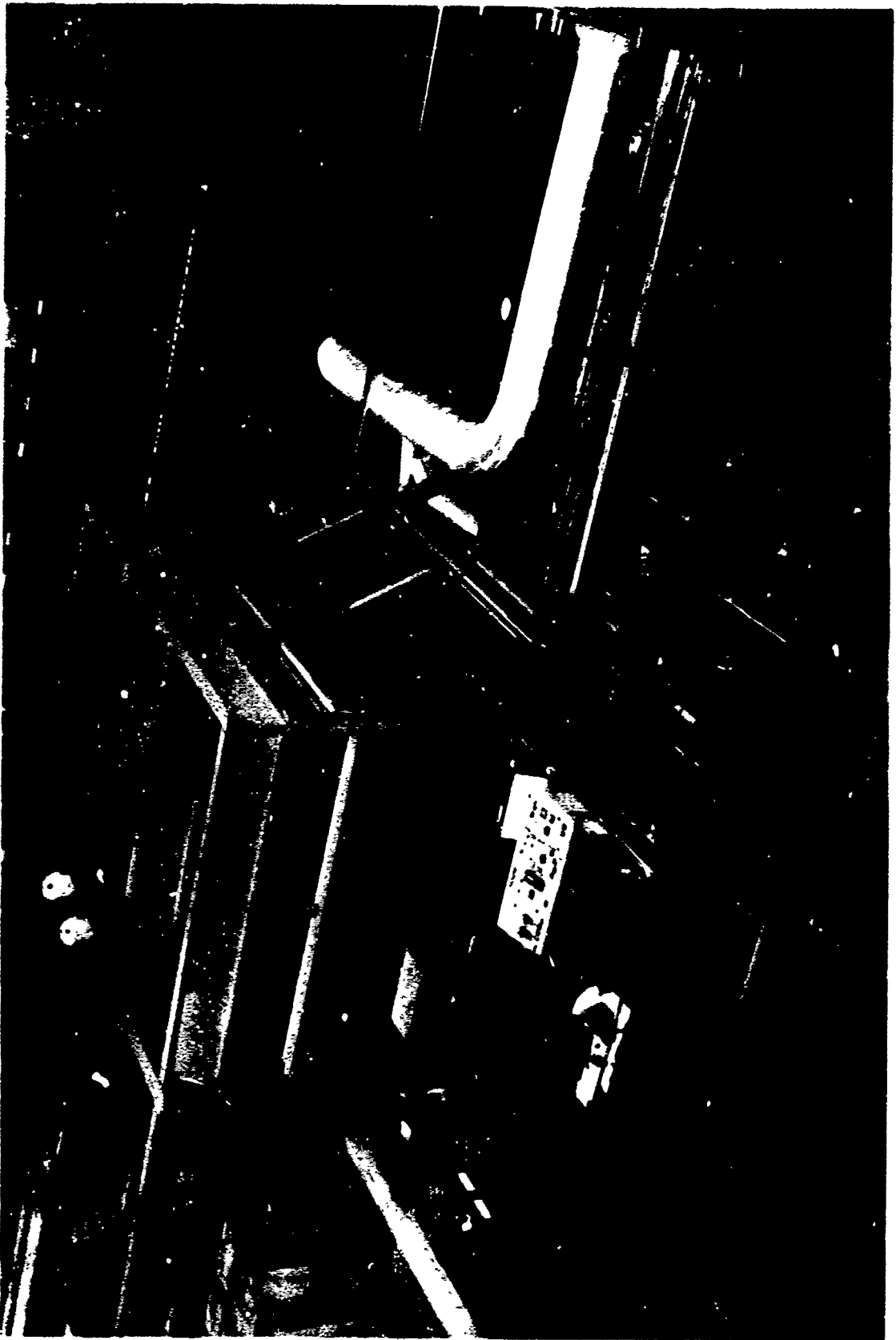

FIGURE 16

The Building 65 liquid nitrogen fuel simulant facility and test barrier located in the north end in the 1960's. The control area is in the left foreground with the vaporizer underneath and the pumping fill, circulating and dump system at the north end.

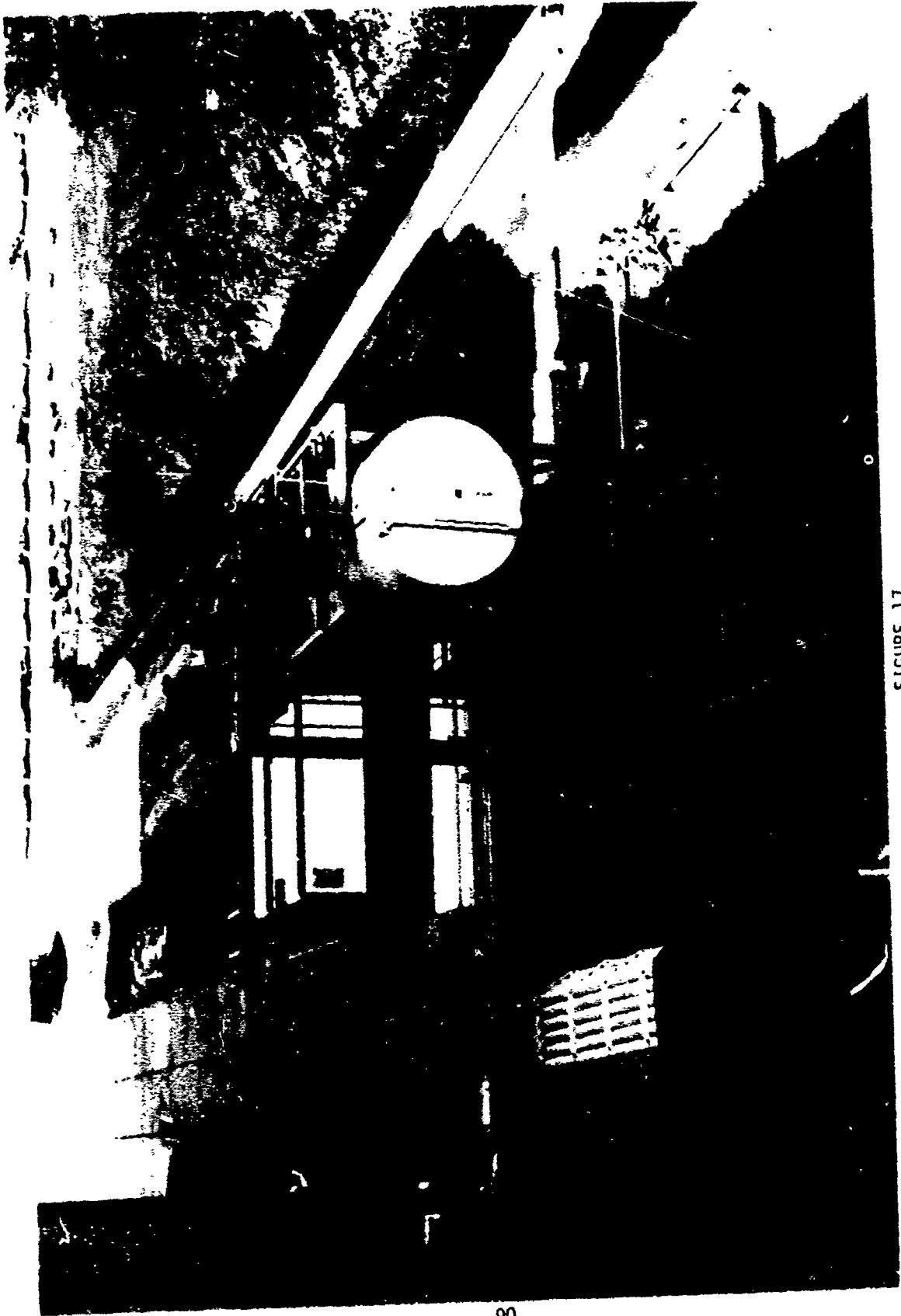

FIGURE 17  
Building 65 outside storage Dewar for liquid nitrogen, liquid carbon dioxide and compressed nitrogen gas used in hypersonic flight vehicle static mission profile testing to simulate internal fuel and for reflector cooling.

Once again, storage of test steel and test equipment became a problem and a request for a Butler type steel outside building 50 by 100 feet was made. It was approved under WPAFB Project No. 450-6 at a cost of \$27,235 and was completed in November 1967.

Increased requirements for fatigue tests resulted in the purchase of four 3000 psi Sprague hydraulic pumps. They were extremely noisy at each test project location and a request was made for the construction of a hydraulic pumphouse on the inside north wall on the main test floor. It was approved locally and constructed in 1967 at a cost of \$24,800. It had 750 square feet on two floors with modular sound proof walls. As part of this construction, a trench was cut in the test floor between the rails the length of the building to provide a hydraulic supply and return line which would be accessible to any test location. Trench covers could be removed at any location to connect to the hydraulic supply and return lines.

With each advancement in the size and speed of airplanes, the Air Force structures test facility was built or modified by the government to support the mission requirements. In 1966, a new facility was needed to test the huge C-5 airplane. A comprehensive Air Force study was made for an Aerospace Structural Test Facility (planned as a government owned national test facility) with siting approval at Palmdale, California, but it was not funded. Instead, the government funded for the construction and equipping of a huge facility for Lockheed Aircraft Co., Marietta, Georgia, to test the static and fatigue C-5 structures.

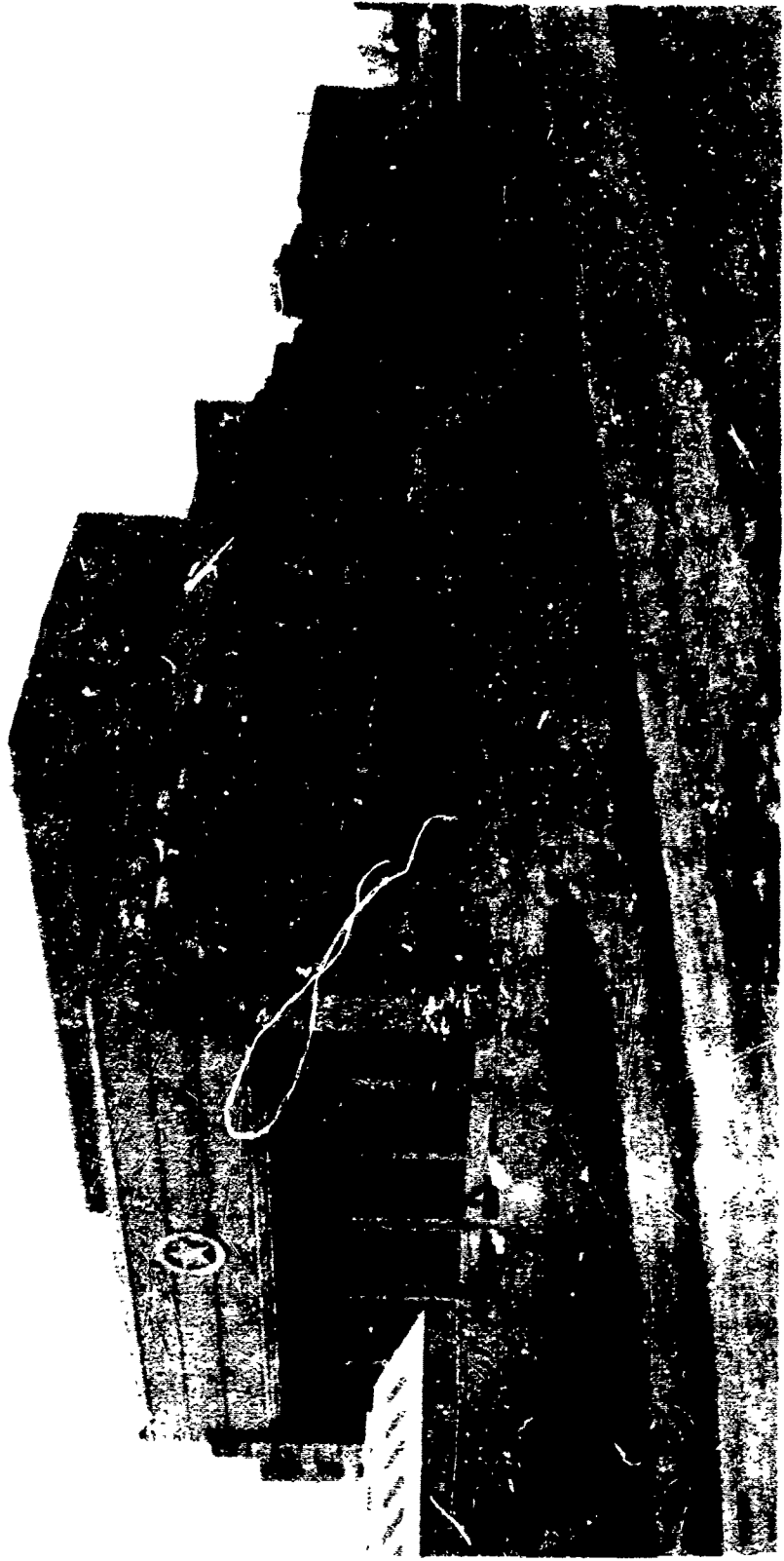

FIGURE 18

Southeast view of Building 65 structures test facility showing the 50 by 100 feet metal storage building on the left and permanent additions to the east side. Circa 1969.

The Air Force's facility design study for siting at Palmdale would have provided for a test floor area of four acres in size. It provided room for both static and fatigue testing of the C-5 simultaneously, and future expansion capability for testing at elevated temperatures with liquid nitrogen and liquid hydrogen fuel simulation. These requirements were tailored after a facility design study for a liquid hydrogen test facility with approved siting in the gun-range adjacent to Building 65 at Wright Field. This design study was made by Catalytic Construction Co., and was in the FY-69 Military Construction Program the first time. It was postponed year by year for several years and finally abandoned. The primary reason was due to the change in mission requirements in supporting the Vietnam war for low and slow type airplanes. This spelled the demise of research and development for hypersonic airplanes and the construction of new ground test facilities.

The proposed (National) Aerospace Structural Test Facility offered a decided cost advantage over the span of several test programs as compared to the C-5 test program facility construction at Lockheed Aircraft Company. Over a 15 year programmed facility life the cost advantage was quantitatively evaluated in excess of the total facility cost of 34 million dollars.

The C-5 had a maximum gross take-off weight of over 700,000 pounds, a 200 foot wing span and a length of 230 feet with a tail height of 63 feet. The supersonic transport was generally comparable, but 40 feet longer, and was to be the first airplane undergoing

elevated temperature testing in the "National Test Facility."  
However, the SST was cancelled.

In line with improved emphasis on research, a modification was made inside the storage building at the east end of Building 65 to house a resonant test machine for rapid cycling on small fatigue coupons and a chemical laboratory. It contained 2500 square feet and was completed in November 1966 at a cost of \$58,310. The roof was designed for light storage and was capable of being serviced by the existing crane.

The Advanced Development Project Office of the Flight Dynamics Laboratory had programs for improved metallic structural designs in the early 1970's. One of these used the B-1 wing carry through box as a baseline structure. It was scheduled for testing in Building 65 and the hydraulic flow requirements for the fatigue test program exceeded that available. A design for a hydraulic pump building was started in 1972 to house hydraulic pumps and a centrifuge with a flow requirement of 870 gpm. The building was 30 by 60 feet and was completed in April 1974. A hydraulic (supply and return) trench was cut into the floor on the east side of the building to supply oil to the Advanced Metallic Air Vehicle Structure (AMAVS) and F-4C/D fatigue tests at a cost of \$25,800. The total cost of the building, trench, 10 dual pump units, accumulators, switch gear and electrical wiring, installation of pumps and pipe and a modified access road cost a total of \$327,627 and was finished in March 1975.

Increased emphasis was given to fracture mechanics requirements on structural test coupons. Equipment was purchased for this work and

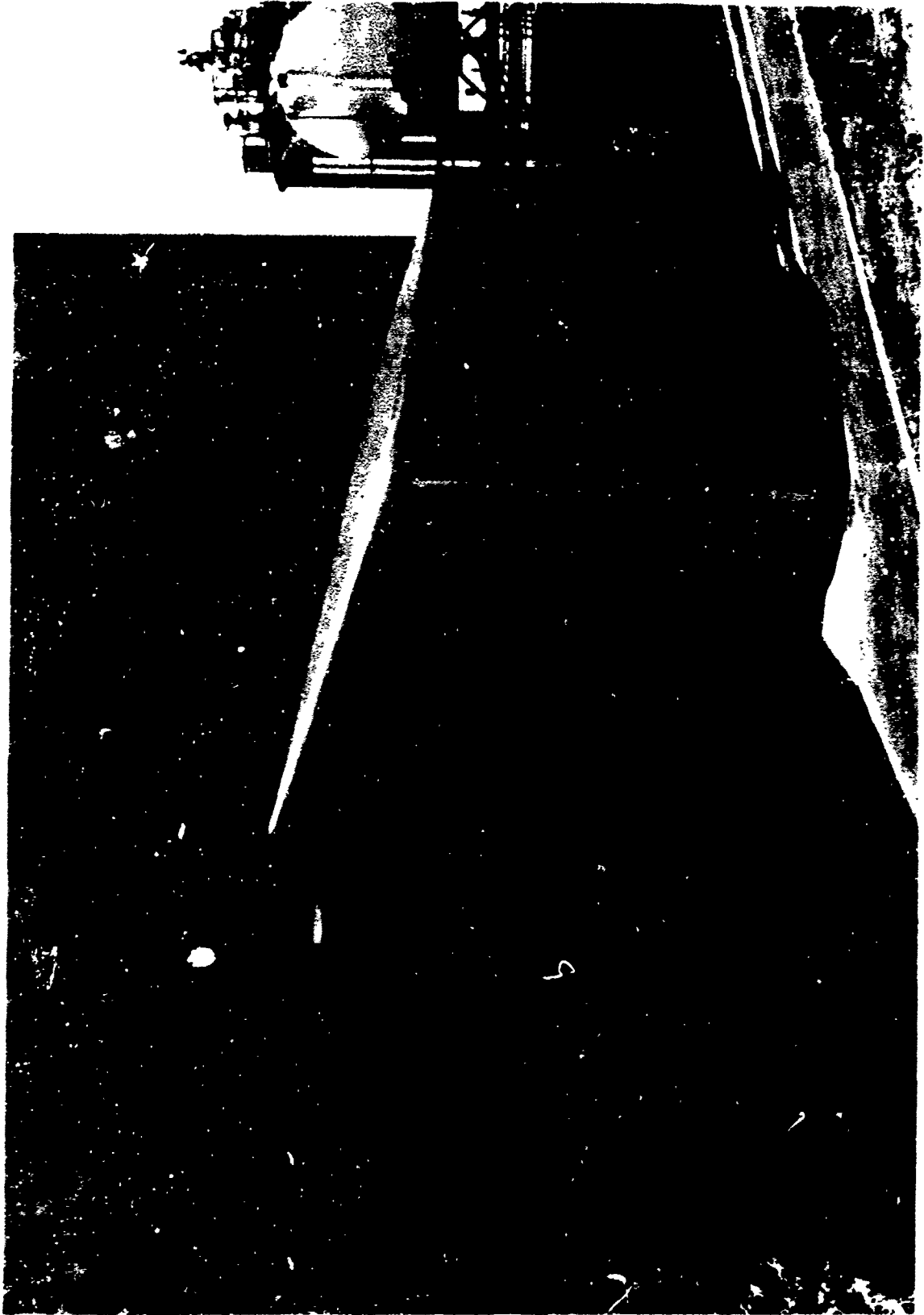

Figure 19

Building 65 hydraulic pump house with a 470 gpm 3000 psi capacity constructed in 1975 to support the Advanced Metallic Air Vehicle Structure and the F-4C/D extended life fatigue tests.

it was located in the northwest quadrant of the main test floor. The need for a clean air conditioned area resulted in modification of the east side of the storage building joining the east side of Building 65 on the south end. The design, 432 square foot hydraulic pump house and the air conditioned 1490 square feet of work area cost a total of \$95,759 and was completed in July 1974. The load frames and electronic equipment in the room cost \$461,571.65. A new addition between that area and the hydraulic pump house is planned for construction in 1979 to house the computer control and programming equipment, at a cost of \$57,600.

Even with the continuous updating of the test facility, it can only do a portion of the test work required by the Air Force. On the other hand, as Air Force need changes year to year, it is impossible to keep all of the contractor test facilities (financed by the government) fully utilized. Although the Navy once had its own facility in Philadelphia for structural testing, it provided its airplane contractors whatever facilities and equipment were required for test programs.

The Wright Field Structures Test Facility has over the years been cost effective to the Air Force, and its outstanding capability has solved many problems quickly at low cost. In 1977 it was still competitive with the contractors who also bid for much of the same work, but in 1979 was forced to utilize its employees differently to remain competitive. This facility has provided most of the advancements in structural test techniques and this knowledge has been

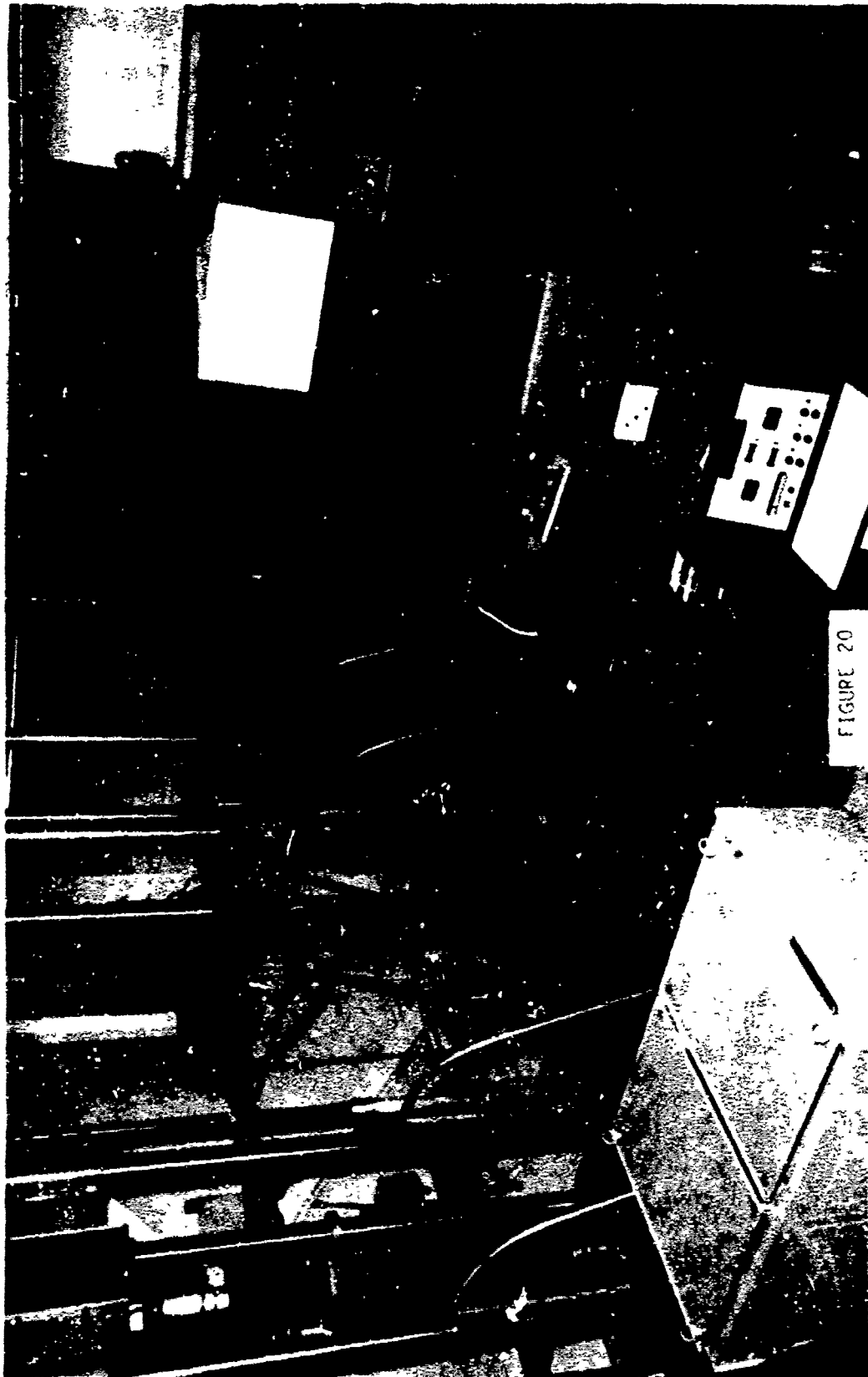

FIGURE 20

Building 65, Wright Field, fatigue and fracture mechanics test facility. It has nine load frames with capacities for fatigue loading from 500,000 pounds down to 5,000 pounds. A variety of mechanical, hydraulic and hydraulic self-aligning grips are available. Four different hydraulic systems are available with flow capacities from 20 to 140 gpm. Support electronics consists of MTS electronic controllers, Bafco controller, Digital Equipment Corporation PDP-11/34 minicomputer and a LSI-11 microprocessor, Motorola 6800 microprocessor and III 4901 Digital Simulators. Each test system has total system safety to prevent overloads or inadvertent failures of test specimens.

used by many governments and industry to establish test facilities and programs of their own. The latest ones are in South Korea and Taiwan.

## SECTION VII STATIC TESTING

Birds, wind and sand helped man solve many of the problems of gliding and mechanical flight. Sand, a seemingly unimportant substance, made important contributions. It was used to static test glider and airplane structures. When it was first used for this purpose is anybody's guess.

Sand was used by Otto Lilienthal in his study of bird flight in the late 1800's. He inverted the wing of a fresh killed bird and distributed sand over its entire surface to measure and study its deflection when loaded to simulate the bird in flight. It is probable that he continued this practice to prove the strength of his gliders.

Samuel Langley made extensive use of sand to test and evaluate the strength of his aerodrome models and man carrying aerodrome. An example of his trial and error progress is indicated when in 1896 the inverted wings of Model No. 5 yielded tip deflections of less than five degrees. Earlier tests in 1894 of that model yielded 65 degrees in tip torsional deflection from the sand tests. Langley's method of wing design and guy wire restraint left much to be desired even after the wings were considered satisfactory from sand tests.

The sand at Kittyhawk, North Carolina deserves more credit for helping the Wright brothers succeed than has heretofore been given. It served them in more ways than just static testing material, but that particular fact has been glossed over or never mentioned by historians.

Static testing was the first, but not the only task used in determining the strength of an airplane structure for flight and ground handling operations. Very early in aviation, it became necessary to develop a strict safety and health program for aviators in order to help save lives and conserve valuable resources. In spite of the enormous amount of technology which has since been applied to this overall problem starting about 1900, some fatal crashes still do occur in both old and new aircraft due to structural deficiencies.

Static testing is not 100 percent reliable, but there is no known substitute. Many of these past accidents resulted from inadequate static testing, or lack of static testing. Static testing discloses errors which when not corrected may cause catastrophic flight failures.

Proof of minimum satisfactory weight and the determination of an airplane's operational strength are also important products of testing. If an airplane is too heavy, its payload is too small; however, if it is too light, the payload may be much greater, but it will not hold together under all operating conditions. Structural designers try to provide an efficient structural design for given mission requirements which represent requirements for ultimate flight safety.

A reliability factor of 0.9999 might represent safe flight for the airplane, but many technologies are needed to satisfy it and nobody could ever be sure of such an actual reliability value. The best

approach strives for 100 percent reliability from a thorough test program of which static testing is only one of several proofs. Efforts to make design analysis adequate proof for the airplane structure using small safety factors, and unproven assumptions, are never successful in achieving the necessary reliability factor for a low risk airplane. There have been incidents where Air Force pilots refused to fly high risk airplanes.

The first static tests of the Wright Flyer were done in 1903 by the Wrights while waiting for the weather to clear for the first attempt to fly with a motor. They accomplished the test by suspending the plane by its wing tips and loading the wing with five to six times their own body weight in the center. This test dictated a change in trussing of the tips so the strain was more evenly distributed between the front and rear spars. It also required a change in the controlling wires. After this was completed, they hung the airplane by the tips and ran the motor while a man was in position at the controls.

Their 1904 static tests were done with the machine supported upside down on trestles placed at the center, and the wings then loaded with sand from wing tip to wing tip. The sand was distributed such that the net chordwise load would occur at the proper center of pressure.

In 1907, the Army became curious about static testing of the Wright airplane and corresponded with the Wright brothers, but there is no evidence that the Army did any testing or required more than was

done by the manufacturers until later. The primary reason was that the Army had so few airplanes that it was not a problem.

Orville Wright was in France in 1911 and wrote about the French officer's fear of flying some of the airplanes because of structural weaknesses and lack of control response. In order to learn their strength, the French turned the airplanes upside down and piled sand on the wings until failure occurred. The Wright airplane withstood four times its flying weight, the Farman two and three-quarter times, the Antoinette one and one-half times, and the Bleriot one and one-quarter times. These tests indicated that the pilot's fears were justified, except for the Wright airplane. This was their favorite airplane because of its handling characteristics and safety of flight at that time.

The Wrights tested their Model C supported by trestles at the last uprights of the wings with a total load, including the weight of the machine, of 1960 pounds to check the spars and uprights (vertical members) against bowing. For this test, the outer uprights carried a load which produced over ten times the normal flight strain. The wing spars of the last section withstood a strain over five times that experienced in flight. This test loaded the center section to only one and one-quarter times that load which was carried in government tests. Also, the center section supports were placed under the uprights where the wings were attached and loaded until the uprights, spars or a wire showed indications of giving. Such testing subjected the uprights to double the strain as when carrying the same load in flight.

The Wrights explained to the Army that this kind of testing did not simulate flight loading. They stated that to do so, the machine should be supported upside down on trestles at the center and loaded with sand of uniform weight from tip to tip. The sand was required to be distributed fore and aft of the surfaces such that its center of gravity would coincide with the center pressure for different rates of speed. They said that when it flew at high speeds the rear spars carried a greater load, and at lower speeds the front and rear spars had a more equal distribution. The Wrights offered charts they had developed for different speeds for the purpose of distributing the sand. They suggested that the Army could test each structural member separately, and compare the test results with the analysis.

It is doubtful that the Army used this information, for it appears that they continued to rely on flight testing until McCook Field was placed in operation.

Army static testing began at McCook Field shortly after it was built. The first airplane built there specifically for static tests was the all metal CO-2. Sand testing, as it was called, credited McCook Field with making an important contribution to proving airplane strength.

The structure being sand tested at McCook Field was securely supported upon scaffolding and the sand bags of known weight were placed on the areas such as wing, tail, fuselage, etc. This made it possible to reproduce the stresses and strains of normal (and abnormal) flight, and to expose and correct structural weaknesses. It was



FIGURE 21

Static test of German Fokker D-VII after World War I at McConk Field using the sand bag test method.



FIGURE 22

Albree-Fraser U.S. Army Scout airplane manufactured by Pigeon Hollow Spar Airplane Co., East Boston, Mass, undergoing static test at McCook Field. Delivered to the Army in September 1917. Single engine Scouts were the fighters after 1915 and were armed with a gun for combat. The 1917 concept of a fighter, "An ideal machine for tactical reconnaissance...." resulted in the Army Signal Corps allotting Serial No.'s 116 & 117 to the design of George Albree. Serial No. 116 was still in existence in 1961.



FIGURE 23

The Albee-Fraser Scout undergoing static test on the horizontal tail section at McCook Field circa 1917. The fabric has been removed to the hinge point of the moveable tail-fuselage section to see the load effects. Note floor of the static test building appears to be dirt. This testing was based on Serial Report No. 105, Specifications for Procedure in Sand Testing by Army Materiel Division.



FIGURE 24

The Albee-Fraser Scout monoplane was rejected after test at McCook Field. The fuselage-wing failure pictured for Serial No. 117 is probably the reason.

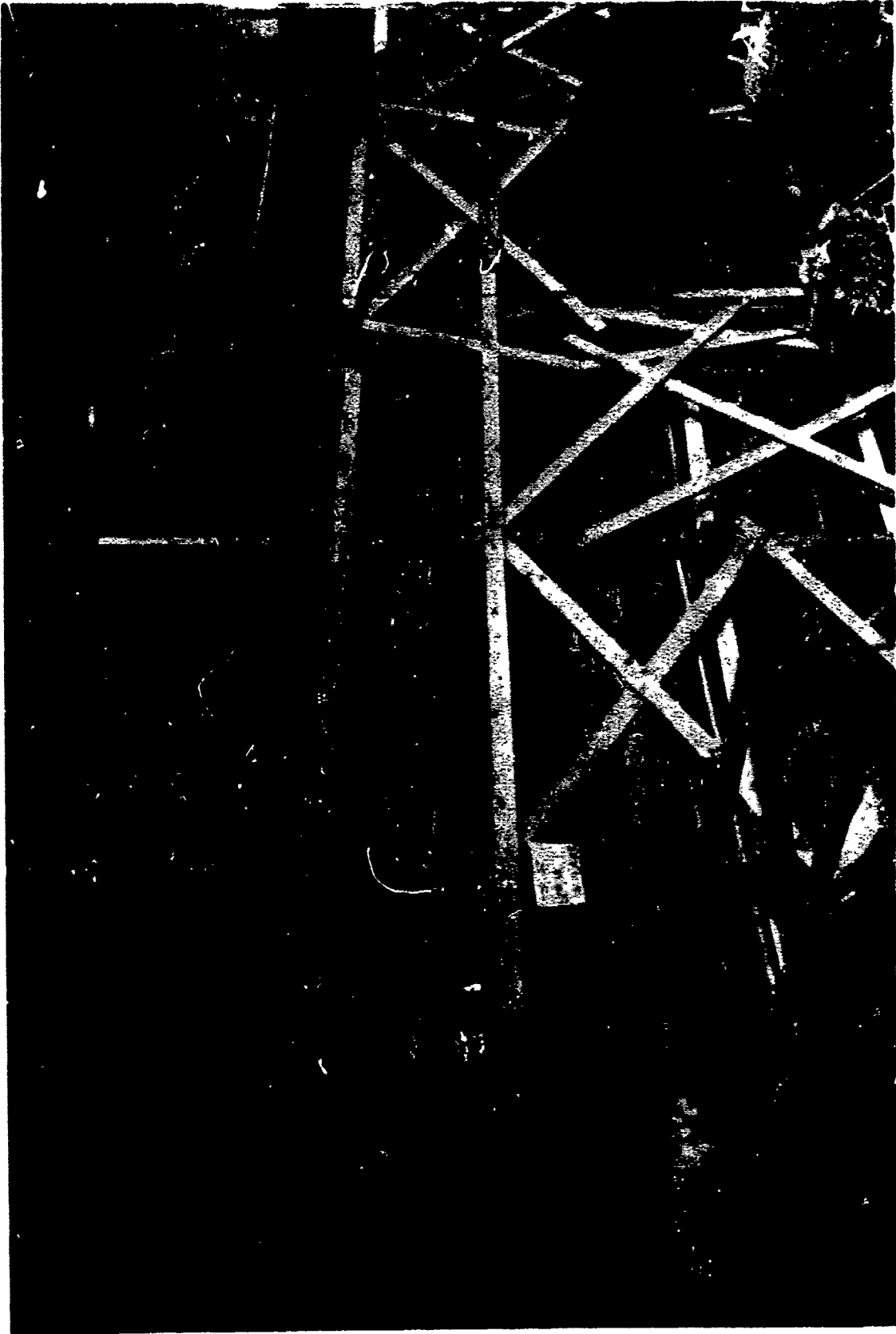

FIGURE 25

Static test setup of USAO-11 Lepere triplane at McCook Field in October 1919. Sand bags are distributed according to estimated loading on wings.

possible for a sand load to simulate both lift and drag on the wing. The wings were loaded at such an angle that a lift to drag ratio of four to one was produced. The fuselage was supported in such a manner as to give the wing the desired angle. Prior to the tests, sand bags were laid out on the floor around the test structure in a well defined order to facilitate application of the load increments. The wings were marked off in sections for the designated load distributions.

Sand bags were made from heavy canvas and sewed with pillow-like dividers in five, ten and twenty-five pound weights. This prevented the sand from shifting and made for easier handling and stacking. Lead bars weighing 50 pounds were used in the early twenties for platform and basket types of local concentrated loadings. Loads were hung on cables where clevis fittings were used to attach the cables to the structure. Dynamometers and turnbuckles were used as another concentrated loading method. Formers (clamps) were used to support flexible structures while the incremental loads were being applied according to the spanwise and chordwise requirements. Once that load increment was in place, the structure was then loaded for the next increment with as many bags as needed to produce the test load by lowering the mechanical jacks until just free of the surface. Necessary measurements were taken and that process continued until the design load was reached or failure occurred. The first such jacks used were the railroad ratchet type, then screw jacks with extension handles and finally hydraulic jacks. The Materiel Division at Wright Field built special three and one-half ton screw jacks (with extension handles) at a cost of 55 dollars each which was probably more than

they would have cost commercially, but suitable jacks were not available in the desired extension and load capacity.

Testing was slow and laborious. The ten pound (7 x 21 inch) shot bags to improve loading density were developed after a long period of testing with sand bags. They were laid out in increments around the test structure for specific conditions for ease and relative speed in putting them on the structure the same as before, but the bulk was considerably reduced. It required the use of skilled laborers to throw the shot bags to heights as much as 25 feet or more. Usually the shot bags were thrown in relays for the high positions. Some of the men could throw them much higher than this in a single throw and prided themselves in being able to do so with consistent accuracy.

The first use of adhesively bonded tension load pads was in 1938 for an airplane wing test at Wright Field. Static test engineers glued canvas patches, developed in 1933, to the test structures and found these to be unsatisfactory. Apparently, this led to the invention of the sponge rubber tension pads which had a metal backing plate to connect into a whiffletree (linkage evener) system for loading with a hydraulic jack. Hydraulic loading methods had begun being used in the early 1940's mostly in conjunction with shot bags.

A comparison of the effectiveness between cushion loading pads and tension loading pads was made on the BC-1 (AT-6). With the advent of the cushion loading pads (compression), it was possible to provide a better wing load simulation. Large built-up beams were made which

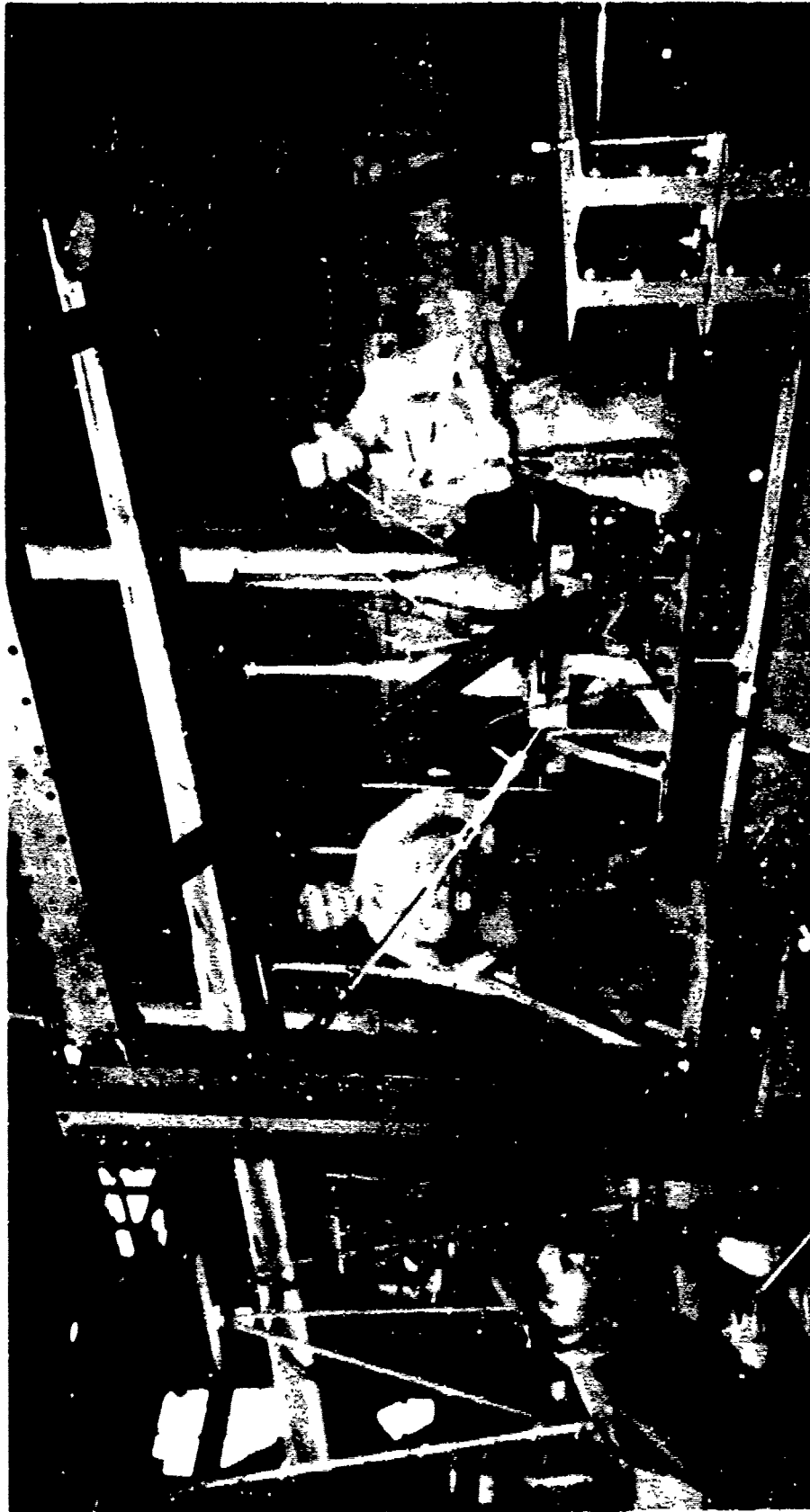

FIGURE 26

The first hydraulic load method used at Wright Field in Building 28, circa 1943 when the test operations used all military personnel. The load equipment shown was made from an aircraft hand pump, a gallon hydraulic can, a pressure gage, hand valves and tubing. The small size airplane strut is connected in tension to a cable under test.

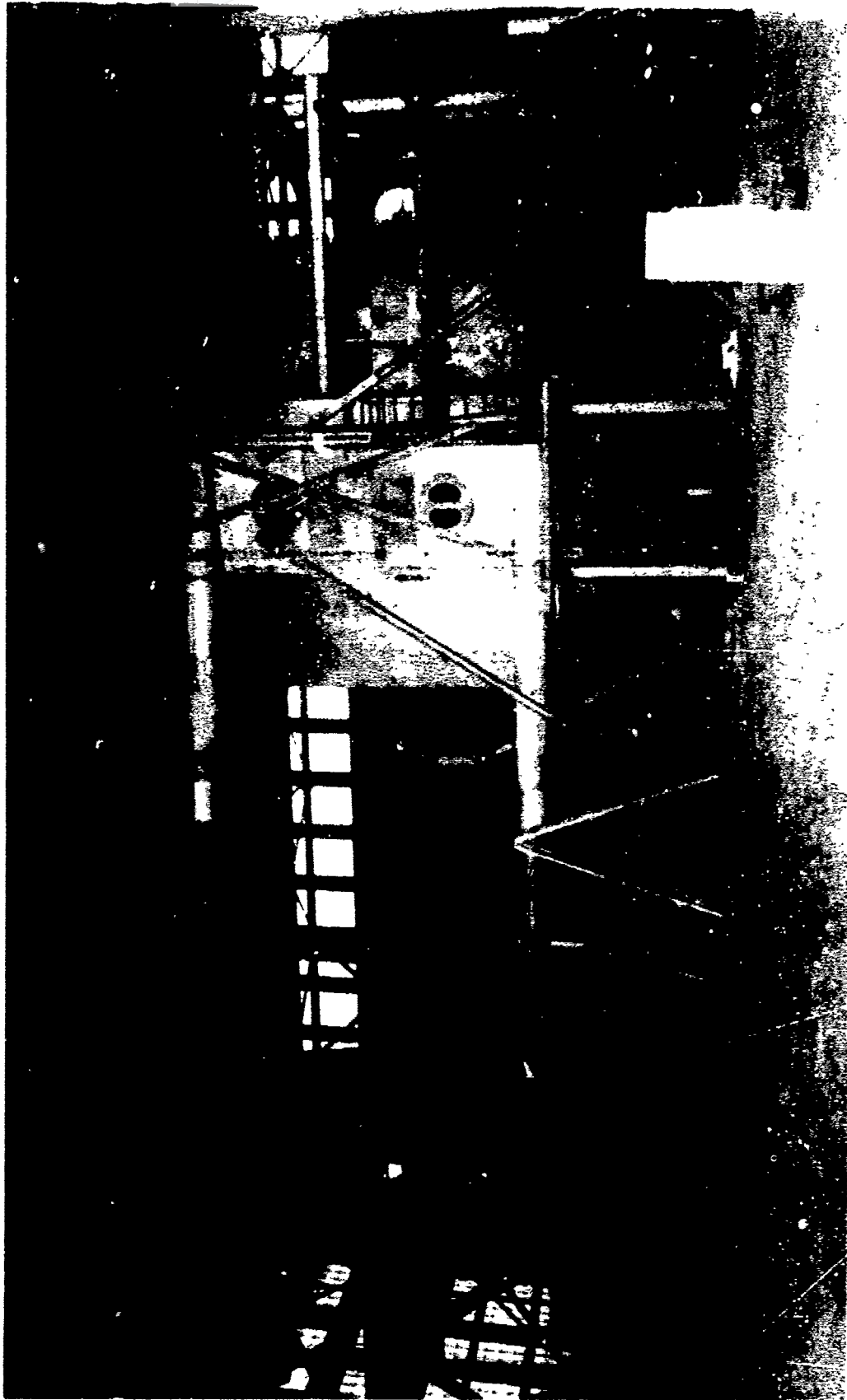

FIGURE 27

General Airborne Transport Company XCG-16A flying wing 40 troop and cargo glider. All wood construction. Glider shown under static test in Building 28 at Wright Field in 1944. Outer wings and single vertical tail have been removed. Not listed in the Appendix on test programs.

spanned the wing chord and the wing was loaded in compression. Later, this was combined with tension pads (patches) to provide better airload distribution using whiffletree linkage made from flat bar steel. Some steel linkage, from one airplane to the next, could be recut, redrilled, and reused, but a lot was scrapped with the resulting loss of a large number of manhours and material. The tension patches were loaded with hydraulic load jacks (also called struts and cylinders), one to each whiffletree arrangement. The hydraulic load jacks used were originally salvaged from the landing gear and flap systems of outdated airplanes. Most airplanes at this time were still being tested using sand bags, shot bags, and pig lead bars and were inverted for positive loading conditions.

The tension patch loading, in combination with shot bags, made testing more accurate and provided better load distribution. Part of the need for shot bag loading for the 20-40 percent load increments was due to the thin wing skins and limits of the skin to rib and spar attachments. Sometimes local surface damage was caused by the test methods when too much load was applied in tension.

As the test engineer's experience built up, they improved the tension patch-hydraulic loading system and advanced from the old aircraft hand wobble hydraulic loading pump methods to electric (DC) hydraulic pumps again salvaged from aircraft hydraulic systems for use with hand controlled loading valves. The test mechanic was then able to monitor pressure gages for applying the incremental loads simultaneously to all parts of the structure under test. No longer was it necessary to have a large crew on screw type jacks, or hydraulic hand

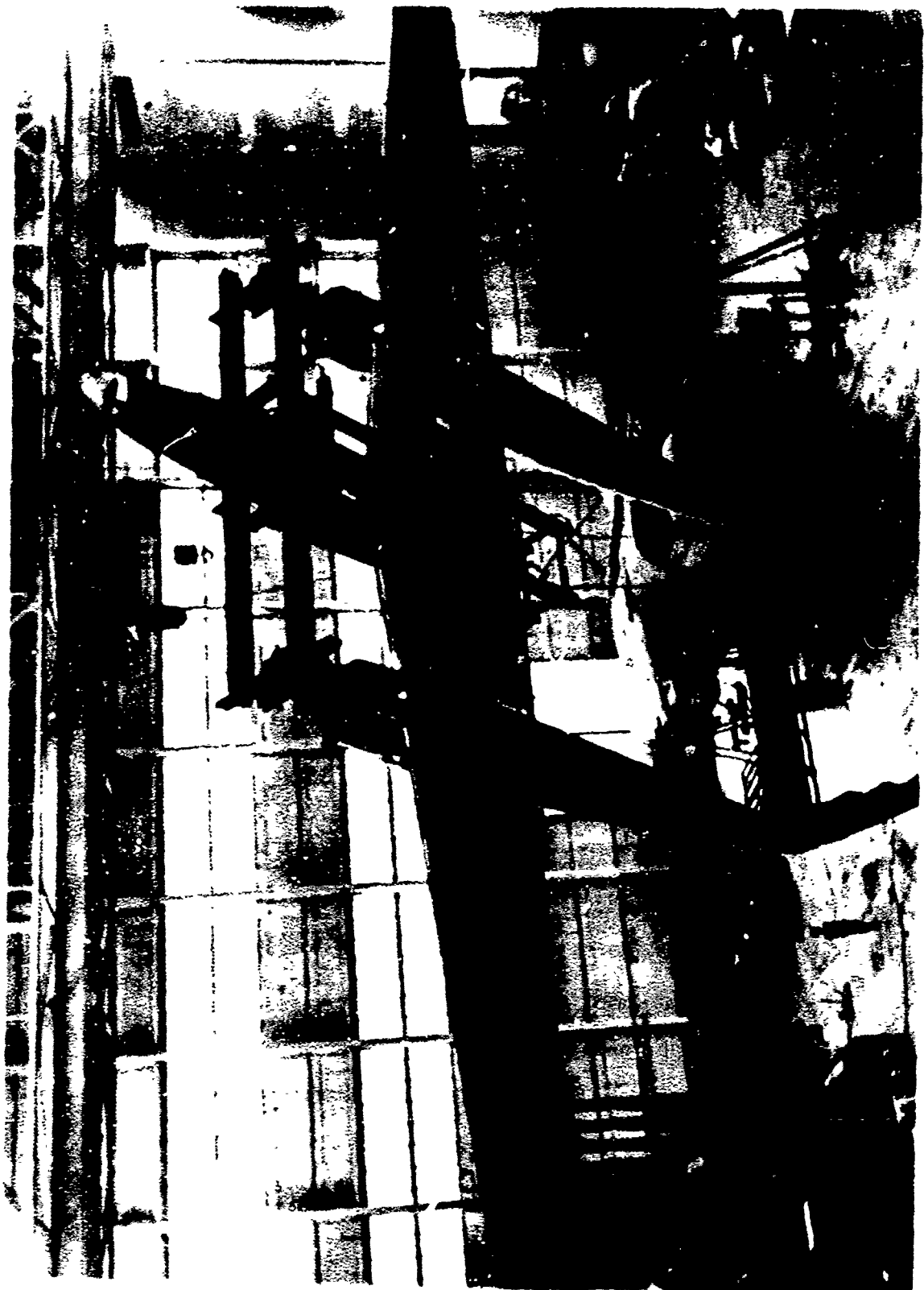

FIGURE 29

Turnover of the Hughes YF-11 in Building 65, north end, in 1947. Howard Hughes was almost killed as a test pilot in this model airplane in July 1946.

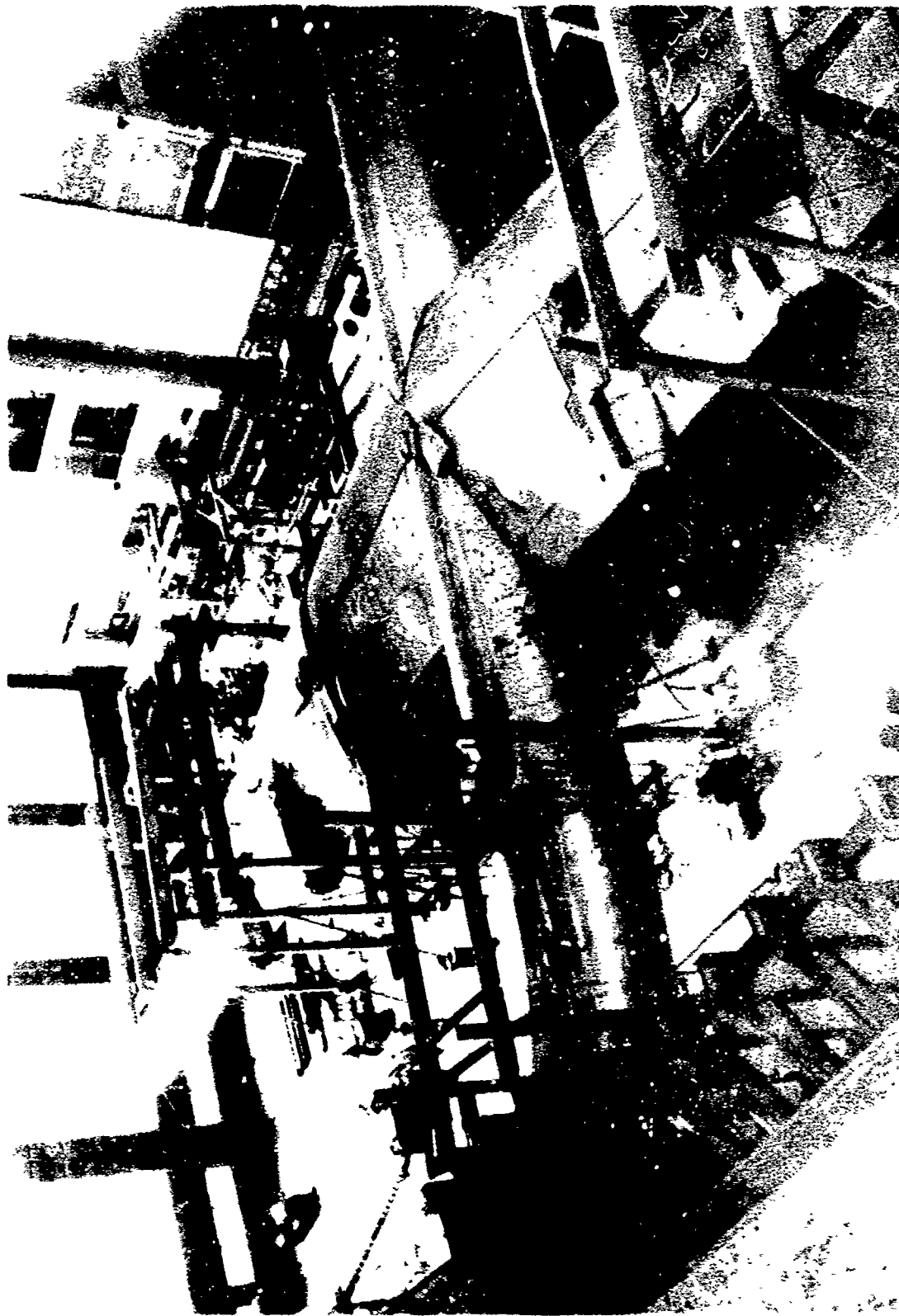

FIGURE 29

B-36 assembled in normal position for test conditions before turnover to test major wind and fuselage conditions in 1948. This airplane when assembled extended into both west and east alcoves.

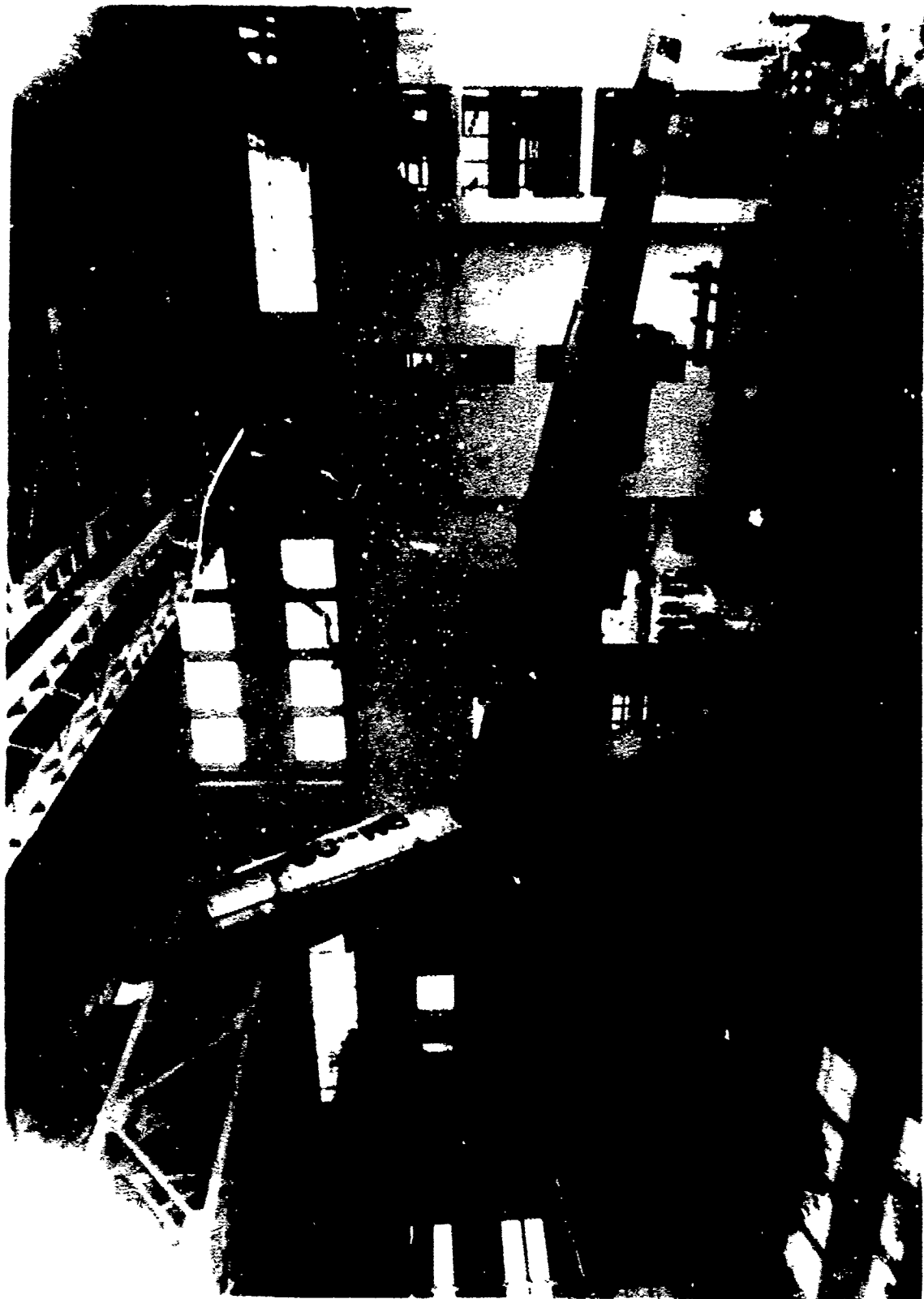

FIGURE 30

Turnover of B-36 in Building 65 at Wright Field in 1949. The size of the building and the crane capacities were design considerations for testing this structure.

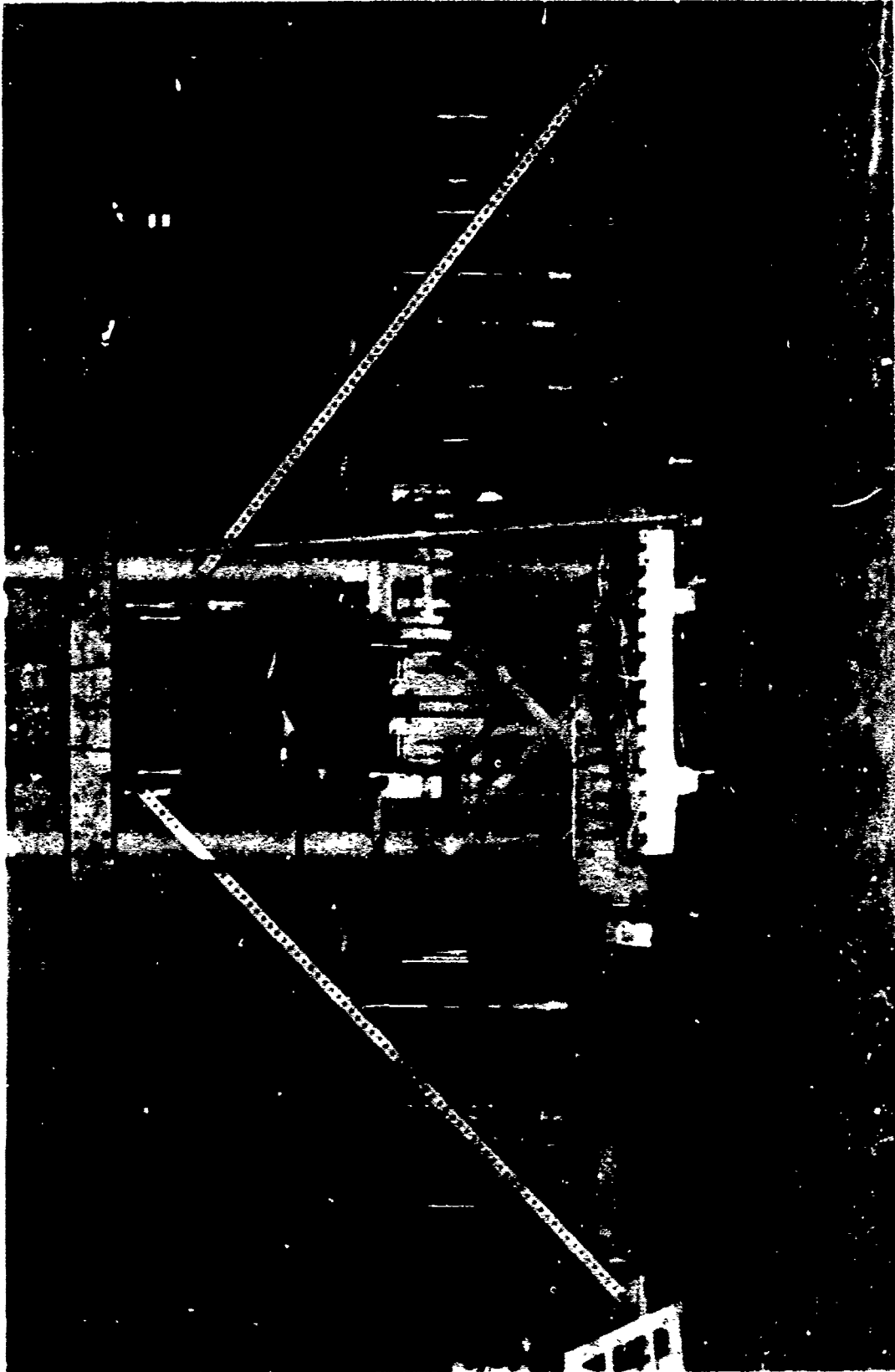

FIGURE 31

Static test of the F-80 sandwich wing at Wright Field in 1952. For this positive high angle of attack condition the airplane is inverted at an angle for the drag component. Loading is with combined lead shot bags and hydraulic load through sponge rubber tension patches.

jacks, to lower the incremental loads of shot or sand until the structure supported the load freely. Different sizes of the hydraulic struts were collected which enabled the engineers to manifold (interconnect) two or more different loads to a common pressure. This reduced the number of manually controlled load pressures for the test condition.

As different size landing gear retraction cylinders were scavenged from many different wrecked or obsolete airplanes, it was possible to improve the hydraulic loading system. These landing struts ranged in load area from .98 in<sup>2</sup> to 17.48 in<sup>2</sup> in 12 different piston areas. The individual hydraulic struts were attached to the whiffletree linkages which at the airplane surface connected to either 6 by 12 inch or 6 by 6 inch tension patches, each capable of supporting 1000 or 500 pounds each, respectively. More struts of equal pressure were able to be manifolded and loaded by a single valve for convenience and economy.

The aircraft electric hydraulic pumps were built into special cabinets with the hand valves and batteries (28 volt). Test workers had load/pressure schedules of 0 - 100 percent design ultimate load (DUL) at individual control hand valves and operated them under the direction and instructions of the test project engineer. The engineer called out individual increments, as opposed to supporting the structure with jacks while an increment of shot loading was put on and the jacks lowered.

The laboratory test jigs and load platforms at McCook Field, and at the first Wright Field facilities, at first were made almost

exclusively of wood members. With the advent of steel beams resembling parts of an erector set in 1935 there was a great savings in time and material. These beams, columns and channels, with holes spaced at three and six inch intervals, were erected and bolted together with three-quarter inch bolts. The different jig configurations were easy to analyze for the required jig strength.

The test floors were designed with steel railroad rails uniformly spaced to accommodate the steel jig erection. The present spacing in the static test facility has doubled railroad rails imbedded in the concrete on ten foot centers. Special load inserts are located between the concrete rails also on ten foot centers. This provides a five foot load reaction matrix over the entire area. These facilitated the erection of the steel beams to construct reaction load jigs to suit each particular test structure. This method of jig construction (large erector set) was simpler and quicker than building self contained loading jigs independent of the test floor. The materials were easily reusable. The same steel has been used ever since it was first purchased at Wright Field.

Static test conditions remained essentially the same for a number of years. As performance and speed of airplanes increased, it was found that other conditions existed which could also cause structural failure. Wind tunnel testing did not identify all of these conditions and some resulted in flight failures.

Most military aircraft were pressurized in the crew areas after World War II to obtain a reasonable cabin or cockpit environment for aircrew comfort. It was sometimes necessary to pressurize these in

conjunction with the test section under load to reproduce the design condition. Otherwise, a cockpit pressure test was performed without any other portion of the structure loaded.

Between World War II and the 1950's, major airplane structure components were tested individually because the state of the art did not permit the loading of all the major components simultaneously. The common practice was to test airplane components in a test jig. It was known that jig effects, where the mating part did not deflect as the true structure under load, gave improper results. Different results were obtained, for example, when shear stress was allowed to react into a jig as opposed to it being removed as an applied load at the attachments. The measured loads showed the structure experienced different bending stresses. Structural transition sections minimized this problem.

Aircraft in the 1950's were flying over 600 mph, and the leading edge loads were high. Shot bag loading was used in conjunction with the tension patch loads because of net load limitations when the loading exceeded the capacity of the tension patches. This type of testing prevented the application of the concept of a freely floating structure in complete equilibrium as suggested by Niles in the 1920's. The first free floating test was begun in 1952 and it showed conclusively that future testing would be done without inverting the airplane structure.

Sometimes wing bending and shear on large wings were applied through formers which were contoured to the surface so as to apply the load directly to the wing spars. Several of these were placed

incrementally along the wing span to give a reasonable step shear application and the shear loads could be placed chordwise at each location for the required torque. Some airplane companies would build in special test load fittings to the spars at similar spanwise stations and apply large concentrated loads in tension to produce the proper wing bending, shear and torsion. Such testing was generally non-representative and might not reveal local structural effects of the load as in flight, but it gave reasonable test results. The Air Force avoided testing in this manner.

The Air Force made a few efforts to calibrate multipar wing structures so as to calculate shear and moment spar distributions to improve design and analysis techniques. The F-102 wing was installed in a jig and calibrated for wing spar bending and shear with the spars mechanically manipulated and displaced to represent calculated differential fuselage frame deflections. Actual fuselage-wing deflections were different under flight loads. Other problems occurred which were not considered important but had a definite effect on the results obtained from this test.

Before the F-100 series aircraft, the fuselage airloads were neglected, although several contractors had to include it in the mid-1950's in order to produce the balancing fuselage shear, bending and torsion in order to balance the wing loads.

Static testing to failure was generally customary on all major aircraft components at the conclusion of the regular static test program. This served as a buffer for potential higher flight loads, changing missions, growth potential and provided design information for improved structural efficiency or design modifications.

Proof of static and dynamic structural strength prior to 1952 was done by checking in detail the contractor's stress analysis, flying the airplane at the various design flight envelopes, using different centers of gravity locations combined with gust conditions in flight and the static testing to full ultimate load for all critical conditions.

During static test, the structure was monitored at all times for buckles or permanent deformation in the skin and stringers. A separate limit load test was performed before any other testing to check for permanent set or permanent deformation as the first major test. It showed up control surface binding and functional control surface and flap operation at limit load. This testing proceeded incrementally to 67 percent design ultimate load with the load removed to zero each time to check for permanent deformation.

Tests were usually in increments of 20, 40, 60, 70, 80, 90, 95 and 100 percent of design ultimate loads. The 70 percent increment was changed to 67 since it represented limit load. Incremental loading was used so that necessary test observations and test data could be recorded, and if a failure occurred, the approximate load at failure could be determined.

Engineers used slide rules and mechanical calculators to generate load/pressure schedules for each and every test condition point. Manifold pressure/load tables were later developed which eliminated the tedious, repetitious, pressure/load schedule calculations for hand valve loadings.

The test loads were applied using hydraulic hand valves operated from a 20 gpm Superdraulic pump from the 1940's until the 1960's. In 1964 the Load Maintainer (Edison) loading control method began phasing in. It had ten screw arms, ten shot pans and a hand crank which moved in or out representing a percentage of load, and worked best when the shot pan was balanced between the equivalent of 1000 and 2000 psi of hydraulic pressure. The load was applied by the balancing and unbalancing of the lever arm opening and closing hydraulic valve ports. Several machines could be linked together and the incremental test load could then be applied by one operator.

Testing in the 1950's was slow and time consuming. Test loads were applied to free floating setups in increments of ten or twenty percent and data taken manually. In 1959, liquid level manometers were developed to record airplane deflections much more quickly and as accurate as reading deflection scales with a surveyor's level which had been the practice for many years. This was soon made obsolete by electrical resistance deflection methods with the reading made remotely using a new data acquisition system in 1962.

Failure prediction was important to static testing, but was never developed sufficiently to be of any use. In efforts to make such predictions, strain gages were used to monitor the strains at critical locations. It helped the engineer understand the behavior of the structure and the location of stresses, but it was not possible for him to predict failure. However, a probable location could be pinpointed using an empirical plotting method.

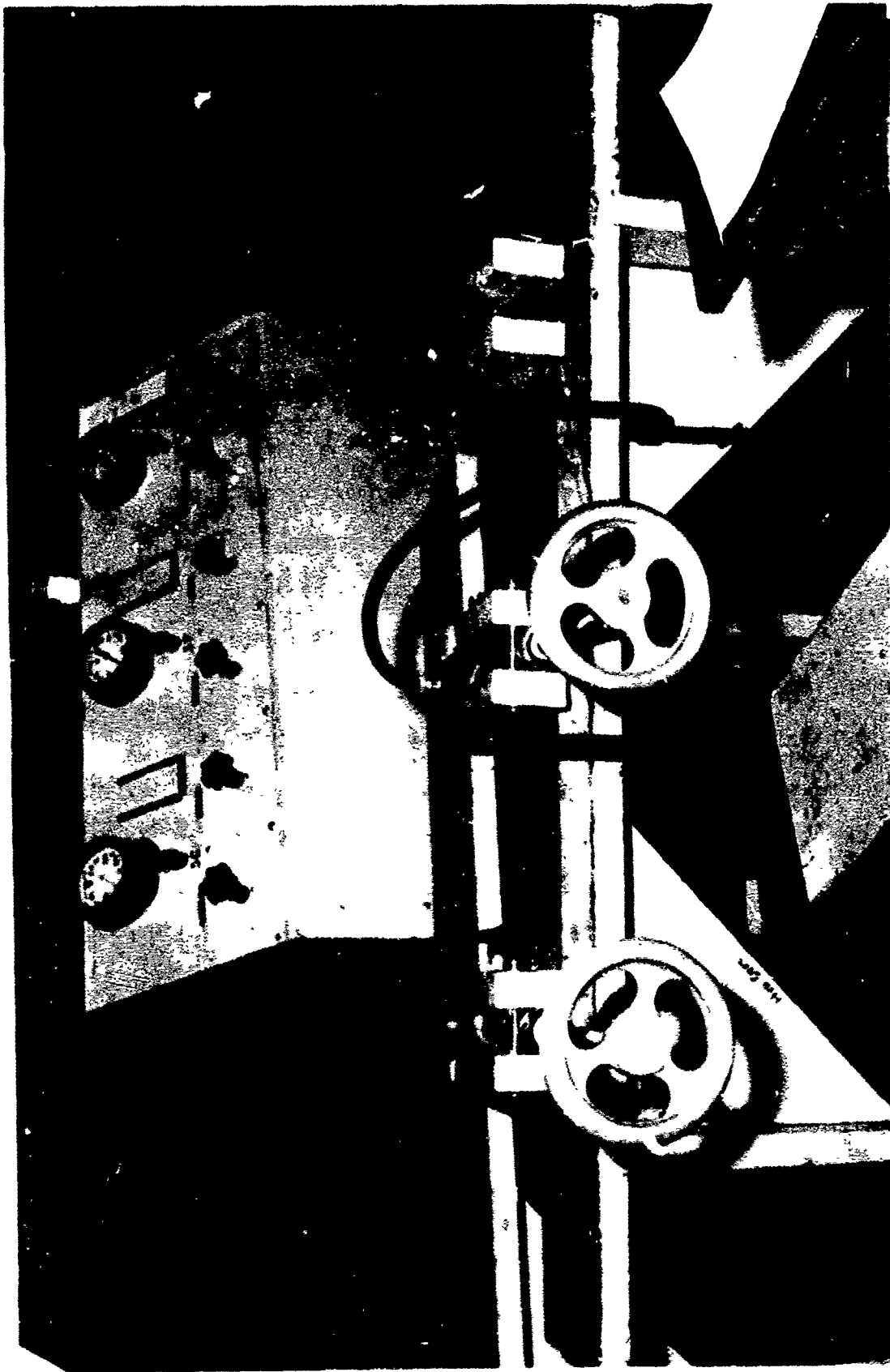

FIGURE 32

Manual hydraulic loading cabinet in the background with the manual vernier control pressure adjustment valves made from hydraulic jacks for precise pressure adjustment in the foreground. This equipment was used up until the 1960's.

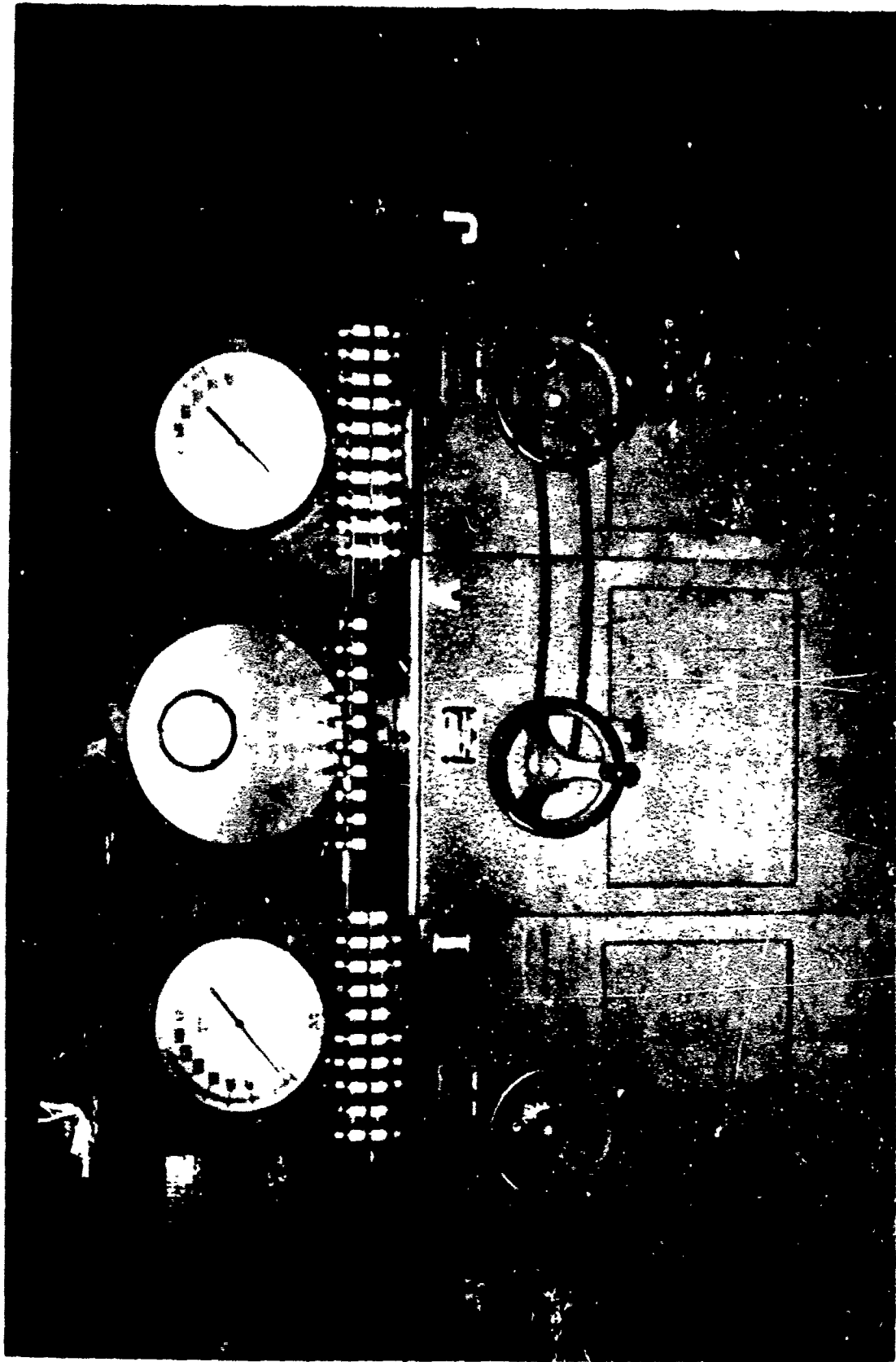

FIGURE 33

Hydraulic pressure control units manufactured by Edison Marginator Company were first used in static testing at Wright Field in 1954. Each unit had 10 channels with separate pressure valves to set the amount of shot in the baskets on the pressure qage.

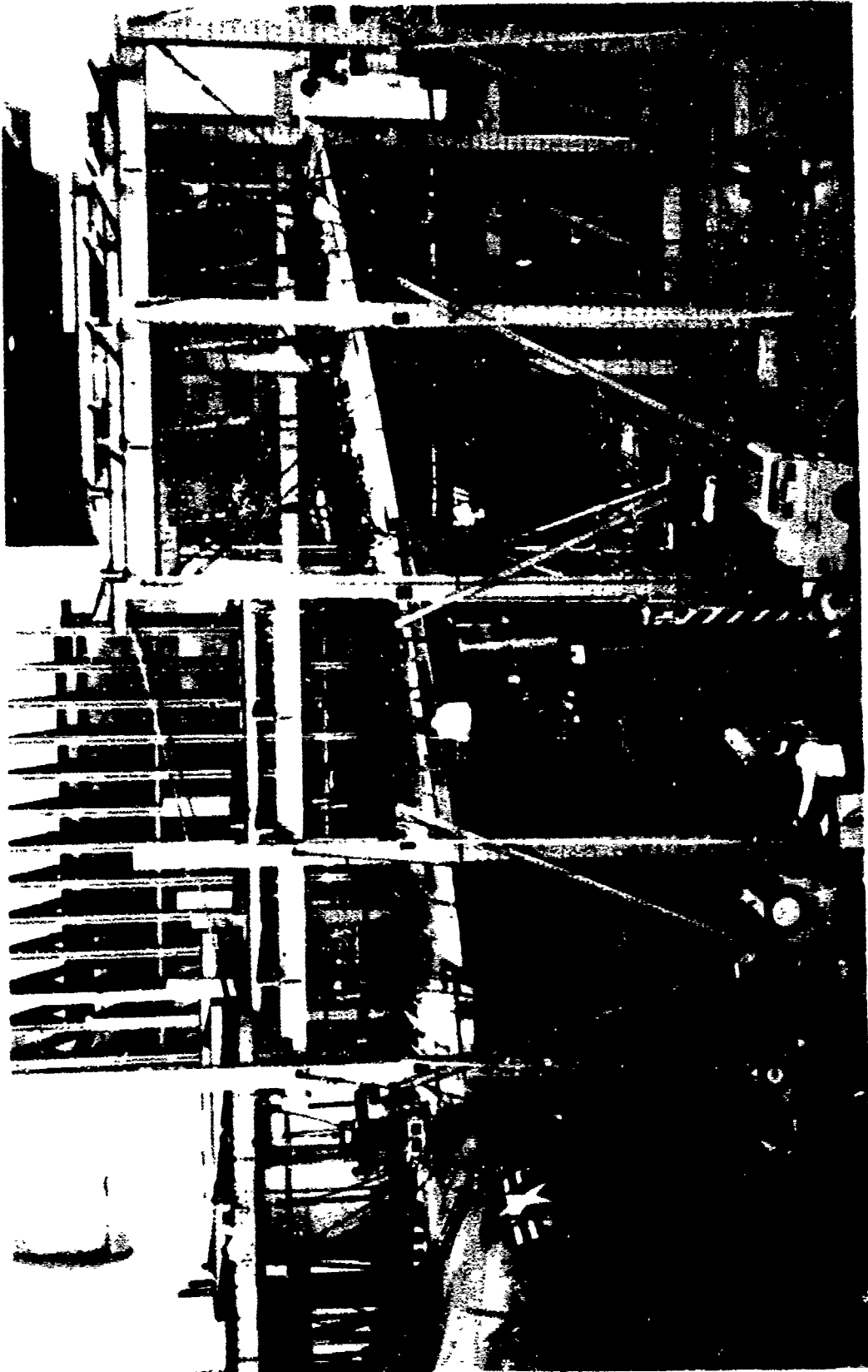

FIGURE 34

C-123B positive low angle of attack condition static test at 100 percent design ultimate load. Note deflection scales hanging from wing and the use of manual loading hydraulic valves in conjunction with Edison hydraulic loading units. Individual on the fork lift is watching a problem area without regard for his personal safety which is no longer tolerated.

The deflection rate failure prediction method was used with some success in the 1950's and definitely showed where a wing, for example, would fail. Without using very detailed calculations though, it could not be predicted at a specific load level. The failure indication was based on local plasticity. The detailed deflection calculations were too time consuming when done manually while the structure was under load. Development work for this method and others were abandoned for several years and a study effort was revived in 1973 for use with a digital computer system. It was dropped with the change in the facility's mission and no further work was done on failure prediction for static or elevated temperature testing in the Air Force.

When strain gages were first used it was difficult for engineers to believe some of the readings. Most of the time the gages would be supplying factual data but were not interpreted correctly. Experience using these sensors helped to solve this problem.

Strain gages were the best instant analysis method, and were used to compare the test strain level at a given load increment against predicted strains as the test progressed. It could be said, with certain qualifications, that the structure should be able to withstand the next load increment by comparing values determined from previous increments. The strain information was valuable for re-evaluating theoretical stress analysis, checking validity of engineering assumptions and for future growth or modification to the structure.

Zeroing strain gages at no load was always a difficult problem to solve due to inaccuracy in relieving the structure dead weight

and that of heavy steel linkages. Usually it was necessary to zero out the strain gages at 20 percent design ultimate load.

The flat steel linkage for whiffletrees were made as needed from bar and plate stocks. The standard usage was for applications from 3,340 inch-pounds to 180,000 inch-pounds bending moment at a design stress of 20,000 psi. The steel was very heavy when assembled into a whiffletree. It required considerable dead weight relief, which was provided by platform baskets attached to cables and pulleys using shot bags or 50 pound pig lead bars for the required total weight. The dead weight of the structure was also relieved in the same manner so that the applied load could start at a predetermined level above zero. In some test setups the dead weight of the structure was subtracted or added to the first load increments.

Even before the need arose for test loading at elevated temperature, the sponge rubber tension patches were shown to be unsuitable for fatigue test operations. With more and more fatigue testing being done, a problem existed for which there was no apparent solution. The B-58 test program was planned as an elevated temperature static test, and to facilitate test loading integral spar fittings were installed on the wings inboard of the leading edge because of the extensive use of honeycomb panels. No penetrations could be made in the honeycomb wing panels and the solution was to develop a load patch which could be used at temperature without effecting the skin temperature distributions.

This problem was solved by the development of load patches using

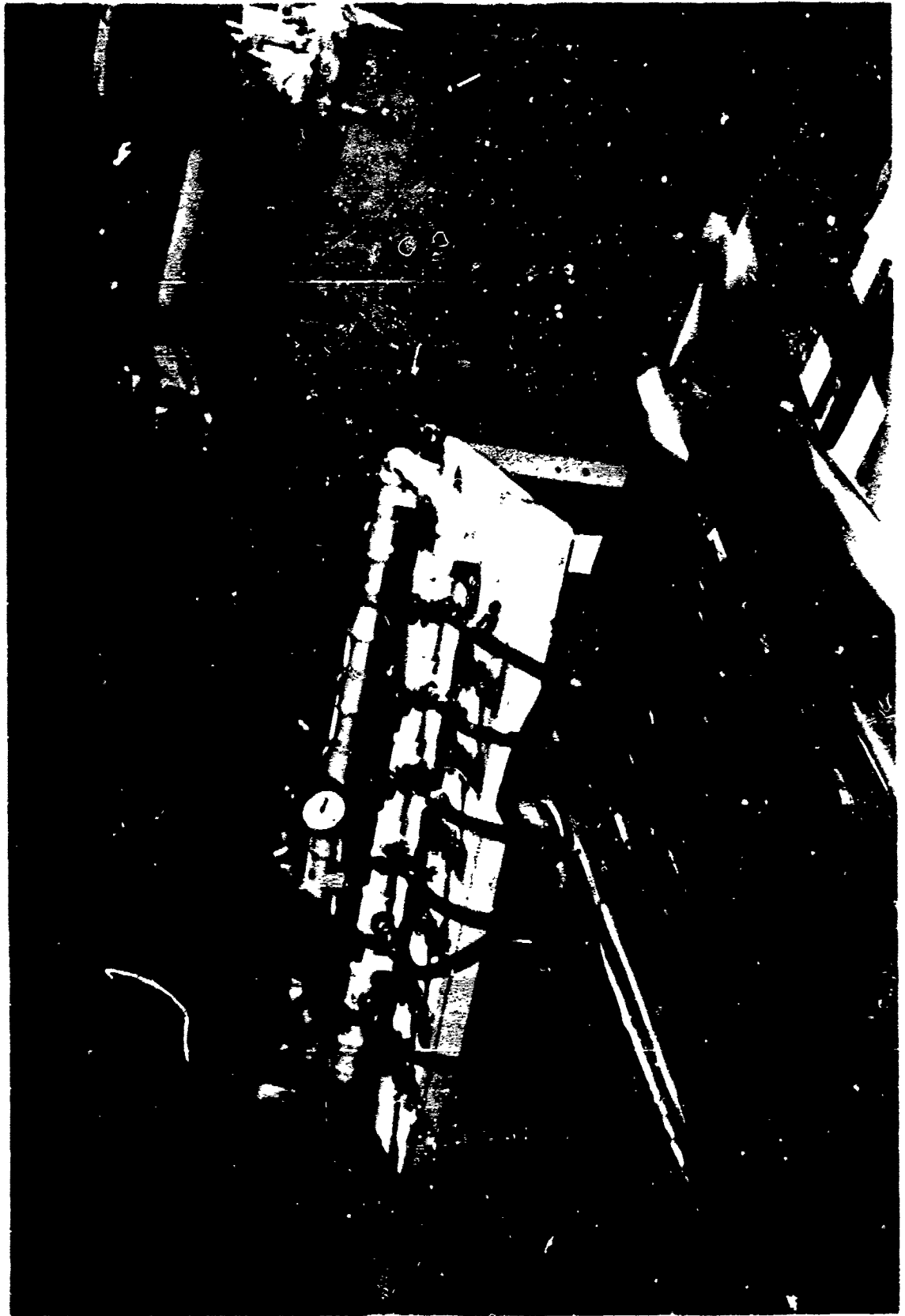

Vacuum blanket method used for installing sponge rubber and RTV silicone rubber tension load patches on test structure surfaces at Building 65.

room temperature vulcanizing (RTV) silicone rubber on two by two inch backing plates. They were suitable for long time loading at temperatures to 600°F for static loadings and nearly 400°F for fatigue loadings. The RTV silicone adhesive had an apparent infinite life at room temperature in fatigue which solved a difficult problem. These small patches were used in large numbers (thousands) on the B-58 leading edges, elevons, wing tip, tail and rudder. This same material was used for shear straps to apply fuselage loads and drag loads. It has been used exclusively since this test program.

New linkage was also developed to pick up the load cables attached to the load plates to complete the whiffletree. Quick disconnect fittings were designed to pick up the swaged balls on the steel cable at the first tier of linkage which was designed using aluminum sheetmetal which had multiple holes for universal adjustment.

The sheetmetal linkage was built in 4, 6, 12 and 24 inch lengths with a load capability from 4,000 to 16,000 pounds. Aluminum doublebacks (double channels) of higher load capacity and longer lengths were used in the upper tiers and for connecting to the hydraulic loading jack. Sheetmetal linkage used in fatigue tests usually required that the bottom tiers be scrapped at test completion. This linkage also served as a safety factor against inadvertent overloads. Shear failing links were designed and used additionally for each load on the B-58 static test program to protect the local structure from accidental overload. All this equipment was designed and fabricated in Air Force shops or by local contracts and is still in use.

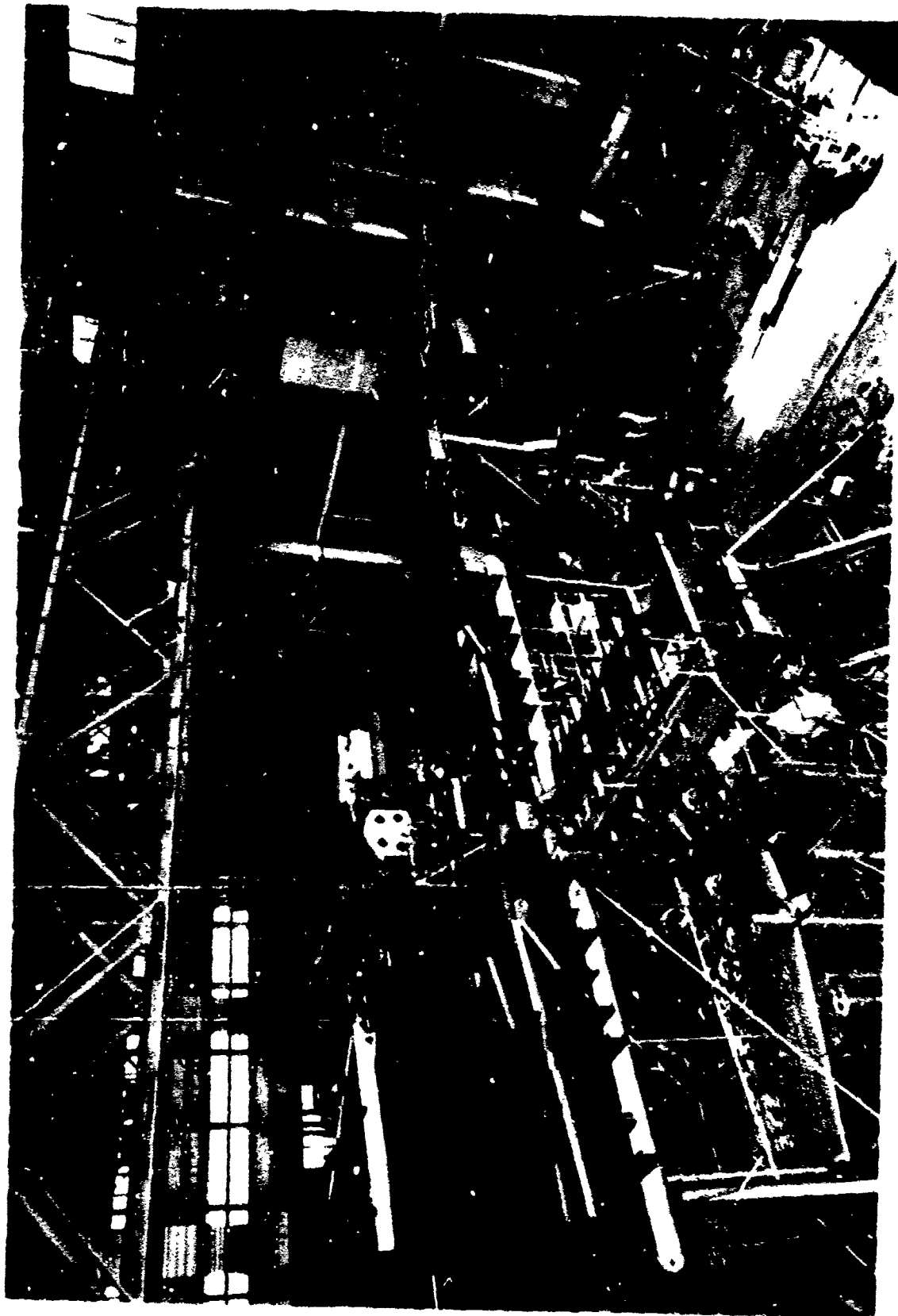

FIGURE 36

The Building 65 test floor in 1974 showing the A-10 static test in the foreground, the F-4C/D fatigue test on the right side and the Advanced Metallic Air Vehicle Structure (AMAVS) B-1 wing carry through structure fatigue and fracture test setup in the background.

SECTION VIII  
FATIGUE TESTING

Fatigue failure is caused from repeated stressing of metal. It was discovered by the railroad industry in equipment which experienced a large number of cycles of vibration or dynamic loads. Their most significant problem occurred in the steel wheels and axles. The railroads were able to solve their fatigue problems and it was all but forgotten by the time fatigue became a significant factor for the airplane. The sources of dynamic stressing and vibration were many in the airplane, whether from gust or maneuver, during flight or in ground handling operations.

When the problem first developed in airplanes, it was difficult to find appropriate, or suitable, test loads to use for evaluating the fatigue characteristics of components. A base point was needed to begin work and establish test criteria.

The Wright brothers experienced "crystallization" problems on a strut fitting and a warping wire pulley bracket at Fort Meyer, Virginia in 1908. Later, there were nuisance failures of lift and landing wires and wire fittings on the Curtiss WBS-4 and the JN-4 which were blamed on repeated stress and vibration.

One of the early airplane fatigue failures was on the B-24 nose gear during World War II. Based on operational records, it was known how many hours the B-24 had operated before the fatigue failure occurred. After some experimentation in the laboratory with load magnitudes and load directions, the gear was made to fail as it had in service. By reinforcing the nose gear until it took twice as many of those load cycles before failure, the service life was approximately



FIGURE 37

Test failure of B-24 nose down crash landing study. Tests were conducted in Building 65 around 1945 and was not documented in a report and is not listed in the Appendix on test programs.

doubled and the successful solution added 2,000 hours more of operation.

In 1945, the North American AT-6 advanced trainer was the first airplane used for a fatigue test at Wright Field. Its predecessor, the BC-1 was used in the static test laboratory to develop cushion loading pads and tension loading pads in 1939.

The wings of the AT-6D were the only parts used for fatigue tests. These tests were crude, but adequate, for the load requirement and the number of cycles which were applied. Repeated testing to limit load was done until failure occurred. The inspection methods were also crude, mostly aural or visual in order to detect or find a crack.

During World War II, airplanes did not accumulate too many flight hours a year, and only the training airplanes were flown enough hours to warrant any fatigue investigation. Commercial airplanes in the 1940's flew about 2,000 hours a year and fatigue was not considered a serious problem. Their usage increased steadily until they fly almost around the clock today and fatigue testing is essential to assuring long, trouble-free service from fatigue problems.

After the war, a P-47D and P-51D airplane classed as "dive weary" were static tested in 1946. These airplanes had been used for training only with many high "G's". The connotation of fatigue or reduced static strength accounts for those tests.

In 1948, fatigue tests were conducted on F-84D wings, and in 1949 the C-45F wings and main landing gear were fatigue tested. In the early 1950's, Holland B. Lowndes, Jr. (Wright Field Engineer) showed the most interest in doing fatigue testing in the Air Force test laboratory, and continued working on F-84G wings in 1952. F-84 wings from airplanes used in the Korean conflict were fatigue tested using the

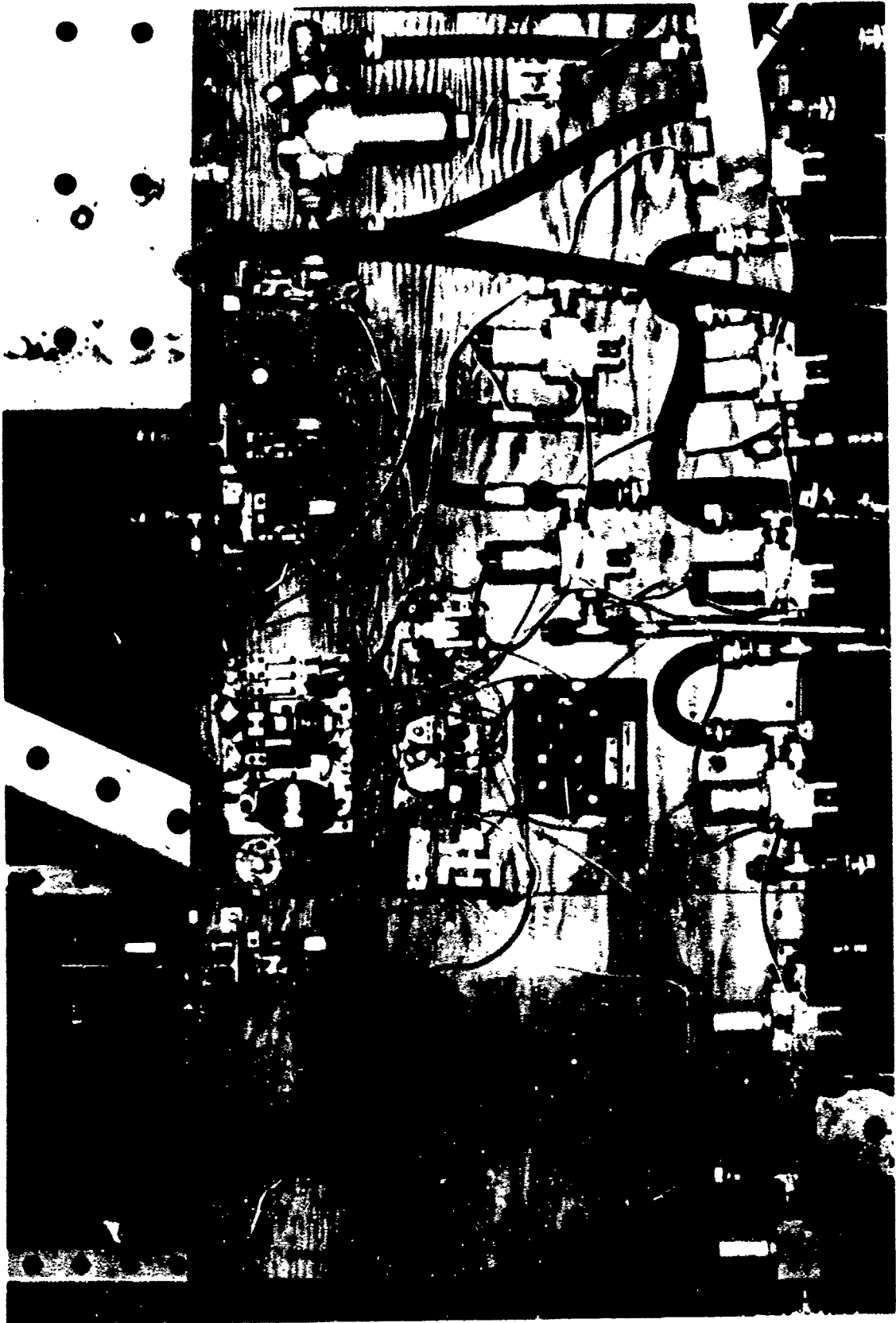

FIGURE 38

The first automatic hydraulic control system used for fatigue testing at Wright Field, Building 65. This equipment was designed and built by the hydraulic foreman.

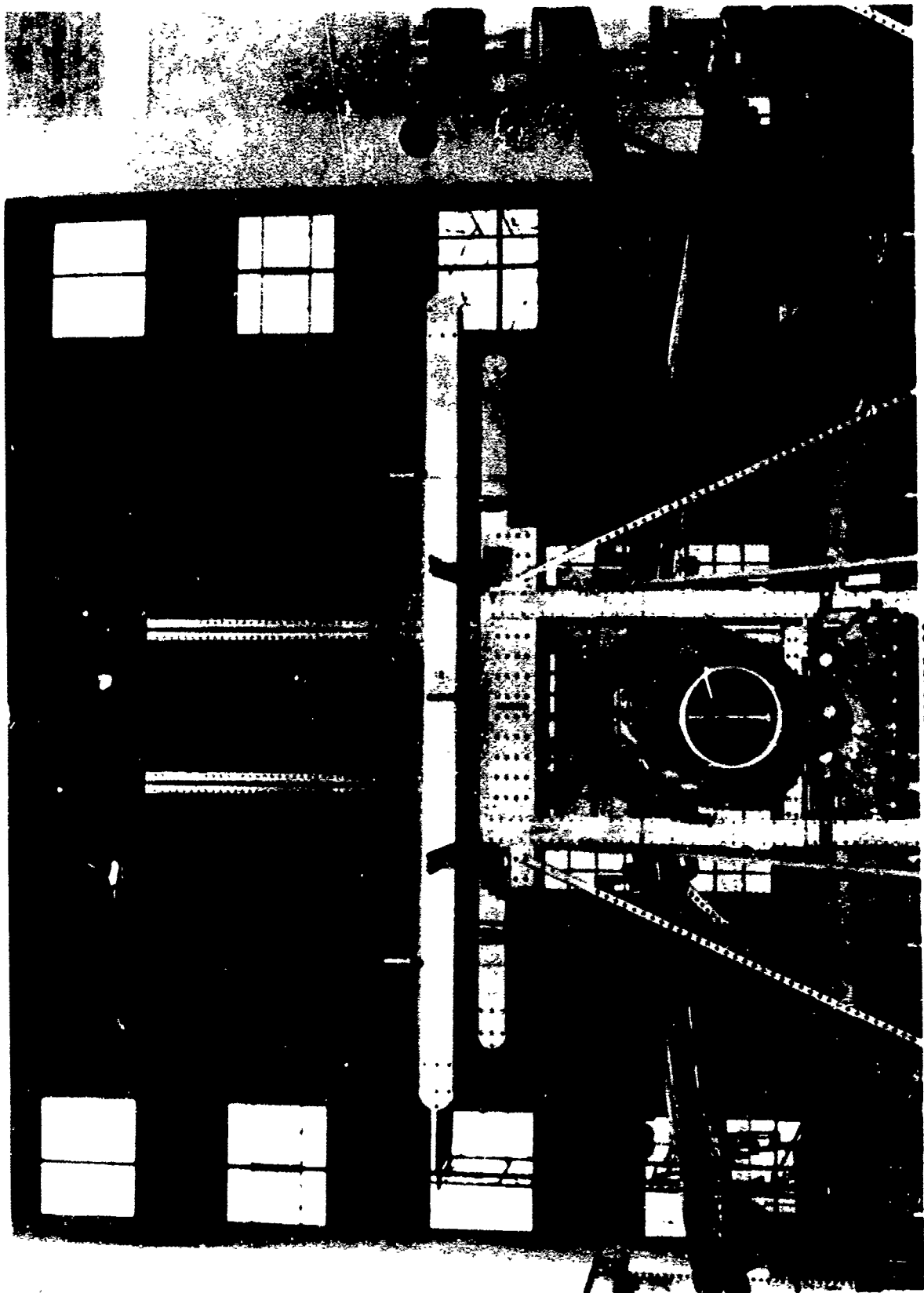

FIGURE 39

The F-84D wing fatigue test at Wright Field in 1948. The wings were cycled from 20 to 67 percent design ultimate load until failure. The fatigue control panel is in the lower center.

normal method of cycling to limit load until failure occurred. These wings withstood more load cycles than new wings and the reason for this was not understood.

In all of the previous years of airplane design, there was evidence found that showed fatigue was considered. Several Air Force Wright Field test engineers did recognize the problem and made attempts to require high level approval for separate fatigue testing on each new airplane along with static testing on separate airplane structures.

The first indication of a fatigue problem in service came about from an inspection after a left wing failure and crash of a F-89C airplane at an air show in 1952. Others crashed after that, including one at the Paris air show. Most of the failures were due to a lack of static strength. It is possible that had the F-89C been designed for the actual loads which it experienced in flight it would not have failed from fatigue and that problem would have taken several years before becoming known. A fatigue problem was proven conclusively on the F-89C wing attachment fingers in the 1953-54 Wright Field laboratory fatigue test program. This series of accidents did command more high level attention in the Air Force on airplane fatigue problems.

There were some reflections and temporary concern by the Air Force for fatigue problems with the crashes of the Martin 202 in 1948, and the British Dehavilland Comet in 1954, but it took the E-47 accidents to finally bring about the full Aircraft Structural Integrity Program in 1953. After the accidents, in June 1952 an F-89C was fully instrumented with strain gages and other instrumentation for flight load measurements. It was learned from this effort that the wing twist produced a more

outboard c.p. (center of pressure) than had been used in design, thus increasing the wing bending loads. There were other factors, but this was the major one.

Fatigue took on several different forms as performance of aircraft increased. Engine exhaust contributed to acoustical fatigue on control surfaces and skin panels. Low stress fatigue was considered a factor in pressurized fuselage failures, and high speeds resulted in elevated skin temperature and thermal fatigue. Engines and landing gears were also very much involved. Corrosion and fatigue combined to cause additional problems which were almost impossible to duplicate in the test laboratory and, by necessity, laboratory fatigue testing was completed in less than real time, but it was designed to simulate real time.

Fatigue failures, once called crystallization, usually started at a local stress raiser such as a bolt hole, fillet, flange, rivet, corner, tool mark or high strength fastener. The possibility of fatigue was increased by the constant search for weight saving and structural efficiency by increasing the design allowable static stresses and the use of higher heat treated materials. It was further increased by higher takeoff and landing speeds which resulted in more severe taxiing, ground maneuvering and dynamic landing loads. Higher altitude flying increased the pressures on fuselage and cockpit sections, and changes in missions used more of the design allowable fatigue limit.

Initial fatigue testing started out using a constant amplitude load level, usually limit load or less. Later, test methods were

revised to reflect better knowledge with testing done using a mean load level, varying load amplitudes, and different numbers of cycles for the different load amplitudes. A "scatter factor" of four lifetimes was agreed upon to cover variations in manufacture, material properties, unanticipated service usage, testing and other things. This meant that to achieve 4,000 service hours, as required for fighter aircraft, 16,000 hours of laboratory testing were needed.

Supersonic flight caused a concern for elevated temperature fatigue and this resulted in a complex "Time Compression" test program which lasted from July 1964 to June 1970. The time compression program was used to study methods of compressing elevated temperature fatigue test time and still produce similar results as real time testing.

In the time compression experimental test program, titanium coupons were used for a Mach 3.2 supersonic transport and AM 350 stainless steel coupons for a Mach 4.5 mission. This experimental program consisted of material evaluation, including creep tests, spectrum tests in basic environments, spectrum tests for the total flight missions and post-test metallurgical examination of the selected coupons.

The results of these time compression test techniques used in the experimental program showed little, if any, success. It did show that the 8-1-1 titanium material was not affected by creep in the Mach 3.2 environment and the cycle replacement technique was not reliable. The multiflight technique did not use compressive loads and thus the data and the results have no real meaning. While it showed that creep did not appear as a significant problem for consideration,

there was no data obtained on the effect of a crack tip which might have made a quantitative evaluation possible.

This program was entirely too complex to obtain essential data and did not prove that time could be compressed based on the data obtained. Such knowledge must be learned from a new and different program when needed. There is presently a better knowledge of metallurgical material behavior in a crack and a better program could be designed whenever the need arises.

The B-47 fleet fatigue problem in early 1958, which temporarily immobilized the fleet, was very closely followed by serious ones in the B-52 fleet. Fatigue was then the most serious problem in the Air Force. The vacillations of years past and arguments between static or fatigue testing as opposed to doing both programs on each different airplane structure were muted. It required a gigantic effort and a very high cost to fatigue test representative airplanes of the B-47 and B-52 from 1958 to 1963. Those fleet problems resulted in all out effort to solve the total problem in the Air Force with all other first line airplanes, first production airplanes and with resultant changes in design criteria, test criteria and design practices.

The impact for the Air Force was far reaching indeed. An extensive structural integrity investigation was launched which eventually encompassed all airplanes in the inventory with remaining useful service life of interest to the nation's security.

The B-47 structural crisis brought to focus a need for fatigue research and development and service airplane fatigue testing that engineers in the Aircraft Laboratory had tried to initiate for many years.

A need to understand and combat the basic causes of fatigue became the goal of the investigative program in 1958. To do this, the flight service loads program and more accurate and predictable mission requirements were necessary to forecast operational life.

The gigantic work effort to determine the remaining service life, identify structural danger areas and define inspection methods and procedures involved the following aircraft: B-66, B-58, B-57, B-52, B-47, F-105, F-106, F-104, F-101, F-100C/D and F, F-89J, KC-135, C-133, C-130, C-124, T-38, T-37, and T-34. Airplanes such as the F-89C, D and H and the F-102, for example, were either previously fatigue tested or in the case of the F-102 equated to the F-106. The fighters were required to have a service life of 4000 hours with 5000 landings, most bombers required 10,000 service hours with 5000 landings, trainers 8,000 hours with 20,000 landings and most transports 30,000 hours with 15,000 landings.

New equipment was required to simulate the mission spectrums. Testing had been done open loop (no signal return from a transducer) using pressure relief valves that released each load cycle in combination with a timer to open pressure valves to start a repeat cycle. Various combinations of electrical contacts, pressure switches, relief valves, etc. were used. A better loading method was developed at Boeing for the B-47 and B-52 fatigue test programs using a closed loop system. A rotating drum was used for the load sequence programming with analog control devices using electro-hydraulic servovalves and load cell feedback from hydraulic jack loads for proper loading of the structure.



FIGURE 40

The first 141,000 loading equipment not made by the Air Force was purchased from the Compudyne Corporation in 1979. It had five Alabama Automation Corporation drums and 34 analog controller channels operating electro-hydraulic servo valves with load cell feedback. This was the first of a low cost program used at Wright Field.

The first fatigue loading system for Air Force fatigue tests was purchased in 1959 from the Compudyne Co. which was similar to the system used by Boeing. It consisted of 34 load channels each with a complete electro-hydraulic force control servo system. The force-time functions were programmed with five Alabama Automation Corporation program drums and a master control panel. Loading capability was from 0 to 50,000 pounds at a cyclic rate which varied according to the hydraulic flow available at a given pressure differential and response of the structure. A flat-bed curve follower was later developed by a Wright Field engineer for programming the loads.

Test fatigue simulation progressed from a single load cycle, repeated over and over, to a block load spectrum of varying amplitude with and without a mean load and with load reversals, and ground-air-ground cycles. It later progressed to flight by flight load sequences and complex mission profiles. The flight by flight load sequence testing was not easily done without using a digital minicomputer. The minicomputer was not available for use in fatigue test laboratory until the early 1970's. Fatigue load programming was done in the late 1960's using multi-channel FM tape recorder-reproducers. Then the Information Technology Incorporated (ITI) digital simulators used in the time compression program (digital programmer with 4K of memory) were modified to incorporate a cassette recorder for more complex longer duration single channel flight by flight load sequences. The ITI Digital Simulator removed the program time constraint of the FM tape transport simulation.

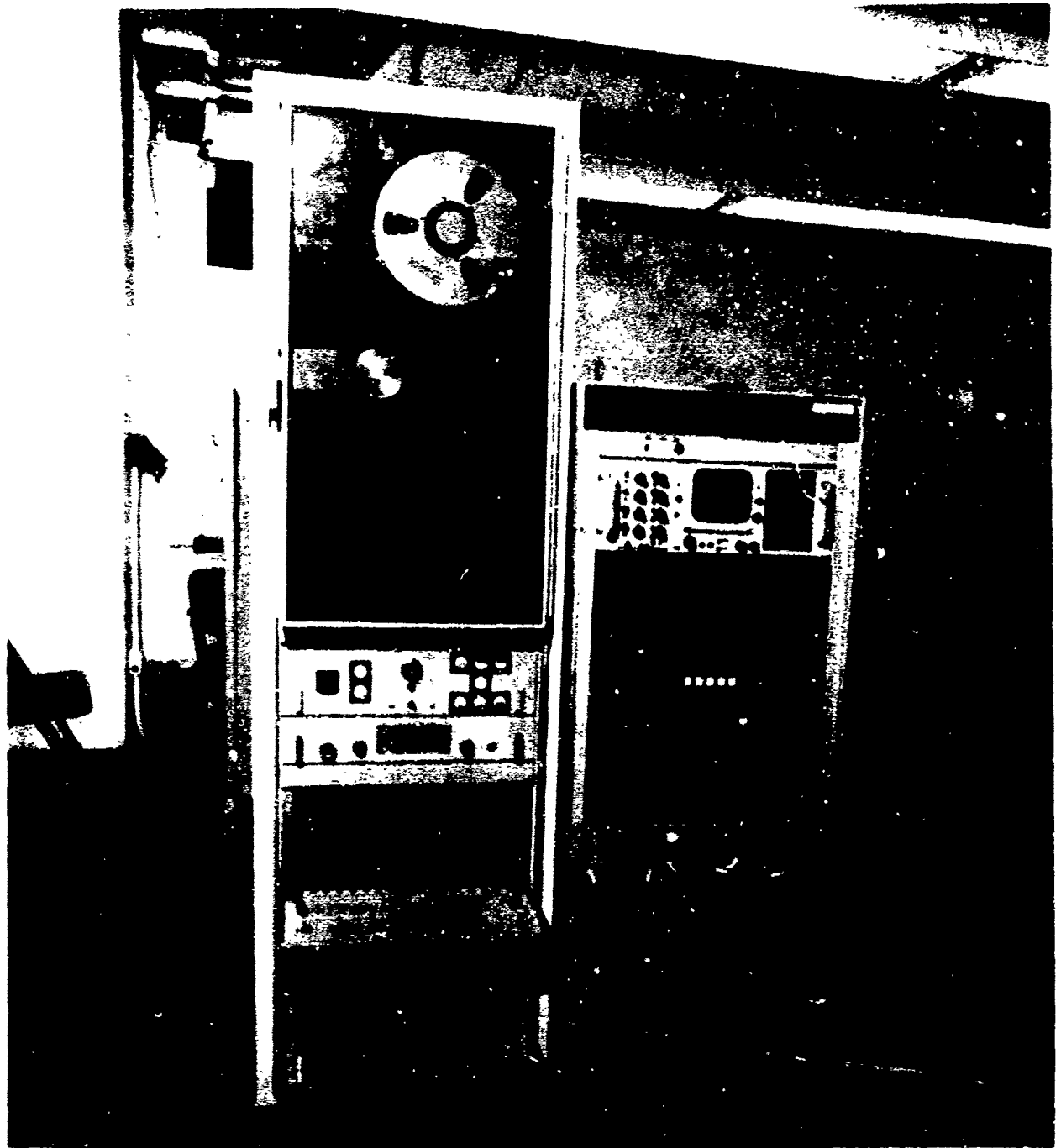

FIGURE 41

A 14 channel FM tape system and Datatron automatic tape search and control with error detection used for fatigue tests in Building 65, Wright Field, in the late 1960's and 1970's.

The "Time Compression" study under Project 1347 from 1964 to 1970 could not have been accomplished without development of the special ITI Digital Simulator. The hardware developed had a three channel capability and satisfied the requirements for programmed temperature, the cyclic fatigue load spectrums with added cycles, and a mean load profile.

Early fatigue studies concentrated on S-N curves in which the material stress was plotted against the number of cycles to failure. Testing was usually discontinued after a few million cycles, or when the curve became nearly asymptotic to the abscissa. It was believed that when this occurred that stress levels below this curve did not contribute to fatigue. This level was called the fatigue limit, and for aluminum it was arbitrarily specified as  $10^8$  cycles. It did not consider the effects of reversed loading or of combined steady and varying loads. Miner's theory assumed that every load contributed some small amount to the total damage and that all loading history was cumulative. This theory was used for several years.

Fatigue designs led to safe life and failsafe structures. Tests were made in the 1950's on loaded structure where a primary member was cut with a saw or other kind of rapid cutting device. Failsafe structure is redundant such that if any one member fails, the remaining structure will take limit load (or 80 percent ultimate, depending on whose criteria is being used). Safe life structure assumes that cracks will not grow critical during the life of the structure, or that they will be found and fixed before reaching a critical length during specified inspections.

The Structural Life Prediction Program in 1958 was set up to prolong the life of weapon systems out of production and in active first line combat inventory, to reduce the cost of Engineering Change Proposals, to improve performance and to include fatigue design know how in future weapon systems (airplanes) to alleviate severe problems of structural and acoustic fatigue.

It was in the mid-1950's that a full scale interest developed in which scientists and engineers began serious and practical work on the fatigue problems. Investigations showed that some materials behaved differently under the same load spectrum and because of this a need was found to study it in a different way. Fracture mechanics came into being which gives a theoretical explanation of the behavior of materials and is able to predict crack growth mechanism and crack growth rate, etc.

The first minicomputer for the structures test laboratory was purchased for Neuber's fatigue analysis in 1971, a Digital Equipment Corporation PDP-11/20 with 4K memory and some peripheral equipment. Multi-channel flight by flight load sequences could not be effectively accomplished in the laboratory without digital computer equipment.

The sophisticated and specialized computers and their software brought about more and more testing on components and full scale structures. New materials made it necessary to do more coupon testing, which, heretofore, was reserved for the metallurgist to evaluate the specific properties of materials for aircraft design usage. The fracture mechanics testing of these materials was necessary to prove their acceptability and for the use of high strength fasteners in

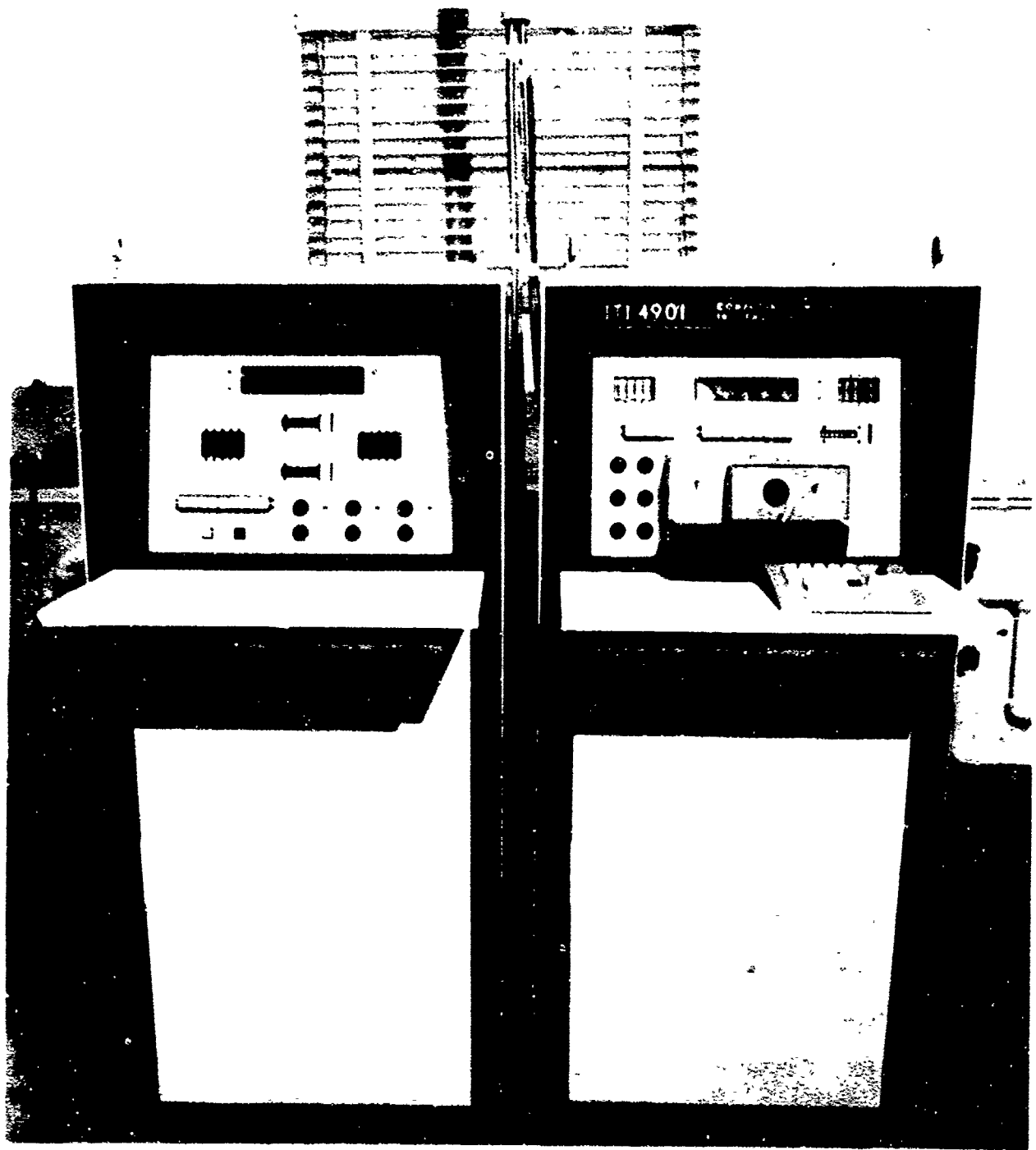

FIGURE 40

Informatics Technology, Inc. Digital Simulators made for Building 65, Wright Field, to program fatigue loading and temperature on the Time Compression test program in the early 1960's. This equipment has since been modified and is currently used for fracture mechanics test programs.

combination with structural materials and predict critical crack growth to help establish airplane inspection procedures.

Increased usage of military aircraft with greater accumulation of fatigue damage was of great concern. There was a critical need to sense a fatigue crack or potential failure before a serious accident occurred, but a useful practical method had not yet been developed. The many operational variations of military missions usually work to the detriment of the structure's fatigue life or design flight time. A fatigue life of 4,000 hours for fighters was not adequate any longer for Air Force needs and new fatigue tests were required to prove the life to 8,000 hours. Cargo plane fatigue life is 30,000 hours due to the low load factor usage, but it can vary on both fighters and bombers, depending on service requirements.

In 1970, the Pakistan Air Force inquired concerning the service life of the AT-65 aircraft. They thought it inconceivable that the U.S. Army Air Corps and the United States Air Force operated these aircraft extensively in pilot training without specific data on the expected airframe life. The answer sent by the Aeronautical Systems Division was truthful and to the point. Several photos were all that remained of the evidence that it was tested. The Aeronautical Systems Division said that "during the 1945-1958 time period, the need for service life calculations and fatigue test verification was not considered necessary. The test of the AT-6 aircraft is believed to be the first such test ever conducted for the Air Force, and was purely scientific in nature. Therefore, it is entirely conceivable that the U.S. Army Air Force operated these aircraft without specific



FIGURE 43  
Resonant fatigue machine and electronic control equipment shown installed in special research test room constructed inside the east warehouse. Circa 1967.

data on expected airframe life. We still do." That last sentence quoted was only partially true. The Air Force with its current approach to fatigue flight safety has a much higher confidence level because of its structural integrity programs.

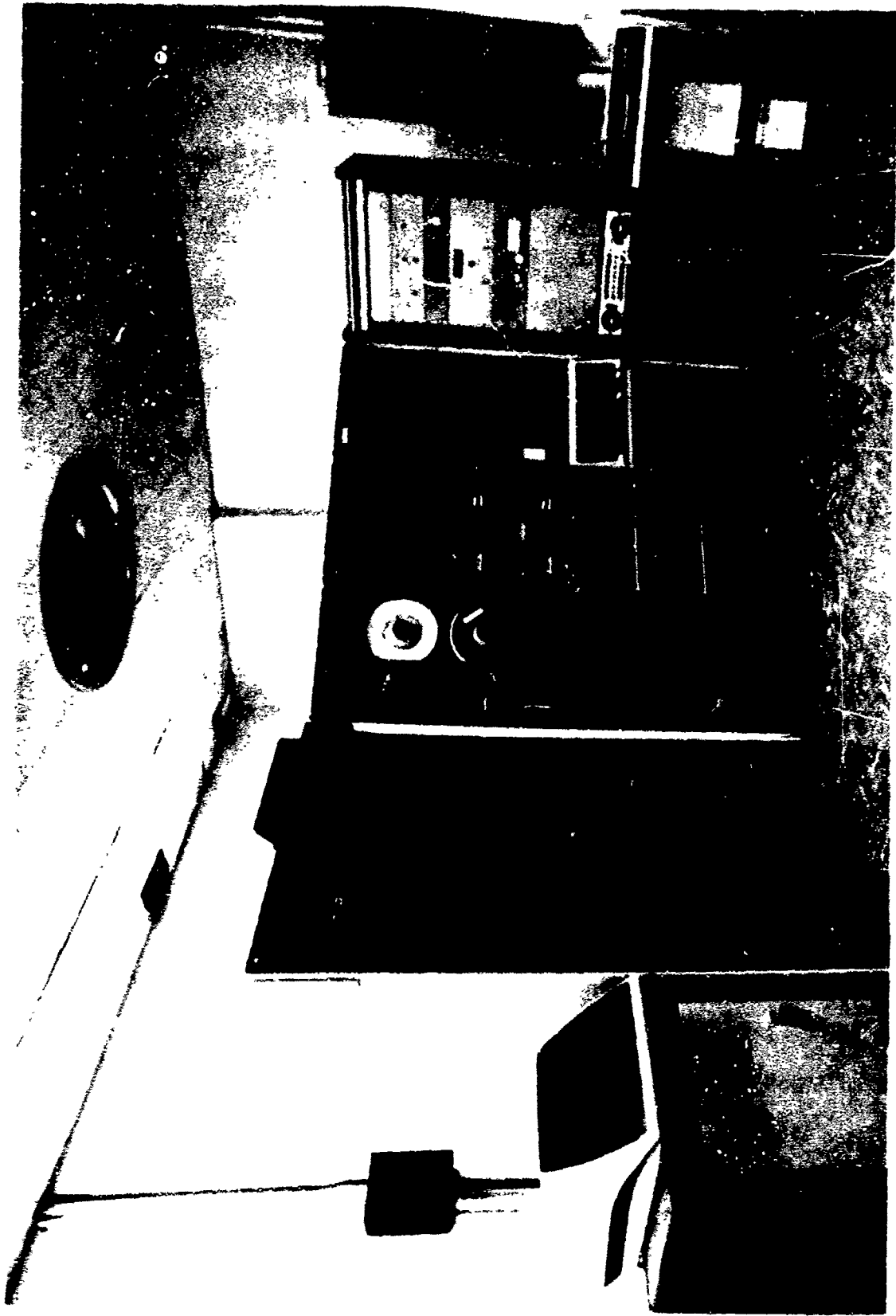

FIGURE 44

The Digital Equipment Corporation PDP-11/40 Minicomputer System used to fatigue test the F-4C/D structure for 16,000 hours during the 1974-79 time period. It had been previously tested for the Navy to 8000 hours using a different structure.

and development necessary for aerodynamic heating simulation. A Test Methods Unit was established for that purpose, and to establish criteria for the design, construction and operation of a larger facility to test full scale aircraft.

Two distinct heating conditions result from aerodynamic heating-- steady state (equilibrium) and transient. The most difficult to duplicate in the test laboratory was transient heating and/or cooling which required that the flight loads also be simulated as a function of time.

The first problem was in understanding the physical phenomenon of aerodynamic heating where the air velocity reached zero on any part of the leading edge or nose structure and caused the highest surface temperature called the stagnation temperature. On a wing, for example, all other points on the structure had a variation of temperature chordwise and spanwise. The same was generally true for other parts of the airplane. Solar radiation added some small amount of heat to the structure at high altitude. Engine heating could also add to the structure's temperature.

Aerodynamic heating results from adiabatic compression of the still air as it approaches the airplane's speed; it causes friction heating within the boundary layer as the air molecules on the skin accelerate adjacent layers to the airplane's speed. The boundary layer temperature is a function of the stagnation temperature. The skin temperature varies with temperature of the air next to the surface and the convective heat transfer coefficient, and is always less than the stagnation temperature during accelerated or constant

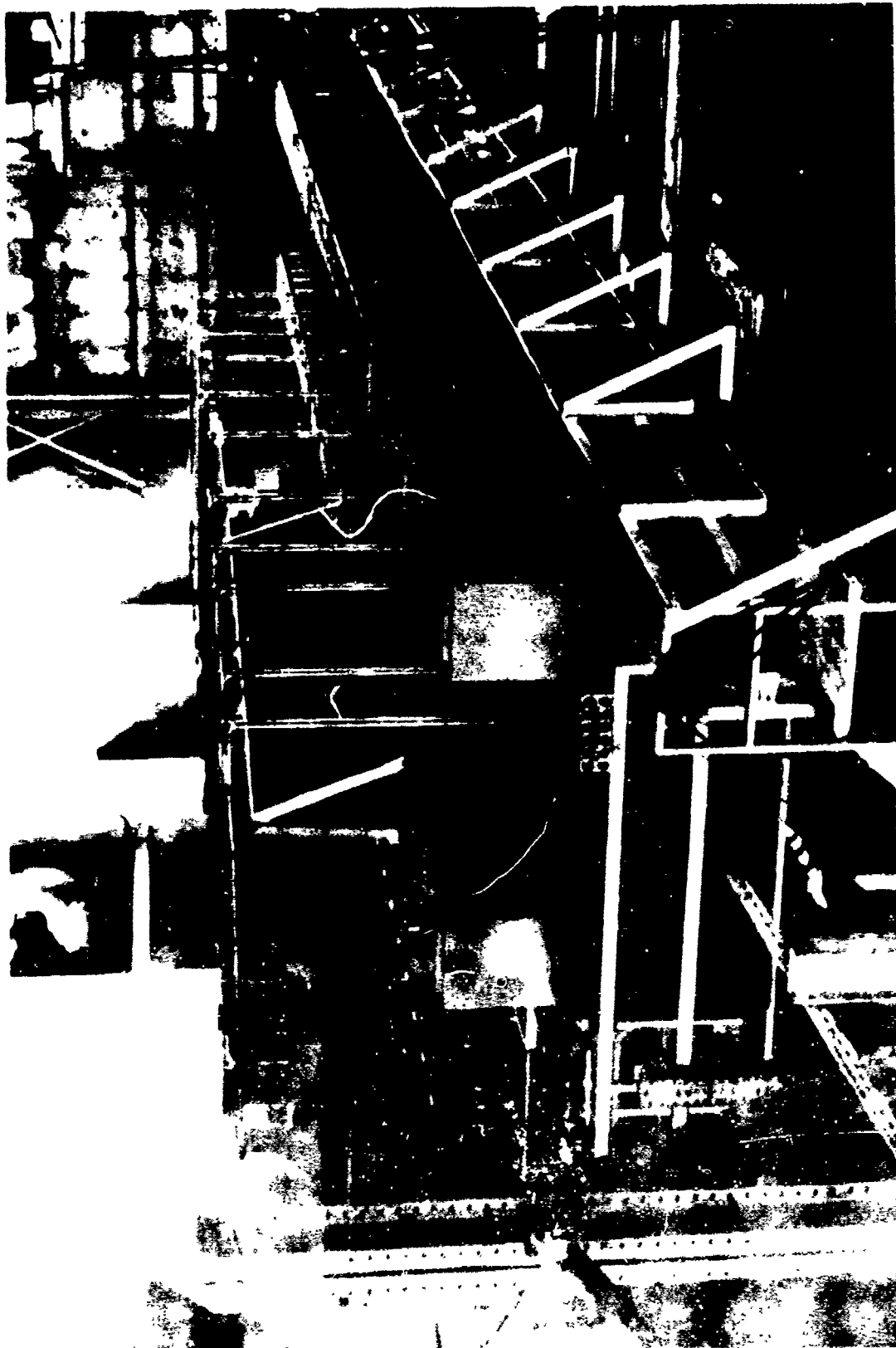

FIGURE 45

... temperature ... plant and Research, Inc. regulator and controller installation for ...  
... methods development located in the northwest corner of Building 65 at ...  
... Wright Field in the late 1950's

and development necessary for aerodynamic heating simulation. A Test Methods Unit was established for that purpose, and to establish criteria for the design, construction and operation of a larger facility to test full scale aircraft.

Two distinct heating conditions result from aerodynamic heating-- steady state (equilibrium) and transient. The most difficult to duplicate in the test laboratory was transient heating and/or cooling which required that the flight loads also be simulated as a function of time.

The first problem was in understanding the physical phenomenon of aerodynamic heating where the air velocity reached zero on any part of the leading edge or nose structure and caused the highest surface temperature called the stagnation temperature. On a wing, for example, all other points on the structure had a variation of temperature chordwise and spanwise. The same was generally true for other parts of the airplane. Solar radiation added some small amount of heat to the structure at high altitude. Engine heating could also add to the structure's temperature.

Aerodynamic heating results from adiabatic compression of the still air as it approaches the airplane's speed; it causes friction heating within the boundary layer as the air molecules on the skin accelerate adjacent layers to the airplane's speed. The boundary layer temperature is a function of the stagnation temperature. The skin temperature varies with temperature of the air next to the surface and the convective heat transfer coefficient, and is always less than the stagnation temperature during accelerated or constant

ADIABATIC WALL TEMPERATURE vs MACH NUMBER

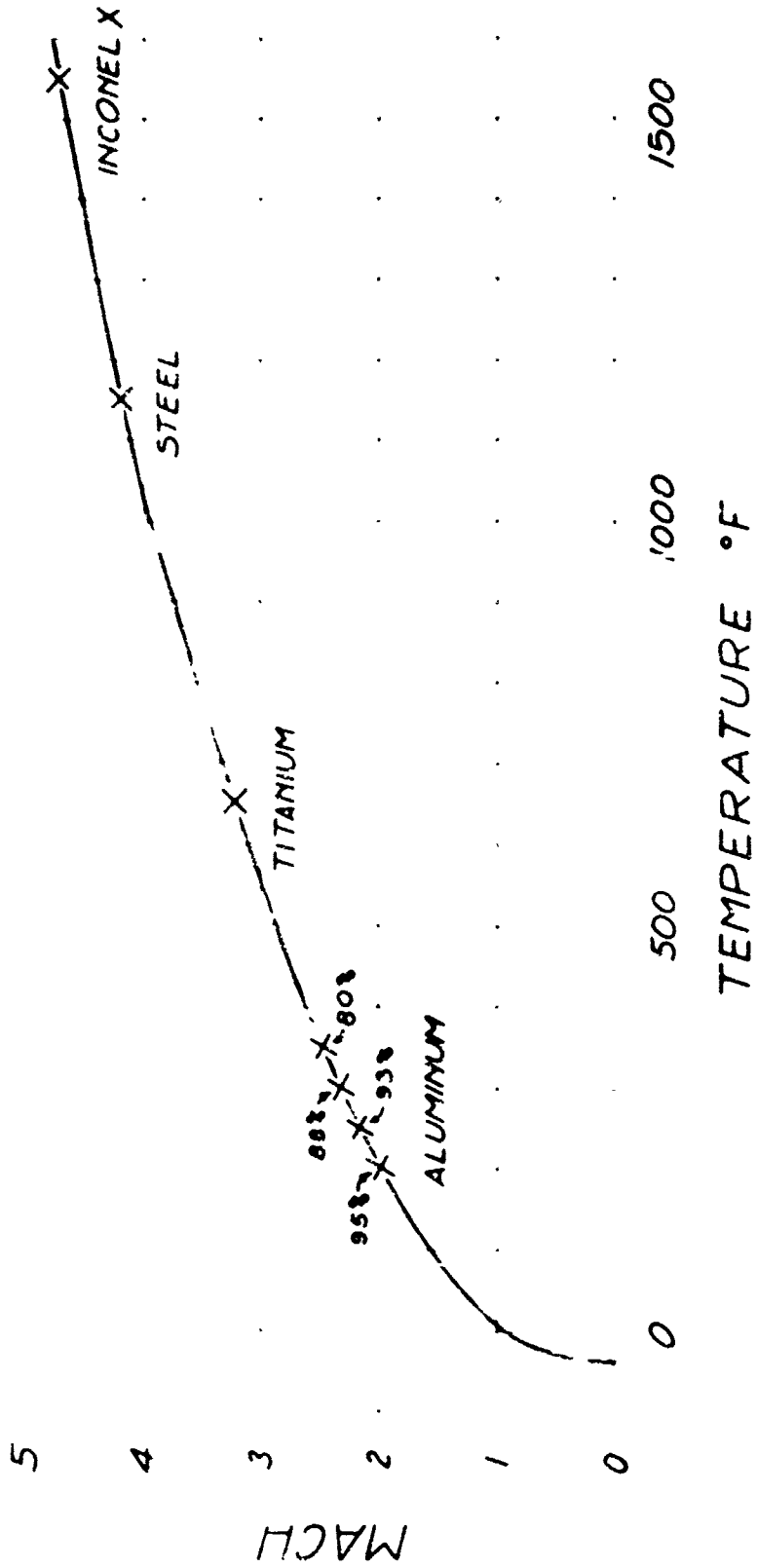

FIGURE 46

Graph shows adiabatic wall temperature versus Mach Number for various structural materials with strength reduction at temperature for aluminum.

speed flight. As the airplane decelerates, the boundary layer heat transfer coefficient reverses its effect and begins to cool the skin. The skin temperature can sometimes be higher than the stagnation temperature.

Transient heating or cooling can be so severe that the differential expansion or contraction fails structures, without consideration of an aerodynamic or mechanical loading. As the internal temperature begins to match the external temperature and approaches an equilibrium condition, these stresses are minimized.

The job of simulating aerodynamic heating was a new challenge for the structures organization and required new test methods and innovation. One major problem was in selecting energy sources for elevated temperature test simulation. Radiant, conduction, convection and induction (radio frequency) were considered and research studies were made concerning the practical application of each.

Several research contracts were awarded to universities, and at the same time an Air Force effort was started by Wright Field structures engineers. Convection heating was eliminated from consideration early in the research because of the difficulty in producing high temperatures and in controlling the flow of heated air to match temperature profiles.

Radiant and conduction heating appeared to offer the best chance of success for low heating rates, and induction for higher heating rates. In the beginning, most of the research effort resulted in learning what could or could not be done while the requirement to test structures was faced immediately by Wright Field engineers.

Conduction heating methods were believed best initially for providing uniform heating to satisfy equilibrium conditions resulting from long flight duration at supersonic flight speeds. The University of Colorado investigated these methods using silicone rubber for the tension patch (6 x 6 and 6 x 12 inches patterned after the existing sponge rubber loading patch method size used at that time) with nichrome ribbon as the heating element. They were estimated useful up to 500 degrees Fahrenheit at 20 psi load. This loading and heating method had several obvious limitations and while there was limited success in the research and development, these patches were never able to be effectively used for elevated temperature test purposes.

Electrical heating blankets showed less promise. Their maximum operating temperature was only 500 degrees Fahrenheit. Graphite heating blankets were developed later for higher temperatures, but were never considered for use in structural testing.

Radiant energy heats by wave motion even in a vacuum. A very high source temperature of nearly 6000 degrees Fahrenheit was available in special infrared heating lamps using tungsten filaments. This method showed great promise for high heating rates in transient heating simulation. The primary problem in the energy transfer was related to the surface emissivity. A highly polished surface was desirable in flight, but in the test laboratory a black surface was necessary to improve energy transfer, to cut costs of the operation, and provide for the maximum possible heating rates from high transfer efficiency. Therefore, methods were studied to provide for high conductivity in the test laboratory.

Many commercial electric heaters were available at that time which were made of nickel-chromium wire and glass enclosed tungsten filament lamps. The ratings were engineered for use by the general public. It was found that these heaters would operate at several times their rated voltage for limited periods of time and provided high flux densities long enough to heat airplane and missile structures satisfactorily. Even the cheapest and most efficient method of aerodynamic heating simulation proved to be very costly.

The attractiveness of radiant heating was in its usage of electricity, its simplicity of control, and the fact that any number of individual heating zones could be designed to provide different power output for simulating the large number of different temperature profiles. Power control could be regulated to provide any precise temperature using thermocouples for temperature measurement and feedback in a control zone. Infrared heating lamps were thought to be limited to only 10 degrees Fahrenheit per second rise rate on test structures. Induction heating methods were expected to provide the higher heating rates. The Westinghouse 200 KVA radio frequency generator used by the University of Florida under contract with the Air Force, produced high flux densities, but the work coil and dielectric material did not meet expectations. Temperature requirements over 2000 degrees Fahrenheit on the work coils for satisfactory use were never met. When applied to actual test operations it was necessary to use a large bulky load matching network at the structure for each load channel with the entire test operation inside a steel radio frequency barrier. Radio frequency heating methods were too cumbersome and impractical to use

for structural testing.

A Phase 3 induction heating contract called for 40/250 KW radio frequency power channels for aerodynamic heating simulation at a cost of \$3,700,000 and \$475,000 for Heat Control Computer Number 3. As the cost of the development effort and inflation increased, the number of power regulators were reduced to stay within the scope of the original contract dollars. By the time it was finally realized that radio frequency heating would not do the job, it was too late to cancel it. The end result was that one 250 KW power control channel was installed on the fourth floor of the elevated temperature building at a final cost of \$2,200,000. This one unit was never used. It was declared surplus in 1974 and removed in 1975 and transferred to the Air Force Materials Laboratory for special materials research.

Elevated temperature loading methods also commanded a lot of attention. The conduction heating patch, if successful, would have eliminated many of the problems. Whatever structure was heated also had to be loaded and the two could not be effectively combined for elevated temperature structures testing.

High temperature transient flight conditions having rapid loading conditions were envisioned for the high speed aircraft. This required simulation of a very rapid load at a precise time in the flight load profile which was superimposed on whatever load then existed. This flight requirement never materialized, but temperature and load profiles as a function of time throughout the flight mission profile were duplicated in the test laboratory quite well.

Harper Engineering was awarded a contract to provide 30 channels of load equipment with a maximum capability of a 25,000 pound load through 25 inches deflection in 0.1 second. Delivery was scheduled for July 1955, but the requirements could not be met.

Another loading development contract was awarded to Compudyne Corporation to develop 50 channels of rapid loading equipment of similar capability. The maximum load ranges specified were 1,000, 6,400, 15,000 and 35,000; deflections of 10, 15, 20, and 25 inches; maximum load velocity of 75 inches per second; and programming provisions to accept the Heat Control Computer Number 1 which was furnished with the interim elevated temperature facility in 1959, but first scheduled for 1957 operation. Appropriate servo valves, hydraulic actuators and strain gage load sensors (load cells) for closed loop control were required. When that contract was finally closed out, the equipment delivered provided 50 channels usable only for fatigue testing. This equipment was used for many years before being replaced by more stable solid state electronic controllers.

Some research and development work was done for methods to cool hydraulic cylinders in a high temperature test environment. Some hardware was delivered, but methods to cool the loading cylinders proved impractical, and the actual need never materialized. Once a suitable heat lamp-reflector assembly was developed, the hydraulic cylinders were outside the reflector area and never overheated.

Engineers believed that the most practical method to simulate aerodynamic heating was with a computer operating on the aerodynamic heating equation. Reduced to its simplest form it was  $Q=HA(T_{aw} - T_s)$ .

The  $h$  represented the convective heat transfer coefficient,  $T_{aw}$  the adiabatic wall temperature, and  $T_s$  the skin temperature at any point in time. A computer was developed to simulate this equation. It provided voltage signals to a temperature regulator/controller which compared the thermocouple feedback signal voltage and an error signal was produced proportional to the temperature mismatch until a zero error signal resulted.

The pilot plant, without the computer, could provide set point control for a slow rise rate to equilibrium temperature. Skin temperature versus time could not be provided with the computer. Simulation of the skin temperature as a function of time was not acceptable then, as it supposedly only verified the structure for a temperature which was based on analysis. There was not enough analytical analysis and theory developed to prove or disprove the accuracy of such methods for skin temperature calculations. This finally became the accepted method when it was proven that calculated and actual flight temperature did match with good accuracy.

As a lack of evidence and experience with analytical methods compared to actual flight temperatures were not available at the time, it was necessary to provide for computer aerodynamic simulation. A contract was awarded to Research, Incorporated for the design, development and fabrication of 40 electronic control computers (analog controllers) to satisfy 40 channels of temperature zone control. An earlier prototype model indicated an accuracy of 95 percent, or better, which satisfied the requirements for elevated temperature testing.

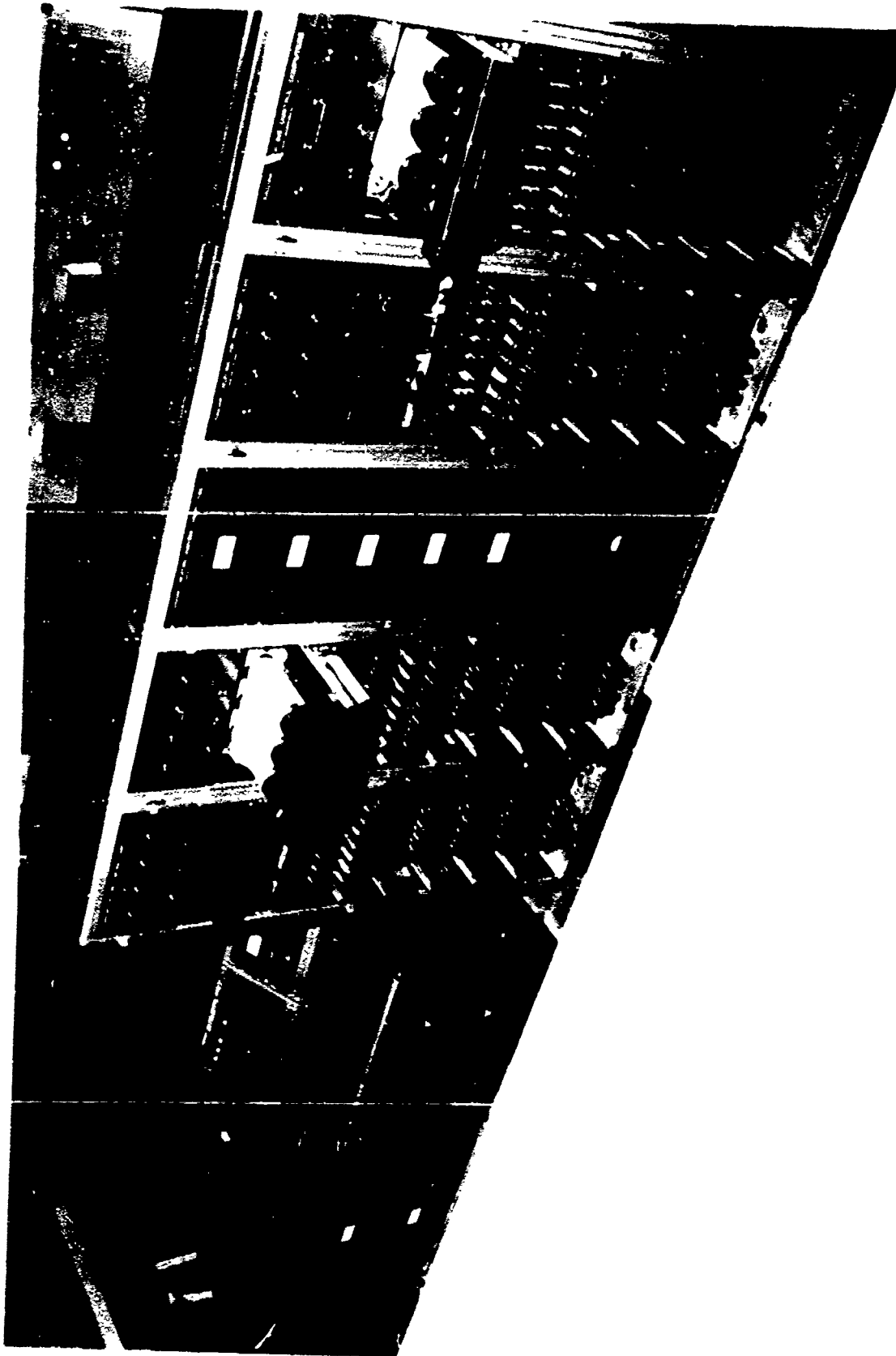

FIGURE 47

The Pilot Plant 40 channel control computers with console for elevated temperature testing were purchased from Research, Inc. and delivered in 1956.

By the time the 40 computers were delivered and checked out, the interim elevated temperature test facility was ready to be checked out. It had a Heat Control Computer (Number 1) supplied on that contract built by General Electric, Phoenix with an expanded equation for closed loop heat control using a convective heat transfer coefficient, and capability for derivative mode, power mode, and time temperature mode.

While the facility engineers were working to get the equipment installed and operational, as with the 3000 KVA pilot plant in 1955, the delays impacted high priority test structure schedules. As a consequence, the engineers responsible for research and development of test techniques were forced to use whatever equipment was available at the time and begin conducting elevated temperature test programs. The untried and unproven test methods, less than ideal at the time, were used and thus caused less emphasis to be put on test methods research and development.

On a contract with Research, Incorporated, 20 structural test specimens were designed and fabricated for in-house research on elevated temperature heating methods. They were constructed from titanium, Inconel, mild carbon steel, 24 ST alclad aluminum alloy, 75 ST alclad aluminum alloy and corrosion resisting steel. This laboratory test research work was never completed, but the test specimens later proved useful in checking the operation of the Heat Control Computers for different specific heat values and emissivities. They were also useful in developing high temperature reflector configurations, optimum control zone layout, power regulator stability,

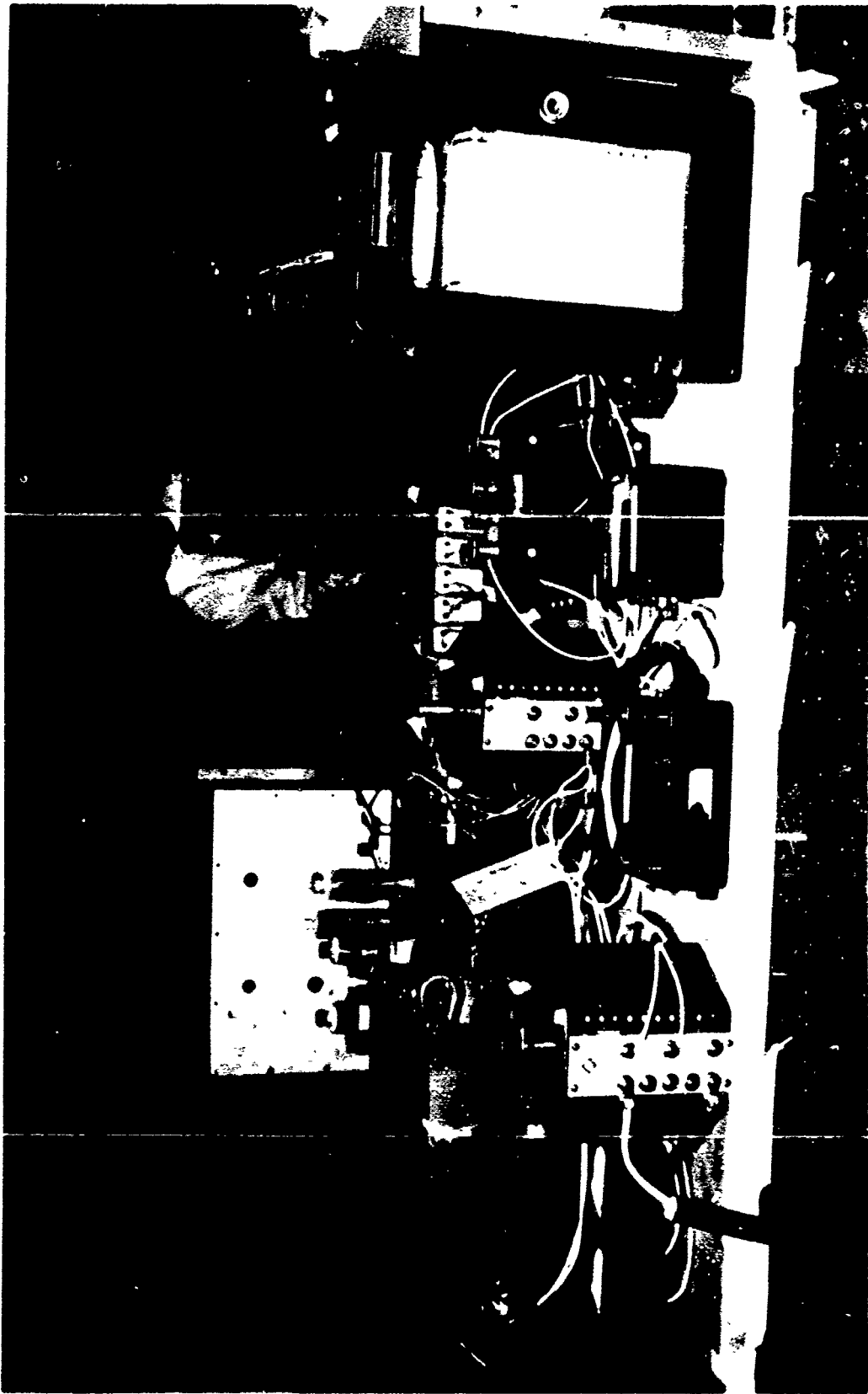

FIGURE 48

Power control equipment used in early elevated temperature tests prior to the pilot plant installation in 1955 which used saturable reactors at Wright Field.

heating efficiency, and for determining adverse effects from convection heat relative to specimen orientation and many other things essential to elevated temperature test operations.

For exposed heating simulation, nickel-chromium element heaters built in the laboratory were evaluated and used for some testing. The heating elements were operated at 2200 degrees Fahrenheit for long periods of time involving simulation of low heating rates and provided very uniform heating, but were not satisfactory for the high heating rates

Electric ovens were used in 1953 to test small components for constant structure temperature, research on high temperature strain gages, thermocouples, silicone rubber tension loading pads and human endurance in temperatures up to 450 degrees Fahrenheit.

General Electric (GE) T-12 tungsten lamps were first used to heat a supersonic fighter wing. These lamps provided the 10 degrees per second heating rate required. On this particular structure, the heating setup was capable of even higher rise rates.

The GE T-12 radiant heat 2500 watt, 110 volt tungsten filament lamps were one and one-half inches in diameter, 14 inches long and had a screw base. At overrated voltage the life of this lamp was approximately ten minutes. They proved too difficult to work with.

A more practical heating lamp was the GE T-3 quartz tubular infrared lamp, three-eighths inch diameter with a tungsten filament 10 inches long, rated at 1000 watts and 230 volts. While the GE T-3 lamp was normally rated at 1000 watts at 230 volts, it could be used for short periods at double rated voltage. When ready to fail, the

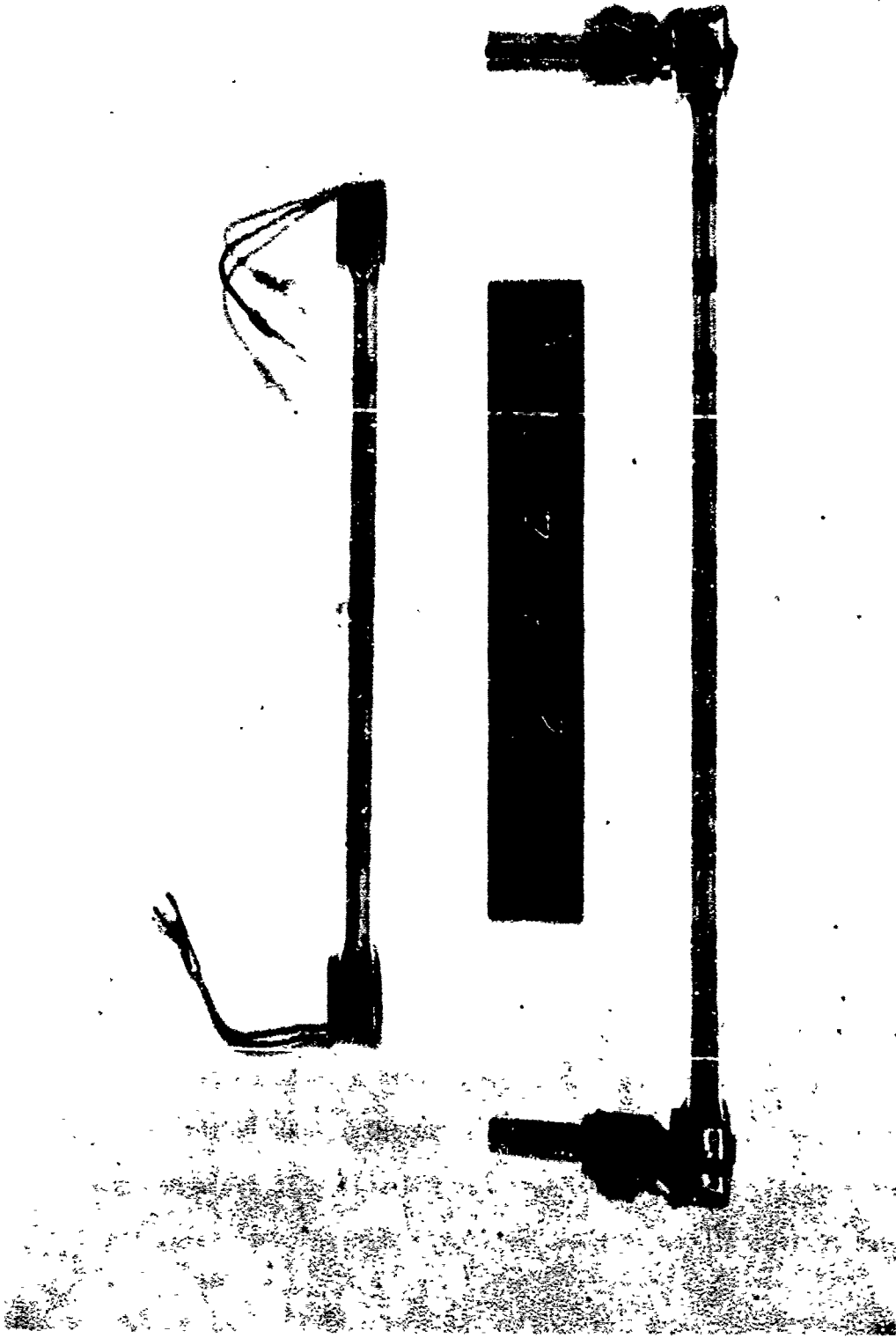

FIGURE 49

General Electric T-3 infra-red radiant heating lamps used for elevated temperature structures testing in the 1950's. The end clips were designed by the electrical foreman in Building 65.

lamp envelope would soften and the lamp would explode, usually causing a chain reaction and breaking other lamps. Cold water could be sprayed on the lamps while operating without causing failure. Whenever connected in a three phase delta electrical connection, the open reflector terminals were not hazardous using the pilot plant electrical system. These lamps were ideal for modular configurations where the lamps could be spaced very closely and could be double stacked. Clips that bolted to the sheetmetal reflector were developed in the laboratory which made assembly and wiring simple. They could be connected easily in series-parallel or parallel circuits. The lamp-reflector units could be placed the required distance from the surface and the reflector surface contoured to it.

The first elevated temperature test simulation with rapid loading was done on the Hawk missile using GE T-3 quartz lamps. Load application was with quartz conical compression washers two inches in diameter at the base, one inch in diameter at the top and one inch high. A hole through the center provided for a flexible steel cable to be threaded through, having an end swaged ball which fit into a rounded seat at the top. Holes were drilled through the structure and the cable-quartz washer combination threaded through and loaded in tension. Research on this quartz compression loading washer indicated that thermal shielding would be minimal and would not affect the temperature distributions. These quartz washers were not practical for general test work because drilling through the structure possibly altered its strength characteristics and they were prone to chip and break.

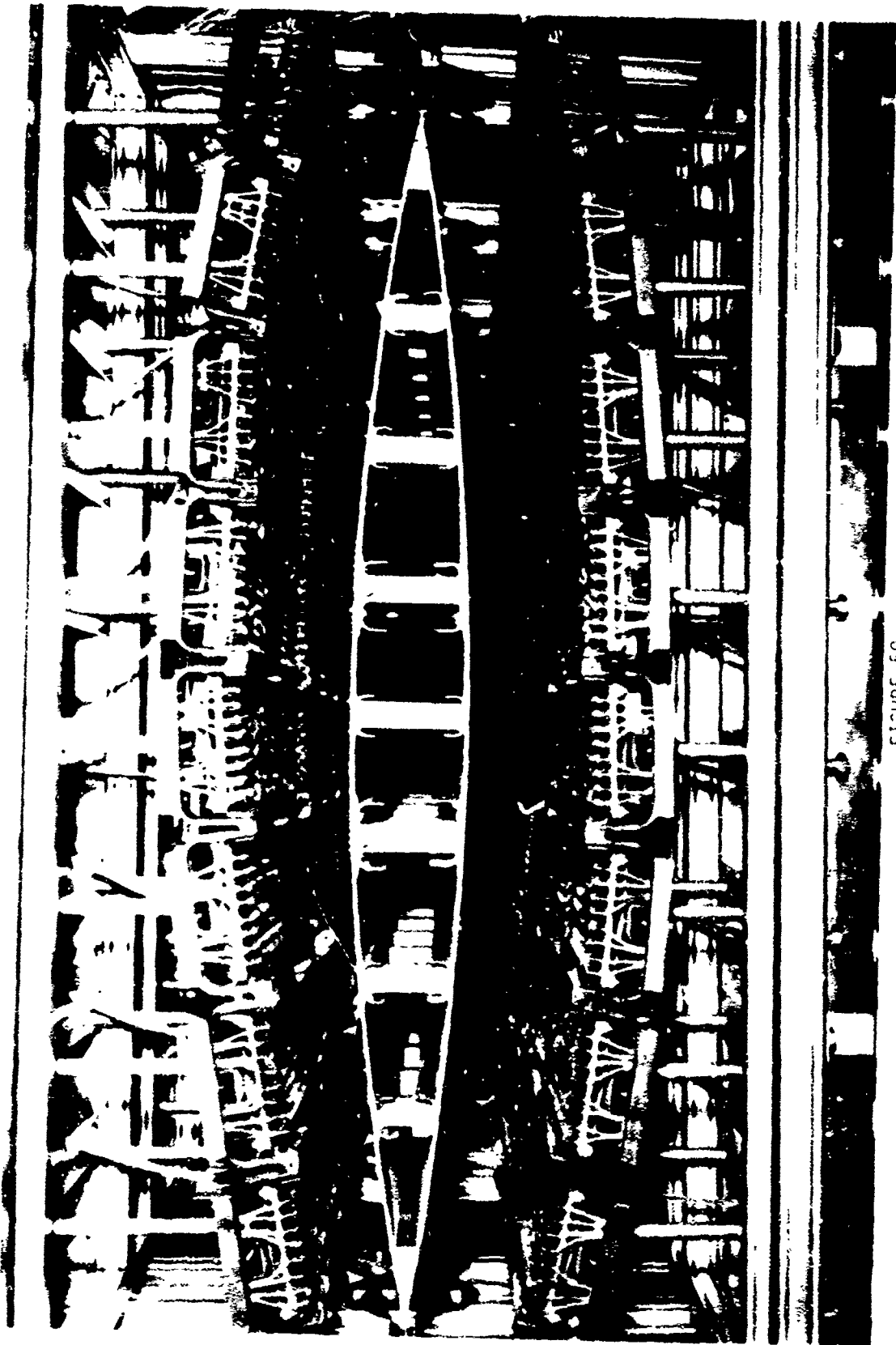

FIGURE 50

The first radiant heating oven built at Wright Field which used Research, Incorporated modular 6 by 12 inch convection cooled reflector units in elevated temperature research test methods.

Research, Incorporated was awarded a contract to develop and build modular natural convection cooled aluminum reflectors using the GE T-3 quartz tube lamps. Later, they developed the same configuration for water cooling the reflector material. The Research reflector was 6 by 24 inches with 16 GE T-3 lamps installed, but it could be used with any number less than that for lower temperature simulation.

An open oven for just one surface, using 80 Research reflectors, was built which allowed adjustment of each reflector in a chordwise and vertical direction. This was used for evaluating heating efficiency at 460 volts on an aluminum specimen coated with a solution of granite in lacquer. An efficiency of 65 percent was obtained. Practically, efficiencies this high were difficult to obtain on most test operations. Test efficiency runs were necessary using the identical test set-up prior to testing, but the actual structure could not be used and structures were simulated for pre-test heating work for lamp-reflector designs.

A large number of research convection cooled reflectors of 6 by 12 inches were obtained for the B-58 test program. Most of the structure was heated using large aluminum sheet material, as reflectors, tailored to provide specific temperature profiles, and power requirements to maintain the required temperature with area parallel thermocouples for feedback control to temperature controllers.

Reflectors absorbed heat from radiation, conduction and convection and in most test applications special provisions were made to cool the reflector material, lamp envelopes or lamp end seals and supports. Water and liquid carbon dioxide were used for the

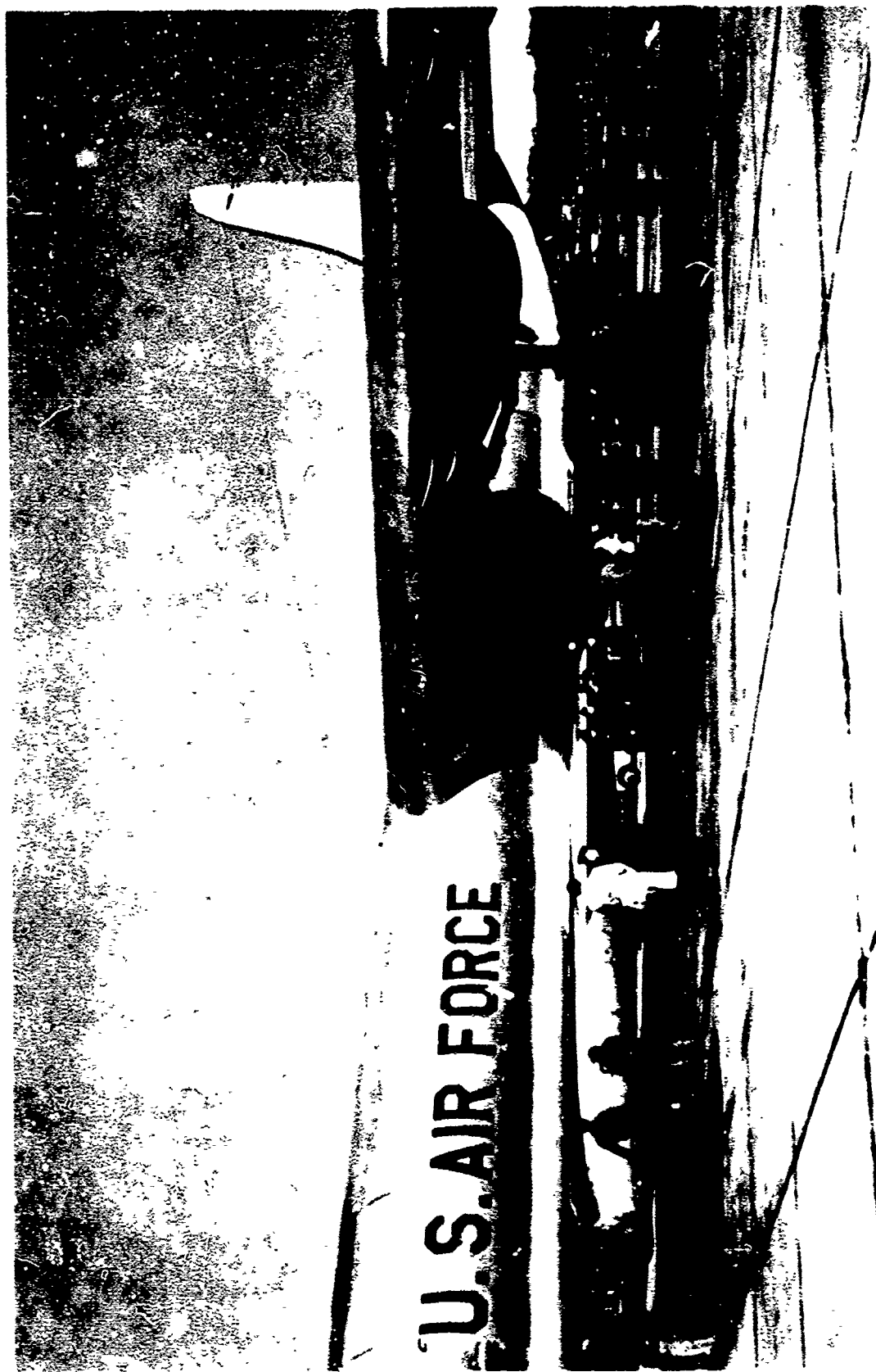

FIGURE 51

Aircraft for structures testing were brought into Building 65 by truck, by rail behind Building 5, flown to Patterson Field and towed on Route 444, flown in, brought in by cargo airplanes or in this unique manner where the B-58, with vertical tail removed, was tucked into the bomb bay of the B-36 airplane and landed at Wright Field in 1957.

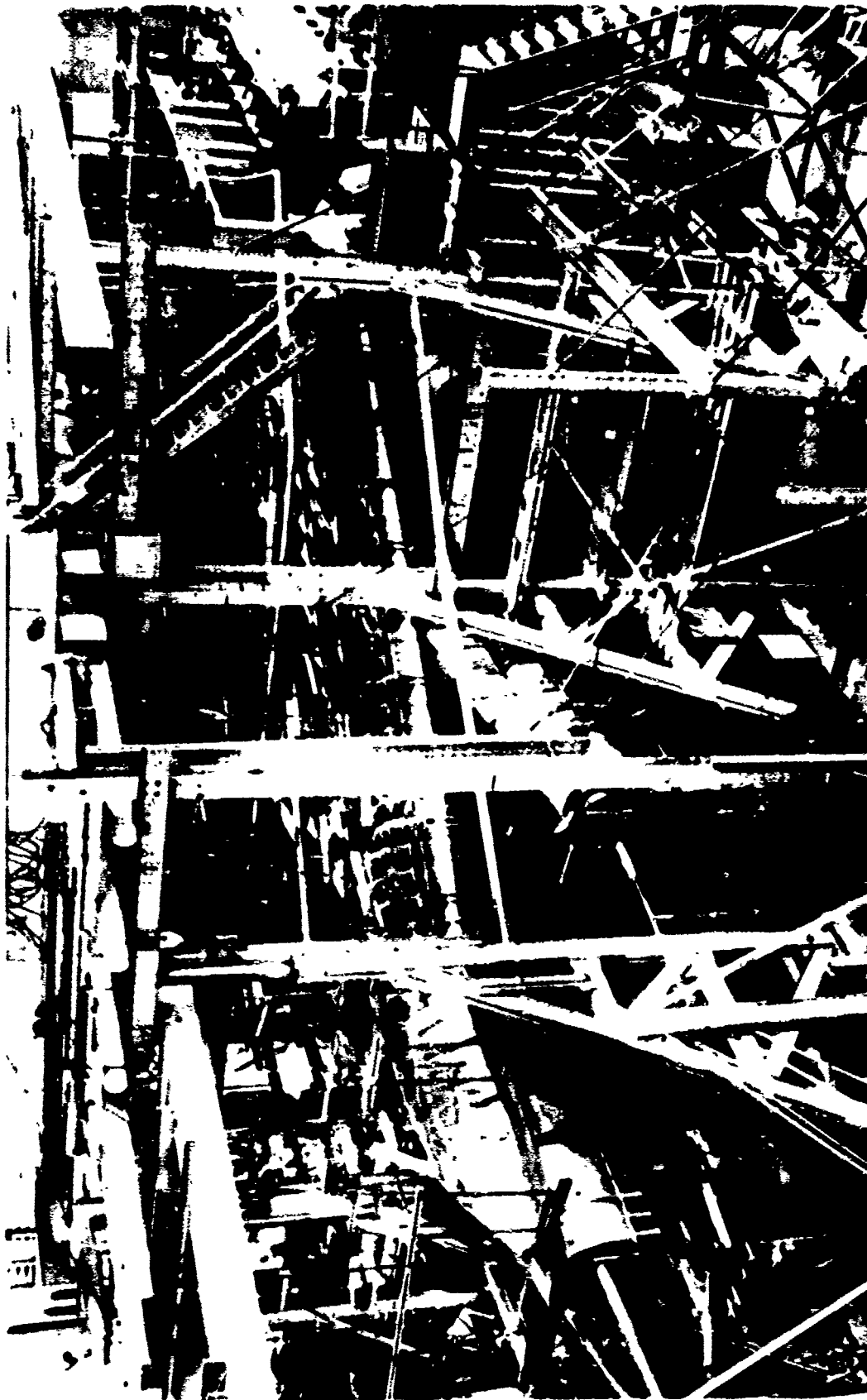

FIGURE 52

The B-58A static test program conducted at Wright Field was the first full scale airplane tested at elevated temperatures and with simulated fuel in its tanks - 1957 - 1962.

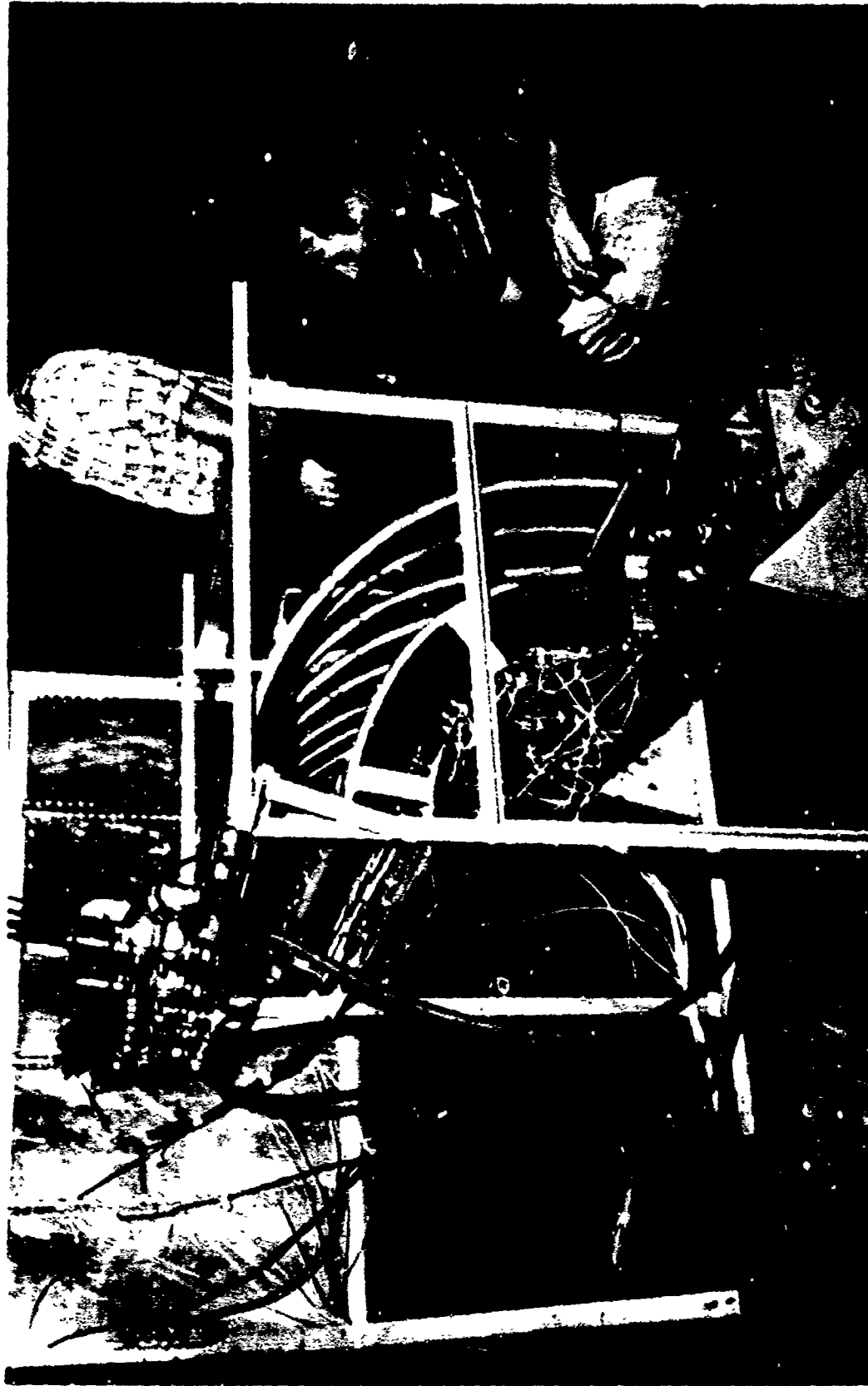

FIGURE 53

The B-58 nacelle honeycomb sandwich structure panel set up for developing heating and cooling methods in 1958. The internal test temperature was 706 degrees and the external temperature was 213 degrees Fahrenheit on the actual test condition. Cooling of the external skin structure was with compressed air.

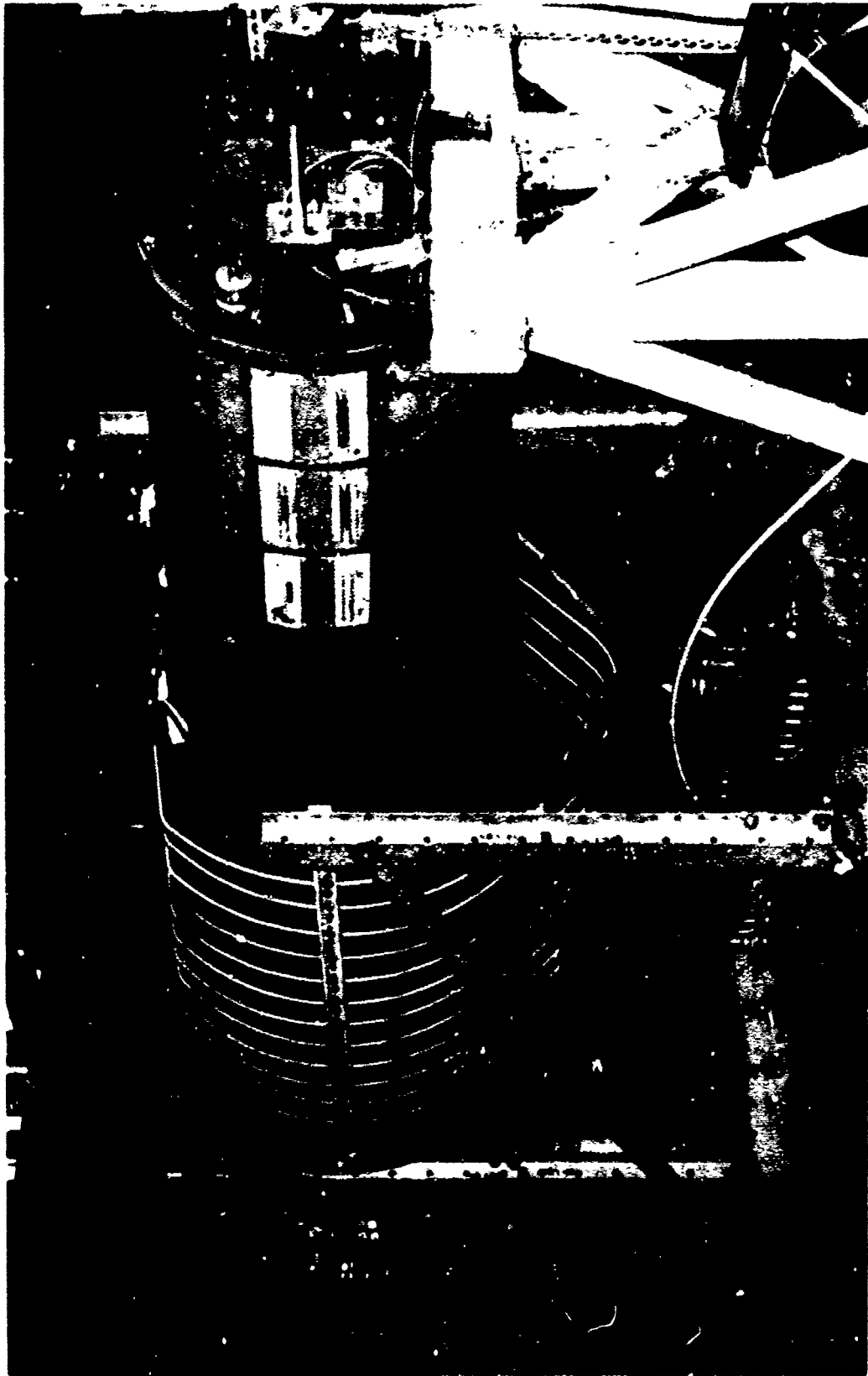

FIGURE 54

Test method development setup for simulating external surface aerodynamic heating and engine heating internally on the B-58 engine nacelles in 1958. Tests were successfully conducted with the engine nacelles installed on the airplane.

aluminum and steel reflector heat exchanger types and air for lamp cooling in the ceramic reflectors. Gold coated stainless reflector material was not cooled unless the temperature exceeded the lamp capability and then the lamp envelopes were air-cooled. In some cases, liquid nitrogen was converted to a cold gas for reflector and lamp cooling resulting in higher performance and extended lamp life.

End seals on the GE T-3 lamps caused problems by melting. Once that problem was solved, the lamps could be used at 530 volts for reasonably long periods of time for very high heating rates and high equilibrium temperatures. This and other improvements enabled radiant heat equipment to be used for simulating nuclear heating effects on structures by providing a very high thermal pulse in a very short time cycle.

Whenever the quartz envelope became too hot and softened, it would sag and fail, sometimes exploding. General Electric developed the iodine cycle lamp which provided longer life for the quartz envelope, but the problem of flying glass was not eliminated completely until the bromine cycle lamp replaced it. With that development, test temperatures in excess of 3500 degrees Fahrenheit could be maintained for short periods of time, but good testing was not possible since thermocouple materials were not reliable much above 3100 degrees for control temperature measurements.

These new developments allowed 40 GE T-3 lamps to be installed in one square foot of reflector giving an output of approximately 240 BTU's (6KW/lamp) for short periods of time to satisfy a nuclear heating pulse. With the development of thin strip graphite heaters,

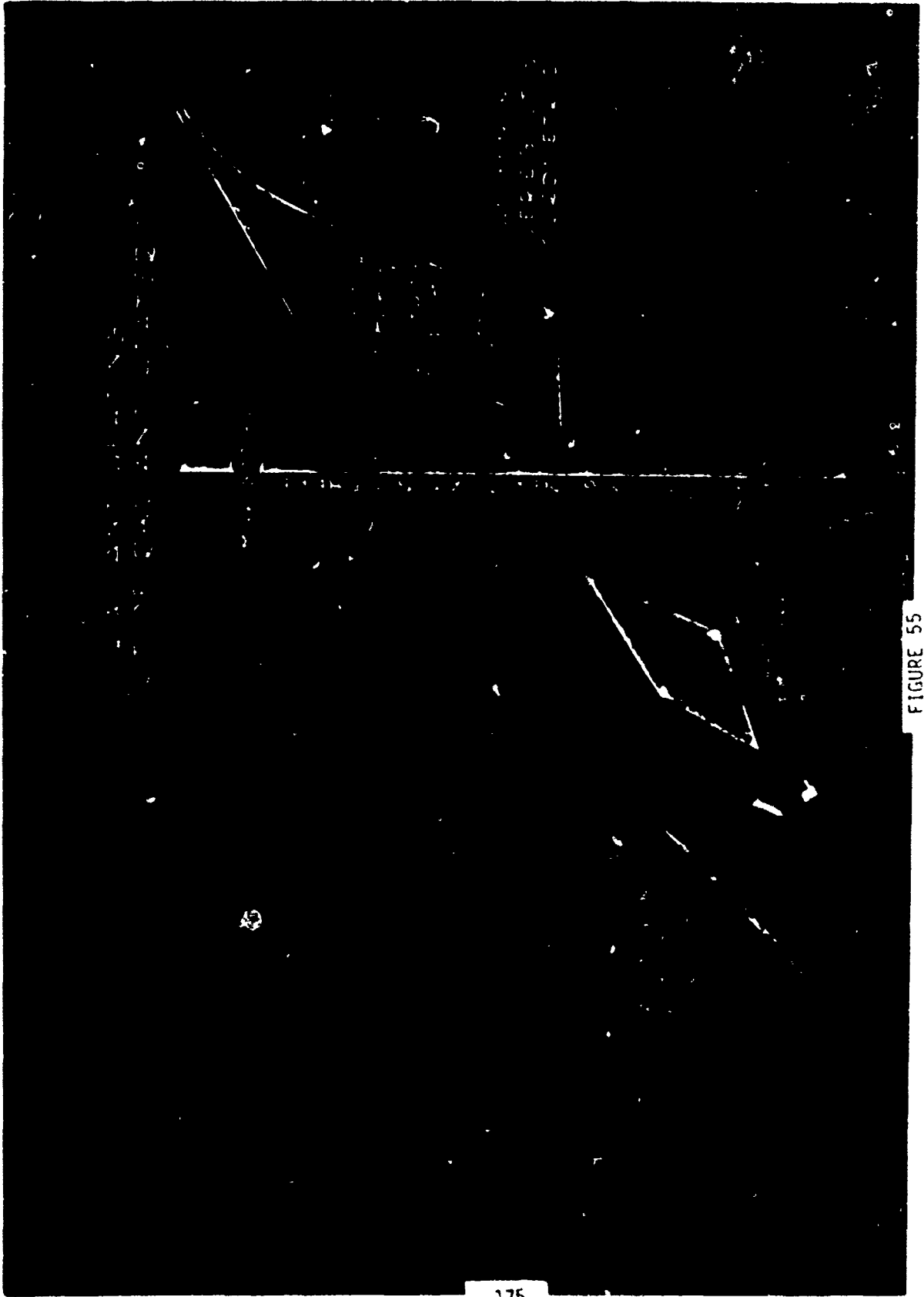

FIGURE 55

Graph shows the relative cost of radiant heating reflectors for elevated temperature structures testing in the 1960's at Wright Field.



FIGURE 56

The glowing Hot Structure lower surface elevated temperature radiant heating with cooling of the  
pipes and reflector surface using carbon dioxide (vaporized liquid) at Wright Field in 1960.

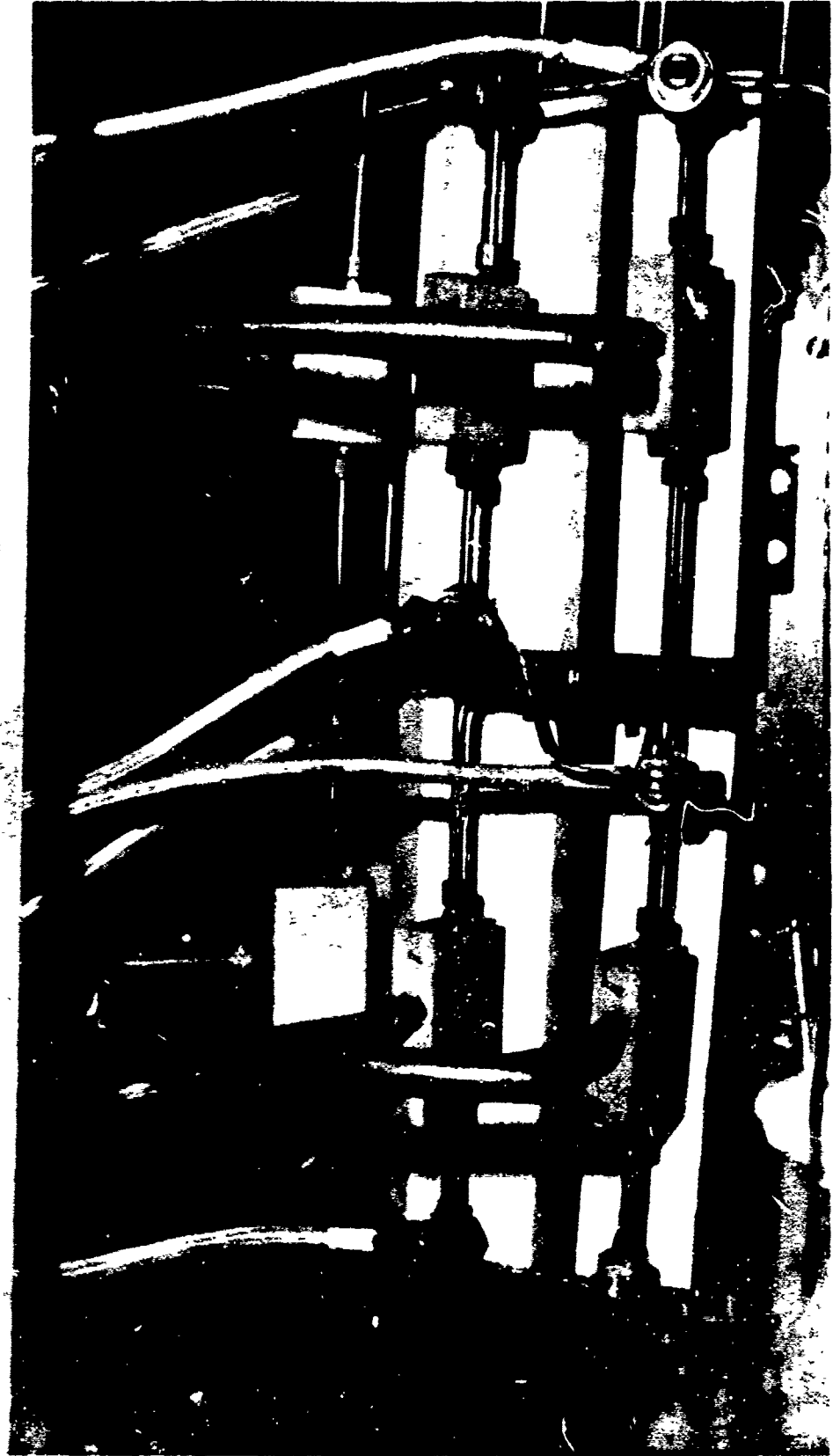

FIGURE 57

Controlled Pyrometric reflector unit and high temperature electric wire for radiant heating to  
per 3000 degrees Fahrenheit.



FIGURE 58

Elevated temperature test of di-boride ceramic nose cap shown undergoing 3000 degrees Fahrenheit at Wright Field in 1973.

as much as 350-420 BTU's per square foot were obtained for longer time periods. In 1969, a shutter was made to cover the graphite until it reached the described flux density. The shutter was then opened and closed for simulation of nuclear heating effects.

Power could be regulated to provide any precise temperature at one point in the control zone using thermocouples or fluxmeters. The principle method for measuring temperature and controlling power to each control zone was with the use of thermocouples. Fluxmeters were valuable for simulating nuclear heat effects on structures; however, thermistors were of no real value in elevated temperature testing.

The first method for installing thermocouples was done by drilling a small hole the size of the two thermocouple wires fused together to form a junction, inserting the junction into the hole and peening the edge. It worked well, but there were problems since installation was very time consuming and on very thin material it was not practical.

The University of California developed a method for flash welding the thermocouple wires directly to the specimen material in the early 1950's. It was done with a small capacitance type welder which supplied the necessary instantaneous current for fusing the wire to the specimen. Iron and Constantan wires were generally used for temperatures to 1000 degrees, chromel alumel to about 2000 degrees and above this temperature the exotic and noble metals were used. It was possible to melt platinum thermocouples when using the GE T-3 lamps in high power density configurations.

Efficiency tests of radiant heating setups were necessary to determine power levels, to design reflectors and to control the

### EQUILIBRIUM POWER CURVES FOR SIMU- LATIVE TEST PANEL AND ACTUAL TEST STRUCTURE

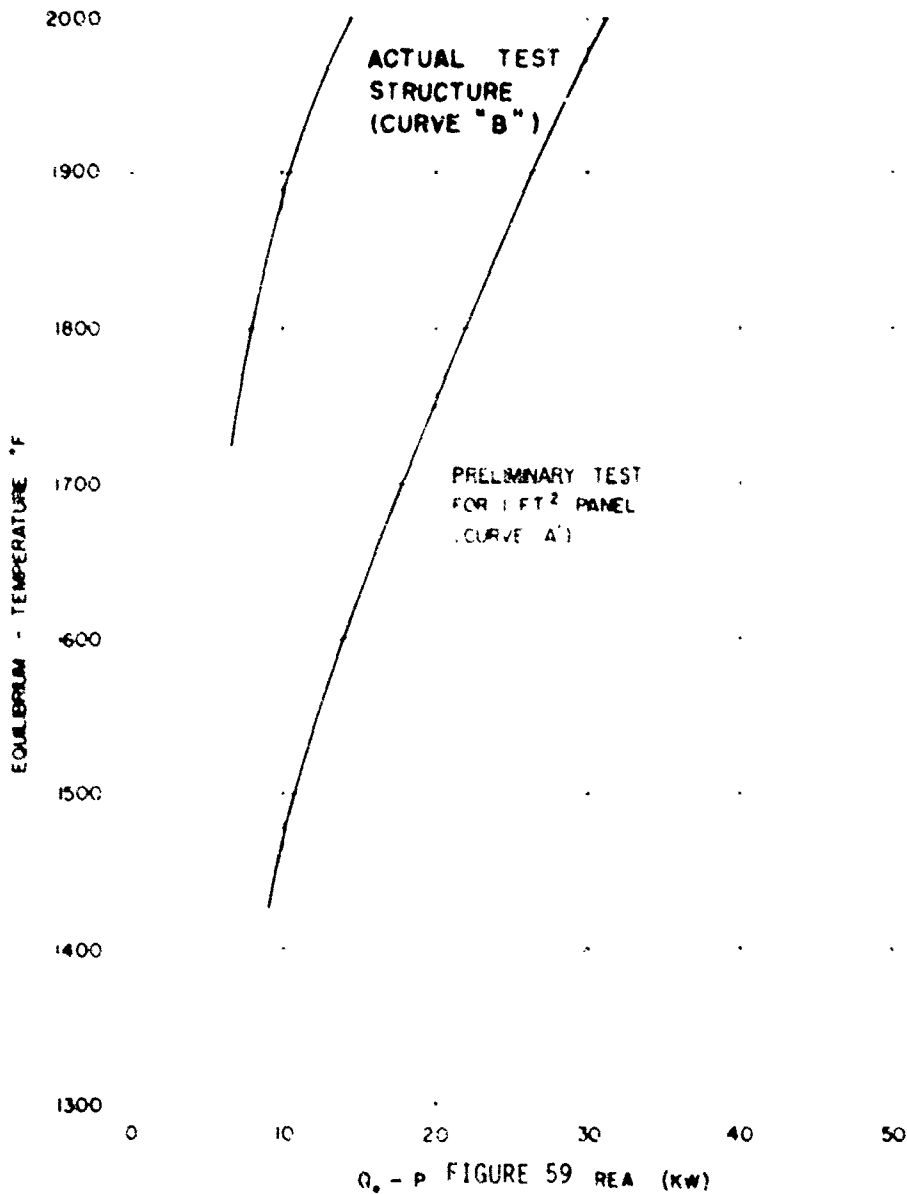

Test data for elevated temperature power requirements shows that power data on a small test panel used to simulate the structure is too conservative. Excessive power capability made it difficult to protect the structure against over temperatures.

test structure. This data raised some doubts that the aerodynamic heating equation was the best, or only way to simulate laboratory heating, since efficiency, specimen orientation, specimen emissivity and secondary heating effects had to be accounted for in the overall simulation. Temperature levels affected the material thermal conductivity, emissivity and the amount of secondary heating from convection, reradiation, etc. Usually it was either impractical or impossible to run efficiency tests, develop a family of curves, adjust the aerodynamic coefficients in the computer to satisfy the equation and meet test schedules as well. As a consequence, it was much easier to use calculated skin temperatures which were simpler to duplicate and did not require efficiency tests. An exception, however, might occur which would require efficiency tests, where power was limited and maximum reflector efficiency design was necessary. Duplication of skin temperatures made it even more imperative to use smaller control areas or to be able to measure control temperatures at more than one point.

The control area temperature problem was solved by the development of a method to parallel thermocouples for an average control temperature by a Wright Field engineer. Any number of thermocouples could be installed on each control area and wired in parallel to a switching panel so that in the event of a thermocouple failure the bad junction could be switched out, if desired, although it was not necessary. Whatever the individual temperature value represented by the failed thermocouple was included in the average, but usually had a small effect. Individual monitoring of each

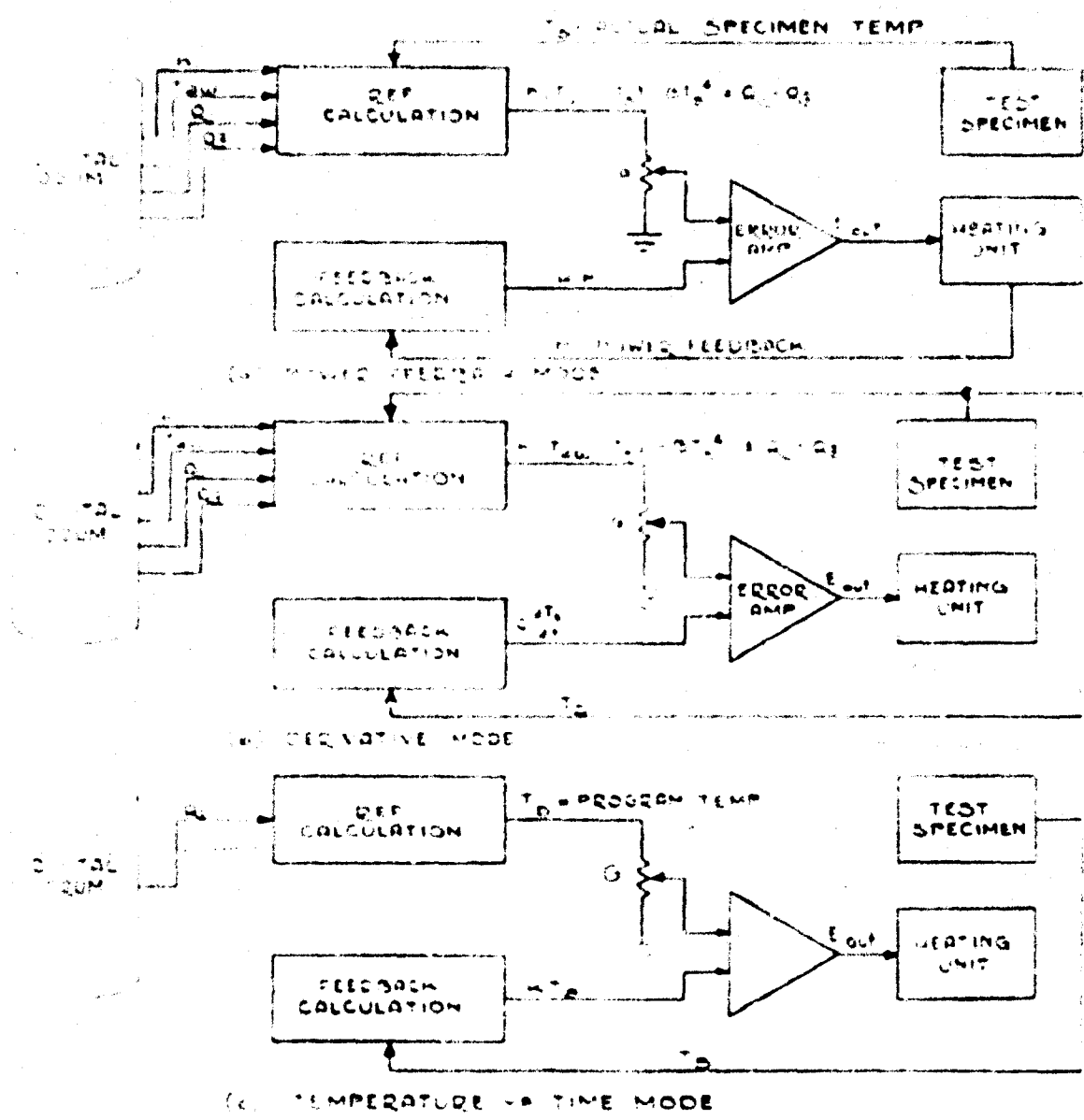

FIGURE 60

HEAT CONTROL EQUATIONS,  
 FUNCTIONAL DIAGRAM

Best Available Copy

thermocouple in a given control area was possible in the event an engineer needed to know an individual temperature value. Single control thermocouples were unreliable. The junction could break, or pull loose from the structure, and measure air temperature or something higher depending on its position relative to the lamps. A thermocouple could be shorted outside the heated area and measure ambient temperature causing an improper power level to the control area. A test abort would result and the thermocouple would then be repaired or replaced at considerable cost and loss of time. The common parallel thermocouple technique was able to eliminate or mitigate the effect of these problems in tests. In some cases data thermocouples could be used in control applications, thus eliminating additional thermocouple installation for control purposes.

The combined heating and loading problem was solved for Mach 2 (260°F) equilibrium and higher Mach number transient conditions when research and development work resulted in a loading system using silicon bonded tension plates 2 by 2 inches square. A one-eighth inch bond line of room temperature vulcanizing silicone sealant material was used between the skin and a three-eighth inch thick aluminum plate. This permitted excellent temperature simulation while loading because the plate and silicone allowed rapid heat conduction. In the case of full patch saturation, there was no perceptible temperature difference between the plates or at the edges. The same situation held whenever the patches were sparsely located. These tension plates were useful up to 600 degrees for steady state static testing, over 500 degrees for fatigue testing and for short time transient heating to 2000 degrees Fahrenheit.

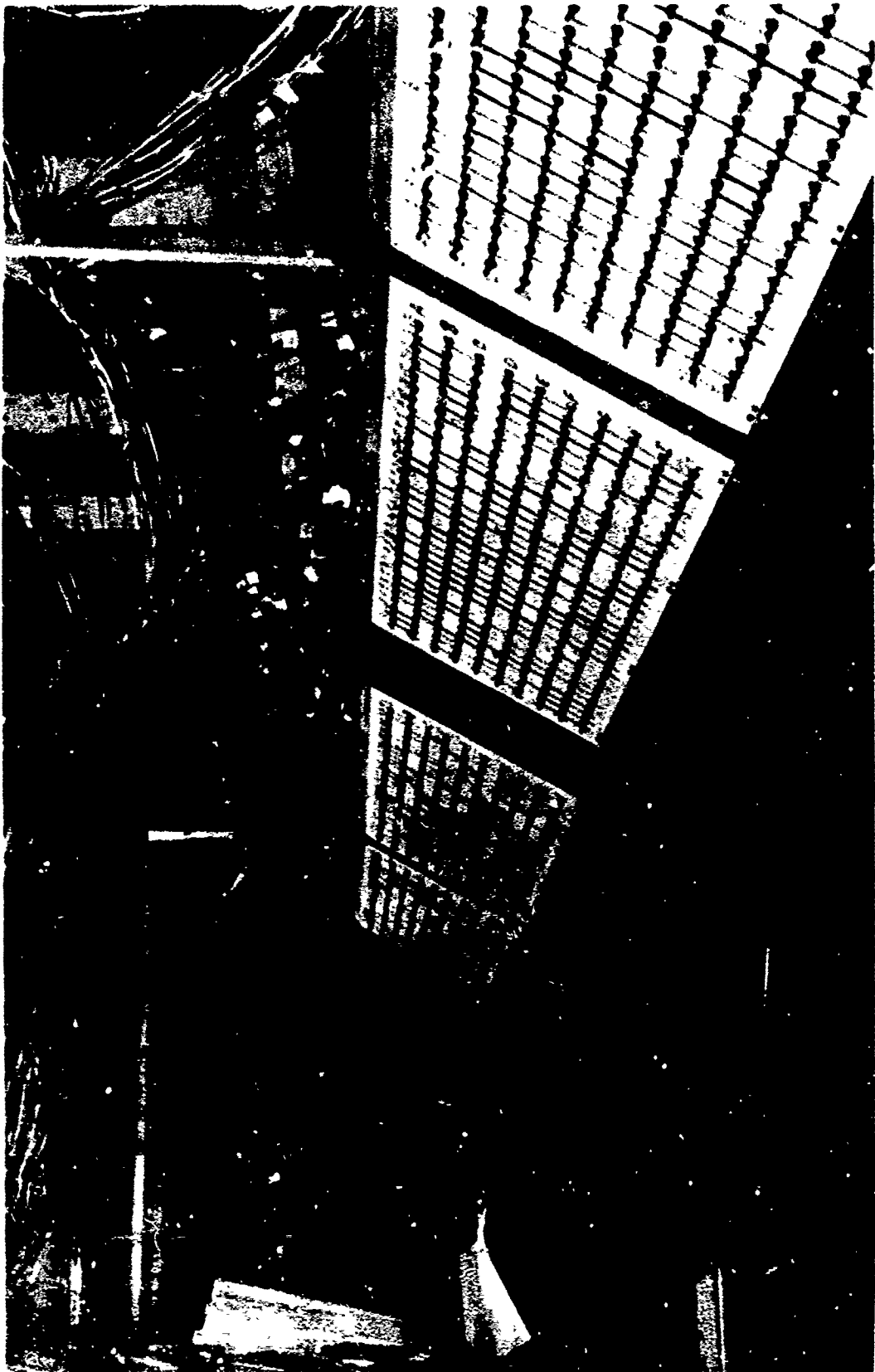
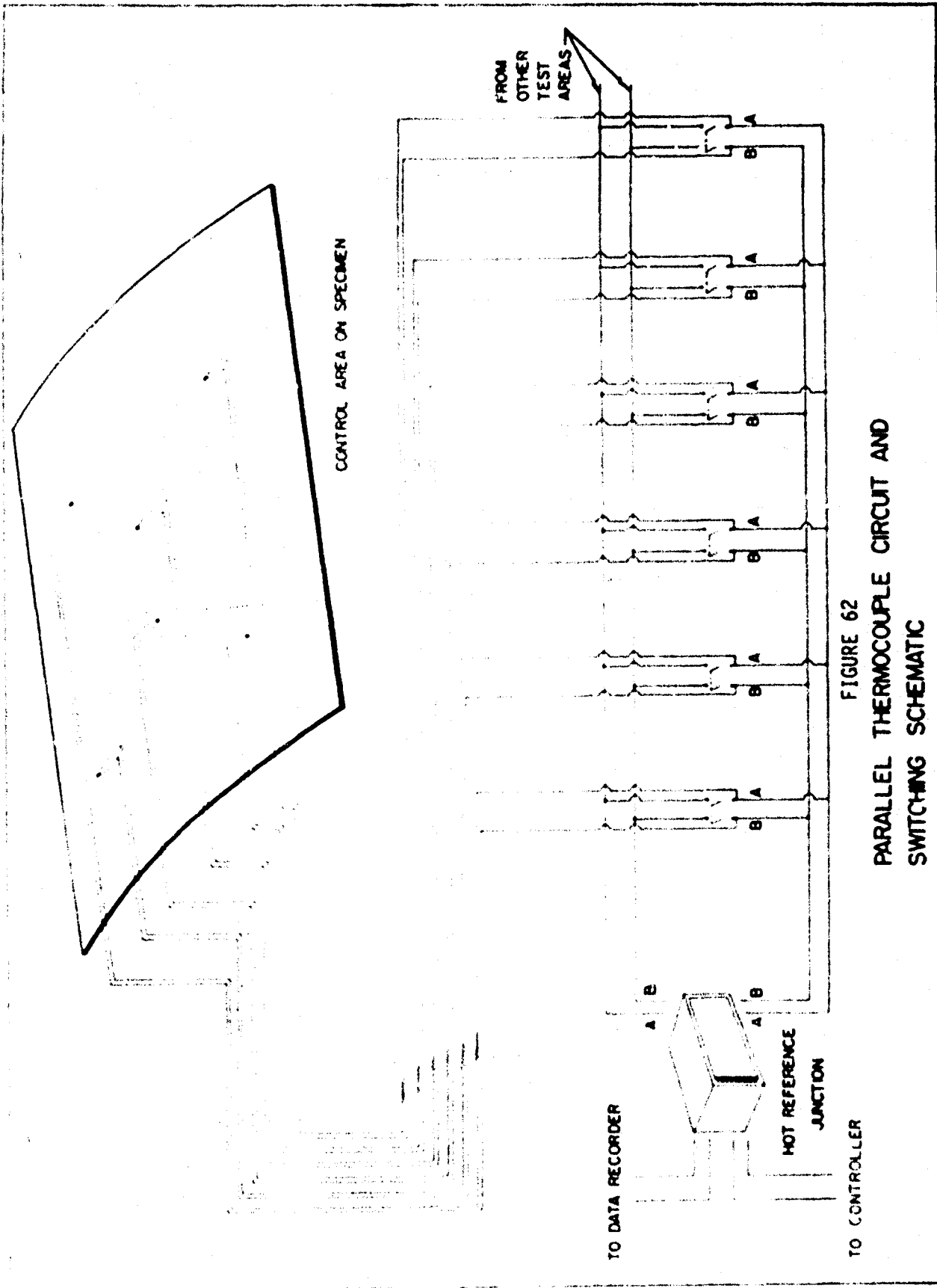

FIGURE 61

Thermocouple switching units for the 2300 thermocouples used on the B-58A elevated temperature tests for control and monitoring in parallel combination for up to seven thermocouples in some control areas.



Development work on conduction heating and loading methods ceased after it was demonstrated that Mach 3 airplanes (supersonic transport types) could be tested using this method. When needed, higher temperature loadings were applied through direct mechanical attachments built into the structure as it was manufactured for test structures. Adequate methods do not exist beyond the present capability of approximately 600 degrees Fahrenheit for tension patch loading of test structures.

The Vietnam war changed the emphasis on flight speeds from high and fast to low and slow. The research and development of structures for test at high Mach numbers was finally stopped in the 1970's with fighter flight speeds not exceeding Mach 3. As a result of these events, elevated temperature test simulation methods development came to a halt.

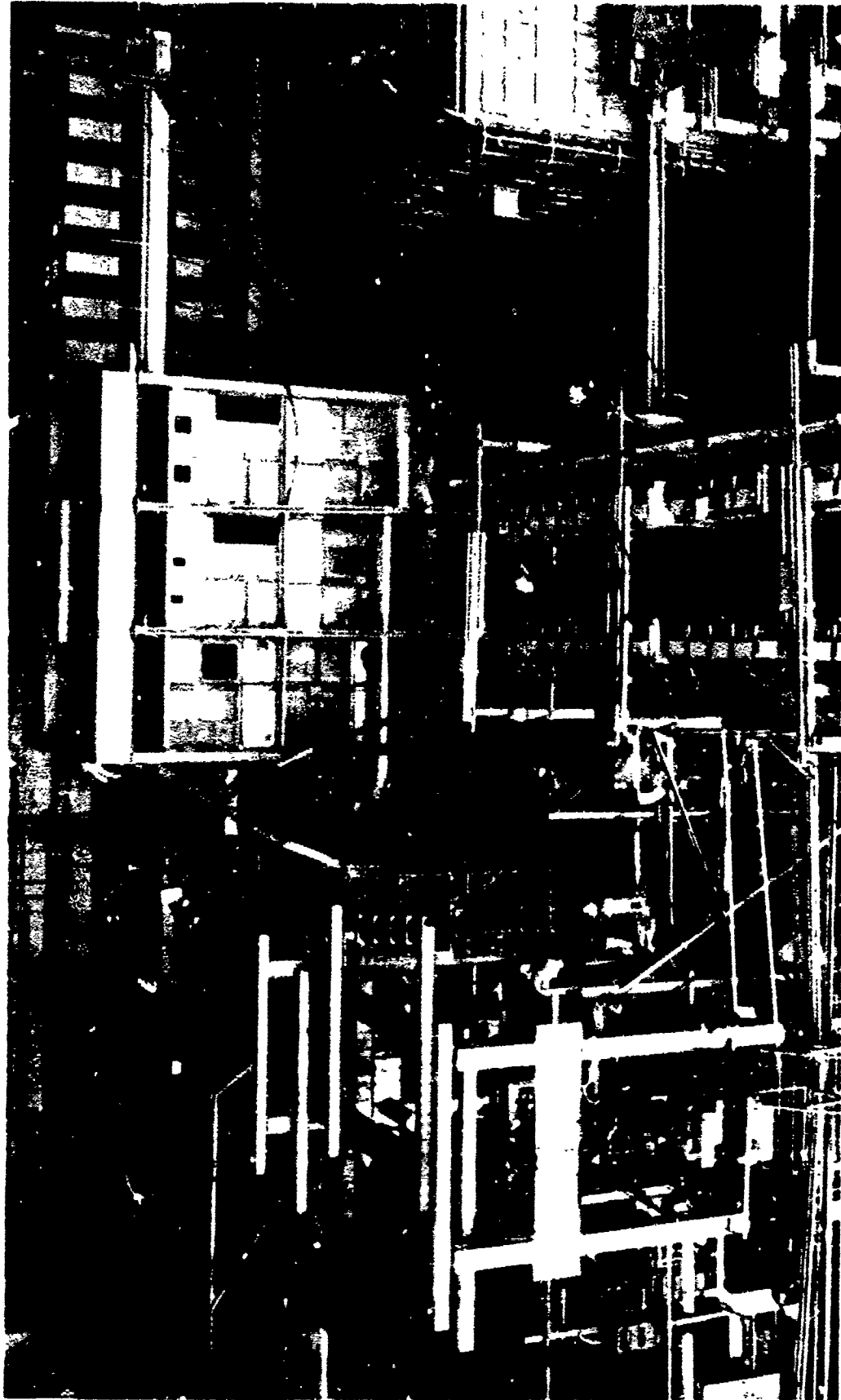

FIGURE 63

The Building 65 test floor in 1965 showing the SR-71 wing box elevated temperature test setup for real time fatigue. Time Compression test setup is in front of the control trailer, Advanced Structural Concept Experimental Structure is in the cryogenic barrier and the metal box-like enclosure at right center is the radio frequency barrier for elevated temperature testing using induction heating methods.

## SECTION X

### FUEL SIMULATION STRUCTURES TESTING

Simulated fuel was not used in static test airplanes before the need to simulate aerodynamic heating and internal heat sinks. Prior to that, fuel tanks were sometimes pressurized to simulate fuel pressures but not for fuel leakage. High roll rates, such as existed in the F-89 airplanes, required simulation of fuel pressures which varied along the wing. The fuel itself was not simulated. The internal fuel tanks were removed, resectioned and modified so as to hold different air pressures spanwise in order to simulate the hydraulic effect during the roll.

The Douglas Thor missile liquid oxygen tank was first tested at elevated temperatures using liquid nitrogen ( $LN_2$ ) as the fuel simulant in 1956. This program was followed by the Martin Titan missile liquid oxygen tanks in 1956 and 1957. Liquid nitrogen was used as the simulant. These tanks were filled from commercial tank trucks as needed at test time.

A study was made to find a safe liquid to simulate JP fuels prior to the B-58 static test program. An ethylene glycol and water mixture was selected as the most practical for the 260 degree Fahrenheit skin test temperature and worked well enough.

A method was needed to test structures that used liquid oxygen and liquid hydrogen. To develop techniques and gain knowledge prior to development of a liquid hydrogen test simulation capability for Air Force developmental structures, a liquid nitrogen facility was designed and built for limited cryogenic fuel simulation.

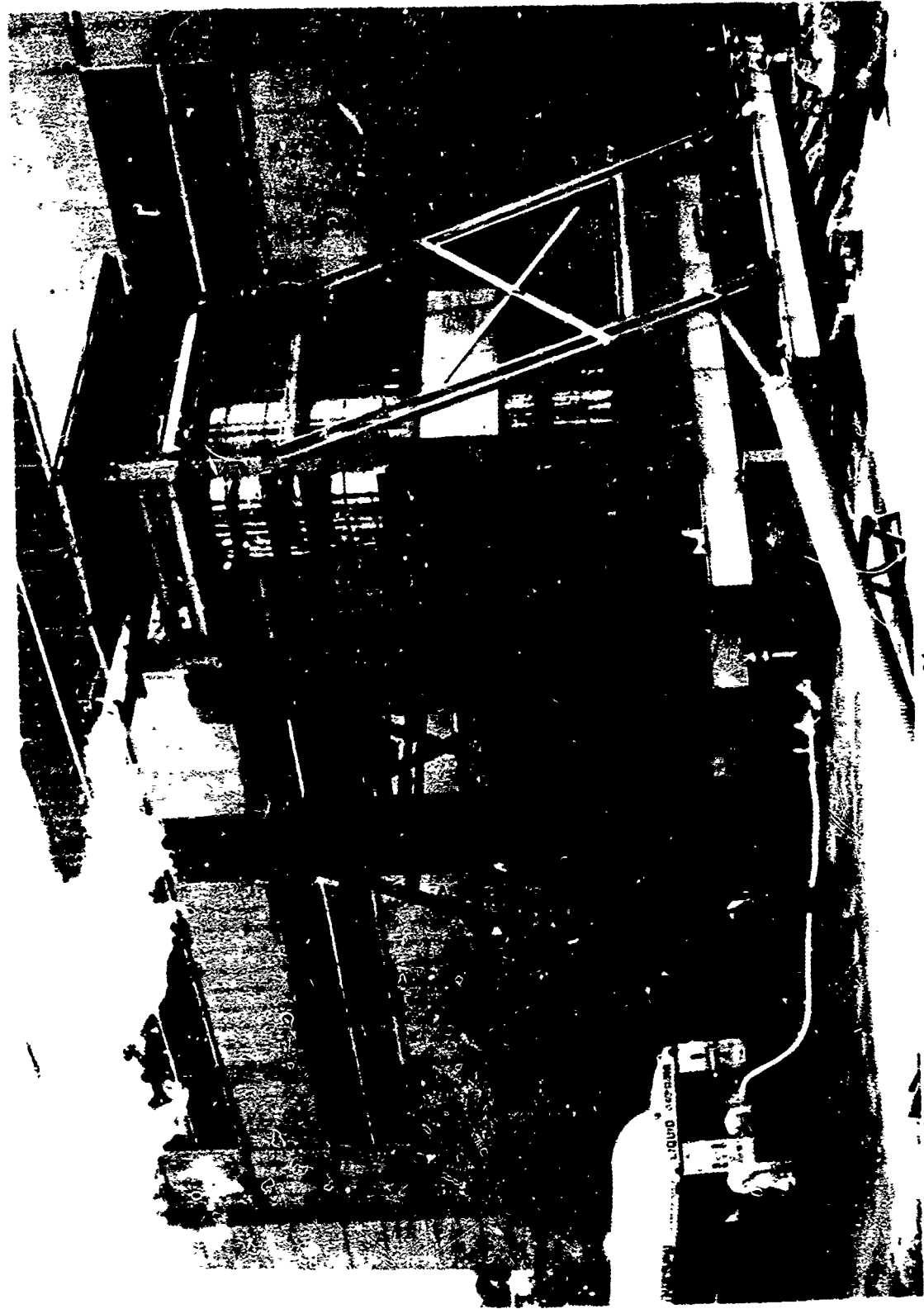

FIGURE 64

Static elevated temperature test of the Thor missile section using liquid nitrogen as a simulant for liquid oxygen at Wright Field adjacent to the north end of Building 65 in 1956.

The design study was made by Cryovac, Inc., Columbus, Ohio. This was followed with a design by Catalytic Construction Co., Philadelphia, with subsequent system construction in 1964. The system had a 10,000 gallon storage Dewar with pumps and control to circulate LN<sub>2</sub> and maintain fuel levels through a fuel tank inside a test structure designed for space operation. A 30 by 60 foot test barrier was constructed inside Building 65 next to the north wall with an insulated floor and drain for LN<sub>2</sub> to the outside into a limestone rock filled trench. It was completed in 1965 and the Advanced Structural Concept Evaluation Program (ASCEP) structure was tested in it from 1965 to 1968. It was used for other purposes including structural cooling during fatigue testing of the F-111 bird proof transparencies. It was removed in 1973, except for the Dewar, which was retained and used for cooling purposes on the bird strike windshield tests and other programs.

The LN<sub>2</sub> facility served its purpose, but was not adequate for the hydrogen fueled flight vehicles projected for the future. Work was begun on design of a liquid hydrogen test facility which was sited north of Building 65 in the old gun range. The test operations were to be conducted remotely from Building 65 with the test structures placed inside a 30 foot diameter by 60 foot long steel chamber. It was also designed to simulate flight altitude with time. The Dewar storage capacity for liquid hydrogen was 20,000 gallons. All elevated temperature and load controls were to be housed in the fourth floor of the elevated temperature building. Construction was first programmed for the 1969 emergency Military Construction Program.



FIGURE 65

The Advanced Structural Concepts Experimental Structure inside the Building 65 cryogenic test barrier showing end of internal fuel tanks for liquid nitrogen as the fuel simulant in 1965.

After it failed to be funded at that time, it was moved each year until it was finally cancelled because of the change in emphasis on hypersonic technology. Its projected cost was \$8,269,287.

Development work for loading and heating in a high altitude condition was started. The problems associated with that kind of testing were new, but did not appear to be insurmountable. Operational safety in a heated environment with a large volume of liquid hydrogen was especially a sensitive consideration. It was considered in depth and did not appear to be as serious as generally pictured by those uninitiated in hydrogen properties and usage.

Less sophisticated, but important facilities were also required for hydrogen cooled skin panels in which the gaseous hydrogen was forced through cooling passages. A gaseous hydrogen facility was designed and constructed by Air Force structures engineers to satisfy the conditions of a specific panel design. The hydrogen skin panel pressure was 500 psi with mass flow rates of 0.35 pounds per second. Panel exit temperatures were 1500 degrees Fahrenheit.

Local safety approval was obtained and checkout runs were made with gaseous hydrogen from tank tube trailers. The facility design met its performance requirements, but the development skin panel structure was not satisfactory for the test conditions. This work was done in 1968 and the lack of interest in hypersonics resulted in this facility being removed.

This same lack of Air Force interest in hypersonic technology caused a total decline in facility construction and many Air Force facilities in the design phase were cancelled and others closed.

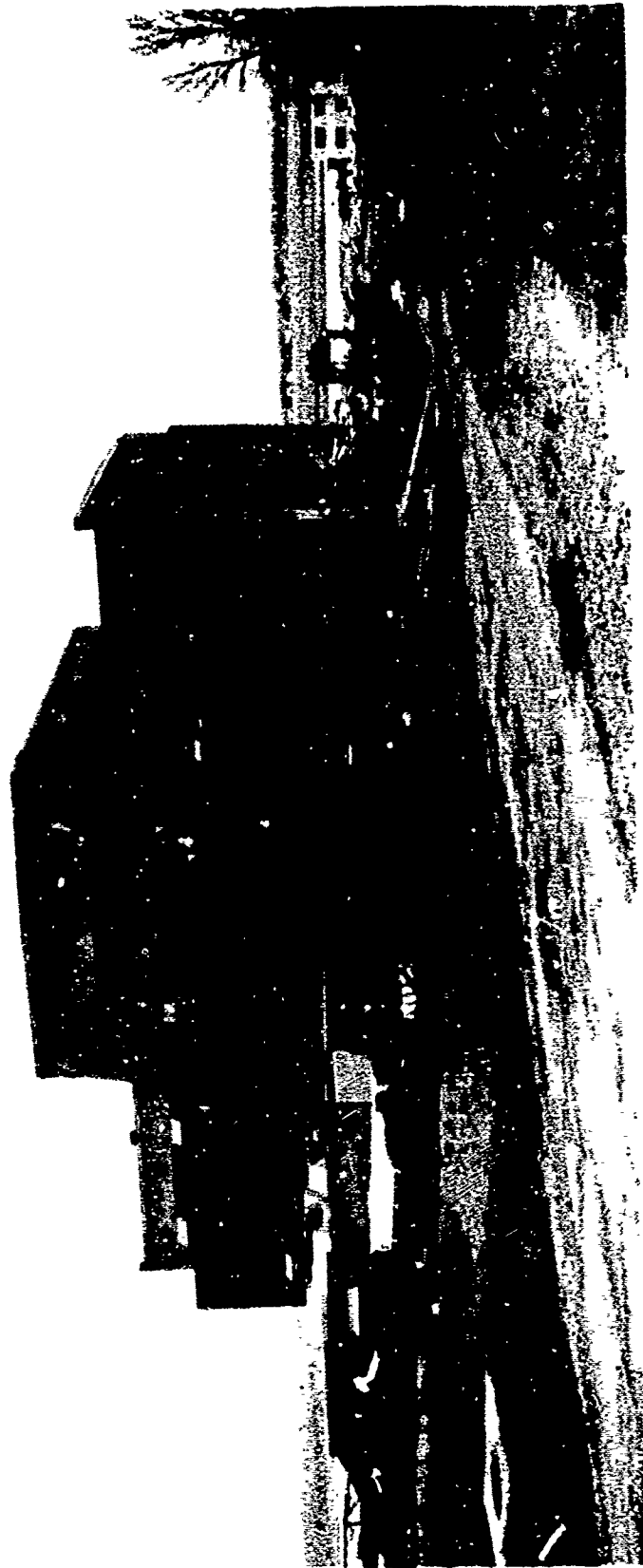

FIGURE 66

Northeast view of Building 65 structures test facility. The gaseous hydrogen tube trailers and control panel for hypersonic vehicle testing are in the center of the picture near the cooling tower building. The 50 by 100 feet metal storage building is at the extreme left edge of the picture. Circa 1969.

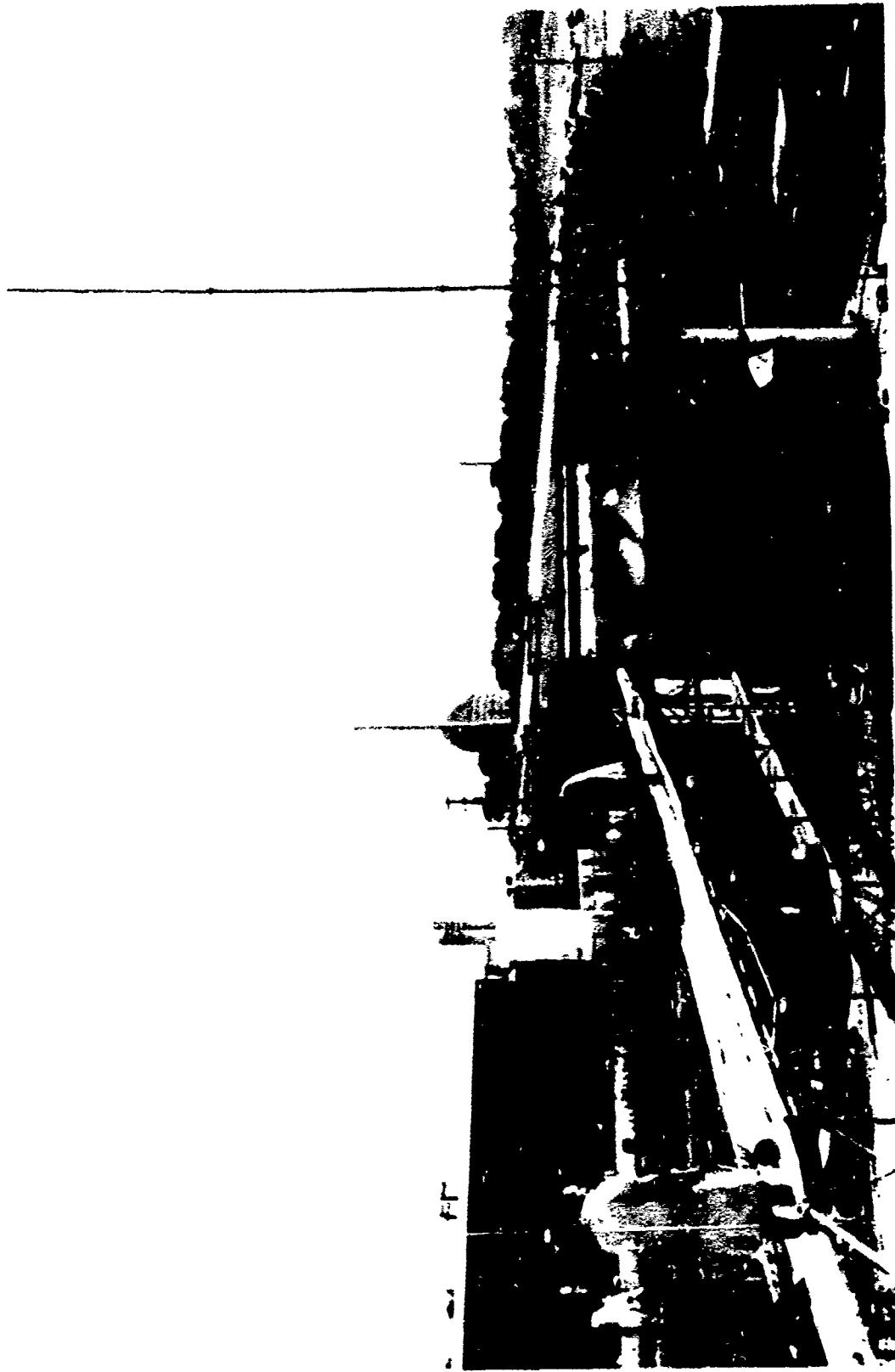

Figure 67

Gasous hydrogen test capability constructed for testing hypersonic vehicle skin panels. Located behind Building 65 in the salvage lot. Test requirements were for hydrogen gas circulated through a heat exchanger skin panel during hypersonic flight with a panel skin temperature of 1500 degrees Fahrenheit, internal gas pressure of 500 psi with .35 pounds of hydrogen per second. Heat flux for this condition was 70 BTU's/ft<sup>2</sup>/second. Construction was in 1968.

As a result, developmental work stopped. The increased sensitivity toward the environment and safety will likely prevent facilities such as a liquid hydrogen facility from ever being built at Wright Field.

As opposed to simulation for proper temperature distribution inside the structure, the problems of airplane fuel leakage is also a critical problem in the Air Force. Except for the F-102 and F-106 airplanes which used a Scotchweld\* adhesive for sealant, most all leak fuel. Future fatigue testing may require simulated fuels during testing to prevent fuel leakage from becoming a serious problem in service usage. More attention is being given to designs that prevent fuel leaks.

\*Registered Trademark

## SECTION XI

### STRUCTURES TEST FACILITY AUTOMATION AND DIGITAL COMPUTER APPLICATIONS

The integrated circuit, which first became available in 1959, revolutionized the electronic industry. It made possible electronic equipment which was very much reduced in size and greatly enhanced test capability and application. The new equipment made a big impact on structural testing operations.

Test automation of equipment used in structural testing was conceived in 1961 because of the apparent complexity required for simulating test parameters to satisfy structural heating, cooling, loading, and cryogenic fuel simulation. The structural test facility's Heat Control Computers for simulating aerodynamic heating had hundreds of switch positions, alone, which were too time consuming to check properly. When integrated with several other test systems the need for eliminating human error in checking was essential.

In July 1963, a study was made by Air Force test engineers for automating checkout operations. Its cost was estimated at two million dollars. Money for that purpose was unobtainable in Fiscal Year 64 or 65. Early in 1964, an AN/GJQ-9 automatic test set, designed for the Skybolt missile system ground checkout became available because that program was cancelled. A new study indicated that this equipment could be used to satisfy the original requirements using a different approach. The AN/GJQ-9 test set was requested from the Air Force Logistics Command. It was approved and installed using Laboratory Directors Funds.

Using the AN/GJQ-9 test set and in-house money and manpower, the Heat Control Computers, the Control Load Programmer, ignitrons and

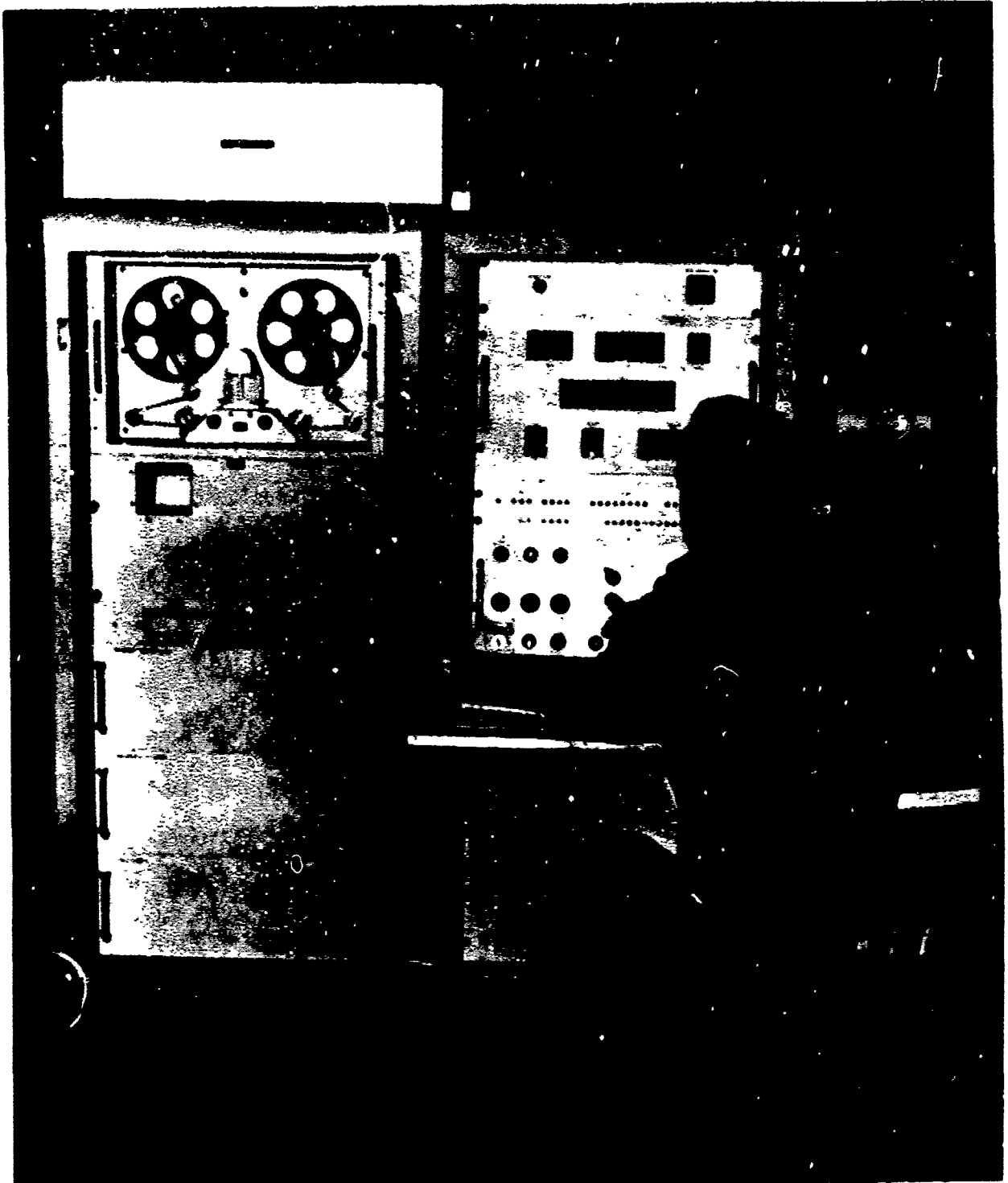

FIGURE 68

The AN/GJQ-9 Test Set designed for ground checkout of the Skybolt missile which was used for automating the radiant heat and heat control computers in Building 65 from 1964 to 1973.

liquid nitrogen system control panel were automated. This Building 65 automation effort was presented as an example of facility automatic checkout by project SETE\* Steering Group in April 1967.

Analog programming equipment and techniques were the backbone of fatigue test loadings for many years. However, this method was not entirely satisfactory for complex load sequences. In the early 1970's, a new requirement was made for flight by flight load sequences by the Air Force and this was satisfied by using an FM tape transport for multichannels and by using an Information Technology Incorporated Digital Programmer with cassette support which had been developed for the time compression project in the early 1960's for single channel testing.

Minicomputers came along later and were used in structural testing. The first minicomputer was developed and manufactured in 1959. It sold for a fraction of the cost of competitive digital computers. In 1965, a different version was produced that would accept most every kind of peripheral equipment necessary for a test system needed for fatigue test programming. It could be used for all types of instrumentation and equipment and operate on-line with as much as 124K memory.

The cost of a basic minicomputer system for fatigue testing a complete fighter airplane structure was approximately \$80,000. The analog to digital and digital to analog converter cost another \$35,000.

The first minicomputer system used in Building 65 was purchased in 1971 for structural testing. It was a Digital Equipment Corporation

\*Secretary for Electronic Test Equipment

PDP-11/20 with a 4 K memory and provided digital control on a test coupon using Neuber's analysis technique. This same machine, with considerable more memory and peripheral equipment, was later used in developing digital load control. The initial work accomplished with this machine enabled test engineers to recommend the use of digital control for both heat profile function generation and control in aerodynamic heat simulation and internal heat simulation from engines, etc., to NASA Edwards and for the British and French on Concorde static and fatigue test operations.

Digital load control began in the Air Force using one channel in March 1973, then four channels in April 1974, followed by 13 channels on the F-111 wing fatigue test in June 1974. The F-111 wing cycle speed was approximately one cycle per minute.

That test success generated the recommendation that the Building 65 test operations use digital load control for the Advanced Metallic Air Vehicle Structure (AMAVS). The system procured for this test program consisted of a PDP-11/40 minicomputer linked to another minicomputer to function as a master and slave. Delivery of this equipment was in 1974.

Programming of this equipment was accomplished with a language called FOCAL, then BASIC and finally FORTRAN with assembly language handlers.

It took additional research and development to prove digital load control after the master-slave equipment was purchased, because of the need for more programming and algorithm development in both theory and demonstration.



FIGURE 69

Digital Computer Company PDP-11/40 master and PDP-11/40 slave concept linked together for digital load control on fatigue test structures in Building 65, Wright Field, as used on the Advanced Metallic Air Vehicle Structure in 1977.

In February 1977, the Advanced Metallic Vehicle Structure was cycled using 11 channels of flight by flight load sequence digital programming and load control successfully.

The master-slave concept using minicomputers was channel limited and a new concept became necessary. This was made possible by the introduction of the microprocessor. By adding the same kind of peripheral equipment to the microprocessor as used with the minicomputer, it was possible to build a similar system at much less cost. It could be tailored for a specific operation and used with the master-slave concept using a minicomputer as the master. With this system architecture, it is possible to have a large number of load channels for structural fatigue testing.

Research and development work using the mini-micro master-slave system was started in 1976 in the Air Force Flight Dynamics Laboratory at Wright Field.

## SECTION XII STRUCTURES TEST INSTRUMENTATION

Without accurate methods for use in airplane structural design, the weight penalty necessary to guarantee structural integrity is severe. Analytical stress analysis techniques were developed to improve airplane weight and efficient designs, but the many different structural geometries and configurations made the problems difficult, if not impossible, to solve. Precise, detailed, designs are required to meet the military mission performance specifications. The process is very expensive and time consuming. Few, if any, load carrying structures other than the airplane require such complex and sophisticated structural designs.

Static testing only proves that the structure is strong enough for the loads imposed. In the event of a failure at one location, that location can be strengthened until it sustains the loads. It is possible for most all of the rest of the structure to be overstrengthened and thereby overweight. Static testing has always been the accepted method of checking or proving stress analysis of a test structure or part. Hooke's Law and material properties such as the yield stress, the ultimate stress, the modulus of elasticity and Poisson's ratio came from static test results and observations. With accurate test information, the process of improved analytical methods are enhanced, minimum airplane design weight is more nearly achieved and airplane performance is improved.

Experimental stress analysis and its supporting instrumentation for measuring strains and deflections, as first applied to airplane

structures in the early 1940's, resulted in claims of a twenty five percent weight savings to structures. The stress analyst must understand all of the loads on a part, a component or a structure as well as the stress distribution and the allowable stresses. Strain measurements provide him with the best information in defining and understanding the internal loadings.

The first strain investigations were on coupon test specimens loaded in tension and compression and were later extended to cover machines and structures. This was first started in 1856 using the Wedge Gage which was followed by a great variety of extensometers and strain gages. Extensometers were of little use on aircraft research and the strain gages prior to the 1930's were not practical for such use.

In the 1935-36 time period, the de Forest Scratch Gage was used for dynamic tests and the Tuckerman Optical and Huggenberger strain gages began to be used in high accuracy static test work.

The electrical wire resistance strain gage was invented in 1938 by two different people. Mr. E.E. Simmons, Jr., California Institute of Technology, and Professor A.C. Ruge, Massachusetts Institute of Technology, did their work independently, but a patent was finally issued for the basic invention to Simmons with improvement patents to Ruge. Two other people, D.S. Clark and A.V. de Forest, were involved with the early applications of strain gages. The first commercial strain gages were designated SR-4, a registered trademark honoring the four people involved. The major problems in its development were calibration techniques, bonding to strained material and temperature compensation.

Baldwin-Southwark manufactured the early strain gages and Frank Tatnall became instrumental in their application to experimental stress analysis through his efforts to sell strain gages for that company.

The strain gage became very useful for airplane structures testing as an aid in reducing structural weight and measuring forces and moments in wind tunnels, determining flight test loads, etc. The resistance strain gage could be installed nearly anywhere and could be used to check against calculated strains.

The earliest full scale static tests in the 1930's used anything and everything available to read strain and compare structural reactions with accuracy of five percent or better claimed. There were Huggenberger and Whittemore strain gages, dial gages, scratch gages, hanging steel deflection scales read with a surveyor's level (first used in 1931 by Wright Field Engineering Division), electric carbon pile telemeters, induction telemeters, etc. available which made static testing a nightmare for the test operators.

The Douglas XO-35 wing static test in 1932 used the McCollum Peters 12 element electric telemeter which was later used at Wright Field on the BT-2B airplane as a flight test strain recorder for measuring loads.

The first automatic strain recorder based on mechanical levers on an extensometer and patented by a Mr. Templin, was first shown to the public in September 1931. Most of the strain recording from electrical telemeters was being done manually, except for the use of the oscillograph which was mostly used for dynamic recording.

Mr. C.M. Hathaway's experiments with fine filament wire earlier than that done by Simmons and Ruge, indicated practical possibilities, but he knew that resistance strain gages were of no value without equipment to record or measure the strain. Vacuum tube electronics solved that problem.

In 1939, Ruge and de Forest formed a partnership for the development, engineering and manufacture of strain gages and devices after the Massachusetts Institute of Technology's patent committee decided that the strain gage lacked commercial possibilities and passed up their opportunity to market it. The Ruge-de Forest Company first ordered 50,000 stock strain gages from Baldwin in 1941, believing that order would last a year. It only lasted two months, which showed that they failed to assess the market adequately, but were thus assured of success in their business.

Baldwin Locomotive Works was the patent protected manufacturer of strain gages, but in the early 1940's the problem of both availability and apparent high cost resulted in the airframe manufacturers and the Wright Field static test facility in building strain gages in clear violation of the patents. The initial price of the A-1 flat grid paper based gage manufactured by Baldwin (later Baldwin-Southwark Division) was \$2.50. During this same time period, some of the airplane companies claimed to be making them for as little as twenty five cents per gage. It was the Vega Airplane Company which claimed the first construction and use of a rosette gage on stressed skins in 1939.

It hurt Baldwin-Southwark's and Ruge-de Forest's operations to have the aeronautical structures people teach each other about gage manufacturing free of charge during this time period. Because of the war circumstances in the 1940's, and the influence wielded by Mr. Tatnall with Baldwin-Southwark, there were no patent infringement suits. After the war, Baldwin-Southwark was able to make amicable agreements with those involved in patent infringements.

Prior to 1941, large structural tests to destruction were not allowed when the strains were measured with Huggenberger Tensometers and Whittemore strain gages. There was extreme danger to anyone reading them in the event of a structural failure which could also result in the dumping of a large quantity of sand and shot bags. With the use of SR-4 strain gages, this problem was eliminated as the gages were read remotely.

In December 1941, Lockheed was awarded a contract to make stress measurements at the Wright Field static test facility on a full scale bomber static test. That test program involved 200 strain gages. This was the first time that the Army Air Corps had ever used an aircraft manufacturer in its aircraft testing operations at Wright Field.

A method used for qualitative stress indications was called stresscoat. A brittle lacquer was painted on the areas of interest, allowed to dry sufficiently, and then the structure was loaded and the lacquer cracking pattern was noted at load intervals to evaluate stress intensity and stress patterns.

Strain gages were the most useful to the stress analyst, and it was not long before there were hundreds of different kinds of strain

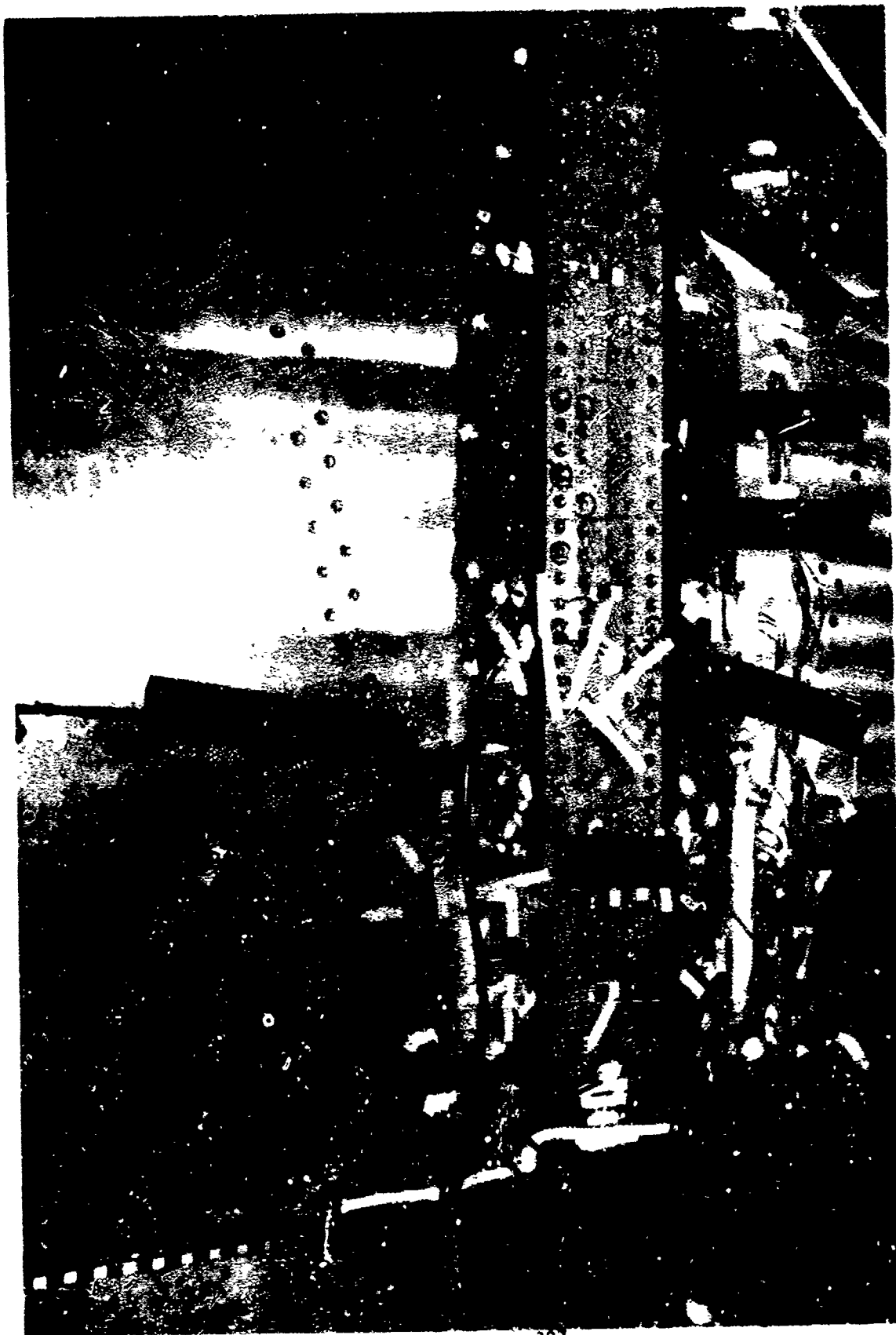

FIGURE 79

F-4C/D extended life fatigue test program center splice plate, lower surface, showing rosette and axial strain gauges.



FIGURE 71

F-4C/D Extended life fatigue test program showing strain gage rosette for measuring strains in the lower wing torque box.



FIGURE 72

F-4 horizontal stabilator shear bridges used in calibration for Have Bource runway roughness program in 1979.

gages, including gages for use at high temperature. With the use of these and other tools, experimental stress analysis came of age. The SR-4 strain gage in the 1940's was credited with the greatest single contribution to making efficient airplane structures.

The first strain gage load cell came into use about 1944, which enabled precise load measurements in conjunction with a hydraulic actuated load cylinder. It was used mostly in fatigue test operations and was instrumental in automated loading system designs using that feedback signal for control.

From the 1940's through 1960 at the Wright Field structures test facility, test structures were evaluated for strength and fatigue tests using a large number of strain gages, deflection scales (graduated to 100ths of an inch) read with a surveyor's level, dial gages and inclinometers. The strains were once recorded using a Wright Field named Black Box Connection (original strain indicator), Baldwin SR-4 Strain Indicators, precision Wheatstone Bridges, Baldwin-Southwark 48 channel Recorders, Miller Oscillographs, Consolidated Oscillographs, Brown Recorders, 16 channel Nosker Strain Indicators, Nosker-Gilmore Strain Recorders and others. Bridge balance was primarily done manually. The strain gages were zeroed at a given low load level. The strains and deflections were then recorded at 10 or 20 percent increments up to 60 percent design ultimate load. Above 60 percent load, the data were recorded at 67, 80, 90, 95 and 100 percent levels as conditions permitted, or to destruction at five percent increments above 100 percent.

The deflection scales, twenty four and thirty six inches long, were used until 1959 when a Wright Field structures engineer designed

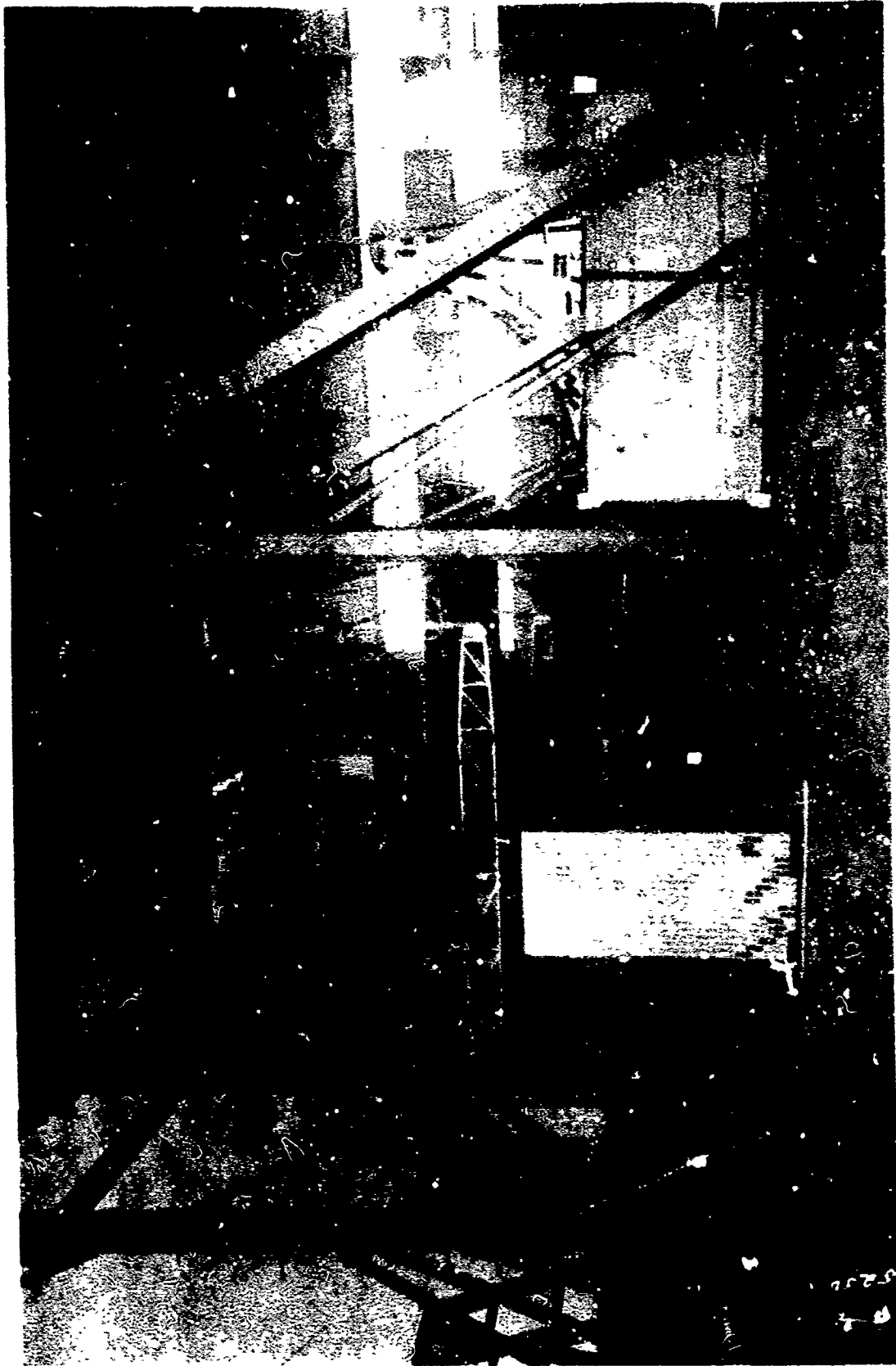

FIGURE 73

B-32 structure undergoing static test in Building 65, Wright Field, in 1945 showing a deflection board in left foreground.



FIGURE 74

The F-84D positive high angle of attack condition under static test with combined lead shot bags and hydraulic tension patch loading. The foreground shows the two types of Nosker 64 channel manual strain gage recording equipment in use in 1948 at Wright Field.



FIGURE 75

The F-84F undergoing tail calibration in 1955. Strain gage instrumentation recording equipment is in the foreground.

a water manometer system. Small water containers hung on the structure were arranged in such a manner that the actual structure's deflection could be seen visually on a specially designed multiple manometer. Measurements were recorded with a camera (and tabulated later), or were read and recorded manually at each increment of load. This method speeded up the test loading considerably and gave the test engineer a complete visual picture of the deflected structure and its movement in the free floating test setups. This method was soon made obsolete in the early 1960's by electronic deflection transducers and the computer.

Investigations of the high temperature effects in high speed flight began with NACA in 1948. In October 1952, the Wright Air Development Center at Wright Field began working in the research and development of high temperature testing of full scale flight structures. The need then was for strain measurements at temperatures of 800 degrees Fahrenheit. As test temperatures continued to increase, serious problems were encountered in the development of high temperature strain gages. At the present time, the highest practical working temperature is 1000 degrees Fahrenheit for resistance type gages and 1500 degrees Fahrenheit for capacitance gages when used in structures testing applications.

Thermocouples were used for temperature data measurement and for control purposes. The thermocouple materials were never developed for accurate temperature measurements in structures testing over 3100 degrees Fahrenheit, although higher temperatures could be produced on the structures using radiant heating methods. Measurement accuracy

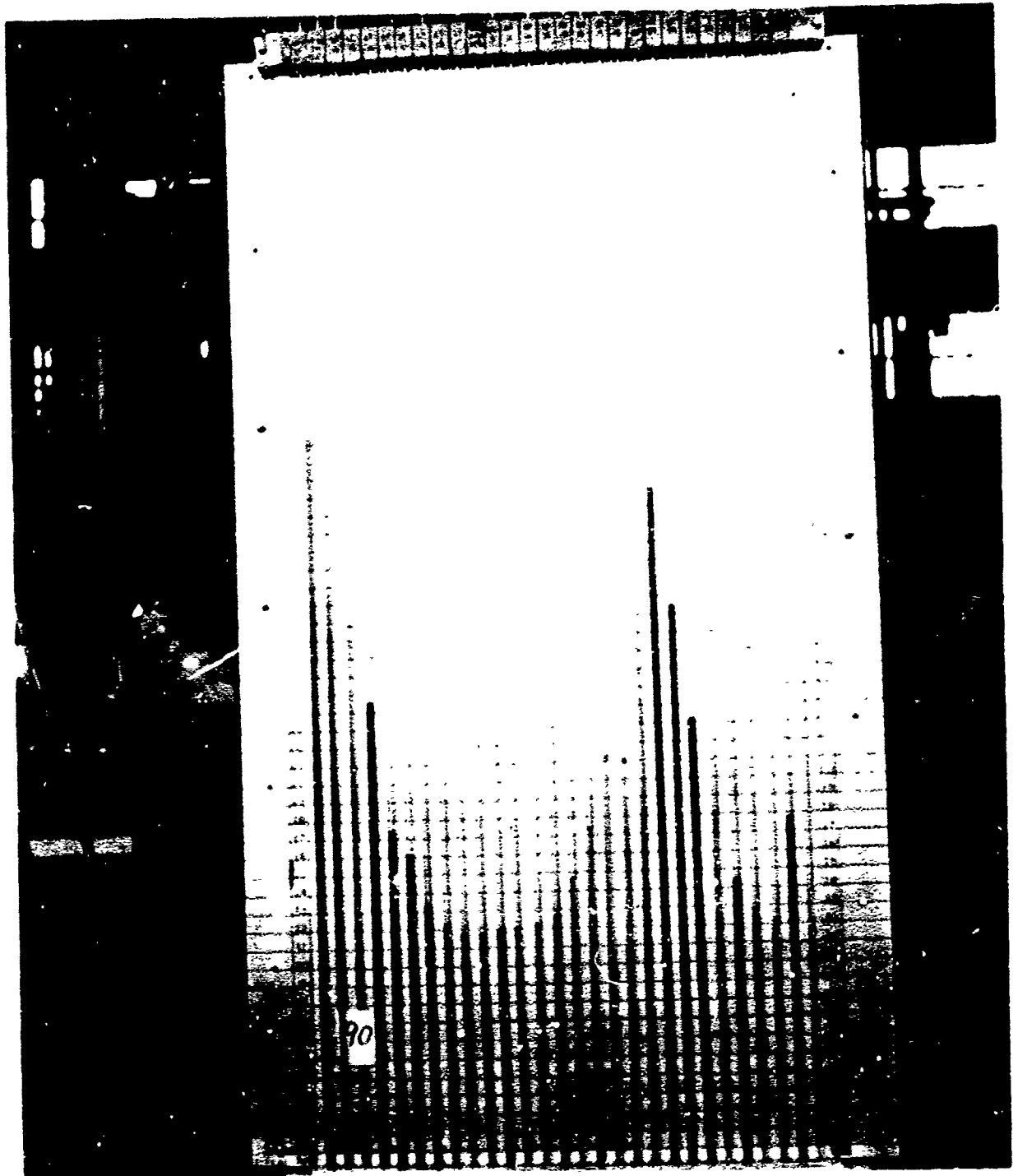

FIGURE 76

Multiple manometer water deflection measuring system used on the F-105B in 1959. The manometers show wings deflected at 90 percent design ultimate load in inches.

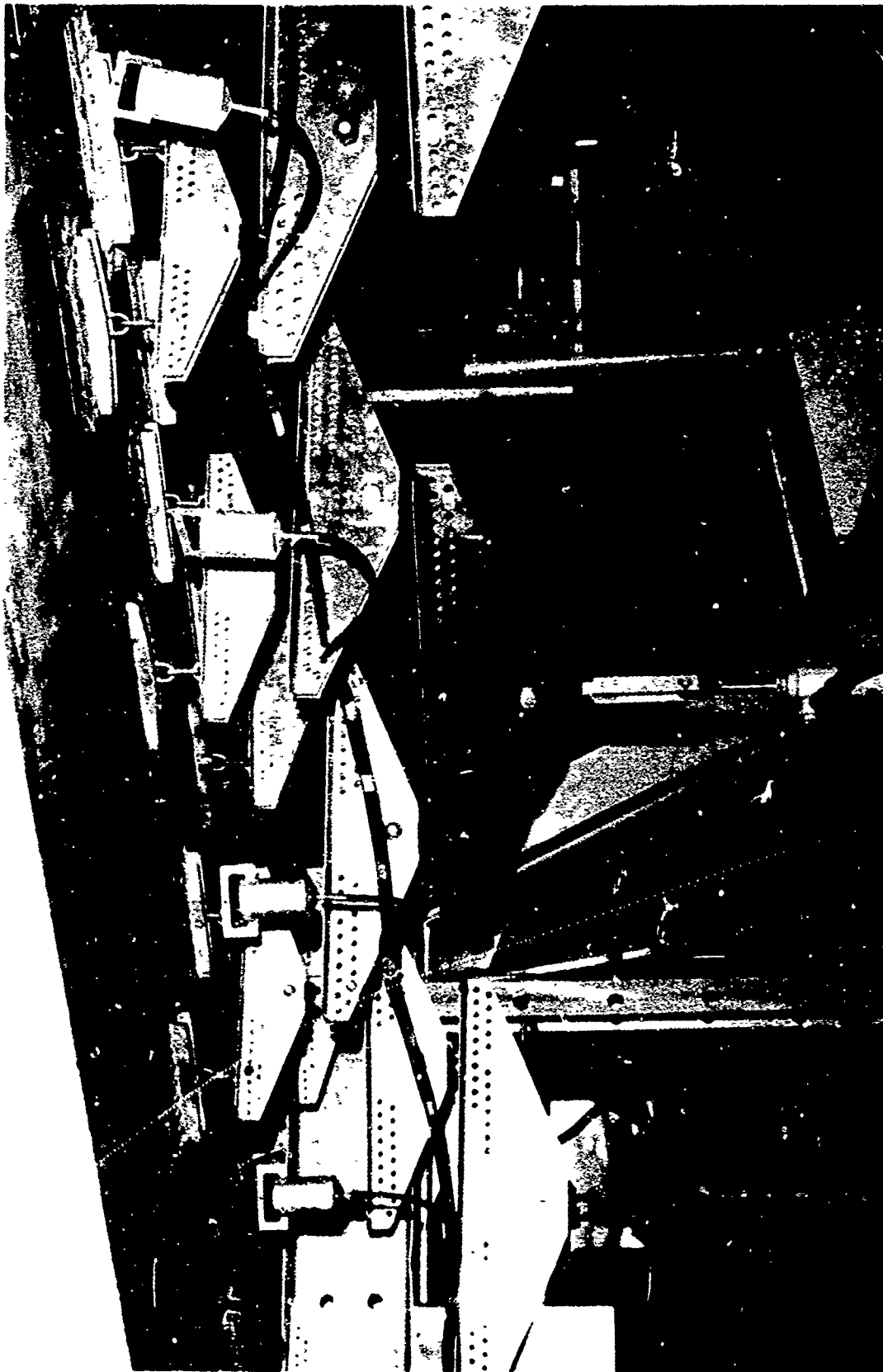

FIGURE 77

Sponge rubber tension load patches using sheetmetal load beams and water manometer deflection cans in 1959.

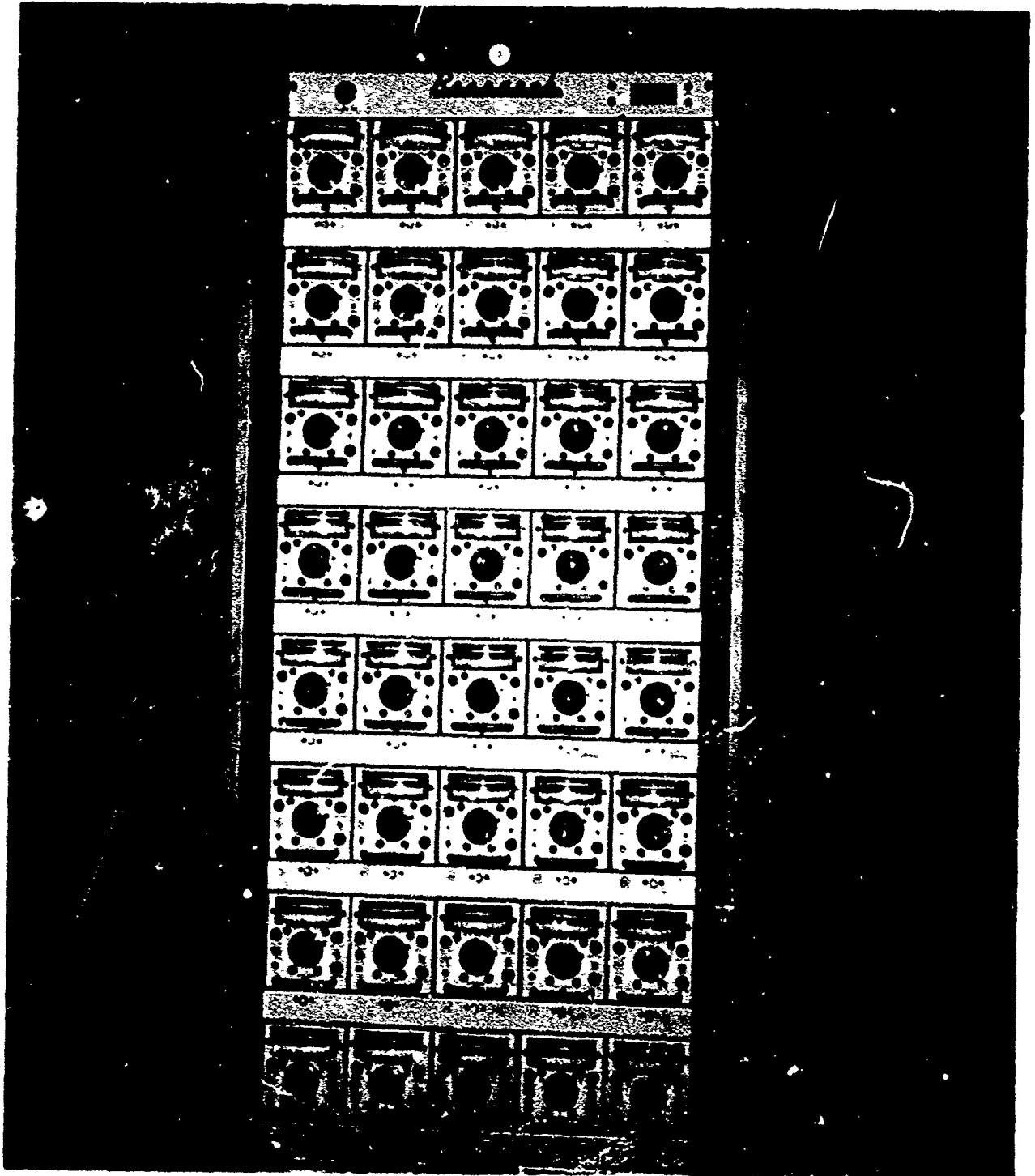

FIGURE 78

Building 65 data system displacement transducer electronic signal conditioning equipment rack. Circa 1962.



FIGURE 79  
Building 65 data system displacement transducers in two of the several ranges for measuring structural deflections electronically. Circa 1962.



FIGURE 80

The Di-boride Ceramic Nose Cap showing high temperature thermocouple instrumentation for re-entry heating profiles at Wright Field in 1972.

for higher ranges remain unsolved problems in the simulation of aerodynamic heating on structures.

The full scale elevated temperature data facility at Wright Field included a data recording and reduction system with 1920 channels. The total channel capacity permitted 832 data and 144 control thermocouples, 642 strain gage channels with one or two active arms, 160 deflection transducers and 160 load transducers. The 1920 channels were fed through eight transmitter multiplexer units which used flying capacitors in the commutating drum.

The low speed sampling rate was 20/sec/channel and the high speed sampling rate was 100/sec/channel. A Control Data Corporation 1604 computer was used with the Stromberg-Carlson Model 4020 microfilm printer and the Stromberg-Carlson Model 1000 monitor. Data storage was on four Ampex FR 314 tape recorders and four Ampex FR 307 computer tape recorders. Selected data channels could be plotted on a Stromberg-Carlson 1000 cathode ray tube display system during tests for a quick look. Data were recorded on magnetic tape, microfilm, or by computer typewriter output by on-line or off-line modes. Data could be plotted or reproduced in tabular form.

This system was scheduled for operation in 1960, but delays were encountered preventing its operation until 1962 when it was first used on the Boeing Hot Structure tests. It could be used on one major test program at a time and required reprogramming in order to take data for different major structural test programs. Software was custom tailored and written in Control Data Corporation 1604 computer assembly language. Air Force efforts to improve the data system

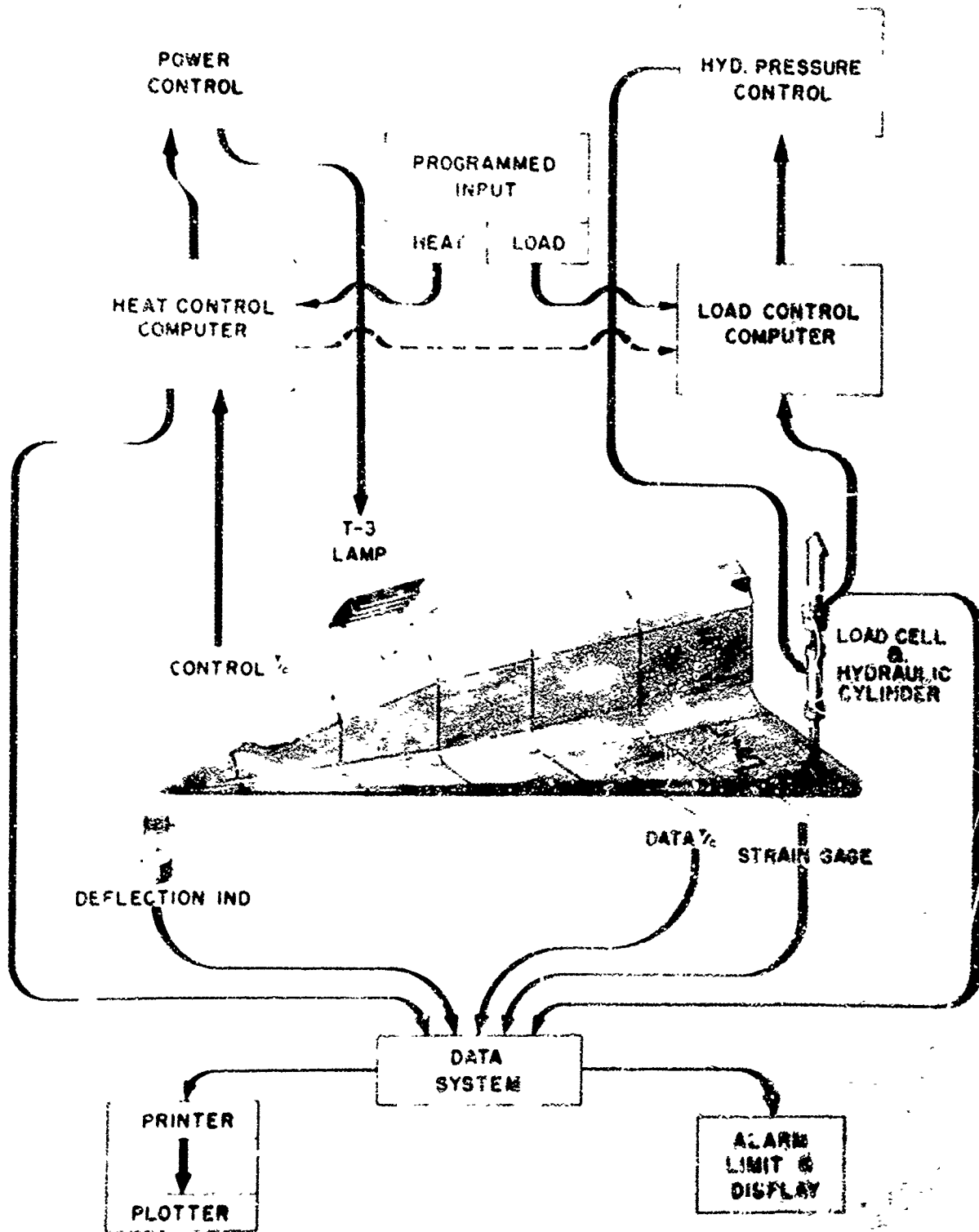

FIGURE 81

DATA SYSTEM "TIE-IN" WITH TEST STRUCTURE AND FACILITY COMPONENTS

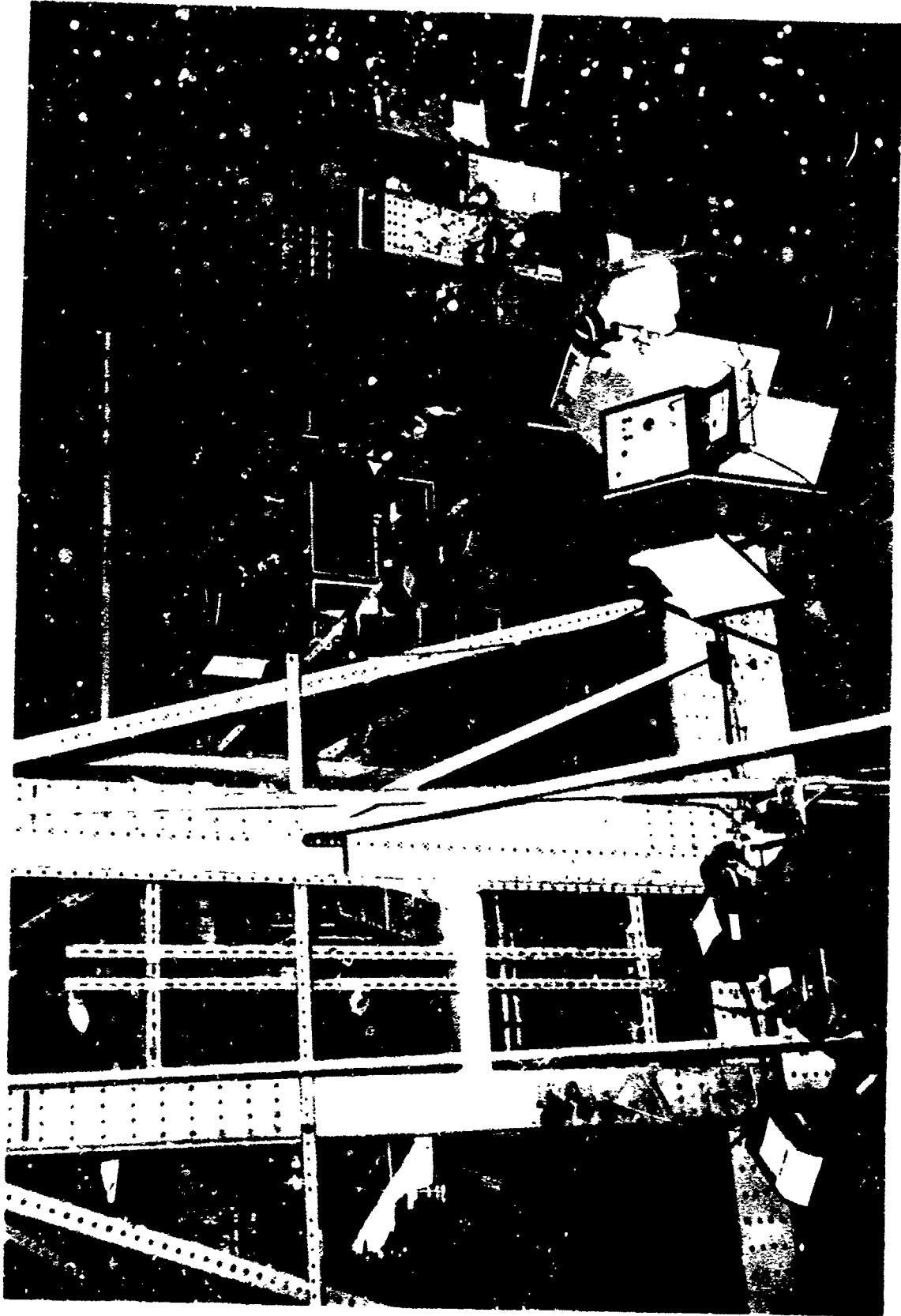

FIGURE 82

Data acquisition support equipment used on the Boeing X-15 Structure elevated temperature tests in 1960.

operation provided better electronic equipment which resulted in the eventual phase-out of the transmitter-multiplexer units which were troublesome, costly and difficult to maintain.

Failure prediction in static testing was considered an important requirement and it was believed that the data system computer could be used for this purpose. Research studies indicated that strain gages could be used successfully to predict failure. An Air Force research and development work effort was completed, but more compelling work requirements prevented its successful utilization. Also, the main test emphasis changed from service airplane structure testing to re-entry type exploratory and advanced development flight vehicle structure testing where failure prediction was of lesser importance.

The first data minicomputer was purchased in 1971 along with two computer controlled, random access, electronically multiplexed multiplexer/analog-to-digital converter systems. The data handling unit was connected to the minicomputer which in turn was connected to operate either under control of the Control Data Corporation 1604 computer, or as a stand-alone system.

A Systems Engineering Laboratories Model 86 computer, four PDP-11/40 minicomputers connected via a high speed direct memory access interface, an IMLAC PDA-4 Minicomputer Graphics System, thirteen computer controlled multiplexer/analog to digital subsystems, 1400 channels of analog signal conditioning equipment, 200 channels of potentiometric bridge signal conditioning equipment, 600 channels of universal thermocouple signal conditioning equipment, and other

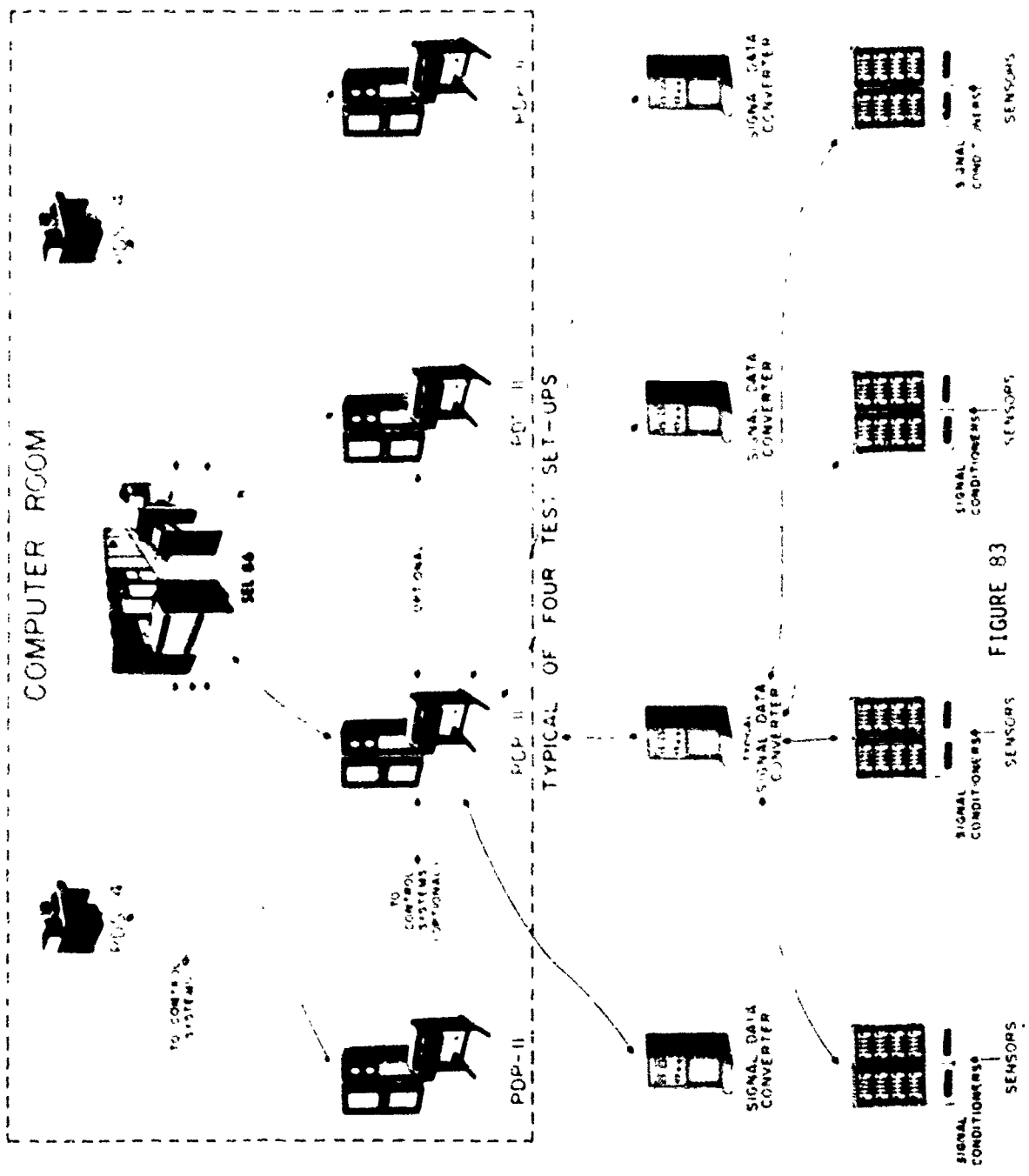

FIGURE 83

Schematic of Building 65 Data Acquisition System as configured in 1979 with the SEL 86 Computer and four PDP-11 Minicomputers.

peripheral equipment were all installed in 1975. All computer tasks were coded in FORTRAN with assembly coding both in-line and in subroutines.

Another minicomputer was successfully used to verify operation of the flight by flight load sequences programmed by two other minicomputers for two major fatigue test programs. In the event of a mis-match in specific load values, at the peak, the check minicomputer automatically shut down the test operation.

The Control Data Corporation 1604 computer system was also used in various ways for test operational safety to identify out of tolerance data points during test on-line operations. It remained in operation for all test programs until the System Engineering Laboratories 86 system came on line for the F-4C/D and Advanced Metallic Air Vehicle Structure (AMAVS) fatigue tests in 1975. At that time it was dedicated to the A-10 static test program and then phased out in December 1977. Parts of the system were shipped to the University of Iowa Nuclear Research Laboratory.

The on-line test capability, where one could see the data plotted as the structures was loaded, and presented in any format desired, with trends displayed for strains, loads, deflections, etc., was in sharp contrast to the earlier years where such data display would have been impossible to obtain. Whether experimental stress analysis will improve as a result of the modern, sophisticated techniques, is unknown. It remains one of the most difficult modern problems to design an airplane with satisfactory mission life at the least possible weight.

## SECTION XIII

### CONCLUSION

As this history shows, structures test methods were slow in developing and, from time to time, the need for that testing was questioned. The value of structures testing to the Air Force has been proven many times over, and has been cost effective to the government while furnishing a unique technical capability which provided the knowledge and experience to solve critical operational problems.

Structures testing is much more complex today when many different technologies are needed to simulate the airplane's ground and flight operations in all environments. The near future may require structures testing in an altitude-controlled chamber where the structure is loaded at elevated temperatures with liquid hydrogen in its fuel tanks.

Improved instrumentation is helping to provide essential data for better structural design techniques using special computer programs. Even so, it is improbable that the requirement for proof of airplane structural capability will ever be totally solved outside of the test laboratory.

This history could be expanded to encompass many more interesting accounts of the progress made in testing structures and of the many different civilian and military people who contributed to it. Some have become internationally recognized for their notable contributions to military and civilian aviation and the sciences. Most names have

been intentionally left out with no intention of slighting them or their contributions in helping to make flying the safest form of military and commercial transportation and a formidable fighting machine. It was not the purpose of this history to assign historical significance to the names of people not already recognized by previous historians except in a few instances. Some can be found in the bibliography and associated with their contributions as future events might dictate.

## APPENDIX A

The list of reports or documents on static testing and structures testing, in this Appendix, dates back to McCook Field shortly after it became the aircraft research and development center for the United States Army in 1917. The Index to Materiel Division Reports contained all of the major structures static tested and listed through 1944. All others were collected from this reference and organization files.

Several changes were made in test reporting procedures since 1944, and it is possible that all test reports are not included prior to that date, but that is purely conjecture. At the beginning of World War II to the present date, sometimes, reports were not written because of high priorities or lack of manpower to complete them. On some major tests, formal reports were written but not published.

Every new organizational change resulted in a different method of issuing technical reports and memorandums. Several major test programs were documented as technical memorandums and not available from the Defense Documentation Center (DDC).

The major and significant trend structures tests accomplished in the Building 65 test facility since 1944 are listed in this Appendix. Where known from local records, the report numbers are listed, but many records and technical test documentation were retired to the St. Louis records center. Extra copies which seemed to have no further value were destroyed. A notation in this Appendix has been made to indicate when a test report was not prepared at the end of the test program.

There were many smaller miscellaneous tests conducted that were not listed in this Appendix from 1917 to the present time. Many tests were conducted for other government organizations such as the Army and Navy, and for different divisions within the Air Force. Many different test operations were performed for other organizations at Wright and Patterson Fields over the years, especially in Building 65. Seat ejection tests and ejection of active duty pilots took place, tests on human subjects were made to determine how much heat they could tolerate, dummy drop tests and parachute harness and strap tests were conducted, to name just a few.

Some report numbers are unknown and the spaces are blank, even though such reports may be available from DDC. For this history, it was deemed of less importance to search for these, since many unproductive hours could be spent. Anyone seriously interested in searching for additional data or completing this test documentation may be successful.

MATERIEL DIVISION TEST PROGRAMS

UP TO 1927

<u>NR.</u>	<u>PROJECT TITLE</u>	<u>TYPE OF TEST</u>	<u>SERIAL TEST REPORT NR.</u>
1.	AE-5A, Type 1, Airplane	Static	1730
2.	Albree Pigeon, Airplane	Static	119
3.	CO-1, Airplane	Static	1975
4.	CO-2, Airplane	Static	2098
5.	CO-6, Airplane	Static	2455
6.	COA-1 Amphibian, Airplane	Static	2536
7.	Curtiss Night Pursuit, Type II, Airplane	Static	1603
8.	D8-1, Airplane	Static	1957
9.	D8-1B, Airplane	Static	2339
10.	DH-4B, Airplane	Static	2526
11.	Elias Training, Type XIV, Airplane	Static	1736
12.	Empire Metal Aircraft, Type X, Airplane	Static	1709
13.	Fokker V-40, Airplane	Static	2001
14.	Huff-Daland Training, Type XIV	Static	1758
15.	Junker L-6 Monoplane, Airplane	Static	1796
16.	Loening, Type I, Airplane	Static	1727

MATERIEL DIVISION TEST PROGRAMS

UP TO 1927

<u>NR.</u>	<u>PROJECT TITLE</u>	<u>TYPE OF TEST</u>	<u>SERIAL TEST REPORT NR.</u>
17.	M-8, Airplane	Static	781
18.	MB-6, Thomas-Morse, Airplane	Static	1920
19.	Messenger, Engineering Division, Airplane	Static	1600
20.	Hook & Dirigible Trapeze, Airplane	Static	2382
21.	U-2, Airplane	Static	2581
22.	Orengo E-2, Airplane	Static	1500
23.	PA-1, Airplane	Static	1902
24.	PG-1, Airplane	Static	1919
25.	PS-1, Airplane	Static	2219
26.	PT-1, Airplane	Static	2578
27.	PW-1A, Airplane	Static	188F
28.	PW-3, Airplane	Static	1839
29.	PW-4, Airplane	Static	2076
30.	PW-7, Airplane	Static	2398
31.	PW-8, Airplane	Static	2394
32.	PW-9, Airplane	Static	2296

MATERIEL DIVISION TEST PROGRAMS

UP TO 1927

<u>NR.</u>	<u>PROJECT TITLE</u>	<u>TYPE OF TEST</u>	<u>SERIAL TEST REPORT NR.</u>
33.	R-5, Fuselage	Static	2399
34.	R-6, Airplane	Static	2458
35.	TA-3, Airplane	Static	1985
36.	TA-6, Airplane	Static	2235
37.	TP-1, Airplane	Static	2154
38.	TW-1, Airplane	Static	1801
39.	TW-2, Airplane	Static	2084
40.	USD-9A, Airplane Serial No. 166	Static	166
41.	USD-9A, Airplane Serial No. 179	Static	179
42.	U.S. Mail Airplane, No. 509	Static	2484
43.	XO-1, Airplane	Static	2523
44.	Cox-Heinkel, Elevators	Static	2477
45.	MB-2, Elevators	Static	2087
46.	PW-9, Special, Elevators	Static	2494
47.	PW-9, Standard, Elevators	Static	2495
48.	TW-1, Duralumin, Elevators	Static	1803

MATERIEL DIVISION TEST PROGRAMS

UP TO 1927

<u>NR.</u>	<u>PROJECT TITLE</u>	<u>TYPE OF TEST</u>	<u>SERIAL TEST REPORT NR.</u>
49.	DH-4B (With Wright R-1 Radial) Engine Mount	Static	2206
50.	NBS-2, Engine Nacelle	Static	2403
51.	Bristol, Veneer, No. 3, Davies Putnam, Fuselage	Static	281
52.	Curtiss Biplane, Model 18-B, Fuselage	Static	972
53.	Curtiss Kirkham, Triplane, Fuselage	Static	835
54.	DH-4, Dayton Wright, Fuselage	Static	1197
55.	DH-4, Dayton Wright, Fuselage	Static	114
56.	DH-4M-2, Fuselage	Static	2475
57.	Fokker, D-VII	Static	1137
58.	GAX-1, Fuselage	Static	1206
59.	Longren, Messenger Type, Fuselage	Static	705
60.	L-W-F, Fuselage	Static	116
61.	MB-3, Fuselage	Static	883
62.	Ordnance, Type D, Fuselage	Static	719
63.	Pomilio FVL-8, Fuselage	Static	707
64.	Pomilio BVL-12, Fuselage	Static	702

MATERIEL DIVISION TEST PROGRAMS

UP TO 1927

<u>NR.</u>	<u>PROJECT TITLE</u>	<u>TYPE OF TEST</u>	<u>SERIAL TEST REPORT NR.</u>
65.	R-5, Thomas-Morse	Static	2399
66.	USAC-1, Veneer, No. 2, Widman, Fuselage	Weather & Sand Load	576
67.	USAC-2, Veneer, No. 1, Haskelite, Fuselage	Static	117
68.	USAC-2, Veneer, Davies-Putnam, Fuselage	Static	118
69.	USAC-2, Veneer, Haskelite, Fuselage	Static	164
70.	USAC-2, Veneer, No. 1, Widman, Fuselage	Static	120
71.	USAC-11, Type X, Fuselage	Static	955
72.	USAO-11, Lepere Triplane, Fuselage	Static	1086
73.	USD-9A, Fuselage	Static	175
74.	VCP-1, Fuselage	Static	921
75.	VE-8, Fuselage	Static	989
76.	Vought, Fuselage	Static	181
77	XB-1, Fuselage	Static	138
78.	XB-1A, Fuselage	Static	1815
79.	XLB-1, Fuselage	Static	2540
80.	CO-4, Split Axle Landing Chassis	Static	2346

MATERIEL DIVISION TEST PROGRAMS

UP TO 1927

<u>NR.</u>	<u>PROJECT TITLE</u>	<u>TYPE OF TEST</u>	<u>SERIAL TEST REPORT NR.</u>
81.	Curtiss 18-B, Landing Chassis	Static	942
82.	Curtiss-Kirkham Triplane, Landing Chassis	Static	850
83.	DH-4, Landing Chassis	Static	1196
84.	DH-4, Air Mail Service Steel Landing Gear	Static	1698
85.	DH-4M, Steel Split Axle, Landing Chassis	Static	2295
86.	DH-4M1, Landing Chassis	Static	2347
87.	Fokker D-VII, Landing Chassis	Static	1168
88.	GAX-1, Landing Chassis	Static	1406
89.	J11-4 With J.V. Martin Shock Absorbing Wheels, Landing Chassis	Static	1595
90.	Messenger, Steel Landing Chassis	Static	1598
91.	NBS-2, Landing Chassis	Static	2403
92.	Ordinance Engineering Corp., Type D, Landing Chassis	Static	761
93.	Pomilio, BVL-12, Landing Chassis	Static	891
94.	Pomilio, FVL-8, Landing Chassis	Static	799
95.	SE-5, Reinforced Metal & Wood, Landing Chassis	Static	2255

MATERIEL DIVISION TEST PROGRAMS

UP TO 1927

<u>NR.</u>	<u>PROJECT TITLE</u>	<u>TYPE OF TEST</u>	<u>SERIAL TEST REPORT NR.</u>
96.	VCP-1, Landing Chassis	Static	868
97.	VE-9, Landing Chassis	Static	967
98.	XB-1, Landing Chassis	Static	785
99.	Seat, Adjustable, Designed by J.A. Roche	Static	2624
100.	Skis, SE-5	Static	1757
101.	Cox-Heinkel, Observation, Stabilizer	Static	2477
102.	PW-9, Standard, Stabilizer	Static	2495
103.	PW-9, Special, Stabilizer	Static	2494
104.	Curtiss 18-8, Tail Surfaces	Static	927
105.	Curtiss Kirkham Triplane, Tail Surfaces	Static	767
106.	Dayton-Wright DH-4, Tail Surfaces	Static	112, 113, 1174
107.	DB-18, Third Test, Tail Surfaces	Static	2433
108.	DH-4B, Designed by Forest Products Lab., Tail Surfaces	Static	2619
109.	Fokker D-VII, Tail Surfaces	Static	1140
110.	GAX-1, Tail Surfaces	Static	1249
111.	JN-4, Tail Surfaces	Static	316

MATERIEL DIVISION TEST PROGRAMS

UP TO 1927

<u>NR.</u>	<u>PROJECT TITLE</u>	<u>TYPE OF TEST</u>	<u>SERIAL TEST REPORT NR.</u>
112.	MB-3, Tail Surfaces	Static	788
113.	MR-3A, Tail Surfaces	Static	2124
114.	Messenger, Steel, Tail Surfaces	Static	1599
115.	NBS-3, Tail Surfaces	Static	2410
116.	NBS-4, Tail Surfaces	Static	2383
117.	O-2, Horizontal Tail Surfaces	Static	2581
118.	TA-6, Tail Surfaces	Static	2273
119.	USAO-11, Tail Surfaces	Static	1017
120.	VCP-1, Tail Surfaces	Static	866
121.	VE-8, Tail Surfaces	Static	978
122.	Vought, Tail Surfaces	Static	183
123.	X-CO-7B, Tail Surfaces	Static	2432
124.	XO-3, Horizontal Tail Surfaces	Static	2592
125.	A-1, Ambulance Wing Spar	Static	2461
126	Aeromarine, Duralumin, Experimental Wing, 2nd Article	Static	2501
127.	Boeing, Experimental, Beam	Static	2434

MATERIAL DIVISION TEST PROGRAMS

UP TO 1927

<u>NR.</u>	<u>PROJECT TITLE</u>	<u>TYPE OF TEST</u>	<u>SERIAL TEST REPORT NR.</u>
128.	CO-4, Wing	Static	2209
129.	Curtiss, Type XII, Thick Wing	Static	1961
130.	Biplane, 18-8 Wing	Static	980
131.	Kirkham Triplane Wing	Static	769
132.	D8-1 Metal Wing Spar, 10-1/2 Inch Section	Static	2115
133.	D8-18 Wing	Static	2283
134.	DH-4 Wing Truss Reversed	Static	111, 115
135.	DH-4 Wing Cellule	Static	1194
136.	DH-48-M Metal Wing	Static	2624
137.	DH-4M-1 Wing	Static	2347
138.	Engineering Division Experimental Wood Box Wing Beam	Static	2430
139.	Engineering Division Experimental Steel Spar	Static	2471
140.	Fokker D-VII, Wing Structure	Static	1200
141.	Fokker V-40, Special Wing	Static	1955
142.	GAX-1 Wing Structure	Static	1437
143.	JN-4 Metal Wings	Static	282

MATERIEL DIVISION TEST PROGRAMS  
 UP TO 1927

<u>NR.</u>	<u>PROJECT TITLE</u>	<u>TYPE OF TEST</u>	<u>SERIAL TEST REPORT NR.</u>
144.	JN-4D, Wood and Metal Wings	Static	154
145.	JN-4D Veneer Covered Wings	Static	645
146.	Kerber-Boulton Wing Beam	Static	2401
147.	Kerber-Boulton Wing Spar, Second Article	Static	2620
148.	Loening Monoplane, Single Seater (Wings)	Static	686
149.	L-12, Internally Braced Wings	Static	792

MATERIEL DIVISION TEST PROGRAMS

JANUARY 1927 - DECEMBER 1930

<u>NR.</u>	<u>PROJECT TITLE</u>	<u>TYPE OF TEST</u>	<u>SERIAL TEST REPORT NR.</u>
150.	C-2, Atlantic, Aileron & Controls	Static Proof	2776
151.	C-6 Sikorsky, Ailerons	Static Proof	3214
152.	O-2K Douglas, Ailerons	Static Proof	2926
153.	XB-1B Keystone, Fuselage	Static Torsion	2993
154.	XHB-3 Keystone, Experimental 2 Spar Wing	Static	2867
155.	XHB-3 Keystone, Experimental 3 Spar Wing Monoplane	Static	2852
156.	XHB-3 Keystone, Multi-Spar Wing & Comparisons	Static	3126
157.	LB-5A Keystone, Fuselage	Static Torsion	2962
158.	XLB-6 Keystone, Aluminum Alloy Rudder	Static	2951
159.	XLB-6 Keystone, Fuselage	Static Torsion	2961
160.	C-2 Atlantic, Horizontal Tail, Aileron & Controls	Static Proof	2776
161.	C-2A Atlantic, Floor, Seat & Safety Belt	Static & Dynamic	3048
162.	C-6 Sikorsky, Ailerons	Static Proof	3214
163.	C-9 Ford, Chair & Floor	Static	3128
164.	O-1C Curtiss Landing Chassis (Olco Type)	Static	3161

MATERIEL DIVISION TEST PROGRAMS  
 JANUARY 1927 - DECEMBER 1930

<u>NR.</u>	<u>PROJECT TITLE</u>	<u>TYPE OF TEST</u>	<u>SERIAL TEST REPORT NR.</u>
165.	O-1E Curtiss, Horizontal Tail	Static	3232
166.	O-2K Douglas, Horizontal Tail, Ailerons & Controls	Static Proof	2925
167.	O-15 Keystone, Special Observation	Static	2994
168.	O-19 Thomas-Morse, Horizontal Tail	Static	3072
169.	O-19B Thomas-Morse, Airplane	Static & Dynamic	3662
170.	XO-14 Douglas, Airplane	Static	3013
171.	XO-15 Keystone, Special Observation, Airplane	Static	2994
172.	XO-27 Fokker, Airplane	Static	3342
173.	P-1 Curtiss, Siversky Ski	Static	2845
174.	P-1B Curtiss, Wing Cellule	Static	3196
175.	P-12 Boeing, Landing Chassis	Dynamic	3096
176.	XP-13 Thomas-Morse, Wing Cellule & Tail Surfaces	Static	3343
177.	XP-16 Berliner-Joyce, Wing Cellule & Tail Surfaces	Static	3327
178.	XPW-9 Boeing, Airplane	Static	3056
179.	PT-3A Consolidated, Wing Cellule	Static	2968

MATERIEL DIVISION TEST PROGRAMS  
JANUARY 1927 - DECEMBER 1930

<u>NR.</u>	<u>PROJECT TITLE</u>	<u>TYPE OF TEST</u>	<u>SERIAL TEST REPORT NR.</u>
180.	2T-1 Great Lakes, Airplane	Static & Dynamic	3271
181.	Waco, Commercial, Airplane	Static	2811

MATERIEL DIVISION TEST PROGRAMS  
 JANUARY - DECEMBER 1931

<u>NR.</u>	<u>PROJECT TITLE</u>	<u>TYPE OF TEST</u>	<u>SERIAL TEST REPORT NR.</u>
182.	XA-8 Curtiss, Airplane	Static & Dynamic	3567
183.	B-3A Keystone, Airplane	Static & Dynamic	3475
184.	XB-901, Boeing, Airplane	Torsion	3518
185.	O-25A Douglas	Static & Dynamic	3488
186.	XP-9 Boeing, Airplane	Static & Dynamic	3554

JANUARY - DECEMBER 1932

187.	XO-35 Douglas, Wing Cellule & McCollum- Peters Electric Telemeter	Static	3627
188.	P-6E Curtiss, Landing Gear	Static & Dynamic	3600
189.	XP-936 Boeing, Wing	Torsion	3672

MATERIEL DIVISION TEST PROGRAMS

JANUARY - DECEMBER 1933

<u>NR.</u>	<u>PROJECT TITLE</u>	<u>TYPE OF TEST</u>	<u>SERIAL TEST REPORT NR.</u>
190.	Y0-31A Douglas, Airplane	Static & Dynamic	3871
191.	Y10-43 Douglas, Wing	Torsion	3779
192.	Y1P-25 Consolidated, Wing	Torsion	3761
193.	Y1P-26 Boeing, Airplane	Static & Dynamic	3885

JANUARY - DECEMBER 1934

194.	Y10-40A & B Curtiss, Wing Cellule	Static & Dynamic	3931
195.	P-128 Boeing, Airplane	Static	3957

JANUARY - DECEMBER 1935

196.	P-1F Curtiss, Fuselage	Static	4050
197.	Y0A-5 Douglas, Landing Gear	Dynamic	4058
198.	P-30 Consolidated, Airplane	Static & Dynamic	4115

MATERIEL DIVISION TEST PROGRAMS

JANUARY - DECEMBER 1936

<u>NR.</u>	<u>PROJECT TITLE</u>	<u>TYPE OF TEST</u>	<u>SERIAL TEST REPORT NR.</u>
199.	A-11 Consolidated, Airplane	Static & Dynamic	4262
200.	A-17 Northrop, Airplane	Static & Dynamic	4233
201.	YB-9A Boeing, Center Section	Torsion	4183
202.	B-10 Martin, Airplane	Static & Dynamic	4254
203.	PB-2A Consolidated, Airplane	Static & Dynamic	4247
204.	Pressure Cabin Investigations	Static & Dynamic	4220

JANUARY - DECEMBER 1937

205.	A-17 Northrop, Main Landing Gear	Structural	4287
206.	A-17A Northrop, Airplane	Structural	4345
207.	BT-8 Seversky, Airplane & Second Static Test of Wing	Structural	4288
208.	BT-9 North American, Airplane	Structural	4289
209.	PT-13A Stearman, Airplane	Structural	4297
210.	O-1430 Continental, Engine Mount	Static	4295

MATERIEL DIVISION TEST PROGRAMS

JANUARY - DECEMBER 1938

<u>NR.</u>	<u>PROJECT TITLE</u>	<u>TYPE OF TEST</u>	<u>SERIAL TEST REPORT NR.</u>
211.	YB-10 Martin, Aileron & Control System	Structural	4415
212.	P-35 Seversky, Airplane	Structural	4397
213.	BT-8 Seversky, Special Type Wing	Structural	4386

JANUARY - DECEMBER 1939

214.	8C-1 North American Adhesive Tension Patch vs. Cushion Lifting Pad Method	Static	4486
215.	B-18 Douglas, Airplane	Structural	4435
216.	O-46A Douglas, Airplane	Structural	4434

MATERIEL DIVISION TEST PROGRAMS

JANUARY - DECEMBER 1940

NR.	PROJECT TITLE	TYPE OF TEST	SERIAL TEST REPORT NR.
217.	Y1A-18 Curtiss, Airplane	Structural	4553
218.	BC-1 North American, Airplane	Structural	4575
219.	BC-1 North American, Study of Adhesive Tension Patch Testing Compared to Standard Sand Test		4527
220.	BC-1 North American, Wing, E.G. Budd Stainless	Structural	4589
221.	O-47A North American, Airplane	Structural	4557
222.	P-36A Curtiss, Airplane	Structural	4592
223.	YP-37 Curtiss, Airplane	Structural	4591
224.	BT-14 North American, Airplane	Structural	4586

JANUARY - DECEMBER 1941

225.	B-23 Douglas, Experimental Bomb Rack	Proof	4704
------	--------------------------------------	-------	------

MATERIEL DIVISION TEST PROGRAMS

JANUARY - DECEMBER 1942

<u>NR.</u>	<u>PROJECT TITLE</u>	<u>TYPE OF TEST</u>	<u>SERIAL TEST REPORT NR.</u>
226.	A-20A Douglas, Airplane	Structural	4732
227.	B-25 North American, Airplane	Structural	4823
228.	XFM-1 Bell, Airplane	Structural	4734
229.	P-39C Bell, Airplane	Structural	4736
230.	P-39D Bell, Airplane	Structural	4809
231.	8C-1A North American, Airplane	Structural	4738
232.	B1-13 Vultee, Airplane	Structural	4735
233.	PT-19 & PT-19A Fairchild, Half Fork Main Gear	Structural	4737
234.	PT-21 Ryan, Airplane	Structural	4807

JANUARY - DECEMBER 1943

235.	AT-10 Beech, Airplane	Structural	4959
236.	P-40D, Airplane - P-40E, Wing	Structural	4889
237.	YP-38 Lockheed, Airplane	Structural	4924
238.	Martin B-26, Airplane	Structural	4962

MATERIEL DIVISION TEST PROGRAMS

JANUARY - DECEMBER 1944

<u>NR.</u>	<u>PROJECT TITLE</u>	<u>TYPE OF TEST</u>	<u>SERIAL TEST REPORT NR.</u>
239.	C-46 Curtiss-Wright, Airplane	Structural	5106
240.	BT-12 Fleetwings, Airplane	Structural	5101
241.	P-47B & P-47D (Republic), Airplane	Structural	5118

JANUARY 1945 - DECEMBER 1946

242.	AT-21 Fairchild, Airplane	Structural	5208
243.	XP-63 Bell, Airplane	Structural	5294
244.	YP-80, Lockheed, Airplane	Structural	5330
245.	L-5 Stinson, Airplane	Structural	5218
246.	AT-60 North American, Airplane	Structural	5364

BUILDING 65 STRUCTURAL TEST PROGRAMS

<u>NR.</u>	<u>PROJECT TITLE</u>	<u>TYPE OF TEST</u>	<u>TEST REPORT NR.</u>	<u>DATE</u>
1.	XA-38, Beech, Airplane	Static		1943-44
2.	B-32, Convair, Airplane	Static		1945-46
3.	C-82, Fairchild, Airplane	Static	4162-19-45 & Add. 1-15	1945-47
4.	B-25J, North American, Wings	Static		1945
5.	C-69, Lockheed, Airplane	Static	4162-28-38 & Add. 1-20	1945-46
6.	P-51D, North American, Wings	Static		1945
7.	AT-6, Aircraft Laboratory Glass Wings	Static		1945-49
8.	P-83 (XP), Bell, Airplane	Static	4302-32-26 & Add. 1-10	1945-46
9.	P-82 North American, Airplane	Static		1945-46
10.	P-51H, North American, Airplane	Static	4302-28-37 & Add. 1-14	1945-46
11.	CG-14A, Chase, Glider	Static	4562-21-13 & Add. 1-23	1946
12.	AT-60, North American, Wings	Fatigue		1946
13.	F-11, Hughes, Airplane	Static	4092-4-35 & Add. 1-7	1946-47
14.	C-74, Douglas, Airplane	Static		1946-48
15.	P-47D-28, Republic, Dive Weary	Static		1946
16.	P-51D, North American, Dive Weary	Static		1946

BUILDING 65 STRUCTURAL TEST PROGRAMS

<u>NR.</u>	<u>PROJECT TITLE</u>	<u>TYPE OF TEST</u>	<u>TEST REPORT NR.</u>	<u>DATE</u>
17.	AT-6, Owens Corning, Glass Wings	Static	45131-2-1	1946
18.	P-81, Convair, Airplane	Static	4302-29-38 & Add. 1-9	1946-47
19.	L-13, Consolidated-Vultee, Airplane	Static	4362-4-27 & Add. 1-11	1946-47
20.	F-15, Dow Chemical Co., Boom	Static	45113-3-1	1946
21.	V-1650 Engine Wooden Transportation Cradle	Static	657-2	1946
22.	F-84, Republic, Airplane	Static		1947
23.	P-61, Narmco, Plastic Boom	Static	45119-4-1 & Add. 2	1947-48
24.	CG-10A Boom	Static		1947
25.	P-80, East Coast, Magnesium Wings	Static Elastic Axis	45120-4-1 & Add. 1 & 2 45120-3-3	1947-48
26.	XP-84, F-84B, C & D, Republic, Airplanes	Static	4302-42-37 & Add. 1-17	1947-52
27.	B-50, Boeing, Wing	Static	4262-40-16 & Add. 1	1947
28.	C-54D, Goodyear, Liaison Antenna Wing Tip	Static	112-3	1947
29.	C-46, AMC Pigid Glider Tow Bar	Static	45323-2-1	1947
30.	Tison Brothers Control Column	Static	45340-2-1	1947
31.	Rivet Hole Strain Gage Study	Static	45118-3-1	1947
32.	F-15, Northrop, Magnesium Boom	Static	45113-3-2 (Strain)	1947

BUILDING 55 STRUCTURAL TEST PROGRAMS

NR.	PROJEC <sup>n</sup> TITLE	TYPE OF TEST	TEST REPORT NR.	DATE
33.	TG-180 Engine Adapters	Static	657-5-1	1947
34.	AT-6, Air Materiel Command Fiber Glass Wing	Static	4536-2-33 & Add. 3	1947
35.	F-84D, Republic, Wings	Fatigue		1948
36.	AT-6D, Chrysler Glass Stabilizer	Static		1948 & 50
37.	B-36, Convair, Airplane	Static	4262-13-45 & Add. 1-42	1948-50
38.	B-45A, North American, Airplane	Static	MCPREXA 8-4262-42-2P & Add. 1-2	1948-49
39.	F-86A, North American, Airplane	Static		1948
40.	CG-18A, Chase, Glider	Static	4562-30-14 & Add. 1-9 & 16	1948-49
41.	F-80, East Coast, Thick Skin Aluminum Wings	Static	MCPREXA 8-45117-2-1 & Add. 1	1948
42.	L-15, Beeing, Airplane	Static	4362-10-22 & Add. 1-3	1948 & 50
43.	BT-15, Plaskon, Glass Cloth Sandwich Aft Fuselage	Static	4536-6-1	1948
44.	Two Dismountable Rectangular Containers	Static	561-1-1	1948
45.	AT-6D, Goodyear, Experimental Sandwich Horizontal Stabilizer	Static	45137-2-1	1948
46.	AT-6D, Chrysler Experimental Sandwich Horizontal Stabilizer	Static	45137-3-1	1948
47.	Bomb Sway Brace	Static	42621-2-1	1948

BUILDING 65 STRUCTURAL TEST PROGRAMS

<u>NR.</u>	<u>PROJECT TITLE</u>	<u>TYPE OF TEST</u>	<u>TEST REPORT NR.</u>	<u>DATE</u>
48.	Evans tilting Arc Engine Sling	Static	657-6-1	1948
49.	F-86A, North American, Airplane	Static	4302-65-22 & Add. 1-4	1948-51
50.	C-45F, Beech, Wings	Static		1949
51.	C-45F, Beech, Wings & Main Landing Gear	Fatigue		1949
52.	Q-2, Ryan, Drone	Static	4482-17-3 & Add. 1-4	1949
53.	AT-6, East Coast, Glass Wing	Static	45137-5-1	1949
54.	F-24E, Republic, Airplane	Static	45137-5-1	1949-52
55.	F-80, East Coast, Tapered Skin Wings	Static	45138-1-1 45138-1-2 (Strain)	1949
56.	AT-6, Two Magnesium Wings	Static	45120-3-3 45120-4-1 & Add. 1 & 2	1949
57.	C-54A, Douglas, Plastic Right Outer Wing Section & Aileron	Static	45131-1-1 & Add. 1	1949-51
58.	Monocoque & Tubular Structures	Static	MCREXA 8-7431-1-1	1949
59.	C-119B, Fairchild, Airplane	Static	4162-34-26 & Add. 1-1B	1950-52
60.	T-33, Wing	Calibration		1950
61.	Nuclear Bombs	Static		1950-51
62.	Nuclear Bomb Dolly Cargo Tiedown	Static		1950-51
63.	F-94A, Lockheed, Airplane	Static	4302-71-37 & Add. 1-3	1950-52

BUILDING 65 STRUCTURAL TEST PROGRAMS

<u>NR.</u>	<u>PROJECT TITLE</u>	<u>TYPE OF TEST</u>	<u>TEST REPORT NR.</u>	<u>DATE</u>
64.	F-89A, Northrop, Airplane	Static	4302-72-24 & Add. 1-17	1950-52
65.	T-28, Fuselage	Static		1950
66.	F-80A, East Coast, Magnesium Fuselage	Static		1950
67.	YF-93A, North American, Wings	Static	MCREXA 8-4302-65-34	1950
68.	C-124A, Douglas, Nose Cargo Doors, Forward Fuselage, Nose Gear Support, Control Systems, Fuselage, Auxiliary Floor, Traveling Crane & Cargo Elevator, Main Cargo Floor & Lower Cargo Floor	Static	4162-40-22	1950
69.	B-50 & C-97A Shipment Dolly & E Power Pkg	Static	4263-90-1	1950
70.	Bomb Sway Brace	Static	42612-2-2	1950
71.	165 Gallon Jettison Tank, Vic Pastushin Industries	Static	524-7-1	1950
72.	RB-45C, North American, Aft Fuselage	Static	4262-43-23	1950
73.	3-50, Boeing, Airplane	Calibration		1951-52
74.	F-86D, North American	Static	4302-71-37 Add. 1-20	1951-52
75.	B-25J, Sandwich Bomb Bay Doors	Static		1951
76.	F-80, Dural Sandwich Wing	Static	WCLS TN 54-22 (1954)	1951
77.	AT-6, East Coast, Wing	Static		1951

BUILDING 65 STRUCTURAL TEST PROGRAMS

<u>NR.</u>	<u>PROJECT TITLE</u>	<u>TYPE OF TEST</u>	<u>TEST REPORT NR.</u>	<u>DATE</u>
78.	AT-6J, Wing	Static	4152-8-4	1951
79.	T-28, North American, Airplane	Static	4152-1-19	1951
80.	C-119, Cargo Tiedown	Static		1951-52
81.	F-84G, Republic, Airplane	Static		1951-52
82.	F-80C, Lockheed, Horizontal Tail	Static	WCNS 4302-68-21	1951
83.	B-47B, Boeing, Airplane	Static	4262-49-28, Add. 1-20	1951
84.	F-80, Lockheed, Empennage & Aft Fuselage	Static	WCNSS 4302-3-1	1951
85.	Litter Support Straps	Static	45330-3-1	1951
86.	XT-28, Wing Flaps	Static		1951
87.	F-84E, Nose Gear	Static		1951
88.	F-94B, Lockheed, Airplane	Static	4302-71-37, Add. 4 (Strain)	1952
89.	F-94A, Titanium Aft Fuselage	Static	45140-1-1	1952
90.	B-36, Convair, Airplane	Wing Calibration		1952
91.	F-94C, Lockheed, Airplane	Static	4302-71-34 & Add. 1-25	1952-53
92.	B-47A, Boeing, Airplane	Hing Calibration		1952
93.	F-89D, Northrop, Airplane	Static	WADC TN 54-38, 39, 40 & WCLS-53-5, 54-47	1952-54
94.	F-84G, Republic, Wings	Fatigue		1952-53

BUILDING 65 STRUCTURAL TEST PROGRAMS

<u>NR.</u>	<u>PROJECT TITLE</u>	<u>TYPE OF TEST</u>	<u>TEST REPORT NR.</u>	<u>DATE</u>
95.	Unit Adapter	Static	WCLS TN 52-26	1952
96.	H-46 Roadable Container (MX-2062)	Static	WCLS TN 52-27	1952
97.	MX-775A Cast Magnesium Wings	Static	WCLS TN 52-30	1952
98.	YF-102, Wing Section	Static Test At Elevated Temp.	WCLS TN 52-9	1952
99.	B-36, Main Landing Gear	Static		1952
100.	F-84G, Republic, Airplane	Static	4302-42-69 & Add. i-5	1952-53
101.	C-124, Gear/Wings	Static		1953
102.	F-89C, Northrop, Emergency Program	Static	WCLS TN 52-28 52-39 (Strain)	1953-54
103.	F-89C, Northrop, Wings	Fatigue	WCLS TN 53-68 (Strain) 53-69	1953-54
104.	F-84F, Republic, Airplane	Static	WADC TN 55-575, 57-136 57-125-129 (Strain)	1953-55
105.	F-86H, North American, Airplane	Static		1953-54
106.	B-57A, Martin, Airplane	Static	WCLS TN 54-58 (Wings) 54-19 (Strain) 54-52 (Fuselage)	1953-54
107.	MX-883, Titanium Wing	Static	TMR WCLS 53-6	1953
108.	H-164 & H-185 Container	Static	WCLS TN 53-26	1953

**BUILDING 65 STRUCTURAL TEST PROGRAMS**

<u>NR.</u>	<u>PROJECT TITLE</u>	<u>TYPE OF TEST</u>	<u>TEST REPORT NR.</u>	<u>DATE</u>
109.	F-89H, Northrop, Empennage	Static	WCLS TN 53-65	1953
110.	F-89H, Northrop, Nose Gear & Support	Static	WCLS TN 53-67	1953
111.	B-57A, Martin, Nose Gear & Support	Static	WCLS TN 53-77	1953
112.	F-86H, North American, Empennage, Nose Gear & Support	Static	WCLS 53-65 & 67	1953
113.	F-84E, Republic, Wings	Fatigue		1954
114.	RF-84F, Republic, Airplane	Static	WADC TN 55-578 (Strain)	1954-55
115.	F-84F, Republic, Wings	Fatigue	WADC TN 57-136	1954-55
116.	SM-62, Northrop, Snark Missile	Static	WCLS 55-8 & WCLSS-6 Files	1954-55
117.	F-89H, Northrop, Airplane	Static	WADC TN 55-530 57-220	1954-55
118.	H-21C, Vertol, Helicopter	Static	WADC TN 56-506	1954-55
119.	F-80C, East Coast, Magnesium Fuselage, Empennage, Flap & Aileron	Static	WCLS-54-10	1954
120.	F-89C, Northrop, Wing, Supplemental Tests	Static	WCLS 54-37 54-39	1954
121.	F-89C, Northrop, Horizontal Tail & Aft Fuselage	Static	WCLS 54-46	1954
122.	F-89C, Northrop, Modified Airplane	Static	WCLS TN 53-83 (Strain)	1954

BUILDING 65 STRUCTURAL TEST PROGRAMS

<u>NR.</u>	<u>PROJECT TITLE</u>	<u>TYPE OF TEST</u>	<u>TEST REPORT</u>	<u>DATE</u>
123.	B-57A, Martin, Control Systems	Static	WCLS TN 53-80	1954
124.	B-36, Engine Components	Static	WCLS TN 54-54 & 54-17	1954
125.	H-275 Container	Static	WCLS TN 54-8	1954
126.	F-80, East Coast, Dural Sandwich Wing	Static	WCLS TN 54-22	1954
127.	B-57A, Martin, Main Landing Gear & Support	Static	WCLS TN 54-34	1954
128.	F-84F, Republic, Airplane	Wing Calibration		1955
129.	C-123B, Fairchild, Airplane	Static		1955-56
130.	F-86F, North American, Wings	Static		1955
131.	F-86F, North American, Wings	Fatigue		1955
132.	F-102A, Convair, Airplane	Static	Manuscript Lost	1955-57
133.	F-86H, North American, External Stores Pylons	Static	WCLS 55-11	
134.	B-57A, Martin, Special weapons Bomb Door	Static	WADC TN 55-92 (Strain)	1955
135.	B-57A, Martin, Aileron & Flaps	Static	WADC TN 55-4	1955
136.	F-89H, Northrop, External Stores Pylons	Static	WCLS TN 55-11	1955
137.	F-80, East Coast, Magnesium Wing	Static	WCLS TN 55-14	1955
138.	F-89D, Northrop, Modified Airplane	Static	WCLS TN 55-16	1955

BUILDING 65 STRUCTURAL TEST PROGRAMS

<u>NR.</u>	<u>PROJECT TITLE</u>	<u>TYPE OF TEST</u>	<u>TEST REPORT NR.</u>	<u>DATE</u>
139.	Navaho Fin, North American	Static Test At Elevated Temp.		1956-57
140.	F-104A, Lockheed, Airplane	Static	WADC TN 59-29 ASTIA AD 304-855	1956-57
141.	Thor Lox Tank, Douglas, Internal Cryogenic Fue Simulation	Boost Elevated Temp.		1956
142.	T-37A, Cessna, Airplane	Static		1956-57
143.	SM-62, Snark, Northrop, Fuselage	Static	WCLSS-6 Files	1956-57
144.	Titan First Stage, Martin, Lox Tanks, Internal Cryogenic Simulation	Boost Elevated Temp.		1956-57
145.	TF-102, Convair, Fuselage	Static		1956-57
146.	Hawk Missile, Northrop	Static Test At Elevated Temp.		1956
147.	X-10, Forward Horizontal Stabilizer	Static	WADC TN 56-436	1956
148.	Nose Cone, Douglas, Dwg. No. 5591268	Static	WADC TN 55-656	1956
149.	B-58A, Convair, Airplane	Static Test At Elevated Temp.	ASD TDR 62-595	1957-62
150.	XH-40, Bell, Helicopter	Static	WADC TN 59-15	1957
151.	F-105, Republic, Airplane	Static	ASD TDR 63-505	1957-59
152.	F-106A, Convair, Airplane	Static Test At Elevated Temp.	WADD TR 6-477	1957-59

BUILDING 65 STRUCTURAL TEST PROGRAMS

<u>NR.</u>	<u>PROJECT TITLE</u>	<u>TYPE OF TEST</u>	<u>TEST REPORT NR.</u>	<u>DATE</u>
153.	F-84F, Republic, Fuselage & Empennage	Static	WADC TN 57-126 57-130 (Strain)	1957
154.	F-84F, Republic, Wing & Forward Fuselage	Static	WADC TN 57-125 57-124 (Strain)	1957
155.	RF-84F, Republic, Fin	Static	WADC TN 57-127	1957
156.	F-84F, Republic, Main & Auxiliary Landing Gear	Static	WADC TN 57-128	1957
157.	High Temperature Plastic Missile Component	Static Test At Elevated Temp.	WADC TN 57-130	1958
158.	F-105D, Republic, Airplane	Fatigue	ASD-TDR 63-505	1960
159.	F-106A, Convair, Airplane	Fatigue	ASD-TDP 63-463	1960-61
160.	X-20, Boeing, Hot Structure, Phase II Included	Re-entry At Elevated Temp.	ASTESS 62-1R	1960-62
161.	X-20, Boeing, Panel	Re-entry		1961
162.	Siliconized Graphite Leading Edge	Static Test At Elevated Temp.	WFESS 61-1	1961
163.	F-106A, Convair Tail Hook	Static	ASTESS 61-4	1961
164.	463L Aerial Delivery System	Static	ASTESS 61-7	1961
165.	F-100, Cockpit/Pilot Tolerance	Thermal Nuclear Pulse	ASTESS 62-2R	1961
166.	Cooled Structure, Bell	Re-entry At Elevated Temp.	ASTESS 61-5	1961

BUILDING 65 STRUCTURAL TEST PROGRAMS

<u>NR.</u>	<u>PROJECT TITLE</u>	<u>TYPE OF TEST</u>	<u>TEST REPORT NR.</u>	<u>DATE</u>
167.	F-104G (MAP), Airplane	Static	FDL TDR 64-40	1961-63
168.	HC-1B (CH-47) Helicopter	Static	RTD TDR 63-4230	1962-63
169.	X-20, Boeing, Dyna Soar Contamination		ASTESS 62-4R	1962
170.	Box Beam, Republic, Thermal Stress	Static Test At Elevated Temp.	ASTESS 62-5R	1962
171.	Thermantic, Aeronca, RTV Water Cooled Panel	Elevated Temp.	ASTESS 63-2R	1962
172.	ASSET Leading Edge	Re-entry At Elevated Temp.	ASTFSS 63-1R	1962
173.	ASR Box Beam			1962
174.	F-100C, Cockpit	Elevated Temp & flare		1962
175.	SST Developmental Wing Boxes	Static		1963-64
176.	SST Developmental Wing Boxes	Elevated Temp. Fatigue		1963-64
177.	F-104G, Lockheed, (MAP)	Fatigue	FDL TDR 64-97	1963-64
178.	F-106A, Convair, "Model Fly"	Influence Coefficient		1963
179.	Lap Belt Buckle Welds	Static		1963
180.	Aft Facing Passenger Seats	Static		1963
181.	Cryogenic Pipe	Bending Failure		1963

BUILDING 65 STRUCTURAL TEST PROGRAMS

	<u>PROJECT TITLE</u>	<u>TYPE OF TEST</u>	<u>TEST REPORT NR.</u>	<u>DATE</u>
182.	Test Tire Compression	Fatigue Test At Elevated Temp.		1963-64
183.	Expandable Solar Collectors	Static Test At Elevated Temp.	AFFDL TR 66-132	1964-65
184.	Thermantic Structure (Internally Cooled)	Re-entry	AFFDL TR 66-76	1964-65
185.	Airmat Inflatable Structure, Goodyear	Static Test At Elevated Temp.	AFFDL TR 65-181	1964-65
186.	F-100, Fuselage	Nuclear Heat Effects		1964
187.	Lightweight Seat, Technology, Inc.	Static		1964
188.	Experimental Net Crew Seat	Static		1964
189.	QRC-160 Pod	Static		1964
190.	X-20, Boeing, Side Window	Elevated Temp.		1964
191.	Al <sub>2</sub> O <sub>3</sub> Ceramic Brittle Materials	Fatigue Test At Elevated Temp.		1964
192.	SR-71, Lockheed, Wing Box & Longeron Splice	Fatigue Test At Elevated Temp.		1965-67
193.	Advanced Structural Concept Experimental Program (ASCEP)	Re-entry	AFFDL TR 70-76	1965-68
194.	X-20, Boeing, Elevon	Re-entry	AFFDL TR 65-191	1965
195.	X-20, Boeing, Window	Re-entry	AFFDL TR 65-211	1965

BUILDING 65 STRUCTURAL TEST PROGRAMS

<u>NR.</u>	<u>PROJECT TITLE</u>	<u>TYPE OF TEST</u>	<u>TEST REPORT NR.</u>	<u>DATE</u>
196.	Alterations in Fatigue Strength of 8-1-i Titanium By Welded Thermocouples	Fatigue	No Report	1965-66
197.	Conversion Shells to Bombs	Static	FDTT 66-1	1966
198.	Boron Horizontal Tail	Fatigue		1966
199.	Fluid Cooled Cabin Wall Panel for Hypersonic Aircraft, Bell Aerosystems	Static Test At Elevated Temp.	AFFDL TR 70-199	1967-68
200.	Boron Box Beam	Fatigue		1966
201.	Boron Cylinder	Static		1966
202.	Scramjet Engine Module	Static		1967
203.	T-38, Cockpit Cargo Pod	Static		1967
204.	KC-135, Boeing, Refueling Boom	Calibration		1967
205.	A-37A, Airplane	Calibration		1967
206.	C-130, Cargo Buffer Stop	Static		1967
207.	TMU/66A Chemical Anti-Crop Dispenser	Static	FDTT 68-2 67-1	1967-68
208.	BLU/27B Napalm Canister (Magnesium)	Static		1968
209.	Hydrogen Cooled Panel & GHz Test Capability	Static Test At Elevated Temp.	Rough Draft	1968
210.	Tantalum Rudder	Re-entry		1968-69
211.	LI-15, Lockheed, Heat Shield Insulation	Re-entry		1968-70

WIND TUNNEL TEST PROGRAMS

<u>NO.</u>	<u>PROJECT TITLE</u>	<u>TYPE OF TEST</u>	<u>TEST REPORT NO.</u>	<u>DATE</u>
212.	Prototype Hander Section	Static		1968
213.	Boron Panel, North American	Static		1968
214.	F-111 Panels	Nuclear		1968
215.	Polyimide Plastic Scramjet Module	Static Test At Elevated Temp.		1968-69
216.	C-130, Cracked Wing Panel	Residual Strength		1968
217.	F-111A, Escape Module Transparency	Fatigue Test At Elevated Temp.		1968
218.	Space Crew Expandable Transfer Tunnel (D-21)	Static		1968
219.	B-52, Thermal Curtain	Nuclear		1968
220.	C-130, Center Wing Sections	Residual Strength		1968
221.	F-111, Boron Horizontal Tail	Fatigue		1968-70
222.	B-52, Escape Hatch	Nuclear		1968
223.	F-4, Modified, Dart Tow Target	Static	FDTT 69-1	1968
224.	F-4, Beryllium Rudder	Residual Strength	FDTT 69-3 & AFFDL TP 74-140	1968
225.	T-37, Boron Landing Gear Outer Cylinders	Cyclic Wear		1968-73
226.	F-111B, Boron Wing Tip	Static/Fatigue		1968-69
227.	WASP Thermal Composites	Re-entry		1968-70

BUILDING 65 STRUCTURAL TEST PROGRAMS

<u>NR.</u>	<u>PROJECT TITLE</u>	<u>TYPE OF TEST</u>	<u>TEST REPORT NR.</u>	<u>DATE</u>
228.	Joint Modeling			1968
229.	Fracture Mechanics	Fatigue		1968
230.	HASP Cryogenic Thermal Simulator			1968
231.	LAFES Extraction Platform	Static		1968
232.	C-5A, Nylon Webbing	Static		1968
233.	Bi-metallic Beam	Thermal Stress		1968
234.	Nylon Braided Extractor Rope	Static		1968
235.	Cargo Delivery System Release Hook	Static		1968
236.	C-141, Cargo Roller Load Distribution	Static		1968
237.	C-141, M38AL Aerial Delivery System (Jeep Tie-Down)	Static		1968
238.	F-5, Expandable Rigidizable External Fuel Tank	Static		1968
239.	Cargo Extraction Parachute Strap	Static		1968
240.	AGM-12 Lanyard Hook	Static		1968
241.	KZB Coverall Helicopter Personnel Pick-up Harness	Static		1968
242.	Personnel Parachute Harness Load	Dynamic		1969
243.	F-111A, Transparencies	Nuclear		1969

BUILDING 65 STRUCTURAL TEST PROGRAMS

<u>NR.</u>	<u>PROJECT TITLE</u>	<u>TYPE OF TEST</u>	<u>TEST REPORT NR.</u>	<u>DATE</u>
244.	F-111, Wing Carry-Through Structure	Survivability/ Vulnerability & Static		1969
245.	A-37, Boron Composite Landing Gear Attach Methods (AFMI)	Static		1969
246.	Columbium Heat Shield, General Dynamics	Re-entry		1969-71
247.	O-2A, Wing & Landing Gear	Calibration		1969
248.	FDL-5, DSM (Dispersion Strengthened Material) Fin (TD-NI-(R))	Re-entry	AFDL 74-36	1969-72
249.	Graphite Heater Evaluation	Elevated Temp.	TM-70-5 FBT	1969-70
250.	Advanced Composite Wing Box (Intermediate)	Static		1969-70
251.	HATS	Static Proof		1969
252.	B-52 & B-58 Window Sections	Nuclear		1969
253.	Boron Epoxy Composite Bi-axial Stress Allowables	Static		1969-72
254.	C-130, C-141 & C-5A Cargo Platform Roller Interface	Static		1969
255.	C-5A, Aerial Delivery Link	Static		1969
256.	Postbuckling Behavior of Heterogeneous Anisotropic Shells	Static		1969
257.	MAU-91 Energy Absorber	Static	FBT 70-3	1969

BUILDING 65 STRUCTURAL TEST PROGRAMS

NR.	PROJECT TITLE	TYPE OF TEST	TEST REPORT NR.	DATE
258.	C-5, Nylon Rope Extraction Line	Static	FBI 70-1	1969
259.	B-58, Angle of Attack Indicator & Magnetic Compass	Nuclear		1969
260.	Paint Samples	Nuclear		1969
261.	Tubular Composite Bi-axial Strength	Static		1969-72
262.	B-52, Honeycomb Panel	Nuclear		1970
263.	AGM-65 Composite Molded Quadrant Missile	Static Test At Elevated Temp.	AFFCL TM 74-47 FBI	1970-72
264.	C-5A, Graphite Leading Edge Slat	Static		1970
265.	Damaged Beryllium Panels	Residual Strength		1970-71
266.	TMU66/A Multiple Tank Configuration Adaptor	Static		1970
267.	Acrylic Transparencies, KC-135 & Boeing 747	Nuclear		1970
268.	F-111 D6ac Flaw Growth (Pivot Box)	Fatigue		1970-71
269.	C-5A, Boron Leading Edge Slat	Fatigue	ASD-TP-76-62	1970-71
270.	Parachute Material	Nuclear		1970
271.	Advanced Composites Wing Box	Fatigue		1970-71
272.	Cargo Pallet Force Transfer Mounting Bracket	Static		1971

BUILDING 65 STRUCTURAL TEST PROGRAMS

<u>NR.</u>	<u>PROJECT TITLE</u>	<u>TYPE OF TEST</u>	<u>TEST REPORT NR.</u>	<u>DATE</u>
273.	H-3, Main Rotor Blade	Fatigue		1971
274.	Aercab Rogallo Wing	Calibration		1971
275.	F-111, Composite Frames and Bulkhead	Static		1971
276.	Composite Materials Mechanical Properties	Static		1971
277.	F-111, Wing Iron Bomb External Store Configuration	Fatigue	AFFDL-TR-76-30	1971-74
279.	Damaged Stressskin Panels	Residual Strength		1971
279.	C-5, Nylon Rope and Strap Extraction Lines	Static		1971
280.	A-7, Weldbonded Wing Section	Static		1971-72
281.	F-5A, Fastener	Fatigue		1971
282.	463L Pollicets	Ultimate Strength		1971
283.	F-5, Graphite Horizontal Tail	Static		1971-72
284.	X-24B, Main Landing Gear	Calibration		1972
285.	HBU-2B/A Lap Belt	Functional		1972
286.	F-106A, Elevation	Nuclear		1972
287.	B-1, Engine Nozzle	Nuclear		1972-74
288.	Advanced Airborn Command Post Structural Specimens	Nuclear		1972-73
289.	Deployable Wing, Parson's	Static		1972-73

BUILDING 65 STRUCTURAL TEST PROGRAMS

<u>HR.</u>	<u>PROJECT TITLE</u>	<u>TYPE OF TEST</u>	<u>TEST REPORT NR.</u>	<u>DATE</u>
290.	C-5A Wing Plank Cracking	Fatigue		1972-73
291.	T-39, Hoist Sling	Proof		1972
292.	F-5, Graphite Horizontal Tail	Fatigue		1972-73
293.	HCU-54/E Polymer Pallets	Static		1972
294.	Diboride Ceramic Nose Cap and Leading Edge, FDL-5A	Static Test At Elevated Temp.		1972-73
295.	BDM Radome Material	Nuclear		1972
296.	UH-1N, Helicopter Rescue Hoist Support	Static		1972
297.	KC-135 & B-52, Radome Materials	Nuclear		1972
298.	Beryllium Properties, Kaweck Beryllco Inc.	Static	No Report	1972
299.	C-5A, Fastener Replacement Interval	Fatigue		1972-73
300.	PRD-49, Material Properties	Static		1972
301.	TACT Wing	Proof		1972-73
302.	Drone Retriever Cable Assembly	Static		1972-73
303.	B-1, Engine Nozzle Seal	Nuclear		1972-73
304.	C-5A, Engine Pylon Lug Crack Growth	Fatigue		1972-73
305.	B-1, Fatigue Spectrum Truncation	Fatigue		1973
306.	PRD-49, Wing	Fatigue		1973

BUILDING 65 STRUCTURAL TEST PROGRAMS

<u>NR.</u>	<u>PROJECT TITLE</u>	<u>TYPE OF TEST</u>	<u>TEST REPORT NR.</u>	<u>DATE</u>
307.	ACLS Forward Parking Bladder Attach Fittings	Static		1973
308.	Composite Bonded Joint Properties	Static/Fatigue		1973
309.	G-5A, Taper Lock Evaluation	Fatigue		1973
310.	Prototype Molded Missile Airframes		AFFDL-TM-74-60 F&T	
311.	Graphite-Epoxy Composite Bi-Axial Stress Allowables	Static		1973-75
312.	F-4, External Wing Tank Ejection	Dynamic	AFFDL-TM-75-169 F&T	1973-74
313.	Laser Damaged Aircraft Skin Survivability	Static/Fatigue		1973-74
314.	B-1, Cold Worked Fastener Hole Improvement	Fatigue		1973-74
315.	NKC-135, Aerial Refueling Boom for X-15 Flight Test	Calibration		1973
316.	F-4E, Slatted Wing Spectrum Truncation	Fatigue		1973
317.	Interference Fit Composite Joints	Fatigue		1973
318.	H-3, Rotor Blade Composite Reinforcement	Fatigue		1973
319.	F-4C/D/E Spectrum Development (ASIP)	Fatigue		1974
320.	AGM-65, AGE Casting	Static		1974
321.	XOM-103, Wing & Empennage	Proof & Calibration		1974

BUILDING 65 STRUCTURAL TEST PROGRAMS

<u>NR.</u>	<u>PROJECT TITLE</u>	<u>TYPE OF TEST</u>	<u>TEST REPORT NR.</u>	<u>DATE</u>
322.	J-Integral	Fatigue		1974
323.	X-24C, Thermal Protective System	Elevated Temp.		1974
324.	PRD-49(Kevlar) Epoxy Composite Bi-axial Stress Allowables	Static		1974
325.	Advanced Metallic Air Vehicle Structure (AMAVS) Wing Carry Through	Static/Fatigue & Damage Tolerant	Rough Draft	1974-77
326.	F-111, Bird Resistant Transparencies	Static Test At Elevated Temp/ Fatigue Test At Elevated Temp.		1974-77
327.	F-4C/D, Airplane, Life Extension	Fatigue		1974-79
328.	A-10, Republic, Airplane	Static		1974-78
329.	Universal Lifting Slings	Static		1974
330.	B-1, Radome	Nuclear		1974
331.	F-15, Composite Wing	Static/Fatigue		1974
332.	Coating Evaluation (AFML)	Nuclear		1974
333.	KC-135 Rudderator	Nuclear	No Report	1974
334.	Biaxial Tubular Composites	Static		1974-75
335.	A-7, Advanced Structural Box Beams (LTV)	Fatigue		1974-77
33C.	AABNCP	Nuclear		1974

BUILDING 65 STRUCTURAL TEST PROGRAM

<u>NR.</u>	<u>PROJECT TITLE</u>	<u>TYPE OF TEST</u>	<u>TEST REPORT NR.</u>	<u>DATE</u>
337.	AMAVS T-1 Study	Fatigue		1974-75
338.	Nuclear Pulse Simulator	240 BTU/sec. in One Sec.		1974
339.	Adhesively Bonded Composite Joints	Static	AFFDL-TR-75-26	1974
340.	Graphite Epoxy Laminates	Fatigue		1974
341.	Fatigue Rated Fasteners	Evaluation		1974
342.	B-1, Advanced Composite Bolted Joints Bending Beams	Fatigue		1974
343.	C-5A, Pallet Lock Release Mechanism	Static		1974
344.	Off-Axis Composite Coupons	Failure		1974
345.	A-37, Graphite Gear Side Brace	Fatigue		1974
346.	KC-135 Antenna, TACAN Antenna & Direct. Lights	Nuclear		1974
347.	Grumman Composite Box Beam	Static Test At Elevated Temp.		1974
348.	Boron Composite Material Property	Static		1974
349.	A-10/GAU-8 30mm Aluminum Cartridge	Residual Strength		1974
350.	Cable Tests ASD/ENFL	Fatigue		1974
351.	Cracked Aluminum Structures	Proof		1975
352.	HBU-2B (T-38) Lap Belt	Dynamic		1975

**BUILDING 65 STRUCTURAL TEST PROGRAMS**

<u>NR.</u>	<u>PROJECT TITLE</u>	<u>TYPE OF TEST</u>	<u>TEST REPORT NR.</u>	<u>DATE</u>
353.	Paint Samples AFML	Nuclear		1975
354.	AMAVS Fastener	Fatigue		1975
355.	F-4 Boron Rudder	Moisture/Balance		1975
356.	Fiber-Reinforced Plastic Tube	Static		1975
357.	90-5J Bede Gear	Landing Gear Evaluation		1975
358.	B-52 Element Proof Load	Fracture/Fatigue		1975
359.	Laser Mount	Calibration		1975
360.	Remote Piloted Vehicle Plastic Spar	Static		1975
361.	Lifting Sling Part No. 7335807	Proof		1975
362.	A-10 Recovery Program Element	Fatigue		1975
363.	Recessed Fastener Study	Tool Wear		1976
364.	AEDC C-3 Composite Blade (Compressor)	Fatigue Test At Elevated Temp.		1976-77
365.	SAAB-Viggen AJ-37 Element	Fatigue		1976
366.	C-141 Crack Growth	Fatigue		1976
367.	IMFRAU Antenna Mast	Static		1976
368.	JP-4 Fuel Effect on Graphite Epoxy Composites	Static		1977

BUILDING 65 STRUCTURAL TEST PROGRAMS

<u>NR.</u>	<u>PROJECT TITLE</u>	<u>TYPE OF TEST</u>	<u>TEST REPORT NR.</u>	<u>DATE</u>
369.	C-141 LIDS Petal Door	Calibration/ Flight Eval.		1977-78
370.	HAVE BOUNCE F-4 Roudh Landing	Calibration		1977-79
371.	Off-Axis Coupon Test	Fatigue		1977
372.	Off-Axis Unidirectional Composite Laminates	Static		1977
373.	MHU-141M Munitions Handling Trailer	Static	TM-FBT	1977
374.	Nylon Sling	Proof		1977
375.	Bi-Axial Tubular Composite (Kevlar & Boron)	Static		1977-78
376.	40K TAC Cargo Loader Bed	Static		1977
377.	Advanced Metallic Structures Box Beam (Comp-Metal)	Static		1977
378.	RPV Horizontal Stabilizer	Failure		1977
379.	MKC-135/3135 Refueling Boom	Calibration		1977
380.	F-16 Crack Growth	Fatigue		1977
381.	Cycle Counting Techniques	Fatigue		1977
382.	Composite Failure Mechanisms	Fatigue		1977
383.	Constant Stress Intensity Crack Growth	Fatigue		1977
384.	Fatigue Rated Fasteners	Fatigue Eval.		1977

BUILDING 65 STRUCTURAL TEST PROGRAMS

<u>NR.</u>	<u>PROJECT TITLE</u>	<u>TYPE OF TEST</u>	<u>TEST REPORT NR.</u>	<u>DATE</u>
385.	Acoustic Emission Detection AMAVS	Damage Detection		1977
386.	Boeing CAST, Frame	Static & Fatigue		1978-79
387.	Laminated Wing Box Structures			1978-79
388.	Nuclear Weapon Cargo Tie-Down	Static		1978-79

APPENDIX B  
FY-73 TEST ACTIVITIES AND MANHOURS

A complete manhour listing for the Building 65 structures test facility operation in fiscal year 1973 is presented in this Appendix.

Appendix A lists only those test programs which involved large manhour expenditures. It is not totally representative of the work efforts accomplished each year. Not all the activities listed involved actual test operations and reflect engineering consulting and involvement in programs across the laboratories, the Aeronautical Systems Division, 4950th Air Base Wing, Air Force Logistics Command and other Air Force Systems Command facilities.

Manpower varied each year and decreased each year from a combination of things, mostly budget/manpower reductions and organizational changes. This resulted in efforts to find ways to do the same level of work with fewer personnel through improved test methods in spite of increased work load from new test requirements.

In 1949, there were 156 civilians and approximately 20 military personnel working in Building 65. This time period required the largest number of workers for Building 65 operations. The bulk of the work involved wage grade manpower for handling shot bags used in static test conditions.

The Fiscal Year 1973 data represents 95 positions for the 111 tasks listed.

Manpower strength in Fiscal Year 1979 is at the lowest level in history with 76 civilian and 10 military positions. Only 27 of these positions are wage grade.

<u>CHARGE NR.</u>	<u>TITLE</u>	<u>HOURS</u>
11730101	TAC Drone Static Test	773
12445001	TAC Loader Proof Test	2726
13470206	Fatigue Damage Sensor Evaluation	1391
13470318	Neuber Fatigue Analysis	1395
13470321	Pure Shear Testing	515
13470401	Fatigue Damage Sensor Evaluation	2334
13470402	Embedded Foil Strain Gage	172
13470403	Capacitance Strain Gages	855
13470405	Acoustic Emission Damage Detection	2208
13470408	Neuber Fatigue Analysis	1608
13470409	Thin Sheet Fracture Mechanics	4112
13470410	Pure Shear Testing	509
13470412	Standard/x Structure Test	2122
13470413	Fatigue Crack Propagation Study	574
13470414	Subsurface Strain Measurement	139
13470601	Standard/x Structure Test	990
13662107	X-24B Design Allowable Test	1378
13680102	Ballistic Impact Beryllium	274
13680109	Dispersion Strengthened Nickel	408
13680110	Damage Tolerant Laminated Composite	569
13680207	Wing Cap Leading Edge High Load	2859
13680208	Hypersonic Aerostructure Test (HATS)	121
13680210	Non-Integral Strength Hypersonic Vehicle	17
13680707	Weldbond Airframe Component Evaluation	104

<u>CHARGE NR.</u>	<u>TITLE</u>	<u>HOURS</u>
13681301	Dispersion Strength Nickel	4737
13690120	A-37B Gear Shaker Test	24
13690126	Graphite Composite Landing Gear	77
13690128	Filament Landing Gear Wear Test	594
13690129	Graphite Landing Gear Components	2874
13691103	Graphite Composite Landing Gear	321
13691105	Filament Landing Gear Wear Test	388
13691106	Graphite Landing Gear Components	1664
139A0000	B-1A	9962
139A0501	B-1 Structure Consulting	3511
139A0502	B-1 Engine Seal Thermal Test	5048
14310209	X-24B Distribution Allowable Test	1361
14670225	Development and Evaluation Structure Analysis Methods	1079
14670406	Development and Evaluation Structure Analysis Methods	376
19260001	Bird Resistant Windshield	312
19260002	F-111 Windshield Analysis and Test	585
19260003	Bird Resistant Windshield	445
19260301	J-Integral Fracture	4342
19290302	Load Sequence Effects	607
19290501	J-Integral Fracture	79
319A0000	AGM-65A Maverick	1440
324A0000	F-111	805
324A0501	F-111A Wing Fatigue Test	23605
324A0502	F-111 Glass Transparency Fatigue Test	125

<u>CHARGE NR.</u>	<u>TITLE</u>	<u>HOURS</u>
327A0000	F-4C	1661
327A5001	F-4C/D Fatigue Test	310
327C0000	F-4E Improvements	302
327C5001	F-4E Fatigue Spectrum	21
327C5002	F-4 Outboard Fuel Tank	294
329A0000	A-X Close Air Support Aircraft	909
330B0000	F-5E International Fighter Aircraft	309
37630000	Thermal Response Test	292
410A0090	C-5A	10223
410A0501	Boron Leading Edge Slat/C-5A	98
410A0502	C-5A Wing Plank Cracking	6702
410A0503	Wing Fastener Fatigue	14398
410A0504	C-5A Pylon Aft Truss Lugs	1877
410A0595	Taper Lock Evaluation Tests	194
412A0000	Life Support System	168
43620501	Wing Cap Leading Edge High Load	1269
43620502	Hypersonic Aerostructure Test (HATS)	415
43630116	Variable Geometry Aircraft External Fitting	71
43630117	Variable Geometry External Fuel Tanks	946
43630202	Survival Simulation Techniques	388
43630701	Variable Geometry Aircraft External Fitting	203
43630702	Variable Geometry Fuel Tanks	40
43640006	Biaxial Theory Verification	710
43640007	Test Tube Combined Biaxial Strength	739

<u>CHARGE NR.</u>	<u>TITLE</u>	<u>HOURS</u>
43640009	Tube Graphite Epoxy Stress	2554
43640011	Joint Fatigue Design	1503
43640014	Bonded Joints Composite Structures	962
43640016	Bonded Composite Joints	4579
43640017	PRD-49 Composites	22
43640019	Fracture Mechanics Composite Material	28
43640022	Composites Facility	957
43640023	PRD-49 Epoxy Composite Evaluation	880
43640203	Test Tube Composite Biaxial Strength	618
43640304	Joint Fatigue Design	874
43640307	Composite Test Static and Fatigue	574
43640340	Bonded Composite Joints	887
43640542	Interference Fit System	455
43660101	AC-130A Gun Ship	70
443N0000	UH-1H	588
443N0101	UH-1H Rescue Hoist Test	2799
443N0102	Hoist Vibration Test	232
468A0000	Compass Arrow	4
468B0000	Compass Arrow	120
481R0000	Advanced Airborne Command Post	330
484A0101	SCW Development	11944
485B0000	HCH-3LE	722
486U0103	Wing Carry Through Structure	1056
486U0104	Wing Carry Through Structure	5509

<u>CHARGE NR.</u>	<u>TITLE</u>	<u>HOURS</u>
486U0105	Advanced Metallic Air Vehicle Structures Test	1374
60650407	Application Deployable Wing Encapsulation	326
60650410	Deployable Wing Structure	210
60650914	Application Deployable Wing Component	808
61460205	Rotating Heat Exchanger	38
69500101	Air Cushion Landing System Development Program	966
69CW0108	Graphite Contract	3754
69CW0115	Air Force Material Laboratory Box Beam Static Test	639
88090300	Thermal Survivability/Vulnerability Analysis KC-135	1580
9991404L	Microwave Landing System	69
9991484A	Transonic Aircraft Technology Advancement	2216
99936211	Structures Test Facility Improvement	3931
99939210	Structures Test Facility Maintenance	7702
99939805	Equipment And Material Activities	1708
99949801	Training	6946
	TOTAL MANHOURS	205,587
Annual Leave, Sick Leave and Holidays	TOTAL MANHOURS	37,549

BIBLIOGRAPHY

- Aircraft Yearbook 1920-1929, Aeronautical Chamber of Commerce of America, Inc., New York City.
- Part 04 - Airplane Airworthiness, Civil Aeronautics Board, Civil Air Regulations, U.S. Government Printing Office, 1942.
- Airplane Strength and Rigidity Ground Test, Military Specifications, Mil Spec 5700, 8867-A & B.
- 50th Anniversary - A Pictorial Review of WPAFB, 1917-1967.
- Aviation Week and Space Technology, pp. 69, McGraw-Hill Publication, November 28, 1977.
- The B-1 Building a Better Bomber, Aerospace Safety, July 1974.
- Bachman, R.W. & H.M. Wells, Jr., Detail Requirements and Status, Air Force Structural Integrity Program, ASD Technical Note 61-141, Part II, Structures and Air Environment Division, ASD, WPAFB, Ohio, September 1961.
- Baird, Richard B. Equipment and Heating Methods for Structural Testing at Elevated Temperatures, WADC TN 55-149, Aircraft Laboratory, WPAFB, Ohio, September 1955.
- , Wright Air Development Center Elevated Temperature Facility, Volume XVII, Number 1, 1959, Experimental Stress Analysis - Proceedings of the Society for Experimental Stress Analysis.
- Beck, Clark E. Handbook for Test Engineers (Radiant Heating), Aeronautical Systems Division, AFSC, WPAFB, Ohio, February 1963.
- Bennett, J.A., A Study of Fatigue in Metals by Means of X-ray Strain Measurement, Volume IX, No. 2, Experimental Stress Analysis - Proceedings of the Society for Experimental Stress Analysis, 1952.
- Biennial Report, July 1962-July 1964, Air Force Laboratories, Research & Technology Division, AFSC, WPAFB, Ohio.
- Blee, H.H., Capt, History of Reorganization and Activities of Airplane Engineering Division, Serial No. Misc. 220, Bureau of Aircraft Production, August 15, 1919.
- Bluhm, Joseph I, Stress-Strain Relationships, M.R. Serial No. TSEAC 12-4625-3-1, Air Materiel Command, Engineering Division, Aircraft Laboratory, May 24, 1946.

- Boggs, Bernard C., Common Parallel Thermocouples for Average Temperature Measurement, WADD TR 60-650, Flight & Engineering Test Division, WADD, WPAFB, Ohio, November 1960.
- , 1961 Compendium of Symposium Papers, The Science of Thermal Simulation - Strength Testing, Page D-1, ASD TR-61-394, Volume K, Aeronautical Systems Division, WPAFB, Ohio, September 1961.
- , High Temperature Tension Patch and Thermal Simulation Methods for Structural Testing, WADD TR 60-650, Wright Air Development Center, WPAFB, Ohio, Jul, 1960.
- Bosworth, W.H., Gaging the Load - Instrumentation, Minneapolis-Honeywell Regulator Co., Industrial Division, Philadelphia, Pa., Second Quarter, 1953.
- Chanute, Octave, Progress in Flying Machines, M. N. Forney, New York, 1894.
- Dewey, Anne Perkins, Robert Goddard Space Pioneer, Little Brown & Co., Boston-Toronto, 1962.
- Dill, H.D., and J.A. Newman, Experimental Verification of the Suitability of Compressing the Time of Mission Profile During Elevated Temperature Fatigue Testing, AFFDL TR 70-113, Air Force Flight Dynamics Laboratory, WPAFB, Ohio, February 1971.
- Engineering Division Tour Guide (Mimeographed Paper), Mid 1920's, Air Force Museum.
- Experimental Stress Analysis, Proceedings of the Society for Experimental Stress Analysis, Volume 1, Number 1, May 13 - 15, 1943, Volume 11, Number 2, December 2 - 4, 1943.
- Fahey, James C., U.S. Army Aircraft - 1908 - 1946 (Heavier Than Air), Ships and Aircraft, 1265 Broadway, New York, New York.
- General Electric Heat Rate Computer for Wright Air Development Center (Instruction Manual), General Electric Co., Phoenix, Arizona, August 1959.
- Gibbs Smith, Charles H., Aviation: An Historical Survey from its Origins to the End of World War II, London, H.M.S.O., 1970.
- Glines, Carroll V., The Compact History of the United States Air Force, Hawthorn Books, Inc., New York.
- Goldberg, Alfred, A History of the U. S. Air Force - 1905-1957, Princeton, 1957.

- Grogan, John C., Structural Test Program - B-58A Airplane, ASD TDR-62-595, Directorate of Engineering Test, Aeronautical Systems Division, AFSC, WPAFB, Ohio, August 1962.
- Guide to WPAFB, Air Force Museum.
- Heldenfels, Richard R., High Temperature Testing of Aircraft Structures, Unnumbered NACA Report, 8th Meeting Structures and Materials Panel Advisory Group NATO, Copenhagen, Denmark, October 20-24, 1958.
- Hetényi, M., Handbook of Experimental Stress Analysis, John Wiley & Sons, Inc., New York 1950, 3rd Printing 1957.
- Herron, M.J., Fairfield Air Depot, Air Force Museum.
- History of the Air Corps Materiel Division - 1917 - 1937, Air Force Museum.
- Hoff, Wilhelm, Analysis of Stresses in German Airplanes, Eighth Annual Report of the National Advisory Committee for Aeronautics, 1922, Government Printing Office, 1923.
- Hudson, Charles R., et al, R&D Contributions to Aviation Progress (RADCAP), ASD TR-72-30\*3, Vol. II, Appendices 1-9, Section II, Pages 194, 290 & 305, Ref. 24, Section II-8, Pages 307-317, Department of the Air Force, Washington, D.C., August 1972.
- Jablecki, Leon S., Analysis of the Premature Failures in Static Tested Aircraft, Verlag Leemann, Zurich, 1955.
- Jackson, D.W., and R.L. Bondurant, Airframe Structural Integrity Testing - A Challenge in Automation, 3rd Annual Automatic Techniques Conference (AIEE, ASME & IRE), Cleveland, Ohio, April 1960.
- Jane's All the World's Aircraft - 1945 - 46, Page 258C, Compiled and Edited by Leonard Bridgman, The MacMillan Co., New York.
- Kelly, Fred C., The Wright Brothers, Harcourt, Brace & Co., New York, 1943.
- Kemmer, Paul H., Lt. Col., Preliminary Specifications for Building 65, Aircraft Laboratory, Air Corps, Approx. 1942.
- Kotanchik, J.N., Experimental Research on Aircraft Structures at Elevated Temperatures, Volume XIV, No. 2, Experimental Stress Analysis - Proceedings of the Society for Experimental Stress Analysis, 1957.

- Kramer, E.H., and E.J. Lunney, Dynamic Measurements During Aircraft Landings, Volume VII, No. 1, Experimental Stress Analysis - Proceedings of the Society for Experimental Stress Analysis, Pages 83-102, 1949.
- Langley, Samuel Pierpont, and Charles M. Manly, Langley Memoir on Mechanical Flight, Parts 1 and 2, Smithsonian Contributions to Knowledge, Volume 27, No. 3, City of Washington, Published by the Smithsonian Institution, 1911.
- Lilienthal, Otto, Birdflight as the Basis of Aviation, Longmans, Green and Co., London, New York, Bombay and Calcutta, 1911.
- A Little Journey to the Home of the Engineering Division, Army Air Services, McCook Field, Dayton, Ohio, Air Force Museum.
- Liquid Hydrogen/Liquid Nitrogen Structures Test Sub-Facility Building 65, FY-70 MCP Technical Brochure (Prepared by E.C. Boogs and H.F. Ostrowski), Structures Test Branch, Structures Division, Air Force Flight Dynamics Laboratory, AFSC, WPAFB, Ohio, March 1968.
- Lowndes, H.B. Jr., Capt, USAFR, Structural Testing of Aircraft (Lecture for Building 65 Tours), Aircraft Laboratory, Dayton, Ohio, December 24, 1949.
- McCook Field: AD Flight Test Center of the 1920's, Approx. 1924, Air Force Museum.
- McMahon, Something About McCook Field (Paper), Air Force Museum.
- McVeigh, Donald R., History of Wright Air Development Center - The Structural Integrity Program, 59 WC-2184, Supplemental Volume VII, Office of Information Services, Wright Air Development Center, WPAFB, Ohio, June 1959.
- Meeker, D.P., Structural Test on E.G. Budd Stainless Steel Wing Panel for the BC-1 Airplane, Report No. 4589, Aircraft Laboratory, November 26, 1940.
- , Structural Tests on the North American BC-1 Airplane, Report No. 4575, Aircraft Laboratory, November 1, 1940.
- Midlin, Harold, and R.W. Landgraf (Editors), Use of Computers in the Fatigue Laboratory, Pages 2-26 by Boogs, et al, STP 613 (Symposium 17 - 21 November 1925), American Society for Testing and Materials, Philadelphia, Pa., 1976.
- Moedebeck, Hermann W.L., Pocket-Book of Aeronautics, English Edition, Whittaker & Co., London & New York, 1907.

- Mondol, Nirmal K., Digital Load Control Applied to Full Scale Airframe Fatigue Tests, AFFDL TR (In Preparation 1979), Air Force Flight Dynamics Laboratory, WPAFB, Ohio, 1979.
- , Direct Digital Multi-Channel Load Control for Full Scale Airframe Fatigue Testing, AFFDL TM-75-89-FBT, Air Force Flight Dynamics Laboratory, WPAFB, Ohio, June 1975.
- Monfort, John B., Structure Test Program - Advanced Structural Concept Experimental Program (ASCEP), AFFDL TR-70-78, AFFDL, AFSC, WPAFB, Ohio, August 1970.
- Moore, H.F., Stress, Strain and Structural Damage, 42nd Annual Meeting of the American Society for Testing Materials, 1939.
- Moran, Dana H., Structures and Materials. . . .A Changing World for the Aerospace Designer, Astronautics and Aeronautics, Page 69, American Institute of Aeronautics and Astronautics, New York, New York, July/August 1978.
- Mr. Thomas, The Flight of the Albatross, Paper read at the Balloon Society, October 3, 1884, Appendix, Progress in Flying Machines.
- Niles, Alfred S., and Joseph S. Newell, Airplane Structures, Volume 1, 3rd Edition, John Wiley & Sons, New York, 1943.
- Niles, Alfred S., Airplane Design, Published by Engineering Division, U.S. Air Service, Dayton, Ohio, July 1926.
- Noble, Robert A., and Richard P. Sorgen, T-3 Lamp Power Density Distribution, FDTE TM-65-19, Research & Technology Division, AFSC, April 1965.
- Northrop Service News, Volume III, No. 2, February/March 1953.
- Ohio's Miami Valley Salutes WPAFB, Air Force Museum.
- Peck, Fred J., Jr., Structural Tests Conducted on the Stinson L-5 Airplane, Report No. 5218, War Department, Army Air Forces, Air Technical Service Command, Aircraft Laboratory, Dayton, Ohio, April 3, 1945.
- Proceedings - Fatigue of Aircraft Structures, WADC TR-59-507, Wright Air Development Center, WPAFB, Ohio, August 1959, Symposium.
- A Quick Look at WPAFB, Air Force Museum, November 1967.
- Ritchie, Malcolm L., The Observance of the 75th Anniversary of Flight, The Research and Development Methods of Wilbur and Orville Wright, Pages 56-67, Astronautics and Aeronautics, American Institute of Aeronautics and Astronautics, New York, New York, July/August 1978.

- Report on Study of Evidence and Justifications for the Procurement of a Static Test Article of the B-36 Airplane, TSEAC 12, Engineering Division, AMC, WPAFB, Ohio, September 6, 1946.
- Sackett, Rod & Dan Hobel, Nine-Channel Data Acquisition System, AFFDL TR-65-151, Air Force Flight Dynamics Laboratory, AFSC, WPAFB, Ohio, September 1965.
- Schneider, Robert L., and Bernard E. Davis, Graphite Heater Evaluation, TM-70-5-FBT, Air Force Flight Dynamics Laboratory, WPAFB, Ohio, October 1970.
- Sechler, Ernest E., and Louis G. Dunn, Airplane Structural Analyses and Design, John Wiley & Sons, New York, 1942.
- Shrader, Welman A., Fifty Years of Flight - A Chronicle of the Aviation Industry in America 1903 - 1953, Eaton Manufacturing Co., Cleveland, Ohio.
- Signal Corps, United States Army, Signal Corps Specification No. 486, February 10, 1908.
- Stitz, Aircraft Laboratory Letter (WCLSY), 22 July 1959, Brief Contractual History of the WADC High Temperature Test Facility.
- AN-SR-4 Strain Gage Primer, Bulletin 283, Baldwin Locomotive Works, Philadelphia, Pa.
- Streckenback, Jack M., Capt, Consideration of Methods for Structural Testing of Aircraft at Elevated Temperatures, TN WCLS 53-24, Aircraft Laboratory, WPAFB, Ohio, February 24, 1953.
- Strength of Aircraft Elements ANC-5, U.S. Government Printing Office, December 1942.
- Study of Results of Structural Testing, TSEAC 12-45118-2, Engineering Division, AMC, WPAFB, Ohio, July 26, 1946.
- Tatnall, F.G., Tatnall on Testing, American Society for Metals, Metal Parks, Ohio, 1966.
- AFSC Technical Facility and Equipment Summary, AFSC-D62, Pages 257-272, January 1964.
- Timoshenko, S., Strength of Materials, Part I, D. Van Nostrand Co., 1930.
- Thomas, Jerrell M., and S. Hanagud, Reliability-Based Econometrics of Aerospace Structural Systems: Design Criteria and Test Options, NASA TN D-7646, George C. Marshall Space Flight Center.

- Up, Up and Away; the Wright's Dream, Skywriter, August 16, 1974.
- U.S. Army Air Corps Materiel Division Index to Reports 1927 - 1948.
- U.S. Army and Air Force Fighters 1916 - 1961, Edited by Bruce Robertson,  
Pages 10 and 238, The Garden Press Limited, Letchworth,  
Herts, 1961.
- Von Karman, Theodore, The Wind and Beyond, Little, Brown & Co., Boston,  
1967.
- WADD Structural Test Facility Complex Brochure (Ozalid), Prepared by  
Fred J. Peck, Jr., and B.C. Boggs, 1962.
- Wardle, M.C., Twenty-Fourth Aerodynamics Discussion - Theory and  
Application of Electrical Strain Gages, October 27, 1943.
- Whittaker Eight-Channel Data Acquisition System, Project 139001002,  
AFFDL (FBTS), Ronald E. McQuown Principal Investigator,  
June 1965.
- The Papers of Wilbur and Orville Wright, Volumes I and II, McFarland,  
Editor, McGraw-Hill, New York, 1953.
- Wood Aircraft Inspection and Fabrication, ANC-19, U.S. Government  
Printing Office.
- Worman, Charles G., McCook Field: A Decade of Progress, AH/Spring 1970,  
Air Force Museum.
- Wright Field Pamphlet, Materiel Division, 1937.