

② LEVEL II

AFAPL-TR-78-74

ADA 064693

DDC FILE COPY

TI/AL DESIGN/COST TRADE-OFF ANALYSIS

GENERAL ELECTRIC COMPANY
AIRCRAFT ENGINE GROUP
1 NEUMANN WAY
CINCINNATI, OHIO 45215

DDC
RECEIVED
FEB 15 1979
B

OCTOBER 1978

TECHNICAL REPORT AFAPL-TR-78-74
Final Report for Period 12 September 1977 - 12 March 1978

Approved for public release; distribution unlimited.

AIR FORCE AERO-PROPULSION LABORATORY
AIR FORCE WRIGHT AERONAUTICAL LABORATORIES
AIR FORCE SYSTEMS COMMAND
WRIGHT-PATTERSON AIR FORCE BASE, OHIO 45433

79 02 12 058

NOTICE

When Government drawings, specifications, or other data are used for any purpose other than in connection with a definitely related Government procurement operation, the United States Government thereby incurs no responsibility nor any obligation whatsoever; and the fact that the Government may have formulated, furnished, or in any way supplied the said drawings, specifications, or other data, is not to be regarded by implication or otherwise as in any manner licensing the holder or any other person or corporation, or conveying any rights or permission to manufacture, use, or sell any patented invention that may in any way be related thereto.

This report has been reviewed by the Information Office (OI) and is releasable to the National Technical Information Service (NTIS). At NTIS, it will be available to the general public, including foreign nations.

This technical report has been reviewed and is approved for publication.



THEODORE G. FECKE
Project Engineer
Propulsion Branch



MARTIN D. SCOTT, LT COL, USAF
Chief, Propulsion Branch
Turbine Engine Division

FOR THE COMMANDER



ERNEST C. SIMPSON
Director
Turbine Engine Division

"If your address has changed, if you wish to be removed from our mailing list, or if the addressee is no longer employed by your organization, please notify AFAPL/TBP, W-PAFB, OH 45433 to help us maintain a current mailing list".

Copies of this report should not be returned unless return is required by security considerations, contractual obligations, or notice on a specific document.

UNCLASSIFIED

SECURITY CLASSIFICATION OF THIS PAGE(When Data Entered)

20. Abstract (Continued)

Cost of the selected titanium aluminides components was compared with the current cost of the nickel-base-superalloy components. The results show a cost increase for all the components. A detailed structural analysis of the four components shows the substitution would lead to longer life components. This substitution would result in not only a weight reduction in the engines, but a reduced fuel load and structure weight for a similar mission with the same bomb load, avionics, and other fixed equipment. An estimated \$41.6 million dollars cost saving would result based on 240 aircraft for 20 years.

UNCLASSIFIED

SECURITY CLASSIFICATION OF THIS PAGE(When Data Entered)

PREFACE

This Final Technical Report was prepared by the Advanced Engineering and Technology Programs Department, Aircraft Engine Engineering Division of the General Electric Company, Evendale, Ohio, for the Air Force Aero Propulsion Laboratory, Air Force Systems Command, on Contract F33615-77-C-2066, Project Number 3066. The work described was performed during the period 12 September 1977 to 12 March 1978. Capt. Paul D. Copp and Mr. Theodore G. Fecke were the Air Force Project Engineers for this program.

This report describes a design and cost trade-off analysis conducted to evaluate the application of selected titanium aluminide alloys to both dynamic and static components of aircraft gas turbine engines. Mr. D. O. Nash was the Technical Program Manager for the overall technical effort and Mr. J. Holowach was the Principal Investigator. Significant contribution was made to this program by Mr. T. K. Redden who performed the materials studies. Acknowledgement is also made to the various involved engineering organizations for their contributions to the program and this report.

ADDITIONAL	
NTIS	<input checked="" type="checkbox"/>
DOC	<input type="checkbox"/>
REF	<input type="checkbox"/>
INT	
FR	
RES	
DATA	SPECIAL
A	

TABLE OF CONTENTS

		<u>Page</u>
I.	INTRODUCTION AND PROGRAM SUMMARY	1
	A. Introduction	1
	B. Program Summary	2
	C. Recommendations	4
II.	TASK I - STRUCTURE PROPERTIES AND FABRICATION EVALUATION	6
	A. Titanium Aluminide Alloys	6
	B. Ti ₃ Al-Base Alloys	7
	C. TiAl-Base Alloys	8
	D. Producibility	10
	E. Material Release Criteria	11
III.	TASK II - COMPONENT COST EVALUATION	13
	A. Basic Material Cost	13
	1. Cost Factors	13
	2. Alloy Ingredient Cost	13
	3. Mill Product Cost Trends	15
	4. Titanium Aluminide Cost Estimate	15
	B. Component Cost Estimate	17
	1. Cost Analysis Method	17
	2. Dynamic-Components Cost	20
	a. General Consideration	20
	b. Process Evaluation Cost Factors	20
	c. Dynamic-Components Costs	23
	d. Static-Component Costs	23
IV.	TASK III - COMPONENT STRUCTURAL ANALYSIS	26
	A. J101 Low Pressure Turbine Blade	26
	1. Introduction	26
	2. Technical Discussion	26
	a. Rupture Life Analysis	28
	b. Low-Cycle Fatigue Life Analysis	28
	c. Resonant Frequency Analysis	30
	d. Dovetail Analysis	30
	e. Disk Analysis	30
	3. Manufacture	34
	4. Summary	37
	B. F101 Fourth-Stage Compressor Blade	39
	1. Introduction	38
	2. Life Based on Steady-State Conditions	39
	3. Vibration Analysis	45
	4. Weight Analysis	49
	5. Summary	49

TABLE OF CONTENTS (Concluded)

	<u>Page</u>
C. F101 Mixing Duct	49
1. Introduction	49
2. Design Considerations	53
3. Design Analysis	53
4. Summary	57
D. F101 Exhaust Duct Cooling Liner	57
1. Introduction	57
2. Design Considerations	57
3. Design Analysis	59
4. Summary	62
V. TASK IV - DESIGN/COST TRADE-OFF ANALYSIS	64
A. Introduction	64
B. Life Cycle Cost Model	64
C. Life Cycle Analysis Calculation Procedures	65
D. Life Cycle Cost Results	66
E. Additional Life Cycle Cost Study	67
F. Summary	67
APPENDIX A - Titanium Aluminide Alloy Property Data	71
APPENDIX B - Comparative Manufacturing Cost Data for Titanium Aluminide Components	105
APPENDIX C - Life Cycle Cost Analysis	111
REFERENCES	114

LIST OF ILLUSTRATIONS

<u>Figure</u>		<u>Page</u>
1.	Selected Titanium Aluminide Study Components.	3
2.	Effect of Sheet or Plate Thickness on Cost.	16
3.	Typical Cost Improvement Curve (80%).	19
4.	Low Pressure Turbine Blade.	27
5.	J1G1 LPT TiAl Blade; Estimated Campbell Diagram.	32
6.	Preliminary J101 LP Turbine Dovetail Stresses in Blade and Disk.	33
7.	Compressor Blade.	40
8.	Comparison of Ti-36Al-5Nb with Titanium and Inconel 718 as the F101 Stage 4 Blade Material.	41
9.	Maximum Blade and Dovetail Stresses for Ti-36-5Nb F101 Fourth-Stage Compressor Blade.	42
10.	Strain Range of Ti-36Al-5Nb F101 Fourth-Stage Compressor Blade.	43
11.	Stress Rupture Life of Ti-36Al-5Nb F101 Fourth-Stage Compressor Blade.	44
12.	F101 Fourth-Stage Compressor Blade Campbell Diagram.	46
13.	First-Flexure Stress; F101 Fourth-Stage Compressor Blade.	47
14.	First-Torsion Stress; F101 Fourth-Stage Compressor Blade.	48
15.	F101 Mixing Duct.	52
16.	F101 Mixing Duct Load Diagram.	54
17.	F101 Exhaust Duct Liner Cooling Flow.	58
18.	F101 Exhaust Duct Cooling Liner.	60
19.	F101 Exhaust Duct Liner Temperature Distribution.	61
20.	F101 Exhaust Duct Liner Pressure Distribution.	63
21.	Effects of TiAl Alloy Development Cost on Life Cycle Cost Savings.	69
A-1.	Tensile Properties of Ti-36Al-5Nb.	72
A-2.	Ti-36Al-5Nb Stress Rupture.	73
A-3.	Ti-36Al-5Nb 1.0% Creep.	74

LIST OF ILLUSTRATIONS (Concluded)

<u>Figure</u>		<u>Page</u>
A-4.	Thermal Coefficient of Expansion Versus Temperature.	75
A-5.	LCF Life of Ti-36Al-5Nb Alloy.	76
A-6.	Ti-36Al Elastic Modulus Data.	77
A-7.	Cast Ti-36Al Tensile Properties.	78
A-8.	Cast Ti-36Al Stress-Rupture Properties.	79
A-9.	Ti-14Al-21Nb (Wt %) Tensile Properties.	80
A-10.	Ti-14Al-21Nb Alloy (14Al-21Nb Wt %).	81
A-11.	Ti-14Al-21Nb High Cycle Fatigue.	82
A-12.	Ti-16Al-10Nb Low Cycle Fatigue.	83
A-13	Ti-16Al-10Nb Alloy Tensile Properties.	84
A-14	Ti-16Al-10Nb 1% Creep.	85
A-15.	Ti-16Al-10Nb Stress Rupture.	86
A-16.	Ti-16Al-10Nb (Ti ₃ Al Base) Coefficient of Expansion.	87
A-17.	Ti-16Al-10Nb Modulus Data.	88
A-18.	Ti-16Al-10Nb (Ti ₃ Al Base) High Cycle Fatigue Data.	89
A-19.	Ti-16Al-10Nb (Ti ₃ Al Base) Notched Low Cycle Fatigue.	90

LIST OF TABLES

<u>Table</u>	<u>Page</u>
1. Ti-Al Intermetallics Comparisons.	7
2. Alloy Comparison Summary.	9
3. Alloy Producibility Estimates.	9
4. Material Release Data for Low Pressure Turbine Blades.	12
5. Cost of Alloying Elements.	14
6. Basic Alloy Costs.	14
7. Ti-6Al-4V Titanium Alloy.	15
8. Ti-14Al-21Nb Estimated Alloy Costs.	18
9. Ti-36Al-5Nb Estimated Alloy Costs.	18
10. Process Evaluation.	21
11. F101 Stage 4 Compressor Blade Costs.	24
12. J101 Low Pressure Turbine Blade Costs (Cast Cored).	24
13. J101 LP Turbine Blade Costs (Diffusion- Bonded, Isothermal-Forged Halves).	24
14. F101 Exhaust Duct Liner Costs.	25
15. F101 Mixing Duct Costs.	25
16. J101 LP Turbine Blade Rupture Life (Pitch Line).	29
17. J101 LP Turbine Blade Resonant Frequencies.	31
18. Blade and Disk Weight and Overspeed Capability.	35
19. Material/Manufacturing Combination Candidates for TiAl LP Turbine Blades.	36
20. Weight Reduction of Current F101 Compressor with Ti-36Al-5Nb Compressor Blades.	50
21. TiAl Compressor Blade Evaluation Program.	51
22. F101 Mixing Duct Stresses.	56
A-1. Titanium Aluminide Alloys.	91
A-2. Ti-Al Intermetallics.	91
A-3. Ti-36Al-5Nb Tensile Properties.	92
A-4. Ti-36Al-5Nb Creep and Stress Rupture Results.	93
A-5. Ti-36Al-5Nb Strain Control LCF Results.	93
A-6. HCF Results on Ti-36Al-5Nb.	94

LIST OF TABLES (Concluded)

<u>Table</u>		<u>Page</u>
A-7.	Tensile Results for the Ti-4Al-2Nb Alloy.	95
A-8.	Creep Results for the Ti-4Al-2Nb Alloy.	96
A-9.	High Cycle Fatigue Results for the Ti-14Al-21Nb Alloy.	97
A-10.	Thermal and Electrical Resistivity of Ti-16Al-10Nb.	97
A-11.	The Specific Heat of A Titanium Alloy (Ti-16Al-10Nb).	98
A-12.	Coefficient of Linear Thermal Expansion for Ti-16Al-10Nb.	99
A-13.	Notched Low Cycle Fatigue Properties of Ti-16Al-10Nb.	100
A-14.	Notched Stress Rupture Properties for Ti-16Al-10Nb.	101
A-15.	Tensile Properties for Ti-16Al-10Nb.	102
A-16.	Charpy Impact Toughness of Ti-16Al-10Nb.	103
A-17.	High Cycle Fatigue Data for Ti-16Al-10Nb ($\gamma = 1$).	104
B-1.	Low Pressure Turbine Blade Cast, Cored, Radial Holes.	106
B-2.	J101 LP Turbine Blade; Diffusion-Bonded, Isothermal-Forged Halves.	107
B-3.	F101 Stage 4 Compressor Blade Detailed Operation Plan.	108
B-4.	F101 Mixer Detailed Operation Plan.	109
B-5.	F101 Exhaust Duct Liner Detailed Operation Plan.	110

I. INTRODUCTION AND PROGRAM SUMMARY

A. INTRODUCTION

In the development of advanced aircraft gas turbine engines, a continuing objective has been to develop lightweight, high-performance designs. A parallel objective, which is now receiving increased emphasis, is the reduction of engine acquisition and life cycle costs without degrading engine reliability or performance. Both objectives benefit from the effective application of new materials and processes. Future gas turbine engine designs must, as in the past, incorporate a judicious blending of design, materials, fabrication techniques, and cost considerations to meet the overall aircraft-system requirements and objectives.

The development of titanium aluminide alloys has received increasing attention in recent years. The Air Force Materials Laboratory (AFML) has demonstrated that titanium aluminide alloys have high potential as replacement alloys for nickel-base superalloy in the 1000° to 1800° F temperature range. Under AFML alloy development and characterization programs, these materials have demonstrated competitive strengths, high temperature creep resistance, and oxidation resistance with a 50 percent reduction in density compared with superalloys. The nonpyrophoric capability of the titanium aluminide TiAl, with 36 percent aluminum by weight, also offers a unique solution to the performance limitations and pyrophoric problems associated with titanium alloys in current engines. The low room-temperature ductility of titanium aluminides, however, presents a major risk to obtaining the significant payoffs of these materials; thorough evaluation is required before these materials can be introduced into critical engine components.

In September 1977, the General Electric Company was awarded a study contract (F33615-77-C-2066) by the Air Force Aero Propulsion Laboratory (AFAPL) to conduct a design/cost tradeoff analysis to identify specific applications for titanium aluminide alloys in aircraft engines. The AFAPL-sponsored program was designed to provide guidance to AFML in its current alloy-development program and provide guidelines for future AFML manufacturing technology programs to utilize the titanium aluminides.

To meet the above technical objectives, the study program was structured to provide AFAPL with a realistic assessment of the utilization and application of titanium aluminide alloys for static and dynamic components in gas turbine engines. The program started with the review of available titanium aluminide properties and the generation of a data base for TiAl and Ti₃Al alloys. Subsequent tasks, using the available materials data, were directed at determining the estimated component costs, structural integrity, performance enhancement, and estimated life cycle costs for the most promising applications of titanium aluminide alloys.

The program consisted of the following four tasks:

- Task I - Structural Properties and Fabrication Evaluation
- Task II - Component Cost Analysis
- Task III - Component Structural Analysis
- Task IV - Design/Cost Trade-off Analysis

B. PROGRAM SUMMARY

The components selected to identify specific applications for titanium aluminide alloys in aircraft engines for the design/cost trade-off study are as follows:

Dynamic Components

- F101 Fourth-Stage Compressor Blade
- J101 Low Pressure Turbine Blade

Static Components

- F101 Mixing Duct
- F101 Exhaust Duct Liner

The locations of these components in a typical, augmented-turbofan engine are shown schematically in Figure 1. The components were selected to encompass a wide range of engine applications for both the TiAl and the Ti₃Al alloys to provide broad understanding of the advantages and limitations for future AFML manufacturing technology programs.

A properties data bank was generated under Task I, Structural Properties and Fabrication Evaluation, and is included in Appendix A. The data bank includes material properties for Ti₃Al and TiAl alloys in the wrought, cast, sheet, and powder-metal forms developed under the AFML characterization and development program.

In Task II, Component Cost Analysis, detailed cost estimates of raw stock or mill products were made based on the current elemental costs of the alloy and the historical cost trends of similar alloys used in the aircraft industry. These costs were then used for estimating the cost of the individual components based on the 250th production unit in Task III. The costs of the titanium aluminide components were then compared with the current costs of the nickel-based superalloy components. These studies showed a cost increase for all the selected components, due to more expensive raw-stock material costs and the more expensive fabricating processes normally associated with reactive materials such as titanium alloys.

Detailed structural analyses of the four selected components were completed in Task III utilizing the analytical techniques used in designing the original components. These studies showed that TiAl could be substituted for the nickel-base alloys in the F101 fourth-stage compressor blade where the nonpyrophoric property of TiAl is desirable for safe engine operation. TiAl is not a good substitute for nickel-base alloys in the J101 low pressure

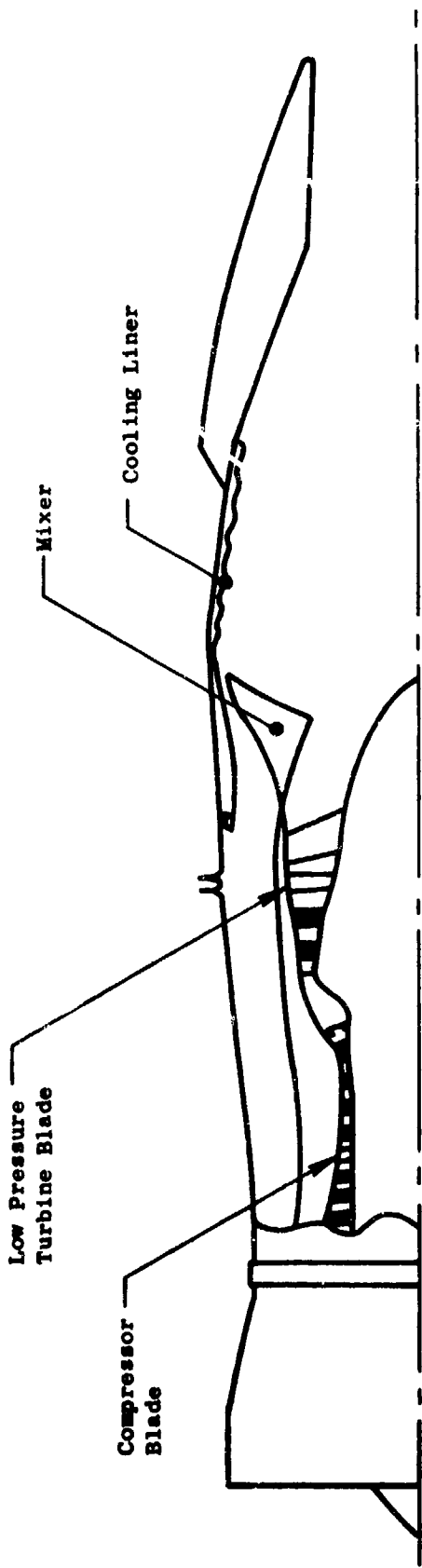

3

<u>Component</u>	<u>Engine</u>
● Compressor Blade - 4th Stage	F101
● Low Pressure Turbine Blade	J101
● Augmentor Mixer	F101
● Exhaust Duct Liner	F101

Figure 1. Selected Titanium Aluminide Study Components.

turbine blade, however, due to the significant manufacturing and blade-cooling design modifications that would be required. In the mixing duct and the augmentor liner, the more ductile and formable Ti_3Al can be substituted for the nickel-based alloys with a significant weight saving and equal structural integrity.

In Task IV, Design/Cost Trade-Off Analysis, a life cycle cost estimate was made for the substitution of titanium aluminide components in an F101 engine derivative for a B-1 penetrator-bomber mission. The substitution of the titanium aluminide components resulted in not only a weight reduction in the engines, but a reduced fuel load and structure weight for a similar mission with the same bomb load, avionics, and other fixed equipment. An estimated \$41.6 million cost saving was calculated based on a 240-aircraft fleet over a 20-year period.

C. RECOMMENDATIONS

The AFML titanium aluminides materials development program should be initially directed toward increasing the impact resistance and ductility of these alloys and obtaining additional mechanical-property data to complete a materials-release criteria for development engines. The type and quantity of the data required for each alloy are dependent upon the type of component selected and the specific engine and aircraft mission. The materials-release criteria (which includes a minimum set of mechanical properties including notch fatigue strength, impact resistance, and crack-propagation data) must be completed before the alloy can be released for introduction into a development engine.

It is further recommended that the AFML manufacturing technology program initiate a development program to establish the manufacturing processes that would be required to fabricate full-size engine components, including welding processes and the rolling of wide sheet stock. It is also recommended that one static and one dynamic component be selected for further development since completely different manufacturing processes are required.

Compressor blades could be an attractive application for $TiAl$ because it would eliminate the pyrophoric problems associated with conventional, titanium-alloy blades. However, additional material-property data (including notch fatigue strength, impact resistance, and crack-propagation data) are required before a valid engineering judgment can be made on the reliability and life of titanium aluminide blades. A comprehensive component-test program would also be required for the compressor blades before commitment to an engine test.

If the titanium aluminides develop sufficient impact strength and notch ductility, the F101 fourth-stage compressor blades would be a good choice as the initial $TiAl$ dynamic component. This stage in the F101 engine was previously fabricated from a titanium alloy, but a nickel-base superalloy was substituted to avoid potential pyrophoric problems associated with the use of titanium-alloy blades. After the successful completion of evaluation

testing of the fourth-stage blade, Stages 5 through 9 blades could be considered as follow-on candidates.

The J101 low pressure (LP) turbine blade is not recommended as a TiAl candidate for development manufacturing because the complex blade-cooling requirements demand the development of manufacturing techniques that are expensive and exotic. The F101 LP turbine blade is not recommended as a candidate since the operating temperature of the F101 engine is beyond the operating range of the current TiAl alloys.

A solid, uncooled, LP turbine blade could be an attractive application for TiAl alloys in a high-bypass-ratio turbofan operating at turbine-stage temperatures below 1500° F. The LP turbine blade is less risky than a compressor blade because of its downstream location in the engine. A blade failure in the last stage of the LP turbine would not result in damage to other rotating components and could possibly be detected by increased engine vibration before catastrophic damage to the engine occurred.

TiAl alloys do not appear, at this time, to be likely candidates for use in either compressor or turbine disk designs because of low ductility compared to current disk materials. Disk weight savings could be gained by redesigning current-material disks for the lower disk loading resulting from substitution of titanium aluminide blades for the higher density nickel-alloy blades.

The F101 mixing duct is recommended as the static component to be fabricated because it has the greatest weight-saving potential and requires the full range of forming and construction techniques normally used in sheet metal construction. The introduction of a Ti3Al mixer into an existing engine for evaluation also represents a less risky step; structural failure would only result in a decrease in performance without damaging other components.

The exhaust duct liner is also a potential static-component candidate for substituting a Ti3Al-base titanium aluminide alloy in place of the currently used nickel-base alloys. The weight saving is not as large as in the mixer, and the liner life may be limited by low-cycle fatigue due to hot streaking because of lower ductility. The lower buckling strength of a titanium aluminide liner for the same sheet metal thickness is also a disadvantage because buckling of the liner could distort the distribution of the cooling airflow and result in damage to either the exhaust duct or the exhaust nozzle.

A life cycle cost study showed that significant cost savings can be made by substituting titanium aluminide alloys for nickel-base alloys on selected engine components on future aircraft engines. The cost effectiveness of the lighter, titanium aluminide components shows the desirability of pursuing the fabrication and component testing of full-scale engine components so that they can be introduced into future engines with a high degree of reliability and safety.

II. TASK I - STRUCTURE PROPERTIES AND FABRICATION EVALUATION

This section describes the results of a review of titanium aluminide research and development activities, both past and current. The purpose of the review was to assemble mechanical-property, fabrication, and material-cost data for use in Tasks II, III, and IV. In some cases data were not available for certain mechanical properties, and manufacturing experience was not sufficient to permit firm cost estimates. For these situations, estimates of properties and costs were made based on alloy composition, comparison to other alloys, and known alloys/processing behavior. The sections which follow summarize the results of this effort. The data base used to make this summary is presented in Appendix A.

A. TITANIUM ALUMINIDE ALLOYS

Two titanium-base aluminide alloy types have been of interest. One type is based on the compound Ti_3Al containing approximately 16 percent by weight (25 atomic percent) aluminum. The other, $TiAl$, contains approximately 36 percent weight (near 50 atomic percent) aluminum. The general characteristics of each alloy type are given in Table 1 with data for unalloyed titanium and two nickel-base alloys for comparison. The principal advantages which have been suggested for the aluminide alloys are:

- Low-density/high-strength-to-weight ratio at elevated temperature
- Higher elastic modulus than conventional titanium alloys
- Higher elevated-temperature creep-rupture strength than conventional titanium alloys
- Greatly improved resistance to oxidation, ignition, and absorption of oxygen

The principal drawbacks associated with these materials are:

- Low ductility at ambient and elevated temperatures
- Difficult to convert to mill products from ingot
- Difficult to forge by conventional methods
- Some aluminide alloys will be costly as a result of expensive alloy additions (niobium, tungsten, etc.) and expensive processing procedures

The above advantages and problems are generalized, and recent alloy-development efforts have been directed at improving some of the advantageous features while obviating those which are considered disadvantageous. The following sections summarize the results of this review for the mechanical

properties and costs associated with each alloy type. The review resulted in selection of alloys of each type (Ti₃Al and TiAl) for consideration in the cost and design analysis work in Tasks II, III, and IV. It should be noted that other alloys with improved properties do exist, but they were not selected because of the lack of available test data at the time of the study.

Table 1. Ti-Al Intermetallics Comparisons

Parameter	Ti ₃ Al	TiAl	Conventional Titanium Alloys	Inco 718
Density (lbm/in. ³)	0.148	0.134	0.163	0.296
Modulus (75° F)	21.0	25.5	16.0	29.0
Stress Rupture Limit (40 ksi/1000 hrs)	1290° F	1350° F	1000° F	>1300° F
Oxidation	1200° F	1800° F	1000° F	>1200° F
Elong. R.T.	1%	1%	10 to 20%	10 to 20%

B. Ti₃Al-BASE ALLOYS

Ti₃Al-base alloys have received relatively little emphasis in the past because of the decrease in tensile ductility which occurs at aluminum contents above approximately eight percent in the binary titanium-aluminum system. This was expressed by Jaffee, et al. (Reference 1), and later by Rosenberg (Reference 2) for alpha titanium alloys as a relationship of the type:

$$\% \text{ Al} + 1/3\% \text{ Sn} + 1/6\% \text{ Zr} + 10 \text{ X } \%$$

$$\text{Oxygen} \leq 9.0 \text{ (all weight percent alloy)}$$

This formula was intended to place a limit on total alpha stabilizer content above which an "excessive" amount of Ti₃Al would be formed. Excessive Ti₃Al would reduce tensile ductility below normal specification limits (approximately 10 percent elongation and 20 to 25 percent reduction of area) either as-processed or after creep exposure of a few hundred hours at temperatures in the range 800 to 1000° F. This concern for ductility loss, and possible other detrimental mechanical-property effects, greatly restricted the development of alloys based on aluminum additions above approximately 7 percent. An exception to this was the work of McAndrew, et al. at the former Armour Research Foundation (References 3, 4, and 5). The alloys studied by McAndrew, et al. included Ti-Al-Nb alloys with aluminum in the range 5 to 20 percent by weight and niobium in the range 15 to 30 percent by weight. These researchers also studied various additions to alloys of the Ti-Al-Nb base.

Although some promising properties were obtained, this work did not result in the scale-up and commercialization of an alloy. It is speculated that this was because there was still concern at that time about the thermal stability and service performance of such materials. Also, the material was expensive to produce due to the high cost of niobium at that time.

Interest was revived in the Ti₃Al type alloys in the early 1970's, and several contracts were let by the Air Force Materials Laboratory (AFML) to study various aspects of Ti₃Al base alloy development and fabrication (References 6, 7, 8, and 9). In addition, several aerospace company laboratories began investigation of these alloys under independent research and development or company funding.

The work of Blackburn, et al. (Reference 6) identified two compositions with attractive elevated-temperature properties. One contained 16 percent Al and 10 percent Nb* (25Al-5Nb) and the other 14 percent Al and 21 percent Nb (24Al-11Nb). The Ti-16Al-10Nb alloy was identified first and used for mechanical-property evaluation. The Ti-14Al-21Nb alloy later proved to have somewhat better low temperature ductility and improved hot workability compared to the Ti-16Al-10Nb alloy. These alloys are similar to those studied earlier by McAndrew et al. (References 3, 4, and 5).

The available data for both of these alloys were collected for use in the Task II, III, and IV studies, and these data are given in Appendix A. Tables 1 and 2 show comparisons of selected properties of the Ti-16Al-10Nb and Ti-14Al-21Nb alloys with properties of the Ti-6Al-4V alloy and the Inconel 718 nickel-base alloy. The density-corrected values for the Inconel 718 alloy (shown in parenthesis) compare the properties to the Ti-14Al-21Nb alloy on an equal-weight basis.

C. TiAl-BASE ALLOYS

The mechanical behavior of the Ti-36Al alloy was first studied by Kessler and McAndrew (Reference 10) beginning in 1952 and continuing to 1955 (Reference 11). This work included determination of tensile, creep rupture, and oxidation behavior of the nominal 50 atomic percent Al Ti-36Al alloy using primarily arc-cast specimens. Some of their data is included in Appendix A. This work indicated that the Ti-36Al alloy had tensile and creep-rupture properties comparable to cast cobalt-base superalloys, such as X-40, and superior to them on a strength-to-weight-ratio basis. The alloy also appeared to have excellent oxidation resistance to at least 1800° F and was not subject to surface hardening as a result of absorption of oxygen at elevated temperature. Hot-working experiments conducted by Kessler and McAndrew on arc-cast ingots were not very successful. The ductility of the alloy at ambient temperature was very low. The lack of hot workability, using techniques available at that time, reduced its attractiveness, and alloy development work was stopped in 1956. Work was begun again

*Compositions are given in weight percent alloy, figures in parenthesis are in atomic percent alloy.

Table 2. Alloy Comparison Summary.

Mechanical Property	Ti-18Al-10Nb	Ti-14Al-21Nb	Ti-3Al-1 (Cast)	Ti-3Al-1-2Nb	Ti-6Al-4V	Inco 718 (Sheet)	X-40	Astrolloy
Ultimate Strength								
75° F	55.0	118.0	70.0	55.0	140.0	185	115	205
1200° F	67.0	95.0	67.0	60.0	55.0	150	84	190
1400° F	62.0	65.0	57.0	62.0	35.0	95	82	168
Rupture Life at 40 ksi (hours)								
1000° F	>>10,000	>>10,000	>100,000	>>10,000	20.0	>>10,000	>100,000	>100,000
1200° F	33,000	2,000	>100,000	2,500	0.05	24,000	66,000	>100,000
1400° F	20.0	2.0	75.0	2.5	--	60	40	15,000

Table 3. Alloy Producibility Estimates.

Alloy	Melting and Casting	Ingot Breakdown and Forging	Powder Mkt. + HIP	Sheet Rolling	Sheet Metal Forming
Ti-14Al-21Nb	Can be cast OK in ingots up to at least 6 in. dia. Could be a problem in cracking in production size ingots.	Can be conventionally forged in the beta field or hot die or isothermally forged.	Can be readily produced as powder product.	Appears to be producible on conventional rolling mills. Park rolling is applicable to thinner sheet gages.	Can be superplastically formed. Conventional titanium alloy hot die forming may also be applicable.
Ti-18Al-10Nb	Similar to Ti-14Al-21Nb except greater tendency to form cracks during ingot cooling.	Same as Ti-14Al-21Nb except greater cracking tendency.	Same as Ti-14Al-21Nb.	Similar to Ti-14Al-21Nb except greater cracking tendency.	Same as Ti-14Al-21Nb.
Ti-3Al-1-2Nb	Can be produced as small castings. Arc-cast ingots sometimes cracked (3-6 in. dia.). HIP of ingot/castings or special cooling procedures may be needed to prevent cracking.	Conventional forging not successful due to cracking. Isothermal forging at high temperature is applicable.	Can be produced by HIP powder processes followed by isothermal forging if required for shape.	Sheet rolling only partially successful to date. A commercially viable process has not been fully developed.	Based on isothermal forging results hot die forming may be applicable.
Ti-3Al-1	Same as Ti-3Al-1-2Nb.	Same as Ti-3Al-1-2Nb.	Same as Ti-3Al-1-2Nb.	Same as Ti-3Al-1-2Nb.	Same as Ti-3Al-1-2Nb.

on these materials in 1974 under AFML sponsorship (Reference 12). The renewed interest was prompted by technological developments in the intervening years that, it was hoped, provide means for improving the ductility, toughness, and workability of TiAl base materials. The pertinent technical developments were:

- Powder-metallurgy techniques developed for titanium alloys
- The availability of very low oxygen titanium sponge for a starting material
- The development of new processing techniques such as hot, isostatic-pressing of powders and isothermal forging which could be applied to form useful shapes from TiAl base materials.

The early work also did not explore widely the alloying behavior of TiAl; thus, there was the possibility that the ductility and/or workability of the material could be improved by alloying.

The work of Blackburn, et al. (Reference 12) has been directed along these lines and includes both processing and alloying studies. Their processing studies also included mold development for casting. A 36 percent aluminum 5 percent niobium alloy was identified as promising for producing a material with improved ductility compared to the binary Ti36Al alloy. Although other alloys have recently shown promise, the bulk of the available design-type data have been developed on the Ti-36Al-5Nb and binary Ti-36Al alloys. Data on these two alloys from the work of Blackburn, et al. (Reference 12), O'Connell (Reference 13), and Kessler and McAndrew (References 10 and 11) are given in Appendix A and were used in the design studies in Tasks II, III, and IV. The TiAl data from Kessler and McAndrew are for arc-cast specimens, while the Ti-36Al-5Nb data from Blackburn and O'Connell are from powder-metallurgy products produced by hot isostatic pressing (HIP). The cast material has superior creep and stress-rupture behavior, compared to the HIP material, apparently as a result of the grain size.

D. PRODUCIBILITY

The recent AFML contract efforts (References 6, 12, and 13) and the sheet rolling work at Battelle (Reference 8) made up the foundation for the producibility estimates. The estimates for various products from the selected alloys are given in Table 3. In order of increasing degree of difficulty in producibility, the alloys might be ranked as follows:

- | | | |
|-----------------|--|--------------------|
| 1. Ti-14Al-21Nb | | Ti ₃ Al |
| 2. Ti-16Al-10Nb | | |
| 3. Ti-36Al-5Nb | | TiAl |
| 4. Ti-36Al | | |

The Ti-14Al-21Nb alloy has a clear processing advantage over all the other titanium aluminide materials. The two TiAl alloys are very similar in producibility.

E. MATERIAL RELEASE CRITERIA

In order for a new material to be released for use in development engines, a minimum set of mechanical-property data must be obtained to provide a valid engineering judgment that the material will perform its function. The type and quantity of mechanical-property data required vary depending on the specific end use of the material. For example, for application as a low pressure turbine blade material, data of the type shown in Table 4 would be required. For initial engine test, a set of data on one heat or lot of material might be required. For flight test or production-engine use, data on additional heats or lots of material would be required. The specific test temperatures and test conditions would be dependent on the specific engine/mission combination under consideration.

For example, Table 4 shows the type of data required for development-engine turbine blade applications. Similar data would be required for production application, except that some longer exposure-time data and data from a larger number of heats or lots of material would be required. The specific test temperatures might be varied depending on the expected service temperatures for the proposed application. Similar data tabulations would be required for other components which might be made from titanium aluminide alloys. It would then be necessary to obtain the required data which might be missing and to obtain minimum confirmatory data for the selected configuration.

Table 4. Material Release Data for Low Pressure Turbine Blades.

<u>Property</u>	<u>Test Temperatures* (F)</u>
1. Tensile Properties (UTS, 0.2% YS, Elong., Red. Area)	72°, 1000°, 1200°, 1400°, 1600°, 1800°
2. Stress Rupture (100 in. and 1000 hr)	1400°, 1600°, 1800°
3. 0.2% Plastic Creep	1400°, 1600°, 1800°
4. Low Cycle Fatigue (Strain Controlled)	1200°, 1600°, 1800°
5. High Cycle Fatigue	1200°, 1600°, 1800°
6. Thermal Stability (Tensile Properties Charpy Impact, Ballistic Impact Before and After 100-hour Exposure to Expected Service Temperatures)	75°, 1600°
7. Melting Point	
8. Density	75°
9. Thermal Expansion	75° to 1800°
10. Thermal Conductivity	Estimate
11. Specific Heat	Estimate
12. Poisson's Ratio	Estimate or obtain from low cycle fatigue data
13. Modulus of Elasticity	75°, 1000°, 1200°, 1400°, 1600°, 1800°

*Specific test temperatures may vary depending on the application

III. TASK II - COMPONENT COST EVALUATION

The purpose of this task was to determine, on a preliminary basis, the estimated cost associated with the fabrication of the selected static and rotating titanium aluminide components. The cost analysis includes material procurement, machining, and manufacturing costs based on the optimum fabrication process for the following engine components:

- F101 Fourth-Stage Compressor Blade
- J101 Low Pressure Turbine Blade
- F101 Mixing Duct
- F101 Exhaust Duct Liner

A. BASIC MATERIAL COST

1. Cost Factors

The cost of raw stock of mill product forms is made up of a number of cost factors starting with the initial alloy-ingredient acquisition costs and proceeding to the cost of forming to the final size or shape required for manufacturing the engine component. In estimating the cost of the titanium aluminides mill products, the following general factors were considered:

- Alloy ingredient costs
- Cost of melting or powder preparation
- Cost of ingot
- Cost of ingot conversion or HIP shape including losses in conversion such as oxidation, grinding, billet end, etc.
- Final size or shape of mill product

2. Alloy Ingredient Cost

The basic alloy-element costs are shown on a relative basis in Table 5 for the elements currently considered for the titanium aluminides (using titanium as a base). The relatively high cost of additives to the basic titanium/aluminum alloy has a significant effect on the cost of the raw material. The estimated effect of alloy composition on the basic cost of the alloy is shown relative to Ti-6Al-4V in Table 6. Note that the estimated ingredient/alloy costs in this study were selected from published information and do not reflect, nor are they intended to provide, anything more than comparative numbers for relative assessment and evaluation. These estimated numbers were adequate for the purpose of this study.

Table 5. Cost of Alloying Elements.

Element	Relative Cost Per Pound
Titanium	1.0
Aluminum	0.2
Niobium	5.2
Tungsten	5.6
Zirconium	3.3
Hafnium	27.8
Vanadium	4.1

Table 6. Basic Alloy Costs.

Alloy	Relative Cost of Ingredients Per Pound
Ti-6Al-4V	1.0
Ti-14Al-21Nb	1.8
Ti-16Al-10Nb	1.3
Ti-36Al-5Nb	0.9
Ti-36Al	0.7

3. Mill Product Cost Trends

The cost of mill product forms can best be estimated for a new alloy by using the actual costs of similar alloys, developed for and introduced into the aircraft engine industry, as a guide. A cost comparison of pure titanium, Ti-6Al-4V, and Inconel 718 as a function of sheet or plate thickness is shown in Figure 2. The cost of Ti-6Al-4V as compared to either pure titanium or Inconel 718 sheet stock increases much more rapidly, as sheet thickness decreases, because of the difficulty in processing and the higher scrap rates involved in reducing the raw stock from ingots to thin sheet metal. This increasing cost trend for thin sheet metal products will be even more pronounced for the titanium aluminide alloys than for Ti-6Al-4V. Table 7 shows the effect of mill product form on the relative cost of Ti-6Al-4V alloy.

Table 7. Ti-6Al-4V Titanium Alloy.

From	Ratio to Cost of Raw Materials
Raw Materials	1.0
Ingot	1.2
Billet (8-in. Dia)	1.8
Plate ($\frac{1}{4}$ inch)	3.2
Sheet (0.050 inch)	5.6

Another method for estimating the cost of a new alloy is to compare the historical cost-trend data of similar alloys. Associated with the development of any new alloy is a "learning curve" which is typified by high cost during the introductory period and a decreasing cost trend as the alloy progresses through process refinement and as the production yield rate is increased. In addition, the alloy cost is typically further decreased as production rate increases to meet growing user demand. A "learning curve," based on the development experience of similar alloys, was applied in developing the cost estimate for the titanium aluminides studied in this program.

4. Titanium Aluminide Cost Estimate

The estimated cost of titanium aluminide sheet is shown in Table 8. The

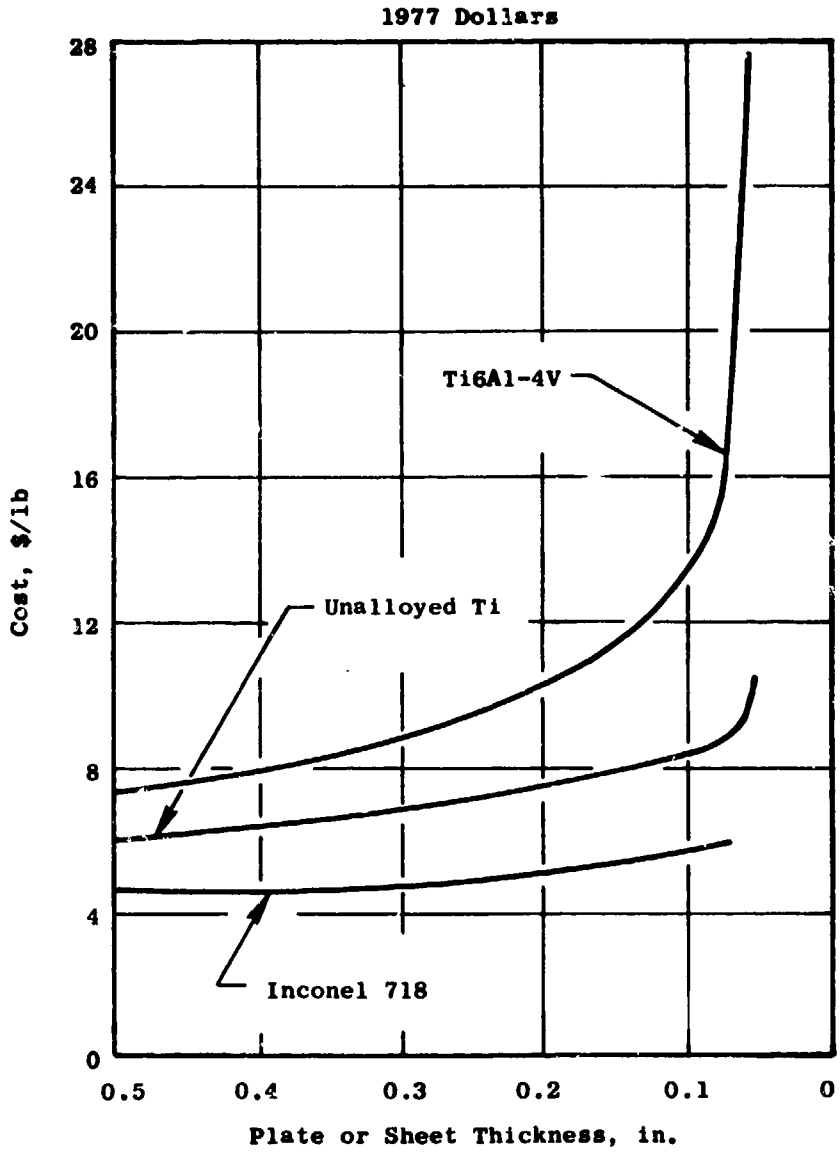

Figure 2. Effect of Sheet or Plate Thickness on Cost.

estimated cost can be expected to decrease with time as processing techniques are improved and yield factors increased; however, the initial materials cost will be used in estimating the preproduction costs of titanium aluminide components.

A similar cost estimate for producing powder for Ti-36Al-5Nb alloy is shown in Table 9 for producing parts by powder-metallurgy techniques.

B. COMPONENT COST ESTIMATE

1. Cost Analysis Method

Several cost methods are currently used to obtain cost estimates of complete jet engines for program planning and business forecasts. For example, a historically proven method of estimating the total engine cost is based on the simple relationship of cost per pound of engine weight or cost per pound of thrust. This direct costing method can be modified by other factors such as airflow, Mach number, turbine temperature, etc. to obtain a more accurate total engine cost estimate.

For specific components, more detailed costing techniques are available and are currently used. Where the component part is similar in design and materials, but differs in size, the component cost can be estimated by scaling factors established for generic engine parts. If the component part is of a new design, a detailed, step-by-step, manufacturing-process plan is prepared starting with the raw or mill product stock and progressing through the manufacturing steps required to complete a finished part. Included in the cost of the component are the scrap rate, inspection costs, and quality-control costs. Additional cost factors that can influence the cost of the component are the production rate and the split between "in house" manufactured parts and purchased parts.

The estimated cost of components is usually based on the 250th unit. This quantity was selected because past experience has shown that by the 250th unit of a production run the manufacturing problems have been overcome, and a mature process is in place using sophisticated production tooling. Using the cost estimate of the 250th unit as a base, any other quantity or cumulative average cost can be estimated using the Cost Improvement Curve (CIC). The CIC is a mathematical device which is used for predicting manufacturing costs for any quantity of a production run. It is based on the assumption that the cost per unit declines at the same percentage whenever the quantities of units produced are doubled. This results in a typical improvement curve as shown in Figure 3. The cost per unit drops rapidly at first and then gradually flattens out as more parts are produced. As a new part is introduced into production, there is a period of development followed by prototypes and then full production. In the initial stage, debugging the design and production tooling takes place followed by problems and/or opportunities that were unforeseen during initial planning. As production increases and the process matures, the ways of improving the process to reduce cost became less obvious and less significant. The slope of the CIC has been established from

Table 8. Ti-14Al-21Nb Estimated Alloy Costs.

Form	Assumption	Cost Per lb (\$)
Raw Material	1977 Elemental Cost	4.79
Ingot	Melt cost same as Ti 6-4	5.75
6-in. Dia Billet	Conversion: 25% more loss than Ti 6-4	10.75
1/4-in. Plate	Conversion: 25% more loss than Ti 6-4	19.15
0.050-in. Sheet	Conversion \approx 50% more difficult than Ti 6-4	40.00

Table 9. Ti-36Al-5Nb Estimated Alloy Costs.

Form	Assumption	Cost Per lb (\$)
Raw Material	1977 Elemental cost	2.53
Ingot	Melt cost same as Ti 6-4	3.04
Powder	Powder making cost \approx 25% greater loss than Ti 6-4	32.50

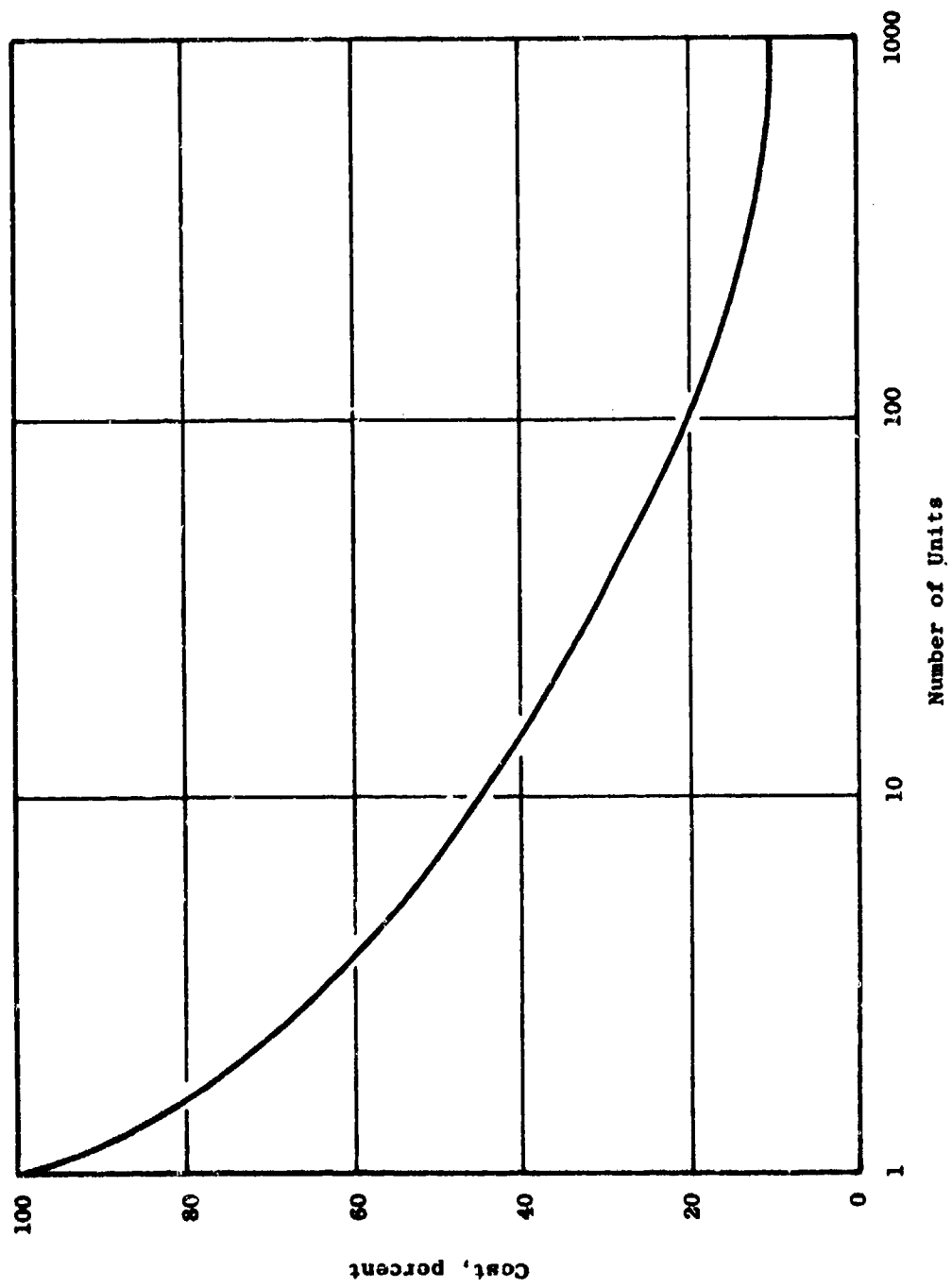

Figure 3. Typical Cost Improvement Curve (90%).

experience for the various manufacturing processes and production rates in the aircraft engine industry.

2. Dynamic-Components Cost

a. General Consideration

The aerodynamic and stress requirements of rotating components necessitate the selection of processes capable of producing precision-toleranced parts without introducing residual stresses and/or metallurgical effects that can limit the structural integrity of the component. Additional restraints of materials with low ductility and strain rates impose additional severe constraints on the manufacturing process selected for production runs.

The two dynamic components selected for study were the F101 fourth-stage compressor blade and the J101 low pressure turbine blade. These components are typical of the precision parts that must conform to the above constraints. Airfoil blades have been successfully manufactured by conventional or isothermal forging, hot isostatic pressing of powder (HIP), extrusion, and casting. A brief description of these manufacturing processes follows.

Conventional and Isothermal Forging - In conventional forging the billet is shaped to the desired geometry using warm dies made from conventional die material and using a standard screw, crank, or hydraulic press. In isothermal forging the billet is shaped at a slow rate of deformation using heated dies made from high temperature materials, and the dies usually have a shorter life.

Casting - Vacuum centrifugal slush casting is the current method used in casting titanium components. Based on the experience in casting titanium alloys, it must be assumed that the mold used for titanium aluminides will be relatively expensive, and a development program would be required to develop a suitable core material.

Hot Isostatic Pressing of Powders (HIP) - In the HIP process powder is used as the input raw material rather than a billet or ingot. The powder is contained in a nonreusable container and compacted to the desired shape by hot, isostatic, high pressure in an autoclave.

Extrusion - In the extrusion process the billet is extruded through a simple die to a cross-sectional area that is slightly larger than the maximum cross-sectional area of the finished part. In blade manufacturing this process results in the highest input weight of all the manufacturing processes evaluated.

b. Process Evaluation Cost Factors

The evaluation of the potential manufacturing processes to produce an F101 fourth-stage compressor blade and a J101 low pressure turbine blade is summarized in Table 10. A brief description of the cost factors used in evaluating the manufacturing processes is given below.

Table 10. Process Evaluation.

Elements Of Cost	Weight Factor	H I P		Conventional Forging		Extruded Bar		Isothermal Forge		Castings	
		Process Factor	Weighted	Process Factor	Weighted	Process Factor	Weighted	Process Factor	Weighted	Process Factor	Weighted
Material Cost	5	3	15	2.5	12.5	2.7	13.5	2.5	12.5	2	10
<u>Input Weight</u> <u>Finish Weight</u>	5	1.2	6	2	10	4	20	1.5	7.5	3	15
Primary Processing	15	4.5	67.5	2.5	37.5	1	15	3	45	5	75
Finish Processing	70	1	70	1.5	105	2	140	1.1	77	1	70
Tooling	5	2	10	1.5	7.5	1	5	2.5	12.5	4	20
Total Weighted Process Factors			168.5		172.5		193.5		154.5		190

Material Costs - This includes the cost of the basic, elemental, raw material plus the processing costs required to convert the raw stock into starting material for the process.

Input Weight/Finished Weight Ratio - The input/finished-weight ratio increases in importance when components are fabricated using expensive starting materials that have low scrap value, such as TiAl. The ranking of the processes for this cost estimate is based on the following considerations:

- The HIP process potentially requires a minimum envelope of stock over the finished part configuration and normally consists of only that thickness required to remove surface contamination and/or that thickness needed to meet the required precision tolerances of critical surfaces or areas.
- Conventional forging normally requires a thicker envelope than the HIP process, including a block-shaped mass from which the dovetail is machined.
- Isothermal forging has an airfoil-envelope requirement similar to the HIP process but requires the same block-shaped mass for machining the dovetail.
- Extruded bar, even with some contour, has the highest input-weight-to-part-weight ratio since the minimum extruded thickness envelope must be sufficient to include the maximum cross-sectional thickness of the part.
- Casting-envelope requirements are similar to HIP but require additional material for gates and risers.

Primary Processing - The evaluation of the primary processes to be used in fabricating the dynamic components is based on the complexity of the operation and the equipment required to convert the input material to a shape suitable for finishing. These cost factors are based on a comparison of the processing costs of titanium alloys in current production.

Finished Processing - In the finishing of the components, the main difference between the five candidate processes is the amount of material to be removed after the primary process is completed. The HIP and cast parts normally have the least amount of material to be removed while the extrusion method has the highest.

Tooling - The tooling factor is used to account for differences in tooling costs, including the normal finishing-tool requirements. Die sets are required in conventional forging and isothermal forging. The isothermal-forging dies require a more expensive material than dies used in conventional forging and usually have a shorter life. The HIP process requires tooling for the manufacture of the nonreusable containers plus expensive, high-pressure, high-temperature autoclaves. The experience acquired in production casting of titanium alloys indicates an expensive mold system would be required

for the titanium aluminide alloys, and a development program would be needed to identify a suitable core material.

c. Dynamic-Components Costs

F101 Fourth-Stage Compressor Blade - Isothermal forging was selected, from the five manufacturing approaches evaluated in Table 10, as the process having the greatest potential for the lowest production cost. The cost comparison presented in Table 11 for the current Inconel 718 (\$12.61) and the titanium aluminide blade (\$14.02) shows a cost difference of only \$1.41 per blade. This small cost differential exists even though the cost of the input material for the titanium aluminide blade is 3.6 times the cost of the material for the Inconel 718 blade. An itemized list of the major cost items is presented in Appendix B.

J101 Low Pressure Turbine Blade - The J101 LP turbine air-cooled blade, because of a complex internal cooling passage, must be cast rather than isothermally forged like the solid compressor blade. In the cost evaluation of the casting process, the material cost of René 80 was based on current material prices while the cost of titanium aluminide was projected at \$32.50 per pound. The core cost was projected at the same cost ratio found between nickel-alloy mold cost versus titanium mold cost, and the labor rate for the T1A1 was assumed to be two and a half times that required for the nickel alloys. The result of substituting titanium aluminide for René 80 increased the cost of manufacturing the J101 turbine blade from \$104.23 to \$242.09 as shown in Table 12. An itemized list of the major cost items is shown in Appendix B.

An alternative to casting the LP turbine blade would be to isothermally forge the concave and convex blade halves and join them together by diffusion bonding. This approach would allow the cavity pattern to be machined in each half prior to joining, thereby circumventing the need for a core material. The major manufacturing operations necessary to fabricate a blade in this manner are shown along with estimated cost in Appendix B. Using this processing approach, the cost of titanium aluminide blade would be \$213.00 as shown in Table 13.

d. Static-Component Costs

Static components in aircraft engines usually consist of more detailed cost elements than rotating parts because they are basically assemblies of subcomponents joined together. Each component of the fabrication must be costed as an individual part and for influence on the cost of other sub-components in the assembly. The F101 augmentor liner and mixing duct were selected as components with high potential weight payoff resulting from substitution of the lower density titanium aluminides for the currently used nickel-base alloys. These components are essentially of sheet metal construction, using manufacturing techniques that have been fully developed in production hardware both for nickel and for titanium alloys.

Table 11. F101 Stage 4 Compressor Blade Costs.

	<u>Inco 78</u>	<u>Ti/Al</u>
Material	\$ 0.65	\$ 2.37
Labor	<u>\$11.88</u>	<u>\$11.65</u>
Ship Cost	\$12.65	\$14.02

Table 12. J101 Low Pressure Turbine Blade Costs (Cast Cored).

	<u>René 80</u> <u>(Radial Holes)</u>	<u>TiAl</u> <u>(Serpentine Passages)</u>
Material	\$ 3.10	\$ 9.79
Casting	\$ 62.96	\$171.59
Shop Labor	\$ 23.55	\$ 38.50
Other Charges	<u>\$ 14.62</u>	<u>\$ 22.21</u>
Total	\$104.23	\$242.09

Table 13. J101 LP Turbine Blade Costs (Diffusion-Bonded, Isothermal-Forged Halves).

Material Cost	\$ 48.00
Forging Cost	37.00
Prebound Machining	30.00
Bonding	60.00
Finish Machining	<u>38.00</u>
Total	\$213.00

F101 Exhaust Duct - An F101 exhaust duct liner could be fabricated from titanium aluminide utilizing the same processes currently used in fabricating aircraft engine components of commercially available titanium alloys. In a direct substitution of titanium aluminide for Inconel 625, the starting sheet metal thickness would be increased to allow for in-process removal of contaminated surfaces. The major manufacturing operations required to fabricate the liner, along with detailed labor costs, are shown in Appendix B. The substitution of titanium aluminide for Inconel 625 would increase the liner cost from \$6,082 to \$9,818 as summarized in Table 14.

F101 Mixing Duct - The F101 mixing duct could be fabricated using the same manufacturing processes and techniques as the F101 exhaust duct liner. The projected labor hours and material cost for the Inconel 718 and a titanium aluminide mixer are tabulated in Appendix B. Substitution of titanium aluminide for Inconel 718 would increase the mixing duct costs from \$9,249 to \$16,737 as summarized in Table 15.

Table 14. F101 Exhaust Duct Liner Costs.

	<u>Inco 718</u>	<u>Ti₃Al</u>
Material	\$2527	\$7884
Labor	<u>6722</u>	<u>8853</u>
Total	\$9249	\$16737

Table 15. F101 Mixing Duct Costs.

	<u>Inco 625</u>	<u>Ti₃Al</u>
Material	\$1010	\$3613
Labor	<u>5072</u>	<u>6205</u>
Total	\$6082	\$9818

IV. TASK III - COMPONENT STRUCTURAL ANALYSIS

The objective of this task was to determine the structural integrity and durability of the titanium aluminide components selected in Task II. These components included:

J101 LP Turbine Blade
F101 Fourth-Stage Compressor Blade
F101 Mixing Duct
F101 Exhaust Duct Liner

The analyses used in this task were based on the actual engine environment and boundary conditions to which the components are subjected. The effects on performance that result from using the titanium aluminides were assessed by measuring structural integrity against the design criteria presently used for these components when fabricated from conventional alloys. The identical analytical tools and methods of calculation utilized in the design of the nickel-based alloy components were used, where applicable, to ensure a direct comparison of both the strength and the life of the component.

A. J101 LOW PRESSURE TURBINE BLADE

1. Introduction

The objective of this portion of the program was to investigate the payoffs and limitations of TiAl as a direct replacement for the current nickel-base superalloy (René 80) in a J101 low pressure turbine blade.

The J101 LP turbine blade shown in Figure 4 offered an attractive potential application for TiAl. These blades are the largest blades of the turbine and operate at high tip speed. Utilizing the TiAl alloy, which is 55 percent lighter than the present J101 LP turbine blade made of nickel-base alloy, could result in a reduction in blade weight, reduced blade cooling flow, reduced dovetail loading, reduced disk weight, and/or increased rotor speed. In investigating the feasibility of using TiAl, each of the following design requirements was considered:

1. Blade rupture life
2. Blade low-cycle-fatigue life
3. Blade resonant frequency
4. Blade manufacturability
5. Dovetail life
6. Disk weight and life
7. Rotor overspeed capability

Each of the above design requirements is described in detail in the Technical Discussion section.

2. Technical Discussion

The following studies identified either component enhancements or degradations due to substituting TiAl for the present nickel-base alloy in the



- J101 Engine
- Cast René 80
- Convection Cooled

TiAl Potential Payoff

- Reduced Weight
- Reduced Dovetail Loading
- Higher Tip Speed

Figure 4. Low Pressure Turbine Blade.

J101 LP turbine blade. The analyses simulated actual engine environment and boundary conditions to which the blade and disk would be subjected. Present ductile-metal design criteria were used in determining component life acceptability.

a. Rupture Life Analysis

Rupture life calculations were made on the Ti-36Al alloy selected as the turbine blade material. Airfoil pitch-line rupture-life calculations indicated that the TiAl blade would require double the cooling-hole surface area and cooling flow of the present René 80 blade (or 1.1% of the compressor flow) to meet the same rupture life. This occurs, in spite of a 55 percent reduction in TiAl centrifugal stress, because the TiAl material has a lower temperature capability. Summarized results (Table 16), which included pitch-line blade stresses and the strength differences of cast and forged TiAl, show that for a cast design the bulk temperature at the pitch line would have to be reduced to 1533° F and for a forged design to 1441° F (about 100° F and 200° F, cooler, respectively, than the René 80 design of 1634° F).

The large reductions in bulk temperature cannot be accomplished with the simple, radial-hole, cooling system of the René 80 blade. An increase in airfoil taper would reduce the centrifugal stresses and allow a higher bulk temperature. However, tapering the blade to a maximum area ratio (cross-sectional area at root/cross-sectional area at tip) of 2.0 will only allow the bulk temperature to be raised 16° F to 1549° F. Tapering by itself is, therefore, not sufficient; the minimum bulk temperature acceptable for full life, even with a tapered blade of cast material with radial holes having larger elliptical cross sections and twice the René 80 cooling flow, is 1570° F. Thus, the TiAl blade would require a more sophisticated cooling system (serpentine-type redesign) which was beyond the scope of this program. The forged-material strength capability is 38 percent lower than cast TiAl; thus, a cooling-system redesign might not be sufficient to enable forged material to meet rupture-life requirements.

The results of the above studies (summarized in Table 16) show that, if TiAl were to be used in a J101 LP turbine blade, the blade must be cast either as one piece with a serpentine core or cast in two halves (having machined, serpentine, cooling passages) which would then be diffusion bonded.

b. Low-Cycle Fatigue Life Analysis

High local thermal stress on the airfoil and resulting reduced low-cycle fatigue (LCF) life are a concern with TiAl J101 air-cooled LP turbine blades. Thermal conductivity (K) for TiAl is less than for René 80 (at room temperature, $K = 48.5 \text{ Btu-in./hr-ft}^2\text{-}^\circ\text{F}$ for TiAl versus 69 for René 80, and at 1472° F $K = 115$ versus 145, respectively). This indicates TiAl is more difficult to cool to lower bulk temperatures and also will cause larger thermal gradients resulting in higher thermal stresses and lower LCF life. The degree of LCF life reduction can only be accurately determined by detailed heat transfer and stress analyses which were beyond the scope of this program. Should LCF life improvements be found necessary, the corrective action would require a cooling-system redesign with film-cooling holes added.

Table 16. J101 LP Turbine Blade Rupture Life (Pitch Line).

Material	Rene 80	TIA1	TIA1
Manufacture Process	Cast	Cast	Forge
Centrifugal Stress	24.3	10.6	10.6
Max. Resultant Stress (ksi)	29.4	16.1	16.1
Cross Section Temperature Profile Factor	1.3	1.3	1.3
Effective Stress (ksi)	38.2	20.9	20.9
*Rupture Life (hrs)	110	110	110
Bulk Temperature (° F)	1634	1533	1441

*Based on average minus three deviation units material property.
 Represents time at maximum temperature that is equivalent to 1200 mission hours at a range of turbine temperatures.

c. Resonant Frequency Analysis

Blade resonant frequencies up to 10,500 Hz were calculated by the General Electric Twisted Blade computer program and are summarized in Table 17. These results show a 30 to 46 percent increase in resonant frequencies over the present René 80 blade due to the high modulus-to-density ratio of TiAl. A Campbell diagram of the two materials is shown in Figure 5.

The vibratory modes of blades are sensitive to boundary conditions. It was assumed, in the above analysis, that the blade was rigidly clamped at the pressure face of the upper dovetail tang. A prior study of the J101 LP turbine blade showed that up to a 20 percent increase in resonant frequency can occur if the platforms of adjacent blades come into contact. During engine operation, the boundary condition of the blade will lie somewhere between a clamped dovetail and a clamped platform.

This range of boundary conditions was considered in the vibration analysis shown in Figure 5. The figure indicates that the only potential problem areas (cross points of blade frequency with engine-excitation per rev lines) at design speed are the 16 (3754 Hz) and 44 (9304 Hz) per rev points. However, these areas are not a concern; the energy levels associated with them are low since: (1) the 16/rev is only a second-order mode of the main 8/rev driving force of the turbine frame struts, and (2) the 44/rev is associated with the high pressure turbine vanes far removed upstream from the LP turbine blades and, thus, exerts weak exciting forces on the blades. In addition, J101 engine experience has shown that these are, in fact, not strong excitation modes, and no problems have been encountered with these modes in J101 tests. A TiAl J101 LP turbine blade, therefore, should operate safely in the engine with no vibratory-frequency problems.

d. Dovetail Analysis

Dovetail stresses for the TiAl LP turbine blade were estimated by adjusting the René 80 blade dovetail stresses by the change in airfoil centrifugal loading. The results are shown in Figure 6. Low-cycle fatigue (LCF) life at the TiAl blade dovetails estimated from these stresses is greater than 10^5 cycles, which is greater than design requirements of 5000 cycles.

e. Disk Analysis

In spite of TiAl LP turbine blade life and manufacturing limitations identified previously, work planned for disk weight savings and rotor-overspeed improvement was continued because of the requests to identify these sensitivities (with the awareness that results were valid only as order-of-magnitude indicators).

Table 17. J101 LP Turbine Blade Resonant Frequencies.

Resonant Frequency (Hz)		
René 80	T1A1	% Change
786	1018	30
2205	3069	39
2585	3754 (16/Rev)	45
4099	5765	41
6388	9304 (44/Rev)	46
8258	-	-
9761	-	-

Speed = 13,533 rpm (100% N)

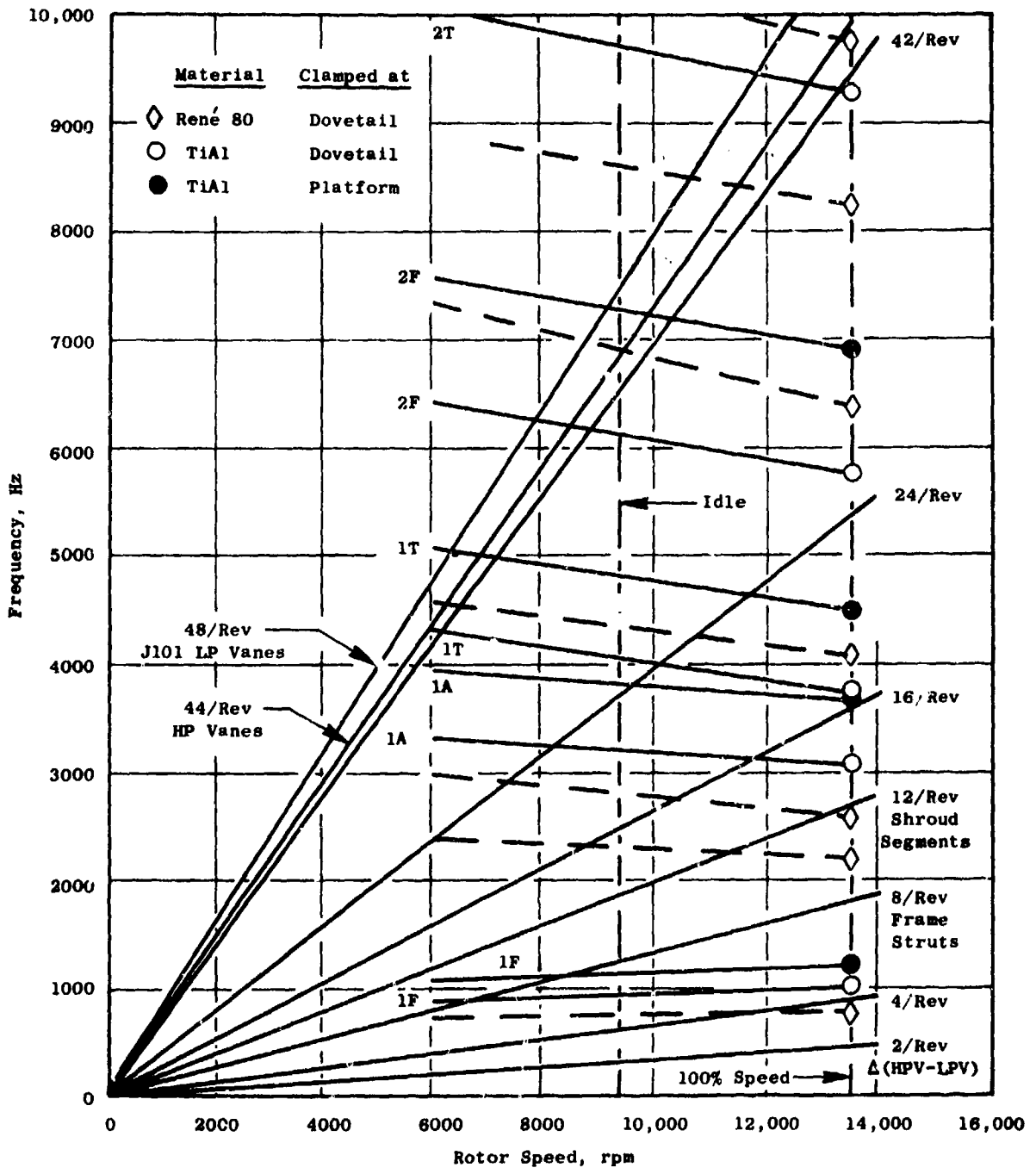
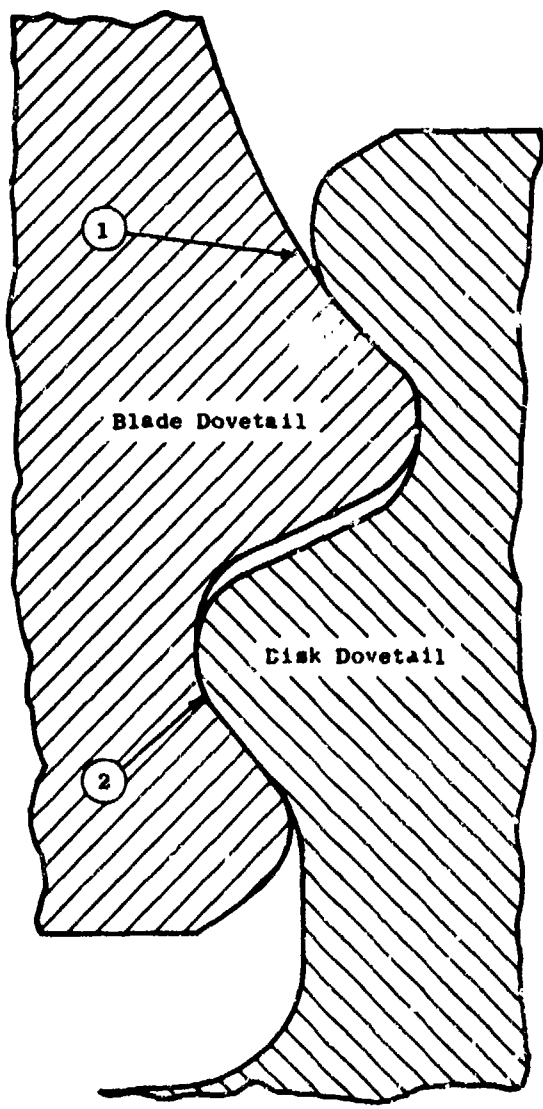

Figure 5. J101 LPT TiAl Blade; Estimated Campbell Diagram.



	<u>Maximum Stress, ksi</u>	
	<u>1</u>	<u>2</u>
<u>René 80 Blade</u>		
Neck Centrifugal	58.6	33.3
Tang Bend	29.7	37.7
Combined	99.0	107.1
Predicted LCF Life	1.2×10^4	$>10^4$
<u>TIA1 Blade</u>		
Neck Centrifugal	27.7	14.6
Tang Bend	13.0	16.5
Combined	45.6	46.9
Predicted LCF Life	$>10^5$	$>10^5$

Required LCF Life = 5000 Cycles
 rpm = 13,533
 LCF = Cycles to Failure

Figure 6. Preliminary J101 LP Turbine Dovetail Stresses in Blade and Disk.

A disk analysis was made using the General Electric Elastic Disk computer program. Three basic configurations were studied, and the results are shown in Table 18. The configurations were as follows: Case I was the base case, the present J101 LP turbine with René 80 blades and a René 95 disk; Case II was the maximum-weight-savings case (consisting of the TiAl blades (though limited, as noted before) together with a René 95 disk sized for the lighter blades and for the same speed capability as Case I; and Case III was the rotor-overspeed evaluation case, where the standard René 95 disk size from Case I was used and the rpm increased until the disk stress reached the same limits as in Cases I and II. The blades used in Case III were the TiAl blades from Case II; the lower blade life due to higher blade stress at the Case III rpm was assumed to be offset by increased blade-cooling air.

The maximum weight savings identified (Table 18) is shown in Case II as 17.6 pounds, where 10 pounds were saved in the blades and 7.6 pounds were saved in the René 95 disk.

The maximum rotor overspeed capability was identified to be 155 percent N or 18 percent higher than the 137 percent N capability of the Case I standard disk. However, it should be noted that, although this may seem significant, it is somewhat academic from a turbine-design point of view. In the design of a new turbine, blade life is the overriding design concern, and disk weight is a secondary concern. Thus, in practice, the Case III penalties of high blade stress and high blade cooling flow would more than offset the benefit of an 18 percent disk-overspeed capability.

3. Manufacture

Potential manufacturing processes for TiAl are conventional and isothermal forging, Hot Isostatic Pressing of powder (HIP), extrusions, and casting. Machining methods are conventional machining, Electro Discharge Machining (EDM), and Electro Chemical Machining (ECM).

In considering which manufacturing methods were most attractive for a TiAl turbine blade, the need for an internal blade-cooling system was a prime consideration. The present cast-nickel-alloy J101 LP turbine blade design has a high-twist airfoil and five cast-in-place, twisted, radial, round cooling holes through the entire blade. A review of TiAl manufacturing methods showed that a cooled TiAl blade with the present aerodynamic design could be manufactured by either of two methods. These methods, as tabulated in Table 19, are: (1) casting with a cast-in cooling passage, or (2) cast in two blade halves, machined per the methods listed above, and diffusion bonded.

Casting with cast-in cooling passages was preferable for simplicity, but a core material (required to make the serpentine cooling passages) is not available within the present state of the art.

Method 2, likewise, has drawbacks. These include the high cost and development work of diffusion bonding and the inability to inspect the bond joints inside the blades.

Table 18. Blade and Disk Weight and Overspeed Capability.

Item	Case I (base)	Case II (max. wt. savings)	Case III* (rotor over- speed)
Blade			
Material	René 80	TiAl	TiAl
Configuration	Present	Present	Present
Weight (lb/engine)	18.3	8.3	8.3
Weight Savings (lb/engine)	-	10.0	10.0*
Disk			
Material	René 95	René 95	René 95
Configuration	Present	Resized	Present
Weight (lb/engine)	28.0	20.4	28.0
Weight Savings (lb/engine)	-	7.6	0
Overspeed (%)	137	137	155

*Additional cooling of the Case III blade must be provided to give full life under the high speed.

Table 19. Material/Manufacturing Combination Candidates for T1A1 LP Turbine Blades.

Material	René 80 Cast	T1A1 Cast	T1A1 Cast	T1A1 Cast	T1A1 HIP	T1A1 Forged
Cooling System	Radial Holes (Cast)	Serpentine (Cast)	Serpentine (Cast)	Serpentine (Cast)	Serpentine (Machined Halves)	Serpentine (Machined Halves)
Special Mfg. Methods	None	None	Diffusion Bonded Blade Halves	Diffusion Bonded Blade Halves	Diffusion Bonded Blade Halves	Diffusion Bonded Blade Halves
Configuration Modifications	None	None	Blade Redesign	Blade Redesign	Blade Redesign	Blade Redesign
Technology Needs	None	Sophisticated Core + Core Material	Diffusion Bond	Diffusion Bond	Diffusion Bond	Diffusion Bond
Cooling Air Increase	0	+ (*)	+	+	+++	+++
Cost Increase	0	+++	+	+	+	+
Risk	0	+++	++	++	++	+++

*Increasingly negative features are denoted by "+"

4. Summary

The design studies showed that the TiAl J101 LP turbine blade requires extensive cooling to meet rupture-life requirements. A manufacturing-feasibility study showed that the high-twist J101 LP turbine blade, when cooled, is not manufacturable within the present TiAl state of the art. A single-blade casting with cast-in cooling passages required development of a yet unidentified core material. Forging, HIP, or casting of the blade in halves are risky alternative manufacturing techniques and are not attractive because of the following: (1) they require final assembly by diffusion bonding, which requires development work; (2) they are expensive; and (3) the bond joints would be difficult to inspect. However, in order to investigate the full range of TiAl payoffs and limitations, the blade study was completed assuming that TiAl manufacturing capability would be developed in the future.

The design studies showed that a redesign of the present blade is required to meet rupture and LCF life requirements. TiAl, though 45 percent lower in density than the present René 80 superalloy, does not possess the temperature capability required for this particular application.

The centrifugal stresses and/or bulk temperature must be reduced substantially to meet the required rupture life. Centrifugal stress could be reduced by tapering the airfoil, but this would only account for approximately 7 percent of the 37 percent reduction in stress needed to meet the required rupture life. Reducing the bulk temperature requires a cooling-system redesign. To meet LCF life, a cooling-system redesign with film cooling may be required to compensate for the low conductivity of TiAl as compared to the present alloy. Blade frequencies and dovetail stresses were within acceptable limits.

Rotor weight savings were evaluated where the blade weight was reduced due to the substitution of the lighter weight TiAl for René 80, and the René 95 disk weight was reduced since less disk material was required to carry the lighter TiAl blades for the same disk-stress criteria. A weight savings of 1.0 pounds for the blades and 7.6 pounds for the disk can be obtained using TiAl LP turbine blades at the 100 percent design speed.

Rotor overspeed was investigated but was found to have little impact on real LP turbine payoff. A potential overspeed increase of 18 percent was calculated but was possible only through overcooling of the blade. Blade life is therefore, the cooling required is a major LP turbine design concern, whereas disk weight is a secondary concern. Thus, the overspeed increase for TiAl blades, already life-limited at 100 percent, is judged not to be a significant payoff.

In summary, a direct replacement of TiAl for the present nickel-base superalloy in a J101 LP turbine blade is not possible at present. A blade redesign plus a new method of manufacture (which is expensive and unproven) would be required to meet blade-life goals. Weight savings both in the blades and in the nickel-alloy disk were identified but are dependent on a successful blade redesign. Higher overspeed capability was identified, but higher blade cooling flow was also required which negates the overspeed increase.

The overall LP turbine blade design study shows that the J101 presents too severe an operating environment to realize significant payoffs through the use of TiAl blades.

Any further studies of TiAl utilization in air-cooled turbine blade designs should be carried out in more detail where: (1) a revised design criteria considering the ductility limitations of TiAl (not considered in this study) is addressed and (2) lower temperature applications (below 1500° F in high-stress blades) are considered. These recommendations are based on the alloys considered in this study; however, on-going alloy development and improvements should permit higher temperature turbine blade applications in the future.

B. F101 FOURTH-STAGE COMPRESSOR BLADE

1. Introduction

Long-life, vibration-free, compressor-blade designs are derived from rugged, long-chord, low-aspect-ratio airfoils. In general, long-life blades must be designed for low operational and stall stresses, low deflection, and good tolerance to foreign object damage. A major cause of airfoil fatigue in turbomachinery is resonance. This phenomenon occurs when the frequency of aerodynamic exciting forces on the airfoil coincides with a blade natural-mode frequency. The major sources of these excitations are the passing frequencies of adjacent, stationary-airfoil rows (or struts) and fan-distorted, unsteady flow driving the airfoil at low-ordered frequency.

Compressor blades are designed to avoid the potentially dangerous two per rev stimulus. Other undesirable resonances are avoided by designing the blades to the following criteria:

- No natural blade modes in resonance with 1/rev or 2/rev from idle to 110 percent speed
- The first-flexural mode must have a minimum frequency margin of 15 percent with respect to 2/rev excitation at the worst condition
- Coincidence of the first-flexural mode with 3/rev and higher, even-order per revs at steady-state speed must be avoided
- Coupled blade-disk modes must be checked for compliance with the above requirements

Because titanium has been so widely used in compressors, the use of a non-pyrophoric titanium alloy deserves consideration; however, this consideration must be tempered with concern about the risk of using a material with the low-ductility characteristics exhibited by titanium aluminide alloys. The low ductility of these alloys at room temperature will probably require special handling procedures to avoid mechanical-impact loads that could damage the blades during assembly and disassembly.

Design advantages of titanium aluminide compressor blades (Figure 7) can be defined in four major areas:

- Direct weight savings due to lower material density.
- Weight saving in disk due to reduced rim load.
- Safer operation due to elimination of potential pyrophoric hazards.
- Increased blade ruggedness with no weight penalty.

Should a TiAl base alloy prove suitable as a compressor blade material, the substitution of this nonpyrophoric material in Stages 4 to 9 of the F101 compressor could show a significant weight saving and would eliminate a potential pyrophoric hazard.

2. Life Based on Steady-State Conditions

Steady-state stresses and deflections for the F101 Stage 4 compressor blade are summarized in Figure 8, which shows a comparison of Ti-36Al-5Nb with Ti 6-2-4-2 and Inconel 718. The calculated stress levels for Ti-36Al-5Nb are sufficiently low, when compared to the material properties, to ensure a long-life design. Deflections are essentially the same magnitudes for all three materials. Careful attention to blade pretwist and tilt can modify these deflections if desired.

Maximum blade and dovetail stresses are compared to 0.2 percent yield strength and ultimate strength in Figure 9 for Ti-36Al-5Nb. Both blade and dovetail stresses are on or below the estimated 0.2 percent yield strength. Note that all -3 σ properties for the Ti-36Al-5Nb have been estimated by examining the available Ti-36Al-5Nb data and by using -3 σ reductions typical for titanium material. The low-cycle fatigue strength of Ti-36Al-5Nb is sufficient to ensure more than 10⁷ cycles. The pseudostrains calculated from the maximum airfoil stress for a stress concentration factor (Kt) of 3.0 and maximum dovetail strain range (Kt = 1.0) are plotted on the LCF material properties curve for Ti-36Al-5Nb in Figure 10. Due to foreign object damage considerations, a stress concentration factor of 3.0 must be applied to the steady-state stresses on the airfoil leading and trailing edges and checked for adequate residual vibratory life. The vibratory life must meet the foreign object damage (FOD) requirements of Mil-E-5007D paragraph 3.2.5.6.2 which states that, for FOD to fan blades or stators (also compressor components) with a resulting Kt of 3, the engine must operate for two inspection periods or the number of hours specified in the engine specification. Since the blade dovetail is outside the flow-path region, no additional FOD stress concentration has to be applied to the dovetail.

Stress analysis showed that rupture life far exceeded the design criteria. This was due to the relatively low operating temperature of 630° F. Referring to the Ti-36Al-5Nb rupture properties (Figure 11), the Larson Miller parameter for a maximum blade stress of 19,149 psi (Figure 8) is 49.4. At a 630° F operating temperature, the rupture life is greater than 10⁵ hours. Actually, rupture life will remain greater than 10⁵ hours at 20 ksi stress up to a



- F101 Engine 4th Stage
- Inconel 718

TiAl Potential Payoff

- Reduced Weight
- Reduced Dovetail Loading

Figure 7. Compressor Blade.

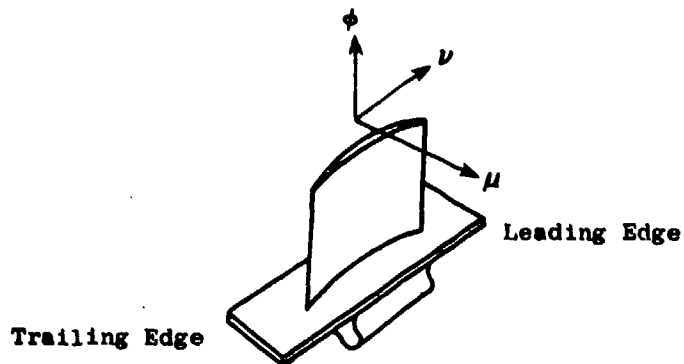

Parameter	Ti-36A1-5Nb	Ti 6-2-4-2	Inco 718
μ - Tangential, in.	-0.104	-0.106	-0.0969
ν - Axial, in.	0.004	0.004	0.0024
ϕ - Rotational, degrees	0.684	1.249	0.728
Maximum Resultant Airfoil Stress, psi	19,149	23,400	40,335
Allowable Vibratory Stress, psi	21,600	39,500	37,400
Maximum Dovetail Stress, psi	30,100	32,900	65,000
Dovetail Crush Stress, psi	25,100	29,000	52,000
Density, lbm/in. ³	0.135	0.164	0.296
Elastic Modulus at 630° F, psi	23.4(10 ⁶)	14.5(10 ⁶)	26.5(10 ⁶)
Shear Modulus at 630° F, psi	9.5(10 ⁶)	5.4(10 ⁶)	10.5(10 ⁶)
0.2% Yield at 630° F, psi	37,000	54,000	128,000

Figure 8. Comparison of Ti-36A1-5Nb with Titanium and Inconel 718 as the F101 Stage 4 Blade Material.

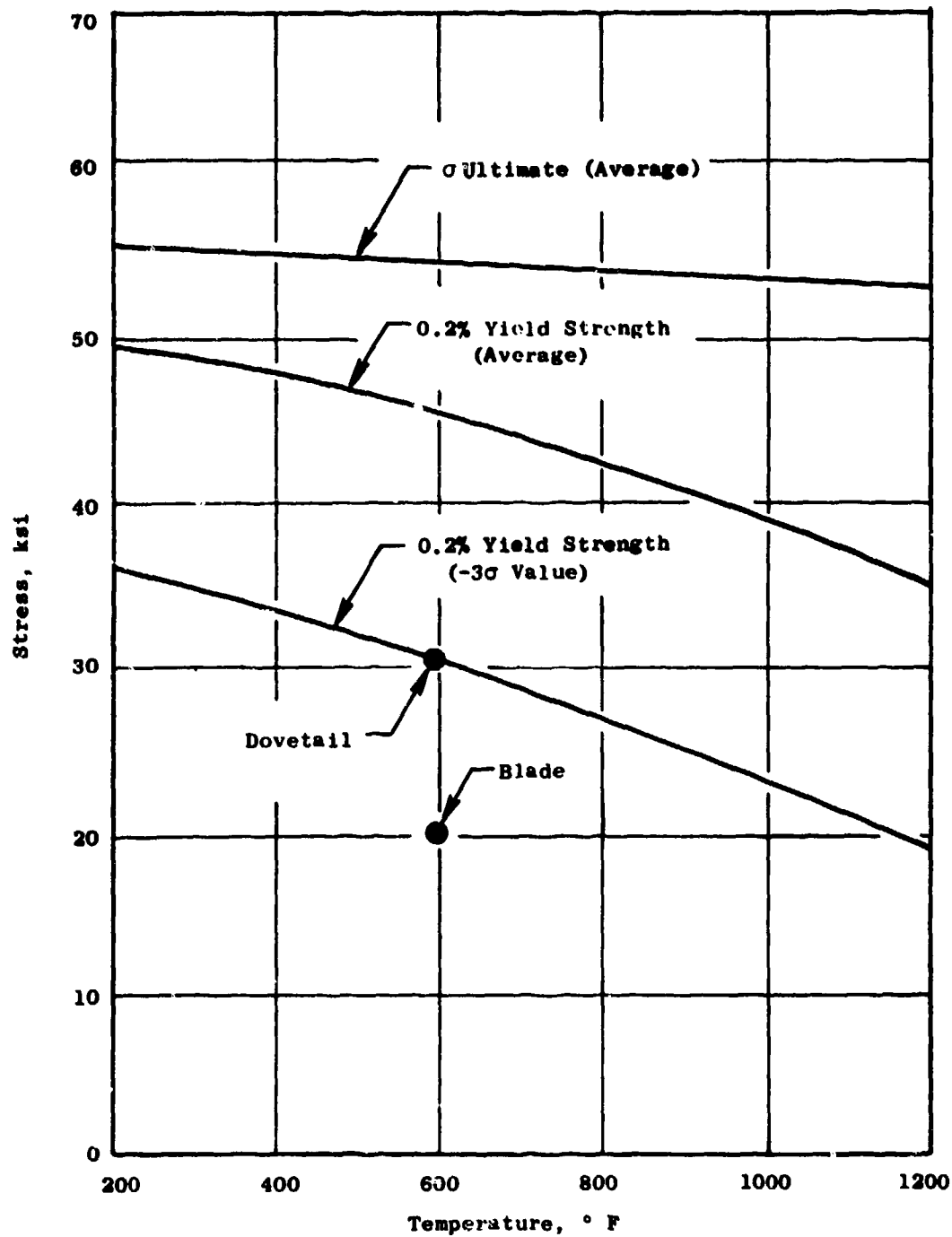

Figure 9. Maximum Blade and Dovetail Stress for Ti-36Al-5Nb F101 Fourth-Stage Compressor Blade.

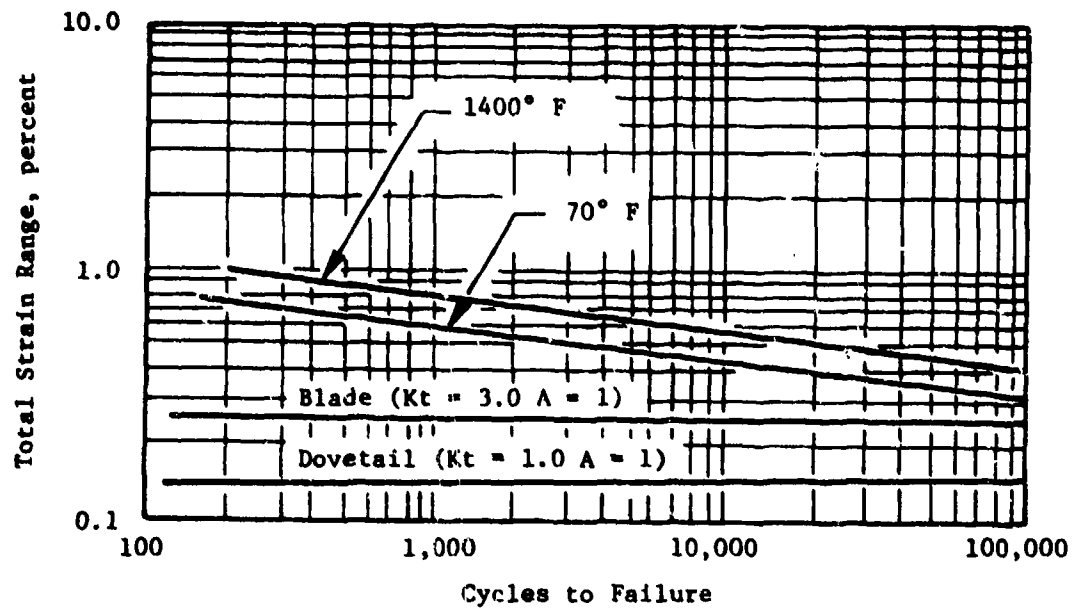

Figure 10. Strain Range of Ti-36Al-5Nb F101 Fourth-Stage Compressor Blade.

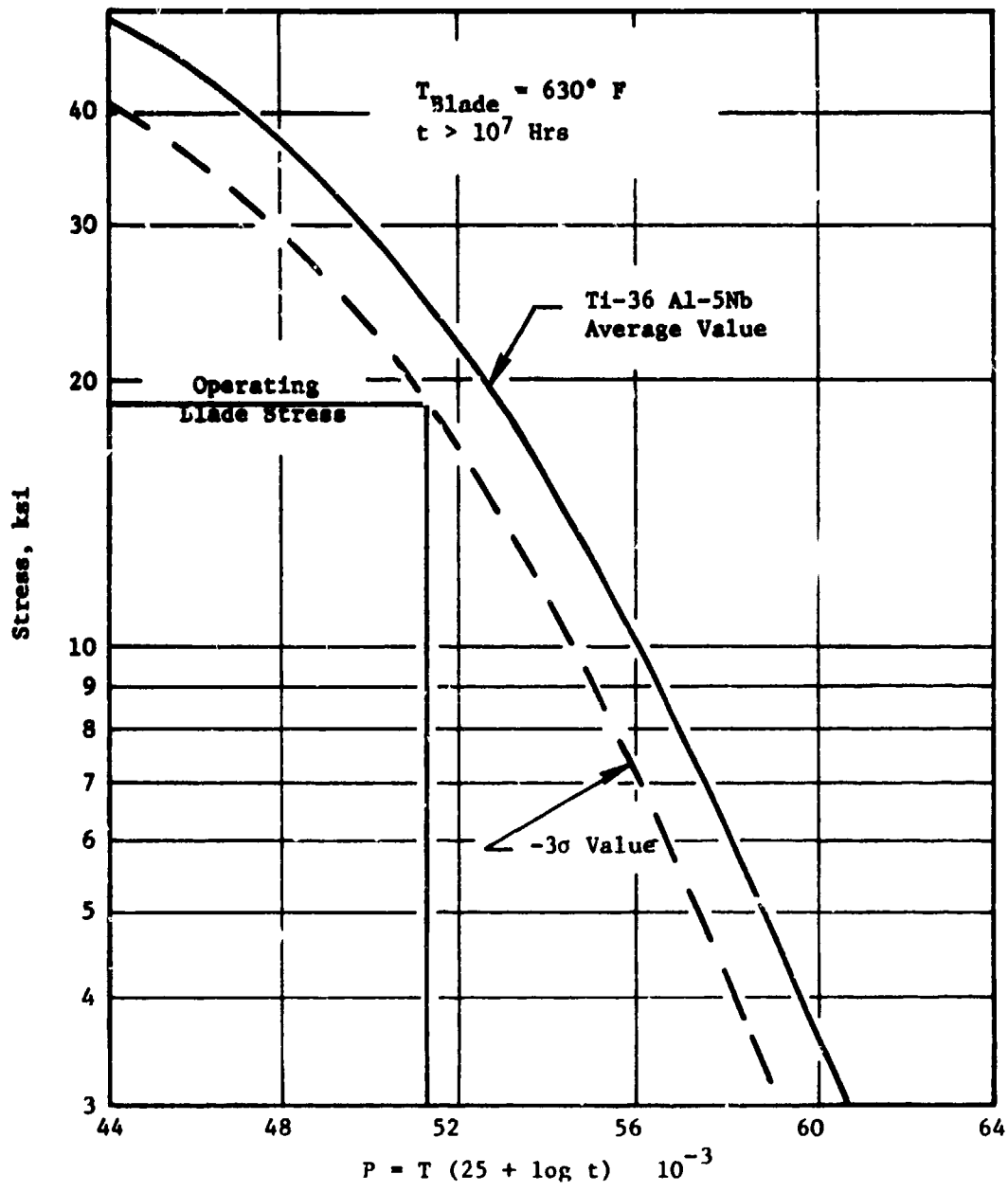

Figure 11. Stress Rupture Life of Ti-36Al-5Nb F101 Fourth-Stage Compressor Blade.

temperature of 1240° F. This indicates that even the aft-stage compressor blades made from Ti-36Al-5Nb should have sufficient rupture life.

The stresses and deflections summarized in Figure 8 were calculated using standard, structural, computer programs. The blade stresses were calculated using the General Electric Twisted Blade program. Dovetail stresses were calculated using the results from the Twisted Blade program in conjunction with the General Electric Single Tang Dovetail program. Disk stresses were calculated using an elastic-disk analysis.

3. Vibration Analysis

Vibration and stability characteristics of the F101 fourth-stage compressor blade made from Ti-36Al-5Nb are adequate and in some ways are superior to blades made from either Ti-6-2-4-2 or Inconel 718. Frequency-response characteristics for the blade are displayed on a Campbell diagram in Figure 12. This diagram shows frequency response for the Ti-36Al-5Nb blade with Ti-6-2-4-2 and Inconel 718 blade natural frequencies. Natural frequencies for the Inconel 718 and Ti-6-2-4-2 blades were obtained from bench tests. Both the flexural and the torsional frequency responses are higher for the Ti-36Al-5Nb blade due to the lower density (ρ) and high elastic modulus (E). Due to the higher E/ρ of titanium aluminide relative to titanium or steel, the first-flexural-frequency increase is coincident with an 8/rev stimulus at approximately 100 percent speed. Since the F101 fan frame has eight struts, even though they are far removed from the Stage 4 blades, a potentially unfavorable source of excitation exists within the operating speed range. If a problem develops, the airfoil thickness ratio, t_m/c , could be modified between the blade root and tip to either raise the first-flexural frequency above 8/rev or lower the frequency so that the 8/rev crossover would occur lower in the speed range, preferably at a transient rather than a steady-state operating point.

The 42/rev excitation caused by the inlet guide vanes should have minimal effect on the fourth-stage blades due to attenuation by the previous stages. Also, the high excitation frequencies, such as the 42/rev, require large energy input to produce large stresses. These large energy inputs are not available near idle where this critical frequency occurs. In addition, the available vibratory stress limits are high near idle due to low blade operating temperature and low mean-stress level.

The reduced velocity parameter, which indicates sensitivity to aerodynamic excitation, is lower for Ti-36Al-5Nb because of the higher frequencies. In this respect Ti-36Al-5Nb is superior to Ti-6-2-4-2 and Inconel 718.

Analysis indicates that sufficient vibratory stress range was available at the calculated mean stress. At a mean stress of 19.1 ksi (Figure 13) on the blade, 20.8 ksi alternating stress is allowable based on -3 σ estimated material properties. Note that Goodman diagrams are usually plotted using 10⁷ cycles life but due to insufficient data 10⁵ cycles was used. F101 test results indicate this level of vibratory stress is sufficient. Based on the available blade alternating stress, corresponding dovetail vibratory stresses were calculated. These stresses are plotted on the Goodman diagrams both for the first-flexural and for the first-torsional modes (Figures 13 and 14).

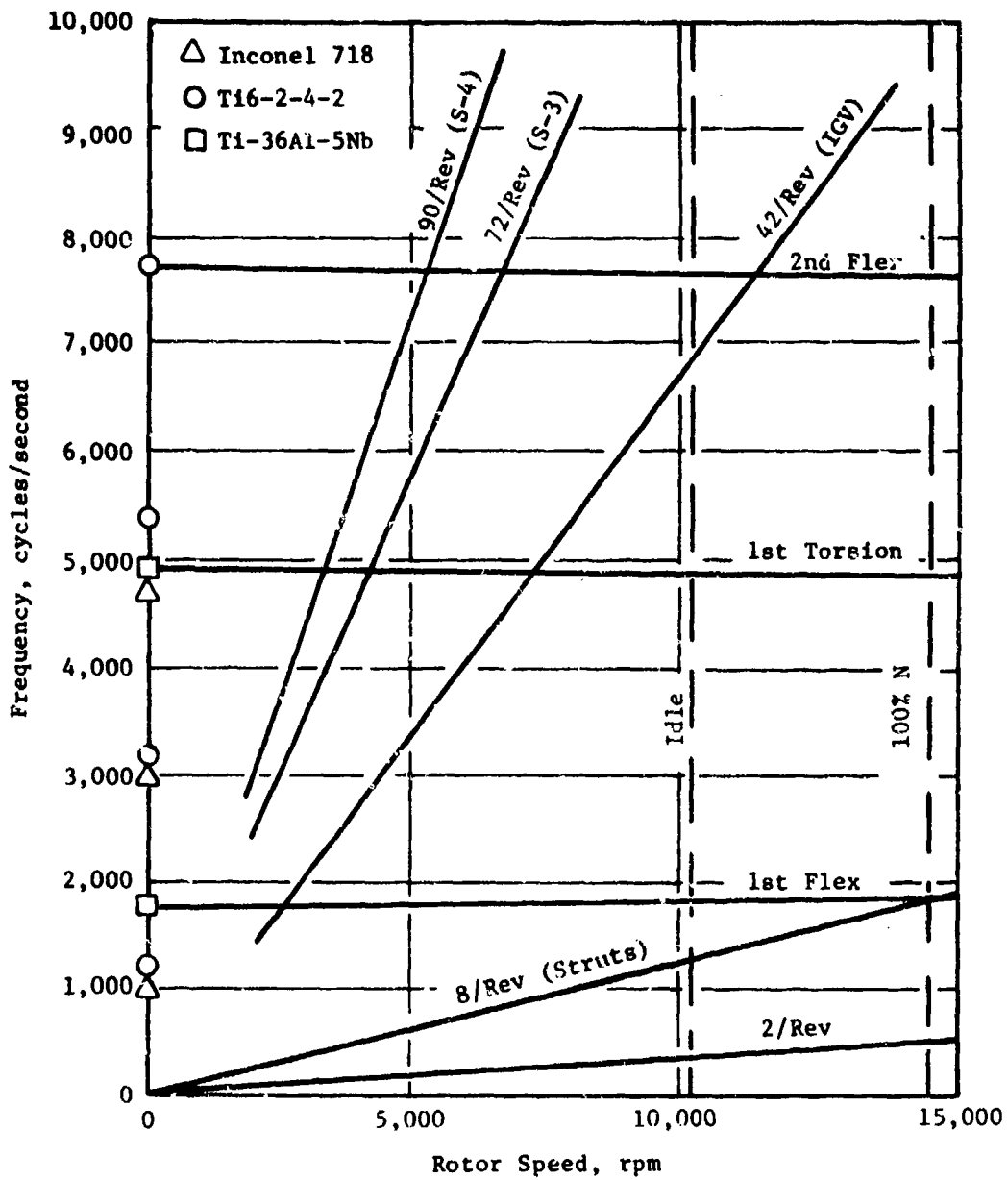

Figure 12. F101 Fourth-Stage Compressor Blade Campbell Diagram.

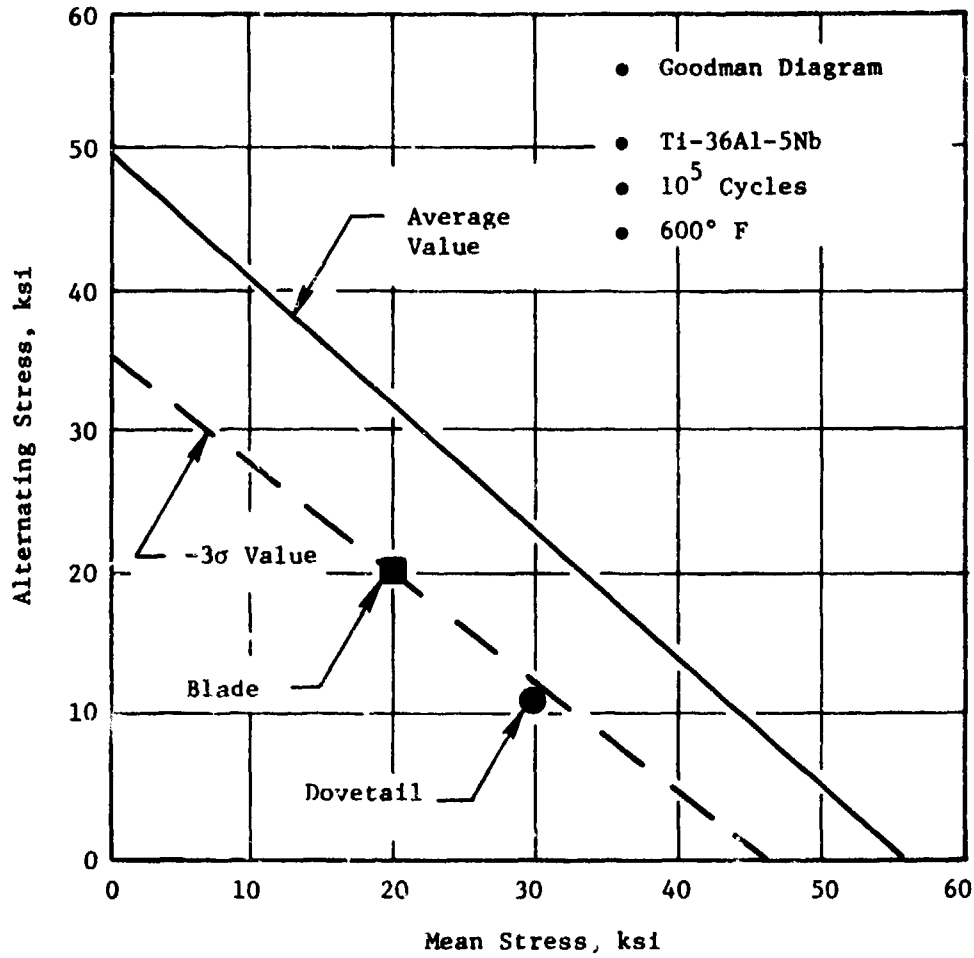

Figure 13. First-Flexure Stress; F101 Fourth-Stage Compressor Blade.

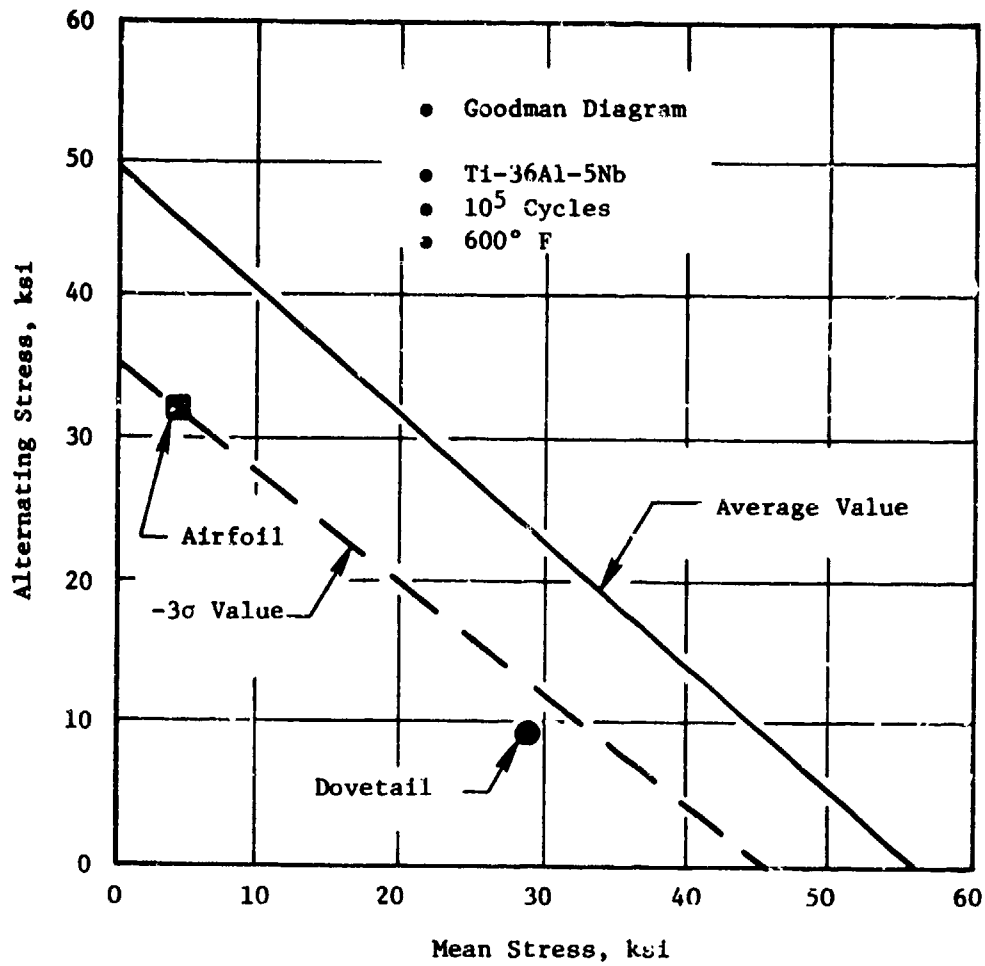

Figure 14. First-Torsion Stress; F101 Fourth-Stage Compressor Blade.

respectively). In both cases, the dovetail vibratory stresses fall underneath the -3σ curve on the Goodman diagram and are, therefore, less severe than the blade alternating stress.

4. Weight Analysis

The primary payoff of Ti-36Al-5Nb compressor blades is reduced weight. Blade and disk weights are summarized in Table 20 which compares Ti-36Al-5Nb with Ti-6-2-4-2 and Inconel 718. Although detail analysis was conducted for the fourth stage only, weights are estimated for the entire compressor based on all stages being fitted with Ti-36Al-5Nb blading. Weight reductions obtained by using Ti-36Al-5Nb are very large percentage-wise. As an example, Ti-36Al-5Nb fourth-stage blades are only 45 percent of the weight of equivalent Inconel 718 blades.

5. Summary

Based on the preliminary stress and vibration analyses, compressor blades appear to provide an attractive, weight-saving application for titanium aluminide alloys. The nonpyrophoric property of TiAl eliminates the potential of a pyrophoric hazard that resulted in replacing the original Ti-6-2-4-2 compressor blades with Inconel 718 blades in the F101 engine. The low ductility of the titanium aluminides, however, is a reliability concern since extensive engine damage can result from a compressor blade failure. The low ductility of titanium aluminides at room temperature is an additional concern. Special assembly and disassembly procedures may be required in order to protect the blades from impact damage.

A comprehensive development test program would be required before a titanium aluminide blade would be committed to an engine test. The additional materials properties and the type of bench tests that would be required are listed in Table 21.

C. F101 MIXING DUCT

1. Introduction

In a turbofan engine such as the F101, an increase in thrust can be realized by mixing the hot core gas with the cold fan stream before discharging the mixed-gas stream through a common exhaust nozzle. The mixing of the hot and cold gas streams in an augmented engine can also facilitate flame propagation and result in increased combustion efficiency and a shorter burning length.

In the F101 daisy-chute mixer shown in Figure 15, the hot core and the cold fan streams enter the mixer as concentric, annular streams. The mixer changes the concentric-flow streams into narrow, radial, hot and cold jets. The increased shearing interface between the hot and cold streams decreases the mixing length required to exchange momentum from the energetic core stream to the cool fan stream. During augmented operation, the mixer also aids in the combustion process since the flame-propagation front must only traverse a short distance through the cold-air stream. To realize these performance benefits from the mixer, the mechanical-design effort must be fully coordinated

Table 20. Weight Reduction of Current F101 Compressor with TI-36A1-SMB Compressor Blades.

Stage No.	Material		Current F101 Compressor				TI-36A1-SMB Blades			
	Blade	Disk	Blade	Disk	Stage	Blade	Disk	Stage	Weight (lb)	
1	TI-8-1-1	TI-17	0.203	15.0	22.70	0.173	12.75	19.32		
2		→	0.068	8.46	13.13	0.075	7.20	11.18		
3		→	0.048	10.69	13.57	0.041	9.09	11.65		
4	Inco 718	René 95	0.048	10.36	13.62	0.022	6.73	8.26		
5		→	0.034	6.46	9.02	0.016	4.20	5.40		
6		→	0.027	6.46	8.68	0.012	4.20	5.18		
7		→	0.022	8.19	10.00	0.010	5.33	6.15		
8		→	0.021	7.99	9.67	0.010	5.20	6.00		
9		→	0.021	7.17	8.77	0.010	4.66	5.42		
Total Compressor Weight					109.16 lb					
Net Weight Reduction					30.73 lb					

Table 21. TiAl Compressor Blade Evaluation Program.

Material Data Required (Room Temperature to T_{Max})

- Tensile and rupture strength
- High and low cycle fatigue
- Impact strength
- Crack propagation
- Wear/fatigue tests for galling or fretting
- Erosion
- Coatings

Blade Rig Tests

- Pellet impact
- First mode (hot) endurance
- Cyclic loading of airfoil and dovetail
- Nodal patterns
- Stress distribution
- End effects



Figure 15. F101 Mixing Duct.

with the aerothermal design in order to achieve a lightweight design with low drag or frictional losses.

The F101 mixing duct was selected as one of the two static components to be studied as potential applications of titanium aluminide alloys because of the potentially large weight saving. In a direct material substitution of Ti_3Al for Inconel 718, the weight of the mixer can be reduced from 96 pounds to approximately 55 pounds. A direct material substitution without a redesign would lend itself to a realistic comparison of weight, cost, and engine performance. In addition, if this application was selected for fabrication and testing, a full-scale-engine evaluation test would be relatively simple as the mixer could be easily installed and run as part of a planned engine program.

2. Design Considerations

The mixing duct is of sheet metal that derives most of its strength from double-curvature construction. The mixer is essentially a low-stressed component with extensive chem-milling of selected areas to achieve a lightweight design. The chem-mill pattern is designed to leave heavier stock thickness in the following areas:

1. The trailing edge of the chutes to prevent flutter
2. At the mount or support bracket areas to distribute the load
3. Along the butt-weld lines to facilitate manufacturing and reduce the percent of weld offset

The mixer is subjected to extremely high heating rates by radiation from the combustion zone during augmented operation. The mixer mounts and links must be capable of accommodating both radial and axial differential expansion between the mixer and the duct.

The above considerations indicate the mixing duct material selection should be based on the following general physical properties:

- Low thermal expansion coefficient
- Low density
- Good low and high cycle fatigue life
- Good forming and joining properties

3. Design Analysis

The load diagram of the F101 mixing duct is shown in Figure 16 for the following load conditions:

1. Flameout during augmented operation at Mach 1.05 at sea level
2. Maximum steady-state flight at Mach 0.95 at sea level
3. A 15-g flight maneuver load

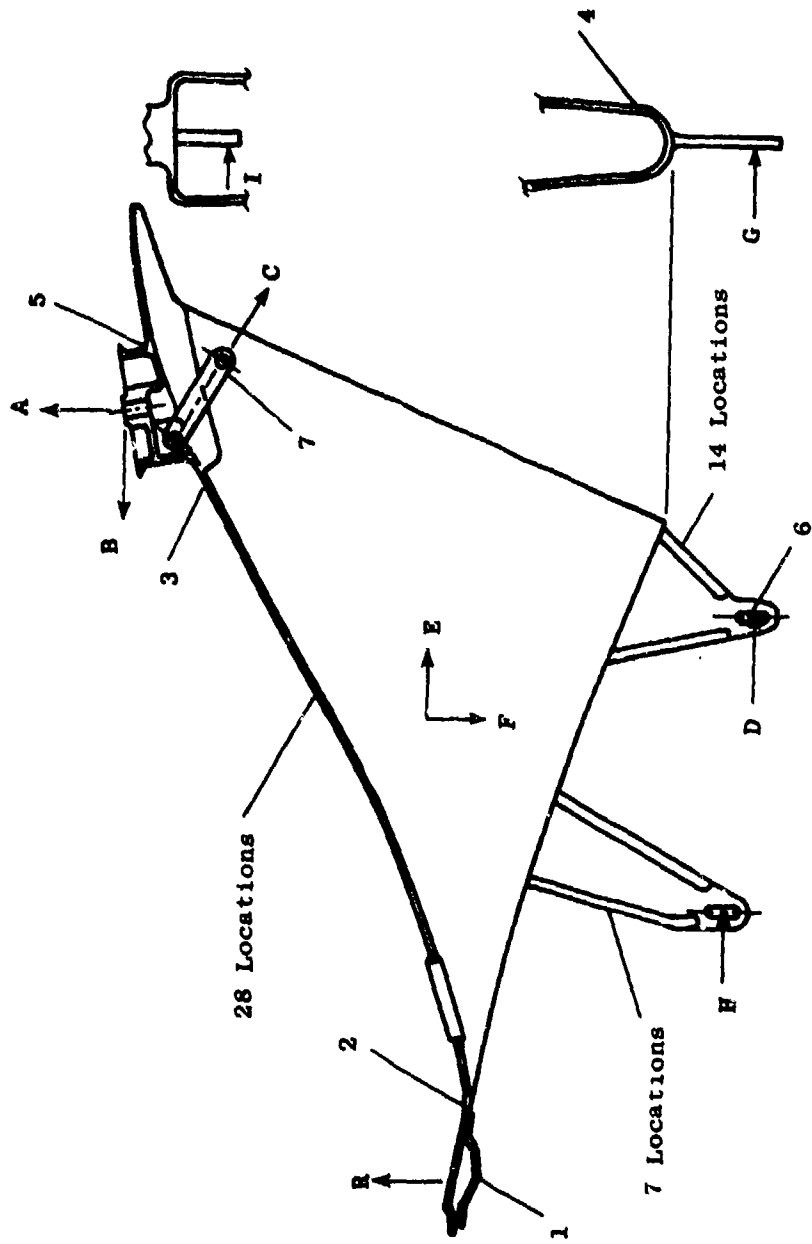

Load Condition	Force per Chute										
	A	B	C	D	E	F	G	H	I	R	
Blow-Out $M_p = 1.05$ (SL)	16	250	132	210	20	159	--	25	--	183	
Maximum Steady-State $M_p = 0.95$ (SL)	18	76	35	56	14	80	--	14	--	72	
15-g Maneuver	86	--	--	--	--	--	42	--	23	--	

Figure 16. F101 Mixing Duct Load Diagram.

These loads include the pressure and acceleration forces on the mixer and the attached flameholder and fuel injector support ring. The chem-mill pattern used in the mixer is such that the sheet metal thickness at the mount and support bracket areas, and other high-stressed areas, are thicker to distribute the load and reduce the local stresses to acceptable levels.

The differential pressure between the fan stream and the core stream results in bending stresses in the sidewalls. The maximum steady-state pressure differential of 1.12 psi across the chute walls occurs at Mach 0.95 and an altitude of 200 feet. A transient pressure differential of 3.0 psi can occur during an augmentor flameout at Mach 1.05 (sea level). The calculated steady-state bending stress in the chute sidewalls is 16,800 psi; the maximum transient bending stress is 45,000 psi. A summary of the mixing duct stresses is shown in Table 22.

The sidewalls of the mixing duct must not only be designed to resist the differential pressure across the chute walls and the local shear and bending loads from the support brackets but must also be checked for the susceptibility of panel flutter leading to high-cycle fatigue damage. The current design practice is to design the panel for a natural frequency above a one-per-engine-revolution excitation force.

The natural frequency of a plate or panel can be calculated from the general equation:

$$W_n = B [Et^2/\rho L^4(1 - \nu^2)]^{1/2}$$

Where W_n = Natural frequency of plate

B = A function of boundary conditions and mode number

E = Modulus of elasticity

t = Thickness of plate

ρ = Density

ν = Poisson's ratio

L = Length of plate

For given plate geometry and edge conditions, the natural frequency of a plate is a function of the square root of the modulus of elasticity, E , and the density, ρ , of the material. Therefore, in a direct substitution of materials, the natural frequency of the Ti_3Al F101 mixer can be calculated as follows:

$$W_n (Ti_3Al) = \frac{\sqrt{E/\rho} (Ti_3Al)}{\sqrt{E/\rho} (Inco 718)} \left[W_n (Inconel 718) \right]$$

$$W_n (Ti_3Al) = 1.18 W_n (Inconel 718) = 1.18 (360)$$

$$W_n (Ti_3Al) = 425 \text{ Hz} \quad (25,500 \text{ rpm})$$

Table 22. F101 Mixing Duct Stresses.

- Steady-State Operating Condition: Mach 0.95, 200 Feet, 127° Power Lever Angle
- Transient Operating Condition: Mach 1.05, 200 Feet, 127° Power-Lever Angle

Component	Temperature (F)	Failure Criteria	Max. Stress (psi)		Allowable Stress (psi) 0.2% Yield
			Steady State	Transient	
1. Forward Ring	1150°	Bending	5,750	14,800	76,000
2. Mixer Skin (Forward Ring)	1150°	Bending	3,190	8,120	76,000
3. Mixer Skin (Mtg. Strut)	950°	Bending	6,600	21,680	76,000
4. Mixer Skin (Radial Panels)	1300°	Bending	16,800	49,000	55,000

The substitution of Ti_3Al for Inconel 718 in the F101 is, therefore, an improvement because the frequency margin is increased by an additional 18 percent.

4. Summary

The direct substitution of Ti_3Al for Inconel 718 would result in a weight reduction from 96 pounds to 55 pounds based on the same weight-saving techniques used in the design of the F101 mixer, including chem-milling of low stressed areas. Although Ti_3Al has a lower allowable stress than Inconel 718, the calculated stresses are within the allowable stress level for Ti_3Al , even for the worst stress case of an augmentor flameout at $M_p = 0.95$ S.L.

The higher natural frequency of a Ti_3Al mixer should result in even greater resistance to flutter or high frequency fatigue. The lower thermal expansion coefficient of Ti_3Al would minimize the support required to accommodate the thermal expansion during engine operation.

D. F101 EXHAUST DUCT COOLING LINER

1. Introduction

In an augmented turbofan engine, such as the F101, fan air is used to cool the exhaust nozzle duct and the exhaust nozzle flaps. The cooling air passes through the annular passage formed by the liner and the exhaust duct as shown in Figure 17. Structural integrity of the liner is essential for maintaining the annular gap to ensure that an adequate and uniformly distributed supply of cooling air is available for cooling both the liner and the exhaust nozzle flaps.

The F101 exhaust nozzle liner was selected as an application for the use of titanium aluminide alloy because of a potentially large weight saving. In a direct materials substitution of Ti_3Al (Ti-14Al-21Nb) for Inconel 625, the weight of the liner can be reduced from 45.2 pounds to 33.0 pounds. A direct material substitution without a redesign would lend itself to a realistic comparison of weight, cost, and engine performance. In addition, if the liner was selected for fabrication and evaluation, a full-scale-engine test would be relatively inexpensive as the liner would be interchangeable with an Inconel 625 liner and could be installed in an existing engine and tested as part of an overall engine program.

2. Design Considerations

The exhaust duct cooling liner has three primary functions:

- Shield the exhaust duct from high temperature combustion gases
- Form an annular flow passage for cooling air to the exhaust nozzle
- Eliminate, or reduce to acceptable levels, screech or buzz occurring in the combustion process

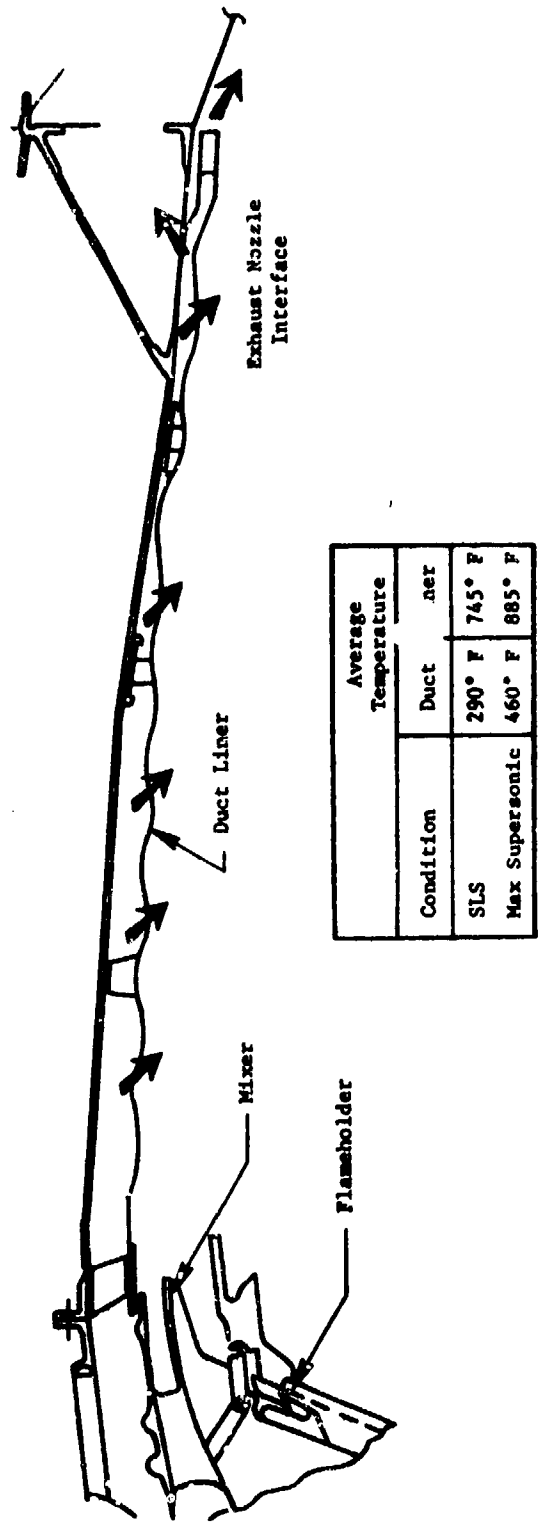

Figure 17. F101 Exhaust Duct Liner Cooling Flow.

The F101 liner shown in Figure 18 is a lightweight, sheet metal cylinder supported by hangers that are mechanically attached to the exhaust duct. The spacing and the location of the hangers also maintain the annular gap between the liner and duct.

A positive, inward, static pressure must be maintained across the liner to prevent hot core gas or fuel from entering behind the liner through the screech holes, cooling slots, or expansion joints. The pressure drop across the liner can change significantly where dams or other flow resistances are used to control the distribution of the coolant air. Large pressure differentials can exist near the exhaust nozzle where the main stream accelerates and where the combustion process during augmentation lowers the static pressure in the core stream. The number and location of the support hangers are functions of the differential pressure across the liner.

Differential thermal expansion between the liner, operating in the 400 to 1000° F range, and the duct, normally operating below 500° F, must be accommodated in both the radial and the axial directions. In the axial direction, the thermal expansion is accommodated by a slip joint in the aft section, and the radial thermal expansion is accommodated by allowing the liner to elastically buckle between the hangers. The liner is stiffened by shallow, circumferential corrugations that are effective vibration suppressors and can accommodate the differential thermal expansion generated by circumferential hot streaks during augmentation.

The above considerations indicate the liner material should be selected based on the following general physical properties:

- Oxidation resistance
- Rupture or yield strength
- Modulus of elasticity
- Coefficient of thermal expansion
- Manufacturing and weldability
- Repairability

3. Design Analysis

The F101 exhaust duct liner is cooled by back-side convection cooling with fan air that passes through the annulus between the liner and the duct and by film cooling from the fan air that passes through the screech holes. The temperature distribution of the liner and the duct at Mach 2.2 and 45,000-foot altitude is shown in Figure 19.

Differential thermal expansion due to the alternating hot and cold streaks on the liner is accommodated by circumferential corrugations. As shown in Figure 20, a 400° F temperature differential exists between the hot and cold chute patterns at approximately 19 inches from the leading edge of the liner.

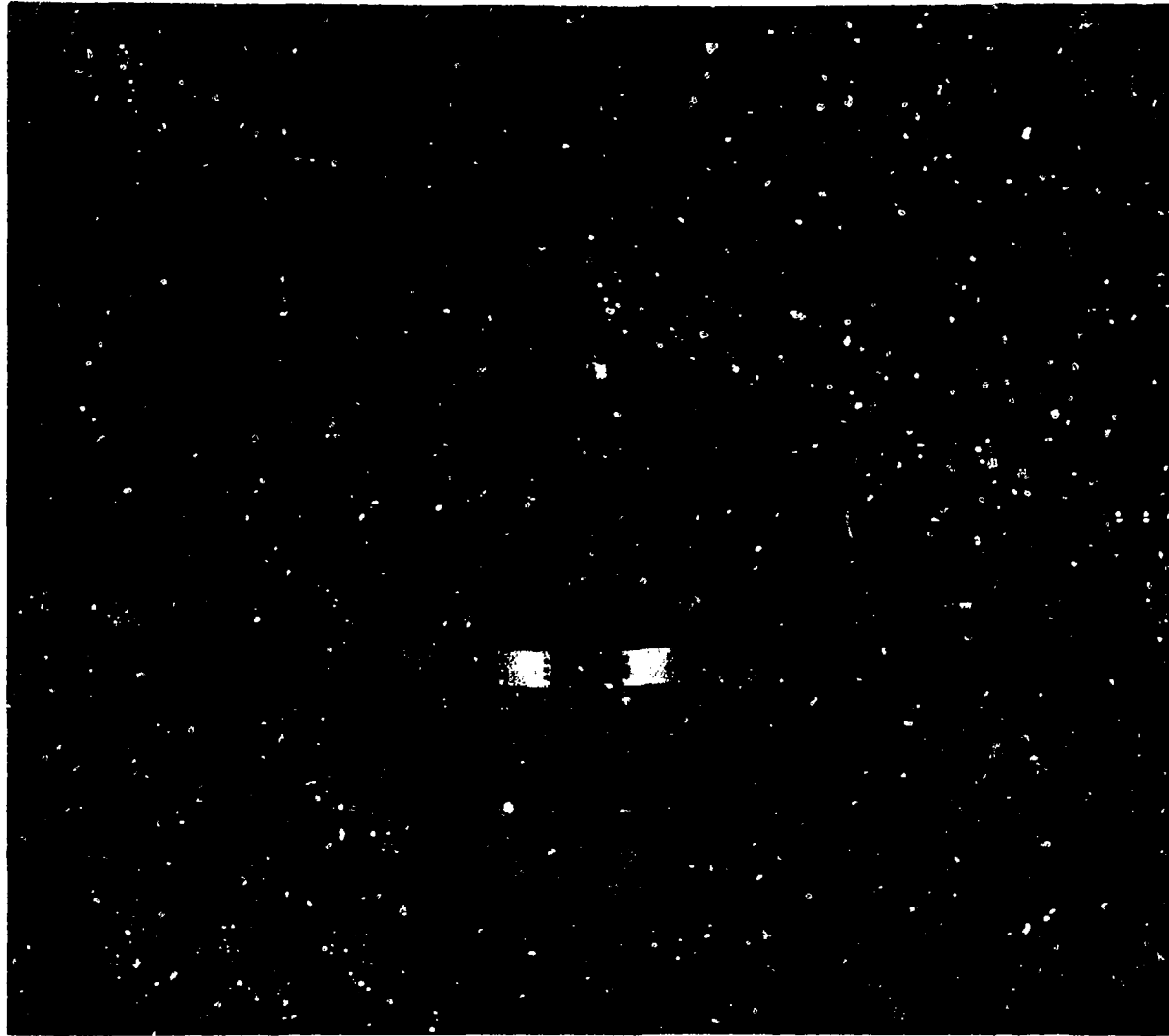

Figure 18. F101 Exhaust Duct Cooling Liner.

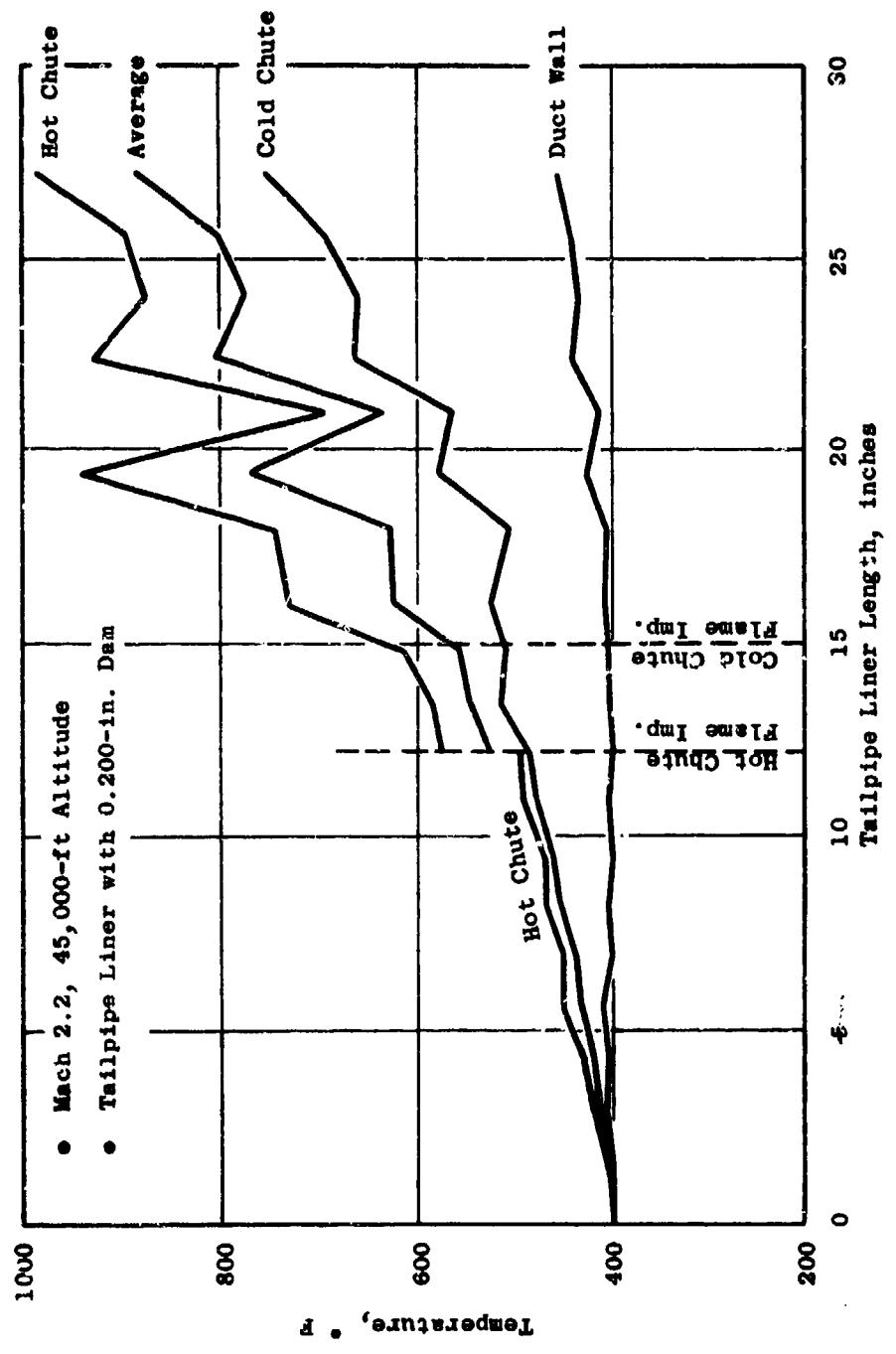

Figure 19. F101 Exhaust Duct Liner Temperature Distribution.

The thermal stress in a uniform flat plate subjected to a temperature change, ΔT , while held at the edges is $\Delta T \alpha E / (1 - \mu)$. Therefore, the change in the unit stress in substituting Ti_3Al for Inconel 625 is only a function of E and α of the materials. Since both the E and α of Ti_3Al are less than Inconel 625, the thermal stress is reduced by a factor of 2.48 from 12,500 psi to 5,040 psi at 1000° F liner temperature.

The positive, inward, static pressure differential across the liner would buckle the liner if it were not supported by hangers to the duct wall. The magnitude of the pressure differential across the liner as a function of liner length at Mach 2.2 at 45,000 feet is shown in Figure 20. In the direct substitution of Ti_3Al for Inconel 625, the lower modulus of elasticity of Ti_3Al reduces the critical buckling pressure since the general approximate equation for buckling of a cylinder held circular at given intervals, l , is:

$$P' = 0.807 (Et^2/lr^2) [(1 - \nu)^{-3} t^2/r^2]^{\frac{1}{4}}$$

where P' = Critical buckling pressure

E = Modulus of elasticity

l = Interval between supports

r = Radius

t = Sheet thickness

ν = Poisson's ratio

Thus, the critical buckling pressure is proportional to the modulus of elasticity, E , and the sheet thickness, t , to the 2.5 power. To maintain the same buckling strength and safety factor the sheet metal thickness must be increased an average 0.008 inch. The increased thickness in Ti_3Al would, therefore, decrease the weight saving that would have occurred for a straight material substitution.

4. Summary

The direct substitution of Ti_3Al for Inconel 625 in the F101 mixer would result in a weight reduction from 49.2 pounds to 33.0 pounds or a weight saving of 16.1 pounds using the same, weight-saving, manufacturing techniques as chem-milling of low stressed areas in the convoluted section.

The lower coefficient of thermal expansion and the modulus of elasticity of Ti_3Al compared with Inconel 625 would result in lower thermal stresses and a reduction in the axial and radial thermal-expansion-accommodation requirements of the supports and hangers. The Ti_3Al liner could be built to be interchangeable with the current Inconel 625 liner.

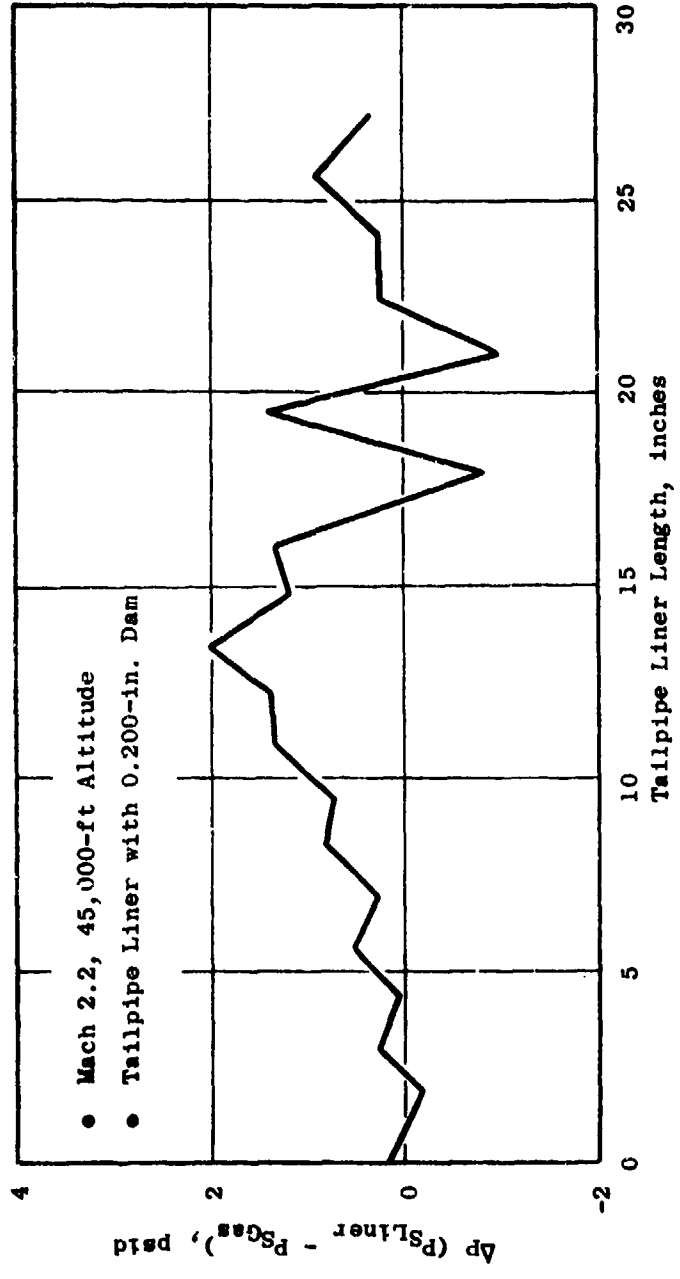

Figure 20. FI01 Exhaust Duct Liner Pressure Distribution.

V. TASK IV - DESIGN/COST TRADE-OFF ANALYSIS

A. INTRODUCTION

A Life Cycle Cost (LCC) model is normally structured with a number of interacting assumptions that have been mutually agreed upon by the customer and the cost analyst so that a meaningful cost comparison can be made within the scope and available funding of the program. In complex engine programs for military applications, the analysis usually includes:

- Research, Development, Test, and Evaluation
- Engine Acquisition
 - Installed engines
 - Spare engines
 - Production rate tooling
- Operation and Support

A brief summary of inputs required to estimate the values for the LCC model would include:

- Unscheduled-maintenance activity rates per millions of engine flight hours
- Estimated repair time for components
- Component costs
- Component and parts design life estimates with statistical distribution

A complete Life Cycle Cost Analysis, as described above, was beyond the scope of the present study and was not required to meet the major objective of this study (which was to establish the cost effectiveness of substituting titanium aluminides for nickel-base alloys in gas turbine engines either on a replacement basis or for future-engine applications). The results of this study were also needed to provide guidance to AFML in its current alloy-development program and provide guidelines for future AFML manufacturing-technology programs to fully utilize the titanium aluminide alloys.

B. LIFE CYCLE COST MODEL

The following life cycle cost model was selected as a model that would meet the above study objectives and could be completed in the scheduled time period to establish the cost effectiveness of the substitution of titanium aluminide for nickel-base superalloys.

1. The aircraft engine would be similar to the existing F101 engine but would be early in the design stage so that the full weight-saving potential of using titanium aluminide components could be realized throughout the aircraft system.
2. The mission would be a penetration-bomber, similar to the B-1, with a 20-year life span.
3. The total bomber fleet costs would be based on 240 aircraft.
4. It would be assumed that substitution of titanium aluminide will result in the calculated weight savings without any change in performance or structural integrity.

Using the above guidelines, the analysis was designed to establish the potential cost savings, over the life of the aircraft, for substituting titanium aluminide in the following components:

- Mixing Duct
- Exhaust Duct Cooling Liner
- Compressor Blades (Stages 4 to 9)

The analysis, to remain unclassified, relied on published data for the F101 engine and the B-1 penetrator-bomber mission as found in References 14 through 20.

C. LIFE CYCLE ANALYSIS CALCULATION PROCEDURES

The following procedures were used to determine the cost effectiveness of titanium aluminide components in the F101 engine:

1. Establish the baseline-system weight of the B-1 aircraft from unclassified, published data.
2. Calculate the new engine weight with titanium aluminide components.
3. Calculate the new system weight using scaling factors for a new engine airflow size and overall system weight.
4. Determine the baseline aircraft-system cost.
5. Calculate the new engine cost with titanium aluminide components.
6. Calculate the new system cost with the reduced structure cost and fuel requirements.
7. Estimate the total cost savings including the reduced structure cost and lifetime fuel savings.

The procedure and results of the above analysis are given in Appendix C.

D. LIFE CYCLE COST RESULTS

The baseline-system weight of 395,000 pounds for the B-1 penetrator bomber consists of the following items:

Weapons load	50,000 lb
Fixed equipment	25,000 lb
Structure	120,000 lb
Fuel	184,000 lb
Engines (4)	16,000 lb
Total System Weight	395,000 lb

Using titanium aluminide components, the engine weight can be reduced from 16,000 pounds to 15,649 pounds for a weight savings of 351.2 pounds. The cost of substituting titanium aluminide components is approximately \$10,000 per engine or \$40,000 per airplane.

The primary cost savings result from the reduced acquisition cost of the lighter weight aircraft and the reduced fuel costs over a 20-year period. The scaled weight of the aircraft is summarized below:

	<u>Current Weight, lb</u>	<u>Scaled Weight, lb</u>	<u>ΔWeight, lb</u>
Weapons Load	50,000	50,000	-
Fixed Equipment	25,000	25,000	-
Structures	120,000	119,400	600
Fuel	184,000	183,080	920
Engines (4)	16,000	15,649	351
Total Aircraft Weight	395,000	393,129	1,871

The structural cost savings resulting from the 600-lb weight reduction was estimated at \$154,000 per aircraft and the fuel saving at \$58,380 per aircraft. The net savings per aircraft can be calculated as follows:

Aircraft Structure Saving	\$154,000
Fuel Cost Savings	<u>58,380</u>
	\$212,880
Added Cost of TiAl Components	<u>-40,000</u>
Net Saving/Aircraft	\$172,880
Net Saving/240 Aircraft	\$41.6M (1977)

E. ADDITIONAL LIFE CYCLE COST STUDY

It is known, from previous experience, that the result of material substitution in a baseline engine will depend upon the aircraft type (bomber, fighter, etc.) in which the engine is used. Therefore, to obtain an indication of these differences, a short additional LCC study was performed. The new result was obtained when the baseline engine was used as the propulsion system of a hypothetical air-combat fighter. The previous four-engine penetrator bomber was designated by B, the air-combat fighter by F. The following values apply as ratios of the takeoff gross weight (TOGW):

Table of Characteristics

<u>Aircraft</u>	<u>B</u>	<u>F</u>
Structure/TOGW	0.304	0.33
Fuel/TOGW	0.466	0.30
(Load and Fixed Equip)/TOGW	0.19	0.203
Engine Weight/TOGW	0.04	0.167
Total Weight	1.000	1.000
Thrust/TOGW	0.304	1.25

The result for the air combat fighter, obtained by the same procedure as used for the bomber, was as follows:

Table of Results (Percent from Baseline)

<u>Aircraft</u>	<u>B</u>	<u>F</u>
Engine airflow size reduction	0.5	2.0
Airframe structural weight savings	0.5	2.0
Fuel savings	0.5	2.0

The relative savings from the baseline air-combat fighter, after substitution of titanium aluminide in the baseline engine, are four times as great as for the penetrator bomber. The reason is apparent in the table of characteristics; namely, the engine weight as a portion of the takeoff gross weight is greater by a factor of four for the fighter.

F. SUMMARY

The significant cost savings that can be made by substituting titanium aluminides for nickel-base superalloys proves the desirability of aggressively pursuing the development of titanium aluminide alloys and fabricating full-scale, interchangeable, titanium aluminide components for evaluation testing in an engine program. The estimated cost savings when applied to all future aircraft engines, both military and commercial, would be an order of magnitude larger than the \$41.6 million estimated for the 240 B-1 type aircraft.

Historically, the development of cost-effective, high-thrust-to-weight-ratio engines with low specific fuel consumption has been a series of small but steady improvements associated with an increase in operating temperature and the development of new alloys with improved properties to meet the increasingly severe environmental conditions. A successful titanium aluminide development program will add to this steady advancement as selected components are fabricated and introduced into future aircraft engines.

The life cycle cost savings both for the 240-bomber fleet and for the 5500-fighter fleet were based on titanium aluminide components fabricated from mill product raw stock. The raw stock cost was based on the historical cost trend of Ti-6Al-4V plus an added cost factor to reflect the increased tooling and forming costs of converting TiAl ingots into mill product forms. The sensitivity of the development costs of TiAl on the life cycle cost savings is shown in Figure 21. The development cost of TiAl can increase as much as 300 percent over the original projected costs and still result in a (smaller, but meaningful) cost savings.

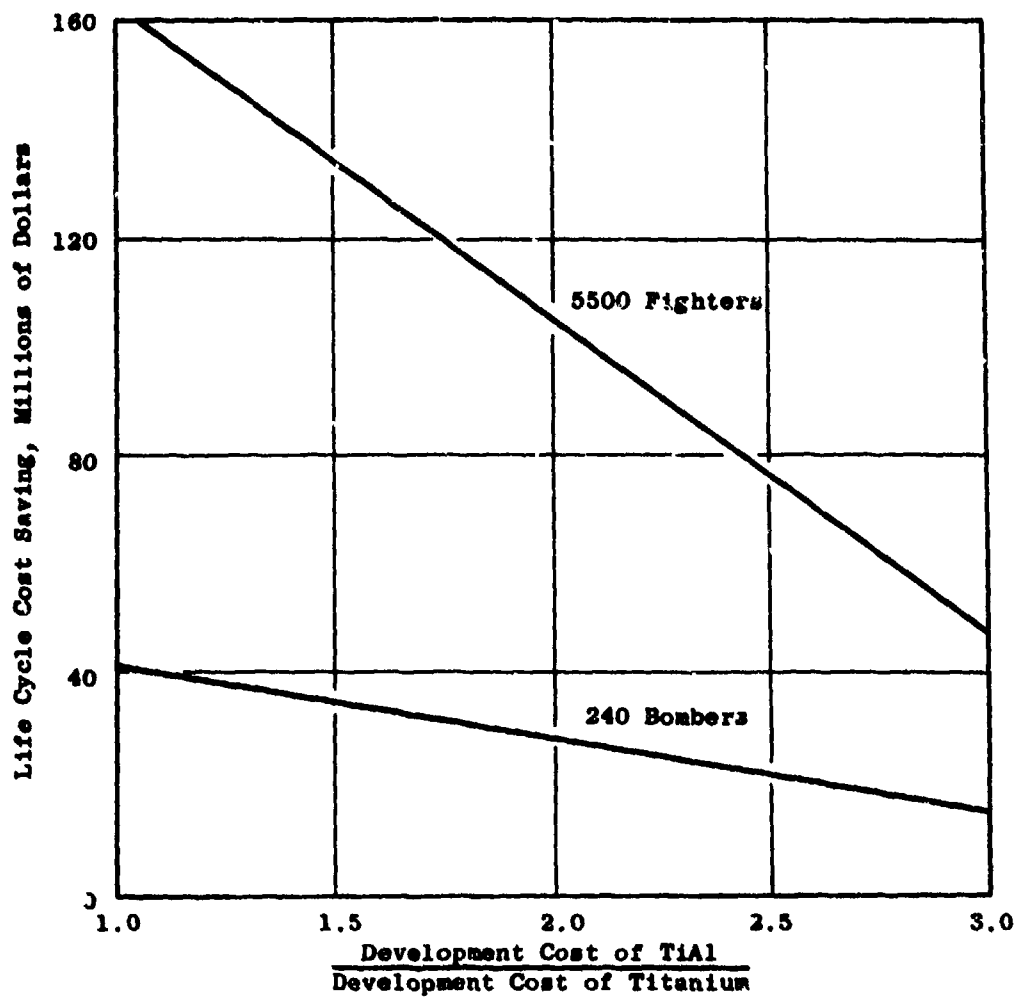

Figure 21. Effects of TiAl Alloy Development Cost on Life Cycle Cost Savings.

APPENDIX A
TITANIUM ALUMINIDE ALLOY
PROPERTY DATA

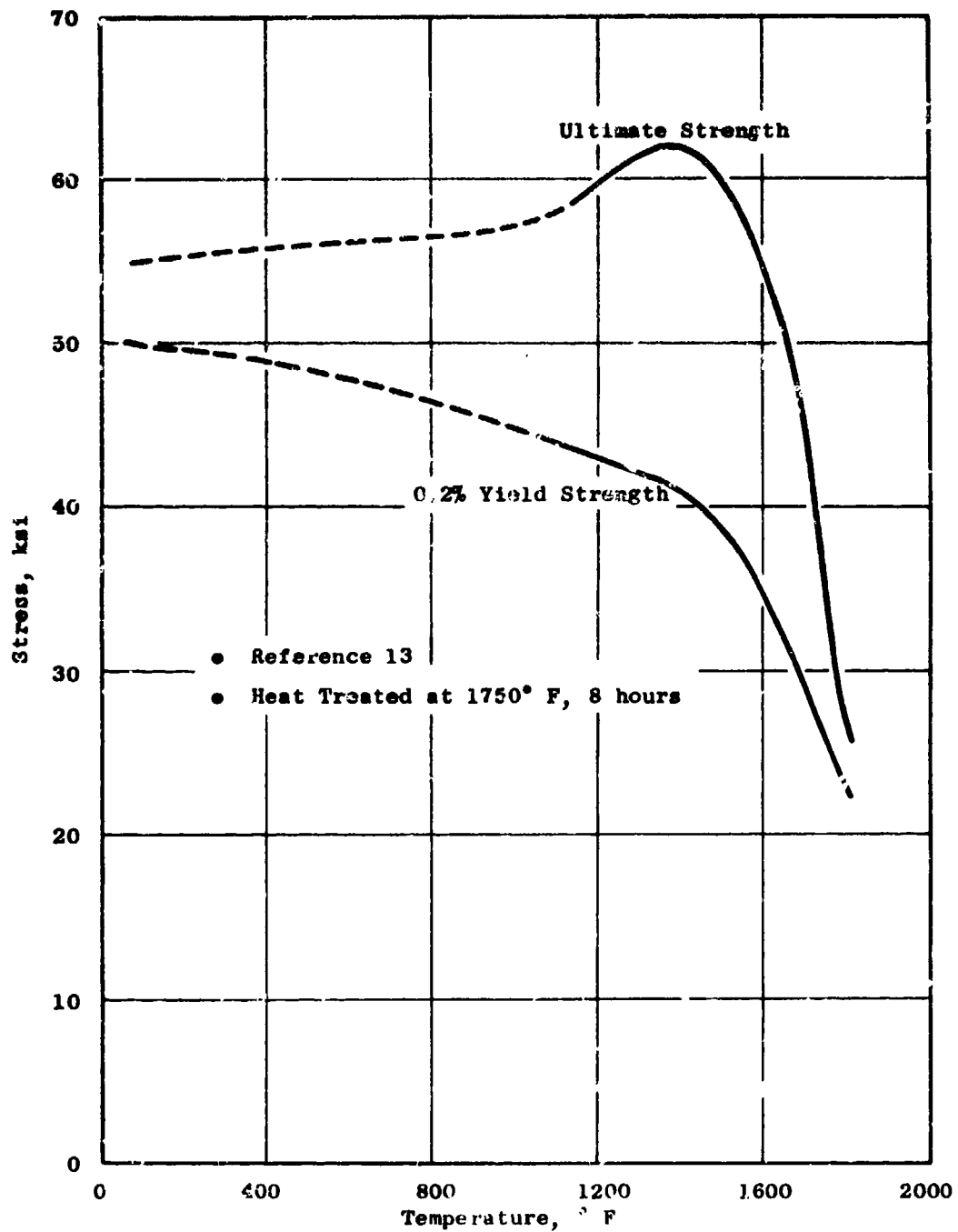

Figure A-1. Tensile Properties of Ti-36Al-5Nb.

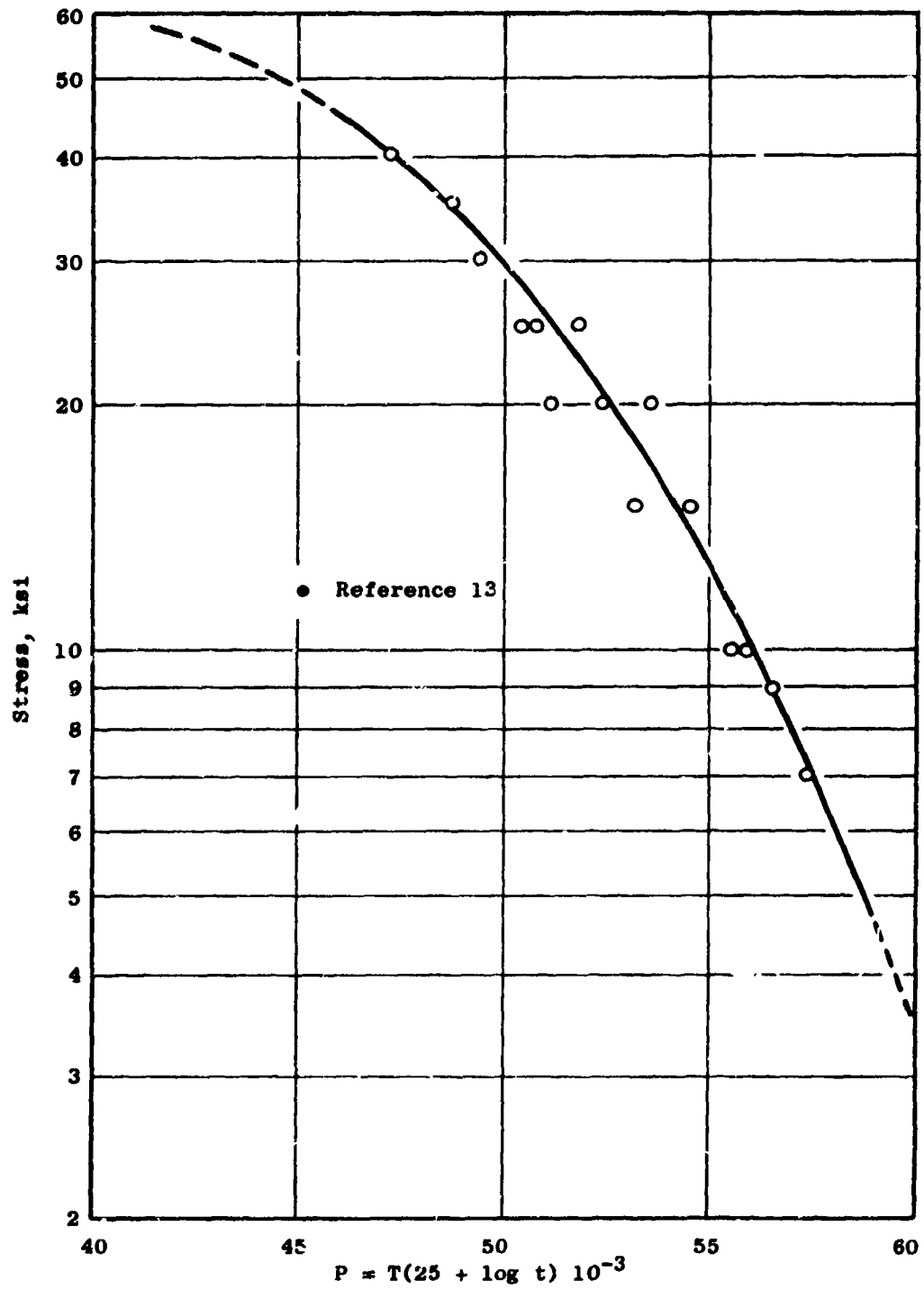

Figure A-2. T1-36A1-5Nb Stress Rupture.

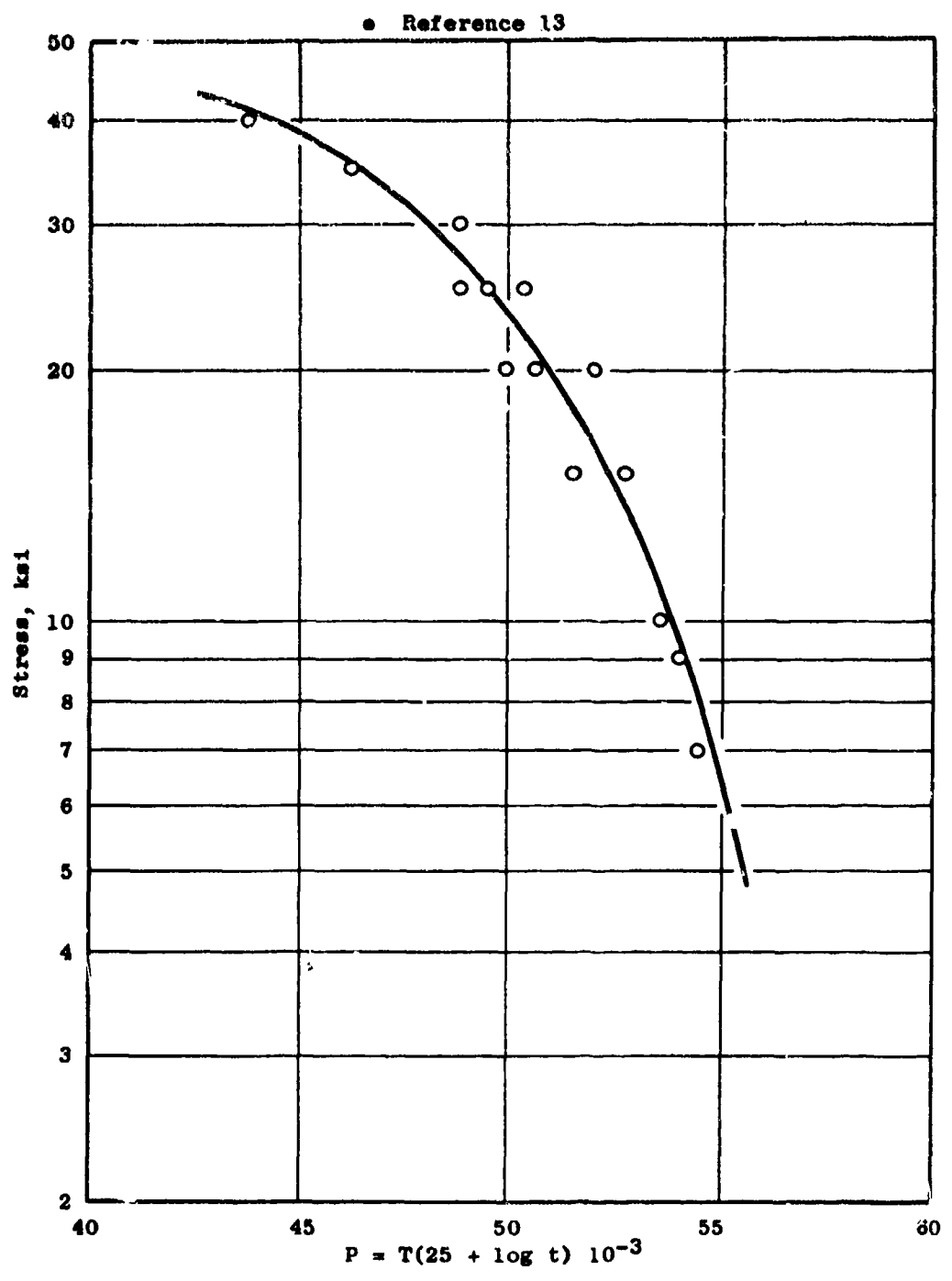

Figure A-3. Ti-36Al-5Nb 1.0% Creep.

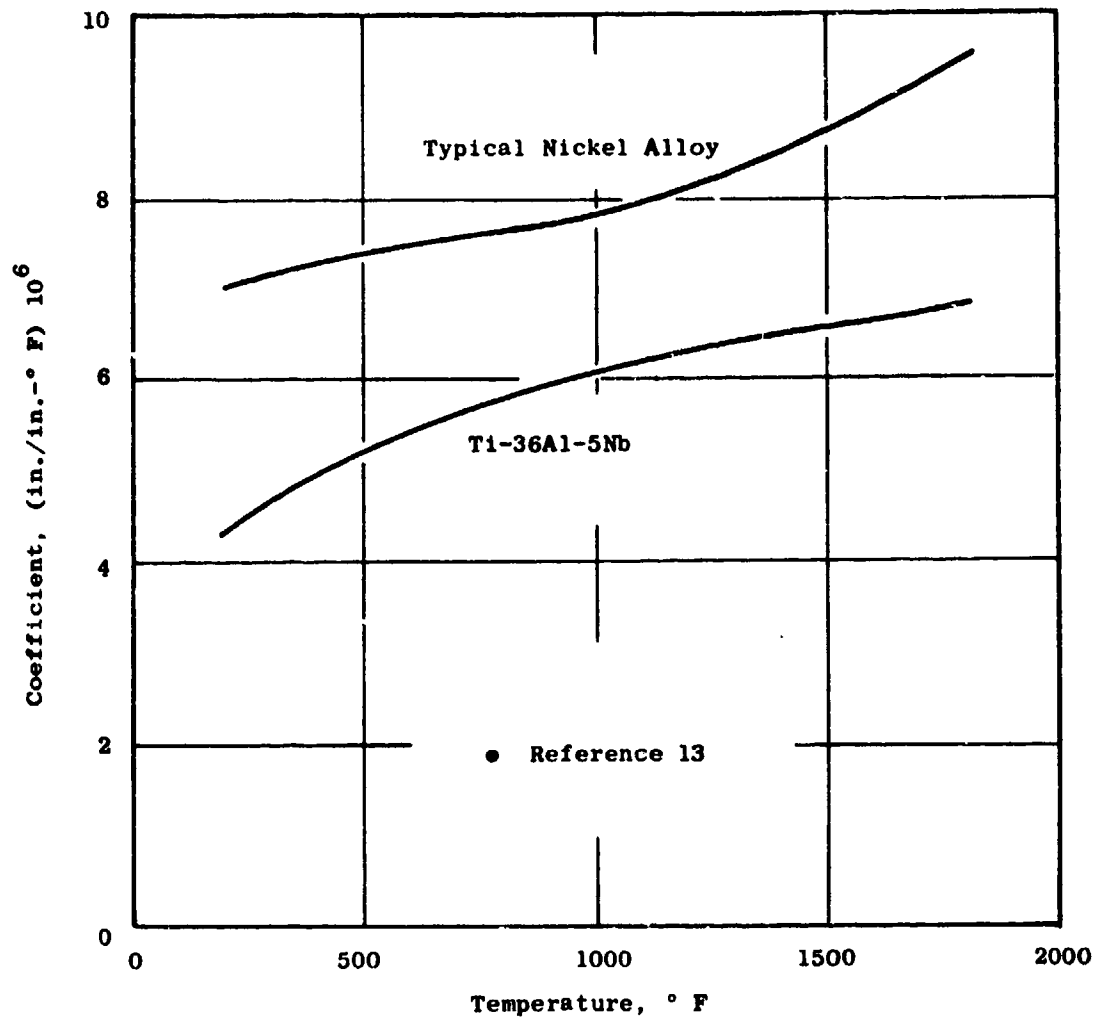

Figure A-4. Thermal Coefficient of Expansion Versus Temperature.

- Reference 13
- Controlled-Strain LCF of Ti-36Al-5Nb
- Mean Strain = 0
- Frequency = 5 cycles/min

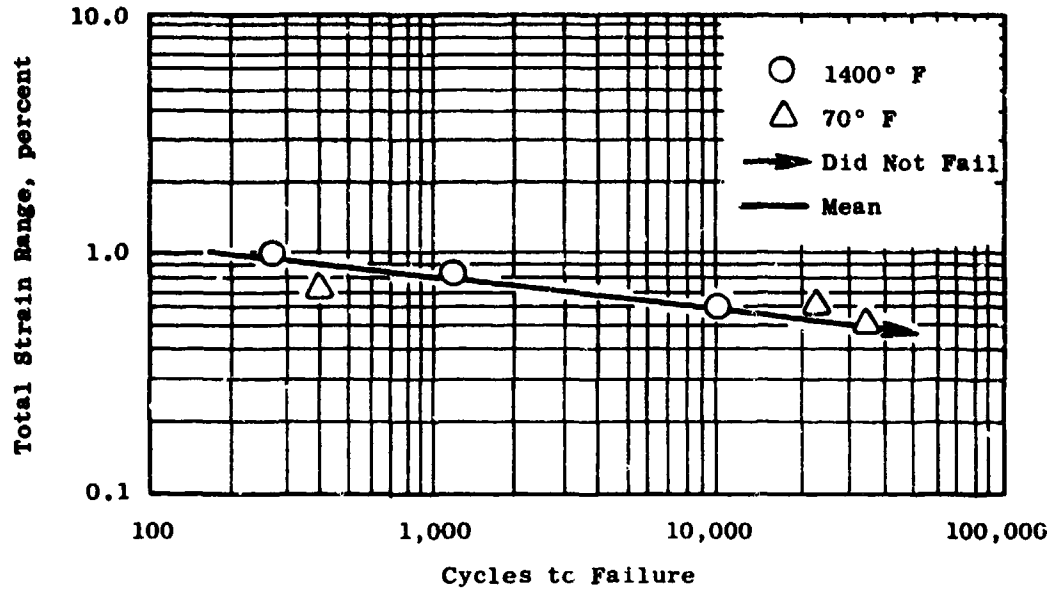

Figure A-5. LCF Life of Ti-36Al-5Nb Alloy.

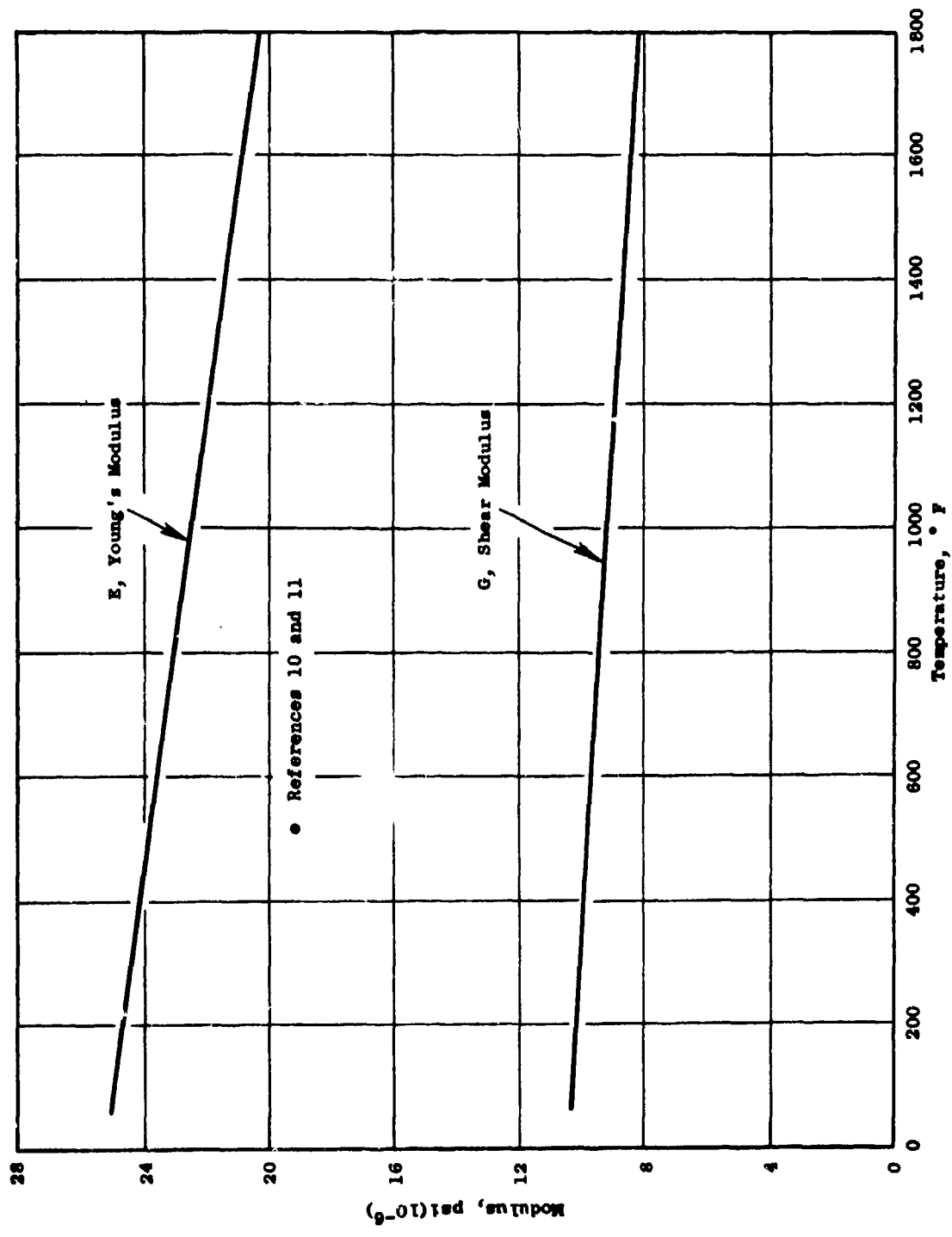

Figure A-6. Ti-36Al Elastic Modulus Data.

• References 10 and 11

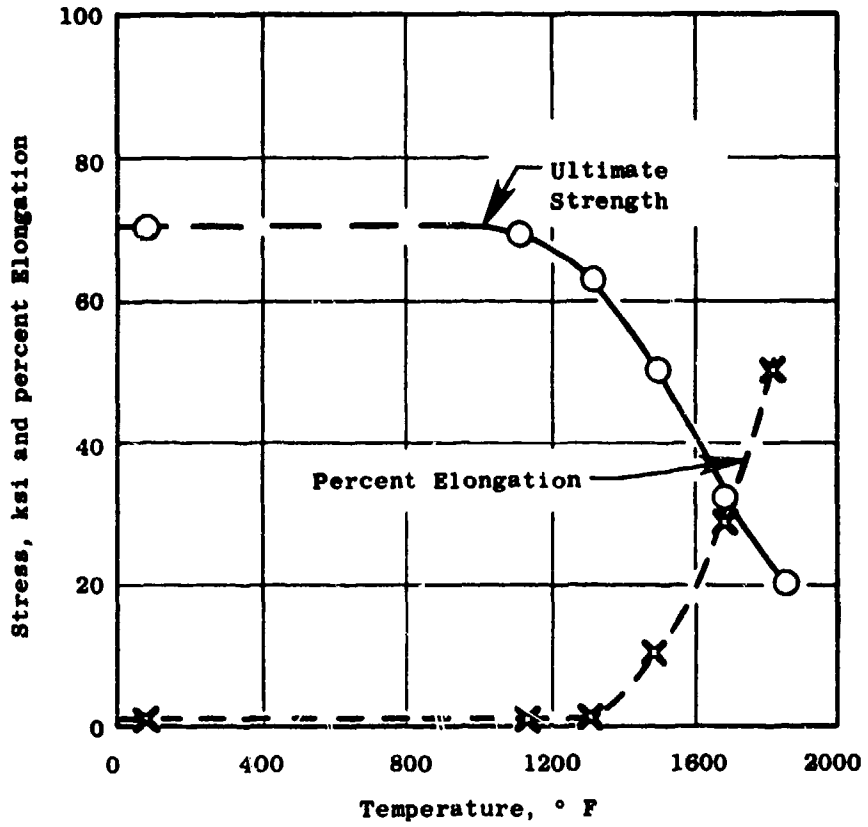

Figure A-7. Cast Ti-36Al Tensile Properties.

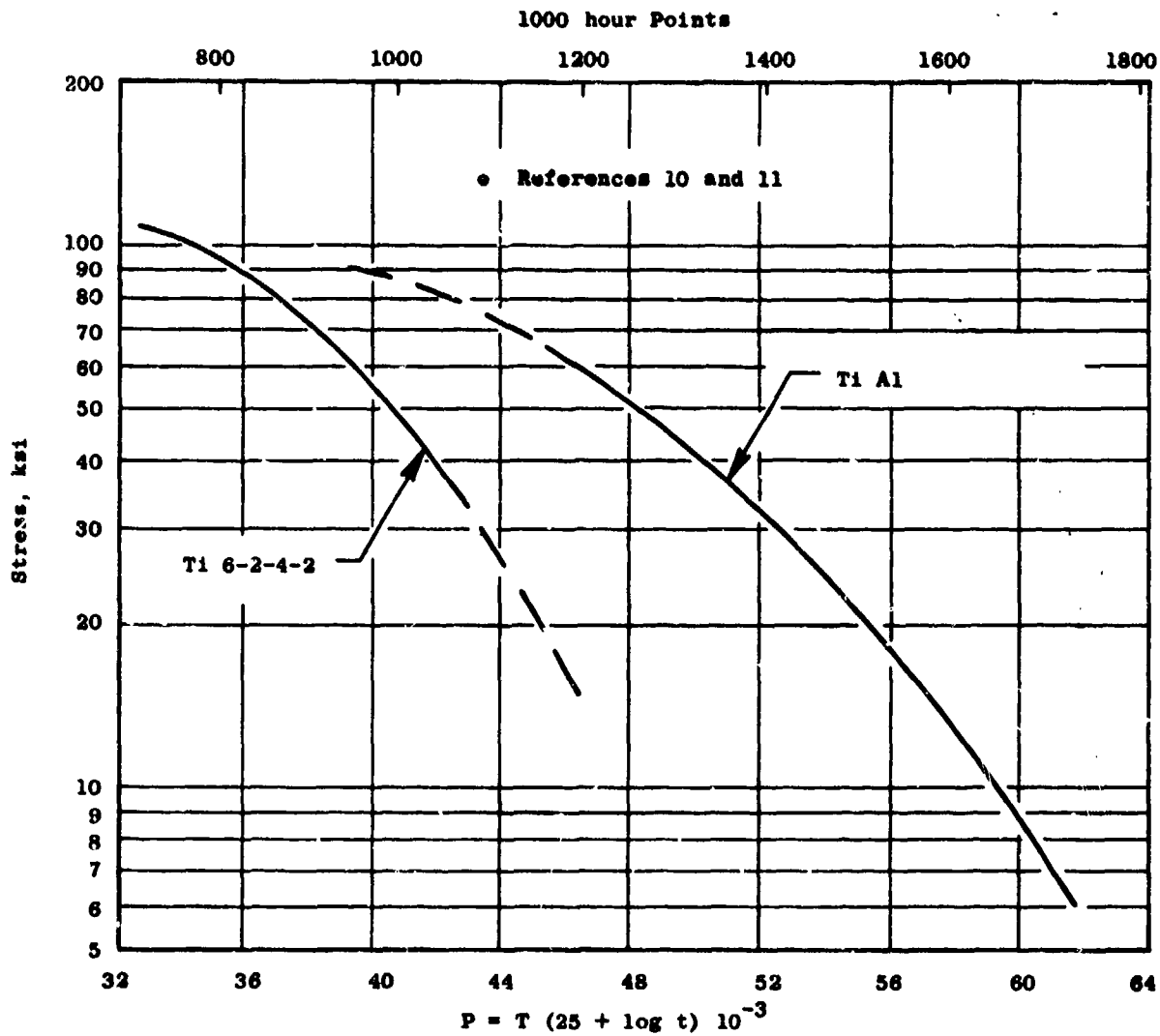

Figure A-8. Cast Ti-36Al Stress-Rupture Properties.

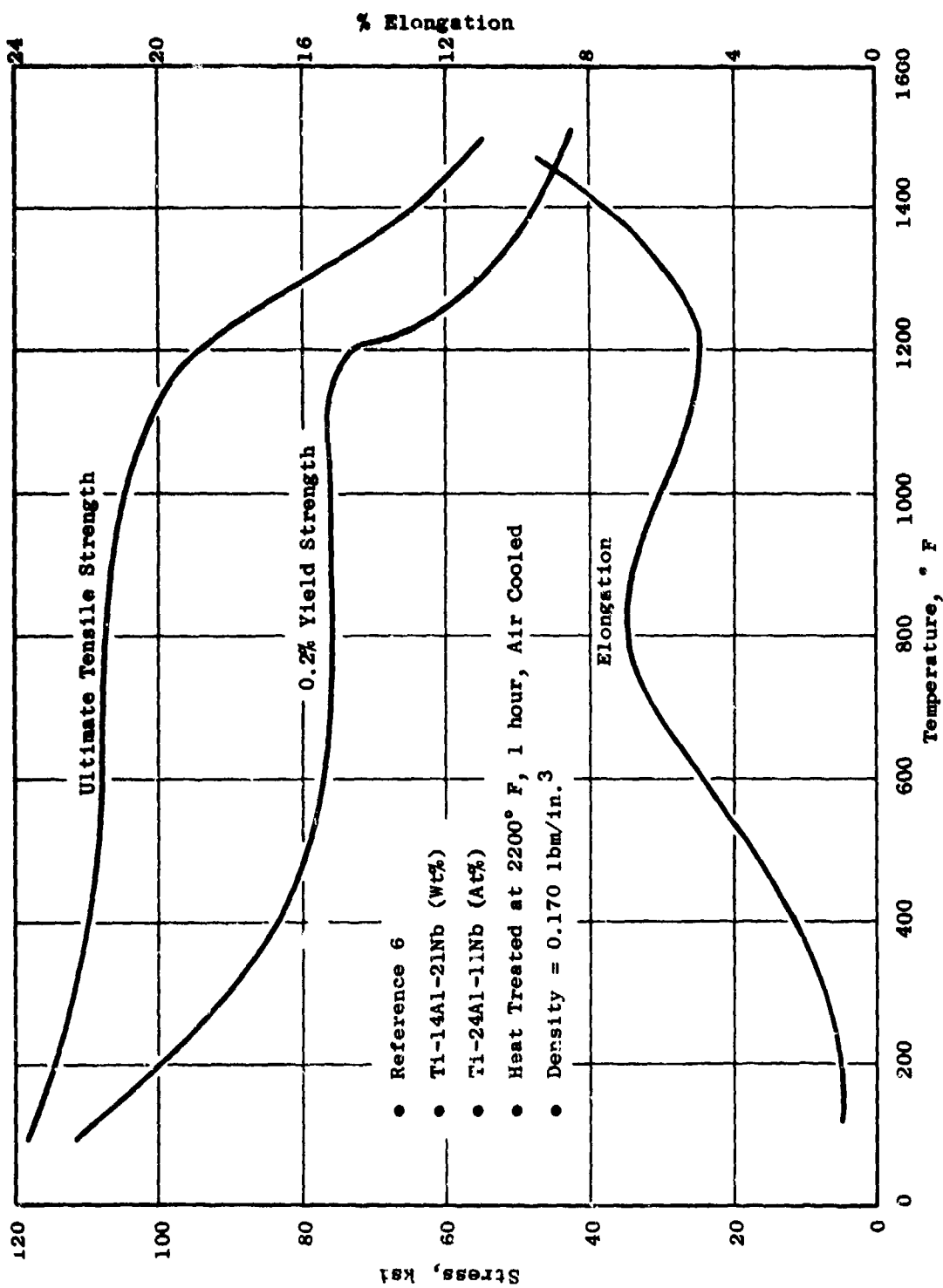

Figure A-9. Ti-14Al-21Nb (Wt%) Tensile Properties.

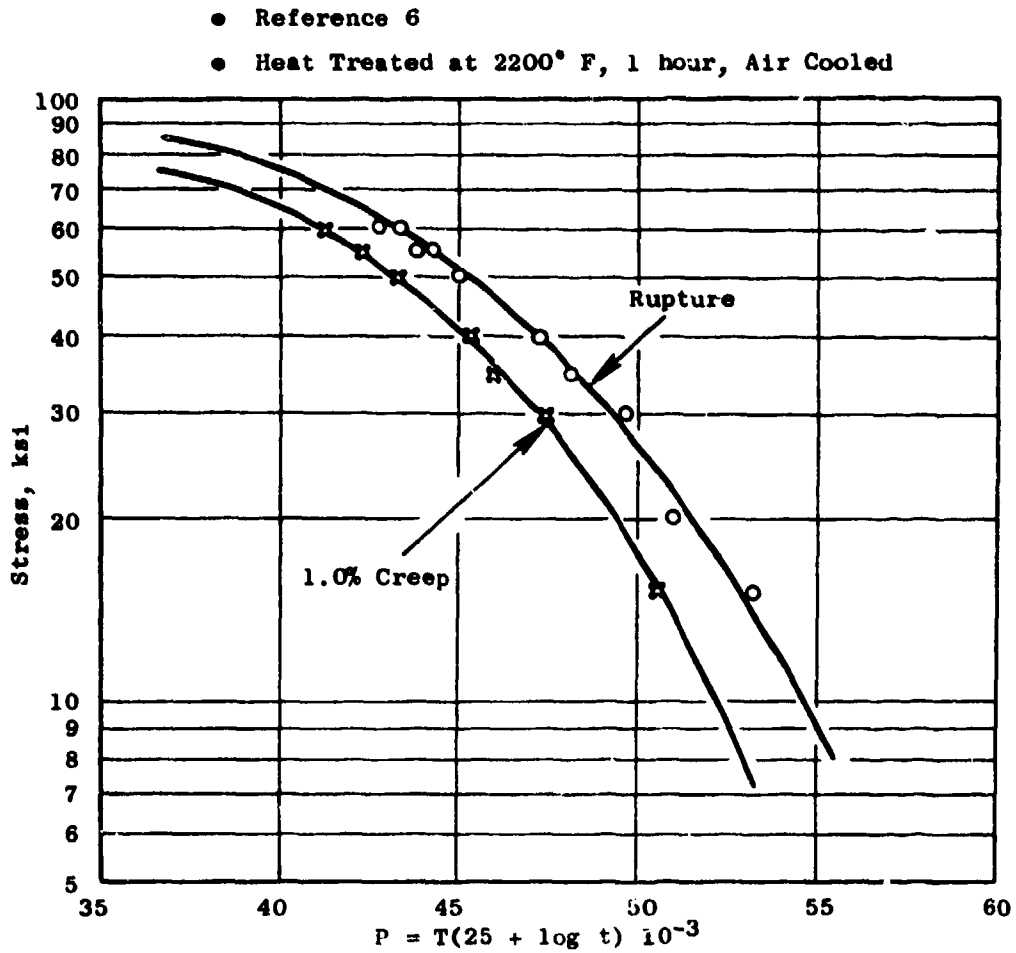

Figure A-10. Ti-14Al-21Nb Alloy (14Al-21Nb Wt%).

- Reference 6
- $K_t = 1.0$
- $A = \text{Alternating Load/Mean Load} = \infty$

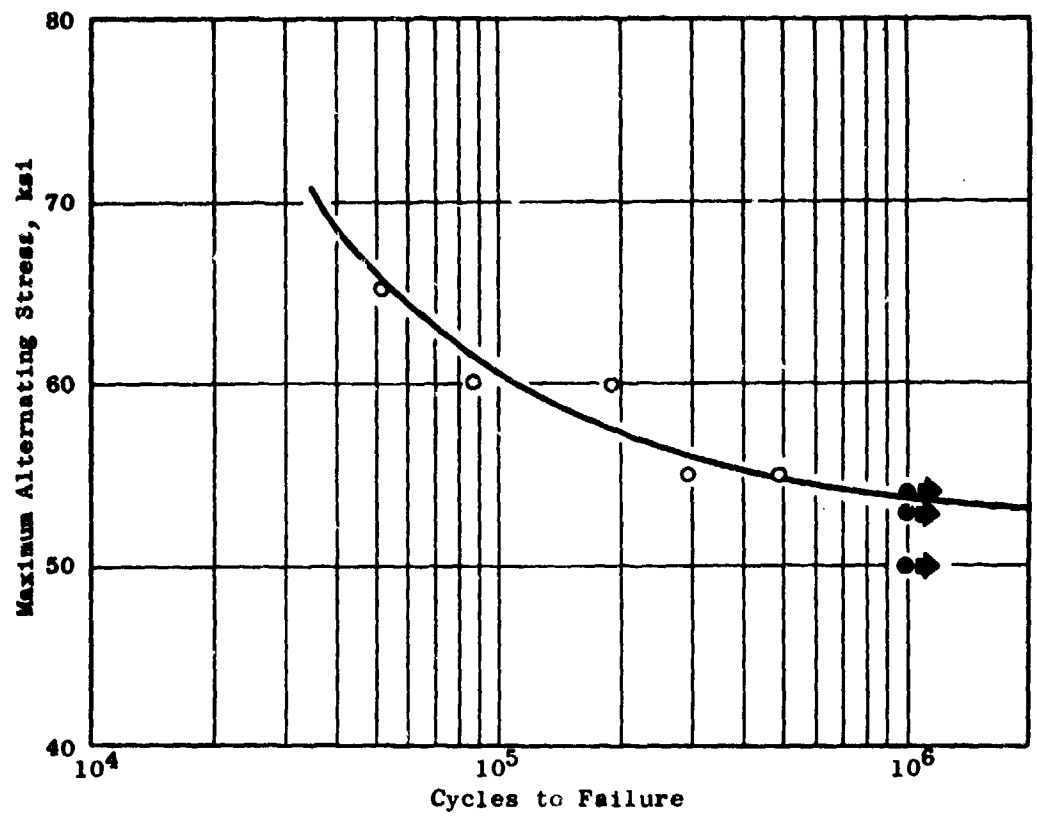

Figure A-11. Ti-14Al-21Nb High Cycle Fatigue.

• Reference 6 • $K_t = 1$, $A = 1.0$ • Strain-Controlled Test, Temperature = 1200° F

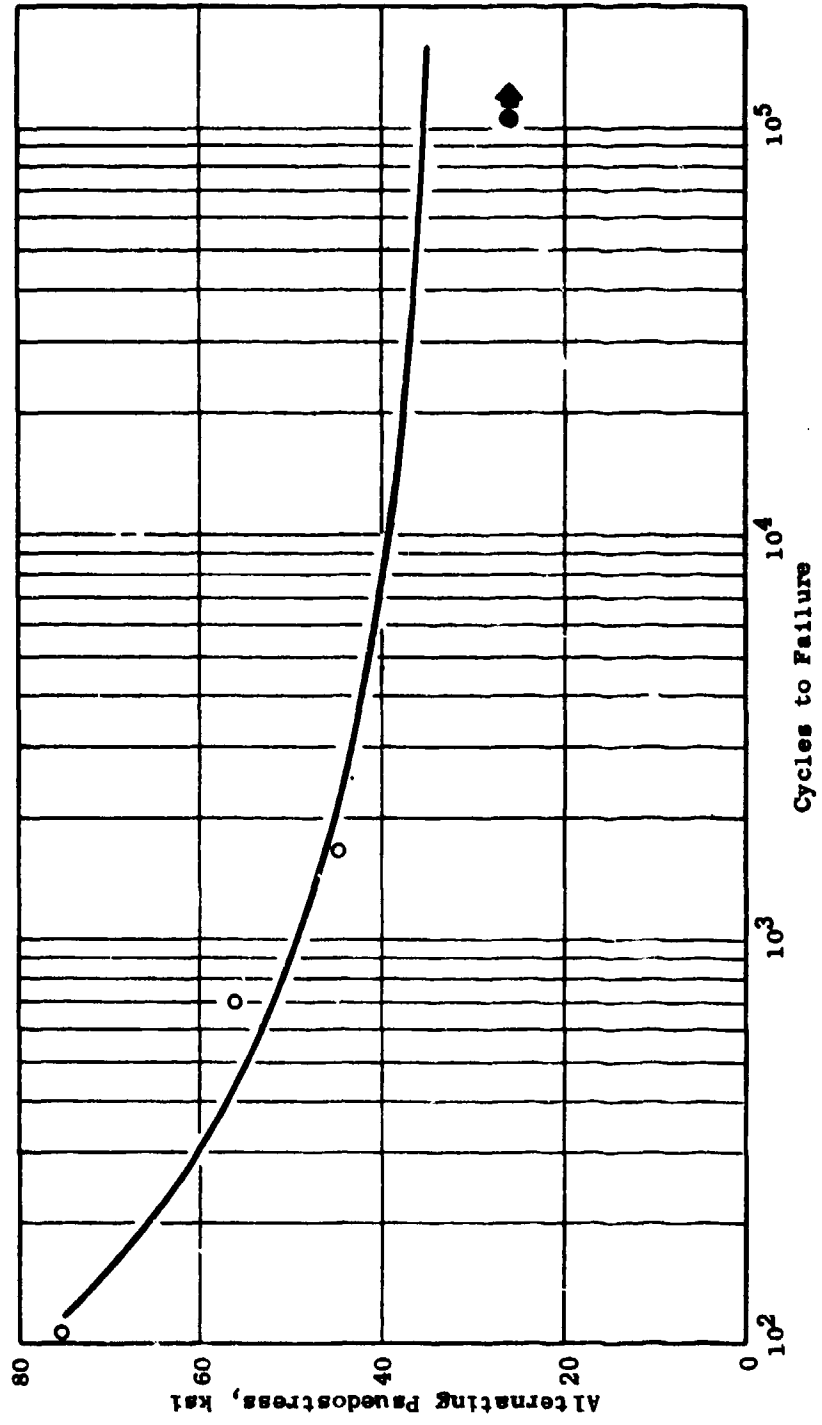

Figure A-12. Ti-16Al-10Nb Low Cycle Fatigue.

• Reference 6

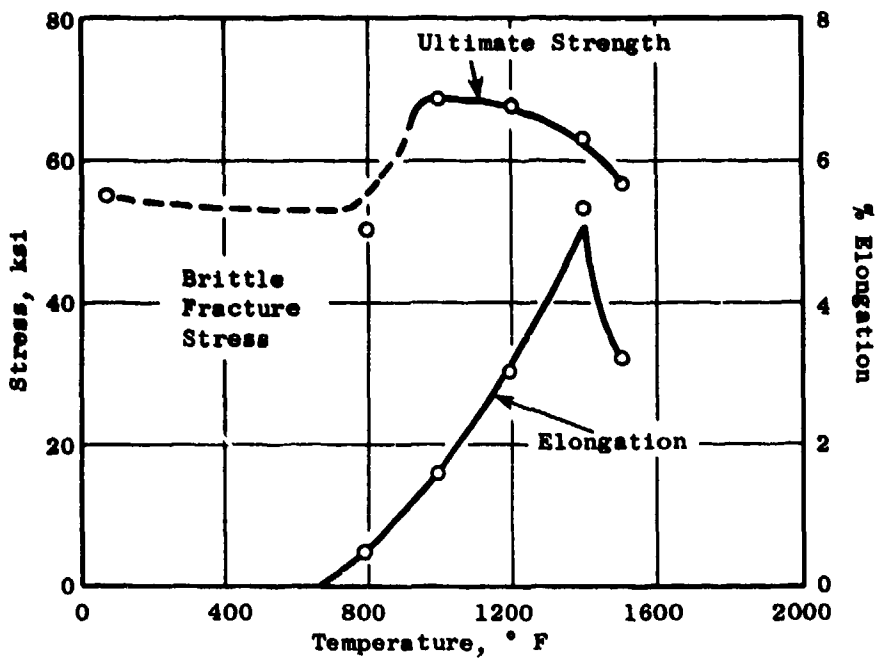

Figure A-13. Ti-16Al-10Nb Alloy Tensile Properties.

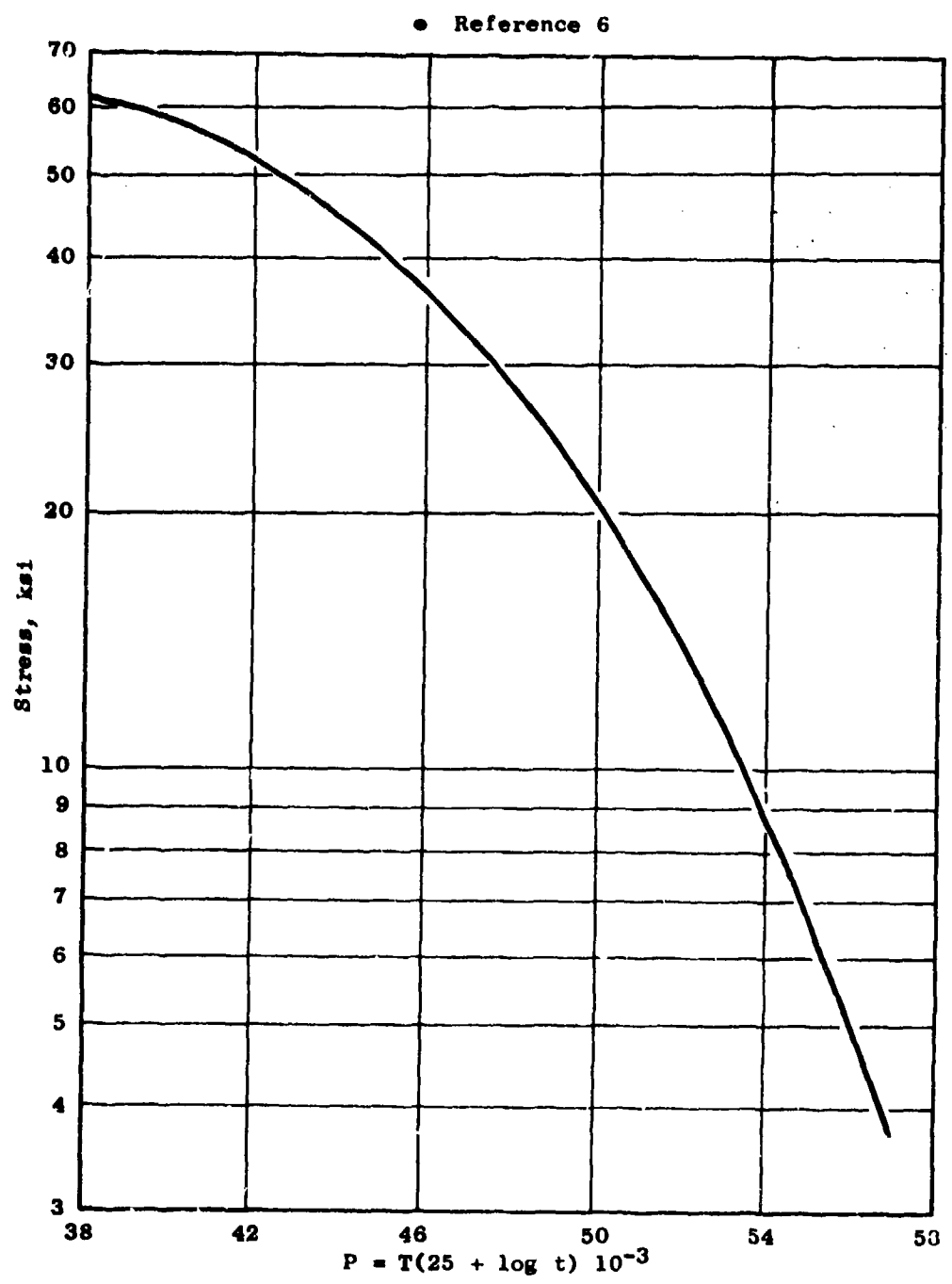

Figure A-14. Ti-16Al-10Nb 1% Creep.

• Reference 6

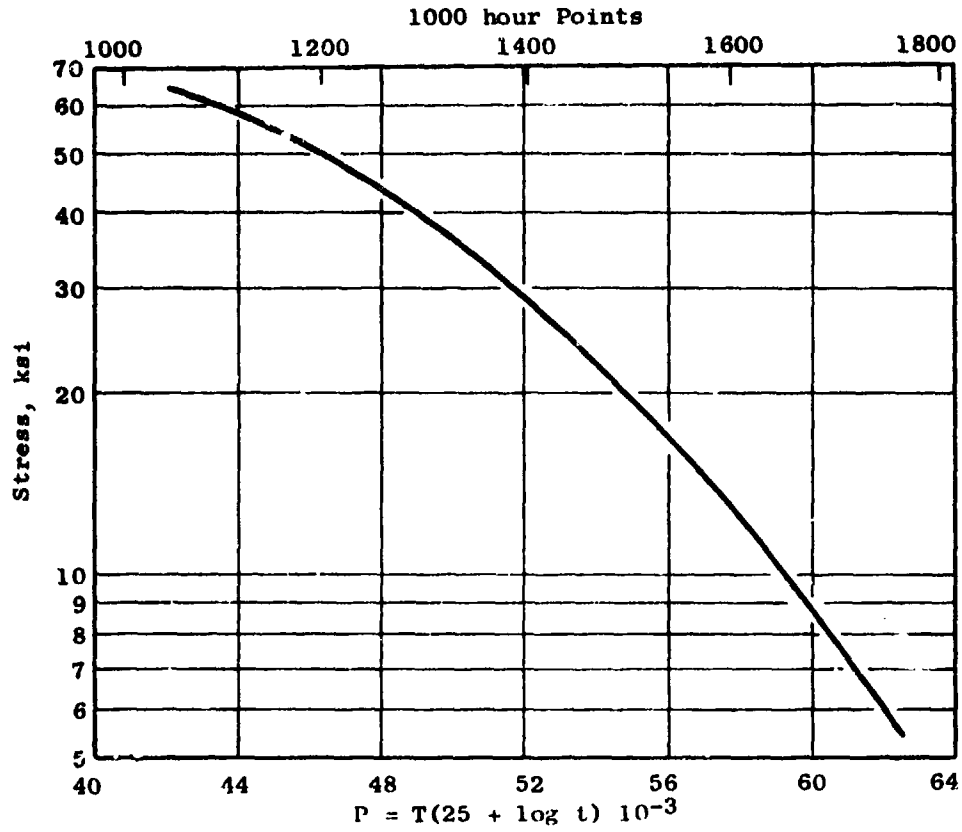

Figure A-15. Ti-16Al-10Nb Stress Rupture.

• Reference 6

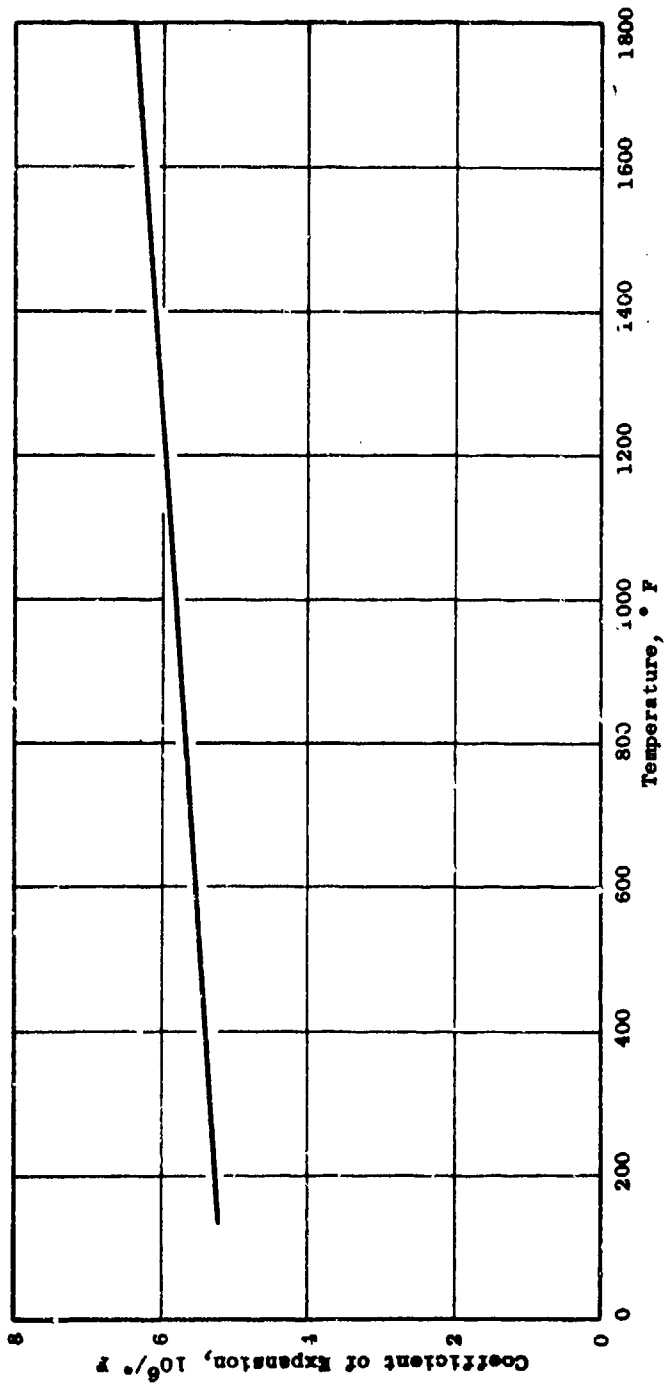

Figure 4-16. Ti-16Al-10Nb (Ti₃Al Base) Coefficient of Expansion.

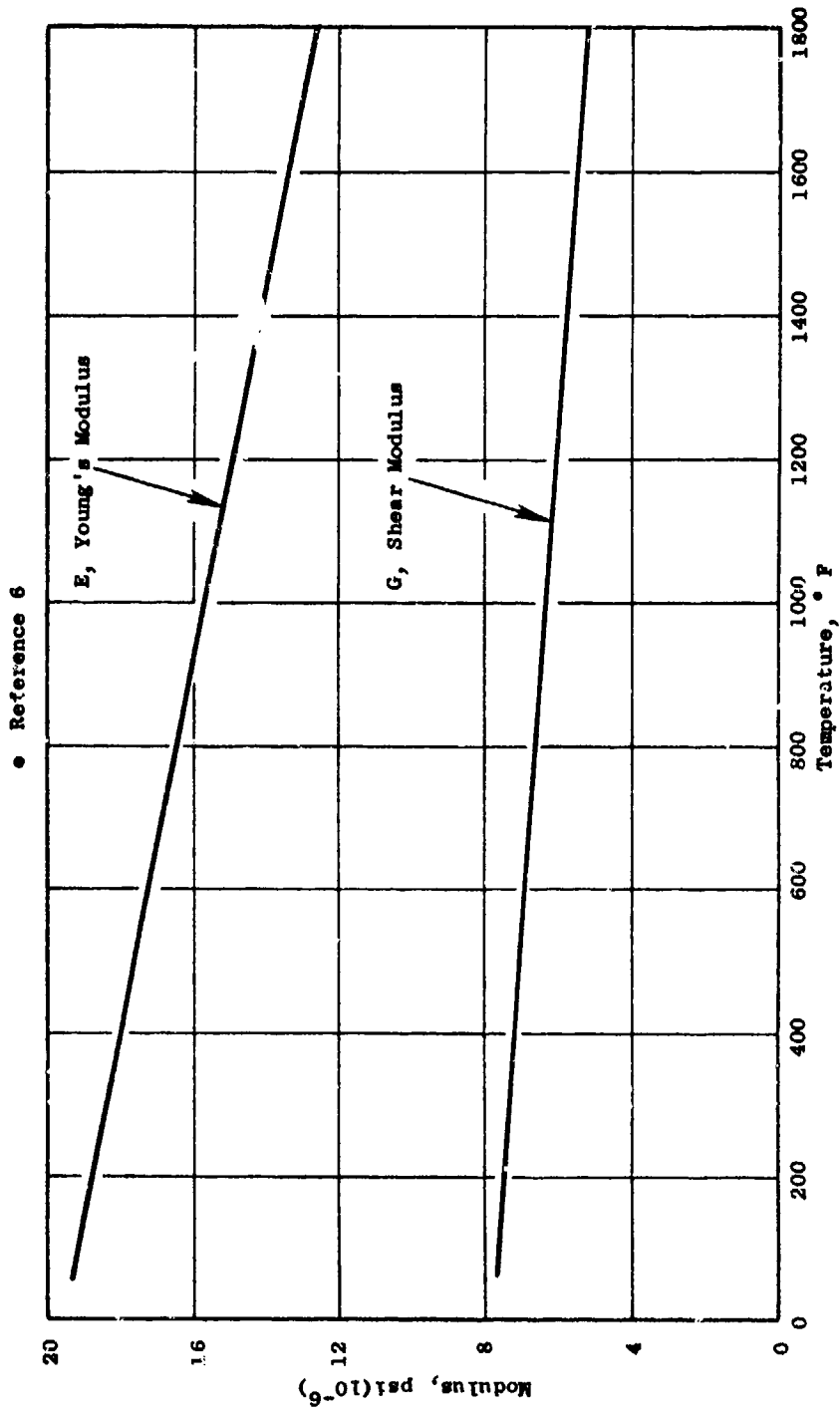

Figure A-17. Ti-16Al-10Nb Modulus Data.

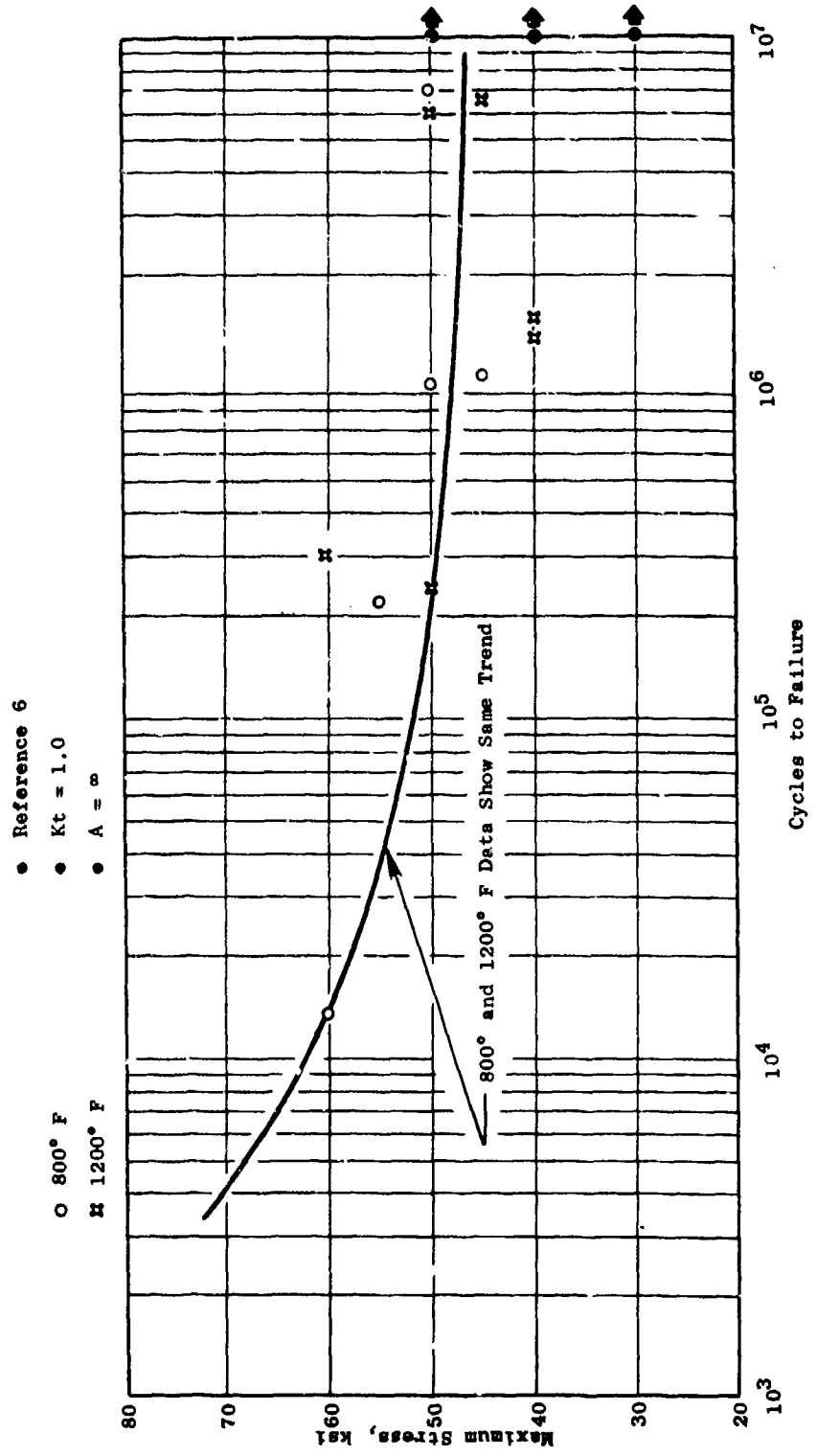

Figure A-18. Ti-16Al-10Nb (Ti3Al Base) High Cycle Fatigue Data.

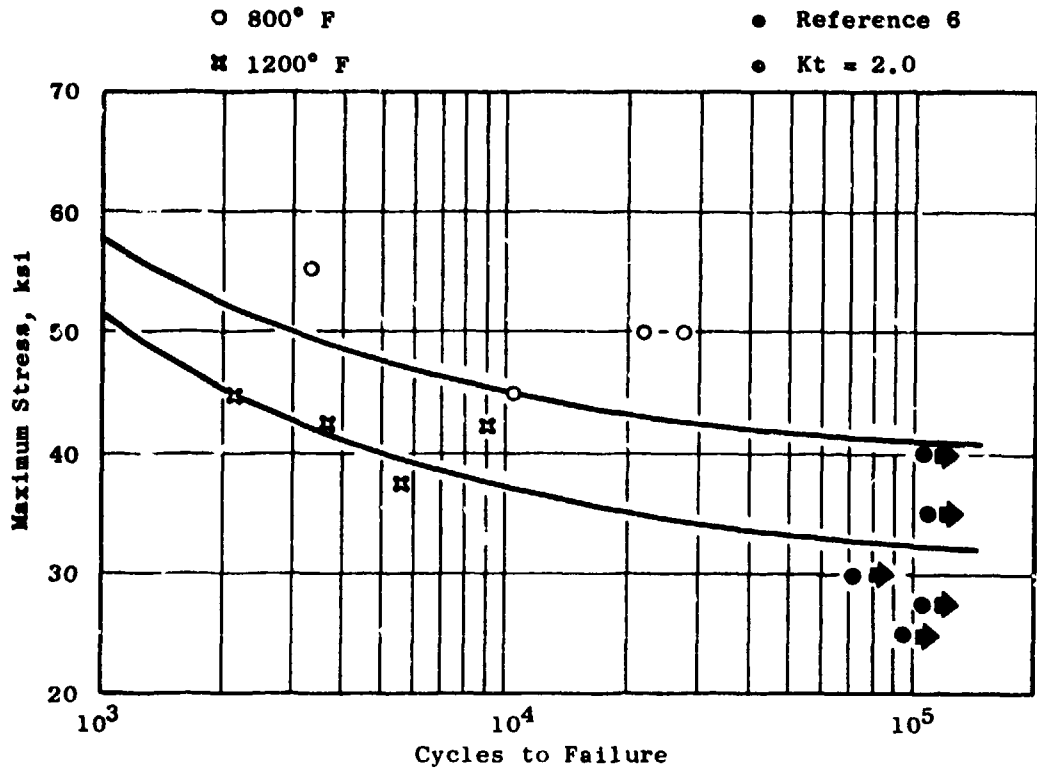

Figure A-19. Ti-16Al-10Nb (Ti₃Al Base) Notched Low Cycle Fatigue.

Table A-1. Titanium Aluminide Alloys.

Alloy	Composition			
	Weight % Alloy		Atomic % Alloy	
	Al	Nb(Cb)	Al	Nb(Cb)
<u>Ti₃Al Type</u>				
Ti-16Al-10Nb	16	10	26	4.8
Ti-14Al-21Nb	14	21	25	11
<u>TiAl Type</u>				
Ti-36Al	36	--	50	0
Ti-36Al-5Nb	36	5	50	2

Table A-2. Ti-Al Intermetallics.

Parameter	Ti ₃ Al	TiAl	Ti
Density (lbm/in. ³)	0.148	0.134	0.163
Modulus	21.0	25.5	16.0
Creep Limit	1500° F	1800° F	1000° F
Oxidation	1200° F	1800° F	1100° F
Elong. R.T.	1%	1%	10.20%

Table A-3. Ti-36Al-5Nb Tensile Properties.

• Reference 13

Temperature, °F	Forging Parameters		Heat Treatment		Grain Size ASTM	Test Temp °F	Test Results 0.2% YS, ksi	UTS ksi	El. %	RA %
	Strain Rate, in./in./min	Strain Rate, in./in./min	Anneal °F-hr	Age °F-hr						
1950	0.05	0.05	As Forged	-	9	RT	56.3	63.6	0.70	-
1950	0.05	0.05	As Forged	-	9	RT	59.2	60.9	0.30	-
1950	0.02	0.02	As Forged	-	8	RT	55.2	60.0	1.54	1.7
2000	0.05	0.05	As Forged	-	8	RT	-	35.4	0.06	-
1950	0.05	0.05	-	1750-8	8	RT	53.4	55.6	1.06	1.1
1950	0.02	0.02	-	1750-8	8	RT	50.3	54.9	1.70	2.7
2000	0.05	0.05	-	1750-8	8	RT	49.3	51.0	0.79	-
1950	0.05	0.05	2100-2	1750-8	4	RT	38.2	47.5	1.34	1.8
1950	0.05	0.05	2100-2	1750-8	4	RT	35.7	45.6	0.98	1.7
1950	0.05	0.05	2100-2	1750-8	4	RT	48.9	54.0	1.44	3.5
1950	0.05	0.05	-	1750-8	4	RT	-	36.6	0.09	-
1950	0.05	0.05	-	1750-8	9	1200	43.8	59.7	2.4	4.1
1950	0.05	0.05	2100-2	1750-8	4	1200	27.1	45.2	2.54	3.4
2000	0.05	0.05	-	1750-8	8	1400	41.0	63.2	13.6	12.3
1950	0.05	0.05	2100-2	1750-8	4	1400	34.2	48.0	1.0	5.0
2100	0.05	0.05	-	1650-72	5	1500	46.0	57.0	4.4	8.8
2100	0.05	0.05	2100-2	1650-72	4	1500	37.0	46.6	5.3	11.0
1950	0.05	0.05	-	1750-8	9	1800	22.6	25.9	80	92
1950	0.02	0.02	-	1750-8	8	1800	22.6	25.0	76	94
1950	0.05	0.05	2100-2	1750-8	4	1800	29.5	33.4	N/A	14
1950	0.02	0.02	2100-2	1750-8	4	1800	29.5	31.2	15.4	21
Isothermally Compacted Material										
1950	0.02	0.02	-	1750-8	8	RT	50.1	52.8	0.87	0.5
1950	0.02	0.02	-	1750-8	8	RT	47.9	50.2	0.70	0.5
1950	0.02	0.02	-	1750-8	8	500	42.7	46.6	1.32	2.6
1950	0.02	0.02	-	1750-8	8	500	43.5	46.9	1.13	1.7
HIP Material										
1950	0.02	0.02	-	1750-8	8	RT	44.3	46.6	0.42	-
1950	0.02	0.02	-	1750-8	8	RT	51.4	53.7	0.83	-

Table A-4. Ti-36Al-5Nb Creep and Stress Rupture Results.

• Reference 13

Test Temperature ° F	Stress (ksi)	Time for 1% Creep (hr)	Rupture Time (hr)	Elongation %	Reduction In Area %
1350	40	0.2	10.3	31.7	49.1
1350	30	50.6	152.5	26.2	54.5
1400	20	78.2	280.9	30.2	41.0
1400	25	20.0	92.5	29.7	55.0
1400	35	0.7	16.4	29.0	44.1
1435	25	12.1	47.3	26.1	43.8
1500	15	20.2	126.4	50.1	68.6
1500	20	6.7	44.5	44.0	55.4
1500	25	4.4	24.2	30.3	58.7
1600	10	11.2	105.4	71.0	78.2
1600	15	3.4	28.1	47.2	63.9
1600	20	1.8	10.2	43.2	63.8
1650	7	4.9	138.4	75.5	85.6
1650	9	4.2	47.7	85.5	81.7
1650	10	2.2	28.9	87.6	91.7

Table A-5. Ti-36Al-5Nb Strain Control LCF Results.

• Reference 13

Test Temperature ° F	Strain Range %	Cycles to Failure
1400	+ 0.5	283
1400	+ 0.4	1085
1400	+ 0.3	9838
70	+ 0.35	394
70	+ 0.3	22109
70	+ 0.25	32368*

*Did not fail.

Table A-6. HCF Results on Ti-36A1-5Nb.

- Reference 13
- All Tests at 70° F

Specimen No.	Rotating Beam Results		Remarks
	Stress (ksi)	Cycles	
3	45	1.0×10^7	Did Not Fail
Uploaded	55	2.2×10^7	Did Not Fail
Uploaded	65	2×10^6	Did Not Fail
Uploaded	75	5.2×10^6	Did Not Fail
Uploaded	85	1.7×10^6	Did Not Fail
Uploaded	100	7.6×10^6	Failed
3	100	-	Failed at Start-up
4	85	-	Failed at Start-up
5	65	1.48×10^4	Failed in Flaw
6	65	-	Failed in Flaw at Start-up
7	65	1.0×10^7	Did Not Fail
Uploaded	75	1.05×10^7	Did Not Fail
Uploaded	85	7.95×10^6	Failed
	Axial Test Results		
1	50	60	Failed in Gage
2	40	3×10^6	Did Not Fail
Uploaded	50	2×10^5	Failed in Gage

Table A-7. Tensile Results for the Ti-4Al-2Nb Alloy.

• Reference 6

Coat Treatment/ Condition degrees C(F)/hr	Test Temperature C(F), degrees	0.2% Offset Yield Strength (ksi)	Ultimate Tensile Strength (ksi)	Elongation (%)	Reduction In Area (%)
As-Forged	RT	-	78.7	-	-
As-Forged	260(500)	67.7	68.5	0.8	3.2
As-Forged	650(1200)	46.1	54.8	13.7	19.1
1200(2200)/1/FC	RT	80.8	86.8	0.58	2.3
1200(2200)/1/AC	RT	114.2	119.6	0.66	1.5
	RT	108.6	115.9	0.65	-
	200(400)	85.4	115.8	2.2	2.4
	200(400)	83.0	102.5	1.9	1.6
	260(500)	76.3	102.1	3.5	4.2
	370(700)	76.2	106.2	4.1	4.9
	425(800)	81.1	116.0	8.1	9.0
	425(800)	78.2	109.7	6.5	8.8
	540(1000)	78.5	105.0	4.7	6.6
	540(1000)	61.2	88.0	7.0	10.8
	540(1000)	72.9	100.0	5.2	6.6
	650(1200)	86.2	104.4	3.9	4.3
	650(1200)	71.2	94.1	6.0	12.7
	700(1300)	54.4	75.6	7.7	15.3
	760(1400)	47.0	63.2	9.5	15.6
	815(1500)	43.0	55.3	8.7	10.6
1200(2200)/1/AC+	RT	-	84.1	0.25	-
870(1600)/14/AC	RT	82.2	85.9	0.50	1.6
	260(500)	59.3	83.0	3.5	4.2
	650(1200)	50.0	74.2	6.0	9.2
1165(2125)/1/AC	RT	83.1	86.7	0.5	-
	260(500)	68.8	79.4	1.4	3.6
	650(1200)	48.3	67.1	8.6	10.8

Table A-8. Creep Results for the Ti-6Al-2Nb Alloy.

• Reference 6

Heat Treatment/ Condition degrees C (F)/hr	Test Temperature C (F), degrees	Stress (ksi)	Time To 1% Creep (Hours)	Time To Rupture (Hours)	Elongation (%)	Reduction In Area (%)
As-Forged	700(1300)	40	0.03	0.4	5.6	14.3
1200(2200)/1/FC	650(1200)	55	0.0	1.3	11.0	14.6
1200(2200)/1/AC	640(1000)	70		640 Running		
	540(1000)	75	To be run			
	590(1100)	60	25.26	233.9	7.0	4.1
	650(1200)	50	10.88	129.6	6.8	7.3
	650(1200)	55	2.94	44.7	14.5	4.5
	700(1300)	35	12.67	233.5	12.2	13.7
	700(1300)	40	6.95	62.8	10.0	8.8
	760(1400)	20		242.5	47.0	77.6
	760(1400)	30	3.00	44.2	20.0	23.1
	815(1500)	15	6.23	123.6	58.0	62.7
1200(2200)/1/AC+	590(1100)	60	23.55	605.9	3.6	5.7
870(1600)/1/AC	650(1200)	55	0.14	23.1	9.0	11.6

**Table A-9. High Cycle Fatigue Results
 for the Ti-14Al-21Nb Alloy.**

- Reference 6
- Test Temperature: 425° C (800° F)
- Kt = 1.0
- Cycle Rate = 7200 cpm

Stress (ksi)	Cycles to Failure
50	1.0 x 10 ⁷ Runout
53	1.0 x 10 ⁷ Runout
54	1.0 x 10 ⁷ Runout
55	2.9 x 10 ⁶
55	4.9 x 10 ⁶
60	1.9 x 10 ⁶
60	3.6 x 10 ⁵
65	5.2 x 10 ⁵

Table A-10. Thermal and Electrical Resistivity of Ti-16Al-10Nb.

- Reference 6

Temperature		Electrical Resistivity mho (10 ⁸)	Thermal Conductivity	
° C	° F		watts/meter-K	$\frac{\text{Btu-in.}}{\text{hr-ft}^2-\text{° F}}$
25	77	173	7.0	48.5
200	392	185	9.0	62.5
400	752	188	11.5	79.5
600	1112	187	14.1	97.5
800	1472	187	16.6	115.0

Table A-11. The Specific Heat of a Titanium Alloy
(Ti-16Al-10Nb).

• Reference 6

Temperature		Specific Heat	
° C	° F	J/kg-K	Btu/lbm-° F
25	77	560	0.134
200	392	610	0.146
400	752	650	0.158
600	1112	700	0.167
800	1472	740	0.177

Table A-12. Coefficient of Linear Thermal Expansion for Ti-16Al-10Nb.

Reference 6

Temperature		Thermal Expansion ($\Delta L/L_0$) 10^4	Temperature Range		Coefficient of Thermal Expansion	
$^{\circ}C$	$^{\circ}F$		$^{\circ}C$	$^{\circ}F$	Per $^{\circ}C$	Per $^{\circ}F$
20	68	-	-	-	-	-
100	212	7.6	20 - 100	68 - 212	9.5(10^{-6})	5.3(10^{-6})
200	392	17.3	20 - 200	68 - 392	9.6(10^{-6})	5.3(10^{-6})
300	572	28.0	20 - 300	68 - 572	10.1(10^{-6})	5.6(10^{-6})
400	752	38.8	20 - 400	68 - 752	10.2(10^{-6})	5.7(10^{-6})
500	932	49.9	20 - 500	68 - 932	10.4(10^{-6})	5.8(10^{-6})
600	1112	61.6	20 - 600	68 - 1112	10.6(10^{-6})	5.9(10^{-6})
700	1292	73.6	20 - 700	68 - 1292	10.8(10^{-6})	6.0(10^{-6})
800	1472	86.8	20 - 800	68 - 1472	11.1(10^{-6})	6.2(10^{-6})

Table A-13. Notched Low Cycle Fatigue Properties of Ti-16Al-10Nb.

- Reference 6
- Frequency = 10 cpm, Kt = 2.0

Test Temperature ° F	Stress ksi	Cycles to Failure
800	25.0	95,323 Discontinued
800	27.5	106,510 Discontinued
800	30.0	71,465 Discontinued and Uploaded to:
800	35.0	109,760 Discontinued and Uploaded to:
800	40.0	101,210 Discontinued and Uploaded to:
800	45.0	10,280 Failed
800	45.0	*10,000 Discontinued and Uploaded to:
800	50.0	*26,799 Failed
800	50.0	*21,269 Failed
800	55.0	*3,354 Failed
1200	25.0	104,326 Discontinued
1200	27.5	104,757 Discontinued
1200	27.5	92,213 Discontinued
1200	32.5	67,941 Discontinued and Uploaded to:
1200	37.5	5,501 Failed
1200	37.5	100,207 Discontinued and Uploaded to:
1200	42.5	*3,608 Failed
1200	42.5	*8,974 Failed
1200	40.0	*100,000 Discontinued and Uploaded to:
1200	45.0	*2,090 Failed

*New data

Table A-14. Notched Stress Rupture Properties for Ti-16Al-10Nb.

- Reference 6
- $K_t = 3.8$

Test Temperature ° F	Stress ksi	Time to Failure hr	Time to Failure for Smooth Specimen (Equivalent Condition) hr
1100	60		163.7 Running
1200	50	246.2	379.6
1200	10	24.3 Uploaded	
1200	20	23.7 Uploaded	
1200	30	23.9 Uploaded	
1200	40	24.0 Uploaded	
1200	50	73.7 Uploaded	379.6
1200	60	22.5 Uploaded	
1200	70	2.0 Rupture	8.0 (From Larson Miller Curve)
1300	45	522.3	84.2
1400	30	1200*	335.1
1500	10	336.8 Uploaded	306.3 Discontinued
1500	30	144.7	54.9
1500	15	1670*	1654.8
1500	5.0	505.4 Uploaded	
1600	10	1250*	(1575 From Larson Miller Curve)

*No failure in indicated time.

Table A-15. Tensile Properties for Ti-16Al-10Nb.

• Reference 6

Heat Treatment	Test Temperature ° F	0.2% Yield Strength ksi	Ultimate Strength ksi	Elongation %	Reduction in Area %
2200° F, 1 hr, Air Cooled	RT	--	58.2	--	--
1650° F, 8 hr, Air Cooled	RT	--	53.9	0.05	--
**1650° F, 4 hr, Vacuum	RT	--	34.0	--	--
1650° F, 8 hr, Air Cooled	800	--	47.1	--	--
↓	800	--	49.6	0.15	--
**1650° F, 4 hr, Vacuum	800	48.4	58.9	0.58	*2.4
1650° F, 8 hr, Air Cooled	800	47.0	50.0	0.4	--
↓	1000	51.6	68.4	1.6	3.8
↓	1000	45.2	60.5	1.3	*2.0
↓	1200	44.5	66.5	3.1	4.2
↓	1200	44.1	70.4	3.8	*9.6
↓	1400	43.0	62.0	5.2	9.0
↓	1400	41.2	58.8	5.5	*9.1
↓	1500	43.8	55.9	3.1	5.3
↓	1500	39.8	53.4	3.7	*7.4
↓	1500	39.3	51.6	5.2	*9.0
2200° F, 1 hr, Air Cooled	800	--	83.6	--	--
2050° F, 1 hr, Air Cooled	800	47.9	63.8	0.90	--

* New Data

** Specimens Stress Relieved

Table A-16. Charpy Impact Toughness of Ti-16Al-10Nb.

● Reference 6

Test Temperature ° F	Charpy Impact Toughness ft - lb
RT	1.03
RT	1.03
RT*	0.69
400*	1.32
800	2.1
800	1.7
800*	1.7
1200	4.9
1400*	9.7**
1500*	8.8
1600*	8.4**

*Specimens stress relieved: 1650° F, 4 hr, Vacuum

**New Data

Table A-17. High Cycle Fatigue Data for Ti-16Al-10Nb (r = 1).

- Reference 6
- Frequency = 1800 cpm

Test Temperature ° F	Kt	Stress ksi	Cycles to Failure
800	1.0	30.0	1.0×10^7 Discontinued and Uploaded
800	1.0	40.0	1.0×10^7 Discontinued and Uploaded
800	1.0	50.0	1.0×10^7 Discontinued and Uploaded
800	1.0	60.0	1.5×10^6
800	1.0	30.0	* 1.0×10^7 Discontinued
800	1.0	40.0	1.0×10^7 Discontinued
800	1.0	45.0	1.0×10^6 Potential Crack
800	1.0	50.0	7.0×10^6
800	1.0	50.0	9.5×10^5
800	1.0	55.0	2.2×10^5
800	1.0	60.0	1.3×10^5
1200	1.0	40.0	1.3×10^6 Potential Crack
1200	1.0	40.0	1.5×10^5 Potential Crack
1200	1.0	45.0	6.5×10^6
1200	1.0	50.0	6.0×10^6
1200	1.0	55.0	2.2×10^5
1200	1.0	60.0	3.0×10^5
1200	1.0	60.0	* 8.6×10^5
800	3.8	15.0	1.0×10^7 Discontinued
800	3.8	20.0	1.0×10^7 Discontinued
800	3.8	25.0	1.0×10^7 Discontinued
800	3.8	30.0	1.0×10^7 Discontinued
1200	3.8	10.0	1.0×10^7 Discontinued
1200	3.8	15.0	1.0×10^7 Discontinued
1200	3.8	20.0	1.7×10^5 Potential Crack

*New Data

APPENDIX B
COMPARATIVE MANUFACTURING COST DATA
FOR TITANIUM ALUMINIDE COMPONENTS

**Table B-1. Low Pressure Turbine Blade Cast,
 Cored, Radial Holes.**

	<u>René 80</u>	<u>Ti/Al</u>
Processing Cost		
Material	\$ 3.10	\$ 3.06
Core Cost	10.00	25.00
Casting Labor & O/H	26.33	51.80
Other Material	1.75	2.00
Reject Castings	7.75	41.39
Vendor G&A + Profit	<u>17.13</u>	<u>45.29</u>
Casting Selling Price	\$ 66.06	\$174.65
Casting Cost	\$ 66.06	\$174.65
Other Charges	14.62	22.21
Shop Labor	<u>23.55</u>	<u>38.50</u>
	\$104.23	\$235.36

**Table B-2. J101 LP Turbine Blade; Diffusion-Bonded,
 Isothermal-Forged Halves.**

Material Cost	\$ 15.00
Forging Cost (Preform and Final Form)	37.00
Cutoff	
Deburr	
Coat	
Heat	
Form	
Descale	
Polish	
Etch	
Chem-mill	
Inspect	
Prebond Machining	30.00
Cavities	
Mating Surfaces	
Inspect	
Bonding	60.00
Assembly	
Diffusion Bond	
Ultrasonic Inspect	
Finish Machine	38.00
Dovetail	
Tip	
Leading Edge and Trailing Edge	
Final Inspect	
Total	\$180.00

Table B-3. F101 Stage 4 Compressor Blade Detailed Operation Plan.

Process Operations	Labor Hours		
	Ti/Al	Inco 718	
Cutoff	0.005	0.005	
Deburr	0.002	0.002	
Coat	0.002	N/R	
Heat and Preform	0.08	↓	
Descale	0.002		
Polish	0.01		
Etch	0.00		
Coat	0.00		
Heat and Final Form	0.08		
Pinch and Roll	N/R		0.25
Descale	0.002		0.002
Polish	0.01		0.01
Etch	0.002		0.002
Chem-mill	0.14	N/R	
Rough Machine Dovetail	0.05	0.07	
Finish Machine Dovetail	0.05	0.07	
Trim Leading Edge, Trailing Edge, and Tip	0.02	0.03	
Roll Leading Edge, and Trailing Edge	0.05	0.05	
Inspect	0.07	0.07	
Tip Grind	0.02	0.02	
Inspect	0.10	0.10	

Table B-4. F101 Mixer Detailed Operation Plan.

Process Operation	Inco 718	Ti3Al
Form Lobes	\$1717	\$2620
Blank		
Form	} Times 56 pcs.	
Trim		
Weld Prep		
Setup		
Variance		
Scrap and Rework		
Weld	\$ 915	\$1235
Weld Variance		
Scrap and Rework		
Chem-mill	\$2390	\$2690
Clean	} Times 56 pcs.	
Mask		
Mark		
Peel		
Mill		
Variance		
Scrap and Rework		
Fabricate Center Section	\$ 320	\$ 670
Material		
Fabricate and Weld		
Castings	\$ 980	\$1428
Machine	Times 28 pcs.	
Finish Machine	\$ 400	\$ 400

Table B-5. F101 Exhaust Duct Liner Detailed Operation Plan.

Process Operation	Inco 625	Ti3Al
Form Liner	\$ 825	\$1015
Blank		
Form		
Trim		
Weld Prep		
Variance		
Scrap		
Setup		
Weld	\$ 617	\$ 840
Variance		
Scrap and Rework		
Chem-mill	\$ 980	\$1100
Clean		
Mask		
Mark		
Peel		
Mill		
Variance		
Scrap and Rework		
Fabricate Hangers	\$ 600	\$ 900
Drill 7500 Holes	1050	1350
Finish Assemble	1000	1000

APPENDIX C - LIFE CYCLE COST ANALYSIS

BASELINE SYSTEM WEIGHT SUMMARY AND NOMENCLATURE

T, Design Maximum Ramp Weight	395,000 lbm
L, Weapon Load	50,000 lbm
FEQ, Fixed Equipment Weight	25,000 lbm
S, Structure Weight	120,000 lbm
F, Fuel Inventory Weight	184,000 lbm
E, Engine (4) Weight	16,000 lbm
FN, Thrust	30,000 lbf
WA, Engine Flow Rate	350 lbm/sec

ENGINE WEIGHT-SCALING PROCEDURE

The design ramp weight of an aircraft can be calculated from

$$T = L + FEQ + S + F + E \quad (1)$$

For similar engine designs, the engine weight, E, is a function of the engine airflow to the 1.2 power or

$$E = WA^{1.2} \quad (2)$$

Substituting (2) into (1) we have the following equation for estimating the design ramp weight as a function of engine flow rate.

$$T = L + FEQ + S + F + WA^{1.2} (E/WA^{1.2})_{Ref} \quad (3)$$

Rearranging (3), we have

$$T[1 - (S/T) - F/T] = L + FEQ + WA^{1.2} (E/WA^{1.2})_{Ref} \quad (4)$$

Equation 4 can be further rearranged by dividing both sides by WA and introducing the engine thrust, FN, into the equation to obtain

$$\begin{aligned} (T/FN) (FN/WA)[1 - (S/T) - F/T] &= [(L + FEQ)/WA] \\ + WA^{0.2} (E/WA^{1.2})_{Ref} & \quad (5) \end{aligned}$$

In a family of similar aircraft, with the same performance carrying the same load and fixed equipment, the left-hand side of (5) is a constant because the

weight to thrust ratio (T/FN), the thrust per pound of flow ratio (FN/WA), the ratio of the structure to the aircraft system weight (S/T), and the fuel weight to total system weight (F/T) are all constant.

Substituting the known values in the right-hand side of the equation and using WA = 1,400 lbm/sec, we can evaluate the right-hand constant

$$\begin{aligned} \text{Constant} &= [(L + FEQ)/WA] + WA^{0.2} (E/WA^{1.2})_{\text{Ref}} \\ &= [(50,000 + 25,000)/1,400] + 1,400^{0.2} (16,000/1,400^{1.2}) \\ &= 65 \end{aligned} \tag{5}$$

$$[(L + FEQ)/WA] + WA^{0.2} (E/WA^{1.2})_{\text{Ref}} = 65 \tag{6}$$

Substituting the new engine weight with titanium aluminide components in (6), we can calculate the new engine flow rate of 1,393 lbm/sec.

Inspection of (6) shows that the design maximum ramp weight is proportional to the engine flow rate or

$$T/T_{\text{Ref}} = WA/WA_{\text{Ref}} \tag{7}$$

Substituting the known values in (7) we find the new ramp weight of 393,000 lbm, or 1,975 lbm less than the baseline engine.

$$\begin{aligned} T &= T_{\text{Ref}} WA/WA_{\text{Ref}} \\ T &= 395,000 (1,393)/1,400 = 393,025 \text{ lbm} \end{aligned} \tag{8}$$

$$T = 395,000 - 393,025 = 1,975 \text{ lbm weight reduction}$$

Since the structure function (S/T) is also a constant, the new structure weight can be obtained from:

$$\begin{aligned} S &= T(S/T)_{\text{Ref}} \\ S &= 393,025 (120,000)/395,000 = 119,400 \text{ lbm} \end{aligned} \tag{9}$$

$$S = 120,000 - 119,400 = 600 \text{ lbm weight reduction}$$

The new fuel weight can be estimated from a similar relationship

$$F = T(F/T)_{Ref}$$

$$F = 393,025 (184,000)/395,000 = 183,080 \text{ lbm} \quad (10)$$

$$\Delta F = 184,000 - 183,000 = 920 \text{ lbm weight reduction}$$

LIFE CYCLE COST

Structural Cost Estimate - The cost of the basic aircraft system without avionics, engines, or other fixed equipment is \$30.88 million.

$$\text{The cost per pound of structure} = 30,800,000/120,000 = \$257.33/\text{lbm}$$

The structural cost savings based on the reduced structure weight of 600 lb is:

$$\text{Structure Cost Saving} = (\$257.33) (600) = \$154,000/\text{aircraft}$$

Fuel Cost Estimate - The cost savings in reduced fuel consumption can be calculated as follows based on the fuel tanks being filled once a week for 20 years with fuel at \$0.40 per gallon.

$$\text{Fuel Cost Saving} = \frac{920 \text{ lbm}}{6.5 \text{ lbm/gal}} (52) (20) (\$0.40) = \$58,000/\text{aircraft}$$

Engine Cost - TiAl Components (from Task II)

- a. Compressor Blades (466) \$ 657
- b. Mixing Duct 7,488
- c. Augmentor Liner 3,736

\$11,881/engine

Life Cycle System Cost Savings Based on 240 Aircraft

Aircraft Structure Savings 154,400 (240) = \$37.1 million

Fuel Cost Savings 58,880 (240) = \$14.1 million

\$51.2 million

Increased Cost of TiAl Components (0.01 (960) = -9.6 million

Net System Savings = \$41.6 million

Note: All costs are in 1977 dollars.

REFERENCES

1. Jaffee, R.I. et al., "Stable, High Strength, Alpha Titanium Base Alloys," U.S. Patent 2,892,705.
2. Rosenberg, H.W. "Titanium Alloying in Theory and Practice," The Science, Technology and Application of Titanium, Pergamon Press, 1970 (Proceedings of the First International Conference on Titanium, London, England, May 1968).
3. McAndrew, J.B and Simcoe, C.R., "Investigation of the Ti-Al-Cb System as a Source of Alloys for Use at 1200° - 1800° F," Armour Research Foundation of Illinois Institute of Technology, WADD-TR-60-99, May 1960.
4. McAndrew, J.B and Simcoe, C.R., "Development of a Ti-Al-Cb Alloy for Use at 1200° - 1800° F," Armour Research Foundation of Illinois Institute of Technology, ASD-TR-61-446, March 1962.
5. McAndrew, J.B. et al., "Development of a Ti-Al-Cb Alloy for Use at 1200° - 1800° F," Armour Research Foundation of Illinois Institute of Technology, AFML-TR-61-446 Part II, June 1963.
6. Blackburn, M.J. et al., "Research to Conduct an Experimental and Analytical Investigation of Alloys," Pratt & Whitney Aircraft Group, Contract F33615-75-C-1167 Quarterly Progress Reports for 2/17/75 through 10/21/77.
7. Rhodes, C.G. et al., "Study of Intermetallic Compounds," Rockwell International Science Center, AFML-TR-76-105, June 1976.
8. Hoffmann, A.L. et al., "Rolling, Forming, and Joining Titanium Aluminide Sheets," Battelle Columbus Laboratories, Contract F33615-75-C-1168 Quarterly Progress Reports for 2/15/75 through 6/15/77.
9. Rhodes, C.G. and Paton, N.E., "Titanium Aluminides for Elevated Temperature Applications," Rockwell International Science Center, Contract F33615-77-C-5079 Quarterly Progress Reports Beginning 6/1/77.
10. Kessler, H.D. and McAndrew, J.B. "Investigation of the Metallurgical Characteristics of the 36% Aluminum Titanium-Base Alloy," Armour Research Foundation of Illinois Institute of Technology, WADC-TR-53-182, July 1953.
11. McAndrew, J.B. and McPherson, D.J., "Investigation of the Metallurgical Characteristics of the 36% Aluminum Titanium-Base Alloy," Armour Research Foundation of the Illinois Institute of Technology, WADC-TR-53-182 Part II, January 1955.
12. Blackburn, M.J. et al., "The Understanding and Exploitation of Alloys Based on the Compound TiAl (Phase)," Pratt & Whitney Aircraft Group, Contract F33615-74-C-1140 Quarterly Progress Reports for 5/15/74 through 9/15/76.

13. O'Connell, T.E., "Study of Intermetallic Compounds," Pratt & Whitney Aircraft Group, Contract F33615-75-C-1166 Quarterly Progress Reports for 2/15/75 through 4/1/77.
14. Taylor, John. W.R. (Editor), Jane's All The World's Aircraft, Jane's Yearbooks, London, 1976-1977.
15. Nicolai, Leland M., Fundamentals of Aircraft Design, University of Dayton, Dayton, Ohio, 1975.
16. Corning, Gerald M., Supersonic and Subsonic CTOL and VTOL Airplane Design, Published by the Author, Box No. 14, College Park, Maryland, 1976.
17. Anonymous, "Industry," Interavia, 8-75, p 832.
18. Anonymous, "Aircene," Air Enthusiast, July 1973, p 6.
19. Fink, Donald E, "B-1 Avionics Test Vehicle Flight Nears," Aviation Week and Space Technology, 9 Feb. 1976, p 48-51.
20. Anonymous, Compilation of Labor and Wholesale Price Indexes, General Electric, 1978.