

# UNCLASSIFIED

<b>AD NUMBER</b>
ADB191132
<b>NEW LIMITATION CHANGE</b>
<b>TO</b> Approved for public release, distribution unlimited
<b>FROM</b> Distribution: DTIC users only.
<b>AUTHORITY</b>
AFDTC/PA ltr., dtd January 11, 1995, signed by Chief of Public Affairs.

**THIS PAGE IS UNCLASSIFIED**

AD-B191 132



OCT 24 1994  
F

HEADQUARTERS  
AIR PROVING GROUND COMMAND  
Eglin Air Force Base, Florida

This material contains information affecting the national defense of the United States within the meaning of the Espionage Laws, Title 18, U.S.C. Sections 793 and 794, the transmission or revelation of which in any manner to an unauthorized person is prohibited by law.

*u.g.*  
*GP IV*  
*7/22/45*  
*5372283*

FINAL REPORT  
ON  
OPERATIONAL SUITABILITY TEST  
OF THE B-57B AIRCRAFT (U)  
PROJECT NO. APG/TAS/119-A

DOWNGRADED AT 8 YEAR INTERVAL  
DECLASSIFIED AFTER 12 YEARS  
DOD DIR 5200.10

ATTENTION TO APGC  
ADJUTANT  
TECHNICAL REPORT BRANCH  
DO NOT DESTROY

This document is classified SECRET in accordance with paragraph 23, AFR 205-1

*Project APG/TAS/119 - A*

"DTIC USERS ONLY"

Additional copies of this Report may be obtained from:

Armed Services Technical Information Agency  
Document Service Center  
Knott Building, Dayton 2, Ohio

Indicate Project Number and Title

Classification changed per Authority *APGC* Letter Dated *22 Sep 58*  
Distribution Limitations: *R.T.*

This document will not be distributed outside the Department of Defense or its contractors without prior approval of this Headquarters.

Retain or destroy in accordance with AFR 205-1. Do not return.

1 Copy No. 132 of 150 Copies.

UNCLASSIFIED

DTIC QUALITY INSPECTED 3

94-32732

94 10 21 0

SEP 14 1958

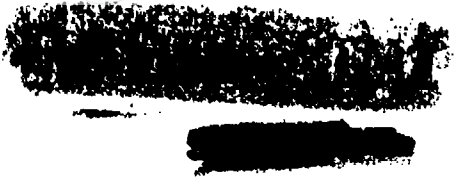

**UNCLASSIFIED**

**THIS PAGE BLANK**

**UNCLASSIFIED**



UNCLASSIFIED

CONFIDENTIAL  
[REDACTED]  
HEADQUARTERS  
AIR PROVING GROUND COMMAND  
Eglin Air Force Base, Florida

6 September 1955

PROJECT NO. APG/TAS/119-A

OPERATIONAL SUITABILITY TEST OF THE B-57B AIRCRAFT (U)

1. The object of this test was to determine the Operational Suitability of the B-57B Weapons System for performing the night intruder and close support missions of the Tactical Air Forces. (U)

2. The B-57B has the potential of providing the USAF with an effective night intruder and all weather attack weapons system. At the present time, however, it cannot fulfill the requirements of a night intruder because it is inadequately equipped for navigation, target acquisition, and all weather operation. Also, the inherent line of sight limitations of present ground based bombing systems do not permit exploitation of the range and performance capabilities of the aircraft in the all weather attack role. (S)

3. If maximum effectiveness is to be realized from the B-57B, action is required to provide navigation and armament delivery systems which will allow operation to the full extent of the aircraft's performance capability. (S)

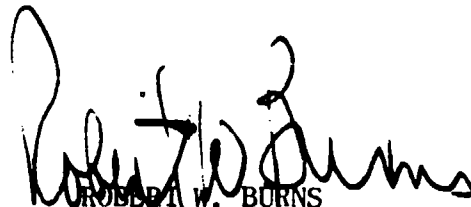
  
ROBERT W. BURNS  
Major General, USAF  
Commander

UNCLASSIFIED

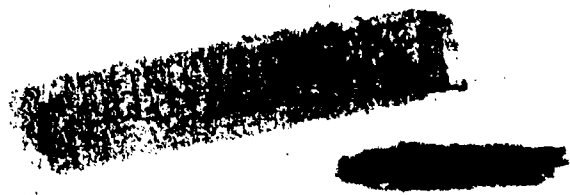

**UNCLASSIFIED**

**THIS PAGE BLANK**

**UNCLASSIFIED**

**iv**



UNCLASSIFIED

CONFIDENTIAL

HEADQUARTERS  
AIR FORCE OPERATIONAL TEST CENTER  
Eglin Air Force Base, Florida

FINAL REPORT

ON

OPERATIONAL SUITABILITY TEST OF THE B-57B AIRCRAFT

(Title Unclassified)

Accession For	
NTIS CRA&I	
DTIC TAB	
Unannounced	
Justification	
By	
Distribution/	
Availability Codes	
Dist	Avail and/or Special
12	

"DTIC USERS ONLY"

PROJECT NO. APG/TAS/119-A

UNCLASSIFIED

CONFIDENTIAL

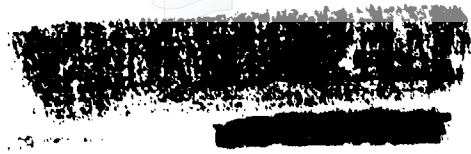

This page has been  
intentionally  
left blank

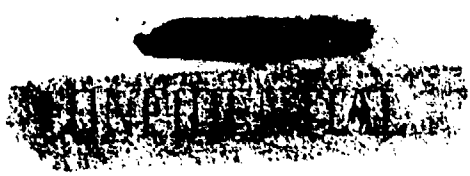

**SECRET**

**TABLE OF CONTENTS**

	Page
<b>SUMMARY</b> . . . . .	5
1. INTRODUCTION . . . . .	5
2. PURPOSE AND DESCRIPTION OF TEST ITEM . . . . .	6
3. OBJECT . . . . .	7
4. CONCLUSIONS . . . . .	7
5. RECOMMENDATIONS . . . . .	9
<b>DISCUSSION</b> . . . . .	11
1. GENERAL . . . . .	11
2. ORGANIZATIONAL IMPACT . . . . .	11
a. Personnel . . . . .	11
b. Training . . . . .	11
c. Facilities . . . . .	13
3. CAPABILITIES . . . . .	16
4. LIMITATIONS . . . . .	18
5. TACTICS AND TECHNIQUES . . . . .	20
6. COLLECTIVE ANALYSIS . . . . .	22
<b>APPENDICES</b>	
Appendix A - Test Procedure . . . . .	31
Appendix B - Test Results . . . . .	40
Appendix C - Functional Deficiencies . . . . .	77
Appendix D - Detailed Recommendations . . . . .	95

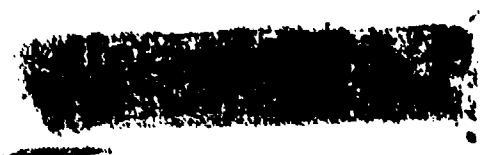
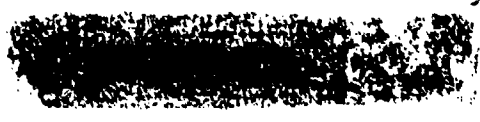
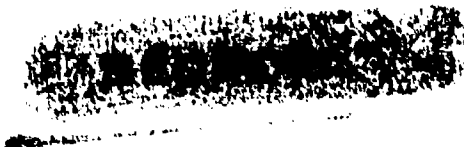

TABLE OF CONTENTS (Cont'd.)

	Page
<b>APPENDICES</b>	
Appendix E - Recommended Operating Procedures . . .	111
Appendix F - Maintenance and Support Annex . . .	117
Appendix G - Human Factors . . . . .	134
Appendix H - Evaluation of Additional Equipment and Modifications . . . . .	162





SUMMARY

1. INTRODUCTION:

a. This is the final report on the "Operational Suitability Test of the B-57B Aircraft", Project No. APG/TAS/119-A. The test was conducted under the provisions of Air Force Regulation 80-14, dated 11 September 1951. (U)



Figure 1: The B-57B Aircraft (U)

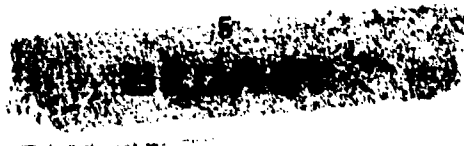

b. Investigation was concentrated in those areas of tactical employment outlined in current Tactical Air Command, Far East Air Force, and United States Air Forces in Europe Operational Plans for the B-57B. After extensive delays were encountered, Headquarters USAF directed that the program be sharply abbreviated in order to preserve an element of timeliness in the data obtained. During the course of the test the decision was made to confine further testing to (a) special weapons delivery methods and (b) investigations of the flare dispenser concept for night low-level search and attack illumination. (S)

2. PURPOSE AND DESCRIPTION OF TEST ITEM:

a. The B-57B aircraft is intended for employment by the tactical air forces to search out, attack, and destroy counter-air, interdiction, and close support targets at night under all weather conditions and in the daytime in bad weather. (S)

b. The test vehicles used on this test were standard production B-57B aircraft. They are manufactured by the Glenn L. Martin Aircraft Company as the USAF version of the English Electric Canberra bomber. The more obvious changes incorporated in the American aircraft include addition of a large T-33 type canopy, a rotary bomb door, and large fuselage speed brakes. Power is provided by two Wright J-65-W-5 axial flow turbo-jets that deliver 7220 pounds of thrust at 100% RPM; there is no provision for thrust augmentation. The landing gear is of the tricycle type with two single wheel main gear and a dual wheel nose gear. Flight controls are conventional in design and operation except that a variable incidence horizontal stabilizer/elevator combination provides pitch control. Flight controls do not have power boost. Dimensions of the aircraft include a 64-foot wing span and a 65.5-foot length. Armament includes eight caliber .50 machine guns, and eight external rocket pylons or four external bomb pylons. From two to 21 internal bomb stations (depending on the size of the bomb) are provided in the rotary bomb door. A special door accommodates one special weapon. (S)

c. The aircraft is equipped with an ARC-27 UHF Radio, AIC-10 Interphone System, ARN-6 Radio Compass, APX-6 IFF, S-4 Shoran, APW 11-A Radar Set with Indicating Group APA-90, ARN-12 Marker Beacon Receiver, and the mounts and space for the APG-31 Gun Ranging Radar; this latter set is not yet available for installation. In addition, the AN/APS-54 Tail-Warning Radar in conjunction with the AN/ALE-2 Chaff Dispenser are programmed for the B-57B, and will be tested in the near future. To

**SECRET**

augment this standard equipment, the MA-2 LABS, the Navy Aero 2A Flare Dispenser, and the MK 20 Mod 5 gunsight were installed and tested. The only provisions for de-icing or anti-icing are a pitot heater, a windshield de-icing system, and a canopy defogging system. (U)

3. OBJECT: The object of this test was to determine the operational suitability of the B-57B weapons system for performing the night intruder and close support missions of the tactical air forces. Investigations were conducted in the following general areas: (U)

a. Suitability of the aircraft for its mission in respect to performance and handling characteristics. (U)

b. Navigational capabilities. (U)

c. Suitability of the aircraft as a delivery vehicle for special weapons, employing conventional and toss bombing techniques. (S)

d. Night search and attack capabilities, with and without artificial illumination. (U)

e. Suitability of the aircraft as a gunnery, bombing, and rocketry platform for low and medium altitude attacks. (U)

f. Suitability and accuracy of aiming devices. (U)

g. Organizational impact in respect to requirements for personnel, personnel training, equipment, and facilities for maintenance and operation of the aircraft. (U)

4. CONCLUSIONS: It is concluded that:

a. The B-57B weapons system does not fulfill the operational requirements of a night intruder because it is inadequately equipped for navigation, target acquisition, attack, and all weather operation. (S)

b. The B-57B has the potential, if properly equipped, of providing the USAF with an effective night intruder and all weather attack weapons system capable of delivering both conventional and special weapons. (S)

**SECRET**

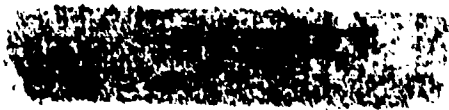
  
c. The B-57B is suitable from the overall maintenance standpoint. (Refer to the Materiel Annex, Appendix F.) (U)

d. The following major deficiencies must be corrected before the B-57B weapons system can be expected to operate with a consistent and dependable degree of effectiveness at night and/or in bad weather:

- (1) Lack of a precision navigational and bombing capability that will allow the aircraft to operate accurately out to its maximum range. (S)
- (2) Lack of anti-icing and de-icing provisions for engine and lift surfaces. (U)
- (3) Lack of adequate radio navigational equipment for use in peacetime training or for recovery of aircraft at the home base after strikes in a combat theater. (U)
- (4) Inadequacies of the armament system including:
  - (a) Unsuitable gun-bomb-rocket sight. (S)
  - (b) Unsuitable ammunition link ejection system. (S)
  - (c) Unsuitable location and presentation of some key armament system switches. (S)
  - (d) Unsuitable release characteristics of external stores. (S)
  - (e) Unsuitable wiring circuits for release of stores in some instances. (S)
- (5) Lack of a warning device against aerial interceptions. (S)

e. The inherent limitations in range and altitude of the S-4 Snoran bombing system do not permit exploitation of the range and performance capabilities of the B-57B. (S)

f. The AN/M-26A1 Parachute Flare is not compatible with the B-57B weapons system. (Refer to Appendix C, Paragraph 4.) (S)

g. Numerous minor deficiencies exist which should be corrected to increase the capability of the B-57B for effectively accomplishing its designed mission. (Refer to Appendix C.) (S)



**SECRET**

5. RECOMMENDATIONS: It is recommended that:

a. Immediate action be taken to increase the capabilities of the B-57B weapons system by installing certain items of "off-the-shelf" equipment. The equipment to be installed should be commensurate with the anticipated tactical utilization of the aircraft during its life span in the USAF inventory and should include: (S)

- (1) A precise, lightweight, navigational and bombing system (probably the APN-59 or equivalent) that will permit the aircraft to be flown accurately to any position within its range. (S)
- (2) Effective provisions for anti-icing or de-icing of the engines and lift surfaces to assure a reasonable all weather capability. (S)
- (3) Installation of the most reliable and effective radio navigational equipment available. (S)
- (4) A simple but effective automatic pilot. (S)
- (5) The Low Altitude Bombing System (LABS), complete with an automatic trim device. (S)
- (6) An effective warning device against aerial interception. (S)
- (7) An improved version of a fixed gun sight that will not impair forward visibility at night during low level attacks. (S)
- (8) Provisions for use of the T-1 Partial Pressure Suit (or equivalent). (S)
- (9) Ballistic bomb boxes for the AN/MSQ-1 close support control ground radar set to accommodate the T-63 Practice Unit. (S)

b. An intensified effort be made by development agencies of the USAF toward developing equipment or a system of equipments that will assure a high degree of target acquisition at night and in bad weather with a minimum of search for all future night intruder weapons systems. (S)

**SECRET**

**SECRET**

c. Immediate attention be given to the correction of the severe limitations in the armament system as cited in Appendix C. (U)

d. A suitable parachute flare and dispensing mechanism be developed to fulfill the requirements for search, attack, and area illumination as needed to perform the night intruder and night close support roles in the B-57B. (S)

e. Action be taken on the minor recommendations as listed in Appendix E and the recommendations pertaining to materiel deficiencies in Appendix F. (U)

**SECRET**

**SECRET**

## DISCUSSION

### 1. GENERAL:

a. This test was conducted under the task force concept in that several commands with a primary interest in the B-57B participated in the operational suitability test. While the primary responsibility was retained by the Air Force Operational Test Center, representatives of the Tactical Air Command, Air Research and Development Command, Air Training Command, and the Air Materiel Command were either active in the testing and evaluation or monitored their particular field of interest. (U)

b. The physical testing program included 129 sorties totalling 238 flying hours. Eight pilots and four observers were employed on the test sorties. All but one pilot and two observers had completed combat tours in Korea in night intruder or night photo reconnaissance units. In general, the experience level of test personnel was similar to that of current tactical squadrons transitioning into the B-57B. (U)

### 2. ORGANIZATIONAL IMPACT:

#### a. Personnel:

There is no apparent need for additions to the personnel authorized in the proposed Table of Organization (T/O 1-1157P) dated 1 November 1953 unless additional radar equipment is installed in the aircraft. (U)

#### b. Training:

- (1) Pilot (AFSC 1224B): Basic transition into the B-57B requires a minimum of preliminary training for a rated pilot previously qualified as a 1224C. Jet indoctrination should be provided in a formal ground school or Mobile Training Unit that covers jet theories, high speed navigation, high altitude weather phenomena, physiological training to include a thorough knowledge of the potential dangers to be encountered above 43,000 feet, and the B-57B aircraft in general. Mere transition training is deceptively simple in that students overestimate their mastery of the aircraft; consequently, close supervision should be exercised and repeated cautions should be issued advising the student of critical conditions that can occur with little or no warning.

**SECRET**

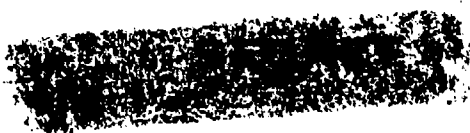

This applies specifically to airspeed and Mach Number limitations and fuel management, conditions which are not normally of primary concern to the conventionally trained pilot. Specialized training of the pilot to realize the full capabilities of the aircraft is somewhat more extensive than previously required for the night intruder role. Day and night instruction in acrobatics and unusual positions on instruments will be necessary, as will additional practice and training for low level night attack in a relatively high performance aircraft. In consideration of the basic mission of the aircraft, it is virtually mandatory that at least 75% of this training be accomplished at night. It is necessary that the pilot be given a course of instruction on the capabilities, limitations, and methods of operation of the S-4 Shoran and APW-11A/MSQ-1 systems. This should include considerable practice with each system in flight or in the flight simulators. For special weapons delivery, it will be necessary that each pilot attend a course of instruction to become a bomb commander. Further, in the case of the MA-2 LABS an understanding of the equipment and the delivery technique must be taught, and sufficient training in the maneuver must be provided to assure proficiency at night or in bad weather. (S)

- (2) Observer (AFSC 1525C): An observer fully qualified in basic navigation and use of the S-4 Shoran system requires little in the way of additional training in respect to the primary functions of his job. Because of the exceedingly meager navigational and bombing equipment and a virtual lack of other duties, the observer is actually unable to take full advantage of the formal training provided in the observers school. General instruction in the capabilities and limitations of the aircraft, procedures for use of equipment to be operated by the observer and procedures for operation of emergency equipment will be required. Also, an indoctrination on the principles of jet flying and allied weather phenomena is essential. Continuous training and practice will be required to attain and maintain proficiency with the S-4 Shoran and visual navigational procedures at all altitudes. Further, if additional radar navigational equipment

~~SECRET~~

is installed, training in operation of this equipment will be required. (U)

- (3) Maintenance Personnel: The general simplicity and ease of maintenance of the B-57B and its systems lend themselves to uncomplicated maintenance procedures. Formal training of supervisory personnel and crew chiefs is desired, but OJT training is satisfactory for other personnel if factory or service school training cannot be accomplished. Here again, if additional radar equipment is to be provided to augment the present equipment installed in the aircraft, training in the maintenance of such equipment will be required. (U)
- (4) Armament Personnel: Formal schooling for qualified armament men in respect to conventional stores is not required, but it is desirable in order that a thorough knowledge of the radically new bomb door can be attained. During this test, only supervisory personnel were trained in formal B-57B courses; other personnel acquired their training under the direction of the supervisors. In the case of special weapons, it is necessary that key personnel (those actually engaged in the handling and preparation of the units) be given a detailed course of instruction in the applicable phases of special weapons and control systems in the B-57B. (U)

c. Facilities:

- (1) Runways: The B-57B can operate normally from a substantially shorter runway (concrete or pierced steel) than is required for other contemporary jet tactical aircraft. For a general comparison, it may be said that the B-57B will operate satisfactorily off any runway that will accommodate a B-26 (Douglas) in tactical operations at maximum gross weights (38,000 pounds). (Refer to Appendix B, Paragraph 1c and d.) (S)
- (2) Parking and Loading Areas: Minimum requirements for parking and loading areas for the B-57B are somewhat greater than those for the B-26. A loaded B-57B may require as much as 80% RPM for starting to taxi and the resulting jet blast is sufficient to tear up

~~SECRET~~

**SECRET**

packed earth or brittle asphalt, in addition to its dangerous effect on ground personnel and equipment in its wake. Further, the dismounting, loading, and remounting of the rotary bomb door requires a smooth surface beneath the parked aircraft. This is particularly critical in the loading of the T-63 Practice Unit where clearance between the loaded door and the aircraft is less than an inch. These conditions make a fairly smooth, hard surfaced parking and loading area essential. Further, the area should be laid out to minimize sharp turning at slow speeds in order to avoid the use of dangerously high RPM in the congested areas. This factor in itself dictates a considerable dispersion problem. The typical "minimum turn radius" revetments employed for the Douglas B-26's in the Korean airfields definitely should not be employed for the B-57B, since high-power turns in such a small enclosure would make engine damage from foreign objects a distinct possibility. (S)

(3) Gunnery and Bombing Ranges:

- (a) For Conventional Attacks at Low Altitudes: Training for conventional weapons attacks at altitudes below 30,000 feet can be safely conducted on ranges used for the same purpose by fighter-bomber aircraft. (U)
- (b) For Level Bombing Attacks Above 30,000 Feet: Level bombing attacks with the APW-11A/MSQ-1 or S-4 Shoran Bombing System above 30,000 feet require much more elaborate range facilities than those formerly required by night intruder organizations for training. Gross errors in the magnitude of several thousand feet can be induced by many factors. Consequently, ranges must be large enough to accommodate such errors with safety, or radar safety monitoring must be provided to avoid the release of bombs when the aircraft is not in position to hit the range. (U)
- (c) For LABS and Toss Bombing Techniques: The probabilities of gross errors in the nature of several thousand feet occurring with LABS and M-1 Toss Bombing techniques are high enough to

**SECRET**

justify a much larger impact area than is generally required for level bombing at low altitude. Also, the requirement for the two- to five-mile run into the target at minimum altitude at high power settings and with the bomb door open dictates a much more isolated bombing range than formerly required for night attack work. Finally, many aspects of the training for delivery of special weapons are classified and undoubtedly will be classified for some time to come—an obvious requirement for an isolated target area for the sake of security. (S)

- (4) Liquid Oxygen Resupply: The liquid oxygen system of the B-57B imposes a serious logistic problem upon support facilities when the aircraft is used in the field. Each wing will require a suitable liquid oxygen generator (A-1A or equivalent) with a minimum output of 3000 gallons per month. A storage facility must also be provided to minimize loss by evaporation of supplies on hand. In this respect it is to be noted that once an aircraft is serviced with liquid oxygen in temperate weather the oxygen evaporates rapidly, and the system must be refilled again in a matter of hours if the flight is delayed. (Requirements cited above are based on the sustained operations described in the TAC Operational Plan for the B-57B and computed from consumption figures obtained during this test.) (U)
- (5) Support of Special Weapons Capabilities: The problems involved with maintaining a special weapons capability is one that will be entirely new to night intruder organizations, since the B-57B is the first night intruder aircraft to have this capability. In addition to the training of personnel, there are the much more extensive considerations involved in devising a workable and extremely mobile plan for supply of necessary items on short notice. Such a plan would necessarily provide for operation with squadrons dispersed to various locations, and aligned with the current directives pertaining to the handling of special weapons. (S)

**3. CAPABILITIES:**

**a. Aircraft Performance:**

- (1) The B-57B is capable of being operated from hard surface or pierced steel plank runways 5000 feet or more in length. (Refer to Appendix B, Paragraph 1c and d.) (S)
- (2) The B-57B may be turned around between sorties within the two hour minimum required for conventional or special weapons with only that ground support equipment and personnel required for refueling, rearming, and reserVICing with oxygen. (S)
- (3) The aircraft will operate and maneuver within the applicable limits of performance for special weapons delivery techniques required for LABS and the M-1 Toss Bomb Computer. (S)
- (4) The aircraft is capable of effective evasive action against a single interceptor attack at altitudes above 40,000 feet, provided the pilot can see the attacking aircraft.
- (5) Various ordnance loads can be carried up to the maximum gross weight of 53,400 pounds, of which the following are representative: (S)
  - (a) One T-63 Practice Unit; or
  - (b) Four MA-3 Century Launchers with twenty-eight 2.75-inch FFA Rockets, four M-116 Firebombs, 2400 rounds of .50 caliber ammunition, and 5460 pounds of internally loaded bombs (21 260-pound fragmentation bombs). (S)
- (6) The aircraft is capable of ranges of 2200 nautical miles (1100-mile radius of action) in a clean configuration with an internal bomb load at optimum altitudes. (S)
- (7) The aircraft is capable of ranges of 1050 nautical miles (525-mile radius of action) in high drag configurations required for target-of-opportunity missions. (S)

- (8) The B-57B is capable of ranges of 1150 miles (575-mile radius of action) in the minimum altitude LABS attack type of mission. (S)

b. Ordnance Delivery:

- (1) The B-57B in its present configuration (without the MA-2 LABS installed) is capable of delivering a special weapon utilizing the LABS technique with a CEA of 1284 feet by day or by night, employing the 87-degree or the "over-the-shoulder" release angles only. (Refer to Appendix B, Paragraph 2.) (S)
- (2) The B-57B, with an MA-2 LABS installed, is capable of delivering a special weapon more accurately than with the "Stand-by" method from any release angle even when manned by relatively untrained crews. (Refer to Appendix B, Paragraph 3.) (S)
- (3) The weapons system is capable of delivering conventional ordnance and special weapons with APW-11A/MSQ-1 from altitudes up to 45,000 feet. (Refer to Appendix B, Paragraph 4.) (S)
- (4) The weapons system is capable of delivering conventional ordnance through gunnery, rocketry, dive bombing, and fixed angle bombing with the accuracies normally expected of the systems provided. (U)

c. Navigation and Target Location:

- (1) Precise navigation can be performed within the line-of-sight and reliability limitations of the S-4 Shoran and ground radar systems. (S)
- (2) Navigation can be performed beyond the range of the Shoran stations with the accuracies normally expected of dead reckoning and pilotage. (U)
- (3) Targets of opportunity can be located at night without artificial illumination if enough natural illumination is present from the moon or stars. (U)

d. Maintenance: The B-57B can be adequately maintained by the personnel authorized in the current Table of Organization (T/O 1-1157 P, dated 1 Jun 1955). (U)

**4. LIMITATIONS:** The B-57B weapons system has the following limitations:

**a. Navigational Limitations:**

- (1) There is no self-contained precision navigation system. (S)
- (2) There is no precision navigation capability beyond the line-of-sight range of Shoran. (S)
- (3) The radio navigational capability is limited to the ARN-6 Radio Compass and the ARN-12 Marker Beacon Receiver. (S)

**b. Armament System Limitations:**

- (1) The Mk 8 Mod 8 Gunsight reduces forward visibility, cannot be adjusted at night without outside light, and cannot be adjusted to full depression because its reflector strikes the windshield. (S)
- (2) The location of many key armament system control devices makes them extremely awkward for the pilot to see and operate; there is no provision for the observer to assist the pilot in setting up armament controls in the attack. (S)
- (3) Relocating bomb shackles and sway braces to change the bomb door configuration takes excessive time when quick turnaround is a factor. (C)
- (4) Most external stores cannot be released cleanly from the wing pylons at operational airspeeds. (C)
- (5) A minimum of five men is required to mount or dismount the rotary bomb door. (C)
- (6) The B-57B, in its present configuration, cannot carry and release parachute flares available in the USAF inventory. (C)
- (7) Only one shape of a special weapon can be carried on the special door in its present configuration. (S)

- (8) Fire-out rates with the present gun system are unacceptably low due to repeated charger failures and link chute jams. (S)

c. Bomb Aiming Limitations:

- (1) There is no self-contained visual or radar bomb aiming system for use in level flight, except for the Mark 8 Mod 8 fixed gunsight. (C)
- (2) There is no high altitude level bombing system beyond the range of Shoran or APW-11A/MSQ-1. (C)
- (3) The S-4 Shoran System cannot operate at the maximum altitude of the aircraft and, as experienced on this test, has an unacceptably low reliability rate. (C)
- (4) There is no capability at present for releasing special weapons with the APW-11A/MSQ-1 ground station using the automatic bomb ballistics equipment. (S)
- (5) Many elements of the fixed angle bombing technique make this type of attack undesirable for night intruder operations except against a limited field of targets. (C)

d. General Limitations:

- (1) There is no provision for anti-icing or de-icing the engines or lift surfaces. (S)
- (2) There is no provision for accommodating a T-1 Partial Pressure Suit or equivalent to permit the crew to operate the aircraft at its maximum operational altitude. (S)
- (3) The crew seats are operationally unsuitable because:
  - (a) They are unduly fatiguing because of poor design. (U)
  - (b) They will not accommodate any standard version of currently available survival gear. (U)
  - (c) The quick disconnect units are prone to separate frequently from normal airframe vibration. (U)

**SECRET**

- (d) Design of the seat frame permits inadvertent loosening of the safety belts with crew members in the seat. (U)
- (e) The seats are so physically confining that adjustment of the seat belt is extremely difficult. (U)
- (f) Routing of the oxygen hose in the pilot's position cannot be accomplished without interference with the pilot's arm or thigh. (U)
- (4) The absence of a "hot mike" system reduces crew coordination and effectiveness. (U)
- (5) There is no provision for tail warning equipment. (S)
- (6) The dive brake actuating switch is awkwardly placed for effective operation. (U)
- (7) The cockpit defogging system is not adequate to maintain clear vision in the windshield during a maximum performance letdown from high altitude. (C)
- (8) There is no provision for holding data cards or note paper for the pilot's use in flight; the confines of the seat and the proximity of the control column prevent use of the knee type note pad. (U)

5. TACTICS AND TECHNIQUES:

a. Tactics: In compliance with the stated plan for single ship employment of the B-57B by the Tactical Air Command, all sorties of this test were individual efforts with each aircraft carrying its own ordnance and artificial illumination (when applicable). (S)

- (1) Penetration and Recovery: It is possible to exploit the increased performance of the B-57B to considerable tactical advantage in penetration into and recovery from the target area. High altitude capabilities permit the aircraft to be flown above most hazardous weather conditions that would have caused earlier night intruder missions to fail. In addition, the increased speed, range, and maneuverability permit the B-57B to operate in areas not accessible to earlier night intruder types. (S)

**SECRET**

**SECRET**

- (2) Search and Attack: For target acquisition, the tactics for employment of the B-57B conform quite closely to those used by the Douglas B-26 night intruders in Korea. Search and attack are still wholly dependent upon the visual acuity of crew members. Further, in view of the accuracy with which the LABS technique for special weapons delivery must be employed, it may be necessary to adopt some version of the pathfinder or target marker tactics used in World War II and Korea in order to fully exploit the special weapons capabilities. (S)
- (3) Defensive Tactics: The B-57B has an effective passive defense against single interceptors or uncoordinated attacks by two or more interceptors. The aircraft can be turned at extremely high rates of turn, particularly at high altitudes, and interceptor attacks can be successfully thwarted with such turns. Employment of this tactic requires visual location of the interceptor before he is in firing position. In those situations where the enemy is able to mount a persistent and aggressive interceptor attack with modern fighter aircraft, the B-57B will be extremely vulnerable. Consequently, successful attacks by the B-57B in such a situation would be committed to low level tactics to minimize radar detection ranges and probabilities of effective interception. (S)

b. Techniques:

- (1) Conventional Ordnance Delivery: There is no equipment in the B-57B that changes its techniques materially from those utilized by the Douglas B-26. The increased acceleration and deceleration capabilities permit some expansion of these techniques into wider ranges of airspeed, dive angles, and altitudes. (U)
- (2) Special Weapons Delivery: The only new techniques for special weapons delivery in the B-57B rests in its ability to perform the LABS maneuver; release of a special weapon with Shoran or APW-11A is no different in technique than delivery of conventional ordnance with the same systems. However, when using Shoran, the bomb door must be opened manually, since

**SECRET**

**SECRET**

the automatic door opening feature would not allow sufficient time for fin extension of the special weapon. Execution of the LABS maneuver, either with the "stand-by" technique or with the MA-2 LABS, is quite simple in that it consists of an Immelmann turn maneuver executed with a known series of conditions of airspeed, altitude, acceleration, and bomb release angle. Even with the "stand-by" system this can be accomplished with acceptable accuracies for some combinations of weapons and targets. However, the inescapable problem of initial target acquisition makes this type of attack extremely difficult to bring to bear against a target at night. Since the attack must be initiated at low level, the visibility problem is further increased. It was found that the "over-the-shoulder" attack could be used with an acceptable degree of accuracy, since the visibility problem obviated the use of an IP (Initial Point) for timing. Further, it was obvious that a target selected for special weapons attack would probably be easier to find initially than would some lesser object used as an IP. In almost all cases, use of some sort of an IP is desirable, but not in the sense of timing for the LABS. What is actually required is a close-in departure point from which the aircraft can depart on a given heading and expect to locate the target with sufficient accuracy to permit a last second adjustment in tracking immediately prior to pull-up. (S)

6. COLLECTIVE ANALYSIS:

a. In the history of aerial warfare there has always been a requirement for effective employment of aircraft for attack at night. However, the many problems that darkness imposes upon the aircraft weapons system has fostered a consensus in the USAF that employment of night intruder aircraft is a secondary mission to daytime operation. As a result, we have never before designed and built in production quantities either an aircraft or a weapons system that is intended primarily for night attack work. Consequently, in the past, when enemy resupply and movement accelerated during hours of darkness and bad weather, the only weapon available was the same aircraft and equipment already being used to the maximum degree by day. Solutions to the night attack problems are yet to be attained. This is borne out with a minimum of reference to our progress in the fields of development of equipment and training of crews for night intruder

**SECRET**

**SECRET**

work. In spite of the lessons that were taught in World War II, there was not one night intruder unit in the structure of the USAF when the Korean Conflict began in 1950. Early in the war, when commanders again realized that the enemy's night resupply effort was sustaining his daytime operation, B-26 light bomber units were assigned the night intruder task even though they had no particular night capability beyond that of other units in the theater. Our thinking on night attack was evident in briefings that were given crews during these initial night efforts, e.g., "You are to circle and keep the enemy awake. Harrass him with engine noise and an occasional bomb release. You don't have to be seen to be effective. The enemy won't move with our aircraft in the vicinity." The lack of effectiveness of these early efforts and the only slightly more effective results of later efforts at night intruder operation is a matter of fact. The movement of the enemy's troops, materiel, and supplies was stopped during daylight hours by aerial attack; it flowed without serious delay at night. Even today, in spite of a complete awareness of the importance attached to effective night intruder operations, the USAF has not yet solved the basic night problem, i.e., the inability to locate targets at night with an acceptable degree of frequency. (S)

b. The continued recognition of some elements of the night problem has been evidenced in recent projects conducted at APGC. Of these, the APG/TAT/22-A series, "Investigation of Tactics and Techniques for Fighter-Bomber Aircraft for Night Attack," and Project No. APG/TAT/128-A, "Night Owl," were the most detailed in their scope. The results of these projects reaffirmed the complexity of the problem. In spite of the long established requirement for aircraft and equipment especially suited for night operations, the B-57B's sole claim to being especially equipped rests in its coat of black paint, which, ironically enough, is of dubious value in the night role. (S)

c. In order to examine the problems confronting the night intruder, it is necessary to fully understand the nature of the mission it performs. The mission of the night intruder is to locate, attack, and destroy both fixed and moving targets at night under all weather conditions. The aircraft will use visual and/or electronic aiming devices, and will be able to deliver both conventional and special weapons. In general, tactics will include: (S)

- (1) Employment in single ship sorties in order to retain the high degree of maneuverability and versatility required for night and bad weather operations. (S)

**SECRET**

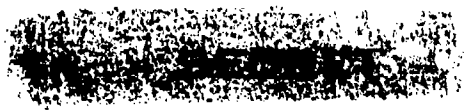
- 
- (2) Employment in that area defined by the main line of resistance and the limits of the operating radius of the aircraft. (S)
  - (3) Employment against counter-air, interdiction, and close support targets. (S)
  - (4) Extensive employment of artificial illumination (parachute flares) for target acquisition and attack. (S)
  - (5) Exploitation of capabilities that include satisfactory performance for operation off of advanced strips and quick turnaround times between sorties in order to obtain a maximum effort with a minimum force requirement. (S)

d. The night intruder mission readily breaks down into four phases, namely, Penetration, Search, Attack, and Recovery. Of these, the Attack phase is the only one that accomplishes the desired destruction of enemy resources; however, the very initiation of the attack is wholly dependent upon the complete success of the Penetration and Search phases. Furthermore, the ability to sustain a continuous operation can be realized only if the Recovery rate of attacking aircraft is great. To accomplish all of these phases of the night intruder mission with an acceptable degree of effectiveness, it is necessary that a weapons system have certain specific capabilities. (S)

e. The B-57B is the first aircraft that has ever been assigned the night intruder mission for a primary task straight from the production line. A comparison of the desired night intruder capability with the capabilities of the B-57B weapons system is presented below: (U)

DESIRED CAPABILITIES

1. High performance that will permit safe operation off of advanced air strips, fuel range and endurance well beyond that of a fighter-bomber and maneuverability that will assure delivery of ordnance with maximum effectiveness. (U)

B-57B CAPABILITIES

1. In general, the performance of the B-57B is superior to any other aircraft in respect to suitability for the night intruder mission. In fact, most aspects of its performance capability are extremely desirable for this mission. (U)

**SECRET**

2. A navigation system that will assure practical and precise navigation to any known point within the range of the aircraft, without visual reference to the ground. (U)

3. A search capability that will assure acquisition of fixed or moving targets in areas where targets exist. This search capability should be a positive one in order to avoid repeated patterns over a given area with consequent exposure to enemy action. (U)

4. An attack capability that will permit versatile and accurate delivery of conventional and special weapons. This must necessarily include aiming devices that will permit level bombing (electronic) from medium and high altitudes, low level gunnery, bombing, and rocketry attacks, and special weapons delivery techniques from all altitudes. (U)

2. There is no long range navigational capability in the B-57B except for pilotage and dead reckoning, which are entirely dependent upon visual contact with the ground to assure accuracy. The S-4 Shoran and APW-11A systems are dependent upon ground stations and do not extend beyond line-of-sight range. This is a major deficiency in the weapons system and is its most condemning limitation. (U)

3. There is no search capability in the B-57B weapons system beyond the visual acuity of the crew members. This limitation is an equipment fault and is independent of the aircraft. However, this lack of a search capability combines with the lack of a precise navigational capability to assure that a very high percentage of sorties will fail for lack of target acquisition. (U)

4. The B-57B weapons system has a level bombing capability in the S-4 Shoran system and the APW-11A, but these are both limited to line-of-sight ranges, less than 25% of the usable range of the aircraft. Further, the Shoran equipment is limited to 43,000 feet or below. The Mk 8 Mod 8 Sight is unsuited for the night attack role because it impairs forward visibility and requires too much attention for adjustment. At present, the special weapons delivery capabilities of the B-57B lie in the S-4 Shoran system, Manual MSQ-1/APW-11A, and the "stand-by" LABS technique. (S)

**SECRET**

**SECRET**

5. A provision for some form of artificial illumination that will provide adequate light for search and attack for as long as 50 minutes, without undue sacrifice of ordnance carrying capability. (U)

6. An ordnance carrying and delivery capability that will accommodate substantial quantities of conventional and special ordnance items. (U)

7. A defense capability, active or passive, that will assure an acceptable survival probability against enemy air action. This must necessarily include a tail warning device as a minimum requirement. (U)

5. The B-57B cannot safely carry the AN/M-26A1 Parachute Flare (refer to Appendix E), which is the only parachute flare in the USAF inventory. This limitation is imposed by the construction of the flare which limits it to release at 350 miles per hour or less, and is not considered compatible with the aircraft. In fact, with the power available in the B-57B, it is felt that an excellent flare capability could be enjoyed if a suitable flare and flare dispenser combination could be provided for external carriage. (S)

6. The B-57B is capable of carrying a wide variety of conventional ordnance items in substantial quantity. However, a design deficiency in external pylons will not permit release of most external stores without damaging the wing. Correction of this defect is underway. The rotary bomb door on the aircraft is a unique and effective device, both in respect to its operation in the air and its ease of loading on the ground. Door interchangeability provides for an exceptionally short turnaround time for all internal loads if extra doors are available for preloading. A special door is provided to carry and release a special weapon. (S)

7. The B-57B has no tail warning system and no defensive armament. However, its inherent ability to maneuver effectively, particularly at altitude, provides it with an excellent evasive capability and a possible counter-attack capability in the event of

**SECRET**

attack. Exploitation of these capabilities is entirely contingent upon initially sighting an attacker well before he is in firing position. (S)

8. An all weather penetration capability that will include satisfactory stability and handling characteristics for instrument flying, adequate flight instruments and flight instrument presentation, and adequate provisions for anti-icing and de-icing for engines and lift surfaces. To minimize fatigue during extended night and/or instrument flights an automatic pilot is extremely desirable. (U)

8. The B-57B is satisfactory for instrument flying in respect to handling, and it has an excellent instrument presentation. However, a need for careful trimming due to CG changes resulting from use of fuel imposes an extremely heavy load on the pilot at night and in weather for extended periods. There is no provision for anti-icing or de-icing of the engines or lift surfaces, and no automatic pilot is installed. (S)

9. Maintenance and servicing capabilities that will assure a high in-commission rate and minimum turnaround times between sorties. (U)

9. Maintenance procedures for the B-57B are commensurate with high in-commission rates, provided adequate spare parts are available. One major exception to this is maintenance of the S-4 Shoran Set; this requires removal of the rear seat in order to have access to the set for maintenance. Turn-around can be accomplished within the two-hour limit desired for tactical operation. Exceptions to this will occur if extra bomb doors are not available and the bomb door configuration must be changed between sorties. (U)

f. Operation of the B-57B weapons system in a tactical organization appears to closely parallel operation of the B-26 in respect to organization, logistics, training, and facilities. (U)

(1) Organization: The principal reasons for any difference in the B-57B and the B-26 equipped

## SECRET

organizations result directly from the changes dictated by conversion from reciprocating to jet power plants in the aircraft involved. No substantial increases or decreases in personnel strength are warranted. (U)

(2) Logistics: This area presents the major impact upon a unit converting from B-26's to B-57B's. Liquid oxygen must be available to the base of operation, and elaborate precautions have to be taken with the liquid oxygen supply to minimize evaporation. Shorter engine life of the jet engine requires a much greater number of engines in the supply and build-up pipeline. Much higher rates of fuel consumption require proportionately greater fuel supplies and dispensing units. Addition of a special weapons capability requires that extra bomb doors be carried as organizational equipment in order to accommodate the special weapon, and thorough logistics plans for effecting supply of special weapons must be laid and constantly reviewed. (U)

(3) Training:

(a) Flying Crew:

1. Training of the crew is not particularly involved or difficult because the aircraft with its systems is very simple to operate. Check-out in the aircraft may be accomplished safely with a minimum of training to include jet indoctrination and instruction on the aircraft and its capabilities and limitations. (U)
2. Training of the crew as an effective unit requires considerable practice as a team for search techniques, Shoran operation and in-flight coordination. Further, the increased performance of the B-57B requires that the pilot be proficient in acrobatics and recovery from unusual positions on instruments in order to fully realize the capabilities of the aircraft. (U)

## SECRET

- (b) Maintenance Personnel: Key maintenance personnel (flight chiefs and crew chiefs) should have factory training or a comparable service course. Others can accomplish their training in OJT capacities. (U)
- (c) Armament Personnel: All armament personnel should attend a formal course of instruction that includes a thorough coverage of the operation and loading of the rotary bomb door and pertinent aspects of special weapons applicable to the B-57B. (U)
- (4) Facilities: On the basis of comparative figures for takeoff and landing roll, it appears that any airstrip suitable for the B-26 is also satisfactory for the B-57B. An evaluation of parking and run-up facilities, however, indicates that some additional preparation will be required for B-57B's in order to minimize the probability of foreign objects being sucked into the engines. (S)

g. The B-57B provides a greater potential than any other aircraft currently available to the Tactical Air Command for the night intruder role because of its performance capabilities, simplicity of operation, ease of maintenance, and its ability to deliver special weapons. However, the greater portion of the potential effectiveness of this weapons system cannot be realized because of a lack of equipment essential for night and all-weather operations. It is believed that the APN-59 radar should be installed immediately because:

(C)

- (1) It is relatively inexpensive and currently available.
- (2) It will complement and not detract from present capabilities.
- (3) It will provide a means of locating the target area beyond the range of Shoran or APW-11 so that conventional methods of target lighting and target acquisition can be employed.

**SECRET**

- (4) It will provide a means of low altitude navigation thus allowing minimum altitude penetration and withdrawal.
- (5) It will simplify the recovery problem.

**APPENDICES:**

- A - Test Procedure
- B - Test Results
- C - Functional Deficiencies
- D - Detailed Recommendations
- E - Recommended Operating Procedures
- F - Maintenance and Support Annex
- G - Human Factors
- H - Evaluation of Additional Equipment and Modifications

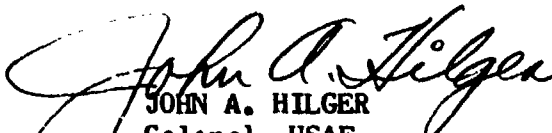
  
JOHN A. HILGER  
Colonel, USAF  
Commander

**SECRET**

## SECRET

### TEST PROCEDURES

#### 1. FAMILIARIZATION TRAINING:

a. The extremely low level of jet experience of all project crews assigned to this test dictated that considerable familiarization training be accomplished prior to commencement of testing and during the test when new techniques were to be attempted. The eight pilots actively participating flew from three to eight missions in preparation for the test investigations. These sorties included all of the performance and handling maneuvers normally associated with check-out training. In addition, these maneuvers were supplemented with dry runs in basic low level attack techniques, level bombing techniques with the S-4 Shoran system, the APW-11A/MSQ-1 system, and special weapons delivery techniques. (U)

b. During these familiarization sorties the initial evaluations were made of handling and performance characteristics, suitability of the cockpit layouts and location of controls, visibility for handling on the ground and in flight, and functional reliability of the installed equipment and systems. (U)

c. A limited amount of continuation training was accomplished during the period in which the aircraft were restricted to 250 knots indicated airspeed. During this period takeoff measurements were accomplished on hard surface and pierced steel runways with the aircraft in special weapons configuration. (U)

d. One sortie was flown to investigate altimeter position error corrections as a cross check of existing information published on this very important factor in low level operation at night. (U)

2. LABS "STAND-BY" MISSIONS: Lack of availability of an MA-2 LABS for installation during early months of testing prompted initiation of a series of tests without the computer installed. The object of these tests was to determine if the aircraft could perform the required maneuvers and if safe separation of the bomb from the aircraft could be attained during the accelerated state. Results were encouraging from the outset, so further investigation was conducted to determine the feasibility of employing this technique as an interim ("Stand-by") method for LABS delivery. The technique finally adopted is as follows: (Refer to Figure 24, Appendix G, Paragraph 3b, for a diagram illustrating the key points in the LABS delivery.) (S)

Appendix A, Page 1

## SECRET

a. Determination of the Release Angle: The sequence of development of this technique was actually in reverse order. The first step to be accomplished was determination of a reference point for a relatively consistent release angle, employing only those instruments standard to the B-57B. Study of the B-1A Vertical Flight Gyro (Attitude Indicator) showed that this instrument would provide such an indication at approximately 87 degrees of pitch when it would start a controlled precession and reversal. Bomb release could be made at the exact moment this precession began, as evidenced by a counter-clockwise movement of the gyro. (S)

b. Determination of the Pull-Up Point: Once the release point (angle) had been determined with an acceptable degree of constancy, the next step was determination of the pull-up point. Using data obtained in early LABS tests with the F-84G aircraft and LABS bombing tables, estimates were obtained for the horizontal distance the aircraft would travel during a constant acceleration to the release point and the distance the bomb would be tossed from release at this angle. First pull-ups were made with reference to a ground check-point (line of trees) known to be at the computed distance from the target. Later, in an effort to refine this technique, a system was devised for utilizing the Mk 8 Mod 8 Sight to determine the pull-up point. This amounted basically to the solution of a triangle that had two sides and the opposite angle known. (Refer to Figure 24, Paragraph 3b, Appendix G.) The aircraft was to be flown at a known altitude above the target (1000 feet) at a given airspeed and gross weight (for a relatively constant angle of attack). The horizontal distances from pull-up to release point (BC) and from release point to target (CD) were computed as stated above. Finally, since the angle between the horizontal approach leg (AB) and a line drawn through the aircraft at the pull-up point (B) would always be 90 degrees, other dimensions of the triangle could be computed. In this case the key dimension is the angle between the base horizontal range (BD) and the hypotenuse (slant range from the aircraft to the target at pull-up). This sighting angle can be measured with the Mk 8 Mod 8 fixed sight by depressing it to the desired angle and correcting for computed aircraft angle of attack. (S)

c. Attack Technique: The delivery technique with the "Stand-by" LABS method is quite simple and straightforward. Set the sight at the computed angle of depression, open the bomb door, and set the switches for bombing prior to entry into the attack run-in. Enter attack sufficiently far from the target to permit the airspeed to

Appendix A, Page 2

## SECRET

stabilize at between 420-425 knots indicated airspeed. The last mile and a half to two miles of the run-in should be made with strict attention to lining up on the target at the desired airspeed and altitude. Trim out all forces on the controls, particularly the rudders. Power required will be between 90% and 93% RPM for maintaining the entry airspeed straight and level. During the last part of the approach add power smoothly to 98% RPM. (Since acceleration will be almost immediate, power must not be added too early before pull-up is commenced or the airspeed will be higher than desired.) Both hands should be on the control wheel for pull-up when the pipper passes onto the target. Commence the pull-up with a steady application of back pressure until the desired acceleration (3.5 "G") is indicated on the accelerometer. The full acceleration rate should be attained in approximately two seconds. Sustain the acceleration as smoothly as possible with constant cross checking between accelerometer and the Attitude Instrument, using the latter for wings level indications. At the instant the Attitude Instrument commences a counterclockwise rotation from its vertical movement in the climb, hit the bomb release button. Continue the application of "G's" at the same rate or at a slightly reduced rate until the aircraft approaches the inverted position. Commence the half roll recovery at this time by application of aileron and rudder. Ideal recovery will find the aircraft in a slight nose low altitude, accelerating with the high power settings still on. Continue the acceleration until the limiting airspeed of 434 knots is attained to increase escape distance as much as possible. (S)

d. "Over the Shoulder" Release: This technique, as described, was expanded in one more respect in an effort to obtain satisfactory "over-the-shoulder" tosses. To obtain the proper release point, photodolite data from previous sorties were studied to determine the length of time required to traverse the arc from the approximate 87-degree point to the 110-degree point. To get a release at 110 degrees on subsequent missions, the pilot merely added this time (approximately three seconds) before release while continuing the acceleration through the controlled precession point of the Attitude Indicator. (S)

e. Evaluation: A total of 31 individual releases were made on eleven sorties employing the techniques described above. These included 25 M64A1 500-lb GP bombs, five M65A1 1000-lb GP bombs, and one T-63 Practice Unit. Each release was tracked and scored by photodolite cameras to include full coverage of both the bomb and the aircraft throughout the maneuver. (S)

Appendix A, Page 3

## SECRET

3. LABS MISSIONS WITH THE MA-2 COMPUTER: Late in the testing cycle an MA-2 LABS was secured and installed in one test vehicle in time for nine sorties. (Refer to Page 1, Appendix H, for a detailed description of the installation of this system.) Releases were made at 45-, 60-, 90-, and 110-degree angles. Completion of the maneuver with the assistance of the MA-2 LABS is basically the same as without a computer in respect to handling of the aircraft. Airspeed and power control are identical, but wings level and "G" indications are now obtained by reference to the LABS Indicator during the pull-up. The pull-up point and bomb release point are determined through the computer and must be preset prior to takeoff, and all pull-ups are made with the assistance of an automatic trim device to assure consistency in the initial stages of the maneuver. A total of 45 releases of 500-lb GP bombs were made with the computer. All runs were covered by photo-theodolite from pull-up through impact, with the flight path of both the aircraft and the bomb being plotted for study. (Refer to Paragraph 3g, Appendix G, for a more detailed description of techniques employed for conducting LABS sorties with the computer.) (S)

#### 4. S-4 SHORAN MISSIONS:

a. A total of 16 missions were flown employing the S-4 Shoran bombing system. Twenty-three bombs were released. The ground stations were located at Abbeville, Alabama, and Apalachicola, Florida; the target was Range 53 on Eglin AFB Reservation. The triangle thus formed measures 102, 123, and 91 statute miles. (C)

b. Operators flying the missions with the S-4 system had no previous experience with it, although they had worked with other versions of Shoran and were considered qualified. Of the two pilots used, only one had any previous experience with Shoran arc flying. (U)

c. Early test planning called for missions to be flown at both low and high altitudes; however, the program was curtailed before missions at the lower altitudes had been completed and the remaining missions were flown at 40,000 feet. (C)

d. All S-4 Shoran bombing missions were accomplished at night because of the extremely poor readability of the scope in daylight. One mission was flown in actual instrument conditions. Ordnance carried and released on these missions was the M64A1 500-lb GP bomb with M-128 conical tail fin. Spotting charges were used to assist in scoring. Preset bombing data was computed on the basis of a "Zero" Q factor. Scoring was accomplished by triangulation. (U)

Appendix A, Page 4

## SECRET

### 5. APW-11A/MSQ-1 MISSIONS:

a. Fourteen missions were flown using the APW-11A/MSQ-1 system for determining bomb release points. A total of 13 bombs were dropped. The MSQ-1 station was located only 13 statute miles from the range. On all missions another MSQ station located elsewhere on the Eglin Reservation had to be used to safety monitor releases to prevent release should gross errors be involved; this requirement was necessary because of the proximity of the bombing range to other installations.

(C)

b. On one of these sorties the pilot was equipped with the T-1 Partial Pressure Suit for protection at extreme altitude. The fittings for this suit are not standard equipment in the B-57B, so it was necessary to fabricate the necessary fittings locally. A description of the necessary modification is given in Paragraph 9, Appendix H.

(U)

6. LOW LEVEL ATTACK MISSIONS WITH CONVENTIONAL WEAPONS: A total of 29 sorties were flown in which bullets, bombs, or rockets were delivered. A part of the missions were flown in the daytime in order to permit observation of the systems involved, and the remainder were flown at night with or without flares. A brief description of the techniques employed is as follows:

(U)

a. Gunnery: The machine guns were fired on 24 sorties. The first five sorties were for the purpose of determining a workable pattern, and the rest of the sorties were flown with the pattern and technique established. This included a rectangular pattern flown at an altitude of 3000 feet above the ground. Power was set at approximately 84% RPM, establishing an airspeed of 220-240 knots indicated, with speed brakes in. Brakes were extended as the turn into the attack was made, and the angle of dive was measured at 13-15 degrees. By the time firing range was attained, the airspeed had built to the 300-knot harmonization speed. Recovery was made by retracting the dive brakes and zooming back to pattern altitude. This pattern was believed to be typical of the somewhat conservative attack generally required in night attack operations.

(U)

b. Rocketry: MA-1 Century Rocket Launchers were used on three sorties and the MA-3 Century Launchers were fired on 12 sorties. Most of this firing was done in the automatic position. In general, the pattern employed consisted of a dive of approximately 30 degrees from a base leg of 4000 to 5000 feet above the ground. Entry speed varied from

Appendix A, Page 5

## SECRET

220 to 250 knots, and dive brakes were extended in the final turn. Power was carried at 82-84% RPM. Airspeed would build up to 320-350 knots at the time firing range was attained. The same recovery as for the gunnery passes was employed; however, if repeated rocket passes were to be made it was necessary to add power to zoom to pattern altitude while maintaining more than 200 knots airspeed. (U)

c. Fixed Angle Bombing: Seven sorties were flown to investigate a fixed angle bombing capability, using the Mk 8 Mod 8 Sight or the Mk 20 Mod 5 as an aiming device. Settings were derived at by computing angles of attack for the desired release airspeed and then using the bombing tables for determining the path of the bomb from the altitude of release at the given airspeed. Release airspeeds of 350 knots and 375 knots and release altitudes of 2000 feet above the ground were flown for this series of tests. Three of the missions were run at night against a simulated convoy that was lighted with flare pots to simulate dimmed-out head lights. The technique employed was to make a level approach from as far out (two to four miles) as the target could be seen. Airspeed and altitude control were exercised to the highest degree possible, and a bomb was toggled off as the pipper passed through the target. (U)

d. Strike Camera Photography of Fixed Angle Bombing Attacks: In an effort to secure some strike information, a locally manufactured camera pod was mounted on the wing of the aircraft during three of the fixed angle bombing sorties. The pod consisted of a camera, an intervalometer, and a 6-cartridge ejector for M112 photoflash cartridges. The system was activated by the bomb release button simultaneously with bomb release. The intervalometer was set to eject a cartridge and explode it just after bomb impact. Simultaneously, the intervalometer activated the camera to photograph the entire target scene. (Refer to Appendix H for a detailed description of the pod as employed on this test.) (U)

e. Dive Bombing: Five dive bombing sorties were flown with single releases of 500-lb GP bombs. A rectangular pattern was flown on repeated passes. Entry into the dive was made at 12,000 feet. Airspeed at entry was 190-210 knots, power was set at idle, and the dive brakes were extended as the turn onto the target was made. Dive angles were measured at from 25 to 40 degrees. Tracking was accomplished with the Mk 8 Mod 8 or Mk 20 Mod 5 sight set as for gunnery, but the lower edge of the 100-mil ring on the reticle was used as the pipper to allow for trail. Release was made at between 7000 and 4000 feet, depending upon the time required for lining up on the target. Airspeed

Appendix A, Page 6

## SECRET

attained at release varied from 375 to 400 knots, depending upon the angle and time before recovery was made. Recovery consisted of retracting the dive brakes, making a 2 to 2.5 "G" pull-up in a climbing left turn. Full power was added as the nose came through level on the way up. (U)

### 7. VULNERABILITY:

a. Determination of Skin Tracking Characteristics: Two sorties were flown to determine the skin tracking characteristics of the B-57B against GCI Radar (FPS-3) similar to equipment possessed and operated by potential enemy forces. The aircraft was flown at 45,000 feet through a random pattern that brought it through minimum and maximum radar ranges at various bearings from the GCI station. The FPS-3 Radar was used for skin tracking and a concurrent track was made by CPS-6 Radar, employing the APX-6 in the aircraft for positive identification. Blip/scan data and track logs were kept for the entire flight. (S)

b. Determination of Evasive Tactics Against High Altitude Intercept: Four sorties were flown to determine the degree of passive defense available to the B-57B through its maneuverability when attacked by interceptor aircraft at high altitude. F-100 aircraft, singly and in pairs, made repeated attacks against the B-57B. Initial intercept was accomplished with the aid of GCI control, but attacks were made visually. The majority of the runs required the bomber to furnish a straight and level target at .78 Mach. However, on several occasions, the mission was varied to permit the bomber to take evasive action. This consisted of a maximum rate turn until the fighter attack had been obviously thwarted. Turns were initiated, in some cases, at the will of the B-57B pilot; other breaks were not begun until the F-100 called that he was moving into firing range. Gun camera film from the fighter aircraft and objective critiques after each mission furnished the evaluation. (S)

8. PARACHUTE FLARE MISSIONS WITH THE AERO 2A DISPENSER: Three sorties were flown early in the test with the AN/M-26A1 Parachute Flare, presently the sole parachute flare in the USAF inventory. Results were so unsatisfactory that the balance of the flare work accomplished during the test was done with the externally-mounted Aero 2A Flare Dispenser, designed and built by the U.S. Navy for a sonobuoy dispenser. It carries 18 Mk 5 flares of approximately 750,000 candlepower with a burning time

## SECRET

of three minutes. This flare/dispenser combination was flown on seven sorties. Attacks with guns and rockets were made by the light provided. The technique employed was to have the aircraft fly over the target at flare release altitude (3500 feet) and release a string of from two to four flares slightly up wind of the target. The aircraft would then immediately break into a descending turn and set up an attack pattern on the target, firing rockets or guns as desired. (U)

9. SEARCH MISSIONS: Six sorties were flown to investigate search capabilities of the weapons system, with and without artificial illumination. Of the three sorties flown without illumination, one was flown under a full moon, and the other two were with the moon invisible. Searches were conducted in the local area for known targets on local ranges and for airfields (unlighted) on the Eglin Reservation. An attempt was made to locate and identify such targets as aircraft, tanks, vehicles, buildings, road nets, and railroads. On the three missions in which the AN/M-26A1 Parachute Flares were used for illumination the flares were released over a range known to have several targets of a military nature. Flares were released at airspeeds of from 160 to 300 knots, one, two, and three at a time to burst at about 2700 feet. The aircraft would then remain at the release altitude of approximately 4000 feet for the first minute of illumination, then descend below the flare in order to evaluate the search capabilities above and below the flare. (U)

10. PROFILE MISSIONS: Sorties were flown at each of five selected configurations typical of the various combat configurations at which the B-57B can operate. These configurations are as follows:

a. LABS Minimum Altitude Attack: This mission makes the approach flight from base to target at minimum altitude, delivers a special weapon with the LABS technique, runs out at maximum speed, then climbs to 45,000 feet for the return leg, depending on altitude and maneuverability to evade interception. The bomb load carried for this sortie was 1500 pounds. Full internal and external fuel was used, and the wings were clean (without pylons). (S)

b. LABS Long Range Mission: This sort of mission would be used against targets at sufficient range to require near-optimum fuel consumption. The flight plan would involve climbing out to 40,000 feet, cruising to the target area, descending to minimum altitude and making a maximum speed run-in and run-out, climb back to 45,000, and return to the base. The same bomb and fuel loads were used for this mission as were used on the minimum altitude attack. (S)

Appendix A, Page 8

## SECRET

c. Level Bombing with APW-11A/MSQ-1 and S-4 Shoran (40,000-Foot Release): This mission represents the level bombing mission at 40,000 feet, employing either the APW-11A/MSQ-1 System or the S-4 Shoran Bombing System for aiming. A 2500-pound bomb load was carried and released in train, simulating attack with conventional bombs in train or a special weapon. Full fuel loading was used. (U)

d. Level Bombing with APW-11A/MSQ-1 and S-4 Shoran (45,000-Foot Release): This mission was configured identically to the preceding mission. It differs only in that the bomb release is made at 45,000 feet instead of 40,000 feet. This mission would apply to the situation where interception was expected, and to reduce the probability of successful interception. (S)

e. Low Level Attack with Parachute Flares: This mission represents the typical night intruder sortie dispatched to loiter in a potential target area for targets of opportunity. The ordnance load includes 2400 rounds of .50 caliber ammunition and a maximum load of conventional bombs internally, and an Aero 2A Flare Dispenser, seventeen Mark V Parachute Flares, six MA-3 Century Rocket Launchers, and forty-two 2.75" FFA Rockets mounted on the wings. (U)

11. ORDNANCE LOADING: Repeated loadings were accomplished on the various ordnance combinations in order to arrive at times required for each loading operation. In the case of conventional stores, this timing included time to load the door with various stores, time to change the bomb door configuration, time to remount the loaded door, and time to load and check out the various external stores. For the special weapons door, practice loading was accomplished in the manner recommended by the contractor and in the manner devised by APGC armament personnel, and the relative merits of each were compared. (U)

# SECRET

## TEST RESULTS

### 1. FAMILIARIZATION TRAINING:

a. General: As a result of experience gained in the familiarization phase of this test, all assigned pilots were of the opinion that the B-57B is extremely simple to operate, and that it has many desirable performance and handling characteristics for accomplishing the night intruder mission. The performance, visibility, flight instruments, and cockpit lighting in particular are superior to other aircraft utilized in this role in the past. In general, the handling and performance characteristics of the aircraft are satisfactory for all phases of the night intruder mission under normal conditions of flight. (U)

b. Handling: Handling of the B-57B under normal conditions of flight is straightforward and conventional in all respects. However, three points of interest in respect to handling require considerable attention in this aircraft. They are as follows: (U)

- (1) Fuel Management: Proper fuel management in this aircraft is of paramount importance because of the exceptionally fast rate at which the center of gravity and lateral trim can be changed by use of fuel. Since only one tank (No. 2 fuselage) has such critical control of the center of gravity, this tank was turned on at start of engines and left on until a maximum of 2000 pounds of fuel remained before any other tank was selected. This permits a prompt determination of its proper feeding before an unfavorable center of gravity is attained, and provides a steady movement of the center of gravity to a more favorable position. The other undesirable condition, lateral out-of-trim, results when a wing tank or wing tip tank on either side fails to feed when both sides are turned on. Safe landing with one wing tank full and the other empty can be made, but a high landing speed must be used to retain aileron control to touchdown; retention of lateral control at low speeds with one tip tank full and

Appendix B, Page 1

## SECRET

the other empty is doubtful, and landing probably should not be attempted at any speed; tip tanks should be jettisoned prior to landing. In view of the above, it is extremely important that the pilot determine any malfunctions in fuel feeding before the out-of-trim condition becomes advanced. (U)

- (2) Single Engine Operation: Pilots on the OST gave considerable attention to operation of the aircraft on single engine in high-drag and high-power configurations. This investigation included many simulated engine failures and at least three actual single engine landings resulting from precautionary shut-downs. All pilots were of the opinion that the single engine handling and performance characteristics should be stressed in training because of the sharp deterioration of control at low speeds with high power settings. Control effectiveness decreases and control forces increase sharply with asymmetric power, and at a rate that can result in complete loss of control if power is not reduced and airspeed increased. Climbing flight can be sustained as low as 140 knots with use of partial power at light weight in a clean configuration. At low air speeds power sufficient for flight but within the aircraft control range is difficult to maintain and even impossible in some ranges of weight and configuration; therefore, all pilots arrived at a figure of 150-155 knots as "safe single engine speed." (U)
- (3) Control Forces: All pilots commented on the high control forces experienced at high indicated airspeeds. The rudder control appears to be the least affected. The aileron and elevator forces at airspeeds above 350 knots are high enough to reduce maneuverability considerably; this is particularly noticeable in low level attack maneuvers requiring even two to three "G" maneuvering for repeated passes. These control forces become extremely fatiguing for the pilot when sustained for even a few minutes. In the case of the "one maneuver"

Appendix B, Page 2

**SECRET**

effort, as in the LABS delivery, forces are not considered excessive even at maximum speed (434 knots). A pilot can impose the current "G" limit in pull-up from 425-430 knots without use of trim.  
 (S)

c. Takeoff Measurement: All measurements are corrected to the NACA Standard for temperature, pressure, wind direction, and wind velocity.

**TAKEOFF MEASUREMENTS**

CONFIGURATION	TAKEOFF GROSS WT (POUNDS)	TYPE RUNWAY	GROUND RUN	B-26 GROUND ROLL AT SAME % OF MAX GROSS WEIGHT
CLEAN, FULL INTERNAL AND EXTERNAL FUEL. (85% of max gross wt. One measurement.)	45,572	Hard Surface	2800 Ft	2850 Ft
CLEAN, FULL INTERNAL AND EXTERNAL FUEL WITH T-63 PRACTICE UNIT. (91% of max gross wt. Mean of two measurements.)	48,663	Hard Surface	3177 Ft	3500 Ft (Approx)
SAME CONFIGURATION AS LISTED ABOVE (mean of three).	48,663	Pierced Steel	3209 Ft	Over 3500 Ft
FOUR M-116 FIRE BOMBS AND FOUR CENTURY ROCKET LAUNCHERS EXTERNALLY. BOMB LOAD AND FULL FUEL INTERNALLY. (97% of max gross wt. One measurement.)	52,087	Hard Surface	4100 Ft	Over 4600 Ft

Appendix B, Page 3

**SECRET**

In general, pilots did not comply with the takeoff speeds recommended in the Pilot's Handbook. This Technical Order recommends 110 to 120 knots indicated airspeed for takeoff, depending on the gross weight. Pilots on this test were of the opinion that these speeds are unrealistically low and would cause an exaggerated nose high attitude and increased ground run. It is believed that from 5 to 15 knots should be added to these recommended takeoff figures. (S)

d. Landing Measurement: Only two landings were measured. These were measured on the pierced steel runway at extremely heavy landing weights, simulating the emergency condition in which the ordnance load would be jettisoned immediately after takeoff with the aircraft returning for an immediate landing without time to consume much fuel. In order to avoid excessively hard touchdown, the aircraft was flown onto the runway at higher than normal airspeed, maintaining a rate of sink of less than 300 feet per minute. Maximum use of profile drag was made after touchdown by holding the nose off until 75 knots indicated was reached. Moderate braking action was then employed to a complete stop. Measurements are presented below:

LANDING MEASUREMENTS

LANDING WEIGHT	TYPE RUNWAY	TOUCHDOWN SPEED (CAS)	LANDING ROLL DISTANCE
41,913 Lb	PSP	125 Knots	4767 Feet
42,513 Lb	PSP	136 Knots	4149 Feet

e. Altimeter Position Error: Significant altimeter position errors were shown in the position error runs. These vary from a minus 500 feet at 434 knots to a minus 30 feet at 200 knots (indicated airspeed at sea level). This information is not available in the current Pilot's Handbook (T.O. 1B-57B-1) but is of primary importance for any aircraft to be used in night operations. (Since only one aircraft was run through the entire position error calibration course, no attempt is made to offer results as accurate for all B-57B's; however, spot checks of other assigned test vehicles at many of the same speeds indicate that the results cited are accurate within a few feet in either direction.)

## SECRET

### 2. LABS "STAND-BY" MISSIONS:

a. It was determined that the LABS maneuver is well within the capability of the aircraft while carrying a special weapon. Heavier loads may be carried on training sorties without noticeable difference to the pilot. The maneuver may be performed readily from level flight at 400 to 425 knots indicated, with 96% to 100% power. (Current acceleration limitation on the aircraft with wing tip tanks installed is 3.4 "G"; all LABS sorties were flown with tips on but empty.) Stick forces are high, but well within limits of the pilot, even without use of trim. Manual use of trim is not recommended because of the extremely rapid rate at which it takes effect at this speed range. As pilots became more proficient in this technique, it was found that less altitude was gained and high airspeeds were sustained throughout the maneuver. Holding 3.4 "G" in the pull-up, about 5000 feet altitude is gained and rollout can be made in level or slightly nose low attitude at 200 to 275 knots indicated airspeed, dependent upon the gross weight. Rollout may be made satisfactorily with rudder and aileron together or with aileron alone. The open door, loaded with any of the stores tossed, did not have any appreciable effect upon the handling or performance of the aircraft. It is recommended that the door be opened prior to commencement of the maneuver, so that both hands may remain on the wheel to control the acceleration smoothly. All stores carried and released separated cleanly from the aircraft. (On practice sorties, five 500-lb GP bombs were carried on the door and released one at a time on successive runs.) (S)

b. Composite scores of the releases made with this technique are presented below. Figure 2 is a reproduction of the track of aircraft and bomb plotted from phototheodolite data made during release of a T-63 Practice Unit. In studying impact data, it will be observed that bombs fell generally to the left of the target. The reason for this could not be determined from available data. However, it is suspected that either precession is occurring in the Attitude Instrument with application of "G" forces, causing the pilot to correct to the left unnecessarily, or the "G" forces applied in the pull-up react on the rotating engine part and cause a gyroscopic effect, resulting in a yaw to the left that is not detected as such by the pilot. (Refer to Figure 2, Page 47.) (S)

Appendix B, Page 5

SECRET

**SECRET**

COMPOSITE SCORES - "STAND-BY" LABS TECHNIQUE

1000-LB GP BOMB RELEASES

RELEASE NUMBER	RELEASE ANGLE	RANGE ERROR	DEFLECTION ERROR	CIRCULAR ERROR	REMARKS
1	82°	2000 OVER	1095 LEFT	2285 FEET	Bombs 1 to 5 were tossed using a point on the ground as a pull-up point. A correction was made after the first two hit long.
2	82°	1260 OVER	834 LEFT	1515 FEET	
3	82°	120 SHORT	242 RIGHT	363 FEET	
4	82°	615 SHORT	867 LEFT	1062 FEET	
5	82°	140 SHORT	1410 LEFT	1420 FEET	

CIRCULAR ERROR AVERAGE: 1329 FEET

500-LB GP BOMB RELEASES

6	87°	769 OVER	1801 LEFT	1959 FEET	Bombs 6 to 10 were tossed to develop a sight setting for the Mk 8 Sight for determination of a pull-up point.
7	87°	1943 SHORT	1703 LEFT	2584 FEET	
8	87°	1912 SHORT	912 LEFT	2118 FEET	
9	87°	1152 SHORT	785 LEFT	1394 FEET	
10	87°	993 SHORT	1339 LEFT	1667 FEET	
11	87°	553 OVER	413 LEFT	690 FEET	Bombs 11 to 15 were tossed with sight setting worked out on previous sortie. (Pilot experimented with trim.)
12	87°	232 SHORT	1128 LEFT	1152 FEET	
13	87°	496 OVER	966 LEFT	1086 FEET	
14	87°	1651 OVER	420 LEFT	1704 FEET	
15	87°	549 SHORT	539 LEFT	769 FEET	
16	87°	1385 OVER	385 LEFT	1425 FEET	Night toss.

(Cont'd.)

**SECRET**

**SECRET**

COMPOSITE SCORES - "STAND-BY" LABS TECHNIQUE, (Cont'd.)

500-LB GP BOMB RELEASES

RELEASE NUMBER	RELEASE ANGLE	RANGE		DEFLECTION		CIRCULAR		REMARKS
		ERROR		ERROR		ERROR		
17	87°	800	SHORT	165	RIGHT	850	FEET	Night toss.
18	110°	46.1	OVER	989	LEFT	1091	FEET	On bombs 18 to 21 pull-up was made over target, bomb released 4 seconds after the gyro precession began.
19	110°	229.1	OVER	1065	LEFT	2526	FEET	
20	110°	121.8	OVER	1529	LEFT	1954	FEET	
21	110°	74.0	OVER	2003	LEFT	2136	FEET	
22	110°	48.5	OVER	1519	LEFT	1595	FEET	Bombs 23 to 25 were tossed from an aircraft which had not yet had its gyro precession angle determined. This mission was for that purpose, but an engine malfunction was encountered during the last two runs.
23	UNKNOWN	194.1	OVER	893	LEFT	2137	FEET	
24	UNKNOWN	60.2	SHORT	969	LEFT	1141	FEET	
25	UNKNOWN	135.9	SHORT	1094	LEFT	1745	FEET	
		CIRCULAR ERROR AVERAGE:				1571	FEET	

T-63 PRACTICE UNIT RELEASE

26	87°	843	SHORT	440	RIGHT	951	FEET
CIRCULAR ERROR AVERAGE FOR ALL SCORED RELEASES: 1284 FEET							

NOTE: Although there were 39 releases, scoring was obtained on only 26 of these releases.

**SECRET**

# LABS MANEUVER, B-57B

ACTUAL PLOT OF AIRCRAFT AND BOMB PATHS  
AS TRACKED BY PHOTOTHEODOLITE

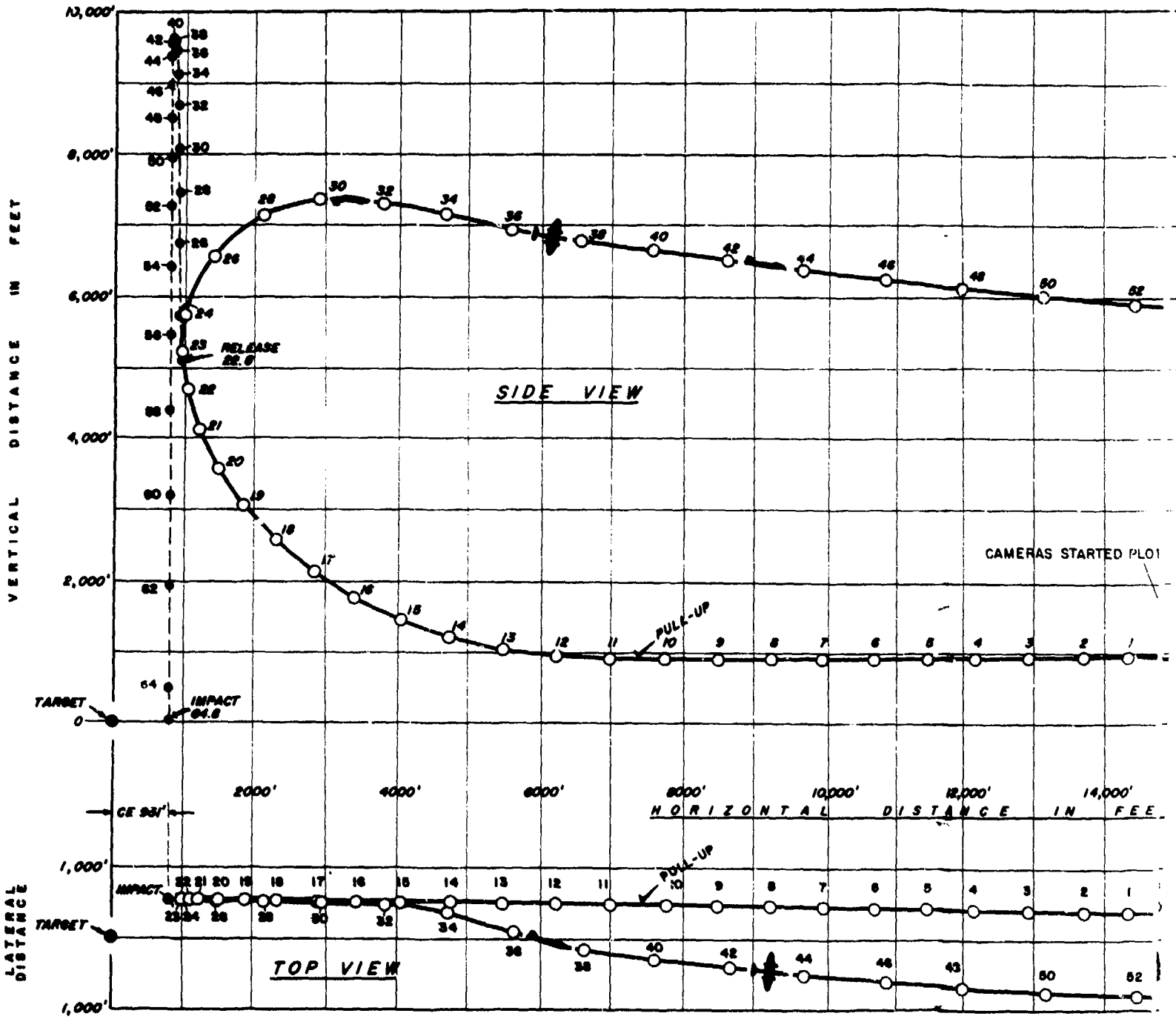

①

R, B-57B  
 ID BOMB PATHS  
 THEODOLITE

**SECRET**

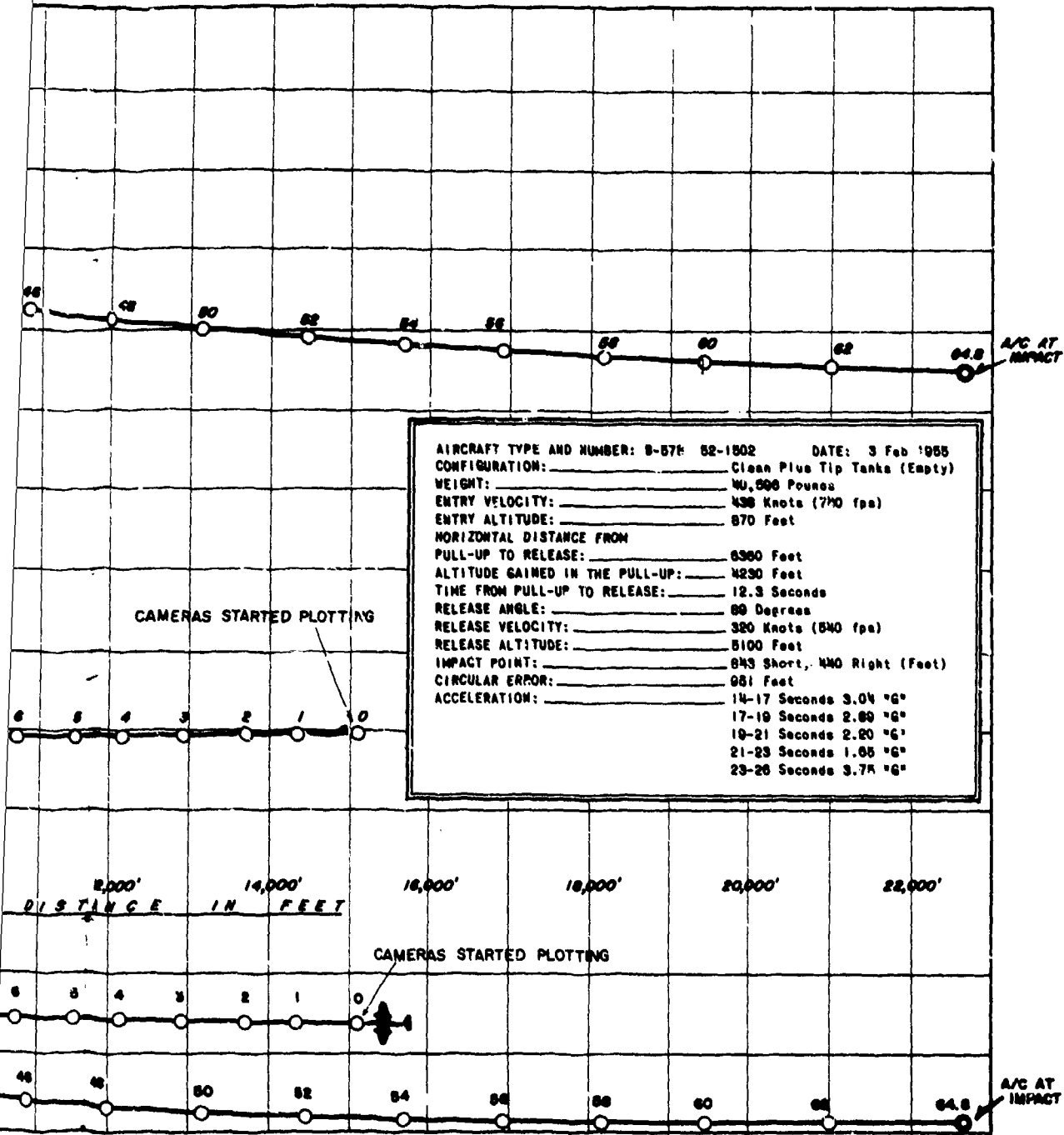

Figure 2 (S)  
 Appendix B, Page 8

(2)

## SECRET

c. Two "dry run" sorties and one "wet run" mission with five releases were made at night. Pilots found that the LABS delivery maneuver can be accomplished more smoothly at night when the air is less turbulent. The large Attitude Indicator and the excellently lighted instrument panel greatly assist in the accomplishment of the maneuver. It must be noted, however, that the requirement for picking up a target some two to four miles (minimum) out for a LABS run-in greatly limits the range of targets applicable to this type of attack at night. Further, since it is fully as hard to locate an IP as it is a target, it follows that the most practical type of LABS delivery at night is the "over-the-shoulder" release which requires no IP. This will permit sighting of the target at the last possible moment, which is generally the case at night, while still retaining the capability to deliver the weapon. (S)

d. There is no accurate means of determining any given angle for a low angle release, employing equipment in the present B-57B cockpit configuration. (S)

### 3. MISSIONS WITH THE MA-2 LABS:

a. The MA-2 LABS as installed in the B-57B for this test increases the overall effectiveness of the LABS attack by providing a more sensitive flight instrument and by providing automatic release at the preselected release angle. (S)

b. Use of the Automatic Trim Control Device in conjunction with the MA-2 LABS greatly simplified the entire maneuver and offered a consistent rate of pull-up for all pilots, a notable deficiency existent in the "stand-by" LABS technique as accomplished on this test. However, use of the automatic trim is also applicable to this latter technique. (Refer to Paragraph 3, Appendix H, for a detailed description of this device.) (S)

c. The importance of effective lighting on the LABS instruments and switches cannot be overemphasized. The installation as mounted in the B-57B for this test was unsatisfactory. The LABS Indicator did not have individual lighting, the "Pickle" light could not be dimmed and blinded the pilot during the approach, the control panel (switches) was not lighted, and the bomb release light also was of the no-dim type and further reduced the pilot's night vision. (S)

Appendix B, Page 9

## SECRET

d. Of the nine missions run with the MA-2 LABS, only one was run at night. It was necessary to light the target in order that it might be seen from as far as two miles out on the approach. (This was accomplished by putting four flare pots atop the target pyramid.) Further, since the finding of an unlighted IP was just as difficult as finding an unlighted target, it was found that the over-the-shoulder attack is the most practicable technique for night LABS. At the same time, when a target was known to be particularly hard to locate, an IP was essential, even for the over-the-shoulder attack. However, this IP was used only as a departure point and not for timing purposes.  
(S)

e. The scores listed on Pages 51 and 52 were obtained by using computed release angles that had not been flight checked for accuracy, and include all scores for the three pilots concerned. Consequently, no conclusion is offered as to the accuracies ultimately obtainable. (S)

**SECRET**

RELEASE NUMBER	ENTRY VELOCITY (GROUND SPEED)		RELEASE ANGLE	RELEASE VELOCITY (GROUND SPEED)		ACCELERATION AT RELEASE (G'S)	RANGE	SCORING ERRORS		ESCAPE DISTANCE
	FT/SEC	KNOTS		FT/SEC	KNOTS			DEFLECTION	CIRCULAR	
1	UNK	UNK	45	UNK	UNK	UNK	20-0	148-R	150 FT	UNK FT
2	UNK	UNK	45	UNK	UNK	UNK	1465-S	62-R	1466	UNK
3	675	400	45	UNK	UNK	UNK	1624-S	815-R	1817	21,200
4	UNK	UNK	110	UNK	UNK	UNK	475-S	1440-L	1510	UNK
5	UNK	UNK	110	UNK	UNK	UNK	190-0	2800-L	2810	UNK
6	UNK	UNK	110	UNK	UNK	UNK	320-0	3520-L	3525	UNK
7	UNK	UNK	110	UNK	UNK	UNK	350-S	1915-L	1960	UNK
8	UNK	UNK	110	UNK	UNK	UNK	1430-S	1025-L	1760	UNK
9	UNK	UNK	110	UNK	UNK	UNK	495-0	990-L	1110	UNK
10	UNK	UNK	110	UNK	UNK	UNK	1490-S	1111-L	1855	UNK
11	680	403	45	620	367	3.7	1830-S	220-R	1750	21,200
12	715	423	45	640	378	3.7	100-S	0	100	23,280
13	715	423	45	640	378	3.7	400-S	400-R	580	25,690
14	685	405	45	635	375	3.7	550-S	100-R	565	25,770
15	715	423	45	650	385	3.8	250-C	300-R	400	26,100
16	710	420	60	590	349	3.5	1000-S	800-L	1300	26,100
17	695	412	60	580	343	3.5	1400-S	600-L	1550	23,780
18	700	414	50	605	356	3.7	1500-S	750-R	1700	25,570
19	710	420	60	610	361	3.7	1125-G	400-R	1200	26,930
20	695	412	60	610	361	3.8	975-S	475-R	1075	26,020
21	700	414	110	480	284	3.5	220-0	1050-L	1110	UNK
22	740	438	110	490	290	3.5	490-S	450-L	650	UNK
23	740	438	110	490	290	3.6	850-S	500-L	950	16,570
24	710	420	110	490	290	3.5	UNK	UNK	UNK	13,370
25	720	426	110	500	296	3.8	1125-S	850-L	1450	13,310
26	740	438	110	480	284	3.0	50-S	800-L	805	13,190
27	730	432	110	480	284	3.1	100-0	1225-L	1230	15,765
28	730	432	110	480	284	3.5	250-S	800-L	850	13,220
29	720	426	110	500	296	3.5	890-S	700-L	1000	16,190
30	730	432	110	510	302	3.8	1050-S	1075-L	1500	14,790
31	715	423	110	480	284	3.5	1200-0	1625-L	1975	14,590
32	715	423	110	480	284	3.5	220-0	200-L	300	13,400

Appendix B, Page 11

**SECRET**

RELEASE NUMBER	ENTRY VELOCITY (GROUND SPEED)		RELEASE ANGLE	RELEASE VELOCITY (GROUND SPEED)		ACCELERATION AT RELEASE (G'S)	RANGE	SCORING ERRORS		ESCAPE DISTANCE
	FT./SEC.	KNOTS		FT./SEC.	KNOTS			DEFLECTION	CIRCULAR	
33	720	426	110	480	284	3.7	140-0	400-L	450	14,300 FT
34	725	429	110	490	290	3.7	573-S	690-R	900	15,550
35	715	423	110	510	302	3.9	150-S	3450-L	3500	14,400
36	730	432	90	500	296	3.0	540-S	800-L	965	19,700
37	735	435	90	500	296	3.0	225-S	890-L	920	22,850
38	730	432	90	510	302	3.3	650-S	450-L	800	20,000
39	735	435	90	500	296	3.2	1250-S	75-L	1255	23,030
40	735	435	90	500	296	3.2	975-S	200-R	995	21,850

Appendix B, Page 12

**SECRET**

**SECRET**

The following table shows basic information for planning purposes, utilizing data obtained on the maneuvers scored above. In all cases the data is based on an entry airspeed of 420 knots (Ground Speed - 710 feet per second) and an entry altitude of 1000 feet above the terrain.

PULL-UP DATA AND COMBINED SCORES FOR LABS IN THE B-57B

TYPE OF RELEASE	CEP	CEA	PULL-UP	HORIZONTAL RANGE COVERED IN THE PULL-UP	ALTITUDE GAINED AT RELEASE	RELEASE VELOCITY (FT/SEC)	HORIZONTAL RANGE COVERED BY BOMB AFTER RELEASE
45-degree	1488 ft	1433 ft	4475 ft	1650 ft	640	13,700 feet	
60-degree	1300 ft	1365 ft	5090 ft	2390 ft	610	10,775 feet	
90-degree	965 ft	987 ft	5830 ft	4110 ft	600	0 feet	
110-degree	975 ft	1191 ft	5700 ft	4870 ft	480	5,950 feet	

OVERALL CIRCULAR ERROR AVERAGE (CEA) 1279 feet

OVERALL CIRCULAR ERROR PROBABLE (CEP) 1137 feet

**SECRET**

**SECRET**

4. S-4 SHORAN RESULTS:

a. Discussion of Mission Procedures:

- (1) A detailed SOP for operating the S-4 Shoran system was presented in the Interim Report on the Operational Suitability Test of the B-57B, Project No. APG/TAS/119A. This procedure was prepared with the assistance of the S-4 Shoran OST Project Team and was utilized on all Shoran missions during this test. (U)
- (2) Initial efforts with the PDI Instrument showed that it requires considerable practice to use successfully for remaining on the arc, and that it cannot be used without some voice assistance from the operator when very small corrections are required. As a result of these findings and the limited amount of time available for training with the Shoran system, all bombing runs were made with the operator talking the pilot onto the arc. (U)
- (3) In order to obtain as much data as possible from each sortie, individual releases were made of the five bombs on consecutive runs. This resulted in considerably more set operation on any given sortie than would be normally expected on a combat mission in which only one run with a train release would be required. (U)
- (4) Only one S-4 Shoran set with the capability for bombing at 40,000 feet was available in the four assigned test vehicles. (S)

b. Mission Summary: A composite record of all sorties flown with the S-4 Shoran system is presented on the following page. (S)

Appendix B, Page 14

**SECRET**

<b>SORTIE NUMBER</b>	<b>FLYING TIME</b>	<b>BOMBS RELEASED</b>	<b>MISSION ALTITUDE</b>	<b>PERCENT SUCCESS</b>	<b>REMARKS*</b>
1	1:05		6,000	0	Equipment check.
2	1:55		6,000	100	Equipment check.
3	2:15		6,000	100	Equipment check.
4	1:35	1	6,000	20	Poor crew coordination.
5	2:05	5	6,000	100	One bomb not scored.
6	1:10	0	10,000	0	Crew coordination and set malfunction.
7	1:50	0	10,000	0	Set and ground station malfunction.
8	2:15	0	20,000	0	Transmitter failure.
9	2:10	5	6,000	100	Two bombs not scored.
10	1:30	3	10,000	60	Indicator failure.
11	2:30	0	40,000	0	Transmitter failure.
12	2:20	0	40,000	0	Crew coordination. Station failure.
13	2:35	3	40,000	60	K-4 Computer failure. Only one bomb scored.
14	3:00	0	40,000	0	Transmitter failure.
15	3:10	5	40,000	100	
16	3:20	0	40,000	0	Station, transmitter, indicator failure ex- perienced during mission.
17	3:40	1	40,000	100	Receiver and transmitter failure. Bomb not scored.
18	3:15	4	40,000	100	Only four bombs loaded.

TOTAL FLYING TIME: 41:40

TOTAL BOMBS RELEASED: 27

TOTAL BOMBS SCORED: 21

(\* Malfunctions noted are tentative in nature; positive conclusions were not possible in all cases.)

Appendix B, Page 15

**SECRET**

c. Scores: The scores below include all bombs scored. Several bombs could not be scored due to failure of the spotting charges or other reasons. (S)

S-4 SHORAN SYSTEM BOMBING SCORES

<u>SORTIE NUMBER</u>	<u>TAS</u>	<u>RELEASE ALTITUDE</u>	<u>ERROR RANGE</u>	<u>ERROR DEF.</u>	<u>CIRCULAR ERROR</u>
4	450	6,000	-655	- 285	714
5	425	20,000	-350	+1585	1685
	425	20,000	+175	+1485	1460
9	427	19,960	-570	- 460	730
	427	19,960	-360	- 425	550
	375	6,000	-325	+ 190	375
	375	6,040	+205	- 210	294
	375	6,000	-445	- 160	473
10	374	10,050	-375	- 505	629
	375	9,980	-515	- 315	604
	373	9,960	-300	- 310	432
13	425	40,000	+180	+ 225	289
15 (Train Release)	425	40,000	+120	+ 690	700
	425	40,000	+250	+ 650	N/A
	425	40,000	+330	+ 575	N/A
	425	40,000	+555	+ 727	N/A
	425	40,000	+815	+ 650	N/A
18	425	40,000	+1800*	+ 240*	1820
	425	40,000	-1620*	+3060*	3450
	425	40,000	-1860*	+ 180*	1870
	425	40,000	-1800*	-0*	1800

\*These four impacts are radar scored with an accuracy of ±600 feet.

d. Summary of Results:

(1) Malfunctions:

(a) Malfunctioning of some element of the Shoran system (airborne or ground support) prevented bombs from being released on seven of the fifteen sorties on which they were carried. This is a reliability rate of 53.3%. (S)

## SECRET

- (b) Only two sorties could be completed as planned (single releases of the bomb load on consecutive runs) before some malfunction occurred. (S)
  - (c) Some delays were encountered through malfunctioning of safety monitoring equipment (independent of the Shoran system), but no missions failed directly as a result of these malfunctions. (U)
- (2) The limited number of bombs that were released and scored denied valid information on the capabilities of the S-4 Shoran bombing system. (U)
  - (3) The S-4 Shoran bombing mission requires a very great degree of crew coordination. (U)

### 5. APW-11A/MSQ MISSIONS:

a. General: The APW-11A/MSQ type bombing missions flown encountered a minimum of difficulty with the basic components of the system, and this sort of bombing appears to offer some promise within its line-of-sight range. Of the 14 sorties flown, releases were made on only six. All drops were made on a target only thirteen statute miles from the ground station. These failures occurred mainly as a result of problems involved with safety monitoring drops from extreme altitude. Only two malfunctions were experienced with the basic system normally employed in combat. There are two outstanding defects in the system as employed during this test. First, the MSQ equipment utilized on this test is not equipped to furnish the ten-second countdown prior to bomb release; this results in a slight delay at bomb release due to the pilot's reaction time. Secondly, the only capability in the present ground equipment for releasing a T-63 Practice Unit or comparable special weapon consists of a manual release by the pilot, similar to the technique employed in Korea; ballistic bomb boxes for the ground equipment are not yet available. (S)

b. Scores: The scores recorded on APW-11A/MSQ bomb releases are presented on Page 57. (All releases were made at 420 knots TAS.) (S)

**SECRET**

RELEASE ALTITUDE	RANGE ERROR	DEFLECTION ERROR	CIRCULAR ERROR
40,000 Ft	190 SHORT	625 LEFT	650 FEET
40,000 Ft	270 SHORT	3°0 RIGHT	480 FEET
40,000 Ft	1035 OVER	125 LEFT	1050 FEET
40,000 Ft	23 OVER	56 LEFT	61 FEET
40,000 Ft	71 OVER	114 LEFT	134 FEET
	CIRCULAR ERROR AVERAGE FOR 40,000:		435 FEET
45,000 Ft	630 OVER	650 LEFT	905 FEET
45,000 Ft	370 SHORT	550 LEFT	655 FEET
45,000 Ft	70 OVER	275 RIGHT	300 FEET
45,000 Ft	555 SHORT	872 LEFT	1037 FEET
45,000 Ft	349 SHORT	220 RIGHT	410 FEET
45,000 Ft	192 OVER	635 LEFT	665 FEET
45,000 Ft	832 SHORT	189 LEFT	850 FEET
45,000 Ft	242 OVER	1742 LEFT	1765 FEET
	CIRCULAR ERROR AVERAGE FOR 45,000:		824 FEET

c. Antenna Test Patterns: Test patterns from the APW-11A Antenna at 45,000 feet are shown in Figure 3. (Patterns made at lower altitudes may be seen in the Final Report on Project No. APG/TAS/122A, "OST of the RB-57A Aircraft.") (S)

**SECRET**

**APW-11A ANTENNA PATTERN  
FOR B-57B AT 45,000 FT.**

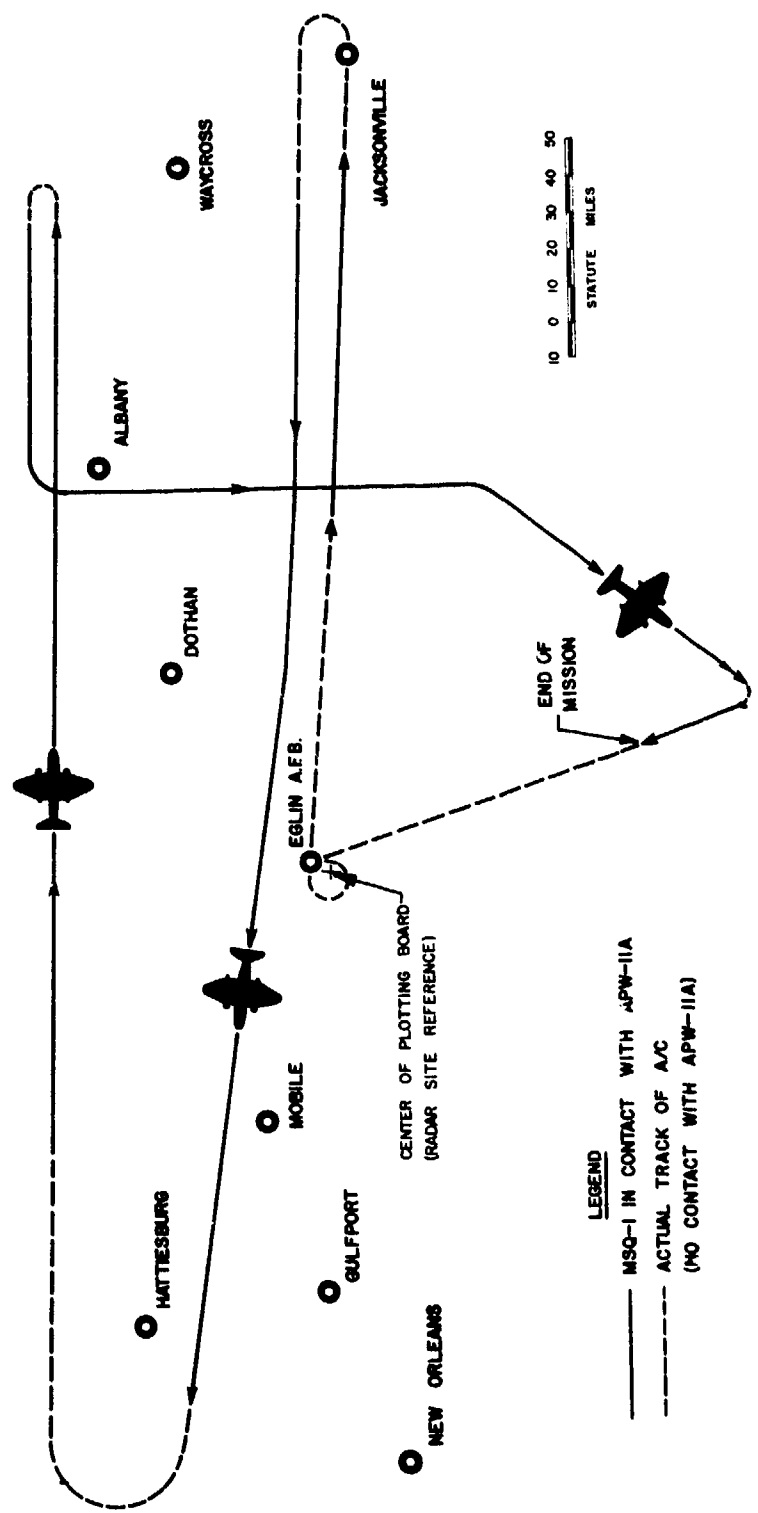

Figure 3 (S)

Appendix B, Page 19

58  
**SECRET**

## SECRET

d. T-1 Partial Pressure Suit: The one sortie flown with this suit was sufficient to show its severe limitations on the operation of the aircraft by the pilot. The suit is excessively restrictive and uncomfortable, and the locally manufactured arrangement for adapting the suit to the B-57B was so cumbersome that it would have made ejection from the aircraft somewhat doubtful. In general, the pilot was able to accomplish all basic control movements (throttles, dive brakes, and flight controls) with relative ease; however, his vision was restricted severely and he could not actuate the armament control switches in preparation for a bombing run. As a result of these glaring defects and the lack of a standard installation in the B-57B, no further testing of this equipment was done during the OST. Further, this limitation prohibited a complete investigation of the capabilities of the B-57B at maximum operating altitudes. (S)

### 6. LOW LEVEL ATTACK MISSIONS WITH CONVENTIONAL WEAPONS:

a. Gunnery: The B-57B makes a satisfactory ground gunnery platform and its guns make a very effective pattern. The aircraft is extremely sensitive to rudder in passes, but will track the target satisfactorily. Firing of the guns causes so much reticle vibration that the sight becomes useless until firing ceases. Further, the sight is very poor for night work in that it reduces visibility forward (apparently from a slight tint in the reflector glass). It cannot be adjusted without use of an outside light source, and the reticle cannot be reduced in brilliance to a sufficient degree for best night visibility. Recorded scores ranged from 13.8 percent to 24.6 percent against 12-foot by 12-foot panel targets; many targets were burned and knocked down, and most sorties were not meant to be scored. Control of the aircraft in the gunnery pattern is very easy with the exception of dive brake operation. The location of the dive brake switch makes its employment extremely awkward, especially in the extension operation, which requires that the switch be held open for about four seconds. Firing of the guns does not have any detrimental effect on the control of the aircraft normally; however, unbalanced firing will cause noticeable yaw. When this unbalanced condition is at its worst, i.e., all guns out on one wing and all guns firing on the other wing, the yaw is sufficient to destroy accuracy completely on short bursts. (U)

b. Rocketry: All rocketry was accomplished with either MA-1 or MA-3 Century Launchers firing seven 2.75-inch FFA Rockets each. Some modification is required to adapt the system to these launchers.

**SECRET**

since the rocket circuitry in the B-57B was intended primarily for the obsolescent 5-inch HVAR type rockets. (Refer to Paragraph 5, Appendix H, for a description of these modifications.) Once these modifications were accomplished, all missions were fired with 100% fire-out rates. The rockets appear to be much more accurate than the old 5-inch rockets and are not greatly dispersed on impact if dive angles of 30 to 40 degrees are used. Flatter dive angles will cause the rockets to disperse excessively. Again, in rocketry just as in the gunnery attack, the rudder is very sensitive and hasty corrections are not easily made. (C)

c. Fixed Angle Bombing: This type of attack can be accomplished in the B-57B, but there are many overly critical factors that severely limit its applicability to the night intruder mission. Altitude and airspeed control are of primary importance and must be held within extremely small tolerances to assure desirable accuracies. The limit to the angle of depression of the Mk 8 Mod 8 Sight, caused by the reflector striking the windshield, precludes aiming with this sight at airspeeds lower than 350 knots or altitudes above 2000 feet; the sight cannot be depressed enough to bear on the target at the required release point. Safe release altitudes of the stores intended for this technique (500-pound GP bombs or 260-pound fragmentation bombs) is 1500 feet. Consequently, the range of applicability for this attack lies between 1500 and 2000 feet above the ground only. Further, it is necessary that the target elevation be known. Airspeed can be controlled satisfactorily, provided a long enough run-in is made. However, many night targets are not visible at such a range as to permit a well-stabilized approach. In addition, light to moderate turbulence causes fluctuations of plus or minus 10 knots and 100 feet in the airspeed indicator and the altimeter, respectively. Scores obtained on the 18 bombs scored are presented below: (C)

FIXED ANGLE BOMBING SCORES

<u>RELEASE NUMBER</u>	<u>RANGE ERROR</u>	<u>DEFLECTION ERROR</u>	<u>CIRCULAR ERROR</u>
1	190 OVER	185 RIGHT	265 FEET
2	90 OVER	30 LEFT	100 FEET
3	585 OVER	30 RIGHT	590 FEET
4	90 OVER	220 RIGHT	240 FEET
5	660 OVER	60 RIGHT	665 FEET
6	140 OVER	20 LEFT	145 FEET
7	40 OVER	90 RIGHT	100 FEET

Appendix B, Page 21

Cont'd.

**SECRET**

**FIXED ANGLE BOMBING SCORES, Cont'd.**

RELEASE NUMBER	RANGE ERROR	DEFLECTION ERROR	CIRCULAR ERROR
8	205 SHORT	165 RIGHT	265 FEET
9	5 OVER	10 RIGHT	12 FEET
10	300 OVER	140 RIGHT	320 FEET
11	70 SHORT	160 RIGHT	140 FEET
12	180 SHORT	60 RIGHT	240 FEET
13	170 SHORT	90 RIGHT	180 FEET
14	370 OVER	55 LEFT	380 FEET
15	935 SHORT	260 LEFT	940 FEET
16	385 SHORT	222 LEFT	(NIGHT) 270 FEET
17	450 SHORT	222 LEFT	(NIGHT) 550 FEET
18	315 SHORT	58 RIGHT	(NIGHT) 185 FEET
CIRCULAR ERROR AVERAGE, 18 RELEASES:			322 FEET
CEA, 14 DAY RELEASES:			260 FEET
CEA, 4 NIGHT RELEASES:			536 FEET

e. Dive Bombing: Dive bombing scores were not impressive. It was found that the aircraft handled well in all phases of the maneuver with the exception of the target tracking. Considerable difficulty was experienced in tracking in almost all wet and dry runs. The aircraft trimmed accurately in the dive, and the bombs seemed to fall where the sight indicated they would. However, lateral corrections with rudder and aileron seemed ineffective. Of the nine bombs scored, only one satisfactory sight picture was obtained; on this particular run the aircraft was rolled out onto the target, and no correction was necessary. Due to the limited scores available, it is considered that these results are not conclusive. Scores are presented on Page 62. (C)

Appendix B, Page 22

**SECRET**

**DIVE BOMBING SCORES**

<u>RELEASE NUMBER</u>	<u>RANGE ERROR</u>	<u>DEFLECTION ERROR</u>	<u>CIRCULAR ERROR</u>
1	20 OVER	80 RIGHT	85 FEET
2	150 OVER	220 LEFT	270 FEET
3	30 OVER	240 LEFT	245 FEET
4	0 OVER	20 LEFT	20 FEET
5	169 SHORT	246 LEFT	298 FEET
6	89 OVER	120 LEFT	149 FEET
7	296 SHORT	277 LEFT	405 FEET
8	156 SHORT	224 LEFT	272 FEET
9	393 SHORT	424 LEFT	577 FEET

CIRCULAR ERROR AVERAGE, DIVE BOMBING: 258 FEET

The Aural Altimeter Signal, described in Paragraph 8, Appendix H, was used on some dive bombing passes to signal release altitude. The set was selected to 5000 feet, and when the aircraft passed through this altitude, the aural signal sounded its tone. This permitted the pilot to concentrate on lining up visually, since the aural signal indicated when the release altitude had been attained. On all passes the Aural Signal came on within 100 feet of the selected altitude. This type of signal can be of definite assistance in dive bombing. (C)

f. Mk 20 Mod 5 Gun Sight Installation: Severe limitations of the Mk 8 Mod 8 Sight, as installed in the B-57B, prompted an early search for a more versatile and more effective sight. A Mk 20 Mod 5 Gun Sight (much refined version of the Mk 8) was secured on loan from the United States Navy and installed in one test vehicle. This sight did not offer any increase in accuracies against any target that was to be seen through either sight; however, the Mk 20 has several features that permit more targets to be seen through it than can be seen through the Mk 8, and it is easier to operate. The most obvious improvements include: (U)

- (1) Self-contained Night-Twilight-Day Reticles that can be selected simply by turning a knob.
- (2) Relocation of the adjusting knob and setting index to permit easier reading and operation.

Appendix B, Page 23

## SECRET

- (3) Less bulky profile, reducing the obstruction to forward vision through the windshield.
- (4) Full travel of the reflector glass without striking the windshield.

The Mk 20 Mod 5 Sight retains the severe reticle vibration experienced during gunnery with the Mk 8, and it also obscures forward vision with its tinted glass reflector. Further, for night adjustments of the sight settings, it is necessary to use an outside light source; there is no self-contained light in the sight for illuminating the index. A complete description of the Mk 20 Mod 5 and its installation in the B-57B is given in Paragraph 6, Appendix H. The same three reticles that are installed simultaneously in the Mk 20 Mod 5 Sight are interchangeable for use with the Mk 8 Mod 8 Sight also, but only one may be installed for any one sortie. These reticles may be obtained through the United States Navy Bureau of Ordnance and are listed under the following stock numbers: (C)

- |     |                |  |
|-----|----------------|--|
| (1) | J942-R-601-300 | Reticle (Type delivered with aircraft) |
| (2) | J942-R-601-515 | Reticle Day & Night (Twilight)         |
| (3) | J942-R-601     | Reticle (Night)                        |

### 7. VULNERABILITY IN RADAR-DEFENDED AREAS AT HIGH ALTITUDE:

a. Determination of Skin Tracking Characteristics: Skin tracking characteristics of the B-57B are sufficient to provide almost continuous contact by an effective radar net of the FPS-3, CPS-6, or equal equipment at all operational altitudes. (For a more detailed discussion of this phase, refer to Project No. APG/TAS/122A "OST of the BB-57A Aircraft".) (S)

b. Determination of Evasive Tactics Against High Altitude Intercept:

- (1) A complete lack of defensive armament and a relatively low speed limit the defensive efforts of the B-57B to maneuvering to avoid firing passes. The aircraft is adequately equipped to outmaneuver any USAF fighter-interceptor at 40,000 to 45,000 feet for a sufficient period of time to avoid a firing pass. Turns in excess of six degrees per second (double needle width) can be entered from cruising speed and

Appendix B, Page 24

## SECRET

sustained for 180 degrees or more with ease. These turns may be accomplished with a full bomb load (2500 pounds) and with more than half of a full fuel load remaining. Such a turn is adequate to thwart a firing pass if commenced in time. Almost all attacks made by the F-100 resulted in stern chases even with the bomber straight and level. In all cases of attacks in clear skies, the bomber crew could sight the fighter several minutes before it could commence an attack; the contrails left by all fighters encountered at 40,000 to 45,000 feet were visible for as far as 80 miles (measured by GCI). However, if the fighter were to be able to approach the bomber from the blind spot, low and behind, there can be no warning to the bomber crew since the B-57B has no tail warning capability. This applies also to the lead-collision attack or any attack if contrails cannot be seen to warn of the approach of the fighter. In one series of intercepts the bomber was flown in a deck of very thin cirrus clouds, thin enough to be barely noticeable from the ground, but sufficient to greatly reduce sighting ranges. The bomber crew often could not see the fighter even when his range was given at less than three miles. This is similar to the night or all-weather intercept and graphically points out the requirement for a warning system in the B-57B. (S)

- (2) Only four attacks were made by two fighters in coordination. However, this technique did not appear nearly so effective as it is at lower altitudes because of the inherent lack of maneuverability of the interceptors. The extreme radius of turn and the resulting lulls between attacks make effective coordination extremely difficult and usually reduced the attacks to independent passes that could have been dealt with as such. A sustained attack by more than two or three interceptors against a B-57B would necessarily prevent successful accomplishment of a mission. By forcing the bomber into continuous evasive action, the interceptors could prevent an accurate run-in and release of stores from these altitudes; on the other hand,

Appendix B, Page 25

## SECRET

## SECRET

if the bomber persisted in straight and level flight for a bomb run, he would become extremely vulnerable to attack from the rear quarter by the faster interceptors. (S)

- (3) Passes by the F-100 were made at Mach numbers varying from subsonic to 1.5 Mach. Frequently, the shock wave from the interceptor was sufficient to strike the bomber quite sharply. On one occasion the accelerometer in the B-57B recorded plus 10 and minus 5 "G" (maximum limits of instrument) from the resulting displacement by the shock wave. Readings of plus five and minus two were about average. This disturbance lasts for a very short period, however, and is believed to be of no particular significance in its present magnitude. Low altitude, high speed flight in even moderate turbulence is much more severe from the pilot's standpoint. (S)
- (4) This series of sorties re-emphasized the need for a rear view mirror in both cockpits. Such a mirror is desirable as a means of quick, visual communication since each crew member could see the other's face in the mirror. This assists materially in the conduct of all missions, but the mirror would be of even greater importance for clearing a large part of the "blind" spot to the rear when aerial interception is a probability. (S)

8. PARACHUTE FLARE MISSIONS WITH THE AERO 2A DISPENSER: The Aero 2A Dispenser proved to be an excellent way of providing a multiple flare capability at the cost of only one external station. Slight modification to the aircraft wiring was required to accommodate the dispenser; however, its installation and loading were very simple. It was found that reliability was almost directly proportional to the care used in loading and operating the dispenser; there are many ways in which the dispenser can be caused to malfunction. The outstanding disadvantage to the employment of this device for use on the B-57B is its effect upon the performance of the aircraft. The dispenser is limited, structurally, to 350 knots indicated airspeed, and its overall drag reduces the range of the aircraft substantially. Further,

## SECRET

when a dispenser is mounted on one wing only, there is insufficient aileron trim to trim out the out-of-balance condition resulting. The Mk 5 Parachute Flares are adequate for attack against most targets, provided they are dropped accurately. However, they are of such weak illuminating power that a minimum of two or three must be used at one time, and they must be dropped within a few hundred yards of the target if it is to be seen. This minimizes their effectiveness as a searching illuminant, since too little area is illuminated. The flares last approximately three minutes, and if the overall attack, from release of flares to release of ordnance, is well planned and executed, this is of sufficient duration to permit two firing passes against a target. A description of the Aero 2A Flare Dispenser including the necessary modifications to the B-57B for mounting, and operating the dispenser, is given in Paragraph 7, Appendix H. (U)

### 9. SEARCH MISSIONS:

#### a. Search With the AN/M-26A1 Parachute Flares:

- (1) The first sortie was completely successful in that all flares released and functioned satisfactorily at approximately 300 knots. The illumination provided was sufficient to permit recognition of the tank, bunkers, buildings, and panel targets on the range. (S)
- (2) The second sortie was unsuccessful and no flares were released. One flare apparently broke off in flight and another popped its chute container, permitting the stabilizing sleeve to come out in the slip stream. The pilot did not exceed 300 knots with the door open during this flight. (S)
- (3) The third sortie was also completely unsuccessful in that only four flares functioned, and they burst too low to permit search. One flare was a lighted streamer, and the other 15 were complete duds. Releases were made at 260 knots to 160 knots. After returning to the base, the aircrew discovered that one entire parachute and stabilizing sleeve were entangled in the bomb door fittings. Apparently the candle and hood assembly had broken free. The

Appendix B, Page 27

## SECRET

crew was not aware that this malfunction had occurred, and consequently not aware of the airspeed at which the flare had been released. (S)

b. Search Without Artificial Illumination: The success attained on this series of sorties varied with the amount of illumination available from natural sources. Airfields with hard surface runways could be found with comparative ease, as could roads and railroads where prominent cut or fill scars existed. However, targets of opportunity that were dark (tanks, vehicles, small buildings, and bunkers) could not be located with acceptable ease even in the full moonlight. Lighted vehicles or buildings are readily discovered, and once such a light is seen it is sometimes sufficient to permit location of its sources even though the light is extinguished immediately. Visibility from the B-57B canopy and the excellent cockpit lighting increase the effectiveness of the aircraft's search capability over that of the B-26 to some extent. (S)

### 10. PROFILE MISSIONS:

a. Profile Charts: Profile charts for each of the configurations flown for this phase were prepared from the data obtained and are presented in Inclosures 1 through 5, this Appendix. The 45,000-foot ceiling was imposed by the lack of the necessary fittings for use of the T-1 Partial Pressure Suit in the B-57B. Performance of the aircraft at 45,000 feet and data obtained with the RB-57A aircraft on Project No. APG/TAS/122-A indicate that operation at altitudes well above 45,000 feet at operational weights is possible. (S)

b. General: Several of the defects that appeared to be minor during short flights assumed major importance during the course of longer radius-of-action missions. Some of these are capable of causing a mission to fail and all are capable of reducing the effectiveness of a mission. The results of these defects are discussed below:

- (1) The two crew members become unnecessarily fatigued after more than two or three hours in the B-57B because of the poorly designed seats. (U)
- (2) The windshield frosted over completely during maximum rate of descents from high altitudes and required a minimum of two to four minutes of flight at high RPM to clear. (C)

## SECRET

- (3) Fuel valves on one or more of the internal wing tanks or the No. 2 Fuselage tank often stick closed at high altitudes, requiring a descent to let them open. (U)
- (4) Cabin temperatures could seldom be adjusted to suit both the pilot and the observer simultaneously because neither seat position has any independent control over the volume and direction of flow of the ventilating air entering that position. (U)
- (5) The frequent checks of each other's condition while flying at altitude become burdensome on the crew members because they have to interrupt their work to transmit. As a result, checks are not made with the frequency they should be over a long mission. Installation of a "hot-mike" system and a rear view mirror in the front cockpit would solve this problem in a desirable way. (U)
- (6) The aircraft trims fairly accurately in all normal flight conditions; however, minor displacements from turbulence or shifting fuel weights require a constant attention to trimming, especially about the lateral axis. It usually happens that one wing tip tank will feed faster than the other, resulting in an out-of-trim condition that cannot be trimmed out with aileron. The resulting requirement for the pilot to hold in aileron against this uneven weight is an undesirable strain on the pilot, especially in night or in bad weather. (U)
- (7) The pilot cannot accomplish note-taking or any other work requiring accurate marking with a pencil in flight because of the cockpit arrangement and the restrictive shape of the seat. (U)

11. ORDNANCE LOADING: In this portion of the report only that data relating to the times involved for the various loads are considered. For detailed loading procedures, refer to Appendix E.  
(U)

Appendix B, Page 29

## SECRET

### a. Loading of Special Weapons:

- (1) With the contractor-recommended (handling ring) technique, approximately two and one-half hours are required to mount a T-63 Practice Unit on the aircraft. This includes the check-out of the T-79 (T-145) Control Box. (S)
- (2) With the F-4 Dolly technique as practiced at APGC the T-63 Practice Unit can be loaded in less than one hour, including the T-79 (T-145) Box check-out. (S)

### b. Turnaround Times for Internal Stores:

- (1) With Preloaded Bomb Doors: Since the bomb configuration has nothing to do with the amount of time required for mounting a bomb door on the B-57, empty and loaded remounting times are the same, i.e., ten minutes. (S)
- (2) Without Preloaded Bomb Doors: If the same door has to be turned around with the aircraft, then turnaround times increase sharply. Approximate figures are as follows: (S)

- (a) To dismount the bomb door from the aircraft . . .

10 - 15 minutes

- (b) To load the same ordnance item the door is set up for:

Five 500-lb GP bombs . . .	15 - 20 minutes
Nine 500-lb GP bombs . . .	20 - 25 minutes
Four 750-lb GP bombs . . .	30 - 35 minutes
Four 1000-lb bombs . . . .	15 - 20 minutes
Twenty-one 260-lb Fragmentation Bombs . . .	90 minutes

- (c) To change bomb door configuration (add to loading time):

Appendix B, Page 30

# SECRET

From five 500-lb GP's  
to 21 Frags . . . . . 150 minutes

From 21 Frags to five  
500-lb GP's . . . . . 150 minutes

From five to nine 500-lb GP's . . . . . 15 minutes

From nine to five 500-lb GP's . . . . . 15 minutes

Other configuration changes  
not involving the 21 stations  
usually require from . . . . 15 - 20 minutes

(d) To remount the door on the  
aircraft . . . . . 10 - 15 minutes

(e) Net turnaround times for internal stores  
without a preloaded door:

1. Minimum (no configuration  
change) . . . . . 35 - 50 minutes

2. Maximum (no configuration  
change) . . . . . 120 minutes

3. Minimum (configuration  
change) . . . . . 60 - 65 minutes

4. Maximum (configuration change)  
4 hrs 30 minutes

c. Turnaround Times for External Stores: Refer to Appendix  
D for detailed loading procedures. (S)

(1) Rocket pods . . . . . 8 - 12 minutes ea

(2) Bombs or M116 Firebomb Tank . . . . . 5 - 10 minutes ea

(3) To change pylons (rocket to bomb) . . . . . 20 - 25 minutes ea

(4) To add pylons (bomb or rocket) . . . . . 10 - 12 minutes ea

Appendix B, Page 31

**SECRET**

d. Loading Personnel: The following breakdown of armament personnel is the desired number for best handling of the ordnance turnaround (special or conventional): (U)

- (1) Weapons Supervisor (46270) . . . . . 1
- (2) Weapons Mechanic (46250) . . . . . 4
- (3) Munitions Specialist (46150) . . . . . 5

**SECRET**

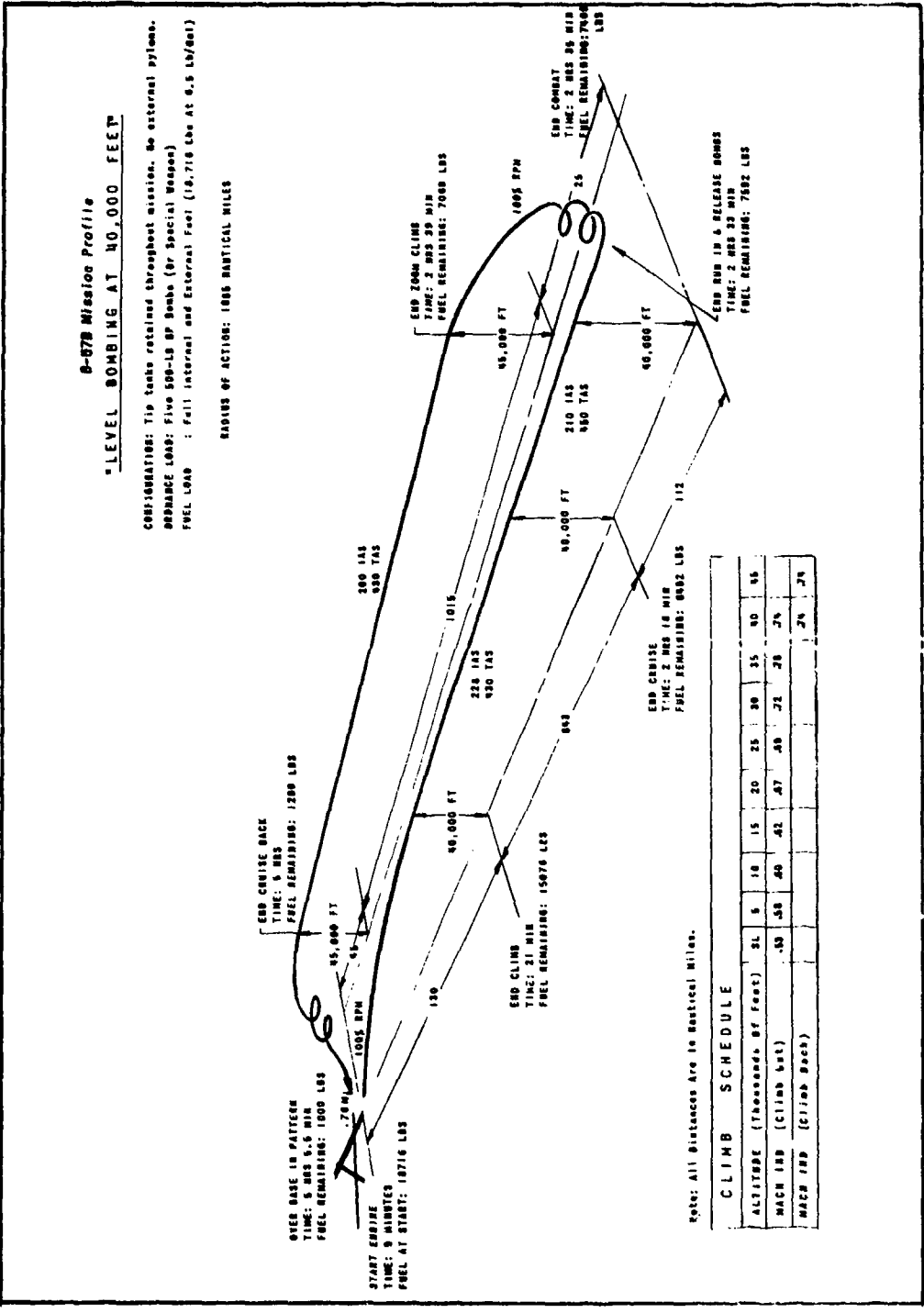

Appendix B, Page 33

Inclosure I (S)

**SECRET**

**SECRET**

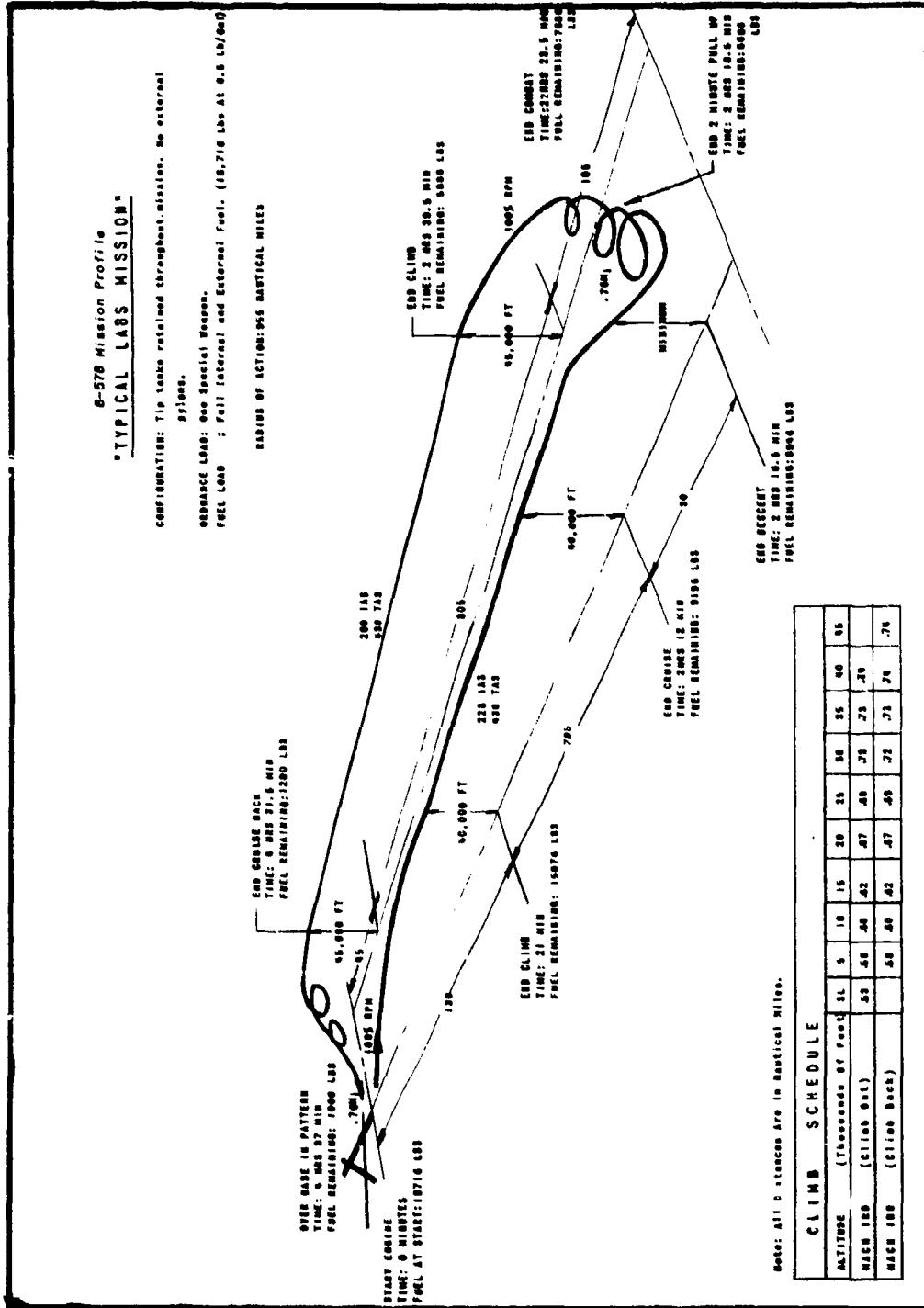

Appendix B, Page 34

Inclosure II (S)

**SECRET**

**SECRET**

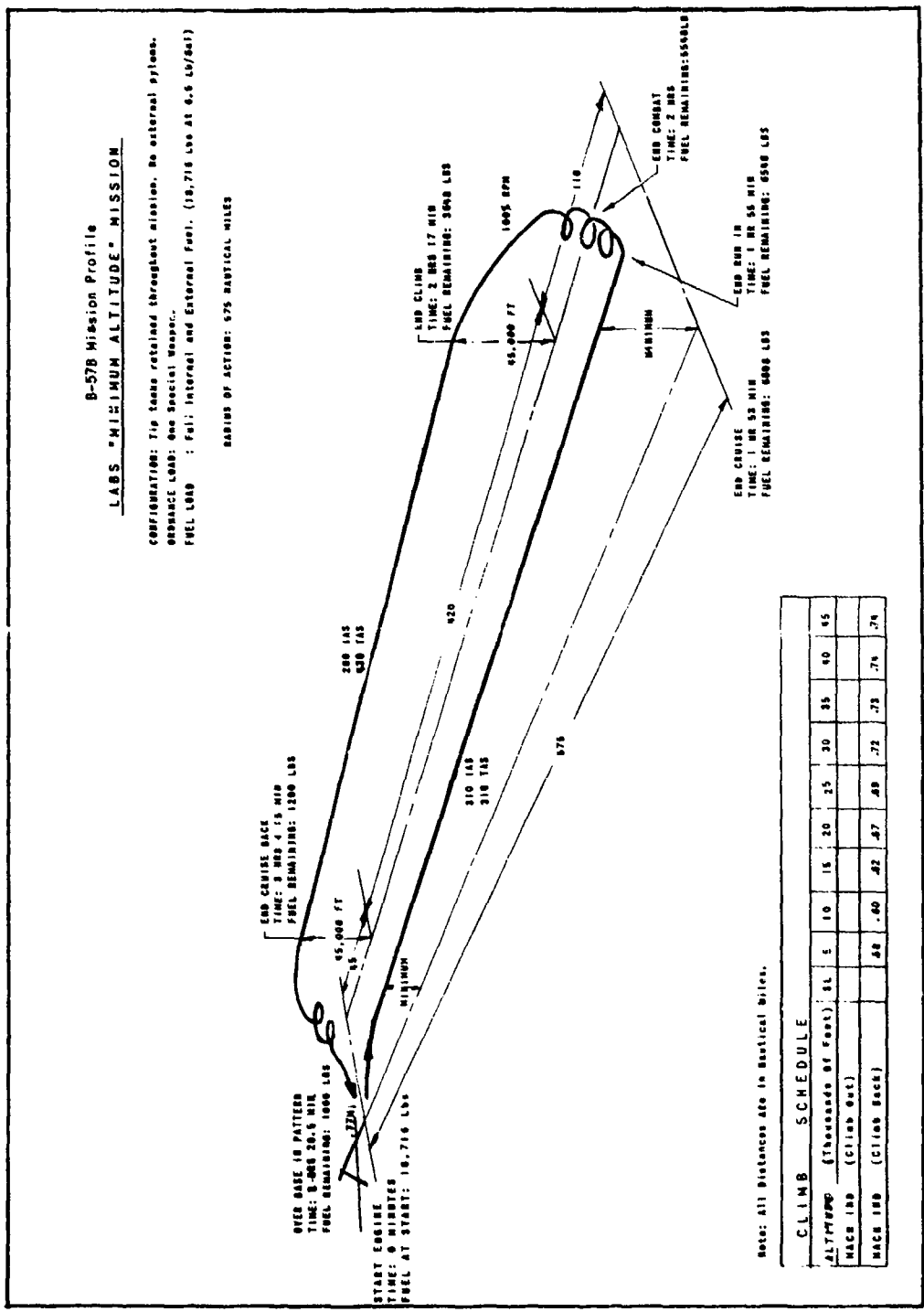

**SECRET**



**SECRET**

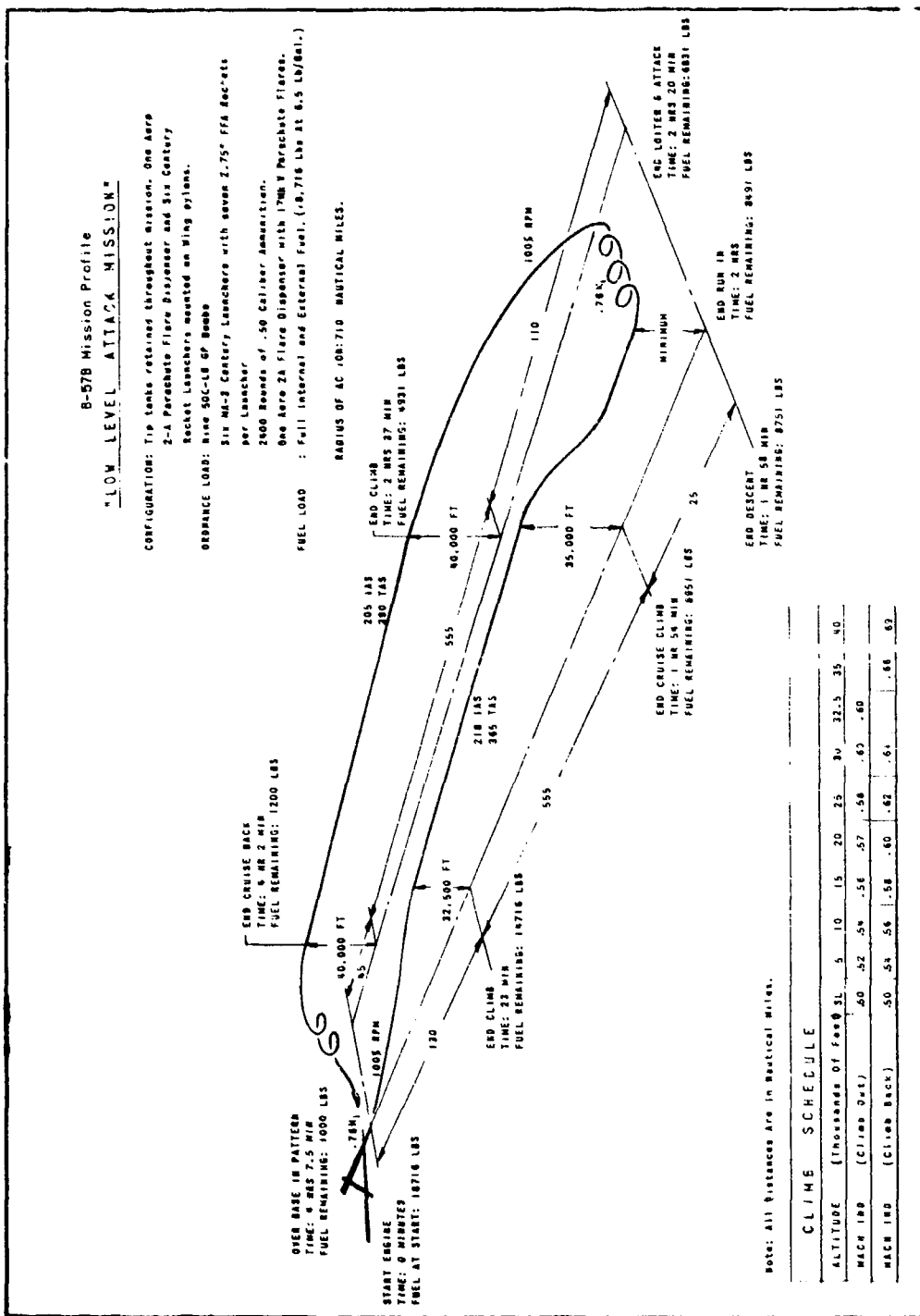

Appendix B, Page 37

Inclosure V (S)

**SECRET**

## SECRET

### FUNCTIONAL DEFICIENCIES

#### 1. GENERAL:

a. There are several functional deficiencies in the B-57B weapons system that materially limit its effectiveness as a night intruder and all-weather attack aircraft. In most cases these deficiencies are limiting in daytime effectiveness also, but they become more critical in an aircraft that is intended primarily for night operational use. In general, the deficiencies fall into four categories, as follows:

- (1) Equipment that has an excessive malfunction rate. (U)
- (2) Devices that are poorly located for operational use. (U)
- (3) Devices that are potentially hazardous due to characteristics of design or construction. (U)
- (4) Equipment that is unduly difficult to operate or maintain because of design or limited accessibility. (U)

b. These deficiencies are covered in three sections. The first section covers the Armament System alone, because there are several critical defects in this system. The second section is devoted to general deficiencies that exist throughout the aircraft and bear directly on operational employment. The third deals with the S-4 Shoran System. (U)

### SECTION I - ARMAMENT SYSTEM DEFICIENCIES

#### 1. MACHINE GUN INSTALLATION:

a. In the 24 gunnery sorties accomplished during this test, a total of 54,900 rounds of ammunition were loaded and only 37,391 rounds fired out, for a rate of only 63%. This malfunction rate was accounted for in a total of 78 individual malfunctions. Of these, three types of malfunction recurred frequently. These were:

- (1) Charger failure - 17: This sort of failure occurred when a leak developed in the charger line, causing the hydrostatic fuze to lock and render the charger inoperative. (U)

Appendix C, Page 1

**SECRET**

- (2) Link chute jam - 13: This sort of failure occurred when links failed to pass through the chute, causing subsequent links to back up into the gun. (Refer to Figure 4.)

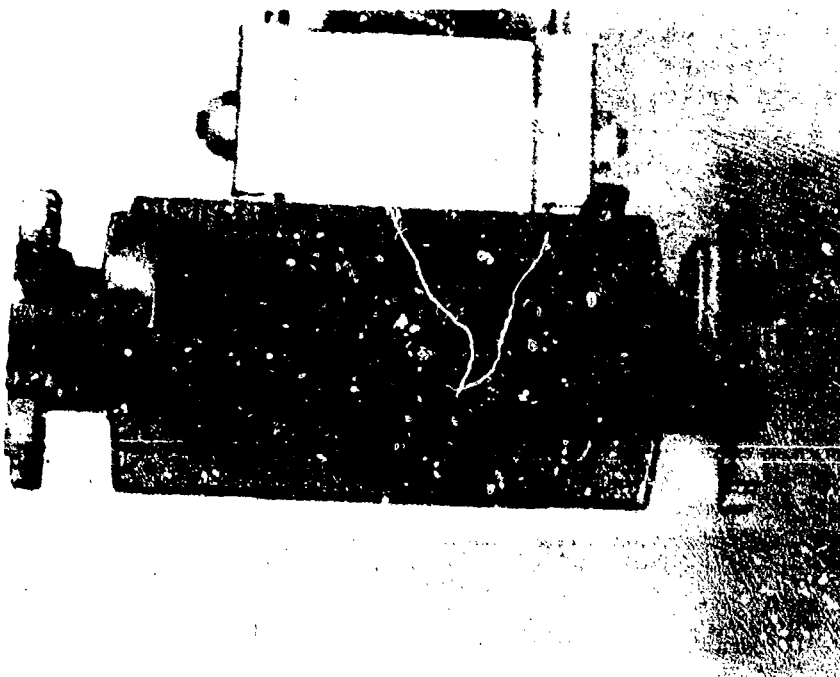

Figure 4: Link Chute Jam (U)

With this link blocking the chute, other links cannot be passed, so they back up and foul the action of the gun.

- (3) Ammunition - 16: Four sorties were flown with ammunition that was of dubious serviceability (reloaded remnants from other missions), and an abnormally high malfunction rate was to be expected.  
(U)

Appendix C, Page 2

**SECRET**

The remaining malfunctions occurred at rates of from one to three each; they included feed chute jam, failure to extract, broken link, and a warped extractor. On one sortie the entire system failed when the electrical fuzing failed, and 12 malfunctions were for undetermined causes. (U)

b. Six of the sorties included above were flown with the system modified to include installation of modified link chutes supplied by the airplane contractor and the Kits, Conversions, B-1 Guncharger (Doughnut Seal). In these six sorties only six malfunctions occurred (9542 rounds fired out of 10,800 rounds loaded for an 89% fire-out rate). Three of these were due to misaligned ammunition links and three were due to charger failures. All three of these latter failures were on the same charger. (U)

c. The space provided for accomplishing the bulk of the general servicing of the machine gun installation is critically confining. Almost all of this servicing is done through the ports provided in the wing above the installation. This will normally include loading the ammunition over the feed pawl, timing and head space adjustments, installing of chargers, link chutes, and heaters, and fastening the guns in the mounts. Personnel find general maintenance of the machine guns considerably more difficult to accomplish for lack of space in which to work and manipulate tools. (Refer to Figure 5, this Appendix.) (U)

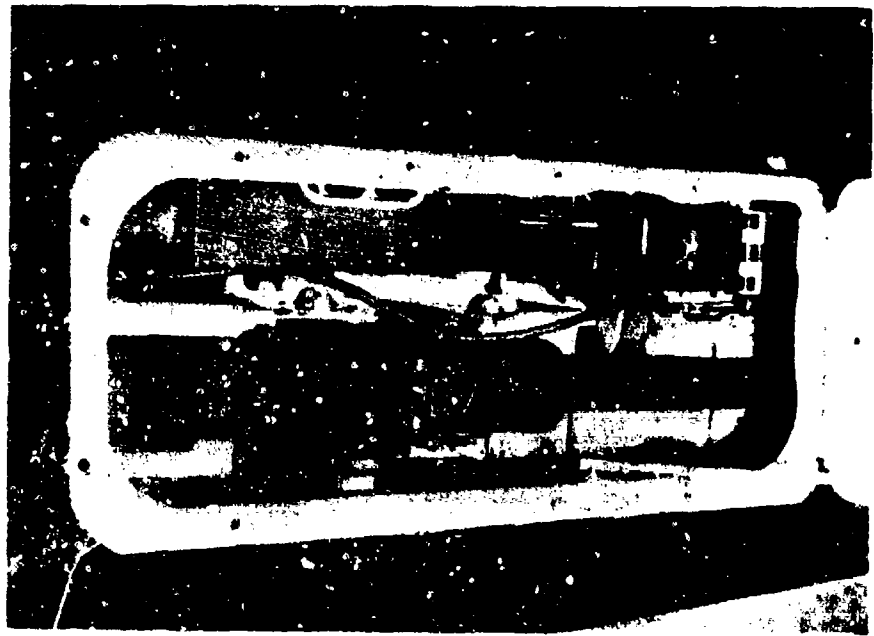

Figure 5: Machine Gun Installation as seen through Access Door.  
(Note the confining work space.) (U)

## SECRET

2. MARK 8 MOD 8 GUN SIGHT: The Mk 8 Mod 8 Gun Sight is unsuitable for operational employment at night because of the following deficiencies in design and method of Operation:

a. The tinted glass of the reflector and the bulky shape of the sight reduce forward visibility over the nose of the aircraft. (U)

b. The various settings for guns, bombs, and rockets cannot be set into the sight at night without aid of a flashlight or other outside light source. (U)

c. The sight comes equipped with the daylight reticle only, which is unsuitable for night work, and there is no current USAF publication that mentions the existence or availability of alternate reticle patterns. (U)

d. The installation of the Mk 8 Sight in the B-57B is in such a position as to restrict full depression of the reflector because the reflector strikes the windshield. (U)

3. RELEASE OF EXTERNAL ORDNANCE STORES: Early efforts with the RB-57A and the B-57B showed an unacceptably high probability for damage to the wing when external stores were released from the bomb pylons. The standard M-116 Firebomb Tank struck the wing with varying degrees of minor damage at all speeds in excess of 175 knots (lowest tested). An inadvertent release of an Aero 2A Flare Dispenser at approximately 230 knots resulted in a slight scraping of the wing. Successful releases of M116 Firebomb tanks were made at speeds up to 340 knots by using mechanical kick-off braces fitted to the wing pylons. (Refer to figure 13, this Appendix.) No other tests of external stores release were made, pending modifications and tests by the contractor. (C)

4. RELEASE OF INTERNAL STORES - AN/M-26A1 PARACHUTE FLARES: On two out of three sorties flown with AN/M-26A1 Parachute Flares installed in the door, potentially dangerous malfunctions occurred. These malfunctions apparently were a result of the stabilizing sleeve and/or parachute being pulled out of the container prematurely due to air pressure of the slip stream. On one sortie the shroud came out on one flare and another flare was lost, possibly by being yanked off when its chute deployed (see figure 6); however, on the other mission the full chute blossomed and fouled on the bomb door fittings. In this latter case the candle and hood element apparently snapped off of the parachute assembly. If the candle had not fallen free, but had remained fixed to the tangled chute, a serious hazard would have existed to safe

## SECRET

flight with the lighted flare (350° C) in the aircraft or close to it. Pilots have been briefed not to exceed the 350-mile per hour release limit for this munition; the failure above occurred within this limit, although pilots were not aware of the malfunctions until after landing. As a result of these malfunctions, no more AN/M-26A1 Parachute Flares were employed on this test. Further, in view of the fact that the B-57B rotary bomb door is, in effect, an external carriage system when in the open position, no other munitions with marginal external characteristics were carried. (C)

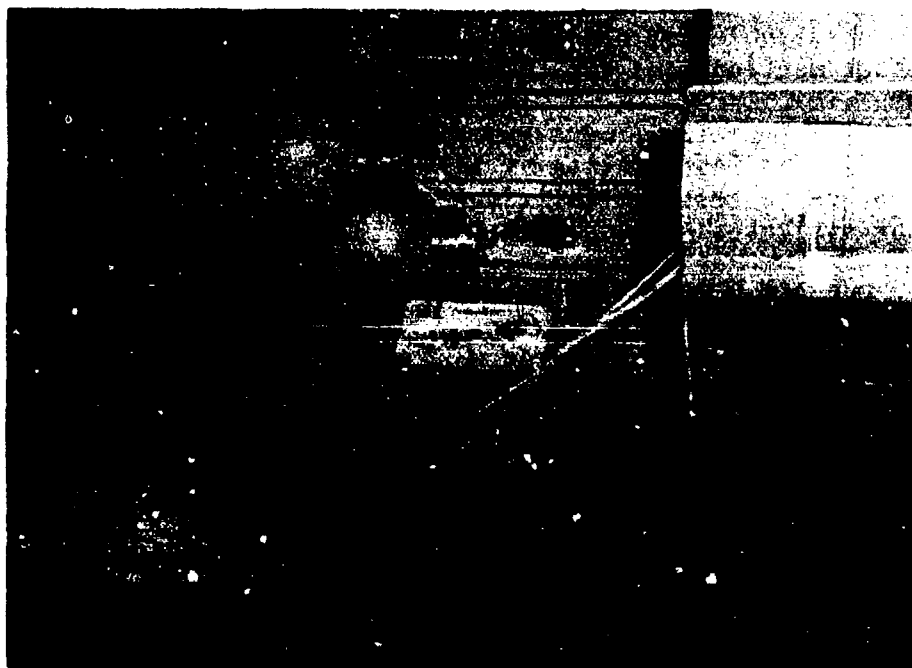

Figure 6: Photograph of an in-flight malfunction of an AN/M-26A1 Parachute Flare mounted on the B-57B rotary bomb door. (U)

The stabilizing sleeve of the left hand flare, top tier, in the forward bay has deployed prematurely. The center flare, top tier, of the forward bay was lost in flight although the rotary door was not connected to permit release. (C)

## SECRET

### 5. ROTARY BOMB DOOR:

#### a. Description of Deficiencies:

- (1) Rotation of the bomb door in flight causes the aircraft to pitch up. Although this pitch-up is not considered to be dangerous, it does interfere with accurate flying on a bomb run. This is particularly true in the case of automatic rotation on the Shoran bomb run when the pilot cannot anticipate countering the pitch-up by adding forward pressure. (Less than 2 "Gs" are indicated on the aircraft at 400 knots indicated airspeed when the pilot rotates the door without trying to counteract the pitch-up.) (C)
- (2) Turnaround times are materially increased when the bomb door configuration is changed between sorties, because bomb shackles and sway braces have to be relocated on the door to accommodate the new bombs. (Refer to paragraph 11, Appendix B for times involved.) (U)

### 6. SPECIAL WEAPONS LOADING:

a. Loading of the T-63 Practice Unit with the contractor-recommended Handling Ring technique is excessively time consuming compared to loading with the F-4 Dolly method. (S)

b. The F-4 Dolly, in its present configuration, is hard to operate when lifting a T-63 Practice Unit onto the B-57B rotary door because the location of the hydraulic lift control valves makes them extremely awkward to manipulate. (S)

### 7. ARMAMENT SYSTEM CONTROL DEVICES:

#### a. Description of Deficiencies:

- (1) In general, the location of the armament switches and allied control devices make switch selection and visual monitoring of the system extremely awkward in flight. This condition is made more acute by the similarity and proximity of most of the switches to each other. Visual reference for selection is required, yet visual reference to the armament panel in flight requires considerable craning of the neck by the pilot, increasing the possibility of vertigo at night. (U)

Appendix C, Page 6

## SECRET

- (2) Each of the 25 bomb station indicator lights (for internal and external stations) has to be dimmed or brightened individually by turning the indicator in the direction desired. This requires more time and attention than can usually be spared in flight. Further, if the lights are on bright when the pilot selects the indicator lights on, the light intensity from even a few of the indicators can impair his night vision for a considerable length of time. (U)
- (3) There is no Lamp Check/Station Check switch by which all indicator light bulbs can be checked simultaneously to see that none are burned out. (U)
- (4) The location of the bomb door switch and the bomb door position indicator is not compatible with the frequency of operation and/or visual reference required of these devices by the pilot engaged in night intruder tactics. (U)
- (5) The bomb release light cannot be dimmed and when it comes on in flight, materially reduces the night adaptability of the crew member. (U)
- (6) The rocket firing circuit, including the intervalometer, will not fire the MA-3 Century Launchers satisfactorily. (U)
- (7) There is no alternate armament control panel in the Observer's cockpit to permit him to assist the pilot in the attack or in preparation for the attack. (U)

### SECTION II - GENERAL DEFICIENCIES

1. DIVE BRAKE ACTUATING SWITCH: The location, method of operation, and physical shape of the dive brake actuating switch severely limit effective employment of the dive brakes in the B-57B aircraft. (U)

a. The location is unsuitable because:

- (1) The switch cannot be effectively reached and operated in coordination with throttle and/or two-handed control column movements. (Figure 7.) (U)

Appendix C, Page 7

## SECRET

- (2) The switch is at least partially obscured from the pilot's direct vision by a part of the overhanging cockpit sill. (Figure 8.) (U)
- b. The method for operation is unsuitable because:
  - (1) The spring-loaded feature that automatically returns the switch to neutral from "Extend" requires the switch to be held in "Extend" to assure full extension. This takes between three and four seconds, and it cannot be accomplished simultaneously with throttle movements or control column movements requiring use of both hands. (U)
- c. The physical shape of the switch is unsuitable because:
  - (1) The switch is too small and slender for prompt operation without visual reference. (U)
  - (2) The physical shape of the switch is not in keeping with accepted human engineering theories that recommend control devices be suggestive of the device being selected for operation (e.g., a wheel shaped knob on the landing gear lever, and a flap shaped lever for wing flap operation). (U)



Figure 7: Dive Brake Switch Location. Note that the hand is on the throttles in the normal position, but the dive brake switch can scarcely be touched, let alone operated by the little finger. (C)

Appendix C, Page 8

**SECRET**



Figure 8: Illustration of how the cockpit sill obscures the Dive Brake Switch. This photograph was made to show the exact view the pilot had of the cockpit while in flight position. The pilot was seated on a dinghy, a seat-type parachute, with the seat in the third notch from the top. (C)

2. CANOPY AND WINDSHIELD DEFOGGING SYSTEM: The Canopy and Windshield Defogging System is unsuitable because:

a. It will not keep the canopy and windshield free of fog and frost during maximum performance letdowns under all conditions of humidity. Clearing of the windshield in such cases requires from two to four minutes of operation at high engine RPM to burn off the moisture. (U)

b. The Defog Blower Control Knob is difficult to operate due to its position, method of operation, and the force required to move it. The device is also erratic in its control over the damper and blower, and it may sometimes be moved throughout its entire range without causing the blower to operate. This latter defect is apparently due to excessive play in the cable, permitting the cable to move without opening the damper and turning on the blower. The awkwardness and difficulty in operation of this control stems from its location and the routing of the control cable in such a manner as to cause heavy forces due to friction. (U)

Appendix C, Page 9

85

**SECRET**

## SECRET

3. CABIN CONDITIONING SYSTEM: The Cabin Conditioning System is unsuitable because:

a. There are too many possible ways of changing the temperature, and none of them have a positive control that will permit selection of any desired temperature range without considerable adjustment. Further, since temperature changes in the cockpit lag control selection to a considerable degree, there is a tendency to run a continuous cycle of "too hot" to "too cold" and back. Temperature in the cabin is affected by the primary Cabin Conditioning System, engine RPM, and the Cockpit and Canopy Defog System. (U)

b. There is no method for independently controlling the volume or direction of flow of cabin conditioning air at either of the crew positions. This requires both crew members to adjust to the same temperatures, an unrealistic requirement in view of inherent differences in individual "comfort levels" and the considerable differences in physical exertion required for performance of assigned tasks in flight. (U)

c. Operation of the cabin conditioning system at high power settings at minimum altitudes frequently results in filling the cockpit with fog. Operation of the Defog Blower will alleviate this condition at the pilot's station, but aggravates the condition for the observer by massing the fog about him. This is an unacceptable condition on minimum altitude missions such as the minimum altitude LABS attack where the full resources of both crew members are required throughout to assure success of the mission. Cabin conditioning is essential in all minimum altitude work with the B-57B where surface temperatures are extreme. This is particularly true in conditions of high temperature and humidity. (U)

d. Solar radiation at high altitudes complicates the problem of temperature control in the cabin. The direct rays of the sun can heat the upper half of the crew members' bodies to an uncomfortable level, but readjustment of the cabin temperature to counteract this can result in permitting their feet and legs to get uncomfortably cold. (U)

4. CREW SEATS: The crew seats in the B-57B are unsuitable for the following reasons: (U)

a. The narrow width and extreme depth of the seat well are excessively confining to crew members, particularly when heavy flying gear and survival equipment is required. This confinement interferes with movement in the seat, it makes wear and use of a knee type note pad extremely difficult, and it is particularly unsatisfactory because it

## SECRET

interferes with the adjustment of the lap belts when crew members are in their seats. (U)

b. The configuration of the right arm rest and routing of the seat belt through this arm rest will permit accidental loosening of the seat belt under some conditions. (See figure 9.) (U)

c. The tendency for the parachute pack to "rock" in the seat requires conscious effort on the part of the crew member to sit erect and well back in the seat. This condition is also conducive to injury in the event of ejection. (U)

d. The back rest of the seat is uncomfortable in that the cushion provided for back support is mounted too high on the back rest to provide support for the small of the back. This cushion is placed in such a manner that it increases the discomfort and fatigue of the crew member. (U)

e. The shape of the right side of the seat in respect to the routing of the pilot's oxygen hose requires that the hose be routed in one of three ways, each unsatisfactory as listed below:

- (1) Routing of the oxygen hose over the arm rest prevents the pilot from making use of the right arm rest for relaxation or support for ejection. (See figure 10.) (U)
- (2) Routing of the oxygen hose below and in front of the right arm rest permits it to loop under the canopy ejection and control column stowing grip with subsequent risk of accidental actuation of this control. (See figure 9.) (U)
- (3) Routing of the oxygen hose through the right side of the pilot's seat subjects the hose to undesirable binding and interference with the seat and seat belts. (U)

Appendix C, Page 11

**SECRET**



**Figure 9: Unsatisfactory routing of oxygen hose and unsatisfactory seat belt condition. Arrow No. 1 points to the condition that will cause the seat belt to loosen accidentally. Arrow No. 2 points to the oxygen hose looped under the right ejection seat handle. (U)**



**Figure 10: Unsatisfactory routing of oxygen hose. Note how the oxygen hose would prevent the pilot from making use of the arm rest for relaxation or support in ejection. (U)**

Appendix C, Page 12

**SECRET**

## SECRET

5. PERSONAL EQUIPMENT: Some of the more glaring defects in the B-57B exist in its lack of adaptation to current versions of USAF personal equipment, survival gear, and planning materials. The following shortcomings are critical: (U)

a. Pressure Suits: There are no provisions in the B-57B for accommodating any version of a pressure or partial-pressure suit for either crew member. (S)

b. Survival Equipment: Current versions of survival kits for attachment to parachute harness cannot be employed in the B-57B. The pilot sits so close to the control column in flight that he cannot possibly wear a back type parachute or back type survival kit; there is no satisfactory way to combine the standard seat type parachute with the seat type survival kit (normally worn with the back type parachute). (U)

c. Parachutes: The standard seat type parachute is not of sufficient depth to permit crew members to see out of the aircraft satisfactorily; additional height has to be provided through a wooden block or a dinghy of approximately 5 to 6 inches thickness. In either case, it is virtually impossible for the crew member to sit comfortably without continual readjustment of his seat pack position. This results from the unstable tendencies of the seat type parachute due to its rounded shape; the pack continually rocks with each movement of the crew member and can result in severe back strain and excessive fatigue. No automatic opening seat type parachute could be obtained for use in this test, and it is not known whether they exist in a standard form for issue to crew members as yet. The automatic opening parachute is highly desirable for use in the B-57B. (U)

d. Flight Planning Materials: None of the current flight planning materials or publications to be used in flight are suitable for night flying. Almost all require the use of a white light in considerable strength to read, and none of the maps or other route-assistance devices are designed to emphasize what is to be seen by night; all of them show in great detail the road nets, cities, terrain contours, and other objects readily used by day. In a blacked-out area at night, as in combat, such maps are useless. (U)

6. INTERPHONE COMMUNICATIONS: The effectiveness of the B-57B weapons system is unnecessarily impaired because of the poor interphone communications between crew members. Defects are as follows: (U)

## SECRET

a. When the pilot desires intermittent communication with the observer and outside stations, it is necessary for him to select "INTER" or "COMM" on the master control switch each time he changes his transmission from interphone to radio or vice versa. This is an unsuitable condition due to the wasted motion and the common tendency to forget to make this necessary change. (U)

b. It is necessary for both the pilot and the observer to depress their microphone buttons for transmission by interphone. This is an unnecessary motion that can be ill-afforded in many conditions of flight when both hands are employed in other tasks. (U)

c. There is no mixing provision for UHF, Interphone, and Radio Compass at the observer's station. This requires that the pilot use "CALL" to contact the observer when the latter is on "COMM" or "ADF". (U)

d. The observer's foot-operated microphone is poorly located for operation by personnel with short legs. (U)

7. FUEL CONTROL DEVICES: Although several Technical Order Compliances have been received and accomplished on defects in the Fuel Control Panel, there are still several operationally unsuitable conditions remaining. These include: (U)

a. The engine shut-off valves are identical to the other fuel selectors and may be easily mistaken for one of these and turned off in error. (U)

b. The infrequency of actuation of the No. 1 Fuel Pump Switch and the Transfer/By-Pass Selector do not justify their present positioning on the main fuel panel. Since these devices have been safety-wired in the "ON" position and are not normally actuated in any phase of flight, their present location on the main fuel control panel only complicates its operation. (U)

c. The undependable reaction of the engines when the No. 1 Fuel Pumps are not turned on makes this a serious hazard to flight, yet there is no positive indication that the No. 1 Pumps Switch is on or that the circuit breakers are in. It is possible to start the engines and conduct all of a flight without use of these pumps, yet it is also highly probable that either or both engines could flameout from insufficient fuel. Consequently, there is a requirement for some

Appendix C, Page 14

## SECRET

sort of a positive signal when the No. 1 Pumps are not on or the circuit breakers are not in. (U)

d. The feeding and the indications of fuel level in the wing tip tanks are unsuitable. The tanks will not sustain the engines alone at some conditions of fuel flow, and there is no indication of whether a tip is feeding at all or how much fuel is left in it. (U)

8. CONTROL SURFACE TRIM INDICATORS: The indicators for all three of the control surface trim devices are unsuitable as follows: (U)

a. Elevator Trim (Stabilizer Position):

- (1) The travel of the horizontal stabilizer in trimming is limited to three degrees and 22 minutes nose down and two degrees and 22 minutes nose up, yet the indicator covers a range of six degrees nose down and ten degrees nose up. This is misleading and tends to underemphasize the importance of the trim position for takeoff. (U)
- (2) The location of the trim (stabilizer position) indicator makes it hard to see accurately at a glance. (U)

b. Aileron and Rudder Trim Indicators:

- (1) The aileron and rudder trim position indicators do not give a positive indication of trim position. (U)
- (2) The indicators do not indicate unless the trim switch is actuated and the trim is approximately in neutral. (U)

9. RUDDER TRIM SWITCH: The shape and direction of operation of the rudder switch makes it unnecessarily hard to find and use without visual reference. It does not work in the same sense as the rudder, which is the desirable way. (U)

10. LANDING LIGHT:

a. There is only one landing light. With the present ineffectiveness of the taxi lights, this one landing light has to be used for taxiing and landing. Having only one light on an aircraft that is designed primarily for night operation is an unnecessary risk. (U)

Appendix C, Page 15

**SECRET**

b. The landing light is located directly behind the case ejection chute for No. 3 machine gun in the left wing. Smoke and waste from the gun frequently cover the light with a greasy film. It is possible for the light to have its effectiveness considerably reduced by such a film. (U)

11. TAXI LIGHTS: The taxi lights on the B-57B are unsuitable because they are not of sufficient intensity and are poorly directed. When wing tip tanks are mounted, the lights become virtually useless. (U)

12. PILOT'S INSTRUMENT GLARE SHIELD AND COCKPIT CANOPY SILL: The glare shield above the pilot's instrument panel and the overhanging portion of the canopy will obscure or partially obscure several instruments and control devices. (U)

a. The glare shield completely obscures the Fire Warning/Fire Extinguisher System and obscures the upper one-third of both the Gyro Magnetic Compass and the Flight Indicator when the pilot raises his seat high enough to realize best visibility through the canopy. (Figure 11) (U)

b. The overhanging portion of the canopy sill obscures the dive brake actuating switch when the pilot sits high enough to realize best visibility through the canopy. (Figure 11) (U)

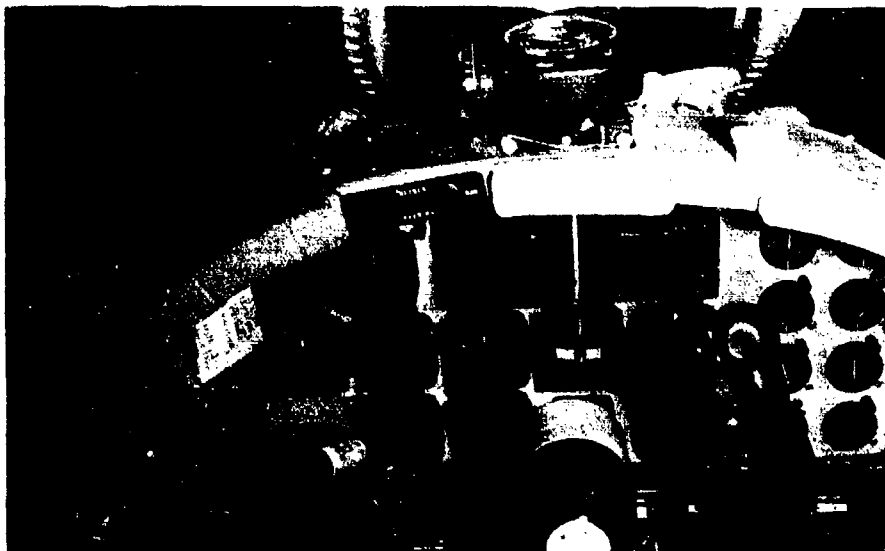

Figure 11: Detail illustrating how the instrument glare shield obscures the fire warning indicator and a portion of some instruments. This picture was taken to show exactly what a 5-foot 11-inch pilot sees when seated on the dinghy and seat type parachute with the seat in the third notch from the top. (U)

Appendix C, Page 16

92

**SECRET**

13. INTERNAL CONTROL LOCKS:

a. There are no internal control locks for the aileron and rudders. (U)

b. The lock provided for the control column (elevator) is unsatisfactory and highly ineffective. This lock is not sufficient to hold the control column immobilized in gusty winds of even moderate strength, and it is obscured by the control column in a manner that makes it easily overlooked at takeoff and hard to engage after landing. (U)

14. CANOPY CURTAIN: There is no provision for shading crew members from direct rays of the sun. Under many conditions of flight in the B-57B this can become extremely uncomfortable due to the uneven temperatures between shaded parts of the body and those hit by the sun. There is also a requirement for a shade of some sort to eliminate "day-light effect" on the S-4 Shoran scope. (U)

15. REAR VIEW MIRROR: Lack of a rear view mirror in the pilot's compartment is a distinct handicap in maintaining constant contact between crew members without recourse to verbal communication. Lack of a mirror is also a handicap in making checks to the rear for possible interception. (U)

16. CHECKLISTS: Neither the placarded TAKEOFF and LANDING Check List nor the plastic bound amplified Check List can be read at night without light from a flashlight. The amplified check list is too small (print) to be easily read by flashlight. (U)

17. COCKPIT FLOORING: The part of the cockpit floor immediately under each seat consists of laced canvas that sags into a cup-like shape. This space becomes a catch-all for dropped equipment (gloves, pencils, cigarettes, etc.), and the depth of this cup is sufficient to preclude recovery of dropped items in flight. In the case of dropped cigarettes, this condition becomes hazardous. (U)

18. PILOT'S NOTE-TAKING: The design of the B-57B pilot's cockpit is so compact that it is extremely difficult for the pilot to find room to make any notes, figure, or do other work requiring use of a surface for writing. The seat is so tight and the control column so close that they prevent satisfactory employment of a knee pad for such a purpose. (U)

## SECRET

19. RADIO BEACON SIGNAL IN REAR COMPARTMENT: The lack of a radio marker beacon signal in the rear cockpit prevents the observer from making best use of the radio compass for navigation in many instances. (U)

### SECTION III - S-4 SHORAN (HIRAN) DEFICIENCIES

1. ALTITUDE LIMITATIONS: The present altitude limitations of the transmitter (T-342/APN-84) is 43,000 feet, well below the maximum operational altitude of the B-57B. (S)

2. FUNCTIONAL RELIABILITY: The functional reliability rate as experienced on this test for operation of the set at 40,000 feet and above is operationally unacceptable. (S)

3. GENERAL:

a. The location of the Signal Comparator unit in respect to the PDI meter and the Range Indicator units precludes normal in-flight PDI alignment because these three controls cannot be monitored simultaneously. (U)

b. Parallax error is introduced by the inconvenient location of the Range Indicator and Computer. This results in poor synchronization in the solution of the bombing problem. (U)

c. The receiver gain controls are ineffective in that minimum satisfactory gain settings may be obtained only with maximum gain reading of the calibrated gain setting dial. (U)

d. The scope visor is so short that an unusual amount of "daylight effect" impairs reading of the scope in daylight. (U)

e. The installation of the S-4 Shoran console makes the performance of set maintenance difficult. The observer's seat must be removed in order to remove and replace the set. (U)

f. There is a ghost pulse visible on the circular trace at all times. (U)

Appendix C, Page 18

**SECRET**

**RECOMMENDED OPERATING PROCEDURES**

Detailed operating procedures for use of the S-4 Shoran (HIRAN) equipment were presented in the Interim Report, Project No. APG/TAS/119-A, "OST of the B-57B." The procedures for loading conventional and special weapons doors are presented in this report in order to provide some assistance to organizations to be equipped with the B-57B aircraft. At the present time this information has not been consolidated and offered in the form of a technical order by the responsible agencies. The procedures outlined herein were successfully used during the OST, and it is believed that they are substantially the same procedures that will be published officially at a later date. (S)

**PART A - CONVENTIONAL WEAPONS**

**1. ROTARY BOMB DOOR:**

a. **Description:** The rotary bomb door is unique in several respects. It is designed to be readily removed from the aircraft for loading, which provides the weapons system with some of the favorable aspects of being able to reload with preloaded clips, after the fashion of hand guns; doors are interchangeable between aircraft. The door is mounted on trunnions in the bomb bay portion of the aircraft. To open and close, it operates through a 180-degree arc, completing either cycle in about six seconds. The design is so effective as to minimize in-flight drag with the door open, and it apparently eliminates most of the high speed turbulence problems common to aircraft with internal bomb bays of the conventional type. Bombs are mounted on the door itself in three "bays"; therefore, when the door is opened, the stores become externally hung items. Loading is generally expected to be accomplished by removing the door from the aircraft completely, and this feature provides an exceptionally fast turnaround time if extra doors are made available for preloading. There are some instances where the door may be loaded faster while mounted on the aircraft. These would occur if the same door had to be reloaded and if no change was required in the door configuration. (U)

b. **Loading Procedure with the Door Dismounted:** The following procedure was successfully employed for loading the rotary bomb door when it was dismounted from the aircraft. (U)

- (1) Prepare the door for the ordnance item to be loaded by arranging the fittings (sway braces, chocks, and shackles) in accordance with the loading diagrams

Appendix D, Page 1

**SECRET**

## SECRET

placarded on the door frame. (This step takes considerable time in the extreme cases. For example, to change from the nine 500-pound GP bomb configuration to the twenty-one 260-pound fragmentation bomb configuration takes 10 man-hours, and since only four men may work on the door at one time, a minimum of two and one-half hours is required for this change. If the door configuration is not to be changed, then this step is eliminated.) (U)

- (2) Place the door in position parallel to the bomb hoisting device for initial loading. (It was found that the M108 Truck, Crane, 6x6, 2½-ton capacity, is satisfactory for hoisting. On all bombs employed, with the exception of the 750-pound GP bomb, the Navy lug was used for attaching the crane hook to the bomb. On the 750-pound bomb there is no Navy lug, so a sling must be employed for lifting.) (U)
- (3) The bombs are individually hoisted with the crane and guided into the racks by the armament personnel. Loading may be started from front or rear of the door, but it should be noted that on bombs requiring nose fuzes only, starting from the front will permit loaded bombs to be fuzed while the other bays are being loaded. The converse is true with tail-fuzed bombs. In all cases, the left bomb in each bay should be loaded first in order to provide sufficient clearance between the bomb and the S2A shackle for inserting the arming wire in the solenoid. (Refer to Figure 12, Page 97.) (U)

Appendix D, Page 2

## SECRET

**SECRET**

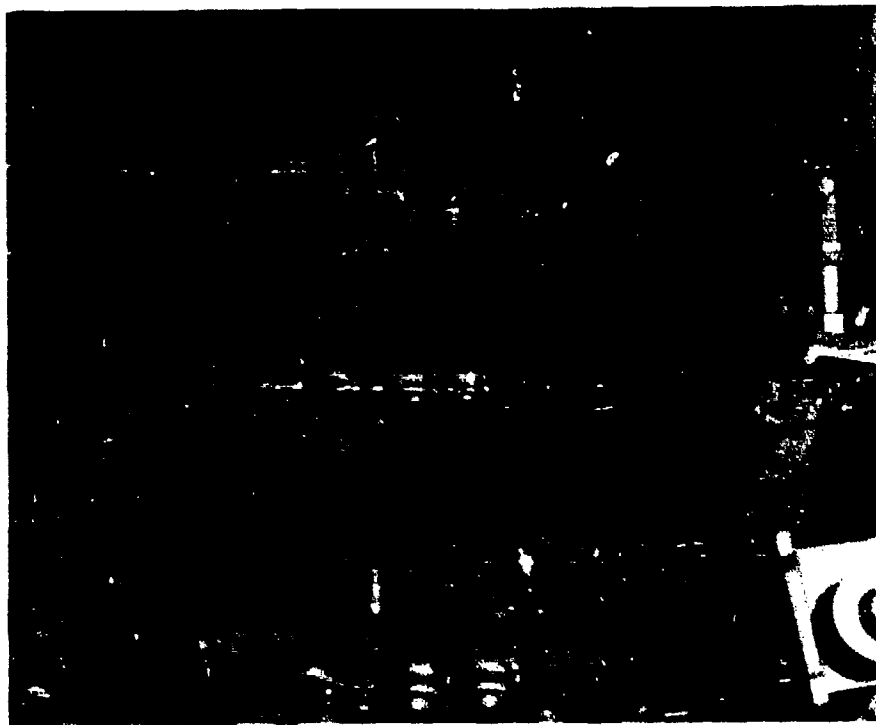

Figure 12: Installing the loop swivel of the arming wire in the S2A Bombing Rack. Note the severely restricted working space. If the bombs had been loaded from the other side first, this space would be even more restricted. (U)

- (4) After the bomb is locked in the rack, put sufficient tension on the hoist line to align the bomb properly for sway bracing. To get a good line it is necessary for the hoist to lift at approximately 90 degrees to the long axis of the bomb. (U)
- (5) Tighten the sway braces to finger tight. Do not get them too tight, because this can cause the racks to seize and fail to release. (U)
- (6) Complete loading of each bay in turn before proceeding to the next bay in order that fuzing personnel can begin their tasks without interference. (U)
- (7) Install fuzes and arm them. (U)

Appendix D, Page 3

**SECRET**

**SECRET**

c. Mounting the Loaded Door on the Aircraft:

- (1) Maneuver the loaded door on its dollies into approximate line beneath the bomb door recess in the fuselage. Direction of entry must be from the right of the aircraft, approximately under the wing root, because on this side only the gear fairing door may be raised and a hinged panel on the bomb bay may be raised to permit entry. (U)
- (2) Insert the four bomb hoists (Mk 8 Mod 0, 2240-pound capacity) in the four hoist ports provided in the fuselage directly above the corners of the door. Attach cable to the door fittings and take up slack evenly. One man is required on each hoist. When the weight of the door is off the dollies, remove the forward dolly. Continue to hoist the door evenly until it is in place for locking. (U)
- (3) When the door is in place in the gimbals, it is locked in place by operating the locking pin levers in the door. (U)
- (4) Inspect the door for correct mounting and locking and remove the rear dolly assembly. (U)

(NOTE: In general, the remounting of the loaded door on the aircraft is simple, provided the aircraft is level. If it is not level, the door will swing to the low side and will have to be pushed back in order to fit into the aircraft for locking. This out-of-level condition occurs quite frequently, resulting from any condition that affects the aircraft static attitude. For example, if the aircraft is stopped sharply in parking, it will rock forward and rest nose down; if it settles excessively in refueling, it will rest nose up. In some instances it has been necessary to change this attitude in order to get the door in place.) (U)

2. EXTERNAL STORES:

a. Description: There are provisions for mounting eight pylons, four on each wing, for carriage of external stores. The two inboard stations are stressed for bombs of the 750-pound GP weight and below.

Appendix D, Page 4

**SECRET**

**SECRET**

The two outboard stations are for carrying rockets only. The bomb pylon stations will also accommodate rocket pylons in lieu of the bomb pylons if desired. (U)

b. Loading Procedure: In general, the loading procedure for the external stations of the B-57B is simple and easy. In the case of the bombs and the M116 Firebomb Tanks, the Mk 6 Hoist is used to lift the item onto the shackles. The most difficult part of the operation is installing the arming wire. Lack of access room for inserting the loop swivel in the arming solenoid requires a tedious effort with long nose pliers and a common screwdriver. For rockets, the launchers are installed by hand, and then the individual rockets are inserted in the launcher. (U)

c. Kick-off Brace: When damage resulted to RB-57A aircraft in releasing M116 Firebomb Tanks, a locally manufactured "kick-off" brace was installed on the pylon to prevent the tank from striking the aircraft on release. On a subsequent firebomb mission when more damage resulted, motion picture film of the release disclosed that the tail fairing came off and struck the aileron of the aircraft. After this mission, the tail fairings were left off the tanks in mounting. No further damage resulted on some 12 to 15 sorties (three involving B-57's, the remainder RB-57's). (Refer to Figure 13, below,)

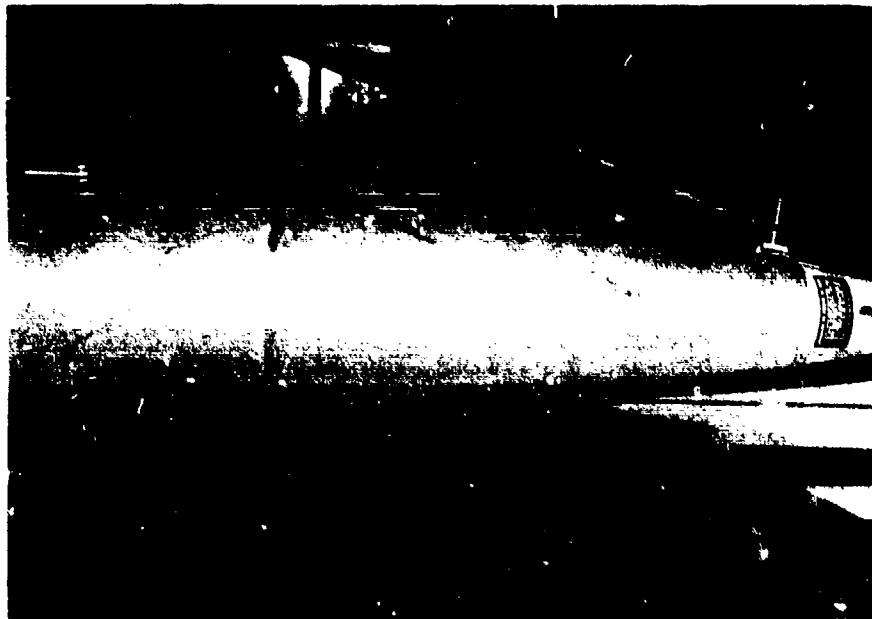

Figure 13: Kick-off brace installed for release of M116 Firebombs externally. (U)

Appendix D, Page 5

99

**SECRET**

## SECRET

### PART B - SPECIAL WEAPONS

#### 1. SPECIAL WEAPONS DOOR:

a. Description: The special weapons door is interchangeable with the conventional weapons door on all B-57B aircraft. No modification to the aircraft is required, since all necessary systems and controls for each door are mounted in the aircraft simultaneously. Operation in respect to opening and closing is the same for both doors; however, the internal configuration and the wiring of the doors are quite different. The special weapons door will accommodate one unit of the T-63 Practice Unit configuration; there are no provisions for other types of special weapons. Control of the weapon on the door is provided for the pilot by the T-79 (T-145) Special Weapons Control Box which is mounted in the armament control panel in the cockpit. (S)

b. Preparation of the Door for Loading: Before each loading of the special weapons door, certain preflight checks and inspections must be made to assure proper functioning. These are as follows: (U)

#### (1) Inspection of Special Door: (U)

- (a) Door must be clean and in serviceable condition.
- (b) Sway braces must be tight and retracted.
- (c) Pull-out plugs and pull-out cable harnesses secure and undamaged.
- (d) T-44 Unit disconnected and T-44 Unit cables connected to the by-pass cable (CT-633).
- (e) Fin microswitch and load microswitch serviceable and free to operate.

#### (2) Operation Check: (U)

- (a) Roll door to aircraft to where it can be connected to forward Cannon plugs and mounted on the aircraft.
- (b) Rotate mounted door to open position.
- (c) Cock the Aero 61B bomb rack with the cocking lever.

Appendix D, Page 6

**SECRET**

- (d) Turn circuit breakers on. (Release, arming, arming heater, T-79 power, fin power located on left-hand console, navigator's compartment.)
- (e) Master armament selector to BOMBS INTERNAL.
- (f) Aircraft battery switch ON.
- (g) Push release button on stick and verify that rack releases.
- (h) Cock bomb rack again.
- (i) Push load microswitch on door and check light on.
- (j) Lift the manual bomb release lever and push forward (navigator's compartment). Check that rack releases.
- (k) Operate Arm-Safe switch to ARM and check ARM lights on.
- (l) Operate Arm-Safe switch to SAFE and check SAFE light on.
- (m) Insert arming wire extension in the arming hooks. Place arming switch to ARM and pull arming wire extension. The extension should not pull out. Next, pull the arming lever back to the safe position and pull arming wire extension out.
- (n) Place arming lever back in neutral (all the way forward). (CAUTION: If the arming lever is in the SAFE position, the bomb door will not open.)
- (o) Close the bomb door and remove it from the aircraft. (In the loading technique in which the F-4 Bomb Dolly is used, do not remove the door. Close it and then open it again to the 7/8ths open position to permit the F-4 Dolly and T-63 to have clearance for maneuvering into the bomb bay.)

2. T-63 PRACTICE UNIT:

Appendix D, Page 7

101

**SECRET**

**SECRET**

a. Description: The T-63 Practice Unit includes two major components, the main body and the tail assembly. The tail assembly has three fins to provide stability to the unit in free fall. One of these fins may be retracted and extended by an electric motor that is controlled by the pilot in the cockpit. This fin must be in the retracted position for loading and at all times the door is closed in order to permit the unit to fit into the bomb bay. It is extended for release. (S)

b. Preparation of the T-63 Practice Unit for Loading: Preliminary preparation of the T-63 must be accomplished before the actual loading procedure can be started. The following steps are required: (S)

- (1) Remove the tail assembly of the unit by taking out the Phillips-head screws that fasten it to the main body. In this step it is also necessary to unplug the fin motor cable before the fin can be completely removed. (CAUTION: It is easily possible to damage the fin motor cable Cannon plug and the cable itself if care is not taken in this step.) (S)
- (2) Since current USAF supply procedures result in having the T-63 delivered in the US Navy configuration, it is necessary to make a minor change on the unit to permit it to fit the USAF bomb rack. This requires removal of the Navy lugs and the blank plugs covering the USAF lug holes. Use two of the plug covers to close the Navy lug holes and screw the Navy lugs into two of the USAF lug holes. Also, a third lug must be secured and installed to complete the change to the USAF configuration; the Navy system requires only two lugs. These lugs are to be tightened down until approximately 1-7/8 inches of each lug protrudes above the unit skin. (S)

### 3. PREPARATION OF THE AIRCRAFT:

a. Circuit Breakers: Make certain that all special weapons circuit breakers and switches are in the OFF position. These include: (C)

- (1) Observer's left console: T-79 (T-145) Power, Fin Power, Fuze Power, IFI Power, 400 Power, T-23 Power, Release, Arming Heater, and Arming. Release lever is to the rear and the arming lever is forward. AKM-SAFE switch OFF.

Appendix D, Page 8

102

**SECRET**

**SECRET**

- (2) Pilot's left console: All armament switches, and all T-79 (T-145) box switches down and light OUT.

b. Setting of Arming Lugs in the Aircraft: These are two lugs mounted in the bulkhead at the forward end of the bomb bay; one is for manual arm and one is for manual release. For conventional stores, these lugs must be removed and reversed so that they project into the bomb bay. This step may be accomplished by removing the nuts in the lugs and reinstalling the lugs in the reversed position. (U)

c. Raise the wing flaps, retract the dive brakes, and lift the fairing door for the right main gear well. These steps are necessary to gain the necessary clearance for moving the F-4 Dolly into the bomb bay cavity with the T-63 loaded. (U)

d. The preparation of the aircraft from this point on varies, depending upon which loading technique is to be followed. (U)

- (1) In the case of the technique in which the T-63 is loaded on the dismantled door and then installed on the aircraft, it is necessary to inflate the struts of the main landing gear approximately 3.5 inches in order to provide the necessary clearance of the door with the practice unit installed. This may be accomplished by applying 1500 psi of air pressure to the extender ports on the gear struts.

- (2) When the T-63 is to be loaded onto the door while the door is mounted on the aircraft, the only step required is to open the door to the 7/8ths open position.  
(NOTE: It is necessary to differentiate between 7/8ths open and 1/8th closed in this step. The door must be positioned during the opening cycle because it must be fully opened after the F-4 Dolly with the T-63 is wheeled into the bomb bay cavity. If the door were positioned in the closing cycle, loading could not be accomplished since each cycle has to be completed before the other can begin.) After the T-63 on the F-4 Dolly has been positioned beneath the door, the door must be completely opened to permit transfer of the T-63 from the F-4 to the shackles in the door.

4. LOADING PROCEDURES: Two methods of loading the special weapons door with a T-63 Practice Unit were tested during the OST. The first of

Appendix D, Page 9

103

**SECRET**

## SECRET

these was recommended by the contractor; the second was developed by armament personnel at APGC in an effort to reduce the time for loading.  
(U)

### a. Loading of the T-63 with the Handling Rings: (U)

- (1) With the T-63 Practice Unit resting on its delivery vehicle and with tail assembly removed, install the No. 1 (top half) of the handling ring by attaching it to the mounting lugs on the side of the unit. This ring is secured on the outside of the mounting lugs, and two bolts are used to secure it.
- (2) The hoist cable hook is inserted in the suspension ring and the T-63 is raised. (NOTE: For balancing the unit while it is suspended, balance holes are provided. Balance can be attained by shifting the suspension ring to the proper hole.)
- (3) After the unit has been suspended, the lower half of the handling ring is installed in a similar ring fashion as employed for No. 1.
- (4) With the complete handling ring installed, the unit is lowered to the ground, the hoist hook is removed, and the unit is rolled over 180 degrees. This permits the suspension ring to be placed on handling ring No. 2.
- (5) The unit is picked up by the No. 2 handling ring and suspended while the No. 1 handling ring is removed. The unit is then placed back on the M-5 Trailer where the tail assembly is reinstalled.
- (6) Put the tail assembly in place on the main body of the unit and connect the fin motor cable by fastening the Cannon plug in place.
- (7) Align the tail fins so that the retracted fin is on the bottom of the unit (in respect to the carrying lugs) and in line with the centerline of the bomb (in respect to the carrying lugs). (NOTE: Since the T-63 is usually delivered in a configuration designed for external carriage on fighter aircraft, the fins will not be aligned symmetrically, the configuration required for the B-57B.) When this has been accomplished, secure the tail to the unit by replacing the

Appendix D, Page 10

104

## SECRET

## SECRET

Phillips-head screws that were removed in step 2a.

- (8) Lift the T-63 unit from the trailer with the hoist and suspend it over the door, lowering it until the pull-out cables may be installed. At this time, install the arming wire extension in the arming hook.
- (9) Then lower the unit until the rack can be cocked by means of the cocking lever, and insert ground safety pin.
- (10) At this time lift the unit and door simultaneously by means of handling ring No. 2 and hoist until wheels clear the ground. Make certain that the sway brace pads are properly lined up. The sway braces are to be tightened until they click; then continue tightening with equal pressure on each sway brace until as tight as possible with finger pressure.
- (11) Remove handling ring No. 2.
- (12) Remove all the mounting lugs from the T-63 unit.
- (13) Mounting of the Door on the Aircraft:
  - (a) Entrance to the bomb bay with the T-63 unit loaded on the door can be made from the right rear of the aircraft only. (Normal loading has entry made from the right front.)
  - (b) Roll door underneath the aircraft and proceed with the normal mounting procedure as with the standard door.
  - (c) Release the 1500 psi from the extend port of the right-hand main landing gear to restore struts to operational position.

b. Loading of the T-63 with the F-4 Dolly: (U)

- (1) In order to accommodate the T-63 suitably for loading on the B-57B, the dolly must be adjusted slightly. The bomb cradle must be offset to permit proper clearance of the loaded T-63 and the dolly beneath the aircraft. This adjustment is accomplished by removing

Appendix D, Page 11

105

## SECRET

## SECRET

the bomb cradle, removing the spacers from the right side, and reinstalling them on the left side. This results in an offset to the right.

- (2) Hoist the T-63 main body onto the F-4 Dolly cradle with the nose of the unit to the rear of the dolly. (CAUTION: The T-63 Unit is extremely nose heavy when loaded on the F-4. Consequently, locking pins must be installed to lock the unit to the F-4 Dolly cradle.)
- (3) The F-4 Dolly with the T-63 Practice Unit loaded (less tail assembly) is backed into the bomb bay cavity from the right rear of the aircraft. Approximate alignment on the unit is accomplished by lining the F-4 Dolly up with the bomb door by paralleling the dolly with the side of the bomb door. This is simplified by guiding the dolly so that it actually touches the lowered side of the door at both ends. Accurate accomplishment of this step greatly simplifies the final stages of fitting the lugs of the T-63 into the bomb racks.
- (4) After the T-63 has been positioned approximately, fully open the bomb door, bringing the racks and the lugs into line.
- (5) Install the pull-out cables. (It will be necessary to raise the unit slightly with the hydraulic lifts on the F-4 Dolly.)
- (6) Continue to raise the unit until the lugs may be locked into the rack. This step may require considerable maneuvering of the dolly as well as of the T-63 Practice Unit in order to align the lugs and the rack correctly, particularly if care was not taken in step number 1, above. With proper positioning of the dolly initially, all adjustments for final loading can be made by individual maneuvering of the four hydraulic lifts on the F-4 Dolly.
- (7) Release the T-63 from the F-4 Dolly and maneuver the dolly out from under the aircraft.
- (8) Install the tail fin of the unit. This is best accomplished by having two men hold it in position while a third replaces the screws. For replacing the screws in

Appendix D, Page 12

## SECRET

the four holes that are nearest to the bomb door structure, an offset ratchet screwdriver is required because of the very close working space.

- (9) Tighten the sway braces individually until each clicks, then continue to tighten them to finger tight.
- (10) Remove the carrying lugs from the T-63.
- (11) Close the bomb door.

5. T-63 POWER CHECK: The final step before releasing the loaded unit for operation is the T-63 power check to assure proper functioning of the loaded unit. (U)

- a. Rotate the bomb door to the OPEN position.
- b. Turn Master Armament Switch OFF.
- c. Close Fin Safety Switch. (The B-57B does not have the standard Fin Safety Switch because of the attitude of the aircraft which might permit the extended fin to strike the ground should the fin be opened on the ground. To get power to the fin motor, it is necessary to have the landing gear handle in the UP position. This may be accomplished by having the gear down locks put in and then actuating the gear handle to the UP position in the cockpit.)
- d. Battery (or external power) ON.
- e. Load light ON.
- f. FIN RE Switch to FIN X (fin retract to fin extend). After approximately 15 seconds the FIN X light should come on.
- g. FIN X to FIN RE and check FIN X light OFF.
- h. After 30 seconds, turn OFF Fin Power Switch.
- i. Close bomb door and remove power.

**CAUTION:** Make sure during this operation that while extending fin, the fin does not hit the ground.

- 6. SPECIAL WEAPONS LOADING PHOTOGRAPHS: (C)

Appendix D, Page 13

107

## SECRET

**SECRET**



**Figure 14: Special Weapons Door (C)**

**Appendix D, Page 14**

**108**

**SECRET**

**SECRET**



**Figure 15: T-63 Practice Unit with Handling Rings Installed (C)**



**Figure 16: T-63 Practice Unit Mounted on the Special Weapons Door (C)**

**Appendix D, Page 15**

**109**

**SECRET**

**SECRET**

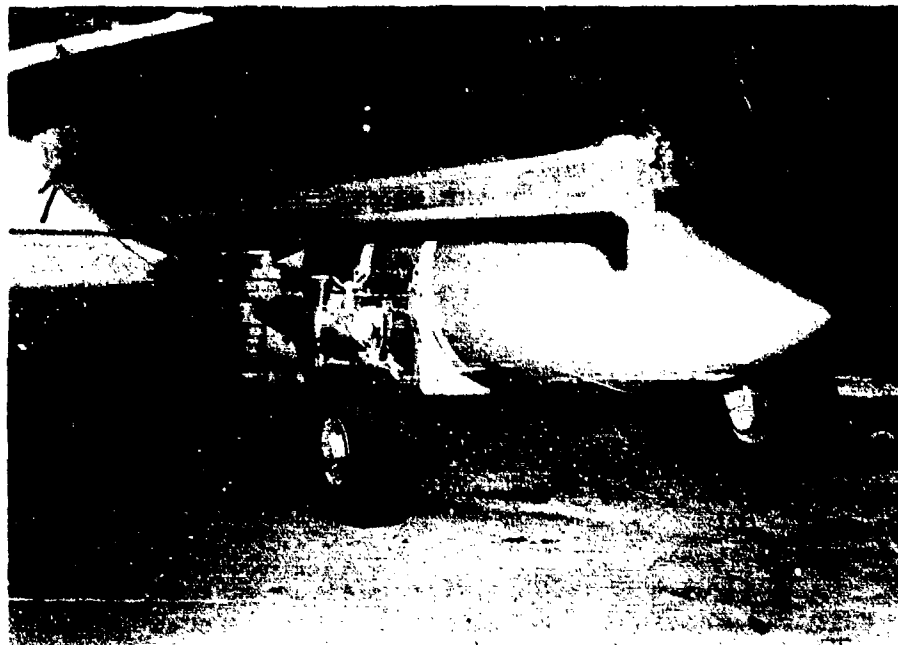

Figure 17: T-63 Practice Unit Mounted on the F-4 Dolly Ready for Mounting on the Aircraft (C)



Figure 18: T-63 Practice Unit (Fin Partially Extended) Mounted on the B-57 (C)

Appendix D, Page 10

110

**SECRET**

## SECRET

### DETAILED RECOMMENDATIONS

The numerous operational and functional deficiencies presented in Appendix C seriously impair the effectiveness of the B-57B weapons system. Correction of each of these defects will furnish a material increase in the overall effectiveness of the weapons system. The detailed recommendations for correction of deficiencies are as follows: (U)

#### SECTION I - RECOMMENDATIONS ON ARMAMENT SYSTEM DEFECTS

1. MACHINE GUN INSTALLATION: Install the modified link chutes and kits, Conversion, B-1 Guncharger (Part No. 801793) in the machine gun system. (U)
2. MARK 8 MOD 8 GUNSIGHT: Replace the Mk 8 Mod 8 Gunsight with a more suitable gunsight that eliminates the defects present in the Mk 8. (U)
3. RELEASE OF EXTERNAL ORDNANCE STORES:
  - a. Redesign the external pylons to provide positive release separation for all external stores at all operational airspeeds. (U)
  - b. Authorize manufacture and issue of the "kick-off" brace for interim use for release of external stores until more suitable pylons can be provided. (U)
4. RELEASE OF INTERNAL STORES - AN/M-26A1 PARACHUTE FLARES: Discontinue use of the AN/M-26A1 Parachute Flare for carriage in the B-57B in view of the doubtful carriage characteristics and ineffective illumination of the flares. (U)
5. ROTARY BOMB DOOR:
  - a. Emphasize in training programs the requirement for opening the bomb door well ahead of release times to permit fin extension of special weapons and a possible trim change from interfering with the bomb run accuracy. (S)
  - b. Provide a sufficient number of extra bomb doors in a unit to permit full advantage to be taken of the interchangeability feature. (U)

Appendix E, Page 1

## SECRET

### 6. SPECIAL WEAPONS LOADING:

- a. Abandon the "Handling Ring" Loading technique in favor of the F-4 Dolly technique in the interests of reducing turnaround time. (U)
- b. Improve the current F-4 Dolly (or similar units) to permit a greater ease of access for operation of the hydraulic lifting devices while the dolly and the T-63 are being maneuvered beneath the aircraft in preparation for locking the T-63 in the rack. (U)

### 7. ARMAMENT SYSTEM CONTROL DEVICES:

- a. Augment the current armament control panel with an auxiliary control panel in the observer's cockpit, providing a dual system for setting up the attack in all phases but the actual release impulse. This would permit the observer to set up the switches at the pilot's request without the pilot's visual attention being diverted from keeping the target in sight. (U)
- b. Install one rheostat type switch to control all 25 station lamps simultaneously, incorporating a "Lamp Check" - "Load Check" feature to provide an instantaneous check to determine if all lamps are working and which stations are loaded. (U)
- c. Relocate the bomb door switch and the bomb door position indicator in a position where they can be readily operated and visually monitored by the pilot with a minimum of movement and visual reference. (U)
- d. Modify the rocket firing circuit as necessary to accommodate the MA-3 Type Century Rocket Launchers as the primary rocket capability. (Refer to Paragraph 5, Appendix H.) (U)

### SECTION II - RECOMMENDATIONS ON GENERAL DEFICIENCIES

1. DIVE BRAKE ACTUATING SWITCH: Replace the present dive brake actuating switch with two independent switches, one to be located on the right throttle and the other on the left handle in the control wheel. (U)

Appendix E, Page 2

## SECRET

### 2. CANOPY AND WINDSHIELD DEFOGGING SYSTEM:

- a. Redesign the defogging system so that it will continue to deliver a sufficient volume of warm air for keeping the windshield and canopy free from moisture under all conditions of engine operation. (U)
- b. Provide a more positive and effective control mechanism for the operation of the defog blower. (U)

### 3. CABIN CONDITIONING SYSTEM:

- a. Reduce the temperature control mechanisms to one rheostat type control with sufficient range to assure a comfortable cockpit temperature at all extremes of ambient temperatures. (U)
- b. Install butterfly valves in the outlets at each crew position to provide a control over the volume and direction of flow of the conditioning air. (U)
- c. Provide a method for positively eliminating the formation of fog through the conditioning system at all altitudes and power settings. (U)
- d. Install small curtains in the upper part of the canopy to shade crew members from direct sun rays. (U)

4. CREW SEATS: Replace the present seat with a redesigned seat that provides for greater comfort and will accommodate the standard survival equipment for any given area. (U)

### 5. PERSONAL EQUIPMENT:

- a. Install the necessary fittings for accommodating the T-1 Partial Pressure Suit or any other pressure suit that will permit the aircraft to operate at its maximum altitude with full crew protection. (U)
- b. Make automatic opening parachutes standard equipment for crews operating the B-57B. (U)
- c. Initiate a complete program for development of night-readable check lists, maps, and other flight publications to reduce the amount of lighting required in the cockpit for use of these items. (U)

Appendix E, Page 3

## SECRET

### 6. INTERPHONE COMMUNICATIONS:

a. Install a "hot mike" system in the B-57B to permit crew members to communicate without having to depress microphone buttons, regardless of the position of their mixer boxes. (U)

b. Install a mixer box in the observer's compartment, identical to the one provided for the pilot, to permit the observer to realize full advantage of monitoring more than one source of transmission simultaneously. (U)

(U) c. Relocate the observer's mike button closer to his seat.

### 7. FUEL CONTROL SYSTEM:

a. Change the design and method of operation of the engine selector valves to preclude their accidental operation due to confusion with tank selectors.

b. Remove the No. 1 Fuel Pumps Switch from the fuel system entirely and permit the circuit breaker to be the only on-off operation for these pumps. (U)

c. Relocate the transfer valve in the vicinity of the Emergency Fuel Pumps, creating an "Emergency Sector" on the Fuel Control Panel and eliminating another source of confusion among primary control valves (engine and tank selectors) that have to be actuated with much greater frequency. (U)

d. Provide an indication for positive feeding of each wing tip tank and an indication when each tank is empty. (U)

### 8. CONTROL SURFACE TRIM INDICATORS:

a. Provide a redesigned elevator trim position indicator that is more realistic in respect to the range of trim movement versus the range of the indicator. (U)

b. Provide indicators for both aileron and rudder that will give position indications of each at all times. (U)

c. Combine all three trim indicators into one unit that can be checked at a glance. (U)

Appendix E, Page 4

## SECRET

9. RUDDER TRIM SWITCH: Replace the current rudder trim switch with a small wheel, permitting easy identification by feel and acting in the same horizontal sense as the rudder. (U)

10. LANDING LIGHT:

a. Install another landing light in the other wing to provide an acceptable safety margin for this aircraft that is designed to operate mainly at night. (U)

b. Relocate the landing light to remove it from directly aft of the cartridge and waste gas chute. (U)

11. TAXI LIGHTS: Reorient the present taxi lights and make them of sufficient intensity to serve safely as taxi lights. (U)

12. PILOT'S INSTRUMENT GLARE SHIELD AND COCKPIT CANOPY SILL: Redesign the instrument glare shield to permit better vision of all instruments without sacrifice in glare reduction. (U)

13. INTERNAL CONTROL LOCKS: Install positive internal control locks for all flight control surfaces, making them operable from the cockpit and providing a block to throttle travel when they are engaged. (U)

14. CANOPY CURTAIN: Provide some sort of a curtain to shade crew members and reduce daylight effect on the S-4 Shoran (HIRAN) scope. (U)

15. REAR VIEW MIRROR: Install a suitable rear view mirror on the windshield frame, orienting it so it can be adjusted to permit the pilot to see the observer. (U)

16. CHECK LISTS: Provide check lists suitable for reading in flight with only that light normally used in flight. (U)

17. COCKPIT FLOORING: Replace the canvas flooring in the cockpits with a light metal. (U)

18. PILOT'S CLIPBOARD: Install a clipboard or other device suitable for writing (Batori Computer, or like item) on the right cockpit sill in a manner that will permit it to be retracted completely out of the way while out of use or folded into writing position when required for copying a clearance or making other notations. (U)

Appendix E, Page 5

## SECRET

19. RADIO BEACON SIGNAL IN REAR COCKPIT: Install a Radio Marker Beacon Signal light in the rear cockpit to permit the observer to realize maximum advantage from the radio compass. (U)

### SECTION III - RECOMMENDATIONS ON S-4 SHORAN (HIRAN) DEFICIENCIES

The following recommendations for improving the system to a limited degree are offered: (U)

1. ALTITUDE LIMITATIONS: Relocate the Shoran equipment in the pressurized section of the fuselage. (U)

2. FUNCTIONAL RELIABILITY: Relocate the Shoran equipment in the pressurized section of the fuselage. (U)

3. GENERAL:

a. A study be made with a view toward relocating or reorienting all or portions of the S-4 Shoran installation in order to permit better accessibility for operation and maintenance. (U)

b. The AN/APN-84 be modified to eliminate the ghost pulse from the circular trace. (U)

c. The AN/APN-84 Receiver gain circuits and controls be modified to provide better operation at gain settings less than maximum. (U)

d. The length of the scope visor be increased or the entire visor be redesigned to eliminate the undesirable amount of "daylight effect." (U)

e. A study be made with the intent of adding an automatic pilot or some other similar device to increase the accuracy with which the arcs may be flown. (U)

Appendix E, Page 6

**SECRET**

**MAINTENANCE AND SUPPORT SUMMARY**

The security classification of this entire Appendix is UNCLASSIFIED.

1. **INTRODUCTION:** This appendix includes maintenance and supply data collected during conduct of Project No. APG/TAS/119-A, "Operational Suitability Test of the B-57B Aircraft."

2. **DESCRIPTION:** A detailed description of the B-57B aircraft can be found in the main body of the report.

3. **OBJECT:** To determine the operational suitability of the B-57B aircraft with respect to mission availability, supply support, maintenance, and personnel requirements incident to organizational maintenance and servicing.

4. **CONCLUSION:** The B-57B aircraft is operationally suitable to accomplish its mission in regard to maintenance, supply and personnel requirements.

5. **RECOMMENDATION:** The detailed recommendations listed in Inclosure 4 be incorporated in the B-57B, or added to the ground handling, as applicable.

Appendix F, Page 1

117

**SECRET**

## SECRET

### DISCUSSION

#### 1. ORGANIZATIONAL IMPACT:

a. Personnel: The maintenance and supply personnel authorized in Table of Organization 1-1157P, dated 1 June 1955, are adequate, in both skills and numbers, to perform the maintenance functions necessary to fulfill the operational requirements.

b. Training: Formal training for the aircraft and engine mechanics is desirable. However, with experienced supervisors, qualified mechanics can be transitioned into the authorized skill levels with on-the-job training. An on-the-job training period of 45 days with formal training and 120 days without formal training will qualify the aircraft crew chief and mechanics on the aircraft.

c. Equipment: There are no known items of ground handling or support equipment that impose undesirable limitations on the using or supporting organization.

#### 2. CAPABILITIES AND LIMITATIONS:

##### a. Capabilities:

- (1) The B-57B is capable of fulfilling the mission requirements insofar as the maintenance functions are concerned.
- (2) Personnel authorized in Table of Organization 1-1157P, 1 June 1955, are capable insofar as the numbers and skill levels required for performing organizational functions in the following areas:
  - (a) Aircraft Maintenance.
  - (b) Electronic and Photographic Equipment.
  - (c) Motorized Equipment.
  - (d) Technical Supply Support.
- (3) A tactical light bombardment squadron is capable of meeting the support requirements for the B-57B with the authorized equipment.

Appendix F, Page 2

## SECRET

b. Limitations: There is no particular limitation to the maintenance of the B-57B. However, time spent on the technical order compliance and modification program for the improvement of the operational capability and safety of flight of the B-57B limits the aircraft availability and utilization.

3. MAINTENANCE TECHNIQUES: There are no special maintenance techniques peculiar to this aircraft.

4. COLLECTIVE ANALYSIS:

a. When the B-57B aircraft were received at the test site, maintenance and test personnel were already familiar with the test item. Because of the concurrent RB-57 suitability test, most of the support equipment and supplies were available. As a result, the accelerated phase of this operational suitability test progressed without undue delay. However, as with the RB-57 aircraft, the B-57B aircraft were then plagued by repeated grounding periods awaiting fixes on one-time compliance technical orders. This condition lasted during the majority of the test period. The present maintenance situation indicates that the number of technical order compliances is diminishing and reaching an acceptable level.

b. The over-all maintenance of the B-57B aircraft is considered typical for a light bombardment type aircraft. Maintenance personnel attest to the ease with which this aircraft can be maintained. The accessibility of the systems is one of the particularly attractive maintenance features.

Appendix F, Page 3

# SECRET

## TEST PROCEDURES

1. Data were collected by utilizing the following:
  - a. DD Form 781, "Aircraft Flight Report and Maintenance Record."
  - b. AF Form 533, "Spare Parts Consumption Data for Initial Operation - New Aircraft."
  - c. AF Form 110, "Daily Aircraft Status Report."
  - d. AFTO Form 29, "Unsatisfactory Report."
  - e. APGC Form 8, "Aircraft Status and Utilization Log."
  - f. APGC Form 0-519 (Test), "Daily Maintenance Record."
  - g. Daily notations made from observations and discussions with maintenance and supply personnel.
  - h. Weekly compilation of the organizational and field maintenance required to support the three test aircraft.
2. During the reporting period, the following were investigated:
  - a. Aircraft availability.
  - b. Scheduled and unscheduled maintenance requirements.
  - c. Aircraft systems.
  - d. Support equipment.
  - e. Supply support requirements.
  - f. Personnel requirements.
  - g. Training requirements.
  - h. Publications.

Appendix F, Page 4

Inclosure I

120

SECRET

**SECRET**

TEST RESULTS AND DISCUSSION OF RESULTS

1. AIRCRAFT AVAILABILITY:

TOTAL CALENDAR HOURS AVAILABLE	HOURS IN COMMISSION		HOURS OUT OF COMMISSION		
	Flying	Not Flying	Maint	AOCP	TOC
19282	359	5100	5700	1005	7118

Percent In Commission 28%

Percent Out of Commission for TOC 38%

2. MAINTENANCE MAN-HOUR EXPENDITURE:

A/C Ser No.	ORGANIZATIONAL		FIELD	TOC	
	Scheduled	Unscheduled		Orgnl	Field
52-1500	1302:15	1020:20	425:30	426:50	122:30
52-1501	2009:05	2923:30	1237:45	1284:10	603:30
52-1502	865:55	788:55	722:15	496:50	415:45
52-1503	1431:10	921:20	848:25	732:10	486:00
<b>TOTALS</b>	<b>5608:25</b>	<b>5654:05</b>	<b>3233:55</b>	<b>2940:00</b>	<b>1627:45</b>

AIRCRAFT SYSTEM	TOTAL MAN-HOUR EXPENDITURE (ORGNL)
Airframe	4319:20
Landing Gear	527:40
Hydraulic	234:55
Utility	809:45
Power Plant	2110:30
Fuel	410:30
Electrical	594:25

Appendix F, Page 5

**SECRET**

<u>AIRCRAFT SYSTEM</u>	<u>TOTAL MAN-HOUR EXPENDITURE (ORGNL), Cont'd.</u>
Instrument	182:35
Radio-Radar	425:55
Armament	1218:35
Photo	5:30
Electronic	77:30
Fuel Servicing	150:30
Oxygen Servicing	117:00
Oil Servicing	77:50
<b>TOTAL</b>	<b>11262:30</b>

**3. INSPECTION MAN-HOUR EXPENDITURE:**

<u>TYPE INSPECTION</u>	<u>TOTAL MAN-HOURS EXPENDED</u>	<u>NUMBER OF INSPECTIONS</u>	<u>AVERAGE MAN-HOURS INSPECTION TIME</u>
Preflight	1153:67	180	6:4
Postflight	733:92	125	5:9
<u>Periodic</u>	<u>3267:83*</u>	<u>7</u>	<u>466:8**</u>

\* This includes 1159:5 man-hours expended on TOC.

\*\* Eliminating TOC, the average periodic inspection time is 301:2.

**4. AIRCRAFT SYSTEMS:** All of the aircraft systems were investigated. The following list includes the particular deficiencies and malfunctions of the major aircraft systems:

**a. Power Plant:**

- (1) During the testing period six engines were changed. The average number of man-hours required to accomplish an engine change was 25. This includes removing and replacing the engine cowling. The engine change was accomplished with a four-man crew and a built-up engine. The average time required to "build-up" a J65-W-5 engine was 43.5 man-hours.

Appendix F, Page 6

Inclosure II

122

**SECRET**

## SECRET

- (2) Three engine changes were made during periodic inspections. According to T.O. No. 2J-J65-2, "Handbook, Service Instructions, Models J65-W-3, J65-B-3, J65-W-5 Aircraft Engines", an engine must be changed if the distance between the longest and shortest rotor blades in the turbine wheel exceeds .007 inches.
- (3) The primary trouble area was the turbo starter assembly. A new design improvement has been incorporated. The lever arm, P/N 292C180G1, has been increased in cross sectional area to provide the necessary additional strength. This improvement was incorporated into the model C-1 starter and is currently used in the production, during the overhaul, and in the retrofit of all starters.
- (4) The following trouble areas were encountered and reported on AFTO Form 29, "Unsatisfactory Report".
  - (a) Turbo Starter Assembly - Eglin AFB UR S/N 54-963, 55-44.
  - (b) Failure of Shock Absorber Lever on Turbo Starter Assembly - Eglin AFB UR S/N 54-966.
  - (c) Connector Assembly - Eglin AFB UR S/N 54-1040.
  - (d) Gasket - Contact Bolt - Eglin AFB UR S/N 54-1061.
  - (e) Starter Fairing Assembly - Eglin AFB UR S/N 55-162.
  - (f) Bolt Latch - Eglin AFB UR S/N 55-358.

b. Armament:

- (1) There were repeated malfunctions with the M3 machine gun. Of the total of 42,400 rounds loaded for 18 missions, 28,764 rounds were actually fired for a fire-out rate of 68%. The malfunctions were a result of:
  - (a) B-1 gun charger failure - 10 times.

Appendix F, Page 7

Inclosure II

123

## SECRET

**SECRET**

- (b) Cartridge discharge link chute jamming - 11 times.
  - (c) Misaligned ammunition - 4 times.
  - (d) Improper ammunition box loading - 1 time.
  - (e) Failure of cartridge to extract - 2 times.
- (2) Vibration causes the links to half-turn as they drop through the flexible link chute, P/N CRA-90A4F5. The links, piling up in the flexible chute, result in a jammed link in the mouth of the link stripper assembly, P/N CRA-1-7/16S90. This condition was corrected by enlarging the rectangular shaped funnel to the size and shape of the opening in the link retaining compartment.
- (3) "Turn around" time: Refer to Paragraph 11b, Appendix B.

c. Fuel: There were no excessive man-hours of unscheduled maintenance expended on this system. The following is a list of repeated malfunctions:

- (1) Fuel syphoning occurred several times during the initial climb of the aircraft. The diaphragm in the fuel float valve, P/N 20-1227-000, was being ruptured from improper torquing of the valve stiffeners and/or uneven thickness of the diaphragm. UR's have been submitted on the valve assembly, S/N 54-858, 54-999, and 54-1000.
- (2) Fuel accumulated in the tail cone and drained back into the belly of the aircraft as a result of the location of saber vent. A relocation of the overflow from station #40 to station #45 would eliminate this condition. The following UR's have been submitted: S/N 54-812, 54-990 and 54-1007.
- (3) The wing tank vent pressure actuated switch (Meletron Switch, P/N 417-6-47) has been UR'd because of the 34 screws in the removable wing plates. An Engineering Change Proposal was approved by the AMA for the installation of flush type drain valves. This will facilitate draining the Meletron switch cans without removing the panels.

Inclosure II

Appendix F, Page 8

124

**SECRET**

## SECRET

### d. Airframe:

- (1) The forward support bomb hoist fittings, P/N 272-7040114-1 and 2, were damaged and/or broken during the loading and unloading of the bomb doors. This was caused by the hoist slipping from the notch of the fitting and as a result transferring the entire weight of the door and bombs onto this bracket. Unsatisfactory reports have been submitted recommending a more secure method of engaging the bomb hoist and forward support fittings.
- (2) The right hand elevator tab assembly, P/N 272-4700009-10, rubbed on the tail cone assembly when the elevator was in the "up" position and the stabilizer trim was in the "down" position. The vendor of the empennage has informed the contractor that the skins on the spare elevator tab assemblies are manufactured one-fourth inch oversize and therefore should be trimmed at each installation.
- (3) "Popped" rivets and cracks were found on the control surfaces. These conditions were UR'd and the rivets were replaced.
- (4) During and after high winds, the rudder and elevator control surfaces have been found to be damaged. The locks are too small to effectively "hold" the surfaces. Present plans call for a modification technical order to be written which will provide a more positive lock assembly. Unsatisfactory reports have been submitted on this discrepancy.

### e. Utility:

- (1) The rated capacity of the liquid oxygen converter is in error. On ten or more tests conducted, it was found that 4 liters of liquid oxygen is the maximum that the converter will hold. The rated capacity listed in the applicable T.O.'s and also on the manufacturers' data plate on the converter itself is 5 liters and the oxygen duration charts in the pilots' handbooks are all based on this capacity. This has been submitted in an unsatisfactory report.

Appendix F, Page 9

Inclosure II

125

## SECRET

## SECRET

- (2) During servicing, liquid oxygen would not flow into the system. Investigation revealed that the retainer ring, P/N 92587-43 in the filler valve, P/N FR-1-A1, was pushed out of the groove. This could be caused by the valve in the servicing hose being frozen and forcing the valve, P/N 738703-1, in the filter valve beyond its normal travel, thereby causing the retainer ring to break and/or be forced out of the groove. The retainer ring has been changed to a heavier material and unsatisfactory reports have been submitted — Eglin AFB S/N 55-272 and 55-339.

### f. Electrical:

- (1) Aircraft batteries were discharging when the aircraft were standing idle for a short period of time. Investigation revealed that the voltage regulator on the standby instrument inverter, P/N AN3532-1, was wired directly to the battery hot bus. A battery switch placed in the standby instrument inverter would eliminate this condition.
- (2) The battery can be used as a source of power to fire the cartridge on the starter for the engine. The power then being generated by the first engine can be used to fire the cartridge on the other engine starter. This starting procedure would minimize the need for the battery cart for all engine starts. It is necessary to note, however, that auxiliary power essential for preflight and postflight inspections.

### g. Radio-Radar:

- (1) Radio: Approximately 96 maintenance man-hours were expended on correcting repetitive radio malfunctions.
  - (a) ARN-6 Radio Compass:
    1. Radio compass sensing antenna came loose or broke at the canopy connector six times; receipt and compliance with Technical Order 1B-57-555, "Installation of blade type sense antenna for ARN-6," should correct this difficulty.
    2. The Radio Compass was reported to be inaccurate and unreliable in stormy weather. Thirty Appendix F, Page 10

Inclosure JI

## SECRET

maintenance man-hours were expended in attempting to correct the difficulty. Compliance with Technical Order 1B-57-555 should correct this difficulty.

- (b) Radio receiver R-122 ARN-12. The marker beacon light was frequently reported to be inoperative above 6000 feet altitude. A study of the technical order on this equipment revealed that the equipment lacks a switch in the lamp and switch assembly part number AN-3157-4. (Refer to Section 3, Paragraph 3-5, Page 5, T.O. 12R5-2ARN12-2, "Marker Beam Receiving Set AN-ARN-12.") Installation of such a switch on another aircraft, not being tested, on which this trouble was reported, corrected the difficulty. The failure of the lamp at altitude according to the Technical Order is that the strength of the signal received at altitude is insufficient to light the lamp. The switch is used to change from low to high sensitivity of the receiver. None of the equipment installed has such a switch and the reason for its omission is unknown. A UR was submitted.
- (c) The pins on the male portion of the quick disconnect plug, P/N AN-3100A-18-12P, located under the ejection seats were found loose or broken on six occasions. Replacement time averaged 4:15 maintenance man-hours. The rigidity of the installation appears to be a factor and a more flexible connection would appear desirable.
- (d) The condenser on the Marker Beacon Antenna Assembly, AT-134 located on the inside bottom of the fuselage between frames 37 and 38 was found broken on two occasions. This was attributed to the equipment being stepped upon by maintenance personnel. The gears on the ARA-19 tuning drive, used in connection with the ARN-6 receiver, jammed on 4 occasions. This caused malfunction of the automatic tuning on the compass. The average time for trouble correction was four maintenance man-hours. The cause of the difficulty appeared to be improper adjustment on installation. A slight inadvertent deviation from the required relative installation of the tuning drive, and the receiver puts a strain on the gears and drive shaft which results in the difficulty.

Inclosure II

Appendix F, Page 11

127  
**SECRET**

## SECRET

(2) Radar:

- (a) Several missions were cancelled due to malfunction of the S-4 Shoran Equipment. Three-fourths of the maintenance man-hour expenditure shown under Paragraph 2 for "Radio-Radar" was expended on the S-4 Shoran Equipment. It was very difficult for maintenance personnel to maintain this set due to the lack of adequate maintenance publications. Toward the end of the test, the manufacturer's publication "Field Engineering Manual-Shoran Set AN/APN-84" was received. Subsequent to the receipt of this publication Modifications One and Two were accomplished, and parts were ordered for Modification Number Three. Modification Number One has to do with the T-342 Transmitter, the range indicator and the signal comparator.
- (b) Modification Numbers Two and Three deal with the range indicator and the signal comparator only. After this publication was received, three successful missions were flown with this equipment. The transmitter, T-342, gave the most serious trouble. One hundred twelve man-hours were expended on this trouble alone. The commutator was found to be out of adjustment eight different times. Other troubles encountered were non-repetitive, but required the expenditure of 51 maintenance man-hours for correction.

5. SUPPORT EQUIPMENT: All of the supporting equipment was investigated.

a. The following deficiencies were noted with the support items:

- (1) Tow Bar: This item has been modified to prevent damage to the pitot tube shaft when the aircraft is being towed over uneven terrain and/or when the tug makes a left turn. The tow bar is suitable when used with a tug that has a low hitch.
- (2) Bomb Doors: Presently there are no extra bomb doors assigned to a squadron. To minimize turnaround time for this aircraft, it is necessary to utilize pre-loaded bomb doors.

Appendix F, Page 12

## SECRET

- (3) MA-1 Servicing Unit: This unit, Stock Number 8210-810200, is suitable as a multipurpose aircraft ground truck.

b. The following items are tools requested by maintenance personnel. The addition of these tools to the kits would decrease the time expended on maintenance in general.

(1) Communication Requirements:

- (a) Adequate hand tools for Cannon plugs would be water pump type pliers with hard leather or fibre gripping jaw seats. Recommend one per tool kit.
- (b) Stakon wrenches are not authorized but are necessary to facilitate maintenance. Recommend one per tool kit.
- (c) Spintite wrenches in standard sizes are needed to facilitate maintenance because of the inaccessible locations of various parts. Recommend one set per tool kit.
- (d) Wire strippers are necessary for the communication section. Recommend one per communication section.
- (e) Speed wrenches for Allen head screws will considerably decrease the man-hours expended in removing the 16 screws on the AN/ARC-27. Normally, 10 to 15 minutes are consumed in removing these 16 screws. With a specially designed speed wrench, this time could be reduced to two or three minutes. This, multiplied by the number of ARC-27 sets in a squadron, would result in a considerable saving in man-hours. Recommend consideration for such a tool and issuance of one per communications section.

(2) Airframe Requirements:

- (a) A tire pressure gage is a necessary tool to be added to the mechanic's tool kit.

Appendix F, Page 13

## SECRET

- (b) No special tool has been issued, at the present time, for removal of the brake assemblies. They are presently being removed with mallets.
- (c) No bearing puller has been issued, at the present time, for removing bearings from the axle prior to removing the axle on the nose landing gear. The axles are presently removed with hard rubber mallets.

c. Presently, two headsets, H-70/A/C (28800-70) Class 16-A, S/N 1790-207385219, are authorized in the ECL 30-30-AICIO. However, when two or more aircraft need communications preflights or postflights, there is a maintenance delay in that two men are required to check out the equipment in each aircraft. This results in other aircraft awaiting maintenance. It is recommended that two headsets be assigned to every four aircraft.

### 6. SUPPLY SUPPORT REQUIREMENTS:

a. Spare Parts Consumption: A complete list of the spare parts consumed has been submitted on AF Form 533, "Spare Parts Consumption Data for Initial Operation - New Aircraft."

b. Test Support Table: This table, as compiled by the Glenn L. Martin Aircraft Company, is unsatisfactory. The items are not listed in a class code sequence and consequently it is necessary to completely screen the table each time information is received or desired. Further, many items were received under different stock numbers than previously listed in the table. This resulted in warehouse storage of some test support items.

c. General: The AFSD is considered generally satisfactory. Upon completion of the test, approximately 75 line items had not been received. Numerous items were received from AF depots which were not listed in the AFSD #9608950 and #9608951. (During the concurrent tests on the B-57B and RB-57 type aircraft, many of the support items were interchangeable.)

d. Tentative Table of Equipment: The Tentative Table of Equipment, dated 15 April 1955 is adequate. An organization equipped with the items listed in this table is capable of meeting the support requirements.

Appendix F, Page 14

Inclosure II

130

## SECRET

## SECRET

e. Equipment Component List: There are discrepancies between the number of assigned manual bomb hoists, S/N 8220-406000, in ECL 20-43-11 dated 25 April 1955, (Airframe Special Tools and Equipment Maintenance) and ECL 20-00-5, dated 1 Dec 54, (Aircraft Organizational Maintenance). The former authorizes one hoist per three aircraft and the latter authorizes four hoists per two aircraft. Four hoists are necessary to mount a fully-loaded bomb door. Therefore, ECL 20-43-11 is in error and a request for change has been submitted.

7. PERSONNEL REQUIREMENTS: Table of Organization, T/O 1-1157P dated 1 June 1955, is adequate. No additional personnel are required.

8. TRAINING REQUIREMENTS: Factory training is desirable in aircraft familiarization for the maintenance supervisors and aircraft crew chiefs. The crew chiefs can then train the remaining crew members. The senior level specialists in the remaining fields (Hydraulics, Electronics, Communications, etc) are considered proficient to maintain their respective systems.

9. PUBLICATIONS: The following aircraft and engine technical orders have been investigated. The deficiencies found will be compiled and submitted on AFTO Form 29, "Unsatisfactory Report."

a. Technical Order No. 1B-57B-1, "Flight Handbook", dated 15 February 1955, has been adequate since revision.

b. Technical Order No. 1B-57B-2, "Handbook of Maintenance Instruction", dated 14 March 1955 has been broken down into 13 separate handbooks on the individual aircraft systems. These handbooks were received starting in May 1955 and to date have proven very satisfactory.

c. Technical Order No. 1B-57A-3, "Handbook of Structural Repair", dated 30 March 1955, has been suitable since revised.

d. Technical Order No. 1B-57A-4, "Parts Catalogue", dated 6 April 1955, is vastly improved over earlier publications. No deficiencies have been reported since the receipt of the revised publication.

e. Technical Order No. 1B-57B-5, "Handbook Basic Weight Checklist and Loading Data", dated 28 March 1955, has been satisfactory.

f. Technical Order No. 1B-57A-6, "Handbook of Inspection Requirements", dated 5 January 1955, has not yet been received from the prime depot. The supplements are being received through channels.

Appendix F, Page 15

Inclosure II

131

## SECRET

## SECRET

g. Technical Order No. 1B-57A-7, "Winterization Instructions and Check List," dated 22 October 1954, was evaluated in the Arctic Phase Report, APG/TAS/119-C.

h. No technical order has been received, or, as far as is known, has been published on the S-4 Shoran equipment. However, the manufacturer's publication "Field Engineering Manual — Shoran Set — AN/APN-84," which was received prior to the termination, appears to be adequate and was effectively used during the short period of the test it was available.

Appendix F; Page 16

Inclosure II

132

## SECRET

## SECRET

### DETAILED RECOMMENDATIONS

1. A more secure method of engaging the bomb hoist and forward support fittings be provided.
2. A more positive locking assembly be provided to hold the control surfaces.
3. One extra bomb door be assigned to each three aircraft in a light bombardment squadron.
4. The hand tools listed in Inclosure 2, Paragraphs 5b(1) and 5b(2) be added as recommended.
5. ECL 30-30-A1C10 authorizing the number of assigned communication headsets be increased to two sets per four aircraft in a light bombardment squadron.
6. ECL 20-43-11 and ECL 20-00-5 be reviewed to determine the correct number of manual bomb hoists to be assigned per aircraft.
7. Technical Order 1B-57B-6, "Handbook of Inspection Requirements," dated 5 January 1955, (Basic Handbook) should be forwarded to the using organizations from the prime depot.
8. Technical Order No. 1B-57A-7, "Winterization Instructions and Check List," dated 22 October 1954, be revised as recommended in the Arctic Phase Report, APG/TAS/119-C.
9. A technical order be published on the S-4 Shoran equipment based on the RCA publication "Field Engineering Manual, Shoran Set AN/APN-84."
10. Protection be provided for the marker beacon antenna assembly AI-134 or the equipment be relocated.
11. An engineering study be made to determine the feasibility of installing switch P/N AN-3157-4 in connection with Radio Receiver R-122 ARN-12 and the marker beacon light to improve its functioning at higher altitude.
12. T.O. 12R5-ARN12-2 be revised to give more accurate information in regards to the absence of the above switch from the system.

Appendix F, Page 17

Inclosure III

133

## SECRET

## SECRET

### HUMAN FACTORS

#### 1. INTRODUCTION:

a. This section provides detailed descriptions of the Night Intruder APW-11A and LABS missions and outlines recommended Special Weapons Training and procedures. These missions were selected for study since the intent of the Human Factors Team was to provide only that information not readily available to the training officer. Other system missions such as Shoran, Strafing, Dive Bombing, etc., were not considered since most B-26 units are already experienced with these problems. The descriptions of the LABS and APW-11A missions include the equipment associated with the mission and pertinent check lists and SOP's. A bibliography of relevant reference documents is also provided. (U)

b. Investigation disclosed that official Technical Order Handbooks were not available for the LABS and APW-11A Bomb Systems. The information contained in the Maintenance Technical Orders for these systems was felt to be too technical and otherwise inadequate for providing the aircrew operators with the knowledge background required. (U)

c. Considerable training type information concerning these systems was found in various source documents (WADC reports, APGC reports, Factory Manuals, etc.). Inspection of the distribution lists for these documents disclosed that very few, if any, of these documents had been distributed to the Tactical Air Command Light Bomb Wings at the time of their issue, since a requirement for this type of information did not exist at that time. To facilitate the flow of this information to the using wings in a form immediately usable for training of B-57B aircrew personnel is the purpose of this section. These mission descriptions should be considered merely as preliminary orientation material. More adequate training manuals will no doubt be provided at a later date. (U)

#### 2. THE APW-11A MISSION:

##### a. Introduction:

- (1) The APW-11A is a radar guidance system consisting of a ground radar station (the MSQ-1), an airborne radar group (the APA-90). This system provides the

## SECRET

B-57B with a blind bombing and navigational capability that enables it to provide close front line support under all-weather conditions, in both day and night operations. The APW-11A system may be used for straight and level bombing of all types of stationary targets and has a potential for positioning the aircraft to attack moving targets with rockets or machine guns. (U)

- (2) The requirement for this system derives from the fact that cloud cover frequently makes visual high level and dive bombing impossible. On such occasions the ability either to bomb through the clouds from a high altitude, or to break through the clouds in position for a short low level run, is essential. (U)
- (3) The APW-11A system permits the controller of a single ground radar station (the MSQ-1 component) to measure the range, azimuth, and elevation of the bombing aircraft. From a knowledge of the range and azimuth of the target relative to the ground station, and the measured positions of the aircraft, the controller can direct the pilot to fly a suitable course to the desired bomb release point. The MSQ-1 ground equipment consists of an automatic tracking radar, a computer, a command coder, and other necessary electronic equipment. The APW-11A airborne transponder beacon, in addition to providing the visual beacon function to the ground station, also provides a command channel for directing the aircraft, when interrogated by the MSQ-1. (U)

b. General: This system was first tested in 1950. It was essentially a further refinement of the original SCR-584 equipment. To attempt to counter enemy jamming this system incorporated an airborne beacon, the APW-11A. This airborne beacon not only aided tracking but provided a pulse coded command channel used by the MSQ-1 operator to direct the aircraft. Being a transponder, the APW-11A Beacon, when interrogated by an appropriately coded radar pulse, emits a return signal. This strong beacon reply enables the ground station to track the aircraft for a much further distance than it could by skin-tracking alone. The computer, as it is fed information regarding altitude and range, first calculates the present rate, then a predicted future position and finally on the basis of this information automatically computes the bomb release point. A further improvement was the APA-90 Indicating Group by which guidance directions are visually presented to the pilot. Commands are received by the APW-11A as various combinations of certain

Appendix G, Page 2

135

## SECRET

## SECRET

frequencies. Each such combination triggers off a different relay and in turn, sends current to a certain light bulb. Placed on the instrument cover directly over the light bulb is a decal bearing a command. Through this command channel it is possible for the ground operator to transmit up to 25 different instructions or commands to the pilot. The display as found on the pilot's instrument panel in the B-57B is shown in Figure 19. (C)

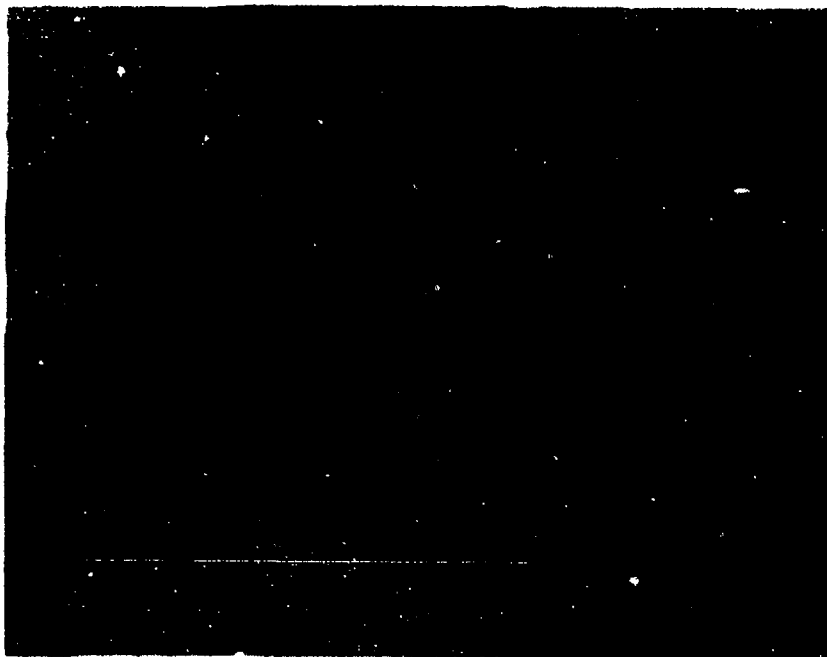

Figure 19: APA-90 Indicator Installation in the B-57B (U)

In early 1954 the MSA-2 Steering Angle Error Computer was added to the MSQ-1 System. The purpose of this item is to compute the bomb release point from any direction to the target. With this addition to the system it is not necessary for the aircraft to be held on one straight-in approach course since the computer continually calculates a new in-bound course to the nearest release point. This is analogous to "homing in" on the radio compass as contrasted to "tracking in" on a predetermined heading. Most recently, the circuitry of the APW-11 has been improved and refined resulting in the APW-11A equipment which

Appendix G, Page 3

**SECRET**

has no essential differences in display or function.



Figure 20. MSQ-1 Consoles and Plotting Board (C)

c. Guidance Procedures:

- (1) Following takeoff the aircraft is picked up by GCI and guided to a rendezvous point at a scheduled time. GCI informs the pilot when he is over the rendezvous point and gives him the altitude and heading to fly so that the MSQ-1 radar operator can pick him up. (See Figure 21.) (C)

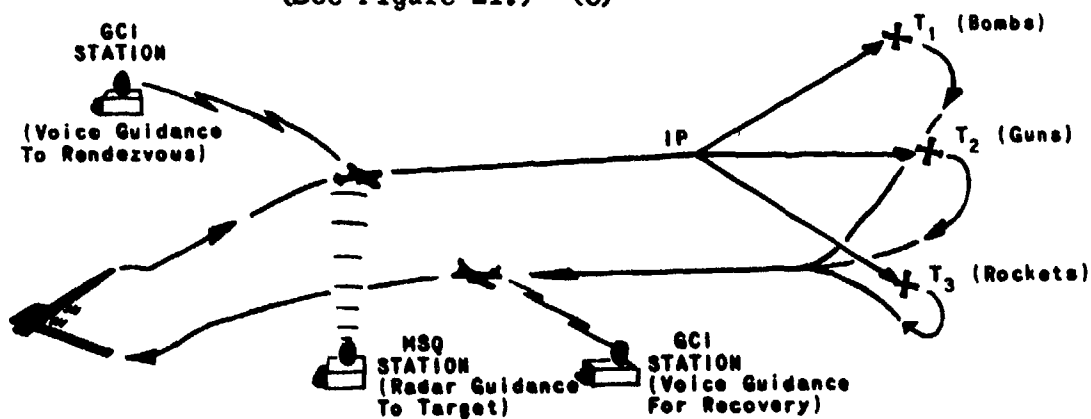

Figure 21: GCI - MSQ-1 COORDINATION (U)

Appendix G, Page 4

**SECRET**

## SECRET

- (2) The MSQ-1 radar operator monitors the flight path from rendezvous point to the IP making radar contact as close to the rendezvous point as possible. When "lock-on" has been accomplished the red Radar Contact Light illuminates at the top of the pilot's APA-90 Indicator. (See Figure 19.) (This is the first indication to the pilot that he has been picked up by the MSQ-1 station.) At this time the pilot may call the MSQ-1 controller to identify the type ordnance carried so that the aircraft can be directed to an appropriate target. The same IP may be used for several targets and is so selected as to provide a minimum 90,000-yard course to the target. (C)
- (3) The aircraft remains under MSQ-1 guidance from the radar contact point following rendezvous point passage until bombs away. Thereafter, the aircraft is again picked up by GCI and may be directed to another area where visual attack is possible or it may be guided back to the base, whichever the case may be. (C)

d. Guidance and Action Commands:

- (1) Commands from the MSQ-1 ground controller are portrayed for the pilot on an indicator as illustrated in Figure 19. Each individual instruction or command is printed on a removable decal which has been inserted in the appropriate place on the faceplate of the indicator. Choice of commands to be used is made by the using agency. Each decal is illuminated by an individual light bulb whenever the appropriate airborne relays are energized by a coded pulse transmission received from the ground MSQ-1 transmitter. The ground controller also has identical removable decals on his MSA-2 Control Panel. (See Figure 22.) It is doubtful that the decal designations would ever be changed for any particular theater of operations once initially established. (C)

Appendix G, Page 5

138

## SECRET

**SECRET**

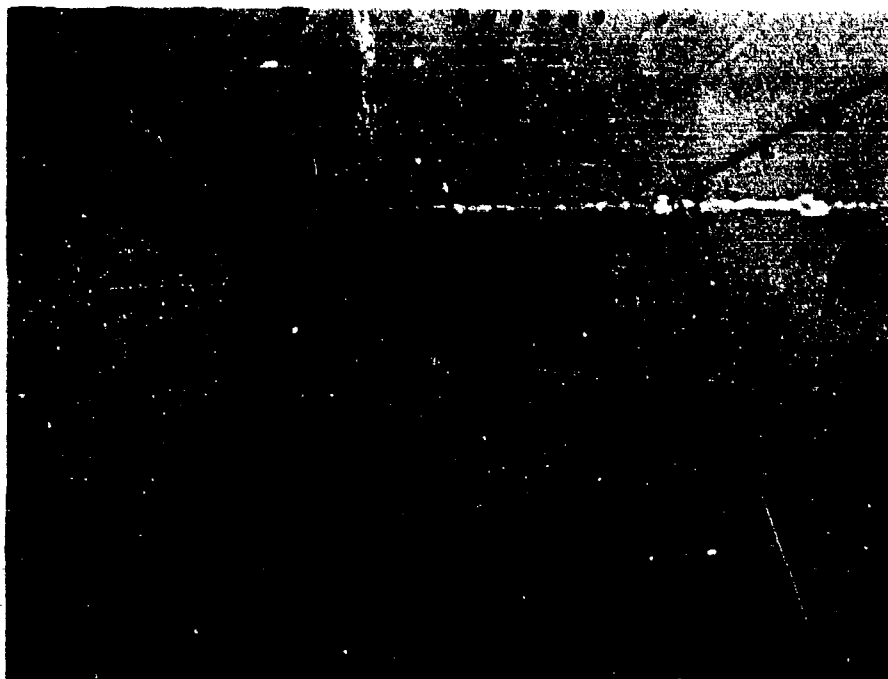

Figure 22: MSA-2 CONTROL PANEL (C)

- (2) Commands always consist of a primary signal followed by a secondary signal, the latter being accompanied by a headset tone. The pilot acknowledges the command by depressing a "Roger" button and simultaneously initiating the appropriate action. Depression of the "Roger" button "erases" the signal from the pilot's indicator, leaving it clear for the next signal and simultaneously indicating to the ground radar operator that the signal was received. In the event that the pilot should fail to depress the "Roger" button, the ground controller, by observation of the aircraft's track, can determine if the pilot has made the correction, in which case he can erase the signal from the ground by either issuing the next primary signal or by a special erase button. In the event the pilot failed to "Roger" and also failed to make the correction, the ground operator would erase the signal and transmit a different signal for test purposes. If this second signal also failed to elicit a "Roger" and/or a correction, then a malfunction of the primary guidance equipment would be

Appendix G, Page 6

139

**SECRET**

# SECRET

assumed and the alternative guidance system would be employed (see paragraph f, below). (C)

(3) Primary and Secondary Signals:

- (a) For each primary signal there are five secondary signals. (C)

<u>Primary Signals</u>	<u>Secondary Signals</u>
(meaning turn right) (meaning turn left) . . . . .	2°, 5°, 10°, 30°, 90°
Fly at . . . . .	1, 5, 10, 20, 30 (thousands of feet)
Prepare to Action ) . . . . .	Control Check, Bomb, Strafe, Rocket, Return to base

Ordinarily the secondary signal immediately follows the primary signal. One of the first commands received after first radar contact is to FLY AT (given altitude) feet. The pilot should thereafter strive to maintain this altitude as closely as he can, however, the MSQ computer continuously monitors the actual altitude of the aircraft and recalculates a new bomb release point instantly for any altitude change (the computer cannot keep up with very rapid altitude oscillations, and these must be avoided). Airspeed is maintained as briefed, though here again the computer will keep up with airspeed changes if they are not made too rapidly. (C)

- (b) The ground controller reads the steering angle error directly from a dial on his console. As soon as a need for correction is noted he manipulates two toggle switches resulting in the transmission of first, the primary left or right arrow signal, second, the appropriate number of degrees to turn. It is important to note that the steering angle error calculated by the MSA-2 computer is actually the correction that must be made to establish a new inbound heading to the closest bomb release

Appendix G, Page 7

**SECRET**

point; this correction will not necessarily bring the aircraft back to any inbound heading previously held and in fact seldom, if ever, does this. (C)

- (c) During the last 60 seconds of the bomb run preparatory and action commands are automatically transmitted to the pilot. At the Air Proving Ground Command the MSQ-1 equipment was set up to transmit the primary PREPARE TO signal 35 seconds from bomb release. (See Figure 23.)

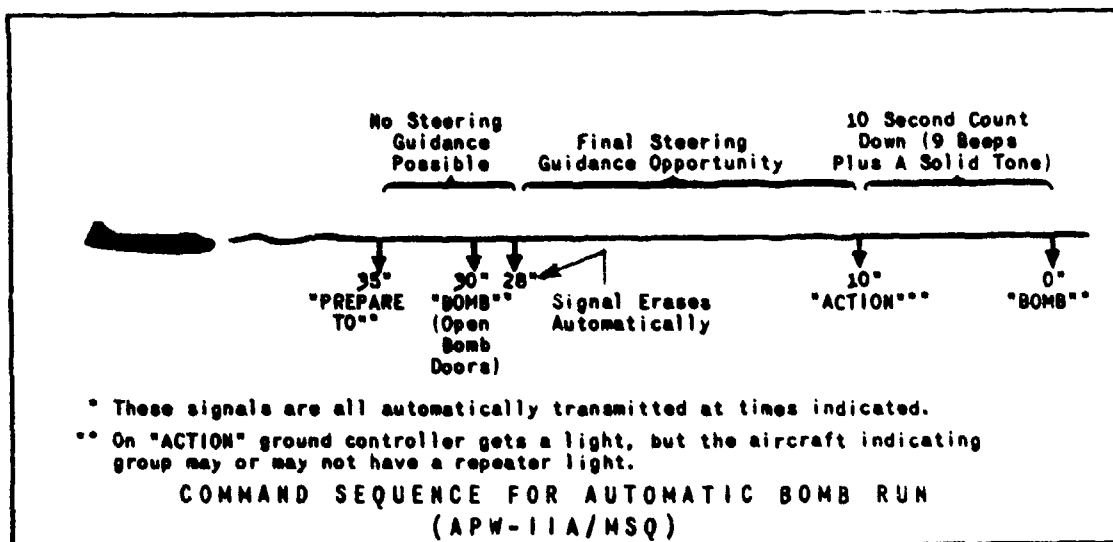

Figure 23: Automatic Bomb Run Command Sequence. (S)

This time can be varied up to 60 seconds from "bombs away" as desired by the using agency. As can be noted from the diagram the preparatory command consists of two signals PREPARE TO and BOMB (or STRAFE or ROCKET) spaced five seconds apart. At this time the pilot opens bomb bay doors; the command of execution (the BOMB signal) is preceded by a 10-second "count-down" which consists of 1/4 second tones sent out each second for nine seconds followed by a

## SECRET

one-second tone. The BOMB decal is illuminated just as the one-second tone terminates, thus giving the pilot two simultaneous indications for depressing the bomb release button. (C)

e. Other Uses for the APW-11A System:

- (1) The APW-11A system theoretically may be used to guide aircraft to strafing, rocketry, or dive bombing targets (though this would be more applicable to the day rather than the night situation). Theoretically, it would then seem helpful at night or during conditions of poor visibility if the pilot could be placed in such a position that he knew the target area was directly ahead of him. In the case of small size or moving targets he would then visually seek out the targets for attack. Conceivably, the pilot could blindly strafe a large bivouac area or other large area target with some success through the use of this system. (C)
- (2) The guidance used for such missions would essentially be the same as for straight and level bombing. Descending changes in altitude would be programmed so that the aircraft is at an appropriate altitude from which to commence the attack when the action command signal is received (either STRAFE or ROCKET or BOMB). In the case of dive bombing, the aircraft could be safely guided during a descent through cloud layers, so that it will break out into VFR conditions on a heading to the target. The pilot could then initiate a visual attack upon a target. (C)
- (3) The TAC has evidently met with some success in the development of this technique for day operations. The following quotation from "Manual of AN/MSQ-1 Operating and Plotting Instructions for Close Support Tactics" TAC, April 1952, concerns practice runs made with F-84 type aircraft. "The practice runs were very successful. The accuracy attained, using only 'map scale' for target location, was such that only minor course changes were necessary to make the first run over the target successfully. The only difficulty encountered was that the aircraft is usually lost near the end of the letdown. This is primarily due to the

Appendix G, Page 9

142

SECRET

## SECRET

fact that the aircraft was below the line-of-sight range from the radar. The aircraft was easily picked up as soon as sufficient altitude was attained." (C)

- (4) Other uses for the APW-11A System described in the above cited manual are as an aid to navigation for assisting reconnaissance operations and for determining winds aloft information. (C)

f. The Alternate System: In the event that a malfunction precludes the use of the primary radar guidance system, an alternate radio (VHF or UHF) guidance system may be employed. (For distances over 60 miles the beacon function for the APW-11 must still be operative for the alternate system to operate.) When a malfunction occurs the ground controller switches over to a VHF or UHF frequency that the pilot has been briefed to monitor. The alternate system is very similar to low frequency radio range beam flying. Two Morse Code letters are transmitted such that one letter indicates a steering correction to the right, the other a correction to the left; when a steady tone is heard the aircraft is "on course." The various letter combinations used are A and N, or U and D, or T and E. There is no buildup in volume as the aircraft nears the bomb release point, hence the pilot must rely on the 10-second countdown to prepare him to release the bomb load. (C)

g. Input Data to the Computer: The exact range and heading from the MSQ-1 station to the target must be known. The only other data fed into the computer consists of metro winds at altitude for the target area and bomb ballistics data. The latter is provided by a removable bomb ballistics box. Such a box is required for each specific type of bomb, e.g., 500-lb. GP with conical fin, T-63 Practice Unit, 500-lb. Frag clusters, incendiaries, etc. (C)

h. Air Proving Ground SOP for MSQ-1/APW-11A Operations:

- (1) Prior to Takeoff: Perform light check by placing control switch in extreme clockwise position. (Light Check.) (U)
- (2) While Climbing to Rendezvous Point: (U)
  - (a) Call MSQ-1 and establish radar contact.
  - (b) Perform control check as follows:

Appendix G, Page 10

## SECRET

1. MSQ-1 will transmit commands in sequence.
  2. After each command shows on the indicator (primary & secondary) the pilot will repeat indicated commands on UHF to MSQ-1, whereupon the ground controller erases the signal and transmits another.
  3. Pilot will not execute commands during this check.
- (3) Turn over Rendezvous Point and take up briefed heading toward target. (U)
  - (4) Switch UHF from MSQ-1 (control radar) Channel to Bombing Range and get clearance to drop bombs. (U)
  - (5) Switch UHF from Bombing Range Channel to MSQ-2 (safety monitoring channel and call). (U)
  - (6) Commands from MSQ-1 as they appear on the APA-90 Indicator will be Rogered and Executed. Simultaneously pilot will monitor MSQ-2 UHF Channel. (U)
  - (7) MSQ-2 will give times at which it is safe to drop over UHF. (U)
  - (8) Sequence of commands approaching target as they appear on APW-11A indicator: (U)
    - (a) PREPARE TO BOMB (This is a preparatory command only.)
    - (b) Both of the above will be "erased."
    - (c) Approximately 18 seconds will elapse during which time guidance commands may be received and must be executed.
    - (d) Approximately 10 seconds from "Bomb Release Point" countdown will begin.
    - (e) BOMB - This is release point and bomb must be toggled off immediately.

Appendix G, Page 11

144

## SECRET

## SECRET

- (9) During the last 10-second period before "Bombs Away" the pilot will hear intermittent tones spaced approximately 1 second apart for a "countdown" of 10. (U)

i. References: (Title classifications are unknown unless otherwise indicated.)

- (1) Operations Analysis Technical Memorandum No. 50, "A Survey of Shoran and MSQ-1/APW-11A All Weather Bombing Capabilities of the United States Air Forces in Europe as of May 1954." (Title: SECRET) by More, Tyler and Sherman, 1 Sep 54, DCS/O, Hq USAF. (U)
- (2) Operations Analysis Technical Memorandum No. 44, "An Evaluation of Shoran and MSQ-1 All Weather Bombing Systems in Europe as of Aug 53," by Howard M. Jenkins. (U)
- (3) Operation Analysis Memorandum No. 1, "An Evaluation of Exercise Nice Try," by Jack Silber and Max Astrachas, 15 July 54, Hq 49th Air Division (Operational). (U)
- (4) "Manual of AN/MSQ-1 Operating and Plotting Instructions for Close Support Tactics," prepared by Tactical Air Division Post Teams, April 1952, TAC, USAF, Langley AFB, Va. (U)
- (5) Handbook Operation and Description of Radio and Radar of RB-57. (Title Unclassified.) T.O. 1B-B57(R)A-2-9 (U)
- (6) Handbook - Operating Instructions Radar Set AN/APW-11 (Title Unclassified.) T.O. 12PZ-2APW11-1, T.O. 12PZ-2APW-11-2 (U)
- (7) Handbook Operating Instructions - Close Support Set AN/MSQ-2 (Title Unclassified.) T.O. 31PZ-2MSQ2-1. (U)

### 3. THE LABS MISSION:

a. Introduction: The LABS (Low Altitude Bombing System) technique has proven satisfactory for the delivery of special weapons in certain fighter type aircraft and shows a very promising potential in the B-57B. Testing by day and night have demonstrated that the

Appendix G, Page 12

## SECRET

handling and performance of the B-57B aircraft are compatible with this delivery technique. Nevertheless, it is obvious that the chronic night intruder problem of target location severely limits the application of this mission in the tactical situation, i.e., the location at night of many night intruder type targets is often impossible in the B-57B with its present navigational and search equipment. The following discussion is predicated on the assumption that a solution to this fundamental problem will be found (such a solution would undoubtedly necessitate the incorporation of an airborne radar navigational capability, e.g., APN-59 Lightweight Airborne Radar.) (S)

### b. The Basic LABS Technique:

- (1) The LABS technique resulted from efforts to provide a low level special weapons delivery attack capability. Several considerations entered into the establishment of a requirement for this sort of attack, namely (a) the need for a visual sighting system that could be used with much greater frequencies than weather (cloud cover) would permit at high and medium altitudes, (b) the greater accuracies in target identification and attack obtainable at low level, (c) the need for an attack technique that would minimize the probabilities of radar detection with subsequent ground directed interception, and (d) need for a delivery technique that would attain accuracies and still provide adequate escape distance for the delivery vehicle. (U)
- (2) The mission is planned so that the pilot approaches the target at a predetermined low altitude and air-speed. In a day mission this would generally be at minimum altitude and maximum speed. A landmark which may be easily identified (bridge, railroad track, dam, coastline, etc.) is employed for a visual IP. This is the point over which the Bomb Release (Pickle) Button is depressed to start the timing cycle for the final run into the target. A line or silhouette IP at right angles to the inbound heading is easiest to identify and is most accurate for timing purposes. For night attacks with this system, the location, identification, and accurate flying-over of the IP is so greatly complicated by the lack of visibility

Appendix G, Page 13

## SECRET

in darkness (assuming blacked-out combat conditions) that the IP technique with LABS becomes impracticable. The only practicable method remaining is the "over-the-shoulder" technique in which the target becomes the "Pickle point" and the "Pull-up point." (S)

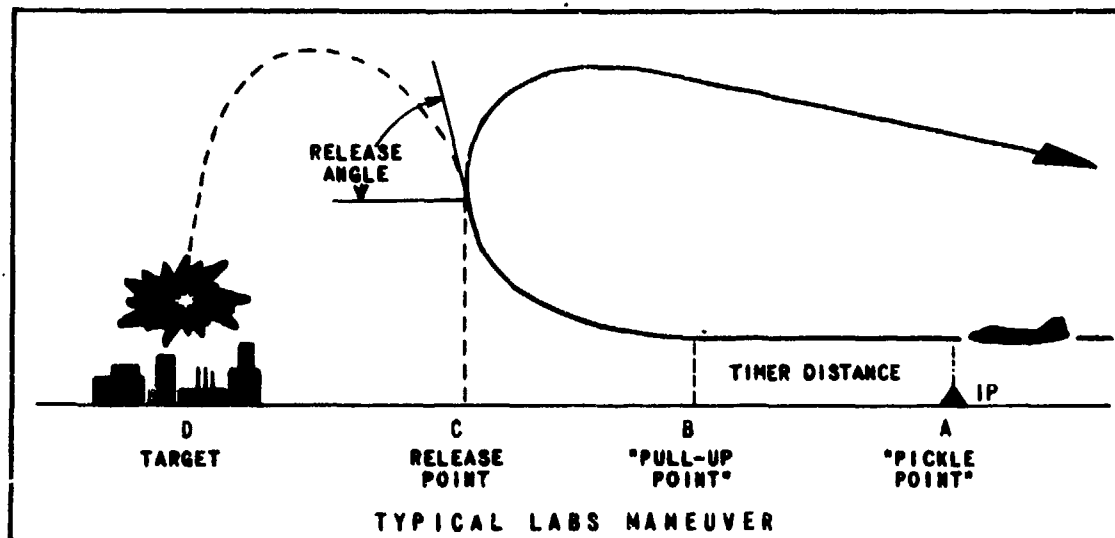

Figure 24: LABS Technique (S)

- (3) By using a LABS Bombing Table for trajectory data (C to D on Figure 24, above), a pull-up table for data on time, distance, and altitude gained during the pull-up (B to C), and the distance between the IP and release point, a time can be set into the bomb fuzing to permit a burst at a desired altitude along the bomb trajectory after release. The time required between IP (Pickle Point) and Pull-up Point is set into the time relay box of the LABS computer. The preselected release angle is set into the gyro component. (S)
- (4) Actual conduct of the run involves flying over the IP on a predetermined heading, altitude, and air-speed. The Pickle Button (bomb release button) is depressed, and the run is continued through the timing sequence. At the end of this time, the reticle light goes out, and the pilot commences his pull-up at a constant "G," referring to the LABS

Appendix G, Page 14

## SECRET

## SECRET

Indicator for "G" and wings level control. As the aircraft attains the preset release angle the bomb release is made automatically by the LABS. After release the pilot continues the maneuver through an Immelmann turn, descending with maximum power to accelerate as rapidly as possible to top speed in order to gain as much escape distance from the blast as possible. (S)

- (5) For angles of release of less than the "over-the-shoulder" type, an IP is required to provide a point from which a pull-up may be accomplished accurately in respect to all distances concerned. (S)

c. Targets: The general operational requirement for the B-57B requires a capability to deliver special weapons at night or during adverse weather conditions upon the types of targets (airfields, rail hubs, seaports, large troop concentrations, major supply depots, etc.) of a size commensurate with the yield of a special weapon and the escape distance attainable by the vehicle. The low level techniques greatly add to the navigational problems of a fast moving aircraft, particularly at night. It may be expected, therefore, that only the more prominent type targets will be suitable for night intruder attack. Such a target would have some sort of profile or distinguishing feature that would permit identification for sighting purposes at distances of from one to five miles to insure accurate lining up for the attack. (S)

d. Radius of Action: The radius of action may be expected to vary from 250 miles to perhaps 900 nautical miles. There would undoubtedly also be suitable targets at ranges of less than 250 miles and others beyond the maximum range of the aircraft. The maximum radius of action would be determined by the type of mission as warranted by the tactical situation. (S)

e. Ordnance: It is doubtful that the LABS Technique would ever be used to deliver conventional ordnance, since accuracies required for conventional bombs are not usually attainable with the LABS technique. (S)

f. Description of the Equipment: The MA-2 LABS is manufactured by the Minneapolis-Honeywell Regulator Company and is sometimes known as the "Modified LABS" or the "LABS 'B' System" in order to distinguish it from the earlier MA-1 and MA-1A computer sets. (The official nomenclature of the MA-2 is: Computer Set, Bombing System, Low Altitude, Type MA-2.) The MA-2 LABS provides an atomic delivery

Appendix G, Page 15

## SECRET

capability superior to that obtainable from the earlier MA-1 version with respect to both accuracy and versatility. The computer set consists of six basic components weighing a total of 23.5 pounds. Further details are included in Appendix H. (S)

g. Flight Technique: The control of the aircraft throughout the LABS delivery maneuver is relatively simple, since this is nothing more than an Immelmann. However, the accuracies with which all elements of the entire attack phase must be performed make this method of delivery highly vulnerable to many errors that will produce unacceptable impact accuracies. In the B-57B, the technique requires an attack ground speed of 420 knots. This speed must be attained at sufficient range from the pull-up point to permit accurate trimming of the aircraft in all planes. Approximately 94% RPM will hold this airspeed; however, it is usually necessary to add full power in order to accelerate to 420 knots in time for the run-in. (Ranges at which the target can be seen from attack altitude preclude establishing a run-in in excess of five to eight miles even in excellent conditions of visibility.) Once established on the run-in, the final switch adjustments on the LABS and bombing equipment must be made. The run is guided by lining up on the target with the pipper of the Mk Mod 8 sight. At the IP the Pickle Button is depressed, and the LABS Indicator becomes the primary control instrument although continuing reference is made to the Mk 8 pipper to assure accurate line-up. At pull-up, the pilot begins a vertical pull-up, referring to the LABS Indicator for both the proper rate of acceleration and proper flight attitude (wings level). In the general night situation, consisting of a well blacked-out target, the target becomes the IP and pull-up point and the "over-the-shoulder" toss has to be employed. The control of the aircraft in this latter maneuver is identical to the control necessary for low angle releases with the IP technique. (S)

h. Planning the LABS Mission:

(1) Preflight Planning Factors: The successful use of the LABS computer is based primarily upon good mission preplanning and precise pilot procedures. (S)

(a) The following factors must be considered during the preflight planning:

1. Distance and heading from initial point to target.
2. Wind and pressure in the target area.

Appendix G, Page 16

## SECRET

3. Elevation of initial point and target.
4. Airspeed and altitude of bombing run.\*
5. Intervalometer timing.\*
6. G-force during pull-up.\*

\*These factors are all interdependent and must be selected simultaneously.

- (b) After becoming airborne it is mandatory that the pilot follow the preplanning exactly because no changes can be made in the LABS computer settings from the cockpit.
- (2) Weather Limitations: Weather minimums at the target can be as low as a 1000-ft ceiling and 5 miles visibility. If the mission is to be run at high altitude on the way to the target, the ceiling must be high enough or sufficiently broken so as to permit a safe letdown to attack altitude without risk of flying into the ground. (S)
  - (3) Required Mission Planning Material: (S)
    - (a) Tables:
      1. Bomb ballistics table.
      2. Aircraft pull-up table.
      3. Aircraft angle of attack table.
      4. Cruise control data.
    - (b) Maps, Charts and Photographs:
      1. En route charts as desired.
      2. Low level course maps 1:500,000 scale.
      3. Target and IP maps and/or photographs 1:500,000 scale, or smaller scale.

Appendix G, Page 17

## SECRET

(c) Weather Information:

1. High level winds and temperatures en route.
2. Ceiling and visibility from letdown point to target.
3. Low level winds for low level course and target.
4. Temperature and pressure in target area.

(4) Mission Planning Procedures: The following outline describes the steps to be followed in planning a typical LABS mission against a representative target. The limited scope of this test did not permit as comprehensive an investigation of this area as would have been desired. For this reason much of this information has been adapted from previous tests conducted with LABS equipped F-84G's (but only where such information was thought to be equally applicable to night B-57B operations). (C)

(a) Target Data Computations: Standard procedures are used to determine the type weapon, yield, fuzing, and burst height required. Once this information has been determined the following computations are made in the order presented. (C)

1. Selection of the Release Angle: This is determined by the following:
  - a. Delivery Accuracy Required: Test with the F-84G seemed to indicate that the greatest accuracy is achieved at the lower release angles. In the case of a target having concentrated flak defenses the lower release angles would allow the aircraft to begin the pull-up earlier in the approach course and thus stay out of flak range. (S)
  - b. Type of Fuzing to be Employed: This question is of course related to the delivery accuracy required. A basic consideration here is the relative importance

Appendix G, Page 18

**SECRET**

of range accuracy versus burst height accuracy. The following is quoted directly from Page 37 of WADC Report 53-258: ". . . in the region of release angles from  $20^{\circ}$  through  $75^{\circ}$ , the Range Errors are always less when the weapon is Time fuzed than when it is Radar fuzed. Time fuzing from the IP rather than from release point gives the least range error. It can also be seen that with Time fuzing, there is an exchange of burst height accuracy for the improved range accuracy and that the exchange is more costly when the weapon is fuzed from the IP than when it is fuzed from the release point. The basic question is then the importance of burst height accuracy. If the accuracy in range is considered of primary importance, Time fuzing will be beneficial in all release angles to  $90^{\circ}$ . Radar fuzing and Time fuzing share about the same range errors at  $90^{\circ}$  and  $110^{\circ}$ , but since radar is expected to give more accurate burst altitude, it is, of course, the best method of fuzing at the higher angles. If burst height accuracy is considered to be equally as important as range accuracy, the total distance or slant range of the actual burst from the desired burst can be considered the criterion. This is found by taking the resultant of the range and burst errors. The columns marked "Total Distance From Desired Burst" show this resultant error. It can be seen that Time fuzing from the IP gives the most accurate delivery capability through an angle of  $30^{\circ}$  based on this criterion. Thus fuzing from release point is then more accurate up to the  $60^{\circ}$  release point. Beyond this, Radar fuzing becomes the best method." (S)

- c. Escape Distance Required: This varies directly with the height of the air burst,

Appendix G, Page 19

**SECRET**

## SECRET

i.e., a greater escape distance is required for a 2000-foot air burst than for one at 1000 feet, an impact burst requires the least escape distance. The yield of the weapon must also be considered in calculating the escape distance required. For the F-84G the release angles between  $45^{\circ}$  and  $75^{\circ}$  allow the greatest escape distance. Escape distance increases as the release angle increases up to approximately  $55^{\circ}$ , thereafter escape distance decreases steadily with the higher release-angles. (S)

2. Selection of the IP: The IP must be located within a range span compatible with the release angle selected (maximum distance from target - approximately six miles). This is determined by drawing two circles around the target, the inner one representing pull-up point distance from target and the outer one the maximum IP distance from pull-up point (approach velocity x 24 seconds, the maximum intervalometer setting). (S)
  - a. The type of terrain and enemy defenses surrounding the target must be considered to determine from which direction the target should be approached. (U)
  - b. The IP should be an easily recognized landmark such as a railroad crossing, river, bridge, or dam, coastline, lake, tower, etc. (S)
  - c. The IP should, when possible, be located along or crossing a guide to navigation such as a railroad, highway, or river. (S)
3. Selection of a Penetration Point: In selecting an IP consideration must be given to its geographic orientation with a suitable

Appendix G, Page 20

**SECRET**

penetration point near the target area. This is the point at which the pilot can descend to low altitude, definitely establish a position, and then navigate to the IP and target. This preferably should be a large area such as a lake, mountain or other prominent terrain feature located within 40 to 100 miles of the target. (S)

- (b) Determination of LABS Settings: Following are the computation procedures for determining the settings for the LABS and Bomb fuze timers, and the LABS gyro angle. (S)

1. Illustration.

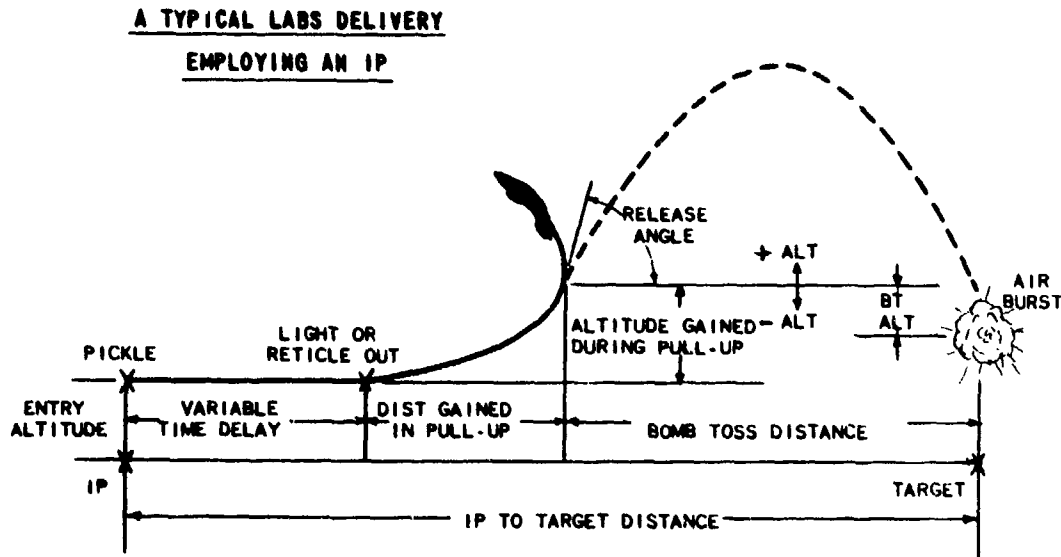

Figure 25 (S)

2. Entry altitude (True altitude measured from target elevation) and true airspeed are first determined by a consideration of the terrain features, target defenses, etc. (S)

Appendix G, Page 21

## SECRET

3. Using the aircraft pull-up tables for the proper "G" force pull-up, determine distance gained in pull-up, altitude gained in pull-up, airspeed at release angle, and, for the time required to attain release angle after pull-up is started. (S)
4. Determine release altitude by adding the altitude gained in pull-up to the entry altitude. Subtract the burst height from release altitude to determine altitude at which to enter bombing tables. If burst height is less than release altitude, bombing table altitude is negative (-). If burst height is greater than release altitude, bombing table altitude is positive (+). (S)
5. Enter bombing tables for correct release angle, release airspeed, and bombing table altitude to obtain bomb toss distance and, for a time fuze, time of flight. (S)
6. Add bomb toss distance and distance gained in pull-up. Subtract this from target-to-IP distance and divide by entry ground speed to obtain LABS timer setting. (S)
7. Obtain the aircraft angle of attack from the angle of attack versus airspeed chart on the "G" force curve at which the pull-up will be made. Add this angle algebraically to the release angle previously selected to obtain the angle to be set in the LABS gyro. (S)
8. To determine the time setting at which the fuze is to be set (if time option of the fuze is used), add together the time of flight of the bomb, time of pull-up, and LABS timer setting for the fuze which is started at "pickle" point. (S)

Appendix G, Page 22

## SECRET

9. Set the LABS timer at the time determined in Paragraph 6, set the LABS gyro angle at the angle determined in Paragraph 7, and set the time fuze at the setting in Paragraph 8. (S)

(5) Critical Mission Planning Elements:

(a) IP Selection:

1. The selection of a geographic reference point for "pickling" (depressing the bomb release button which starts the computer timer) is of critical importance to the outcome of the mission. Intelligence and photo-reconnaissance activities must be familiar with the types of landmarks that are readily recognized at night. The pilot flies over the IP at a low altitude and high airspeed on a predetermined heading to the target. For this reason an ideal IP would be an easily recognized line at a perpendicular to the flight path of the aircraft. Shorelines, broad highways, terrain gashes of light earth contrasted with a dark background, or terrain silhouettes abeam of the aircraft are potentially good IP's at night providing they are at an appropriate distance from the target (13,000 to 31,000 feet). The distance and heading to the target must be very accurately measured, hence the most accurate aerial photographs and/or maps of the target and surrounding area must be available for premission planning. (S)
2. The ability of the aircrew to find the IP without undue searching is so critical to the outcome of the mission that its importance cannot be overemphasized. The IP must be readily located even with the errors that can be expected with DR navigation. It would be desirable to have a

Appendix G, Page 23

156

## SECRET

## SECRET

large river, lake, or other obvious terrain marking that could serve as a landfall after a long flight into enemy territory. After making landfall as a first checkpoint, the crew must then find the IP and cross it at a proper airspeed and altitude on a predetermined heading to the target. A linear directional aid from the IP to the target is highly desirable. This could be a railroad, river bed or like signal pointing at the target or paralleling the desired track. (S)

3. If a suitable IP cannot be found or for other reasons the over-the-shoulder releases option is selected, consideration must still be given to locating a prominent geographic feature for landfall purposes. It would be desirable to have easily found checkpoints along the route to the target from the landfall, and there must be some sort of definite check point near the target from which the pilot can begin his final bomb run. (S)

(c) Map and Flight Plan Preparation:

1. To obtain maximum accuracy all times should be measured to the nearest one-tenth of a minute. All turns should be of standard rate so that the distance gained during the turn can be calculated and the roll out terminated on a precise heading to the next checkpoint. (U)
2. On long-range missions dog leg tracks from one prominent landmark to another are recommended. When on the low level course, procedure turns over check points should be executed so that the aircraft rolls out and passes directly over the checkpoint on the desired heading. (Refer to Figure 26.) (U)

Appendix G, Page 24

**SECRET**

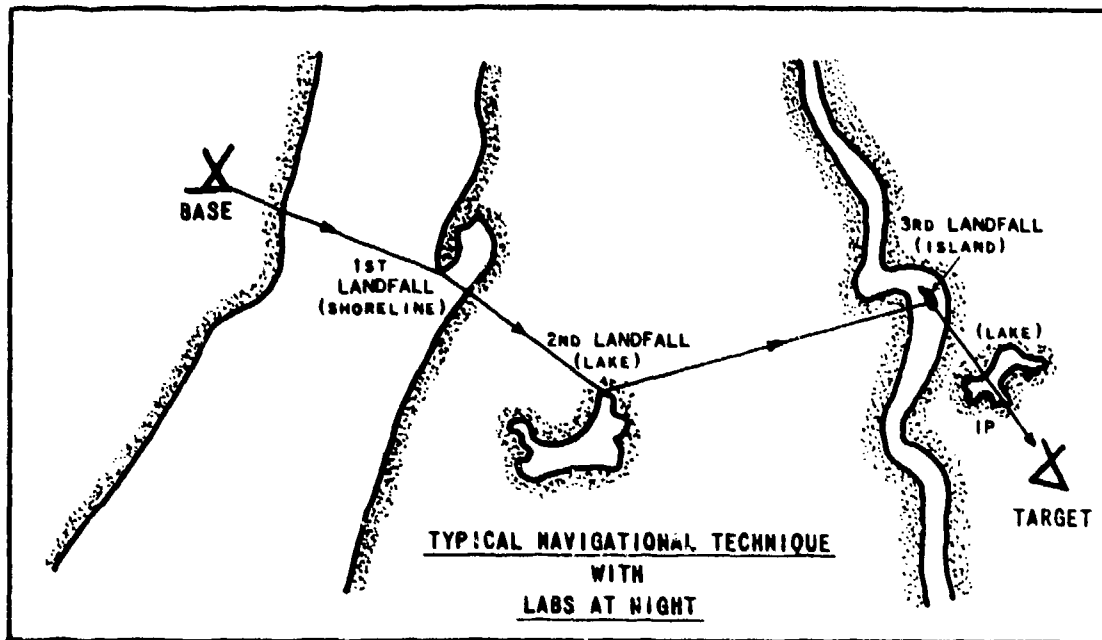

Figure 26 (S)

3. The following information concerning map preparation for final approach to target is quoted directly from the final report on Project APG/TAT/83-A (airspeeds refer to the F-84G): . . . "For navigation to the IP and target, a map with a scale no larger than 1: 500,000 should be used. The final approach course from the penetration point to the IP should be marked off in minutes, such as seven and one-half miles per minute for 450 MPH. This speed will allow acceleration to bombing speed of 500 MPH in two minutes or less and the last two minutes of the course line should be scaled accordingly. If the pilot desires, 5-degree drift lines can be drawn on either side of the course line, using the IP as an apex. This feature is applicable when the final

Appendix G, Page 25

158

**SECRET**

## SECRET

approach course is a straight line to the IP. In some cases it may be simpler to fly from point-to-point where there are good check points. In any case the final 15 to 20 miles of the approach should be on a line with the IP and targets so that only small corrections are necessary to pass over the IP on a heading to the target. The above procedure was used throughout the navigation phase of the project and was successful." (S)

i. Pilot Training for the LABS Maneuver: The following APGC report is included verbatim because of its relevance to pilot training: (S)

### "EASY READING COPY

FROM: Commander APGC, Eglin AFB, Florida      DATE: 5 October 1954  
TO: Chief of Staff, USAF, Washington, D. C.      PRECEDENCE: PRIORITY

DCS/O-TR \_\_\_\_\_, FOR: Directorate of Requirements, DCS/D.  
This message is classified CONFIDENTIAL in accordance with Paragraph 24a(9), AFR 205-1. This is final Flash Report on Project No. APG/TAT/83-A-4, subject (U) Evaluation of T-33 Aircraft to Perform LABS Maneuver. No further report will be submitted, following in six paragraphs.

- a. It has been determined that T-33 aircraft can adequately perform LABS Maneuver and is suitable for training purposes.
- b. Standard aircraft (without special LABS equipment and T-1 Bomb Dispenser) can be used effectively for practice in basic LABS maneuver by placing trainee in rear cockpit and having him perform Immelmans while under hood. In addition to providing good practice for precision instrument flying with standard instruments, this builds confidence in trainee that instrument Immelmann from extremely low altitude is relatively simple and safe. For maximum effective training it is recommended that accelerometer in both cockpits be relocated as outlined below.
- c. For training in actual LABS deliveries a LABS computer and T-1 Bomb Dispenser are required. The very slight increase in drag

Appendix G, Page 26

## SECRET

## SECRET

when T-1 Bomb Dispenser is installed does not affect aircraft performance. No additional instruments are required except LABS indicator. If MA-1 LABS is installed, only one LABS indicator is required in the front cockpit since this indicator is used only for reference and not as a pull-up instrument. If MA-2 LABS is installed, indicators are required in both cockpits since this instrument is used to perform the entire maneuver. Gunsight is not required because a pull-up indicator light may be substituted for reticle-out signal. If sight is not installed, accelerometer may be placed on gunsight mount or in center of panel next to attitude gyro. If MA-2 LABS is installed, accelerometer position can remain as is but LABS indicator should be positioned on gunsight mount or on top of instrument panel for easy reference.

d. Minimum entry speed for LABS maneuver is 360 knots. Maximum entry speed after one minute level flight is 435 knots. Optimum entry speed is 425 knots.

e. Pull-up tables should be prepared for 3½, 4, 4½, 5 "G" pull-ups at speeds listed above.

f. No restrictions apply to T-33 with centerline tanks which will affect safety of flight in performing LABS maneuver. All test flights were conducted with approximately 50 gallons fuel in each tip tank when LABS maneuvers were initiated."

j. References: (Title Classifications are unknown unless otherwise indicated.)\* (S)

- (1) WADC Technical Report 53-258 Title - (U) The LABS Computer, by Hanlen, Fraser, and Mitchell, Armament Laboratory, WADC, October 1954.
- (2) Field Training Manual, Title - (U) Aero 18a and MA-2 LABS Systems, Field Service Engineering, Aeronautical Division, Minneapolis-Honeywell.
- (3) Project No. APG/TAT/83-A, Interim Letter Report, Subj: (S) Low Altitude Delivery of Atomic Weapons by Fighter Bomber Type Aircraft (6 Nov 52).

\* Copies of Air Proving Ground Reports may be obtained from:  
Armed Services Technical Information Agency  
Document Service Center, Knott Building  
Dayton 2, Ohio

Appendix G, Page 27

160

## SECRET

**SECRET**

- (4) Project No. APG/TAT/83-A, Final Report, Subj: (U) Operational Suitability Test of the LABS Computer (19 Nov 53).
- (5) Project No. APG/TAT/83-A-1, Subj: (S) Final Report on Determination of the Best Method of Fighter Low Altitude Special Weapons Delivery 17 Feb 55.
- (6) Project No. APG/TAT/83-A-2, Final Report, Subj: (U) Operational Suitability Test of Practice Bombs for LABS Computer Toss Bombing. (4 Aug 53)
- (7) Project No. APG/TAT/83-A-3, Subj: (U) Final Report on Operational Suitability Test of Modified Low Altitude Bombing Systems (LABS), (1 Sep 54).
- (8) Project No. APG/TAT/83-A-4, Final Flash Report, Subj: (U) Evaluation of T-33 Aircraft to Perform LABS Maneuver, (5 Oct 54).
- (9) Project No. APG/TAT/131-A, (U) Operational Suitability Test of Mark 76 Practice Bomb for LABS Training.

Appendix G, Page 28

161

**SECRET**

**SECRET**

**EVALUATION OF ADDITIONAL EQUIPMENT AND MODIFICATIONS**

1. **GENERAL:** From the initial planning efforts through the physical testing phases it was obvious that the B-57B weapons system was not equipped to realize a very great degree of its potential effectiveness. Lack of equipment in some areas and equipment of dubious reliability in others limited the capabilities of the weapons system considerably. In an effort to offset these handicaps and to exploit the aircraft more fully, several modifications were undertaken at APGC and tested in conjunction with the standard weapons system. The application of each of these modifications is pointed out in the test results portion of this final report. In this appendix the basic details of the equipment and the installation are presented. In all but one case (modified link chutes) the items or their components are available through standard service stock (USAF or USN) and are available through this medium in sufficient quantities to permit their use as interim measures until more refined equipment can be developed. All are basically simple and inexpensive to accomplish. (U)

2. **MA-2 LABS:**

a. **Reason for Modification:** Recent tests conducted in fighter aircraft in recent years have established requirement for the LABS delivery technique for special weapons. Preliminary investigations in the B-57B to determine its capability for employing this technique demonstrated that technique and aircraft are compatible. It was found that acceptable attacks could be made with this technique using only the standard instruments installed in the production aircraft. However, in the interests of securing consistently greater accuracies, an MA-2 LABS was secured and installed in one test vehicle. (S)

b. **Description of the Installation:** The functional parts of the LABS (two-sector gyro, Yaw/Roll gyro, timer relay box, and calibrator box) are located in the pressurized portion of the fuselage, directly below and between the seats. (This space is designed for the M-1 Toss Bomb Computer when this equipment becomes available.) All control switches, the Pickle Light, and the LABS Indicator are located in the cockpit. (A wiring diagram for the installation as tested is shown in Inclosure 1 to this Appendix.) (S)

Appendix H, Page 1

162

**SECRET**

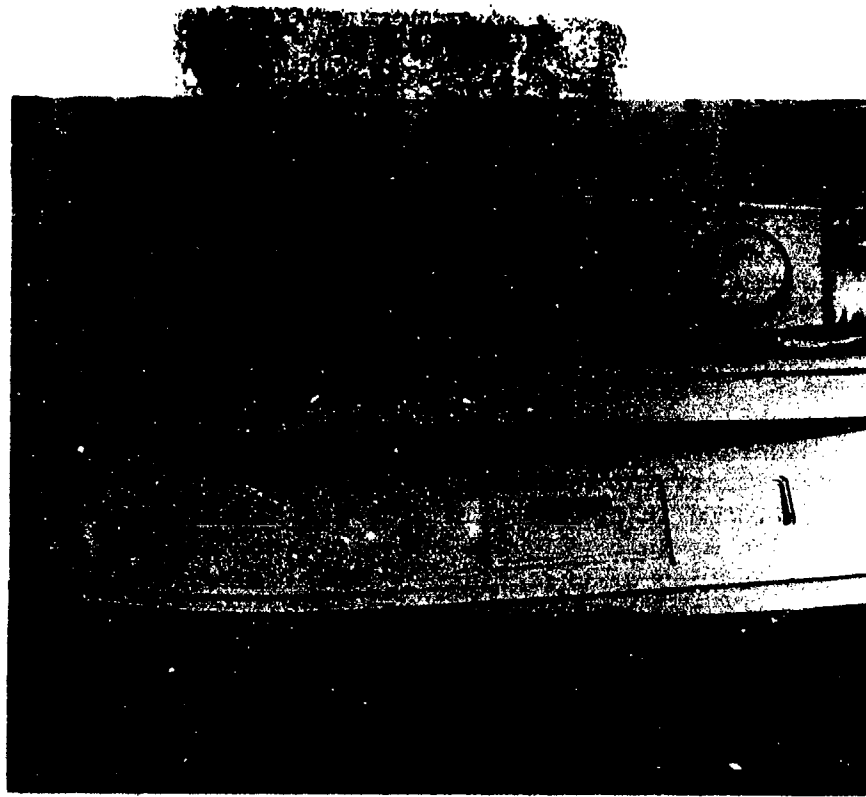

Figure 27: LABS Components In Fuselage (S)

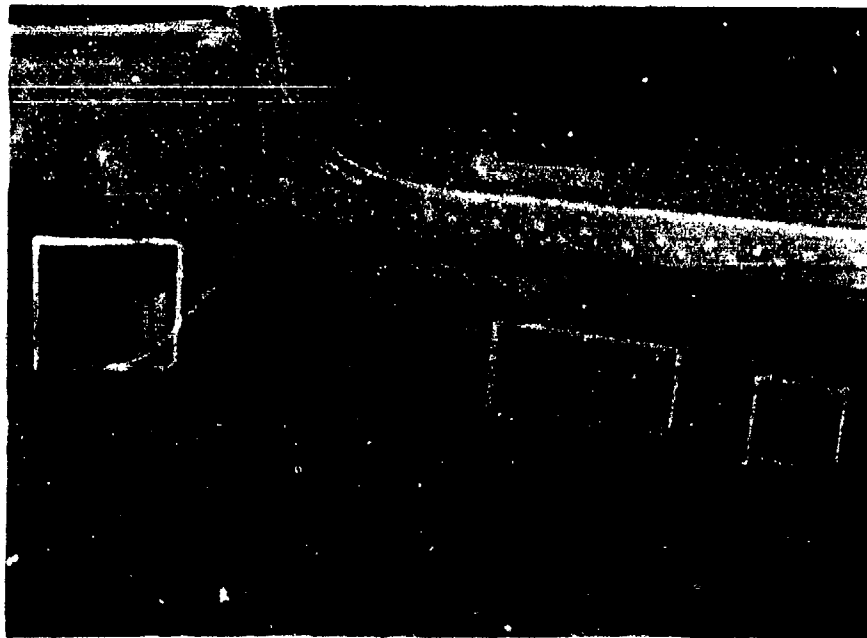
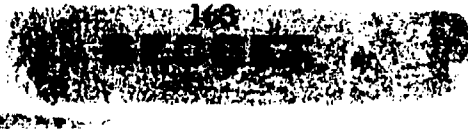

Figure 28: LABS Switches in Cockpit (S)

Appendix H, Page 2



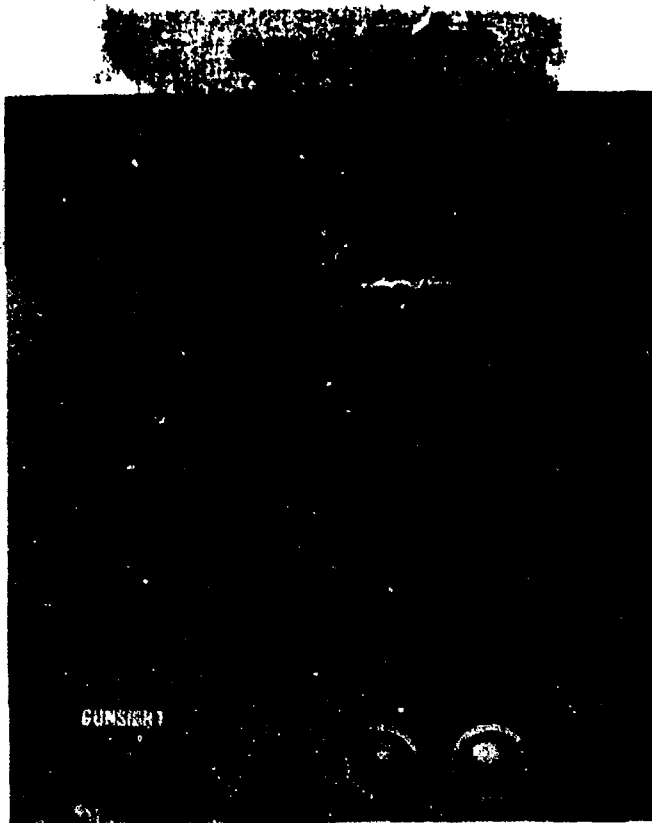

Figure 29: LABS Indicator in Cockpit (U)

c. Evaluation: The installation of the MA-2 LABS equipment in the B-57B greatly increases the adaptability of the aircraft to this attack technique. By using the automatic trimming device, the LABS Indicator, and the automatic release angles set into the system, pilots are able to attain consistent flight paths and accurate release angles. The lack of consistency in these phases was found to have been a major source of error with the "stand-by" LABS technique. (S)

3. AUTOMATIC HORIZONTAL STABILIZER CONTROL (TRIM CONTROL):

a. Reason for the Modification: An analysis of phototheodolite plots of early fighter LABS sorties and sorties in the B-57B in the "stand-by" LABS investigation clearly showed that major errors were produced because pilots were unable to consistently duplicate their flight paths in pull-up while using only the basic pitch controls. This was particularly true of the B-57B because stick forces at LABS speeds are extremely high and the trim extremely sensitive. Consequently, pilots were obliged to make pull-ups without trimming; variations in time between pull-up to release were as high as three seconds in some instances, with a resulting horizontal range error of approximately 2000 feet. In answer to this problem the Technical Services Laboratory

at APGC devised an automatic trimming device to be used in conjunction with the LABS. The entire device is built of standard Air Force stock items and was installed in the B-57B for less than fifty dollars. (U)

b. Description of the Installation:

- (1) The B-57B has a movable horizontal stabilizer, powered by a split field motor to provide trim in pitch control. Energizing one field with the pilot's trim button runs the motor in one direction for NOSE DOWN trim; energizing the other field will give NOSE UP trim. The horizontal stabilizer motor has a clutch coil and a shunt field in parallel, and the direction of flow of current through this coil and field is determined by the closing of the "Stabilizer Retract Relay" for one direction and closing of the "Stabilizer Extend Relay" for the other. Closing of these two relays simultaneously will cause a direct short and blow a circuit breaker. To avoid this, the wire for operating the Stabilizer NOSE UP (the only sense in which the trim device was designed to work) is run through the closed circuit of the "Stabilizer Retract Interlock Relay." This provides a safety feature in that any time the Stabilizer Control Switch (Trim Button) is actuated NOSE DOWN, the "Stabilizer Retract Interlock Relay" will break contact and cut off the automatic trimming action. (U)
- (2) The Automatic Horizontal Stabilizer Actuator was designed to start the motor in the NOSE UP position at a signal from the LABS. A three-position switch (PICKLE, OFF, RETICLE-OUT) in the cockpit allows this action to be selected for the type of bombing approach desired. (See Figure 28.) In the PICKLE position the stabilizer motor begins to run simultaneously with application of the bomb button ("Pickle Button," when the LABS is being utilized) for entry into the high angle releases. In the RETICLE OUT position, the timing on the Timer Relay is permitted to take place before the stabilizer motor actuates; this is for the low angle releases in which an IP is used. The automatic feature permits selection of a period of trim application through a control box (Figure 30) mounted in the

Appendix H, Page 4

cockpit. For this test the range of trim motor application was from .25 seconds to 2.0 seconds; one second of trim application was utilized on all runs as the most satisfactory setting at the desired conditions of flight. (For details of operation and Stock Nos. of Parts required for this installation, reference Air Proving Ground Final Report, Project No. AFG/TAT/83-A-3. Also, see attached wiring diagram.) (S)



Figure 30: Automatic-Trim Control Box (U)

c. Wiring Diagrams: Wiring diagrams of the installation of the Automatic Horizontal Stabilizer Control are included as Inclosure II of the Appendix. (U)

d. Evaluation: The automatic trim control device proved itself to be an invaluable addition to the LABS as installed in the B-57B. It permits use of trim during the maneuver, and it applies trim in the desired amount at the right time without the pilot having to monitor the system. Without the automatic trim feature, pilots could not successfully use trim in the maneuver because individual reaction times and inability to judge the right amount of trim each time resulted in erratic flight paths. Further, since the MA-2 LABS

Appendix H, Page 5

[REDACTED]

technique requires that the pickle button be depressed throughout the maneuver, use of the trim switch is impossible, since the pilot's right thumb has to actuate both the pickle button and the trim switch. The automatic trim reduces the stick forces in the maneuver substantially, with resulting increases in flying precision and a decrease in pilot fatigue. (S)

4. MACHINE GUN SYSTEM:

a. Reason for Modification: Initial sorties in the B-57B resulted in unacceptably low fire-out rates for the machine guns. The bulk of the malfunctions were due to charger failures and link chute jams. The Kits, Conversion, B-1 Guncharger (Part No. 801793), and the modified link chutes were secured and installed to remedy these repeated malfunctions. The guncharger kit is a standard Air Force supply item; the link chutes were modified by the Glenn L. Martin Company and supplied on a test basis. (U)

b. Description of the Installation:

- (1) The B-1 Guncharger Conversion Kit consists of four O-rings, two O-ring Retainers, four plastic seats, and two small steel balls. Installation instructions come with the kit (produced by the Walter Kidde Company, Inc., Belleville 9, New Jersey), and these instructions must be used in conjunction with Technical Order AN11-10B-19, dated 30 December 1952. (U)
- (2) The link chutes supplied by the aircraft contractor were modified very slightly. The modifications consists of widening the throat of the chute at the point it fits into the gun. (U)

c. Evaluation: The sorties run after installation of the charger modification kits and the modified link chutes showed a sharp rise in gun reliability. (U)

5. ROCKET FIRING SYSTEM:

a. Reason for the Modifications: The rocket firing system in the B-57B was designed to accommodate the 5-inch HVAR type rocket, double hung on each of the eight rocket pylons. However, this rocket is obsolescent and is being replaced by the more effective launcher type rocket carriage. In order to carry and fire the new rockets (MA-3 Century Launchers with seven 2.75" FFAR's, mounted one launcher to a pylon), it was necessary to modify the front rocket posts to fit

the new launcher and to modify the firing circuitry to permit firing of the launchers in the desired sequence. (U)

b. Description of the Modification:

- (1) Front mounting post: To fit the test lot of MA-3 Century Rocket Launchers to the standard front mounting post, it was necessary to mill approximately 3/16 of an inch off of each face of the post. (This will not be necessary for production launchers, since they are to be changed to fit the standard posts.) (U)
- (2) The 5-amp fuze in the firing circuit was replaced with a 10-amp fuze. (U)
- (3) The 10-ohm resistor in the rocket intervalometer is wired out of the circuit. (U)
- (4) The firing order of the posts is changed to permit firing of all eight launchers on the first eight impulses followed by jettisoning of all eight launchers on the next eight impulses. (Old and new firing orders are illustrated below.) (U)

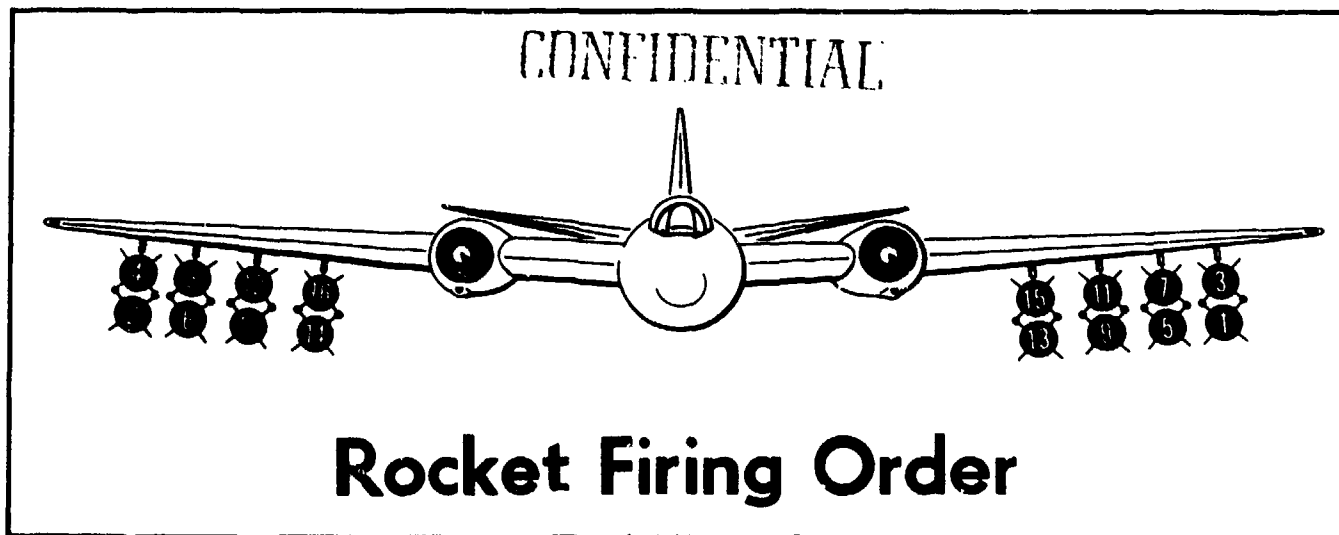

Figure 31 (U)

Appendix H, Page 7

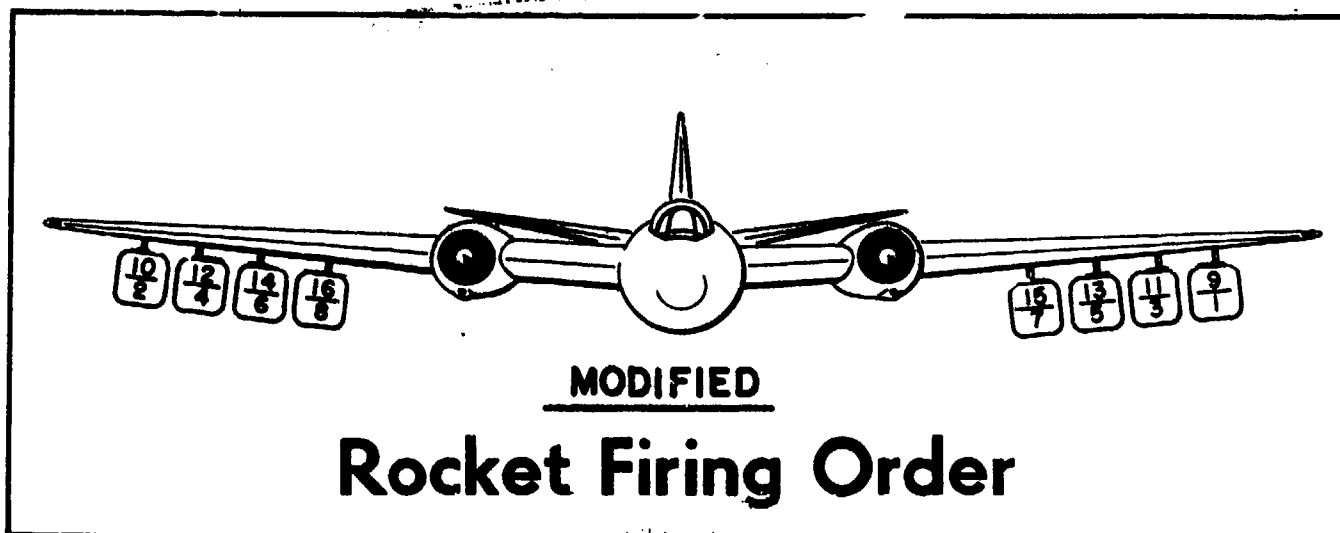
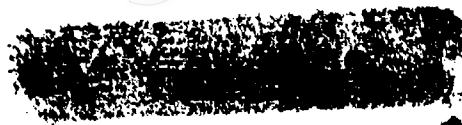

Figure 32 (U)

c. Evaluation: Adapting the B-57B rocket firing circuit to the MA-3 Century Rocket Launcher increases the firepower and accuracy of fire of the B-57B without decrease of other capabilities. (U)

6. MK 20 MOD 5 GUNSIGHT:

a. Reason for the Modification: The standard sight in the B-57B (Mk 8 Mod 8) is operationally unsuitable for several reasons. (See Appendix C, Functional Deficiencies.) An inspection of the specifications of the Mk 20 Mod 5 Gunsight indicated that this sight would be a considerable improvement in that it would correct several of the deficiencies existent in the Mk 8. (U)

b. Description of the Installation: The Mk 20 Sight fits the same mount used for installation of the Mk 8 Sight. However, since the relocation of the reflector adjustment knob would not permit this sight to fit the same recess in the glare shield as fitted the Mk 8, it was necessary to cut away a small piece of the bracing for the glare shield and locally manufacture another piece that would fit around the Mk 20 sight. Approximately 60 man-hours were required to complete the modification, the bulk of which was utilized in forming the new piece for the glare shield. The Mk 20 sight is shown below. (U)

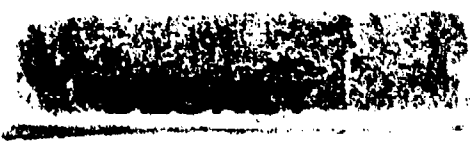



Figure 33: Mk 20 Sight (U)

c. Evaluation: The Mk 20 Mod 5 Gunsight provides several desirable features that are not available in the Mk 8 Mod 8 Sight. However, these features are probably not of sufficient impact to justify conversion to the Mk 20 Sight for all B-57B aircraft, since there is no appreciable gain to be realized in overall accuracies against night targets. (U)

7. NAVY AERO 2A PARACHUTE FLARE DISPENSER:

a. Reason for Modification: Initial parachute flare sorties disclosed that the AN/M-26A1 Parachute Flare, the USAF standard, would not function satisfactorily for use with the B-57B. In the absence of any other suitable flare, it was decided to attempt to adapt the Navy Aero 2A Dispenser with Mk V Parachute Flares to the B-57B aircraft, since this Dispenser had been used with some success on fighter aircraft. (U)

Appendix H, Page 9

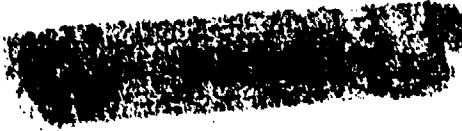

b. Description of the Installation: The Navy Aero 2A Dispenser fits on a standard bomb rack without modification. It carries 17 Mk V Flares. However, some changes in the wiring of the aircraft were necessary to permit the Dispenser to be actuated in the desired manner from the cockpit. The Dispenser was mounted on the left inboard pylon (No. 1). To provide a jettison capability in case of emergency, a jumper cable was installed from the left outboard pylon (No. 2) release mechanism to the No. 1 rack. For actuation of the Dispenser mechanism, an adapter cable was made up and installed between the No. 1 release mechanism and the Navy Aero 2A. For operation of the Dispenser, switches were set as follows: (U)

- (1) Master Switch on "BOMBS EXTERNAL."
- (2) "STA LEFT 1" Switch ON.
- (3) "STA LEFT 2" Switch OFF.
- (4) NOSE & TAIL ARMING Switch ON.
- (5) Depress the BOMB RELEASE Switch. (NOTE: To permit the reels to rotate fully into position, wait a minimum of three seconds between release impulses.)

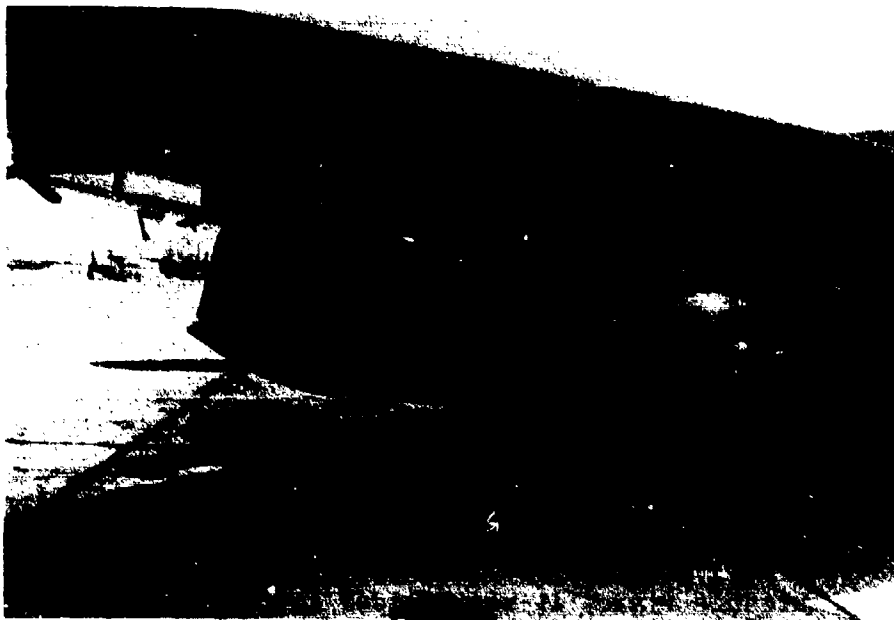
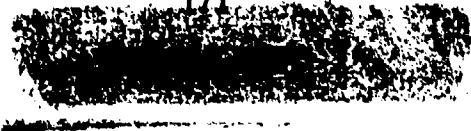

Figure 34: Navy Aero 2A Flare Dispenser Mounted on the B-57B (U)

Appendix H, Page 10



**c. Evaluation:** The Navy Aero 2A Parachute Flare Dispenser with Mk V US Navy Parachute Flares is a workable combination that will provide flare illumination for the B-57B at the sacrifice of only two bomb stations for 17 flares. It is poorly designed from the standpoint of carriage on a relatively high speed aircraft, and it has several functional deficiencies that will make its reliability somewhat questionable in the field. However, it does provide a limited capability for the B-57B in a vital area where nothing else is available at the present time. (U)

**8. THE AUDIO MINIMUM ALTITUDE SIGNAL:**

**a. Reason for the Modification:** A basic phase of the night intruder mission requires sustained periods of visual search at low altitudes (1000 to 3000 feet above the terrain) at night. This results in a somewhat hazardous condition of half visual-half instrument flight wherein the pilot is forced to maintain a visual search outside the aircraft while looking for targets, but is required to rely on his instruments to retain control of the aircraft. This is particularly critical in a jet aircraft since effective cockpit sealing reduces the noise of flight to a degree that an increase or decrease in air-speed cannot be noted by sound as it could be in former night intruder aircraft. Consequently, it is quite possible to enter a descending spiral while in a search pattern permitting the aircraft to descend at a great rate with no audible signal to the pilot. The danger in this is so apparent that the searching effectiveness is impaired because pilots are unable to devote a sufficient amount of time to it alone, due to the need for frequent return to the instrument panel. In an effort to lighten the load on the pilot's already overtaxed eyes, it was decided to devise a signal for loss of altitude below a certain safe limit and present the signal in an audible tone. (U)

**b. Description of the Installation:** The Audio Minimum Altitude Indicator is installed to monitor the standard pitot-static system of the aircraft. It utilizes a bridge circuit composed of a Giannini altitude transmitter as two legs of this bridge and a helipot precision potentiometer as the other two legs. Fifty-volt 4000 AC is obtained from a Hughes 400 transformer by connecting in series eight 6.3-volt taps. This 50 volts is applied to the bridge. The primary of a 50 to 1 output transformer is connected across the bridge as a load. The secondary output transformer is connected to the grid of a 2D21 thyratron tube. A Potter Brumfield SS-4054 Relay is connected in the plate circuit of the 2D21 thyratron tube. The operation of this relay turns on a 2000 cycle oscillator which modulates this 2000-cycle note on the aircraft interphone transmitter. (U)

**c. Operation of the Signal:** The pilot has a single control box for operation of the system. (Refer to Figure 35 below.) He flies the aircraft at the altitude he desires to select as a minimum. He then adjusts the control dial downward until he hears the 2000-cycle tone in his headset. Thereafter, ascending above this base altitude will cause the tone signal to disappear. However, descent to or below the altitude will cause the tone to reappear and signal a loss of altitude below this minimum figure. (U)



Figure 35: Control Box for the Audio Signal (U)

**d. Evaluation:** The operation of the Audio Minimum Altitude Signal was surprisingly effective and appears to have application to several phases of the night attack mission. The signal came on consistently within less than 200 feet of the selected minimum altitude, regardless of the rate of descent. Primarily, its best application appears to be for a guard against accidental loss of altitude during low level search at night. However, it can be used to signal release altitude during a dive bombing run, firing range for guns and rockets in any known angle of dive, and for a "reminder" signal for use during jet

Appendix H, Page 12

penetration and letdowns where the attaining of key altitudes initiates other phases of the maneuver (e.g., penetration turn). (U)

9. T-1 PARTIAL PRESSURE SUIT FITTINGS:

a. Reason for the Modification: Performance of the B-57B permits it to operate at altitudes requiring pressure breathing equipment for crew members, but no provision is made in the aircraft for accommodating any version of current pressure equipment. To be able to evaluate the capability of the aircraft at its maximum altitude, the necessary fittings were installed to permit the pilot to use a T-1 Partial Pressure Suit. (S)

b. Description of the Installation: In order that the T-1 Partial Pressure Suit could be used in the B-57B, it was necessary to install a face plate heater electrical outlet and to adapt the AIC-10 Interphone System to the T-1 Suit headset and microphone plug. (S)

c. Evaluation: In the one flight made with the pilot equipped with the T-1 Suit it was possible to determine that the present partial pressure suit can be utilized in the aircraft. However, it severely restricts the pilot in the accomplishment of his duties. In fact, he is unable to get to and operate his bombing switches on the left rear console. The outstanding defect in the installation as flown in the B-57B was the positioning of the "plumbing" required for the suit; the routing of the lines and hoses and the location of the C-1 Bottle Assembly would have made successful ejection a doubtful probability. As a result of this finding it was decided to abandon all further efforts with the Partial Pressure Suit during this test. (S)

10. STRIKE CAMERA POD:

a. Reason for the Modification: It is usually impossible to accurately evaluate a night attack because of the poor visibility. Frequently crew members have no idea as to exactly what they attacked or how much damage was done to the target. This results in a serious lack of intelligence information and a considerable motivation problem for night intruder crews; a crew is quick to realize that the effectiveness of his mission will probably never be assessed, so why be aggressive. (U)

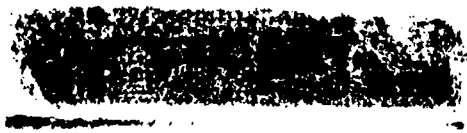

b. Description of the Modification: Two methods were given a preliminary evaluation. The first involved the use of an S-11 continuous strip camera with Navy Mark 5 flares for target illumination. The second consisted of a K-46 camera using M-112 photoflash cartridges for illumination. (U)

- (1) Strip camera: The slit blades were removed from the S-11 camera to give a full  $\frac{1}{2}$ -inch slit aperture, and a 7-inch F 2.5 cone was installed. The camera was then pre-set to the V/H (Velocity-Height) ratio for the anticipated attack pass to be made under flares. (U)
- (2) K-46 Camera: The K-46 camera was combined with a T-8 photoflash cartridge discharger in a 165-gallon Napalm tank which was mounted on a bomb pylon. The system was designed to take a picture automatically of the target area after the bomb release button or the gun trigger had been activated on a normal attack pass. An A-2 "memory delay" was used to delay the firing of the photoflash cartridge until just after the bomb burst on a bombing pass, and to delay the firing of the cartridge until the aircraft was approximately over the target area on a rocket pass. (U)



Figure 36: K-46 Pod Installed on B-57B (U)

Appendix H, Page 14

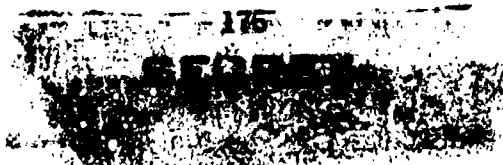

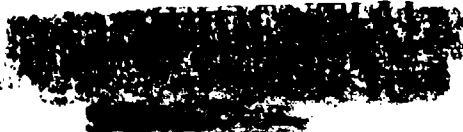

(3) Details of both systems are available in the Master Project Folder, Project APG/TAS/119-A, Technical Reports Branch, Headquarters AFGC, Eglin Air Force Base, Florida. (U)

c. Evaluation:

(1) Comparison of the photographic results of the two systems, their relative cost, complexity and versatility shows that the more practical system for tactical use at this time would be the Strip Camera. (U)

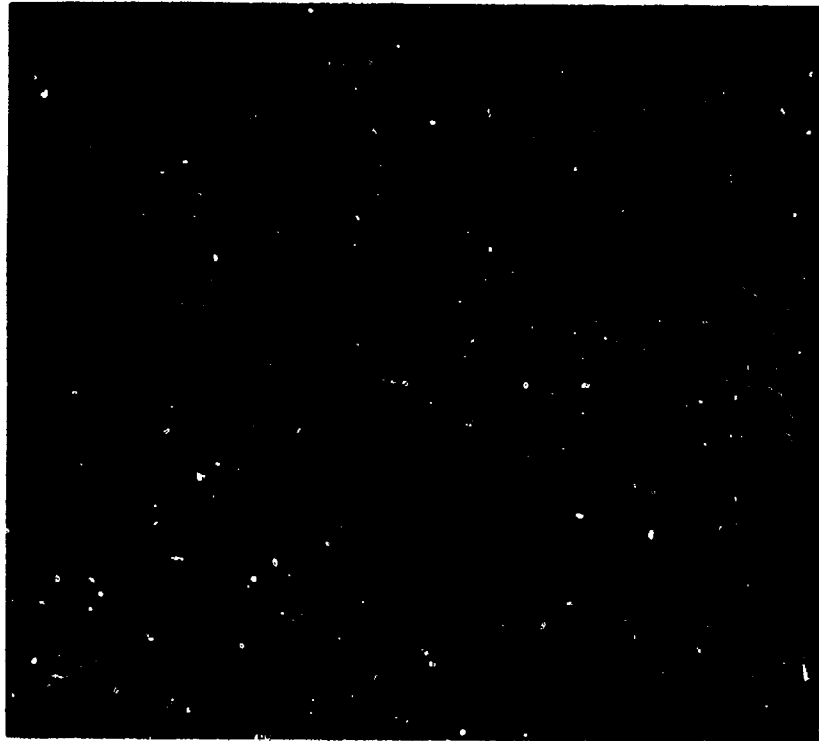

Figure 37: Strip Camera Photograph of Target Area, Camera at 1000 feet, Flare at 1500 feet. (U)



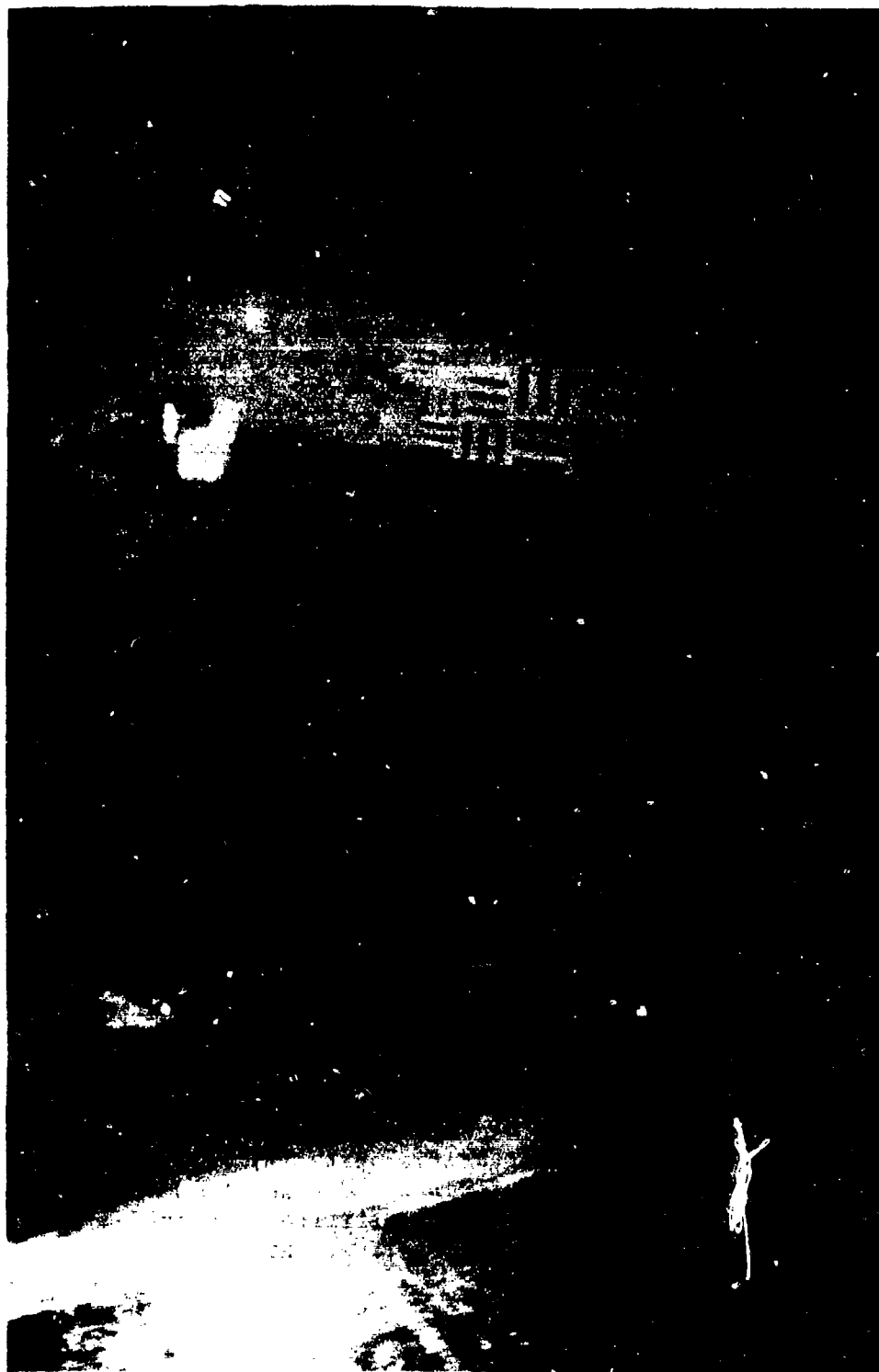
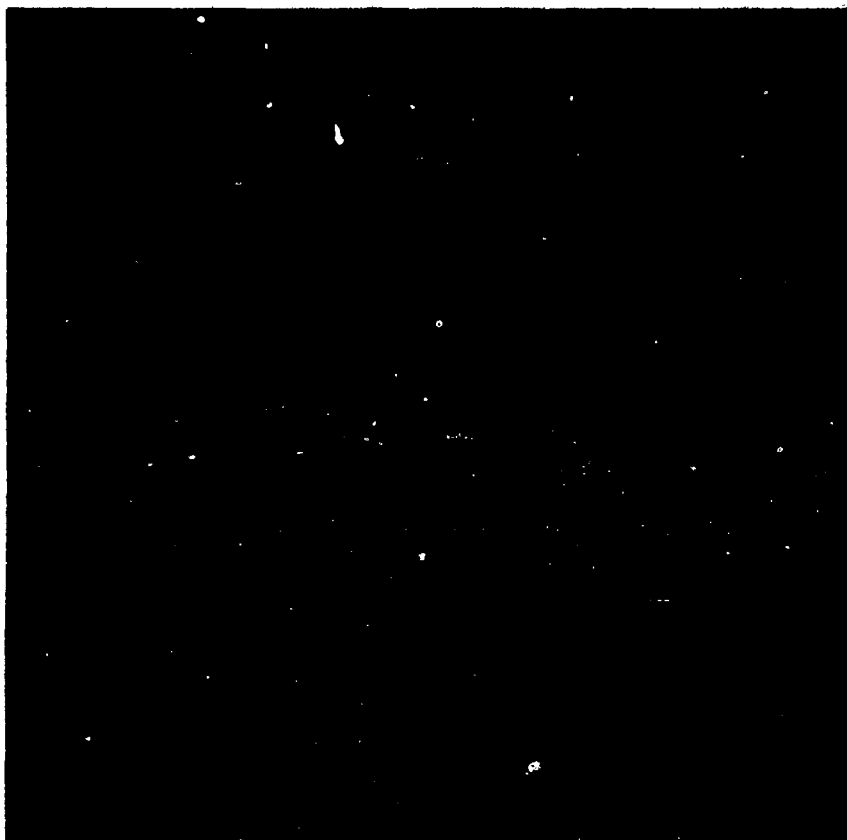

Figure 38: Strip Camera Photograph of Target Area, Altitude 1500 Feet, Flare Burst 1000 Feet  
(U)

CONFIDENTIAL



**Figure 39: Strike Photo Showing Simulated Vehicles with K-46 Camera (U)**

- (2) Prior to this test, an assumption existed that current flares with 750,000 candlepower would not provide enough illumination for any type of aerial photography. This assumption was generally accepted as a fact, even by representatives of various photo equipment manufacturers. With flares of 1½ million to 3 million candlepower under development, further research and tests are justified to provide night attack and bomb damage assessment. (U)

Appendix H, Page 17

CONFIDENTIAL

UNCLASSIFIED

WIRING DIAGRAM  
MA-2 LABS COMPUTER, B-57 #52-1503

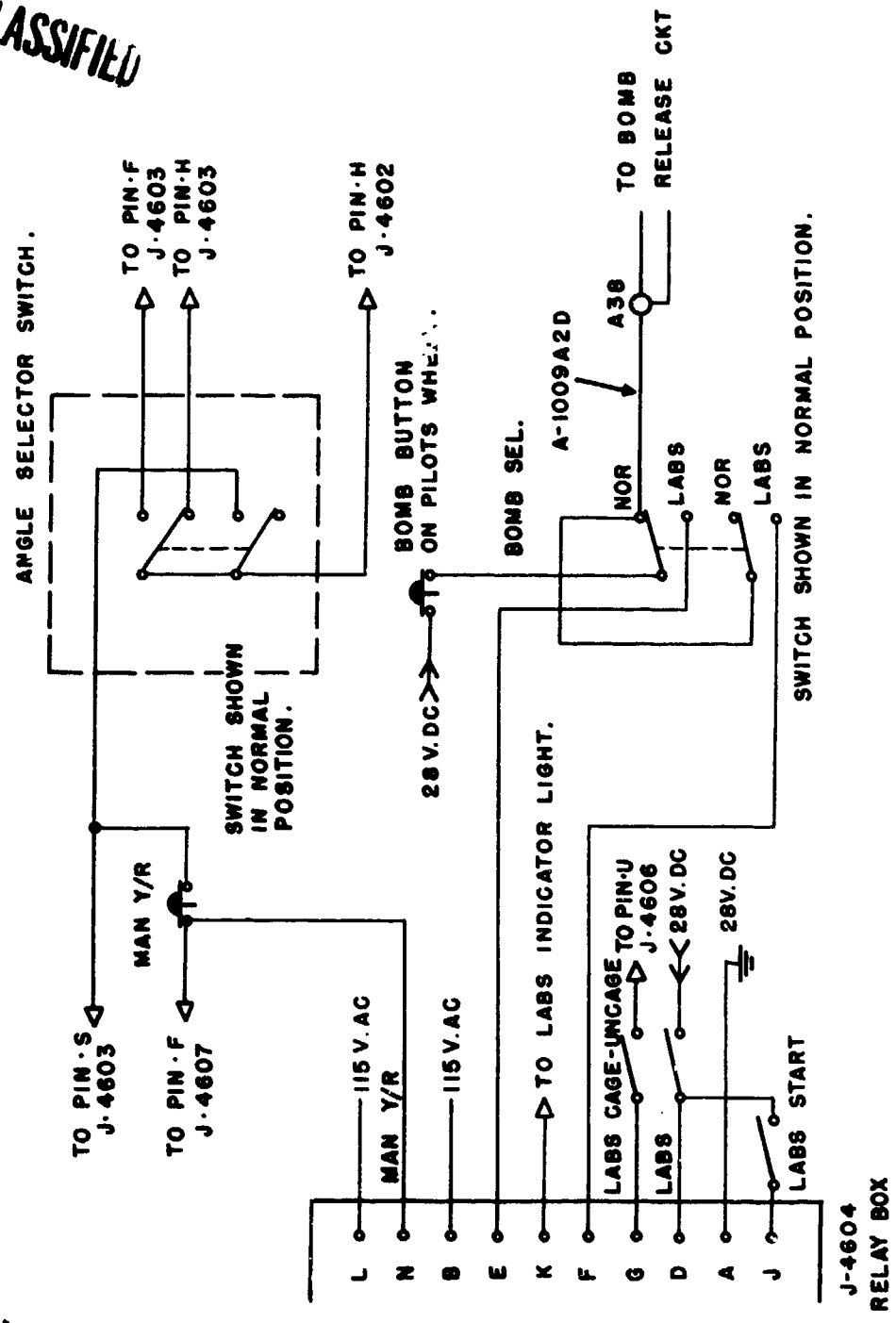

UNCLASSIFIED

Appendix H, Page 18

Inclosure I (S)

179

**UNCLASSIFIED**

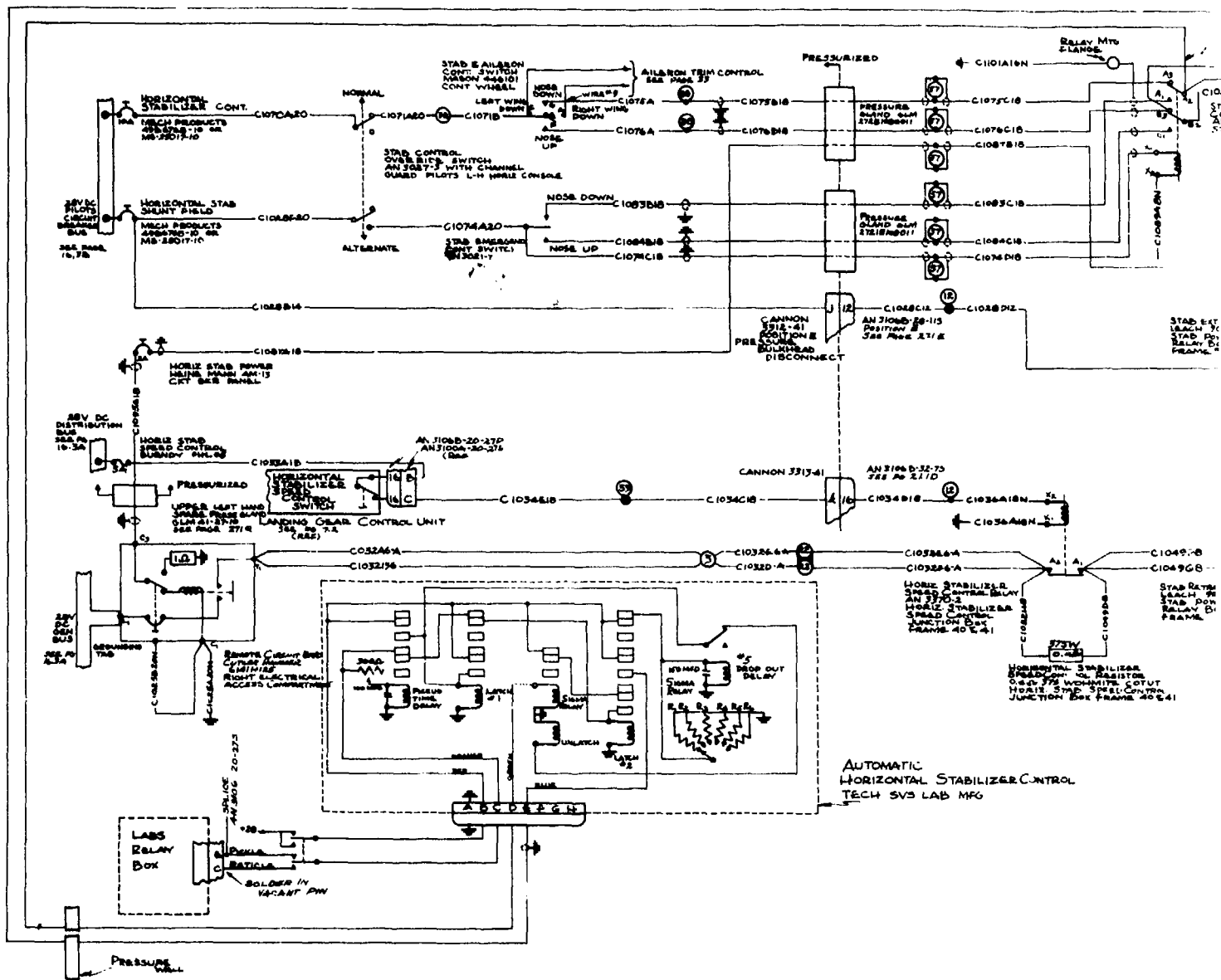

CODE	DESCRIPTION	LOCATION
①	PERMANENT SPLICE	FRAME 5 & 6 LEFT SIDE
②	TERMINALS	CONTROL COLUMN BASE
③	TERMINALS	TAIL SPLICE BETWEEN FRAMES 31B & 32
④	PERMANENT SPLICE	TAIL SPLICE BETWEEN FRAMES 31B & 32
⑤	OVERHEAD TERMINALS	RIGHT ELECTRICAL ACCESS COMPT.
⑥	PERMANENT SPLICE	CONTROL COLUMN BASE
⑦	PERMANENT SPLICE	FRAME 12 & 13

**UNCLASSIFIED**

①

UNCLASSIFIED

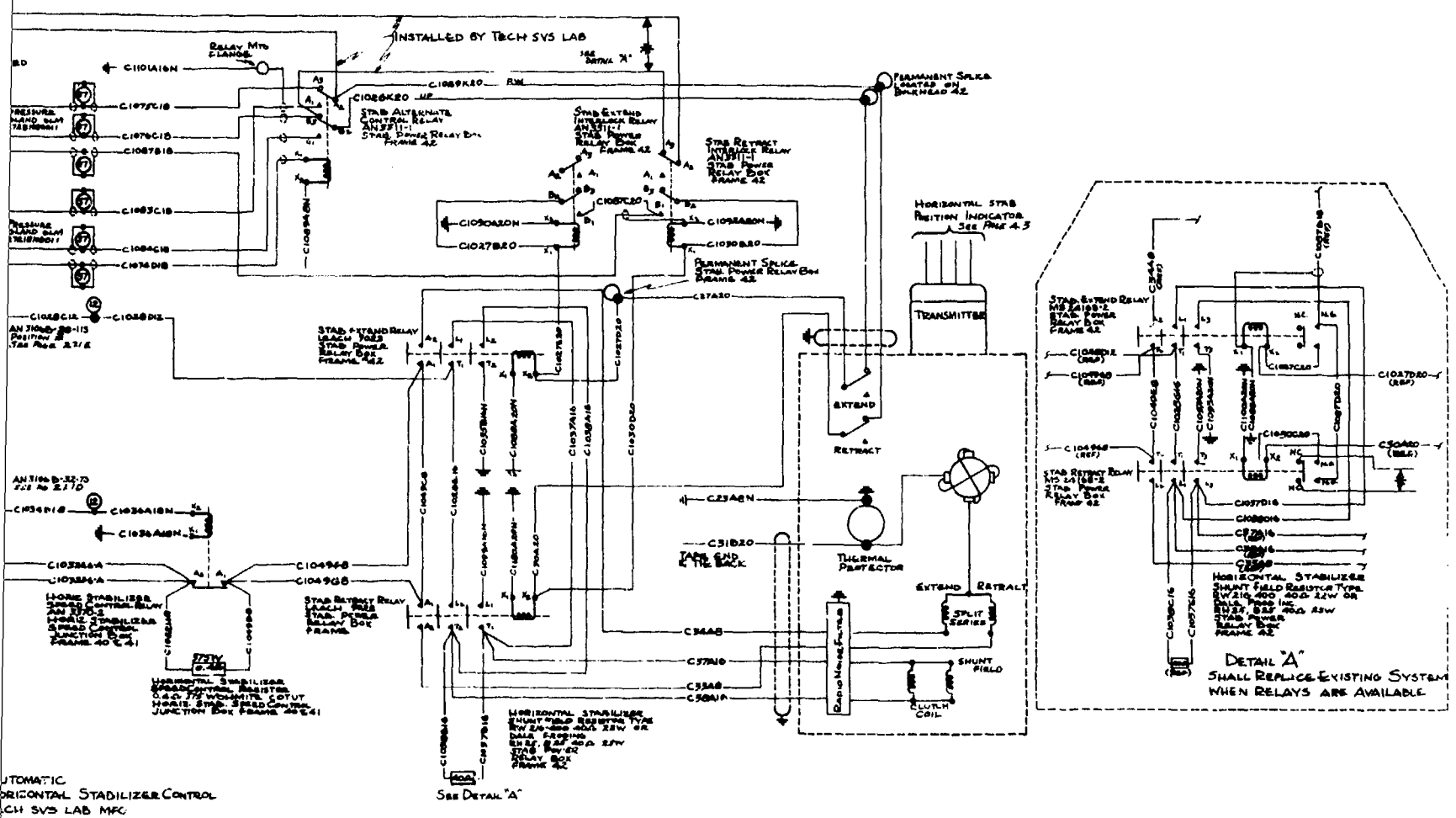
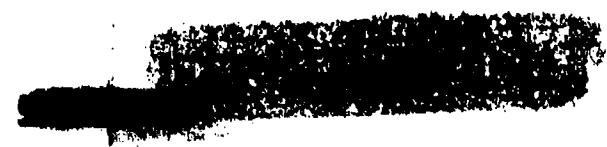

Automatic  
 Horizontal Stabilizer Control  
 Tech Sys Lab MFC

LOCATION  
 ME 586 Left Side  
 TROL COLUMN BASE  
 SPICE BETWEEN FRAMES 310 & 32  
 SPICE BETWEEN FRAMES 310 & 32  
 ELECTRICAL ACCESS COMPT  
 TROL COLUMN BASE  
 ME 12 5 13

UNCLASSIFIED

EGLIN AFB.		
TECH SYS LAB		
AUTOMATIC		
HORIZONTAL STABILIZER CONTROL MODEL B		
DOWN BY U.S. N.	CHK BY	6 JUN 4
		D-709

Inclosure II (S)

2



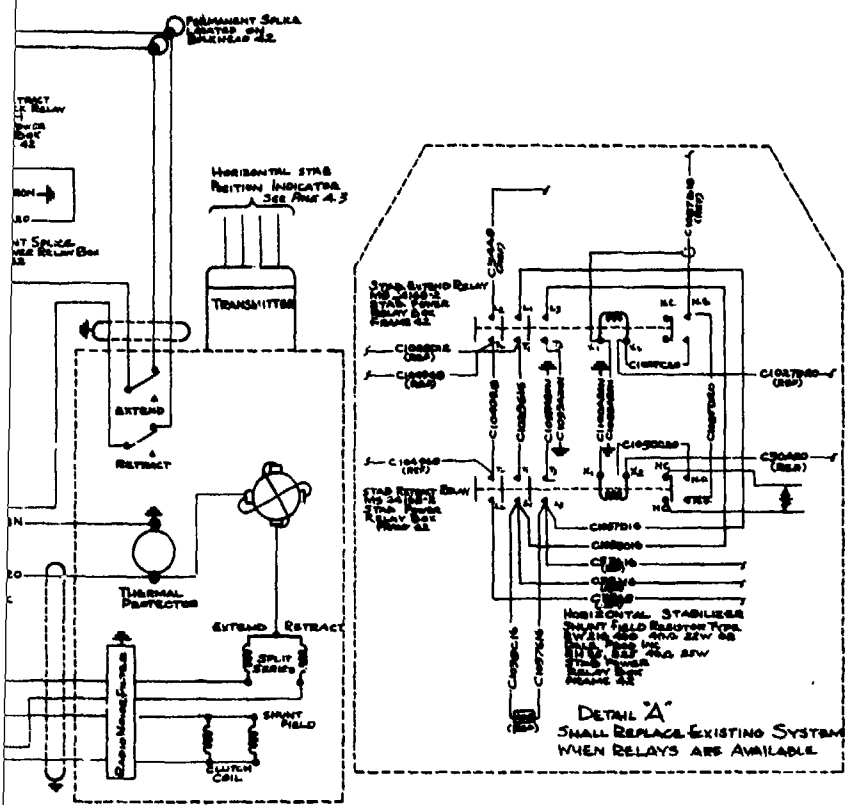

EGLIN AFB TECH SVS LAB AUTOMATIC		
HORIZONTAL STABILIZER CONTROL FOR MODEL B57B		
DRAWN BY U.J.N.	CHEK BY	6 JUNE 55
D-709		

Appendix H, Page 19      END OF REPORT

3

FROM: AFDTC/PA (OSN 872-3931) - Jim Swinton  
101 West D Avenue, Suite 129  
Eglin AFB FL 32542-5498

11 JAN 95

SUBJECT: Clearance for Public Release

The technical report "Operational Suitability of the B-57B Aircraft" has been reviewed. Public release is approved.

  
JERRY RENNE, Maj, USAF  
Chief of Public Affairs

Attachment:  
Tech Report

AFDTC/PA 94-366

UNCLASSIFIED/~~LIMITED~~

AD-8191 132

Technical Report  
distributed by



OPERATIONAL SUITABILITY TEST OF THE B-57B AIRCRAFT

**DEFENSE** (Final Report, Sep 1955)

**TECHNICAL  
INFORMATION  
CENTER**

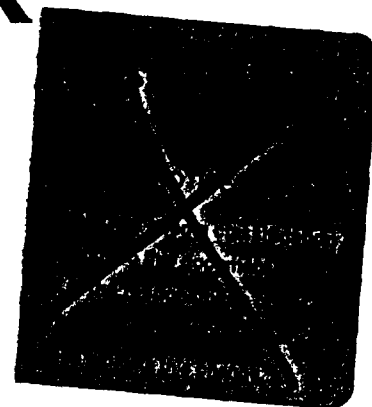

**DTIC** / Acquiring Information -  
Imparting Knowledge

Cameron Station  
Alexandria, Virginia 22304-6145

**— PUBLIC RELEASE —**

UNCLASSIFIED/~~LIMITED~~

(Per Ltr, AFDTIC/PA, 11 JAN 1995)