

REPORT DOCUMENTATION PAGE				<i>Form Approved OMB No. 0704-0188</i>	
<p>The public reporting burden for this collection of information is estimated to average 1 hour per response, including the time for reviewing instructions, searching existing data sources, gathering and maintaining the data needed, and completing and reviewing the collection of information. Send comments regarding this burden estimate or any other aspect of this collection of information, including suggestions for reducing the burden, to Department of Defense, Washington Headquarters Services, Directorate for Information Operations and Reports (0704-0188), 1215 Jefferson Davis Highway, Suite 1204, Arlington, VA 22202-4302. Respondents should be aware that notwithstanding any other provision of law, no person shall be subject to any penalty for failing to comply with a collection of information if it does not display a currently valid OMB control number.</p> <p>PLEASE DO NOT RETURN YOUR FORM TO THE ABOVE ADDRESS.</p>					
1. REPORT DATE (DD-MM-YYYY)		2. REPORT TYPE		3. DATES COVERED (From - To)	
4. TITLE AND SUBTITLE			5a. CONTRACT NUMBER		
			5b. GRANT NUMBER		
			5c. PROGRAM ELEMENT NUMBER		
6. AUTHOR(S)			5d. PROJECT NUMBER		
			5e. TASK NUMBER		
			5f. WORK UNIT NUMBER		
7. PERFORMING ORGANIZATION NAME(S) AND ADDRESS(ES)				8. PERFORMING ORGANIZATION REPORT NUMBER	
9. SPONSORING/MONITORING AGENCY NAME(S) AND ADDRESS(ES)				10. SPONSOR/MONITOR'S ACRONYM(S)	
				11. SPONSOR/MONITOR'S REPORT NUMBER(S)	
12. DISTRIBUTION/AVAILABILITY STATEMENT					
13. SUPPLEMENTARY NOTES					
14. ABSTRACT					
15. SUBJECT TERMS					
16. SECURITY CLASSIFICATION OF:			17. LIMITATION OF ABSTRACT	18. NUMBER OF PAGES	19a. NAME OF RESPONSIBLE PERSON
a. REPORT	b. ABSTRACT	c. THIS PAGE			19b. TELEPHONE NUMBER (Include area code)

Report Documentation Page			<i>Form Approved OMB No. 0704-0188</i>		
Public reporting burden for the collection of information is estimated to average 1 hour per response, including the time for reviewing instructions, searching existing data sources, gathering and maintaining the data needed, and completing and reviewing the collection of information. Send comments regarding this burden estimate or any other aspect of this collection of information, including suggestions for reducing this burden, to Washington Headquarters Services, Directorate for Information Operations and Reports, 1215 Jefferson Davis Highway, Suite 1204, Arlington VA 22202-4302. Respondents should be aware that notwithstanding any other provision of law, no person shall be subject to a penalty for failing to comply with a collection of information if it does not display a currently valid OMB control number.					
1. REPORT DATE 13 JUL 2006	2. REPORT TYPE Technical	3. DATES COVERED 00-05-2006 to 00-05-2006			
4. TITLE AND SUBTITLE A Review of the History of Fire Suppression on U.S. DoD Aircraft		5a. CONTRACT NUMBER			
		5b. GRANT NUMBER			
		5c. PROGRAM ELEMENT NUMBER 30603716D8Z			
6. AUTHOR(S) Donald Bein		5d. PROJECT NUMBER			
		5e. TASK NUMBER			
		5f. WORK UNIT NUMBER			
7. PERFORMING ORGANIZATION NAME(S) AND ADDRESS(ES) Naval Air Systems Command (NAVAIR), System Safety, Code 4.1.6.1, Highway 547, Lakehurst, NJ, 08733		8. PERFORMING ORGANIZATION REPORT NUMBER			
9. SPONSORING/MONITORING AGENCY NAME(S) AND ADDRESS(ES) Strategic Environmental Research and Development Program, Program Office, 901 N. Stuart Street, Suite 303, Arlington, VA, 22203		10. SPONSOR/MONITOR'S ACRONYM(S) SERDP			
		11. SPONSOR/MONITOR'S REPORT NUMBER(S)			
12. DISTRIBUTION/AVAILABILITY STATEMENT Approved for public release; distribution unlimited					
13. SUPPLEMENTARY NOTES					
14. ABSTRACT A review of the history of fire suppression on U.S. Department of Defense (DoD) aircraft is presented to provide a context against which the findings of the Next Generation Fire Suppression Technology Program (NGP) can be assessed. Aircraft fire suppression applications reviewed are powerplant compartments, which include engine nacelles and auxiliary power unit (APU) compartments, dry bay compartments, and fuel tank ullage (wet bays). The evolution of engine nacelle fire suppression system designs are presented, from ?conventional? systems design to current high-rate discharge systems. Nacelle/APU fire occurrence and suppression system discharge is presented relative to altitude and temperature. Pilot response and system effectiveness are also discussed. The evolution of active dry bay fire suppression is also presented, though active systems dedicated purely to dry bay fire protection have not been fielded until the advent of the Live Fire Test legislation. Technologies and methods implemented previously and currently for fuel tank ullage fire suppression are then discussed.					
15. SUBJECT TERMS Auxiliary Power Unit, APU, Boiling Point, Cold Soak, Engine Nacelle, Fire Suppressant, Fire Suppression, Fixed-Wing Aircraft, Halon, HFC-125, Nacelle, Nacelle Airflow Temperature, Outside Air Temperature, Rotary Aircraft, Worldwide Air Environment					
16. SECURITY CLASSIFICATION OF:			17. LIMITATION OF ABSTRACT	18. NUMBER OF PAGES	19a. NAME OF RESPONSIBLE PERSON
a. REPORT unclassified	b. ABSTRACT unclassified	c. THIS PAGE unclassified	1	37	

A Review of the History of Fire Suppression on U.S. DoD Aircraft

Donald Bein

Naval Air Systems Command (NAVAIR)
System Safety, Code 4.1.6.1
Highway 547, B562-2
Lakehurst, NJ 08733
Telephone: (732) 323-1660
Fax: (732) 323-5269
E-mail: donald.bein@navy.mil

ABSTRACT

A review of the history of fire suppression on U.S. Department of Defense (DoD) aircraft is presented to provide a context against which the findings of the Next Generation Fire Suppression Technology Program (NGP) can be assessed. These findings are to be published later this year (2006) in the NGP final report. Aircraft fire suppression applications reviewed are powerplant compartments, which include engine nacelles and auxiliary power unit (APU) compartments, dry bay compartments, and fuel tank ullage (wet bays). The evolution of engine nacelle fire suppression system designs are presented, from “conventional” systems design to current high-rate discharge systems. Nacelle/APU fire occurrence and suppression system discharge is presented relative to altitude and temperature. Pilot response and system effectiveness are also discussed. The evolution of active dry bay fire suppression is also presented, though active systems dedicated purely to dry bay fire protection have not been fielded until the advent of the Live Fire Test legislation. Technologies and methods implemented previously and currently for fuel tank ullage fire suppression are then discussed.

BACKGROUND

As the Department of Defense’s (DoD) Next Generation Fire Suppression Technology Program (NGP) culminates its research efforts, it is prudent to capture the history of fire suppression on DoD aircraft. This is being done as part of the final report being generated for the NGP, since in the years to come, it is possible that it will become increasingly difficult to assemble such history. Such difficulty was apparent when attempting to research the basis for aircraft nacelle fire suppression systems during the conduct of the DoD’s Halon Alternative Technology Development Program (TDP), which was the program that preceded the NGP. This paper provides a synopsis of the history of fire suppression in DoD aircraft. For the more detailed account, the reader is referred to the NGP final report, which is to be entitled *Advanced Technology for Fire Suppression in Aircraft* and will be published later this year (2006).

DISCUSSION

Safety and survivability drive the requirements for fire suppression in aircraft. Whereas safety is concerned with mitigation of hazards associated with system or component failures or human error, survivability relates to susceptibility and vulnerability to threats directed at the aircraft. An aircraft fire is deemed a safety-related fire when it results from component failures, which may be due to inadequate design, a mechanical failure mechanism such as fatigue, or maintenance error, and results in either a flammable fluid contacting an always-present ignition source, such as a hot engine case, or the failures themselves provide both the flammable fluid and the ignition source. Fires that relate to aircraft survivability are those that are ballistically induced in areas on an aircraft that, if not protected by some means, are vulnerable to fire or even explosion.

SAFETY PERSPECTIVE

From a safety perspective, fire is one of many events that can result in loss of an aircraft and/or fatalities, as illustrated in Figure 1. Previous studies [1,2] suggest that in commercial aviation fire accounts for less than 5% of commercial aircraft accidents and fatalities, as indicated in Figures 2 and 3.

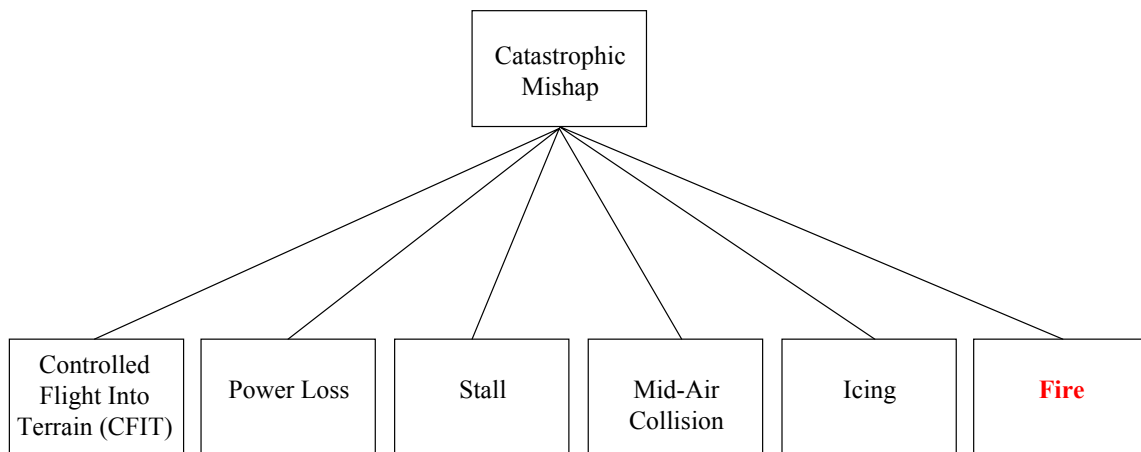

Figure 1. Safety Perspective - Example Breakout of Some Catastrophic Mishap Causal Factors

Throughout aviation history the evidence is overwhelming that the predominant safety fire threat is within aircraft powerplant compartments, and of these compartments the greatest frequency of occurrence of fire occurs in the engine nacelle. Fire suppression systems are typically not provided on DoD single-engine aircraft, since the aircraft design approach to date in DoD and commercial aviation has been to first isolate flammable fluids from the nacelle prior to discharge of a fire suppression system. For a single-engine aircraft, this would effect immediate loss of thrust. For *multi-engine aircraft* the likelihood of a catastrophic event from a fire in one of the nacelles is a stack-up of several probabilities or likelihoods. If $p(\text{in-flight nacelle fire mishap})$ denotes the probability of a catastrophic event resulting from a nacelle fire (i.e., aircraft loss and/or fatalities), then the stack-up of events to realize the mishap are:

Fatalities by CAST/ICAO Taxonomy Accident Category* Fatal Accidents – Worldwide Commercial Jet Fleet – 1987 Through 2004

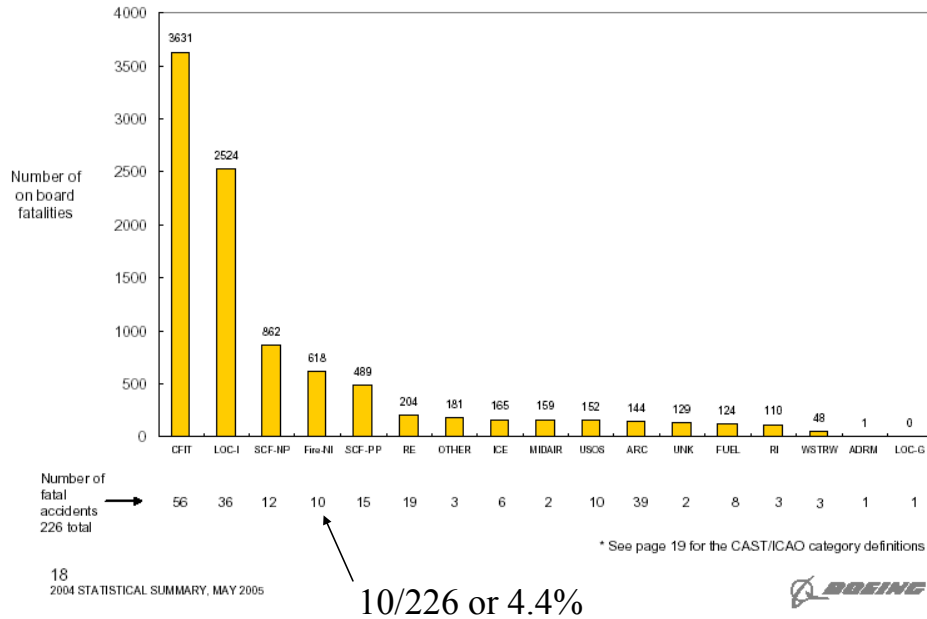
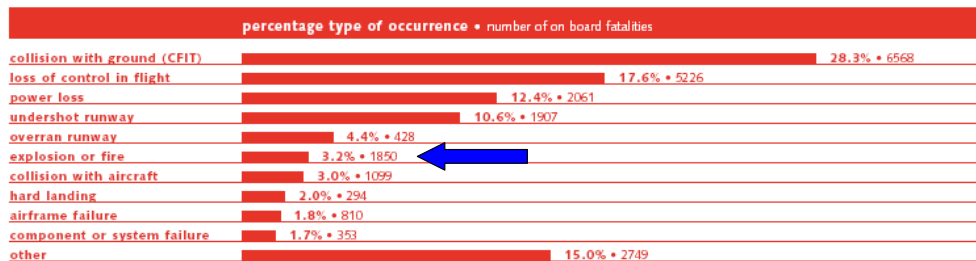

Figure 2. Study of Fatal Accidents in Worldwide Commercial Jet Fleet, 1987 – 2004 [1]
 (Fire-NI denotes non-impact fire events.)

11

Type gebeurtenissen en aantal doden

WERELDWIJD . 1980 - 2001



Fatale ongevallen hebben meestal meer dan één oorzaak: alle fatale ongevallen worden echter ingedeeld op dat type gebeurtenis dat als eerste plaats heeft gevonden en ten slotte heeft geleid tot het ongeval (initial event). De indeling van de gebeurtenissen is volgens een internationale standaard (ICAO).
 CFIT en verlies van beheersing en besturing van het vliegtuig tijdens de vlucht zijn de twee belangrijkste gebeurtenissen. Dit zijn ook de gebeurtenissen die de meeste dodelijke slachtoffers tot gevolg hebben. Zowel op nationaal als internationaal niveau worden inspanningen ondernomen om deze gebeurtenissen te reduceren.

Type of occurrences and fatalities
 Most of the time, fatal accidents have more than one cause. Fatal accidents are grouped according to the initial event that led to the accident. Occurrences are categorized according to the standards of the International Civil Aviation Organisation. CFIT and Loss of Control during the flight are the two most important occurrences and involve the most fatalities. Nationally and internationally, actions continue to be taken to reduce these occurrences.

Veiligheidsstatistieken luchtvaart 1980 - 2001 Wereldwijd en Nederland

Veiligheidsstatistieken luchtvaart 1980-2001, Civil Aviation Safety Data

Figure 3. Study of Fatal Accidents in Worldwide Commercial Jet Fleet, 1980 – 2001 [2]

$p(\text{fire occurs}) \text{ AND } [p(\text{pilot isolates nacelle from flammable fluid AND fire persists})$
 $\text{OR } p(\text{failure to isolate nacelle from flammable fluid AND fire persists})]$
 $\text{AND } [p(\text{nacelle fire suppression system fails to suppress})$
 $\text{OR } p(\text{nacelle fire suppression system fails to activate})]$
 $\text{AND } p(\text{safe landing of aircraft is not executed})$

Summaries of DoD aircraft mishap causal factors similar to those shown in Figures 2 and 3 are not available readily nor are they constructed easily. However, during the Halon Alternative Technology Development Program (TDP), a review of the U.S. Navy (USN) mishap and fire incident data was performed [3,4] and showed that when fire occurred for either fixed-wing or rotary aircraft, only 9% of the events resulted in aircraft loss, as illustrated in Figure 4. When that data is reviewed further it can be shown that utilization of nacelle fire suppression systems represents an even smaller subset of the aircraft operational experience. The same review of Navy fire mishap and incident data also reaffirmed that safety-related fires occurred predominately in engine compartments [5], as illustrated in Figure 5. (Note that in Figure 5 forty-nine percent (49%) of the fires represented in the electrical equipment bar occurred on one aircraft platform type within the aircraft cabin and were readily extinguished by either securing electrical power to that equipment or by use of on-board portable fire extinguishers. Also in Figure 5, ECS is an acronym for Environmental Control System.)

When fire occurred in rotary or fixed-wing aircraft:

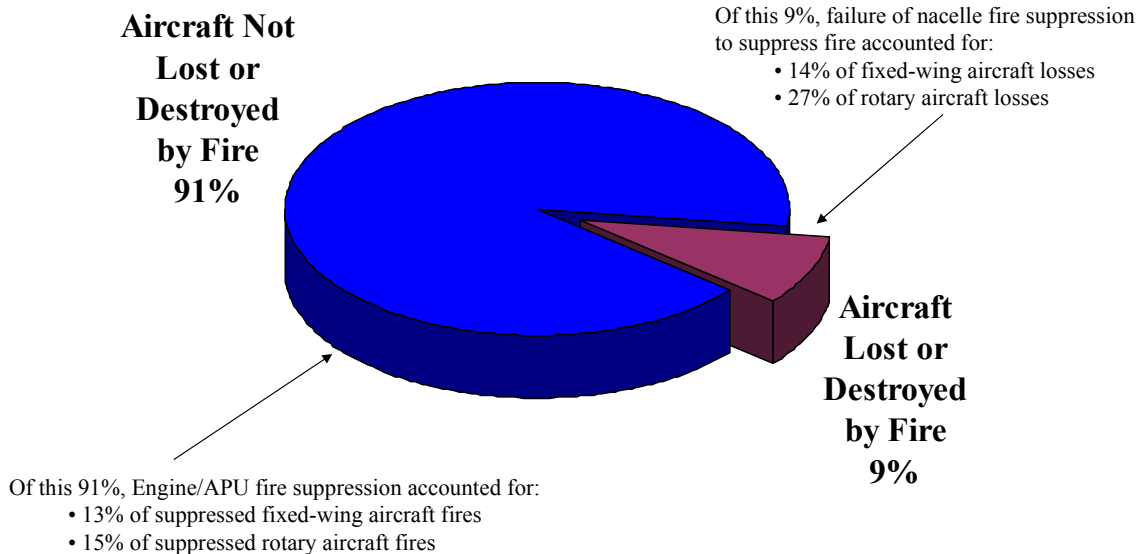

Figure 4. USN Fire Mishaps and Incidents, Aircraft Destroyed or Not Destroyed Due to Fire, 1977-1993 [3,4]

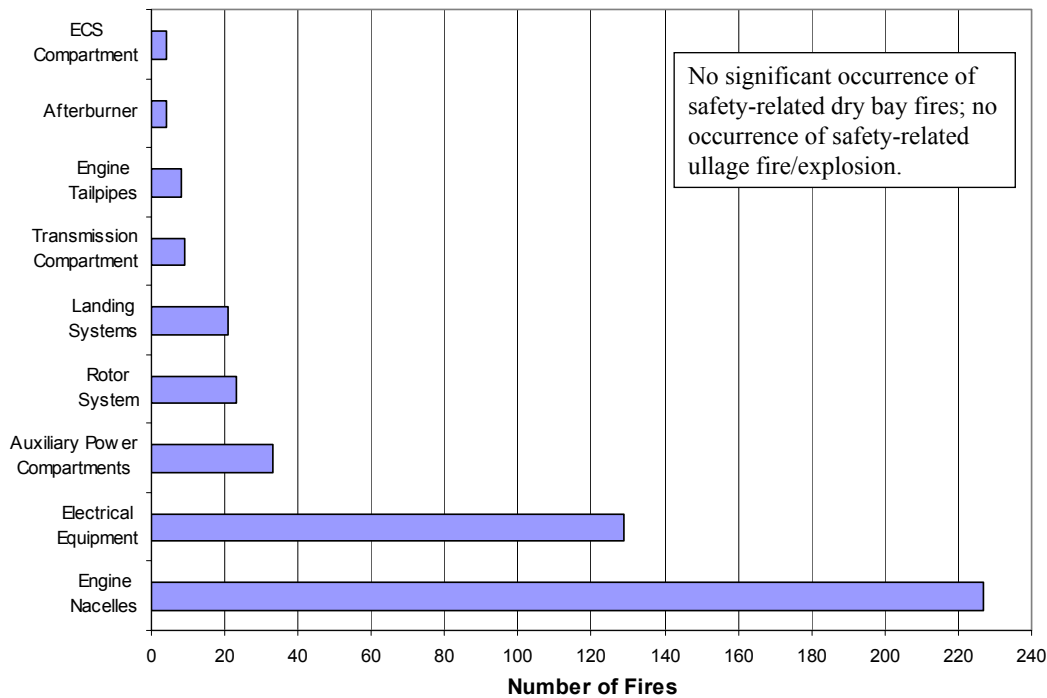

Figure 5. USN Fire Mishaps and Incidents by Aircraft Compartment, 1977-1993 [5]

ENGINE NACELLE FIRE SUPPRESSION

As early as 1922 there is National Advisory Committee on Aeronautics (NACA) reference [6] to implementation of engine compartment fire suppression, which consisted of a fire extinguisher within that compartment and was controlled from the pilot’s seat. Additionally, shutters were installed to eliminate external airflow into the compartment. No specific reference is provided as to the fire suppressant in this case, but one could speculate. The Naval Studies Board has reported that in the 1920s non-fluorinated halon agents were tried experimentally in engine nacelle extinguishers, but their use was abandoned by the U.S. military in favor of the non-corrosive carbon dioxide (CO₂) [27]. Figure 6 shows examples of contemporary engine nacelles and nacelle fire suppression system installations. Generally, the system design philosophy is similar to that described back in 1922: the fire suppressant bottle may be external or internal to the compartment, doors and actuators for closing off compartment air flow may be installed, and discharge control is manual and is effected from the cockpit (pilot’s seat). In the right photograph in Figure 6 CAD is an acronym for cartridge actuated device, and the white box below it is an actuator for a door to close off airflow into the nacelle air inlet.

Figure 7 shows examples of various nacelle/APU fire suppressant bottle installations. These may be located within compartments on aircraft like the nacelle, in which compartment airflow temperature can easily exceed 93.3°C (200°F), or like a wheel well compartment, in which the compartment temperature may be relatively similar to the outside air temperature (OAT).

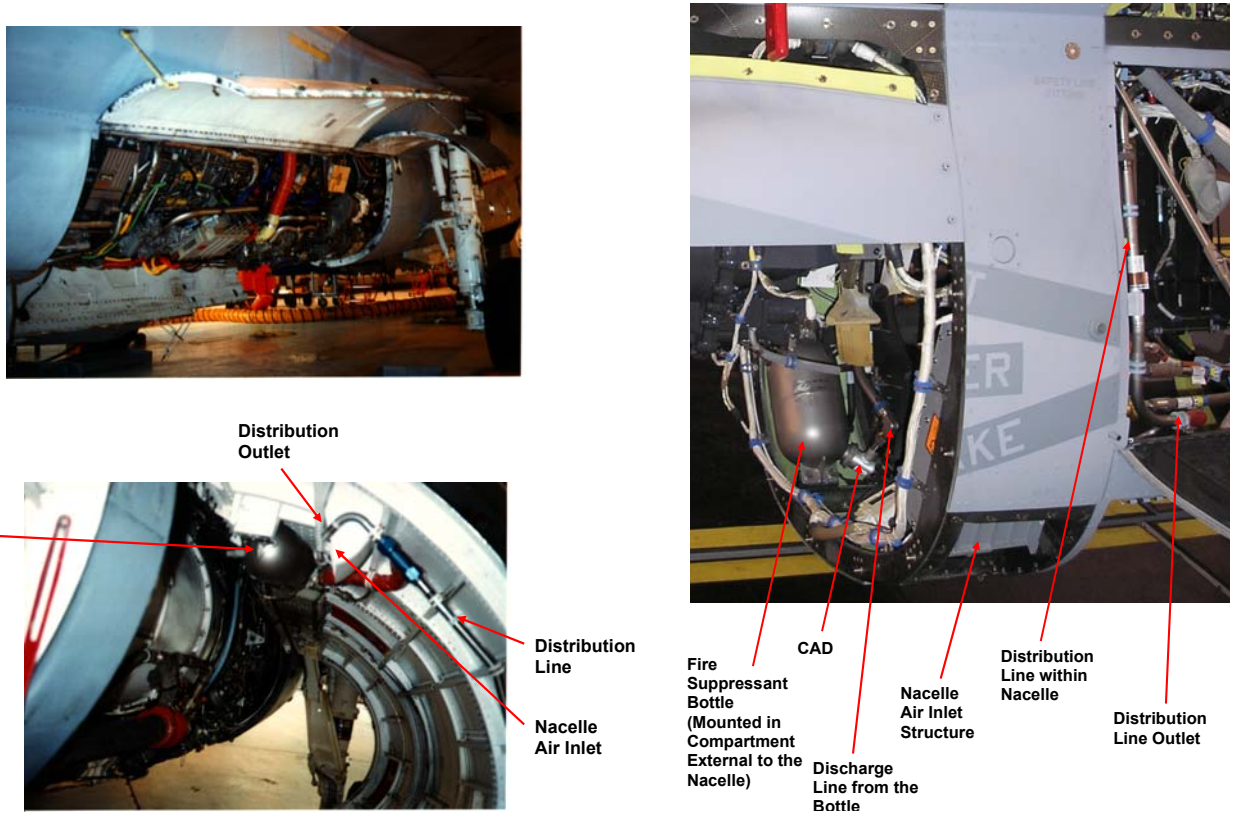

Figure 6. Examples of Contemporary Engine Nacelles and Fire Suppression Systems



(Photo of spherical bottles is from the "737 web site" and used with permission by its author, C. Brady.)

Figure 7. Engine Nacelle/APU Fire Bottle Installations

FIRE SUPPRESSION FOR AUXILIARY POWER COMPARTMENTS

In addition to engine compartments DoD military aircraft may contain other types of powerplant compartments for which a fire suppression capability is provided, either dedicated or shared with another fire suppression system on the aircraft. The most common compartment that falls into this category is that containing the auxiliary power unit (APU). Figure 8 shows examples of APU aircraft installations. On some aircraft this compartment may also be referred to as the auxiliary powerplant (APP) or the gas turbine compressor (GTC) compartment. These units may be miniature turbines or other power generating equipment but are typically smaller than the normal jet engine propulsion systems. These units furnish electrical power when engine-driven generators are not operating or when external power is not available, and they may be used to provide emergency power to all or some of the aircraft subsystems in the event of an in-flight engine shutdown.

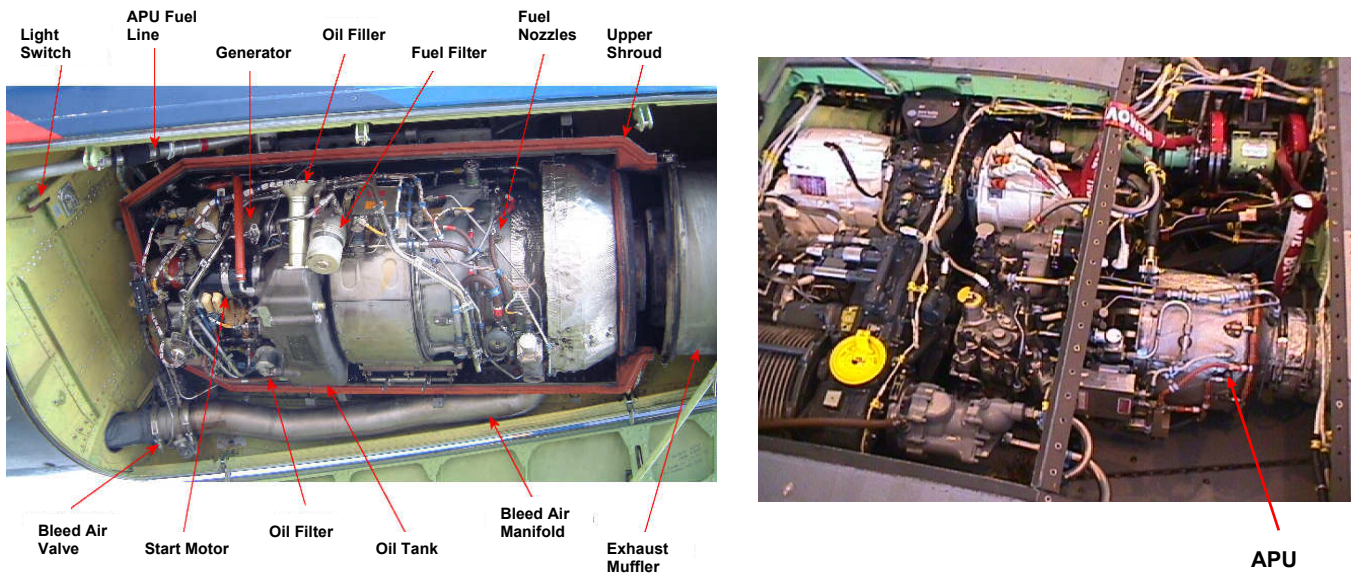

(Photo of APU compartment above is from the “737 web site” and used with permission by its author, C. Brady.)

Figure 8. Examples of Contemporary Auxiliary Power Unit (APU) Installations

ENGINE/APU FIRE SUPPRESSION SYSTEM DISCHARGE

As indicated previously, discharge of engine nacelle and APU fire suppression systems is effected manually. Upon detection of fire in either compartment type, a fire warning is generated in the cockpit. The pilot will isolate fuel flow from the affected compartment, most often by pulling a T-handle-type control, as shown in Figure 9(a); rotation of the handle then arms the fire suppression system. On some aircraft, illumination of the handle is the visual fire warning indication in the cockpit. On other aircraft, there may be separate fire warning indicators. The pilot will then confirm that the fire condition persists through verification that the warning indication remains illuminated and may also check, if possible, for secondary

indications, such as smoke or flammable fluid leaking from the affected compartment, or if correlating failure conditions are indicated in the cockpit, such as a failure indication within the fuel system. If fire persists the pilot will discharge the fire suppression system, which in Figure 9(a) is accomplished by pressing the controls labeled 1 (for fire bottle number 1) and if needed 2 (for fire bottle 2). This results in an electrical signal from the cockpit to the fire bottle, which initiates a pyrotechnic or cartridge actuated device (CAD) that ruptures a burst disc on the fire bottle allowing agent to be released. There also exists, but to a minimal extent, mechanical systems such as pulleys to effect burst disc rupture, as shown in Figure 9(b).



(Photo of cockpit fire panel above is from the “737 web site” and used with permission by its author, C. Brady.)

(a) Electrical

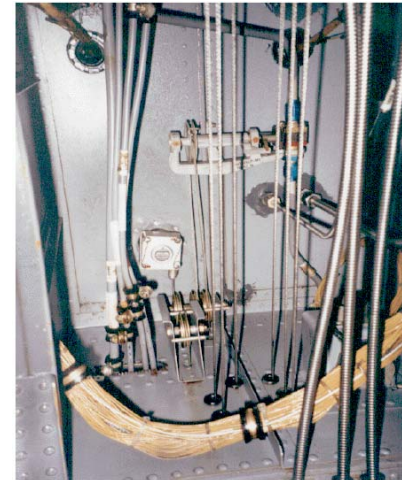

(b) Mechanical

Figure 9. Engine/APU Fire Suppression System Discharge Control

EVOLUTION OF NACELLE FIRE SUPPRESSION SYSTEMS

The requirements for design and implementation of aircraft fire suppression for powerplant compartments have evolved for a variety of reasons, primary among them being powerplant design and the fire suppressant. For example, powerplant fire suppression system design guidance published by the civil aeronautics administration (CAA) in 1943 [7] for use of methylbromide (halon 1001) and CO₂ and was relative to mass airflow in the compartment and the number of cylinders in a radial cylinder engine installation. Agent distribution was to be accomplished using spray nozzles or perforated tubes providing approximate equal distribution and a “sheet of agent spray” across the cross section of the protected zone orthogonal to the airflow. These systems were to become known as conventional distribution systems.

During World War II the German Navy sponsored efforts by I.G. Farbonindustrie to develop an alternative to methyl bromide (halon 1001) due to its toxicity, which resulted in the development of chlorobromomethane (CB or halon 1011) in the 1939-1940 time period [8]. Halon 1011 was determined to be as effective as halon 1001 and less toxic. Testing in 1942 by then Junkers/Dessau for the German Luftwaffe focused on developing a powerplant fire suppression

system using Dachlaurin (D-L), a mixture of 65% halon 1011 and 35% CO₂. In early 1945 the Luftwaffe approved the principle of the D-L system and ordered its installation on all German military aircraft, subject to then not-yet-established priorities. It was planned that the D-L system was to be installed on the Messerschmitt ME 262, the first operational jet-powered fighter. Given the time the directive was issued, it is likely D-L did not come into widespread use before the end of the war. After the war extensive evaluation of halon 1011 was conducted within the U.S. and by 1950, the U.S. Air Force (USAF) required use of halon 1011 systems instead of CO₂ systems in new aircraft and subsequently issued a specification for such systems [9]. Design guidance for use of halon 1011 in powerplant fire suppression system evolved as jet propulsion became more widespread; however, the conventional distribution system approach was still employed for halon-1011-based fire suppression systems.

Techniques for effecting and assessing adequate distribution changed along with the evolution to jet propulsion powerplants. Testing conducted by the CAA compared fire suppression performance of conventional systems versus open-ended systems [10], which later became known as high-rate-discharge (HRD) systems. The HRD systems presented a simplified distribution approach in that perforated distribution lines were replaced with few open tubes out of which the fire suppressant would discharge at a much higher rate. Rather than relying on plumbing to disperse the suppressant, dispersion would be effected by the turbulent mixing of the suppressant discharge jet and the nacelle mass air flow, with the suppressant stored under higher pressure conditions than had been done for conventional systems. Further testing by the CAA demonstrated that the HRD design required less halogenated fire suppression agent to suppress nacelle fires and simplified distribution system design. Testing conducted later by the Wright Air Development Center (WADC) promoted the conclusion that the efficiency of a fire suppression system would be improved with increasing suppressant discharge velocity [11], and that a “critical saturation value,” in percent concentration by volume, occurred between 50 and 100 feet per second for the suppressants evaluated (halon 1011, halon 1301, and halon 1202). Today, HRD systems utilizing halon 1301 are the most prevalent nacelle fire suppression system implementation for engine nacelle and APU fire suppression on DoD and commercial aircraft. Figure 10 illustrates evolution of nacelle fire suppression systems.

FIRE SUPPRESSANT BOILING POINT

The fire suppressant boiling point (T_b) of a fire suppression agent has been used as one of the criterion to guide the search for new halon alternative chemical fire suppressants under the NGP [12]. The T_b criterion was established as -40°C (-40°F). It was also one of the parameters considered during research efforts that identified pentafluoroethane (HFC-125) as the best near-term alternative to halon 1301 for use in aircraft nacelle fire suppression system applications [13] and has since been implemented for nacelle/APU fire protection on newer model DoD aircraft (MV/CV-22, AH-1Z, UH-1Y, F/A-18E/F, and F-22). Previous research conducted by the NGP [14] identified the relationship between the climatic profiles that influence aircraft design and the relevance of the aircraft temperature envelope requirement for engine nacelle and APU fire suppression systems. The T_b of halon 1301, generally -58°C (-72°F) at atmospheric pressure, is consistent with severe-cold land environments and the low temperatures recorded at lower altitudes in the cold world-wide air environments [15], though other halon fire suppressants such as halons 1011, 1202 and 1211 are also currently utilized for nacelle fire suppression and have

much higher boiling points. Boiling points for these suppressants are 66°C (151°F), 22.5°C (72.5°F), and -9°C (16°F), respectively. As shown in Figure 11, the challenge confronted by the NGP was that potential alternatives to halon 1301 other than HFC-125 were indicated to have higher boiling point characteristics. Given that higher-boiling-point halons have been fielded for years, it was questioned whether operational experience supported the 40°C (-40°F) criterion. This led the NGP to investigate DoD fire mishap and incident data to assess temperature conditions at which nacelle fire suppressant releases have occurred.

WWII Proposed Dachlaurin System: 65% Halon 1011, 35% CO₂

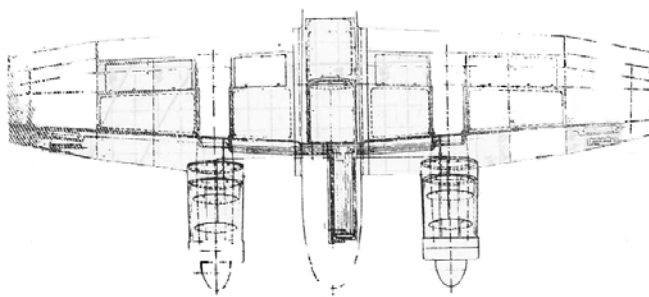

From: Hitchcock, E.B. and Scarlon, E.A., "Use of Monochlorobromomethane by the German Navy and Air Force as a Fire Extinguishing Agent," U.S. Naval Technical Mission in Europe, Technical Report No. 276-45, 1945

Post WWII Halon 1001, Turboprop

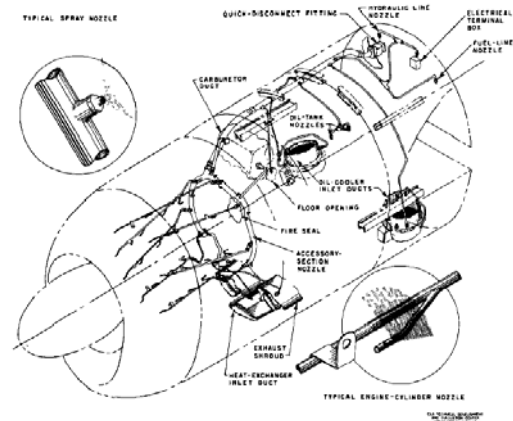

From: Civil Aeronautics Administration Technical Development Report 198

Halon 1011, Turbojet

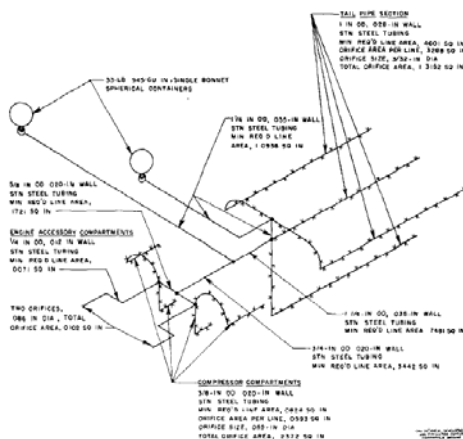

From: Civil Aeronautics Administration Technical Development Report 240

Halon 1301 Today

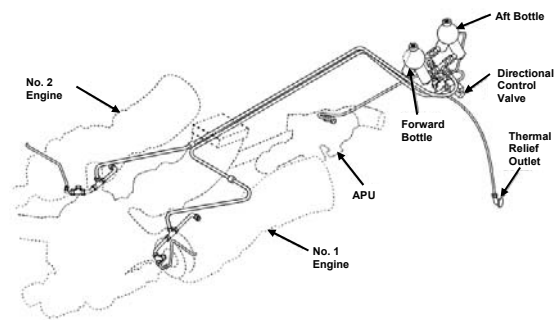

From: *Fire Suppression Substitutes and Alternatives to Halon for U.S. Navy Applications*, National Academy Press, 1997

Figure 10. Evolution of Engine Nacelle Fire Suppression Systems

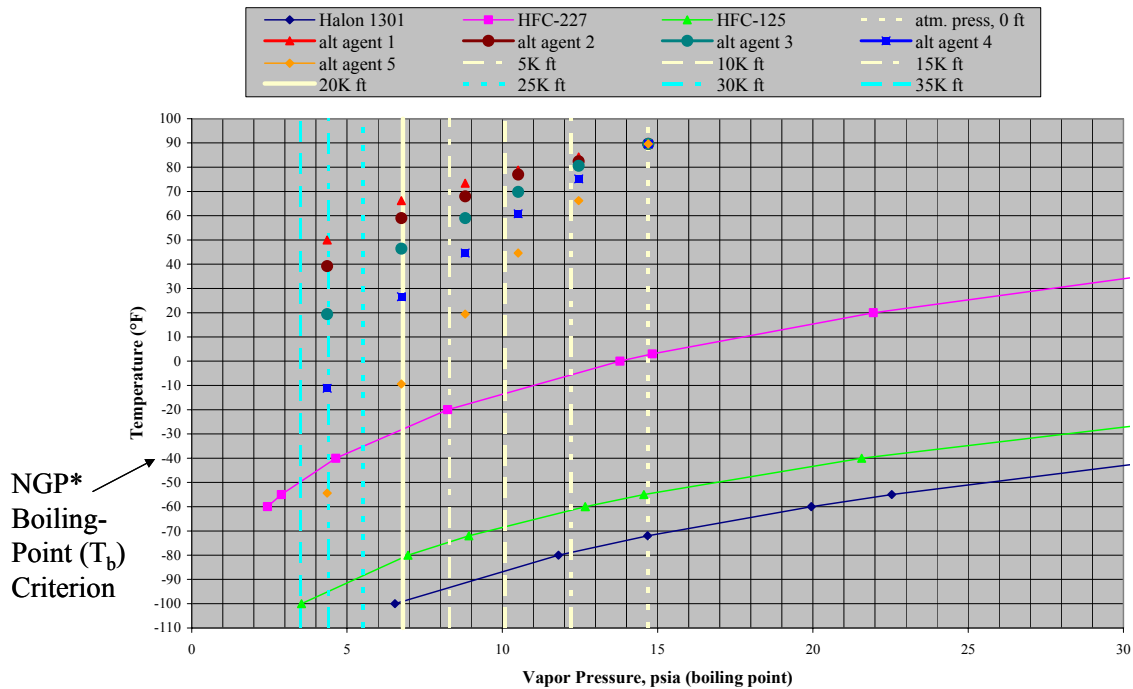

Figure 11. Suppressant Boiling Point vs. Standard Atmosphere Pressure

OUTSIDE AIR TEMPERATURE

A review conducted within U.S. Army aviation of rotary aircraft fires between 1985 and 1995 [16] had found that the lowest outside air temperature (OAT) reported was 0°C (32°F) and the highest reported was the 35°C (95°F). This review concluded that the only time a -50 degree temperature would *remotely* be encountered is at extremely high altitude or in extremely remote northern/southern areas of the earth. In making this conclusion, Reference [16] did not specify the temperature scale. The use of term *remotely* has significance in that within DoD it relates to hazard rate of occurrence. During the time period of the U.S. Army study, aggregate rate of occurrence of in-flight rotary aircraft fires was 4.9 per million flight hours, a remote rate of occurrence per Reference [17]. Thus likelihood of a nacelle fire occurring at lower outside air temperatures or in an extremely cold environment *and* resulting in loss of aircraft would be an even lower (improbable) likelihood.

Publicly-Available Data

Prior to investigating the DoD operational experience, the NGP surveyed publicly available data related to aircraft operation and outside air temperature (OAT). This was done to establish confidence that conducting the review of the combined DoD data, that is U.S. Army, USN, and USAF, would likely provide useful information. Figure 12 plots the then-available data points from the National Transportation Safety Board (NTSB) database that included both OAT and altitude. (Note: a data point representing the TWA 800 ullage explosion event at 13,800 feet is

not shown as OAT for that event was not available.) Without further investigating the details behind the fire events (i.e., which were actually nacelle or APU compartment fires, this data suggested clearly preponderance of fire events well above -20°C (-4°F) and at altitude below 2.7 kilometers (9,000 feet).

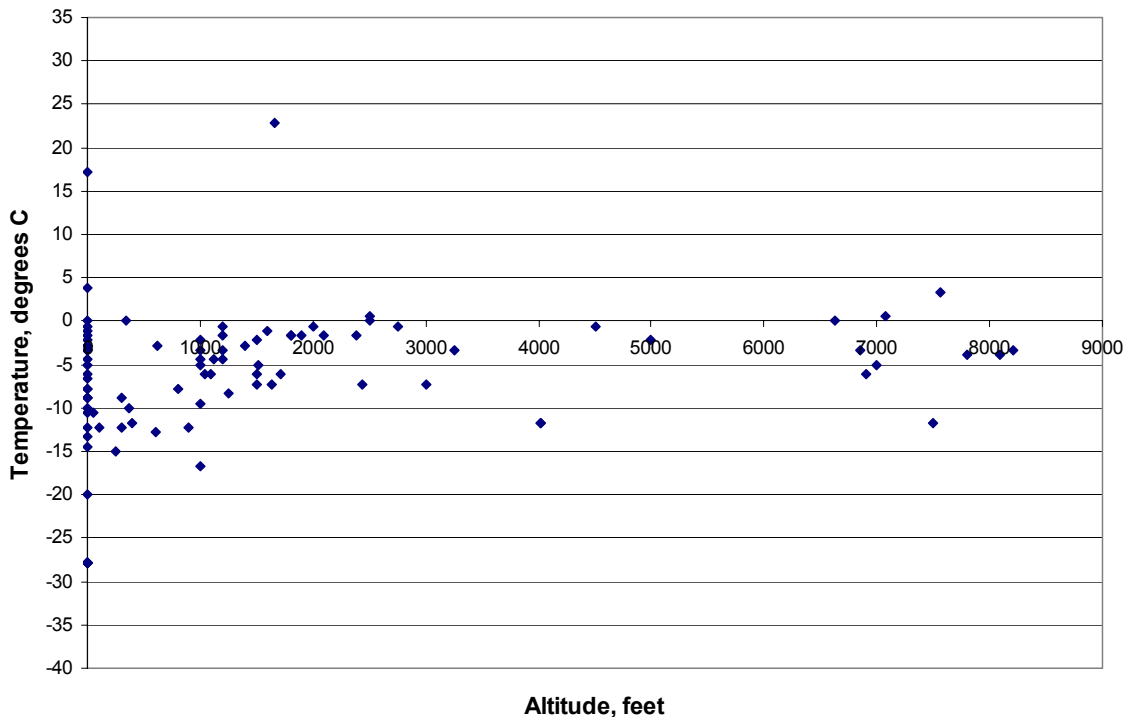

Figure 12. NTSB Database Fire Events Including Both OAT and Altitude, 1988 - 2000

Another issue related operational temperature experience and aircraft fire suppression is that of a cold-soaked aircraft and a fire occurring during engine or APU start-up when cold soaked. Figure 13 plots cold-soak aircraft wing temperatures versus OAT during aircraft ground operations in Canadian winter weather [18]. This data suggested aircraft operational experience in a cold climate predominantly above -20°C (-4°F), and also shows generally that for a given OAT the aircraft cold-soak temperature is several degrees higher.

A detailed account of the NGP investigation into the history of temperature conditions at which nacelle fire suppressant releases have occurred is described in Reference [14]. What follows provides a brief summary of those findings.

DoD Data Review

Table 1 summarizes the number of DoD fire mishap and incident data that were reviewed covering the period 1980 through 2002. Table 2 summarizes the percentage of fire incidents determined to have occurred in geographic cold or severe-cold environments, as defined by Reference [15]. Figures 14 and 15 plot the geographic locations of *ground* fire events versus the Reference [15] land environments for rotary aircraft and fixed-wing aircraft, respectively. In

these figures it can be seen that the clear majority of events occurred in geographic locations associated with Reference [15] *basic* land environments.

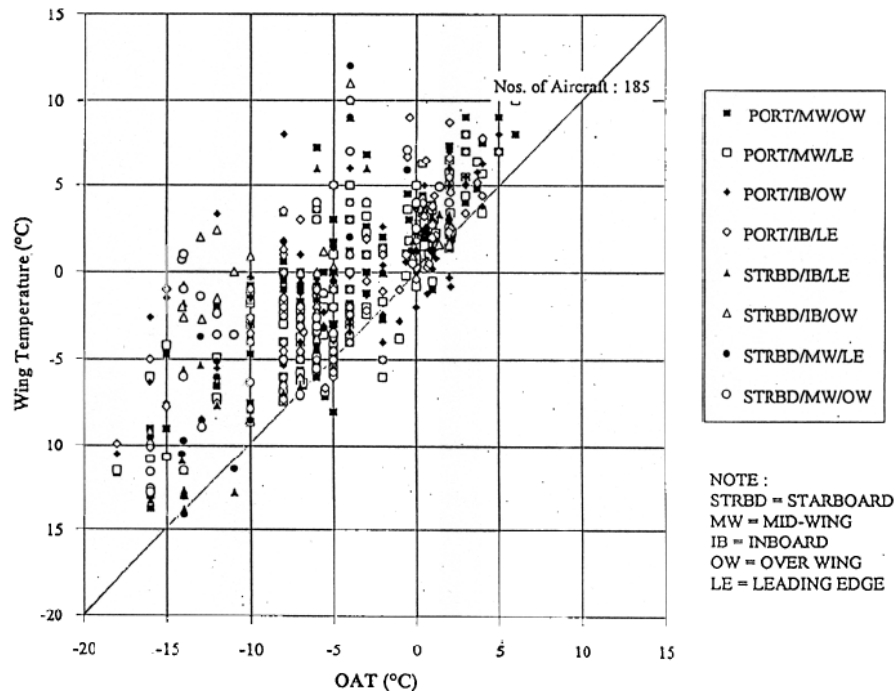

Figure 13. Cold-Soak Wing Temperatures in Aircraft Ground Operations in Canadian Winter Weather

Table 1. Number of Incidents (Number of Mishaps/Incidents Reviewed), 1980-2002

Service, Aircraft Type	Army	Navy	Air Force
Fixed Wing	88	1,212	3,932
Rotary	465	834	98

Table 2. Percentage of Fire Incidents Occurring in Geographic Cold or Severe-Cold Environments

Service, Aircraft Type	Army	Navy	Air Force
Ground	0	1.5%	1.1% ^(a)
In-Flight	< 1%	< 1%	2.7% ^(b)

(a) From data categorized as ground fire incidents only.

(b) From data categorized as in-flight fires only but also includes incidents on ground characterized as flight fire incidents.

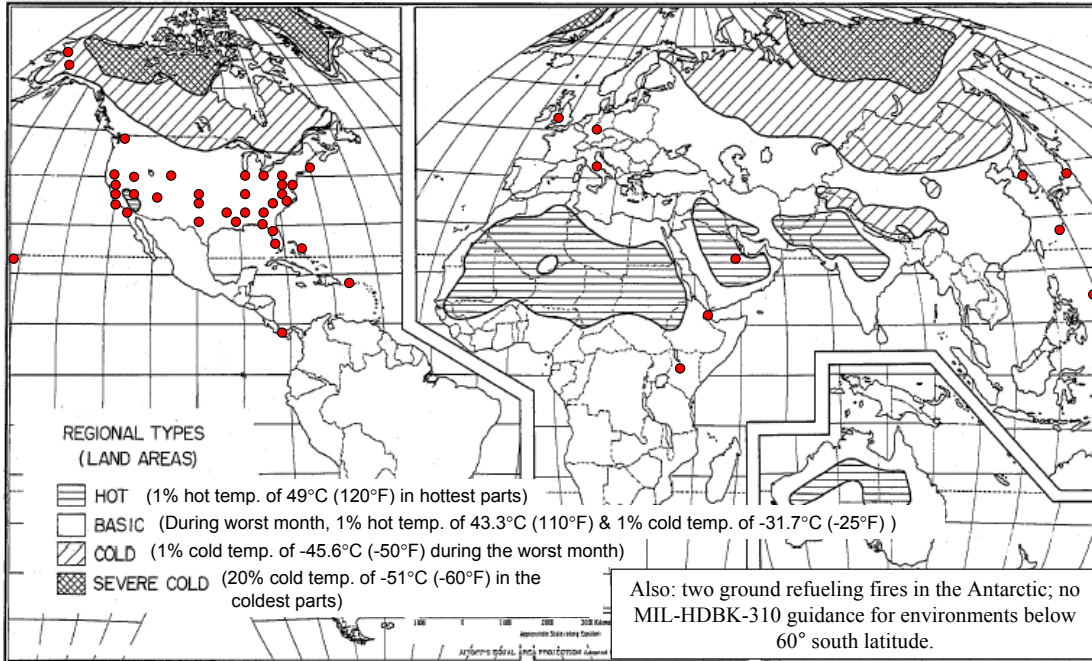

Figure 1. Location of Climatic Regional Types for the Land Areas of the World (Section 5.2)

Figure 14. Distribution of DoD Rotary Aircraft Ground Fire Locations

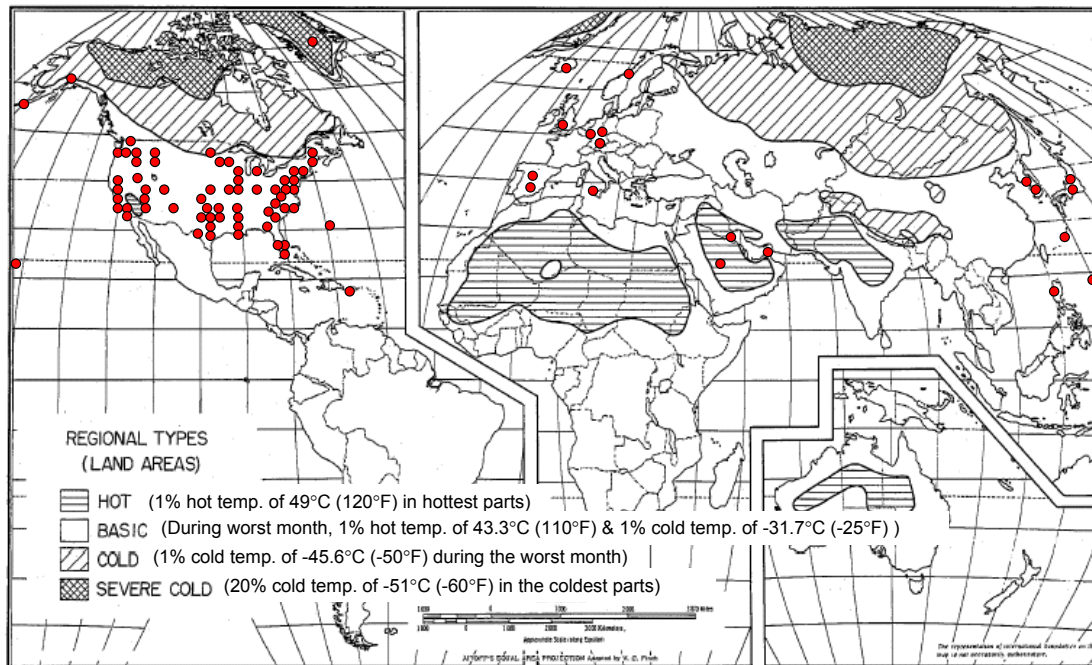
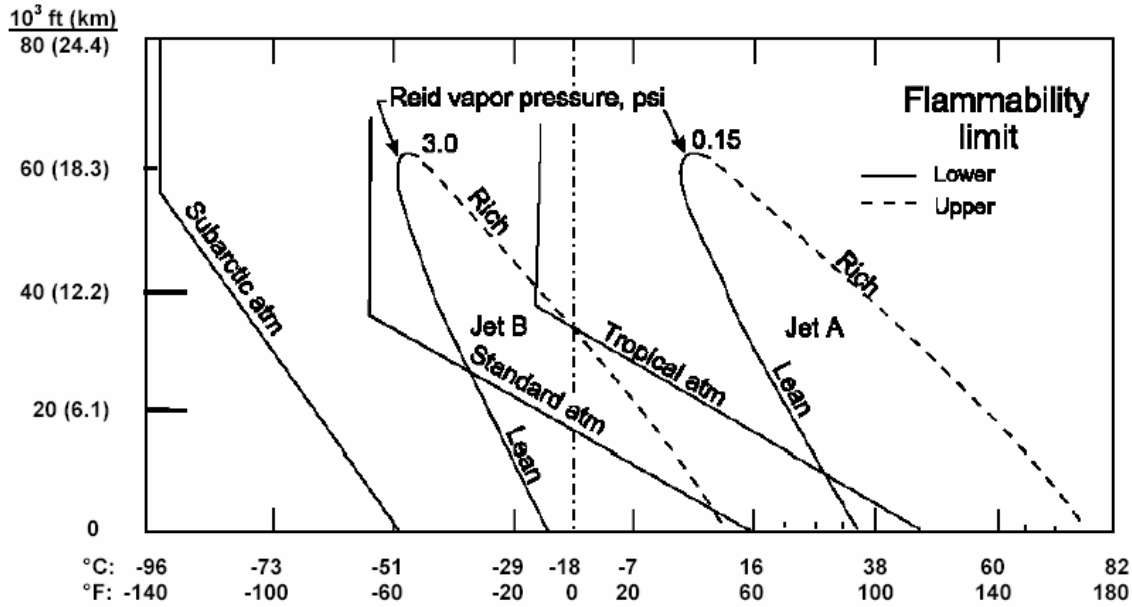

Figure 1. Location of Climatic Regional Types for the Land Areas of the World (Section 5.2)

Figure 15. Distribution of DoD Fixed-Wing Aircraft Ground Fire Locations

Figure 16 shows flammability profiles for Jet A and Jet B aviation fuels. It had been postulated previously [19] that if the temperature profiles shown in Figure 16(a) are encountered in flight, the formation of flammable equilibrium vapor-air is limited to a tropical atmosphere for Jet A, whose flammability properties are similar to JP-8, and the standard atmosphere for Jet B, whose flammability properties are similar to JP-4. JP-8 fuel is now used predominantly by the USAF whereas USN aviation predominantly uses JP-5, which has a more conservative flash point. Figure 16(b) was derived previously by British Aerospace [20] and indicates increasing ignition energy with increasing altitude as well as when approaching the boundaries of the flammability limits.



(a) Atmospheric Profiles

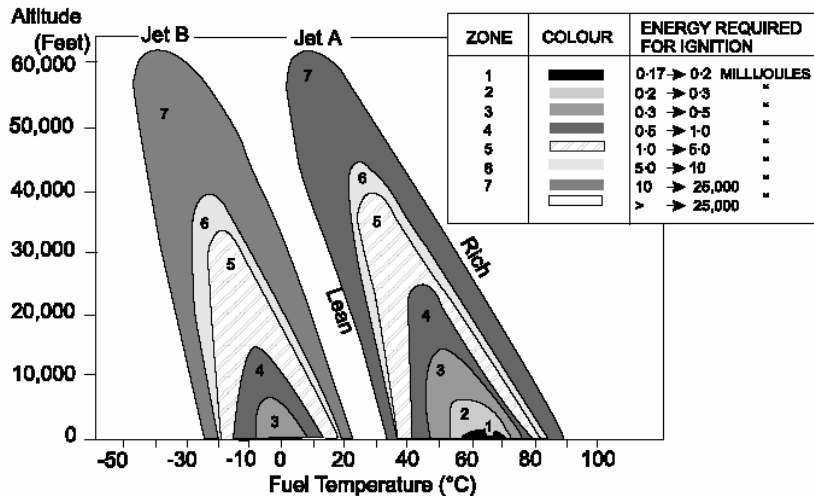

(b) Estimated Minimum Electrical Ignition Energies

Figure 16. Jet A and Jet B Flammability Profiles, Fuel Temperature versus Altitude

Figures 16(a) and (b) served as a basis to plot the DoD fire mishap and incident data for which both altitude and OAT were provided in the data. Figure 17 shows the data plotted versus the Reference [15] world-wide air environments, the air environments published in the Joint Aviation Regulation [21], and a previously published subarctic profile [22]. In Figure 18 the data is plotted versus the flammability profiles derived from Reference [22]; the blue line is the standard atmosphere profile and the orange line is the tropical atmosphere profile. Figures 19 and 20 plot the *nearest-to* geographic locations of *in-flight* fire events versus the Reference [15] land environments for rotary aircraft and fixed-wing aircraft, respectively.

Qualitatively, the plots of the DoD fire mishap and incident data in the Figures 17 through 20 indicate:

- As altitude increases, the number of fire events decreases
- As altitude increases, occurrence of events trends above the standard atmosphere profile
- Rotorcraft fire events occurred below 4,000 meters (13,123 feet)
- The overwhelming majority of fixed-wing aircraft fire events occurred below 6,000 meters (19,685 feet)
- Similar to publicly-available data, the vast majority of fixed-wing aircraft fire events occurred with OAT above -20°C (-4°F)
- In-flight rotary and fixed-wing aircraft fire events occurred predominantly near geographic locations associated with the Reference [15] *basic* land environments.

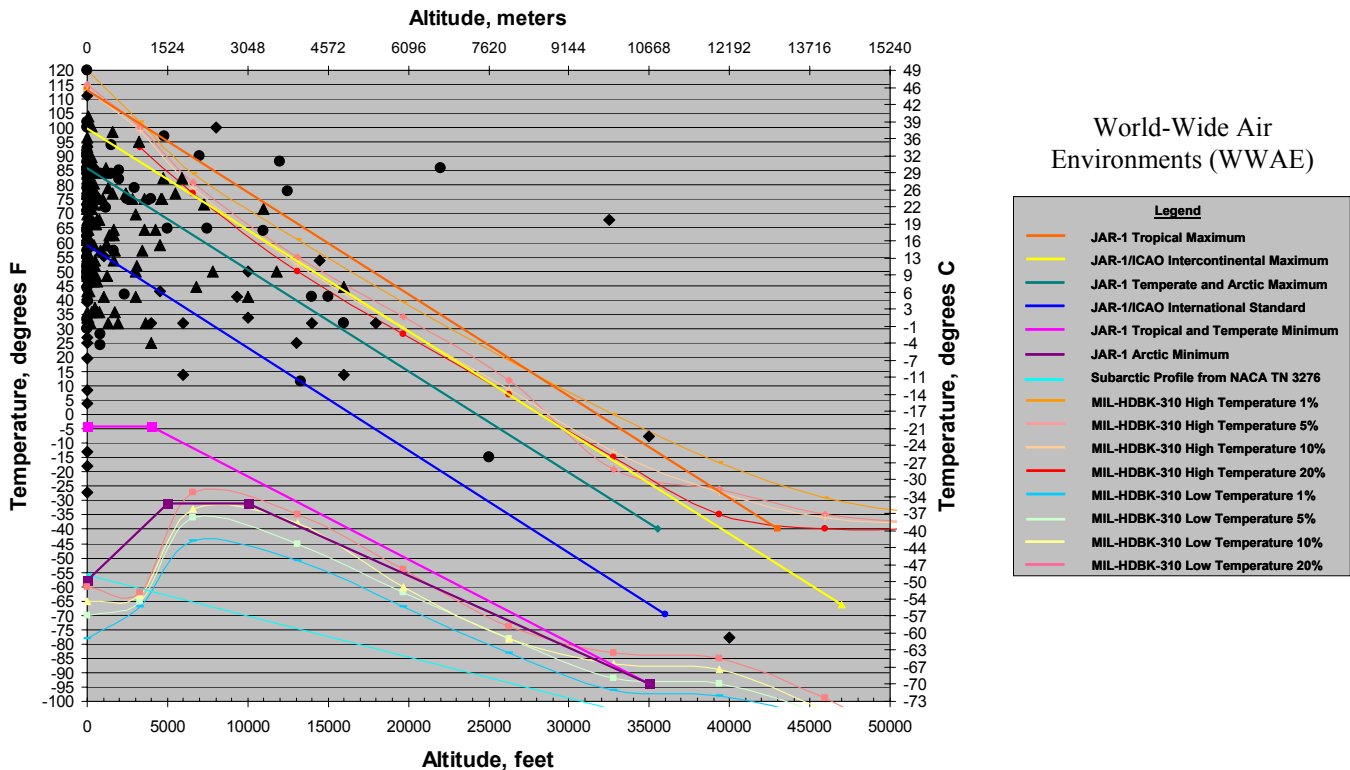

Figure 17. Plot of Standard Climate Profiles and WWAEs versus All DoD Aircraft Fire Events and Suppressant Releases where Both Altitude and OAT Were Provided

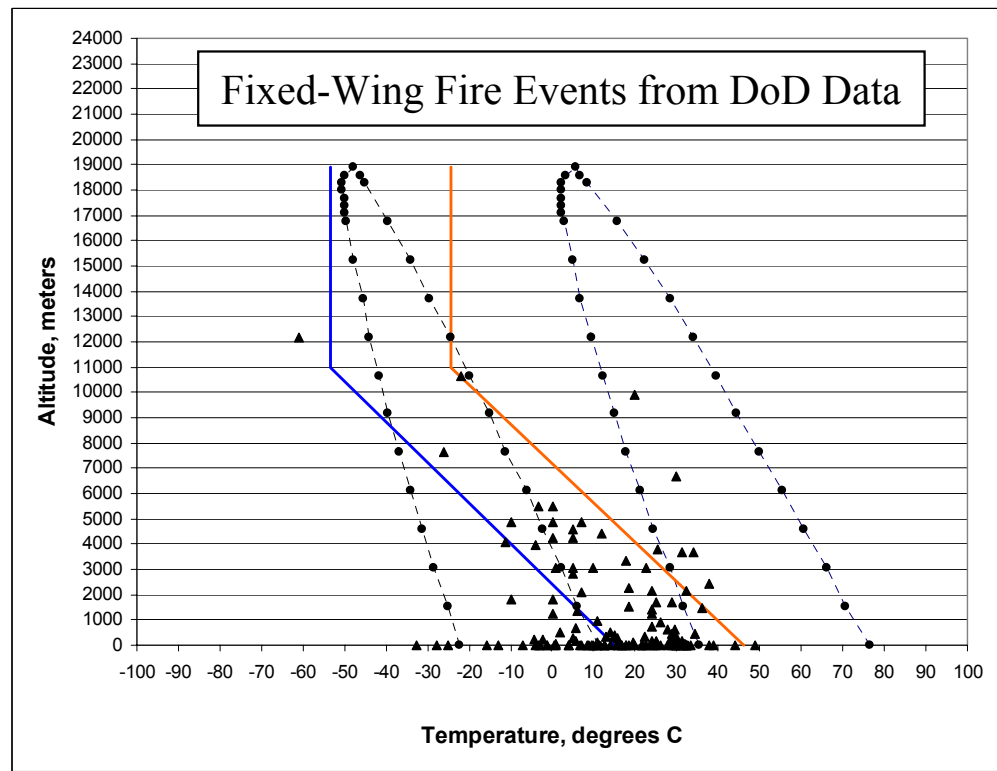
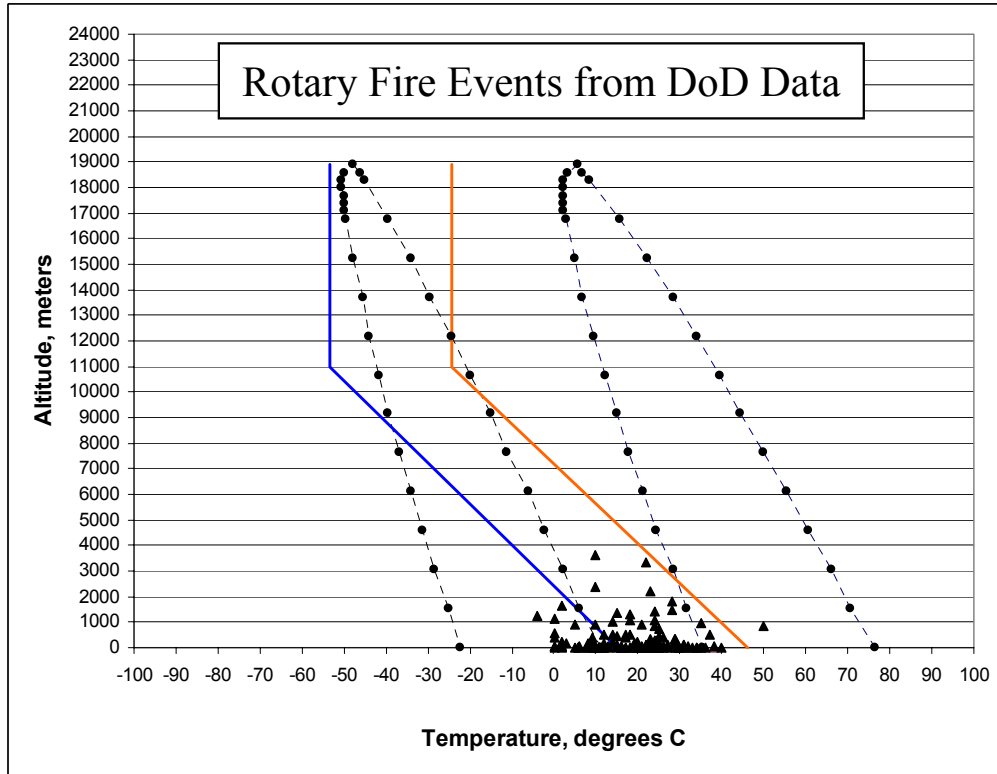

Figure 18 DoD Aircraft Fire Events vs. Flammability Profiles

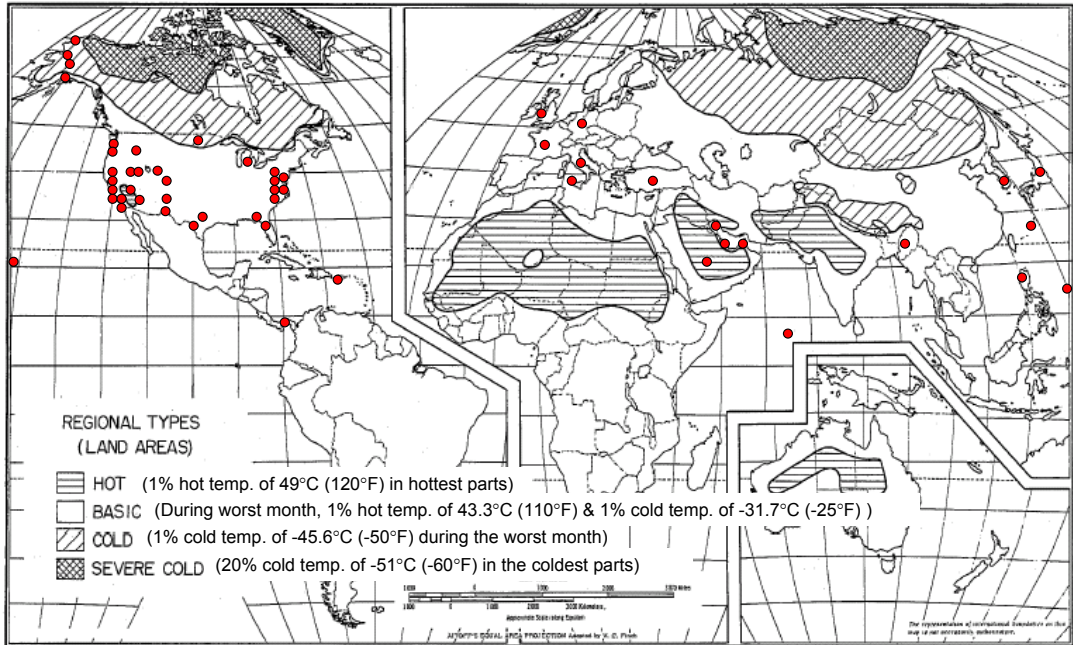

Figure 1. Location of Climatic Regional Types for the Land Areas of the World (Section 5-2)

Figure 19. Distribution of DoD In-Flight Rotary Aircraft Fire Locations (Nearest-to Locations)

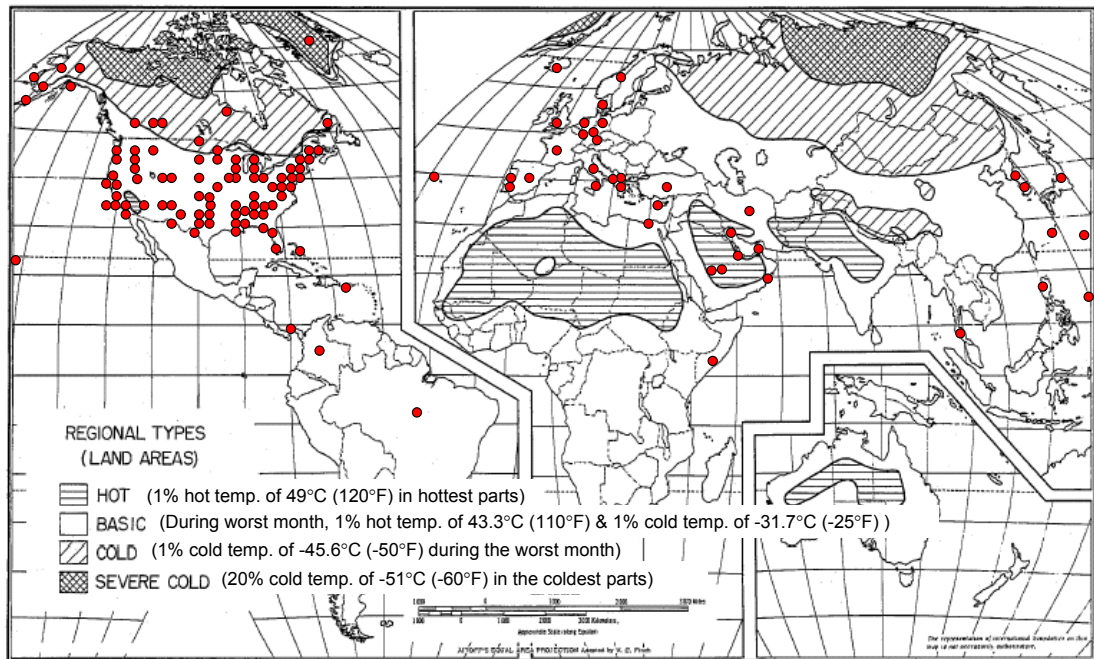

Figure 1. Location of Climatic Regional Types for the Land Areas of the World (Section 5.2)

Figure 20. Distribution of DoD In-Flight Fixed-Wing Aircraft Fire Locations (Nearest-to Locations)

NACELLE AIR TEMPERATURE

Having reviewed extensively DoD mishap and incident fire data, the NGP sought to characterize in-flight temperature conditions within an engine nacelle by developing an in-flight nacelle air temperature model, which is described in Reference [14]. The model was applied to 1,025 cases, bounded by altitude to 9.8 kilometers (30,000 feet). In 88% of the cases the model indicated nacelle air temperatures greater than -17.8°C (0°F). Closer review of the remaining 12% of the cases (those less than -17.8°C) were noted for input conditions at 6.6 kilometers (20,000 feet) or greater, and 89% of these cases (89% of the 12%) were noted for at airspeeds of 50 knots. These cases were deemed not credible as 1) typical military rotorcraft have operational ceilings less than 6.6 kilometers (20,000 feet), and 2) for typical military fixed-wing aircraft that have nacelle fire suppression capability (e.g., fighter/attack aircraft, cargo transports, patrol aircraft) a 50-knot airspeed would be typically *below* stall speed for these aircraft. The remaining 11% (i.e., 11% of the 12%) were noted for input conditions at 9.8 kilometers (30,000 feet) and 400 knots and indicated nacelle air temperatures ranging between -23.3°C (-10°F) and -24.4°C (-12°F), which equated to 1.5% of all cases modeled.

It was obvious that if the non-credible cases were removed from consideration the actual percentage of total cases indicating nacelle air temperatures greater than -17.8°C (0°F) would be greater than 88%. Thus it was assessed that modeling additional cases up to the ceiling of the Standard Atmosphere Model for the tropopause of 11.9 kilometers (36,152 feet) would result in additional nacelle air temperatures less than -17.8°C (0°F) but was likely to not dramatically impact the percentages described. As indicated in Table 3 the model tended to predict (conservatively) lower temperature ranges as compared to measured temperature ranges.

OAT CONDITION AT SUPPRESSANT RELEASE

Figure 21 presents the mass of nacelle/APU compartment fire suppressant discharged for DoD aircraft over the period covered by the NGP review of DoD fire mishap and incident data (1980-2002). Figure 22 presents a summary of the NGP findings to characterize in-flight nacelle fire suppressant OAT conditions. The figures comprise data for which altitude and OAT were included, plus data for which altitude was provided and OAT estimated using the standard atmosphere model, plus data for which both altitude and OAT were not provided but were estimated – altitude was estimated based on aircraft maneuver then was OAT estimated using the standard atmosphere model. From Figure 21 it is easily seen that a substantial amount of fire suppressant was discharged while aircraft were on the ground. During the 1980-2002 period the average amount of fire suppressant discharged from engine nacelle and APU compartment fire suppression systems at 10 kilometers (33,000 feet) and higher, the ozone layer, was determined to be 3.6 kg (8.0 lbs) per year, which compares favorably to 4.6 kg (10.1 lbs) determined in a previous study [25]. That study also incorporated discharges from on-board portable fire extinguishers as well as extrapolated discharges from USN aircraft, for which only three years of data were reviewed, to align with the time period of the data evaluated for U.S. Army and USAF discharges. As presented earlier in Figure 18 for occurrence of fire events, Figure 22 presents that the OAT condition at suppressant release has historically differed between rotorcraft and fixed-wing aircraft. Figures 23 and 24 are presented to examine this further.

Rotary Aircraft

In Figure 23 DoD the rotary aircraft fire data are plotted as in Figure 18 versus the standard atmosphere (blue line) and tropical atmosphere profiles (orange line) and the Jet A (right) and Jet B (left) flammability limit profiles. Also indicated is the typical rotorcraft operational ceiling, and the majority (97%) suppressant release envelope derived from Figure 22. Also shown for reference purposes is an artifact from previous fire testing to determine the flame spectral characteristics for optical fire detection at altitude: that testing at pressure conditions representative of altitude of 11.5 kilometers (35,000 feet) resulted in inability to maintain sustained combustion [23]. The preponderance of fire events and suppressant releases on rotorcraft is shown to occur well below the typical operational ceiling for rotorcraft. Figure 23 indicates clearly trade space above the -40°C (-40°F) NGP boiling point criterion, with 97% of all rotorcraft suppressant releases occurring above -12.2°C (10°F).

Table 3. Comparison of Modeled (Predicted) versus Measured Nacelle Air Temperature Ranges

Pressure Altitude (feet)	OAT (°F)	Engine Surface Temperature Range (°F)	Measured Nacelle Air Temperature Range (°F)	Predicted Nacelle Air Temperature Range (°F)
Sea level	83.8	Not indicated.	92.4 to 180.6	Not modeled since engine surface temperature range not indicated.
17,000+	-6.3	Not indicated.	-1.3 to 87.2	
1,400	82.5	214.7 to 737.6	92 to 180	73.25 to 91.13
2,000	Not indicated.	350 to <500	≈200 to 325	69.34 to 238.19
2,000 to 45,000	Not indicated.	Not indicated.	≈225 at 2,000 feet to ≈50 at 45,000 feet	Not modeled since engine surface temperature range not indicated.
9,887	27.2	166 to 1089.6	72.4 to 200.2	26.65 to 82.48
Sea level	27.41	140.4 to 873	66.6 to 131.4	61.04 to 102.09
10,046	34.5	177.5 to 1088.3	80.3 to 200.9	26.25 to 81.94
10,000	Not indicated.	Up to 500	50 to 200	41.96 to 53.4
11,000	Not indicated	Up to 1,380	<230 to <525	44.31 to 72.82
Sea Level	Not indicated.	Not indicated.	410 ¹	Not modeled since engine surface temperature range not indicated.

¹ Though the engine surface temperature data was not available for use in during modeling, this temperature data point from Reference [24] is listed as it was the highest nacelle airflow temperature found in the literature during the nacelle air temperature modeling effort.

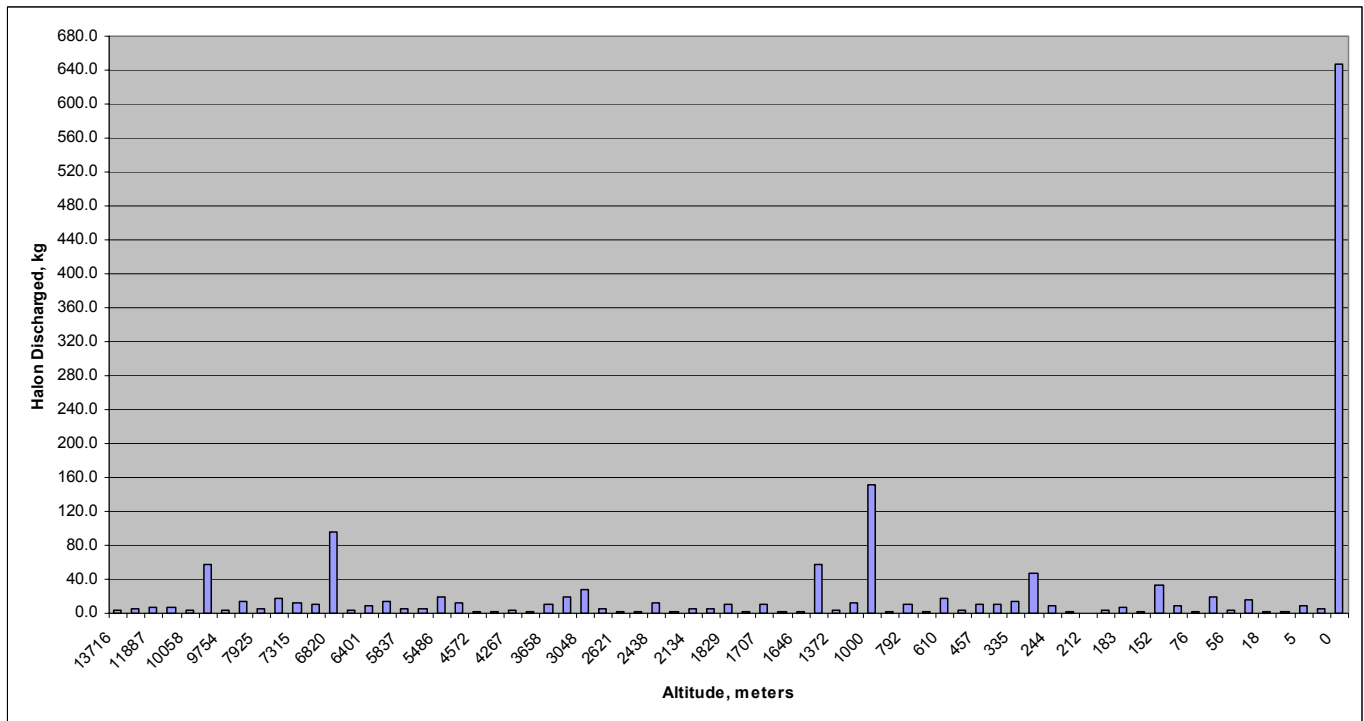

Figure 21. In-Flight Suppressant Deployment vs. Altitude, DoD Data, 1980-2002

Fixed-Wing Aircraft

Figure 24 plots the fixed-wing aircraft in similar fashion and requires a more careful examination. The overwhelming majority of fire events from the data is indicated below 7,000 kilometers (23,000 feet), with 94% of all suppressant releases occurring at an altitude just above 9,000 kilometers (29,500 feet). Qualitatively, this latter altitude as a ceiling correlates well with the results of the conclusions drawn from previously described nacelle air temperature modeling and the previously referenced testing that indicated inability to maintain sustained combustion above 11.5 kilometers (35,000 feet) [23]. Additionally, the overwhelming majority of credible nacelle air temperature modeling cases occurred for OAT conditions at or above -25°C (-13°F), which also correlates well with that very few fire events are indicated below this OAT as well as with the distribution of fire events depicted previously in Figures 19 and 20. In the Basic land environment depicted in those figures, the worst cold temperature exposure is 1% at -31.7°C (-25°F), which also correlates well with the temperature boundary for 94% all suppressant releases in Figure 24.

Figures 23 and 24 represent that DoD rotary and fixed-wing aircraft operational environmental conditions (altitude, temperature) will differ, with fixed-wing aircraft having some greater exposure to colder ground and altitude environments.

Rotary

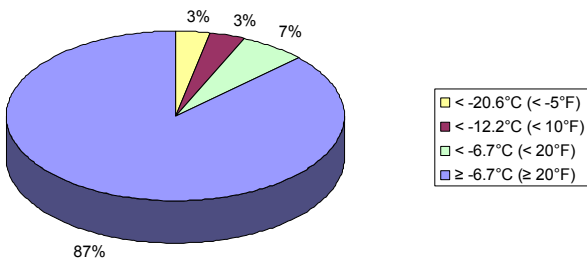
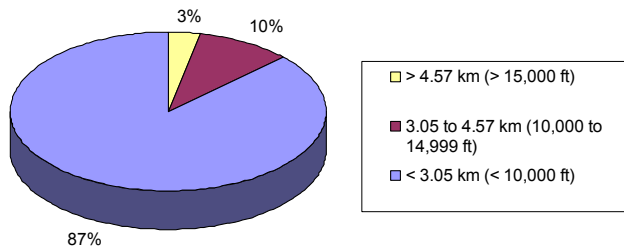

Fixed Wing

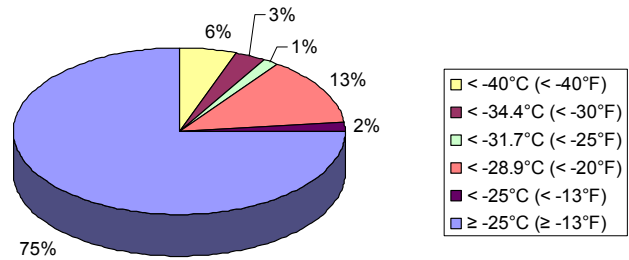
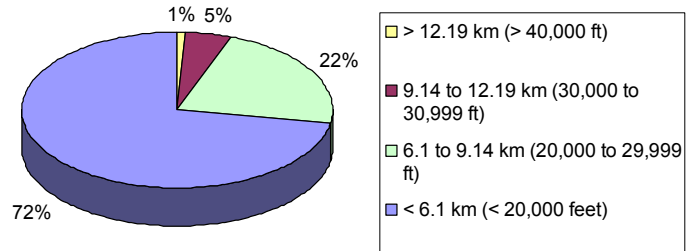

Figure 22. Summary of OAT and Altitude Conditions at Nacelle Fire Suppressant Release

Fire Events and Suppressant Release Under Cold Soak Conditions

Figure 25 summarizes fixed-wing fire incidents by phase of operation. When considering the safety risk of a catastrophic end event, the likelihood is driven primarily by whether fire occurs, and this likelihood is *reduced* by the likelihood of operating in a climatic extreme, e.g., temperature conditions that would effect aircraft cold-soaking. The takeoff-related categories are indicated to total 18.7% of all incidents in Figure 25. When reviewed for the number of suppressant releases during takeoff, approximately 16% of suppressant releases occurred during the takeoff phases. However, when these releases were reviewed further, only 4% of the takeoff-related suppressant releases (and thus less than 1% of all suppressant releases) were indicated to have occurred in land environments categorized as cold or severe cold per Reference [15]. This suggests strongly that safety risk is low (an *improbable* hazard frequency) for an engine nacelle fire during takeoff for a cold-soaked aircraft *and* in which the fire suppression system fails to extinguish the fire *and* a catastrophic event occurs. It can be seen in the distribution of fixed-wing fire events in Figure 24 that the majority of events are indicated above -10°C (14°F). For rotary aircraft fire events and suppressant releases, Figure 23 suggests strongly that cold-soak conditions alone are a low likelihood.

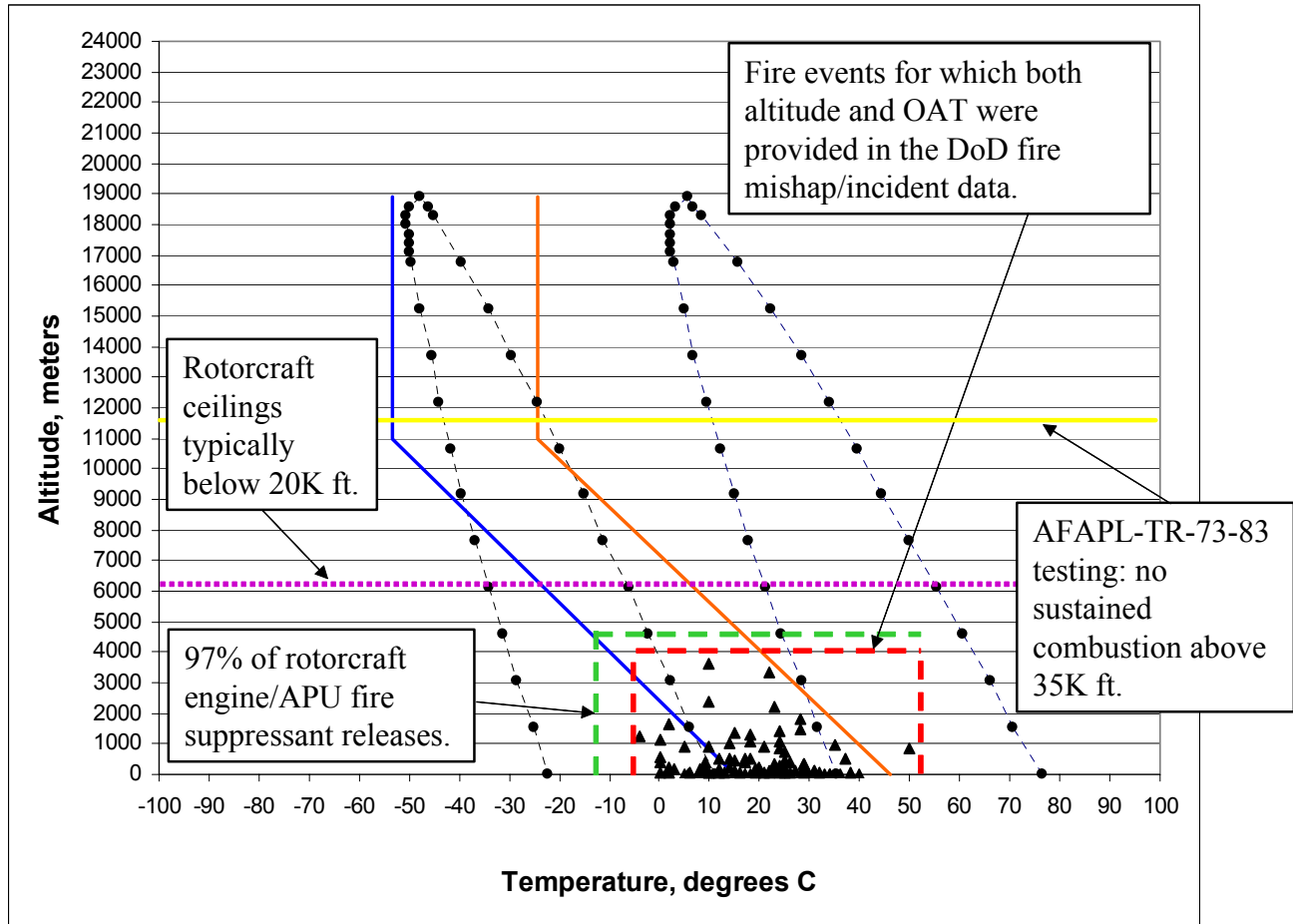

Figure 23. DoD Rotary Aircraft Fire Data versus Atmospheric Profiles, Flammability Limit Profiles, Operational Ceiling, and Suppressant Release

PILOT RESPONSE VERSUS EFFECTIVITY VERSUS OVER-DESIGN

Figure 26 illustrates results of NGP review described in Reference [14] of USN fire mishap and incident data to categorize pilot response time in effecting suppressant discharge and provides a comparison to previous work that describes effectivity of nacelle fire suppression systems on USN aircraft [3,4]. Response time was categorized qualitatively as normal, slow and long. The need for a design optimization capability cannot be overstated when considering that even with halon 1301 as the fire suppressant and normal pilot reaction to effect agent discharge, overall effectivity of halon 1301 nacelle fire suppression systems was still less than 80%. It is this dichotomy that challenges an overarching assertion that halon 1301 nacelle fire suppression systems are over-designed. Traditional design practice usually entails using design guidance (i.e., equations) to estimate suppressant mass quantity needed, conducting analysis of nacelle airflow characteristics for the purposes of designing the suppressant distribution system and discharge location or locations within the nacelle, and then performing qualification tests. If found necessary during those tests, discharge locations and/or nozzles may be adjusted in order

to pass qualification; i.e., try different nozzles on the ends of the distribution tubing or changing the orientation of the discharge locations. (This traditional practice has also been applied in the design and qualification of the MV/CV-22 HFC-125 nacelle fire suppression system and the HFC-125 nacelle/APU fire suppression system on AH-1Z and UH-1Y aircraft. In the development of the F/A-18E/F and F-22 HFC-125 nacelle fire suppression systems, fire test programs were conducted to support system sizing and distribution design.) This can result in non-optimized suppressant distribution, which is illustrated in Figure 2-27. Whether the suppressant concentration provided above the qualification concentration is truly a margin of safety will be determined subsequently through operational experience. It can be that what appears to be margin is either over-design or in fact inadequate design because of peculiarities of the nacelle compartment (e.g., reverse airflows or prop rotor-induced back pressure). Whether a system is inadequate, over-designed or not optimized is more appropriately assessed on an aircraft-by-aircraft basis.

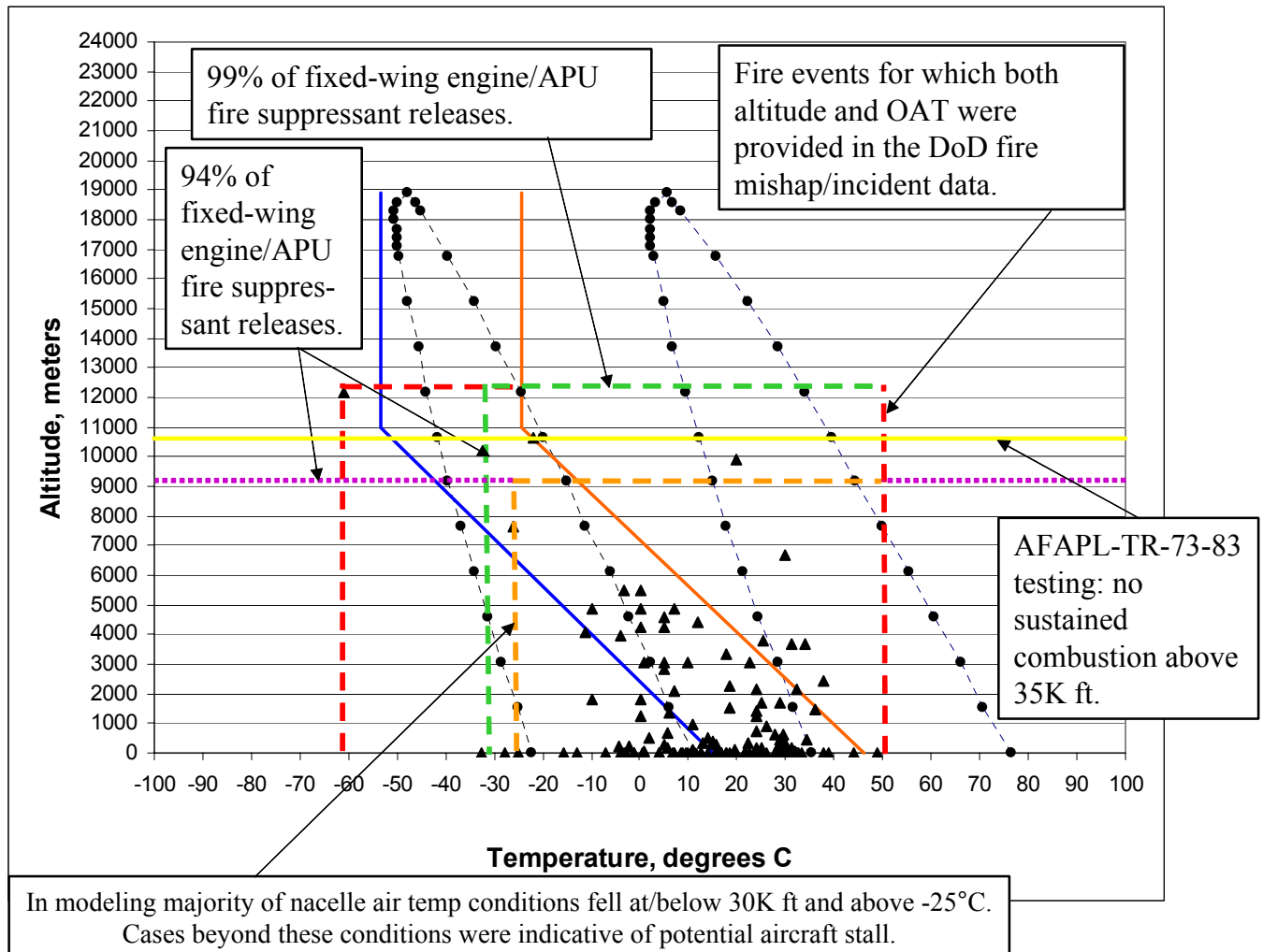

Figure 24. DoD Fixed-Wing Aircraft Fire Data versus Atmospheric Profiles, Flammability Limit Profiles, Potential Stall Condition and Suppressant Release

- Agent release during takeoff: ≈16% of all releases
- Agent release during takeoff in cold or severe-cold environments: ≈4% of all releases during takeoff
- *Data suggests that risk of un-suppressed fire during takeoff in cold or severe-cold environments is an Improbable likelihood (Low Risk)*

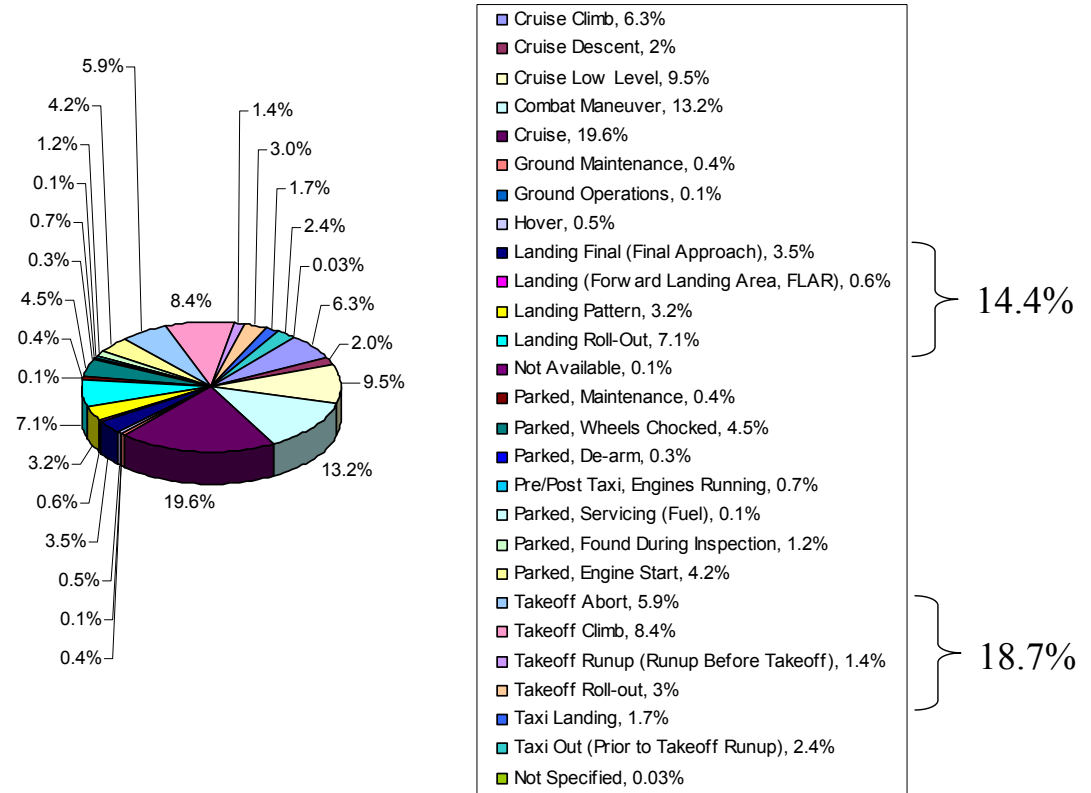

Figure 25. Fixed-Wing Fire Incidents and Mishaps

SURVIVABILITY PERSPECTIVE

Distinguishing DoD aircraft from commercial transport aircraft are survivability requirements to mitigate effects of enemy fire, which includes ballistically-induced fires. Generally, the areas vulnerable to these fire threats are dry bay compartments and the fuel tank ullage, the vapor space above the fuel within a fuel tank. Imperial Japanese Navy design policies during the later part of World War II not only required carbon dioxide (CO₂) for nacelle fire suppression but also for protection of fuel cells and alcohol tanks on aircraft, and structural spaces surrounding fuel cells were to be air tight, structural and weight limitations permitting. (The requirement for CO₂ discharge was to be within one second, similar to the HRD systems developed by the CAA over a decade later.) The CO₂ systems protecting fuel cells were to be automatic, and because of combat experience in which hits on aircraft with alcohol tanks resulted in fires, an automatic CO₂ system was to be implemented for the spaces surrounding the alcohol tank, i.e., a reactive dry bay fire protection system, and a pilot-activated system was to be implemented for discharge into the tank itself. There is evidence that a concept for implementing active dry bay fire protection was being pursued by the Imperial Japanese Navy at the later stage of World War II, which is shown in Figure 28 and was planned to be an automatic system utilizing CO₂ as the fire suppression agent [26].

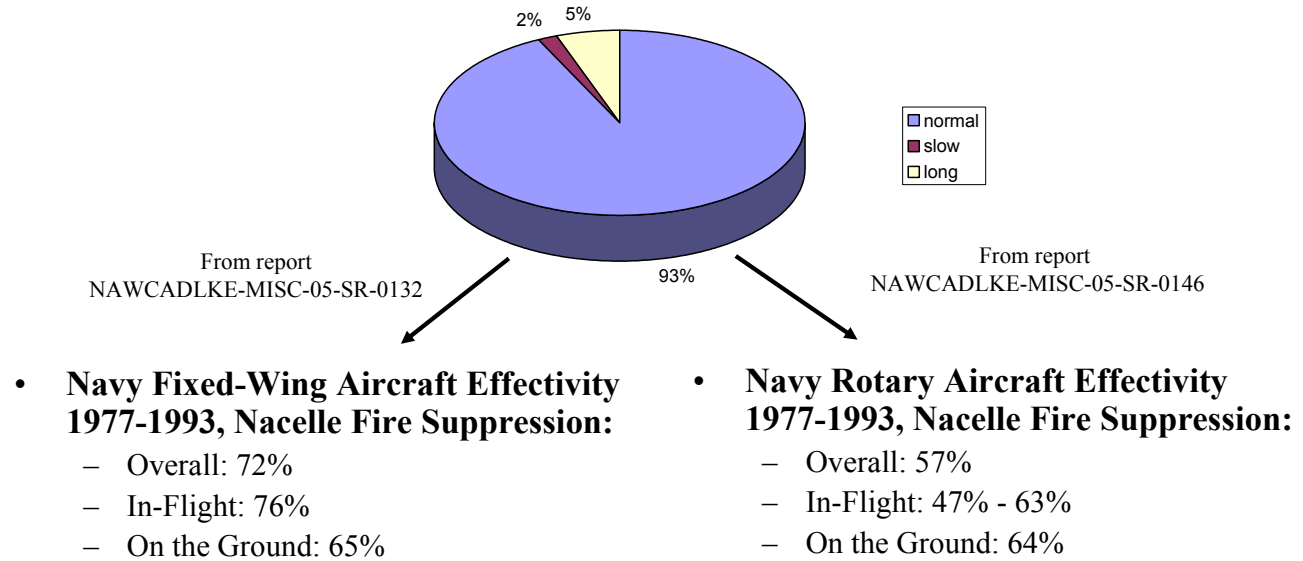

Figure 26. Pilot Response vs. Nacelle Fire Suppression Effectivity

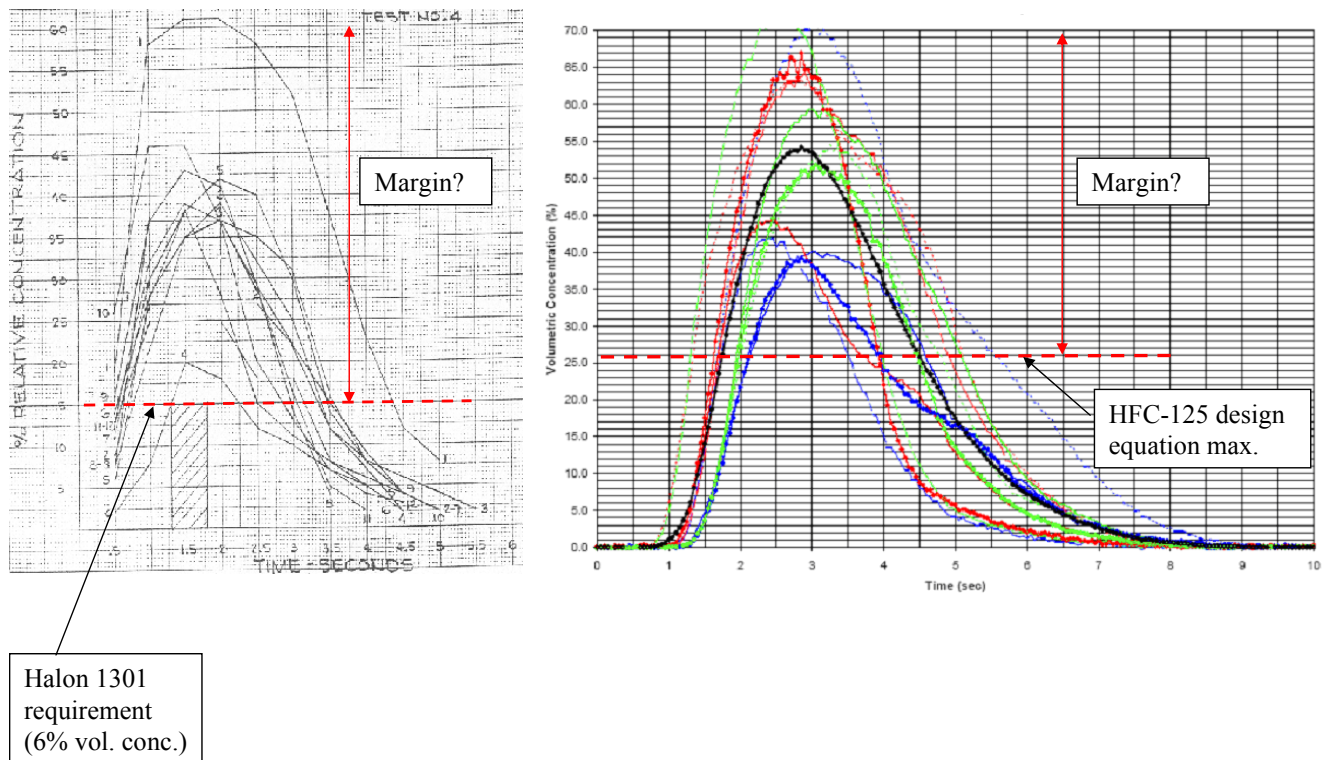

Figure 27. Example Nacelle Fire Suppression Systems Certification Concentrations

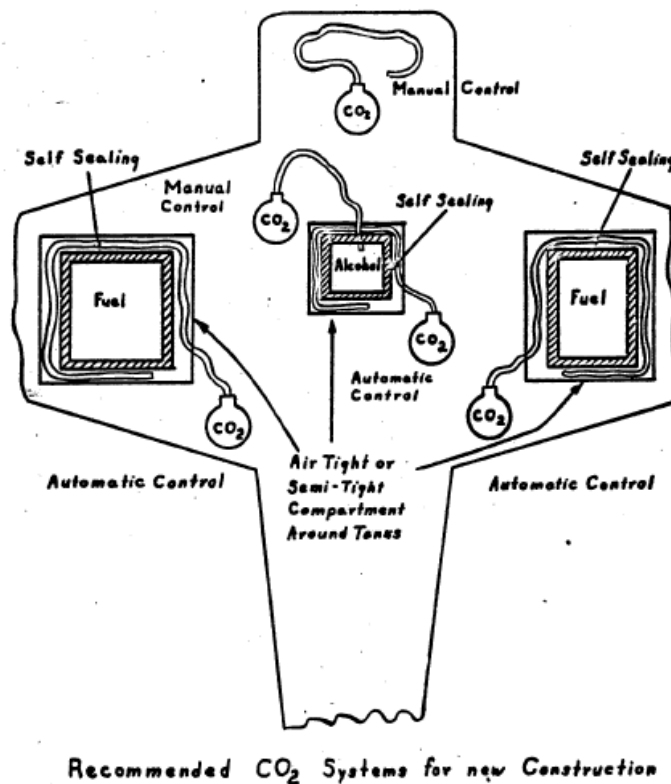

Figure 28. Dry Bay Compartments - WWII Concept

During the Vietnam War the United States suffered combat losses totaling 5,000 aircraft – 2,500 fixed-wing jets and 2,500 helicopters. As losses mounted during the course of the conflict, studies were initiated to see what might be done to lower loss rates, an effort that continued after the war. The analysis revealed that fuel fires and explosions accounted for 50% of the losses and that half of these were attributable to fuel explosions in dry bay compartments [27]. Methods for providing dry bay fire protection on U.S. DoD aircraft were implemented, which consisted primarily of passive techniques as illustrated in Figure 29 [28]. Halon 1301 was given credit for providing active dry bay in a few applications, but closer review shows that halon 1301 dry bay fire protection systems have not really been fielded on DoD aircraft (i.e., certified by Congressionally-mandated live fire testing). In Figure 29 an APU compartment is categorized as a dry bay because of its location aft of a fuel cell compartment, but the design and certification of APU compartment fire suppression is similar to that for engine nacelle compartments. Similarly an accessory compartment, or what may be considered a quasi dry bay, was given credit for having halon 1301 dry bay fire protection. However, even the fire suppression system for this type of compartment would have been certified in a manner similar to that for engine nacelles. It should be noted that space and electrical wiring provisions are installed on delivered F-22 aircraft in the event it is decided in the future to install dry bay fire suppression system components. Though the system was designed for use of halon 1301, no F-22 aircraft are fielded at this time with halon 1301, i.e., no dry bay fire suppression system components are installed.

Figure 30 shows the halon 1301 dry bay fire suppression system installed on United Kingdom CH-47 Chinook helicopters. Like halon systems designed to protect engine nacelles, the fire bottles used for dry bay fire suppression on the CH-47D helicopters, though much smaller, also utilize a pyrotechnic device to rupture a burst disk on the bottle to effect suppressant release, but the bottles are automatically activated upon receipt of a signal from a pressure transducer, and an initiator on the bottle effects discharge [29].

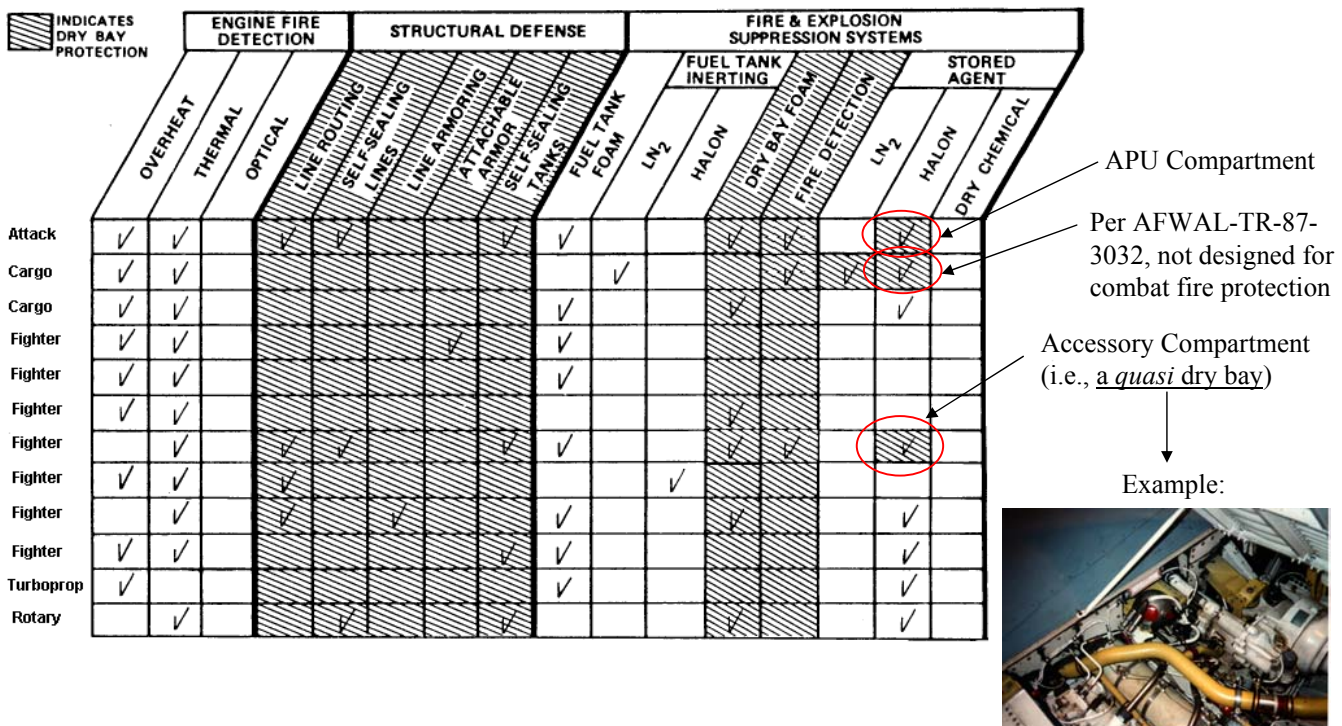

Figure 29. Vulnerability Reduction, DoD Aircraft Dry Bay Compartments (and Ullage)

Though aircraft vulnerable areas have decreased over the years, as depicted notionally in Figure 31, fuel systems and fuel containment systems today remain a significant vulnerability issue and drive the need for vulnerability-reduction measures such as fire suppression for aircraft dry bay compartments, both active and passive. Figure 31 is based on live fire testing (LFT) vulnerability assessments for armor-piercing incendiary (API) threats. Figure 32 shows examples of non-halon active and passive fire suppression techniques that have been implemented on DoD aircraft. In Figure 32 the photograph to the left is a dry bay compartment adjacent to a fuel tank that is protected by an optical fire detector and an inert gas generator, an active system in which detection is required to occur within $5\mu s$ and discharge of the inert gas occurs within 100ms. These halon alternative systems have been installed on MV/CV-22 and F/A-18E/F aircraft. The photograph to the right is a wing leading edge dry bay protected by aluminum-oxide powder panels, a passive system in which the powder is released when the ballistic projectile pierces the panel. In contrast, the system shown in Figure 30 utilizes piezoelectric sensors to sense a pressure rise associated with a ballistic projectile entering a fuel tank, which in turn commands discharge of the halon fire suppressant bottles into the adjacent dry

bay(s), all in less than 50ms. The DoD also has fielded a manually-activated nitrogen fire suppression system on C-5 aircraft, which is an extension of the C-5's fuel tank liquid nitrogen (LN2) inerting system and provides dry bay fire protection, though not against combat threats per Reference [28]. The system is required to reduce the oxygen level within the compartment into which it is discharged, ullage or dry bay, to 10% or less "in the time duration necessary to cope with the particular fire hazard."

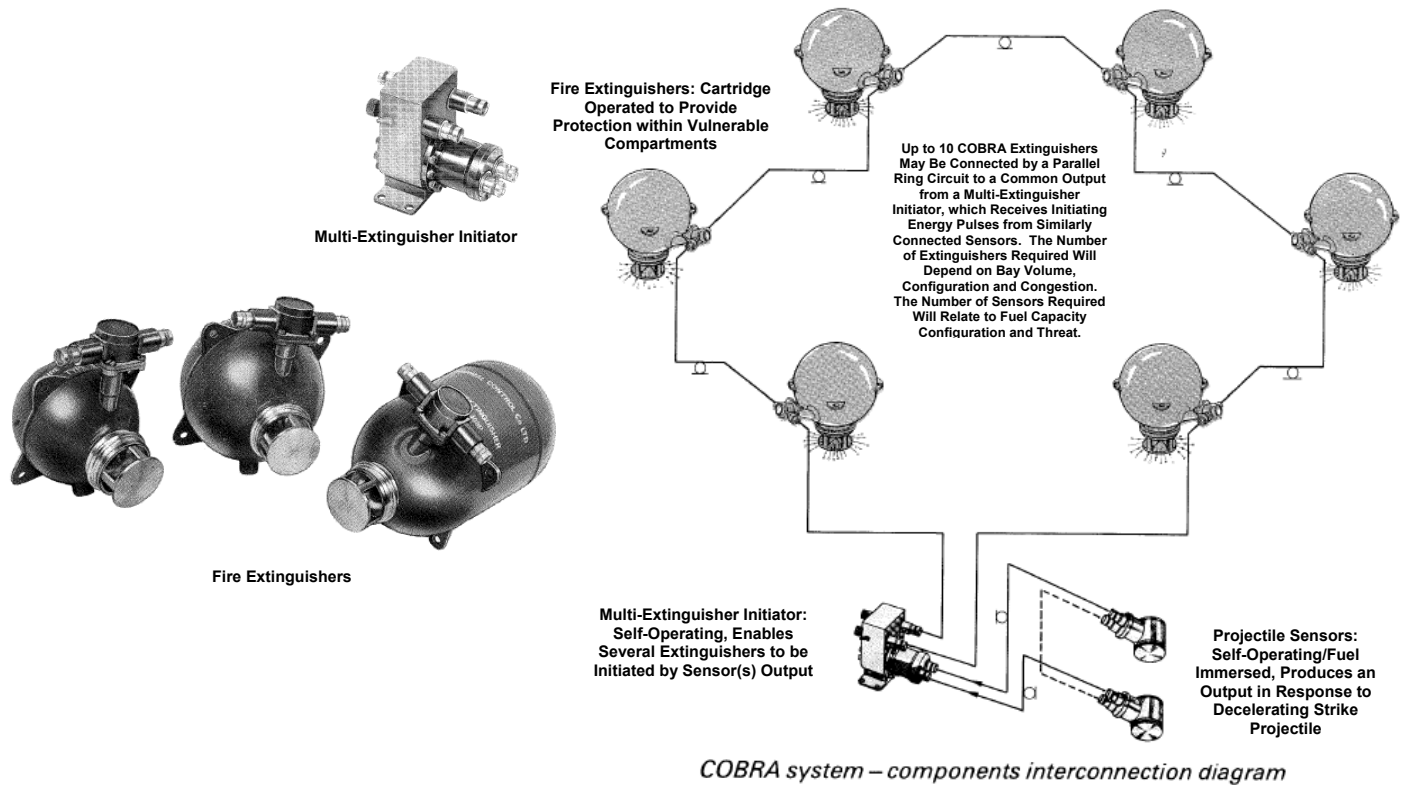

Figure 30. Non-DoD Aircraft Halon 1301 Dry Bay Fire Protection System [30, 31] (Reprinted with permission by Airscrew Limited, U.K.)

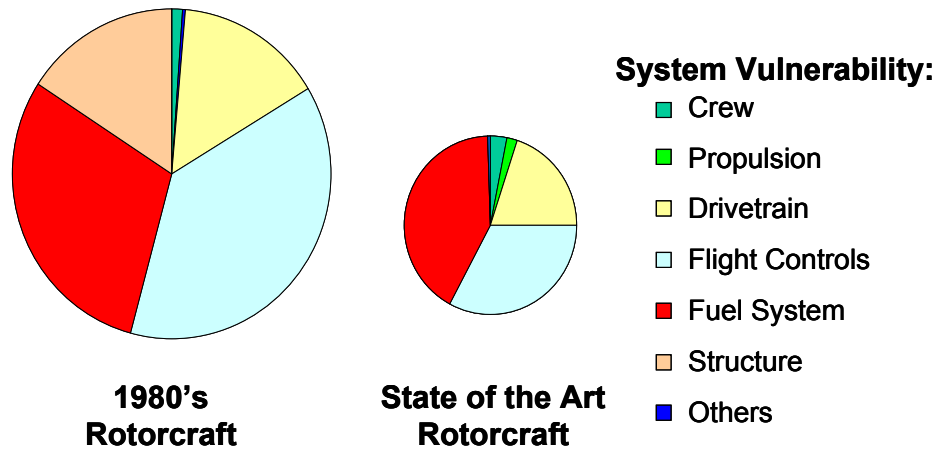
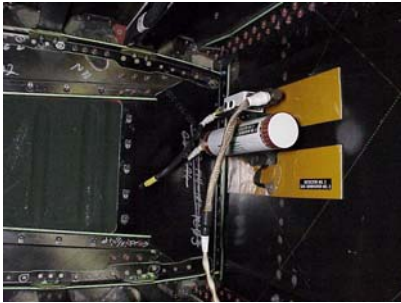

Figure 31. Notional Reduction in Aircraft Vulnerable Area

Active



Optical Fire Detection + Solid Propellant Inert Gas Generators

Passive



Aluminum Oxide Powder Panels

Figure 32. Examples of Dry Bay Fire Suppression on DoD Aircraft Today

Even though fuel tanks (or cells) are a significant contributor to an aircraft's ballistic vulnerable area, a component failure within the tank can also provide an ignition source for the fuel-air mixture in the ullage. In either case, the time between initiation and the time at which combustion results in a catastrophic overpressure condition that exceeds the structural capability of the aircraft is brief, as illustrated in Figure 33. A summary of military safety-related fuel-tank explosions in the National Transportation Safety Board (NTSB) TWA-800 report [32] indicates all occurred with JP-4, and that none occurred on aircraft having some type of fuel tank ullage fire/explosion protection. Though the DoD primarily uses JP-8 (USAF) and JP-5 (USN), aircraft may still be required to use JP-4.

Examples of fielded or previously-fielded ullage fire/explosion protection systems are shown in Figure 34. These are categorized as passive, reactive, and active. Passive systems include explosion suppressant foam (ESF) and aluminum mesh, though the DoD has only fielded ESF. Previously fielded reactive systems include the scored canister system (SCS), which released pentane to create a fuel rich environment to preclude combustion, and cylindrical suppressors, which utilized halon 1011. Other reactive systems investigated by the DoD but never fielded for aircraft ullage fire/explosion protection were linear fire extinguishers (LFE), the Parker Reactive Explosion Suppression System (PRESS), and the nitrogen-inflated ballistic bladder (NIBB). Active systems have been fuel tank inerting systems and have been designed to provide protection either continuously or when commanded. Currently-fielded LN2 and onboard inert gas generation systems (OBIGGS) provide continuous protection, while halon 1301 inerting systems would be activated prior to entering a potential threat environment. Only three DoD aircraft have utilized halon 1301 to provide fuel tank inertion, the USAF F-16 and F-117 aircraft and the United States Navy (USN) A-6E, which is no longer in service. (Typically, the DoD will require that ullage inerting systems reduce oxygen concentrations to 9% or less.). The USN A-6E ullage inerting system was designed to maintain a halon 1301 volumetric concentration of 20% upon activation. Today the only DoD aircraft that utilizes halon 1301 for fuel tank inerting is the USAF F-16.

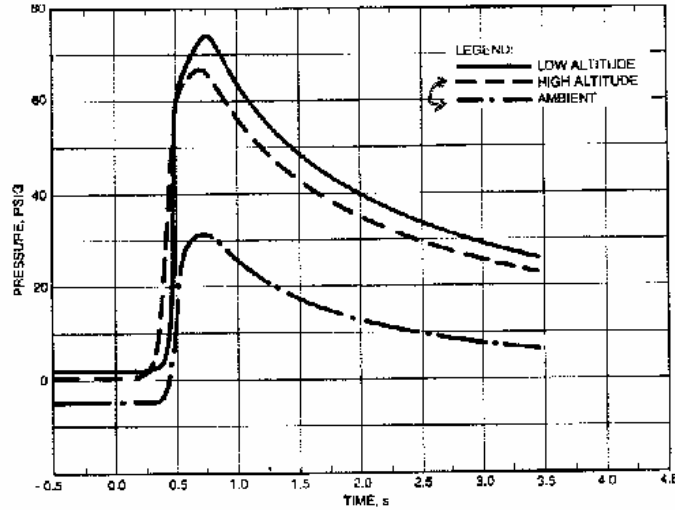
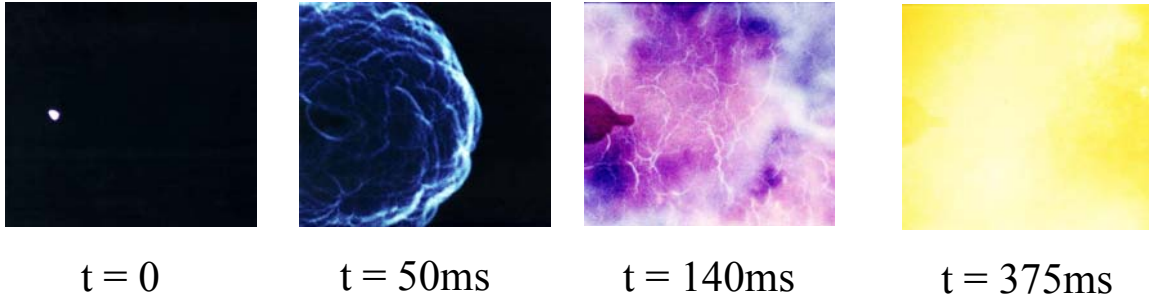
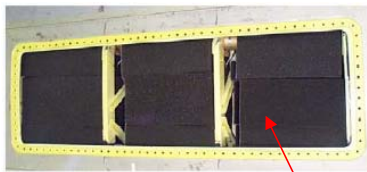
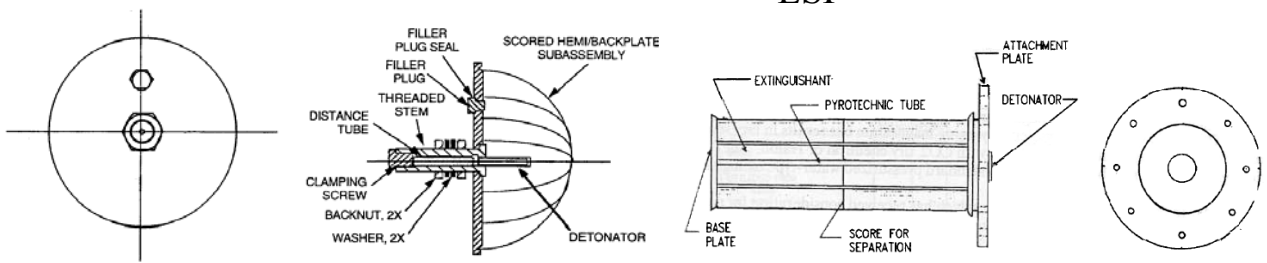

Figure 33. Spark-Initiated Combustion



ESF



Scored Cannister System, used Pentane
 (Used with permission by Kidde Aerospace)

Cylindrical Suppressor, used Halon 1011
 (Used with permission by Kidde Aerospace)

Figure 34. Examples of Fuel Tank Ullage Fire/Explosion Protection Techniques

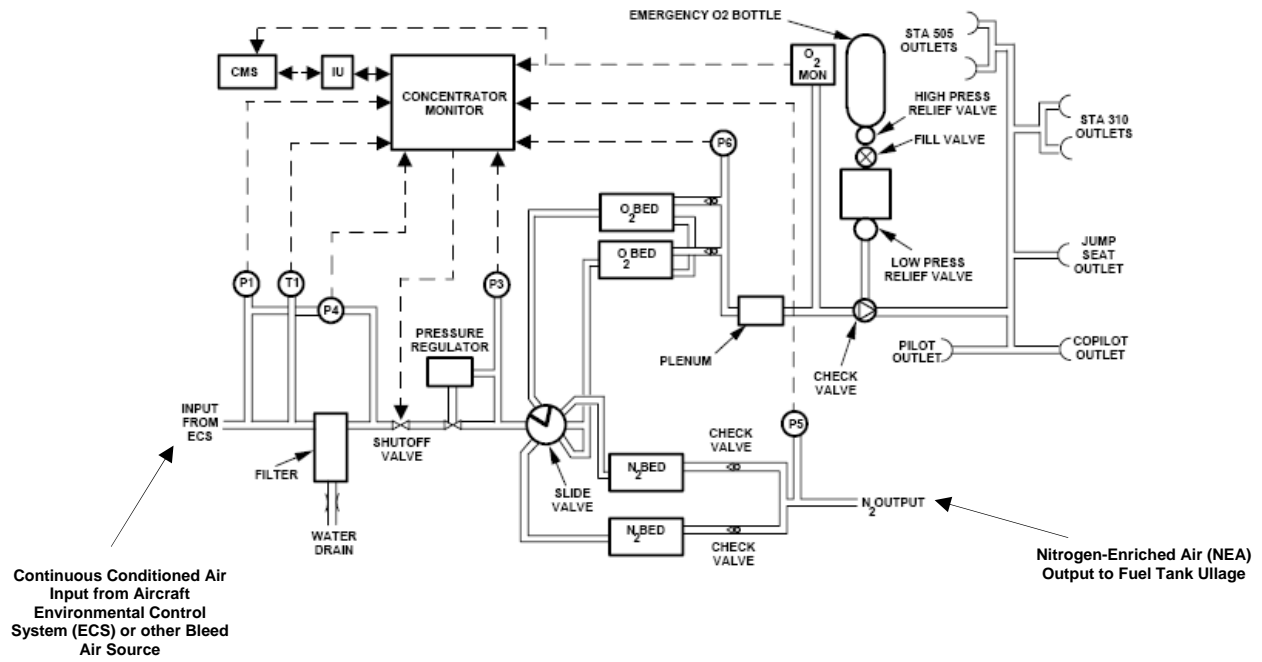

OBIGGS Schematic [33]

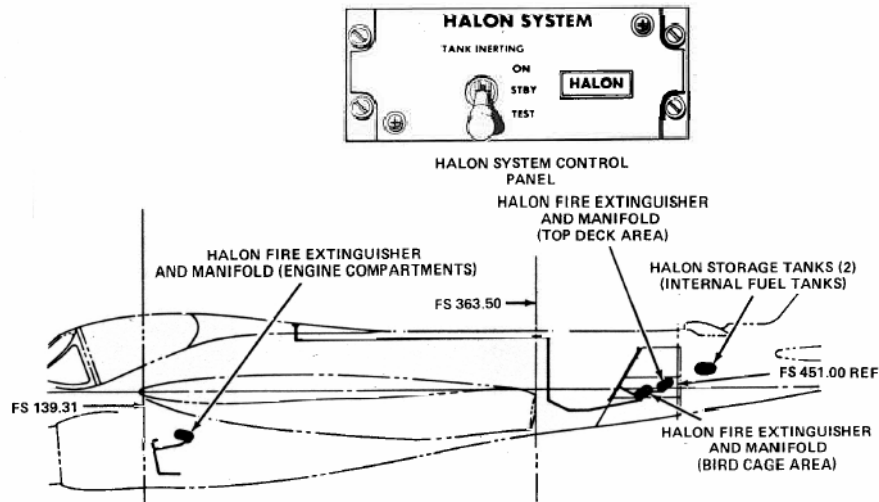

Halon 1301 Inerting System [34]

Figure 34. Examples of Fuel Tank Ullage Fire/Explosion Protection Techniques
 (continued)

SUMMARY

An understanding of history can be beneficial to those involved in the development, implementation and sustainment of aircraft fire suppression systems. History shows, through the modern day, that engine compartments are the most significant safety-related fire threat compartments on aircraft. For nacelle fire suppression systems history also shows that, even with halon 1301, their effectiveness is sensitive to the nacelle installation and possibly to influences by other systems or aircraft effects. The modern history, i.e., 1980 and subsequent, also shows clearly and convincingly that operating environments at which the vast majority of nacelle fire events have occurred have been at altitudes below 6.1 kilometers (20,000 feet) and at OATs above -20°C (-4°F). In the case of rotorcraft, that altitude is shown to be below 4 kilometers (13, 123 feet).

A review of history as well as consideration of LFT vulnerability assessments through the modern day continues to point to fuel systems (and the fuel containment systems) as the greatest contributor to aircraft vulnerable area from a survivability perspective. The history shows that passive protection techniques have predominated within the DoD. Also, the use of higher flash-point fuels has been key to mitigating fuel tank explosions due to safety-related events.

Nacelle/APU Compartments	Dry Bay Compartments	Fuel Tank Ullage
<ul style="list-style-type: none"> • Predominant safety fire threat. • Catastrophic aircraft loss for multi-engine aircraft is a stack-up of probabilities. • Passing Certification \neq 100% Effectivity (<i>inherent risk</i>). • Cold temperature environments have not been the predominant fire risk exposure. • NGP cost/benefit study: fire suppression benefit outweighs cost to implement and sustain [35]. 	<ul style="list-style-type: none"> • Predominant survivability fire threat. • Catastrophic aircraft loss due to fire can be significant contributor to aircraft attrition rate. • Passive techniques have been typically employed on legacy DoD aircraft, though halon 1301 has been used to protect quasi dry bays. • Active gas generator systems fielded on some newer production aircraft. • NGP cost/benefit study: fire suppression benefit outweighs cost to implement and sustain [35]. 	<ul style="list-style-type: none"> • Significant contributor to vulnerable area (obvious). • Safety-related hazards mitigated to large extent by use of JP-5 and JP-8 fuels instead of JP-4. • Passive techniques have been typically employed. • Active techniques (inerting used on few platforms). • Reactive techniques previously employed but not in use today in DoD.

There are several key performance parameters (KPP) that are required to be met during the acquisition phase of the life cycle of a DoD aircraft program. During this phase an enormous amount of attention is paid to weight, performance, cost, reliability/maintainability, safety and survivability - vulnerable area (Av) and probability of kill (Pk). For each except safety, metrics are established. In the case of safety, analyses are developed to support a level of risk after all hazard controls have been implemented, and the residual risk is required to be accepted by the appropriate risk acceptance authority within the procuring the DoD activity. Inevitably, trades are made by the program manager to ensure KPPs are met, and in the current and potentially future era of constrained resources (i.e., dollars), tools that provide the capability to optimize the weight of an aircraft system and its performance and that permit life cycle cost evaluation and optimization of alternatives, or technologies that provide enhanced performance over currently-fielded technologies should benefit program managers and ultimately the end users. Examples of NGP products that can be employed to conduct such trades are:

- Nacelle CFD tool to optimize suppressant weight and distribution system
- Chemically active gas generators and hybrids, which have been shown to require less suppressant mass yet be more effective than recently-fielded inert gas generators
- Enhanced powder panels (EPPs), which have been shown to be comparable in weight with legacy powder panels but are also more effective and provide enhanced dispersion
- NGP cost modeling tool to compare relative life cycle benefits of fire suppression technologies

ACKNOWLEDGEMENTS

The author expresses his sincere appreciation to the following persons and organizations. Without their assistance and contributions, the compilation and publication of information herein would not have been possible.

- Next Generation Fire Suppression Technology Program (NGP), the National Institute of Standards and Technology
- NAVAIR PMA 234, PMA 241, PMA 261, PMA-275, and the NAVAIR Public Affairs Office
- Donna Egner, SURVIAC
- Joe Manchor, NAVAIR Survivability
- Dr. David Keyser, previously NAVAIR and now with SURVICE
- Vendors (Kidde Aerospace, Airscrew Ltd) – for permission to use illustrations

REFERENCES

1. *Statistical Summary of Commercial Jet Airplane Accidents, Worldwide Operations 1959-2004*, Boeing Commercial Airplanes, Aviation Safety, May 2005
2. *Veiligheidsstatistieken luchtvaart 1980-2001*, Civil Aviation Safety Data
3. *Fixed-Wing Aircraft Fire Protection: Halon 1301 Fire Suppression Systems Effectivity Analysis*, NAWCADLKE-MISC-05-SR-0146, Naval Air Warfare Center Aircraft Division, 30 September 1994

4. *Rotary Aircraft Fire Protection: Halon 1301 Fire Suppression Systems Effectivity Analysis*, NAWCADLKE-MISC-05-SR-0132, Naval Air Warfare Center Aircraft Division, 26 May 1994
5. Tedeschi, M. and Leach, W., "Halon 1301 Fire Suppression System Effectivity Aboard U.S. Naval Aircraft," 1995, in Gann, R.G., Burgess, S.R., Whisner, K.C., and Reneke, P.A., eds., *Papers from 1991-2005 Halon Options Technical Working Conferences (HOTWC)*, CD-ROM, NIST Special Publication 984-3, National Institute of Standards and Technology, Gaithersburg, MD (2005)
6. Warner, E.P., "The Prevention of Fire in Air," National Advisory Committee for Aeronautics Technical Memorandum 144, 1922
7. Dallas, A.W. and Hansberry, H.L., "Determination of Means to Safeguard Aircraft from Powerplant Fires in Aircraft, Part I," Civil Aeronautics Administration Technical Development Report No. 33, 1943
8. Hitchcock, E.B. and Scarlon, E.A., "Use of Monochlorobromomethane by the German Navy and Air Force as a Fire Extinguishing Agent," U.S. Naval Technical Mission in Europe, Technical Report No. 276-45, 1945
9. MIL-E-5352A, Extinguishing System, Fire, Aircraft, Installation of, 9 October 1952
10. Middlesworth, C.M., "Determination of a Means to Safeguard Aircraft from Powerplant Fires In Flight, Part VI, The North American Tornado (Air Force XB-45)," U S Department of Commerce, Civil Aeronautics Administration, Technical Development Report No. 221, 1954
11. Hough, R.L., "Factors Involved in Determining the Efficiency of Fire Extinguishing Agents," WADC Technical Note 58-281, Wright Air Development Center Aeronautical Accessories Laboratory, 1959
12. Gann, R., *FY2003 Annual Report, Next Generation Fire Suppression Technology Program (NGP)*, NIST Technical Note 1457, January 2004
13. *Fire Suppression System Performance of Alternate Agents in Aircraft Engine and Dry Bay Laboratory Simulations*, NIST SP 890, Gann, R., Editor, November 1995.
14. Bein, D., "In-Flight Suppressant Deployment Temperatures," 2004, in Gann, R.G., Burgess, S.R., Whisner, K.C., and Reneke, P.A., eds., *Papers from 1991-2005 Halon Options Technical Working Conferences (HOTWC)*, CD-ROM, NIST Special Publication 984-3, National Institute of Standards and Technology, Gaithersburg, MD (2005). Available from the Defense Technical Information Center (DTIC), Accession Number ADA444883.
15. *Department of Defense Handbook MIL-HDBK-310, Global Climatic Data for Developing Military Products*, 23 June 1997
16. Nahlen, C.L., "Outside Temperature of Rotary Wing Aircraft Fires Reported Since January 1985," Memorandum for SFAE-AV-RAH-L, 15 December 1995
17. Program Executive Officer (PEO), Aviation Policy Memorandum 03-02, Risk Management Process, SFAE-AV-PI, 30 April 2003
18. *Aircraft Ground Operations in Canadian Winter: Taxi Times, Wing Temperatures and Hot De-Icing*, Transport Canada Report TP 12735E, April 1996
19. Clodfelter, R. G. and Kuchta, J. M., *Aircraft Mishap Fire Pattern Investigations*, AFWAL-TR-85-2057, August 1985
20. *A Review of the Flammability Hazard of Jet A Fuel Vapor in Civil Transport Aircraft Fuel Tanks*, Federal Aviation Administration Report DOT/FAA/AR-98/26, 1998

21. *Joint Aviation Regulation 1 (JAR-1), Definitions, Change 5*, Joint Aviation Authorities, 15 July 1996
22. Barnett, H.C. and Hibbard, R.R., "Properties of Aircraft Fuels," National Advisory Committee for Aeronautics Technical Note 3276, 1956
23. Linford, R.M. and Dillow, C.F., "Optical Emission Properties of Aircraft Combustible Fluids," Air Force Aero Propulsion Laboratory Report AFAPL-TR-73-83, 1973
24. *Fire Suppression System Performance of Alternative Agents in Aircraft Engine and Dry Bay Laboratory Simulations*, National Institute of Standards and Technology Special Publication NIST SP 890 Volume 2, Gann, R. G., Editor(s), 1995
25. Kolleck, M. L. and Jeffery, K., *Halon Discharges at Altitude*, June 1994
26. Beardsley, G.F. and Korl, K., "Report on Japanese Naval Aircraft CO₂ System Design," Report No. F-IR-76-RE, Air Materiel Command, Wright Patterson Air Force Base, 1946
27. *Fire Suppression Substitutes and Alternatives to Halon for U.S. Navy Applications*, National Academy Press, 1997 (<http://www.nap.edu/books/0309057825/html/>)
28. Robaidek, M.F., "Aircraft Dry Bay Fire Protection," Flight Dynamics Laboratory, Air Force Wright Aeronautical Laboratories, Prepared by Boeing Military Airplane Company, Report AFWAL-TR-87-3032, 1987
29. Bernier, R.G., Enoch, W., Lake, R.E., Mowrer, D.W., and Vikestad, W.S., "Aircraft Fuel System Fire and Explosion Suppression Design Guide," U.S. Army Aviation Research and Technology Activity Aviation Applied Technology Directorate Report USAAVSCOM TR 89-D-16 (JTCG/AS 89-T-005), February 1990
30. *Background to Thermal Control Company's Development of Combat Fire Suppression Systems for Aircraft, Fighting Vehicles, and Ships*, AirScrew Ltd, U.K.
31. *COBRA Primary Fire Suppression System for Fixed and Rotary Wing Aircraft*, AirScrew Ltd, U.K.
32. *Aircraft Accident Report, In-flight Breakup Over the Atlantic Ocean, Trans World Airlines Flight 800, Boeing 747-131, N93119, Near East Moriches, New York, July 17, 1996*, National Transportation Safety Board, NTSB/AAR-00/03 (PB2000-910403;DCA96MA070; Notation 6788G), August 2000
33. Reynolds, T.L., Eklund, T.I., and Haack, G.A., "Onboard Inert Gas Generation System/Onboard Oxygen Gas Generation System (OBIGGS/OBOGS) Study: Part II: Gas Separation Technology - State of the Art," NASA/CR-2001-210950, August 2001
34. Technical Manual, Organizational Maintenance, Description and Principles of Operation, Fuel and In-Flight Refueling Systems, Navy Model A-6E TRAM Aircraft, NAVAIR 01-85ADF-2-30
35. Bennett, J.M. and Kolleck, M.L., "Assessing the Cost Impact of Halon Alternatives on Aviation," 1997, in Gann, R.G., Burgess, S.R., Whisner, K.C., and Reneke, P.A., eds., *Papers from 1991-2005 Halon Options Technical Working Conferences (HOTWC)*, CD-ROM, NIST Special Publication 984-3, National Institute of Standards and Technology, Gaithersburg, MD (2005)